



浙江东方基因生物制品股份有限公司
Zhejiang Orient Gene Biotech Co., LTD



CE-DOC-OG029
Version 4.0

EC Declaration of Conformity

In accordance with Directive 98/79/EC

Legal Manufacturer: *Zhejiang Orient Gene Biotech Co., Ltd*

Legal Manufacturer Address: *3787#, East Yangguang Avenue, Dipu Street,
Anji 313300, Huzhou, Zhejiang, China*

Declares, that the products
Product Name and Model(s)

Malaria P.f./P.v. Ag Rapid Test Cassette (Whole Blood)	GCMAL(pf/pv)-402a
--	-------------------

Classification: *Other*
Conformity assessment route: *Annex III (EC DECLARATION OF CONFORMITY)*

We, the Manufacturer, herewith declare with sole responsibility that our product/s mentioned above meet/s the provisions of the Directive 98/79/EC of the European Parliament and of the Council on In-Vitro Diagnostic Medical Devices.

We hereby explicitly appoint

EC Representative's Name: QARAD BV

EC Representative's Address: Ciplastraat 3, 2440 Geel, BELGIUM

to act as our European Authorized Representative as defined in the aforementioned Directive.

I, the undersigned, hereby declare that the medical devices specified above conform with the directive 98/79/EC on in vitro diagnostic medical devices and pertinent essential requirements

Date Signed: March 4, 2022

Name of authorized signatory: Joyce Pang
Position held in the company: Vice-President



浙江东方基因生物制品股份有限公司
Zhejiang Orient Gene Biotech Co., LTD



CE-DOC-OG030
Version 1.0

EC Declaration of Conformity

In accordance with Directive 98/79/EC

Legal Manufacturer: *Zhejiang Orient Gene Biotech Co., Ltd*

Legal Manufacturer Address: *3787#, East Yangguang Avenue, Dipu Street,
Anji 313300, Huzhou, Zhejiang, China*

Declares, that the products
Product Name and Model(s)

Influenza A & B Ag Rapid Test Cassette (Swab)	GCFLU(A/B)-502Ca
---	------------------

Classification: *Other*

Conformity assessment route: *Annex III (EC DECLARATION OF CONFORMITY)*

We, the Manufacturer, herewith declare with sole responsibility that our product/s mentioned above meet/s the provisions of the Directive 98/79/EC of the European Parliament and of the Council on In-Vitro Diagnostic Medical Devices.

We hereby explicitly appoint

EC Representative's Name: *Shanghai International Holding Corp. GmbH (Europe)*

EC Representative's Address: *Eiffestrasse 80, 20537 Hamburg, Germany*

to act as our European Authorized Representative as defined in the aforementioned Directive.

I, the undersigned, hereby declare that the medical devices specified above conform with the directive 98/79/EC on in vitro diagnostic medical devices and pertinent essential requirements

Date Signed: September 11, 2017

Name of authorized signatory: *Joyce Pang*
Position held in the company: *Vice-President*



浙江东方基因生物制品股份有限公司
Zhejiang Orient Gene Biotech Co., LTD



CE-DOC-OG040
Version 1.0

EC Declaration of Conformity

In accordance with Directive 98/79/EC

Legal Manufacturer: *Zhejiang Orient Gene Biotech Co., Ltd*

Legal Manufacturer Address: *3787#, East Yangguang Avenue, Dipu Street, Anji 313300, Huzhou, Zhejiang, China*

Declares, that the products
Product Name and Model(s)

H. pylori Ab Rapid Test Strip (Whole blood/Serum/Plasma)	GCHP-401a
H. pylori Ab Rapid Test Cassette (Whole blood/Serum/Plasma)	GCHP-402a

Classification: *Other*
Conformity assessment route: *Annex III (EC DECLARATION OF CONFORMITY)*

We, the Manufacturer, herewith declare with sole responsibility that our product/s mentioned above meet/s the provisions of the Directive 98/79/EC of the European Parliament and of the Council on In-Vitro Diagnostic Medical Devices.

We hereby explicitly appoint

EC Representative's Name: *Shanghai International Holding Corp. GmbH (Europe)*

EC Representative's Address: *Eiffestrasse 80, 20537 Hamburg, Germany*

to act as our European Authorized Representative as defined in the aforementioned Directive.

I, the undersigned, hereby declare that the medical devices specified above conform with the directive 98/79/EC on in vitro diagnostic medical devices and pertinent essential requirements

Date Signed: November 28, 2017

Name of authorized signatory: *Joyce Pang*
Position held in the company: *Vice-President*



浙江东方基因生物制品股份有限公司
Zhejiang Orient Gene Biotech Co., LTD



CE-DOC-OG056
Version 1.0

EC Declaration of Conformity

In accordance with Directive 98/79/EC

Legal Manufacturer: *Zhejiang Orient Gene Biotech Co., Ltd*

Legal Manufacturer Address: *3787#, East Yangguang Avenue, Dipu Street,
Anji 313300, Huzhou, Zhejiang, China*

Declares, that the products
Product Name and Model(s)

Rotavirus Rapid Test Cassette (Feces)	GCROA-602a
---------------------------------------	------------

Classification: *Other*

Conformity assessment route: *Annex III (EC DECLARATION OF CONFORMITY)*

We, the Manufacturer, herewith declare with sole responsibility that our product/s mentioned above meet/s the provisions of the Directive 98/79/EC of the European Parliament and of the Council on In-Vitro Diagnostic Medical Devices.

We hereby explicitly appoint

EC Representative's Name: *Shanghai International Holding Corp. GmbH (Europe)*

EC Representative's Address: *Eiffestrasse 80, 20537 Hamburg, Germany*

to act as our European Authorized Representative as defined in the aforementioned Directive.

I, the undersigned, hereby declare that the medical devices specified above conform with the directive 98/79/EC on in vitro diagnostic medical devices and pertinent essential requirements

Date Signed: November 28, 2017

Name of authorized signatory: *Joyce Pang*
Position held in the company: *Vice-President*



浙江东方基因生物制品股份有限公司
Zhejiang Orient Gene Biotech Co., LTD



CE-DOC-OG057
Version 1.0

EC Declaration of Conformity

In accordance with Directive 98/79/EC

Legal Manufacturer: *Zhejiang Orient Gene Biotech Co., Ltd*

Legal Manufacturer Address: *3787#, East Yangguang Avenue, Dipu Street,
Anji 313300, Huzhou, Zhejiang, China*

Declares, that the products
Product Name and Model(s)

Adenovirus Rapid Test Cassette (Feces)	GCADE-602a
--	------------

Classification: *Other*

Conformity assessment route: *Annex III (EC DECLARATION OF CONFORMITY)*

We, the Manufacturer, herewith declare with sole responsibility that our product/s mentioned above meet/s the provisions of the Directive 98/79/EC of the European Parliament and of the Council on In-Vitro Diagnostic Medical Devices.

We hereby explicitly appoint

EC Representative's Name: *Shanghai International Holding Corp. GmbH (Europe)*

EC Representative's Address: *Eiffestrasse 80, 20537 Hamburg, Germany*

to act as our European Authorized Representative as defined in the aforementioned Directive.

I, the undersigned, hereby declare that the medical devices specified above conform with the directive 98/79/EC on in vitro diagnostic medical devices and pertinent essential requirements

Date Signed: November 28, 2017

Name of authorized signatory: *Joyce Pang*
Position held in the company: *Vice-President*



浙江东方基因生物制品股份有限公司
Zhejiang Orient Gene Biotech Co., LTD



CE-DOC-OG258
Version 1.0

EC Declaration of Conformity

In accordance with Directive 98/79/EC

Legal Manufacturer: *Zhejiang Orient Gene Biotech Co., Ltd*

Legal Manufacturer Address: *3787#, East Yangguang Avenue, Dipu Street,
Anji 313300, Huzhou, Zhejiang, China*

Declares, that the products
Product Name and Model(s)

Clostridium difficile Antigen GDH Rapid Test Cassette (Feces)	GCCD(GDH)-602a
---	----------------

Classification: *Other*
Conformity assessment route: *Annex III (EC DECLARATION OF CONFORMITY)*

We, the Manufacturer, herewith declare with sole responsibility that our product/s mentioned above meet/s the provisions of the Directive 98/79/EC of the European Parliament and of the Council on In-Vitro Diagnostic Medical Devices.

We hereby explicitly appoint

EC Representative's Name: CMC Medical Devices & Drugs S.L

EC Representative's Address: C/Horacio Lengo N° 18, CP 29006, Málaga, Spain

to act as our European Authorized Representative as defined in the aforementioned Directive.

I, the undersigned, hereby declare that the medical devices specified above conform with the directive 98/79/EC on in vitro diagnostic medical devices and pertinent essential requirements

Date Signed: May 20, 2022

Name of authorized signatory: Joyce Pang
Position held in the company: Vice-President



浙江东方基因生物制品股份有限公司
Zhejiang Orient Gene Biotech Co., LTD



CE-DOC-OG259
Version 2.0

EC Declaration of Conformity

In accordance with Directive 98/79/EC

Legal Manufacturer: *Zhejiang Orient Gene Biotech Co., Ltd*

Legal Manufacturer Address: *3787#, East Yangguang Avenue, Dipu Street,
Anji 313300, Huzhou, Zhejiang, China*

Declares, that the products
Product Name and Model(s)

Clostridium difficile Toxin A&B Rapid Test Cassette (Feces)	GCCD(Toxin A/B)-602a
---	----------------------

Classification: *Other*
Conformity assessment route: *Annex III (EC DECLARATION OF CONFORMITY)*

We, the Manufacturer, herewith declare with sole responsibility that our product/s mentioned above meet/s the provisions of the Directive 98/79/EC of the European Parliament and of the Council on In-Vitro Diagnostic Medical Devices.

We hereby explicitly appoint

EC Representative's Name: CMC Medical Devices & Drugs S.L

EC Representative's Address: C/Horacio Lengo N° 18, CP 29006, Málaga, Spain

to act as our European Authorized Representative as defined in the aforementioned Directive.

I, the undersigned, hereby declare that the medical devices specified above conform with the directive 98/79/EC on in vitro diagnostic medical devices and pertinent essential requirements

Date Signed: May 25, 2022

Name of authorized signatory: Joyce Pang
Position held in the company: Vice-President



浙江东方基因生物制品股份有限公司
Zhejiang Orient Gene Biotech Co., LTD



CE-DOC-OG266
Version 1.0

EC Declaration of Conformity

In accordance with Directive 98/79/EC

Legal Manufacturer: *Zhejiang Orient Gene Biotech Co., Ltd*

Legal Manufacturer Address: *3787#, East Yangguang Avenue, Dipu Street,
Anji 313300, Huzhou, Zhejiang, China*

Declares, that the products
Product Name and Model(s)

Strep A Rapid Test Strip (Throat Swab)	GCSTR-501a
Strep A Rapid Test Cassette (Throat Swab)	GCSTR-502a

Classification: *Other*
Conformity assessment route: *Annex III (EC DECLARATION OF CONFORMITY)*

We, the Manufacturer, herewith declare with sole responsibility that our product/s mentioned above meet/s the provisions of the Directive 98/79/EC of the European Parliament and of the Council on In-Vitro Diagnostic Medical Devices.

We hereby explicitly appoint

EC Representative's Name: *CMC Medical Devices & Drugs S.L*

EC Representative's Address: *C/Horacio Lengo N° 18, CP 29006, Málaga, Spain*

to act as our European Authorized Representative as defined in the aforementioned Directive.

I, the undersigned, hereby declare that the medical devices specified above conform with the directive 98/79/EC on in vitro diagnostic medical devices and pertinent essential requirements

Date Signed: May 20, 2022

Name of authorized signatory: *Joyce Pang*
Position held in the company: *Vice-President*



Certificate

No. Q5 092305 0001 Rev. 01

Holder of Certificate: **Zhejiang Orient Gene Biotech Co., Ltd.**
3787#, East Yangguang Avenue, Dipu Street Anji
313300 Huzhou, Zhejiang
PEOPLE'S REPUBLIC OF CHINA

Certification Mark:



Scope of Certificate: **Design and Development, Production and Distribution of In Vitro Diagnostic Reagent and Instrument for the Detection of Drugs of Abuse, Fertility, Infectious Diseases, Oncology, Biochemistry, Cardiac Diseases, Allergic Disease based on Rapid Test, PCR and Liquid Biochip Method.**

The Certification Body of TÜV SÜD Product Service GmbH certifies that the company mentioned above has established and is maintaining a quality management system, which meets the requirements of the listed standard(s). All applicable requirements of the testing and certification regulation of TÜV SÜD Group have to be complied with. For details and certificate validity see: [www.tuvsud.com/ps-cert?q=cert:Q5 092305 0001 Rev. 01](http://www.tuvsud.com/ps-cert?q=cert:Q5_092305_0001_Rev.01)

Report No.: SH2198802

Valid from: 2022-04-11

Valid until: 2024-03-16

Date, 2022-04-11



Christoph Dicks

Head of Certification/Notified Body



Product Service

Certificate

No. Q5 092305 0001 Rev. 01

Applied Standard(s): EN ISO 13485:2016
Medical devices - Quality management systems -
Requirements for regulatory purposes
(ISO 13485:2016)
DIN EN ISO 13485:2016

Facility(ies): Zhejiang Orient Gene Biotech Co., Ltd.
3787#, East Yangguang Avenue, Dipu Street Anji, 313300
Huzhou, Zhejiang, PEOPLE'S REPUBLIC OF CHINA

See Scope of Certificate



浙江东方基因生物制品股份有限公司
Zhejiang Orient Gene Biotech Co.,LTD

STATEMENT

We, Zhejiang Orient Gene Biotech Co., Ltd , having a registered office at 3787#, East Yangguang Avenue, Dipu Street Anji 313300, Huzhou, Zhejiang, China assign SRL SANMEDICO having a registered office at A. Corobceanu street 7A, apt. 9, Chişinău MD-2012, Moldova, as non-exclusive authorized representative for Orient Gene Brand product in correspondence with the conditions of directive 98/79/EEC.

We declare that the company mentioned above is authorized to register, notify, renew or modify the registration of medical devices on the territory of the Republic of Moldova.

This Statement letter will be valid from Feb.21th,2023 to Feb.20th, 2024.

Zhejiang Orient Gene Biotech Co., Ltd

General Manager:

Date:2023/2/21



地址：浙江省湖州市安吉县递铺镇阳光大道东段 3787 号
Add: 3787#, East Yangguang Avenue, Dipu Street Anji 313300, Huzhou, Zhejiang, China
电话 Tel:+86-572-5226111 传真 Fax: +86-572-5226222 邮编 P.C.:313300

Strep A Rapid Test Cassette (Throat Swab)



INTENDED USE

The Strep A Rapid Test Cassette (Throat Swab) is a rapid chromatographic immunoassay for the qualitative detection of Strep A antigen from throat swab specimens to aid in the diagnosis of Group A Streptococcal infection.

INTRODUCTION

Streptococcus pyogenes is non-motile gram-positive cocci, which contains the Lancefield group A antigen that can cause serious infections such as pharyngitis, respiratory infection, impetigo, endocarditis, meningitis, puerperal sepsis, and arthritis.¹ Left untreated, these infections can lead to serious complications, including rheumatic fever and peritonsillar abscess.² Traditional identification procedures for Group A Streptococci infection involve the isolation and identification of viable organisms using techniques that require 24 to 48 hours or longer.^{3,4} The Strep A Rapid Test Cassette (Throat Swab) is a rapid test to qualitatively detect the presence of Strep A antigen in throat swab specimens, providing results within 5 minutes. The test utilizes antibodies specific for whole cell Lancefield Group A Streptococcus to selectively detect Strep A antigen in a throat swab specimen.

PRINCIPLE

The Strep A Rapid Test Cassette (Throat Swab) is a qualitative, lateral flow immunoassay for the detection of Strep A carbohydrate antigen in a throat swab. In this test, antibody specific to Strep A carbohydrate antigen is coated on the test line region of the test. During testing, the extracted throat swab specimen reacts with an antibody to Strep A that is coated onto particles. The mixture migrates up the membrane that react with the antibody to Strep A on the membrane and generate a color line in the test line region. The presence of this color line in the test line region indicates a positive result, while its absence indicates a negative result. To serve as a procedural control, a colored line will always appear in the control line region, indicating that proper volume of specimen has been added and membrane wicking has occurred.

MATERIALS SUPPLIED

1. 20 Test cassettes
2. 20 Sterile swabs
3. 20 Extraction tubes and tips
4. 1 Workstation and 1 package insert
5. 1 Reagent B (0.2M acetic acid): 10.0 mL

- | | | |
|---|-------------|--|
| 6. 1 Reagent A (2M sodium nitrite): 10.0 mL |
Warning | Harmful if swallowed.
Wash thoroughly after handling. |
|---|-------------|--|



Harmful if swallowed.
Wash thoroughly after handling.

MATERIAL REQUIRED BUT NOT PROVIDED

1. Clock or timer

WARNINGS AND PRECAUTIONS

1. For professional *in vitro* diagnostic use only. Do not use after the expiration date.
2. Do not eat, drink or smoke in the area where the specimens and kits are handled.
3. Handle all specimens as if they contain infectious agents. Observe established precautions against microbiological hazards throughout the procedure and follow the standard procedures for proper disposal of specimens.
4. Wear protective clothing such as laboratory coats, disposable gloves and eye protection when specimens are assayed.
5. Humidity and temperature can adversely affect results.
6. Do not use test if pouch is damaged.
7. Reagent B contains an acidic solution. If the solution contacts the skin or eye, flush with large volumes of water.
8. Do not interchange reagent bottle caps.
9. Do not interchange external control solution bottle caps.

STORAGE AND STABILITY

Store as packaged in the sealed pouch either at room temperature or refrigerated (2-30°C). The test cassette is stable through the expiration date printed on the sealed pouch. The test cassette must remain in the sealed pouch until use. **DO NOT FREEZE.** Do not use beyond the expiration date.

SPECIMEN COLLECTION AND STORAGE

1. Only use reagents and sterile swabs provided in the kit.
2. Collect the throat swab specimen with the sterile swab that is provided in the kit. Swab the posterior pharynx, tonsils and other inflamed areas. Avoid touching the tongue, cheeks and teeth with the swab.⁵

3. Testing should be performed immediately after the specimens have been collected. Swab specimens may be stored in a clean, dry plastic tube for up to 8 hours at room temperature or 72 hours at 2-8°C. Transport swabs containing modified Stuart's or Amies medium can also be used with this product.
4. If a culture is desired, lightly roll the swab tip onto a Group A selective (GAS) blood agar plate before using the swab in the Strep A Rapid Test Cassette (Throat Swab).

TEST PROCEDURE

Allow the test device, reagents, throat swab specimen, and/or controls to reach room temperature (15-30°C) prior to testing.

1. Remove the test device from the sealed foil pouch and use it as soon as possible. Best results will be obtained if the test is performed immediately after opening the foil pouch.
2. Hold the Reagent A bottle vertically and add 4 full drops of Reagent A to an extraction tube. Reagent A is red in color. Hold the Reagent B bottle vertically and add 4 full drops to the tube. Reagent B is colorless. Mix the solution by gently swirling the extraction tube. The addition of Reagent B to Reagent A changes the color of the solution from red to yellow.
3. Immediately add the throat swab to the extraction tube of yellow solution. Agitate the swab 10 times in the tube. Leave the swab in the tube for 1 minute. Then press the swab against the side of the tube and squeeze the bottom of the tube as the swab is withdrawn. Discard the swab.
4. Fit the dropper tip on top of the extraction tube. Place the test device on a clean and level surface. Add 3 full drops of solution to the specimen well (S) and then start the timer.
5. Wait for the colored line(s) to appear. Read the result at 5 minutes. Do not read the result after 10 minutes.

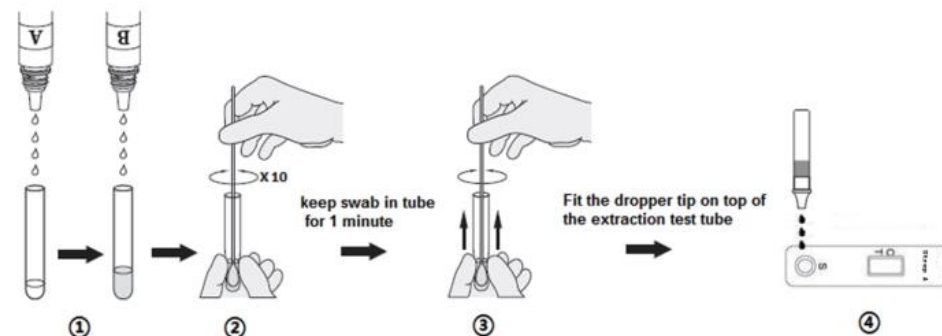

INTERPRETATION OF RESULTS

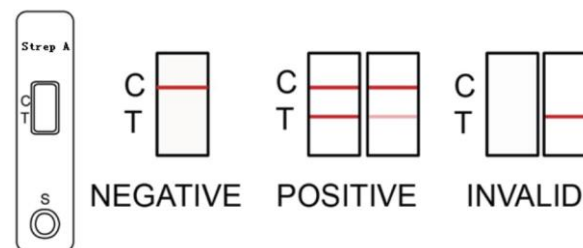

Positive: Two lines appear. One coloured line should be in the control line region (C) and another apparent coloured line should be in the test line region (T).

Negative: One coloured line appears in the control line region (C). No line appears in the test line region (T).

Invalid: Control line fails to appear.

NOTE: Insufficient specimen volume, incorrect operation procedure, or performing expired tests are the most likely reasons for control band failure.

QUALITY CONTROL

Internal Quality Control

Internal procedural controls are included in the test. A color line appearing in the control region (C) is an internal positive procedural control. It confirms sufficient specimen volume, adequate membrane wicking and correct procedural technique.

LIMITATIONS

1. The Strep A Rapid Test Cassette (Throat Swab) is for *in vitro* diagnostic use only. The test should be used for the detection of Strep A antigen in throat swab specimens only. Neither the quantitative value nor the rate of increase in Strep A antigen concentration can be determined by this qualitative test.
2. This test will only indicate the presence of Strep A antigen in the specimen from both viable and non-viable Group A streptococcus bacteria.
3. A negative result must be confirmed by culture. A negative result may be obtained if the concentration of the Strep A antigen present in the throat swab is not adequate or is below the detectable level of the test.
4. The sterile swabs provided with this test must be used for specimen collection. Other swabs have not been validated with this test.
5. Excess blood or mucus on the swab specimen may interfere with test performance and may yield a false positive result. Avoid touching the tongue, cheeks, and teeth⁵ and any bleeding areas of the mouth with the swab when collecting specimens. As with all diagnostic tests, all results must be interpreted together with other clinical information available to the physician.

PERFORMANCE CHARACTERISTICS

Clinical Sensitivity and Specificity

The Strep A Rapid Test Cassette (Throat Swab) was used to evaluate 368 throat swab specimens collected from three physician offices patients presenting with pharyngitis. The test result compared to the culture method. The below table summarizes the data.

Clinical Performance: Strep A Rapid Test vs. Culture

Strep A Rapid Test Cassette (Throat Swab) Results	Reference Culture Results		Total
	Positive	Negative	
Positive	200	1	201
Negative	6	161	167
Total	206	162	368

Sensitivity: 97.1% (200/206); 95%CI = 93.7% - 98.8%

Specificity: 99.4% (161/162); 95%CI = 96.2% - 100.0%

Clinical Performance Stratified by Age

Age	Sensitivity	Sensitivity(95%CI)	Specificity	Specificity(95%CI)
0 ~ 5	97.4% (74/76)	90.4% - 99.8%	98.1% (52/53)	89.1% - 100.0%
5+ ~ 21	96.7% (119/123)	91.7% - 99.0%	100% (88/88)	95.0% - 100.0%
21+	100% (7/7)	59.6% - 100.0%	100% (21/21)	81.8% - 100.0%
All	97.1% (200/206)	93.7% - 98.8%	99.4% (161/162)	96.2% - 100.0%

Cross-Reactivity

The following organisms were tested at 1.0×10^7 organisms per test and were all found to be negative when tested with the Strep A Rapid Test Cassette (Throat Swab). No mucoid-producing strains were tested.

Group B Streptococcus	Neisseria meningitidis	Serratia marcescens
Group F Streptococcus	Neisseria sicca	Klebsiella pneumoniae
Streptococcus pneumoniae	Branhamella catarrhalis	Bordetella pertussis
Streptococcus mutans	Group C Streptococcus	Neisseria gonorrhoea
Staphylococcus aureus	Group G Streptococcus	Neisseria subflava
Corynebacterium diphtheria	Streptococcus sanguis	Hemophilus influenza
Candida albicans	Enterococcus faecalis	
Pseudomonas aeruginosa	Staphylococcus epidermidis	

Physician's Office Laboratory (POL) Studies

Three physicians' offices were used to conduct an evaluation of the Strep A Rapid Test Cassette (Throat Swab). Personnel with various educational backgrounds performed the testing. Each physician's office tested a randomly coded panel of samples consisting of negative (20), low positive (20), and medium positive (20) for three days. The results obtained had a 96% correlation with the expected results.









REFERENCE

1. Murray, P.R., et al. Manual of Clinical Microbiology, 6th Edition, ASM Press, Washington D.C. p. 299-307.
2. Webb, KH. Does Culture Confirmation of High-sensitivity Rapid Streptococcal Tests Make Sense? A Medical Decision Analysis. Pediatrics (Feb 1998), 101: 2, 2.
3. Bisno AL, Gerber MA, Gwaltney JM, Kaplan EL, Schwartz RH. Diagnosis and Management of Group A Streptococcal Pharyngitis. Clinical Infectious Diseases (1997), 25: 574-83.
4. Needham CA, McPherson KA, Webb KH. Streptococcal Pharyngitis: Impact of a High-sensitivity Antigen Test

on Physician Outcome. Journal of Clinical Microbiology (Dec 1998), 36: 3468-3473.

5. Shea, Y.R., Specimen Collection and Transport, Clinical Microbiology Procedures Handbook, Isenberg, H.D., American Society of Microbiology, Washington D.C., 1.1.1-1.1.30, 1992.
6. Nussinovitch, M, Finkelstein Y, Amir J, Varsano, I. Group A beta-hemolytic streptococcal pharyngitis in preschool children aged 3 months to to 5 years. Clinical Pediatrics (June 1999), 38: 357-360.
7. Woods WA, Carter CT, Stack M, Connors Jr AF, Schlager TA. Group A Streptococcal Pharyngitis in Adults 30 to 65 years of age. Southern Medical Journal (May 1999), 491-492.

INDEX OF SYMBOLS

	Consult instructions for use		Tests per kit		Authorized Representative
	For <i>in vitro</i> diagnostic use only		Use by		Do not reuse
	Store between 2~30°C		Lot Number		Catalog#

 Zhejiang Orient Gene Biotech Co.,Ltd
Address: 3787#, East Yangguang Avenue, Dipu Street,
Anji 313300, Huzhou, Zhejiang, China
Tel: +86-572-5226111 Fax: +86-572-5226222
Website: www.orientgene.com

 CMC Medical Devices & Drugs S.L
C/Horacio Lengo Nº 18 CP 29006, Málaga-Spain
Tel: +34951214054 Fax: +34952330100
Email-info@cmcmmedicaldevices.com

 GCSTR-502a

Swab information

 Jiangsu ChangFeng Medical Industry Co., LTD
Address: Touqiao Town, Guangling DISTRICT,
Yangzhou, Jiangsu 225109 China

 Llins Service & Consulting GmbH
Obere Seegasse 34/2, 69124 Heidelberg, Germany
Email-info@llins-service.com



Revision Date: 2022-04-12
B20402-04

H. pylori Ag Rapid Test Cassette (Feces)



INTENDED USE

H. pylori Ag Rapid Test Cassette (Feces) is a sandwich lateral flow chromatographic immunoassay for the qualitative detection of H. Pylori antigen in feces. It is for professional *in vitro* diagnostic use only.

INTRODUCTION

H. Pylori is associated with a variety of gastrointestinal diseases included non-ulcer dyspepsia, duodenal and gastric ulcer and active, chronic gastritis.^{1,2} The prevalence of H. pylori infection could exceed 90% in patients with signs and symptoms of gastrointestinal diseases. Recent studies indicate an association of H. Pylori infection with stomach cancer.³ H. Pylori colonizing in the gastrointestinal system elicits specific antibody responses^{4,5,6} which aids in the diagnosis of H. Pylori infection and in monitoring the prognosis of the treatment of H. Pylori related diseases. Antibiotics in combination with bismuth compounds have been shown to be effective in treating active H. Pylori infection. Successful eradication of H. pylori is associated with clinical improvement in patients with gastrointestinal diseases providing a further evidence.⁷

PRINCIPLE

H. pylori Ag Rapid Test Cassette (Feces) is a lateral flow chromatographic immunoassay based on the principle of the double antibody–sandwich technique. The test cassette consists of: 1) a burgundy colored conjugate pad containing H. Pylori antibodies conjugated with color particles (H. Pylori conjugates). 2) a nitrocellulose membrane strip containing a test band (T band) and a control band (C band). The T band is pre-coated with non-conjugated H. Pylori antibodies.

When an adequate volume of test specimen is dispensed into the sample well of the cassette, the specimen migrates by capillary action across the cassette. The antigen of H. Pylori if present in the specimen will bind to the H. Pylori antibodies conjugates. The immunocomplex is then captured on the membrane by the pre-coated H. Pylori antibodies, forming a burgundy colored T band, indicating a H. Pylori antigen positive test result. To serve as a procedural control, a colored line will always appear in the control line region indicating that proper volume of specimen has been added and membrane wicking has occurred. Otherwise, the test result is invalid and the specimen must be retested with another device.

PRODUCT CONTENTS

H. pylori Ag Rapid Test Cassette (Feces) containing anti- H. pylori antibodies particles and anti-H. pylori antibodies coated on the membrane.

MATERIALS SUPPLIED

- 20 Sealed pouches each containing a test cassette and a desiccant
- 20 Specimen collection tubes with extraction buffer, 2.0 mL
- 1 Package insert

MATERIAL REQUIRED BUT NOT PROVIDED

1. Clock or timer
2. Specimen collection containers.

STORAGE AND STABILITY

All reagents are ready to use as supplied. Store unused test device unopened at 2°C-30°C. If stored at 2°C-8°C, ensure that the test device is brought to room temperature before opening. The test is not stable out off the expiration date printed on the sealed pouch. Do not freeze the kit or expose the kit over 30°C.

WARNINGS AND PRECAUTIONS

1. For professional *in vitro* diagnostic use only.
2. Do not use it if the tube/pouch is damaged or broken.
3. Test is for single use only. Do not re- use under any circumstances.
4. Handle all specimens as if they contain infectious agents. Observe established standard procedure for proper disposal of specimens
5. Wear protective clothing such as laboratory coats, disposable gloves and eye protection when specimens are assay.
6. Humidity and temperature can adversely affect results

SPECIMEN COLLECTION

Collect sufficient quantity of feces (1-2 mL or 1-2 g) in a clean, dry specimen collection container to obtain maximum antigens (if present). Best results will be obtained if the assay is performed within 6 hours after collection. Specimen collected may be stored for 3 days at 2-8°C if not tested within 6 hours. For long term storage, specimens should be kept below -20°C.

To process fecal specimens:

• For Solid Specimens:

Unscrew the cap of the specimen collection tube, then randomly stab the specimen collection applicator into the fecal specimen in at least 3 different sites to collect approximately 50 mg of feces (equivalent to 1/4 of a pea). Do not scoop the fecal specimen.

• For Liquid Specimens:

Hold the dropper vertically, aspirate fecal specimens, and then transfer 2 drops (approximately 80 µL) into the specimen collection tube containing the dilution buffer. Screw on and tighten the cap onto the specimen collection tube, then shake the specimen collection tube vigorously to mix the specimen and the dilution buffer. Leave the tube alone for 2 minutes.

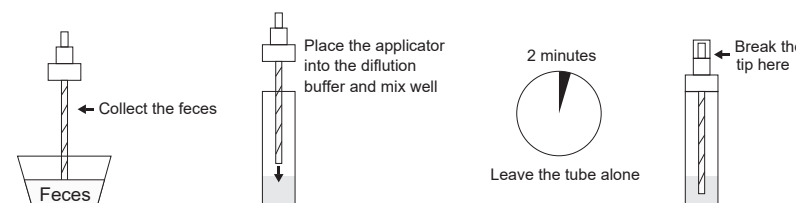

TEST PROCEDURE

1. Remove the test device from its foil pouch by tearing along the notch and use it as soon as possible.
2. Specimen collection. See also specimen collection.
3. Holding the sample collection device upright, carefully break off the tip of collection device.
4. Squeeze 2 drops (~80 µL) of the sample solution in the sample well of the cassette, as in the illustration.
5. Read the test results in 10 minutes. It is important that the background is clear before the result is read. Do not read results after 10 minutes. To avoid confusion, discard the test device after interpreting the result.

INTERPRETATION OF RESULTS

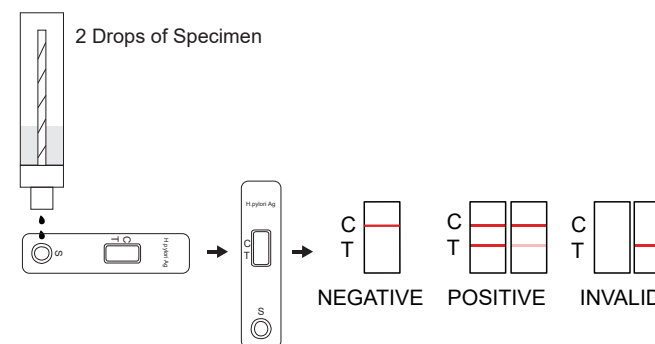

H. pylori Ag Rapid Test Cassette (Feces)

Positive: Two lines appear. One colored line should be in the control line region (C) and another apparent colored line should be in the test line region (T).

Negative: One colored line appears in the control line region(C). No line appears in the test line region (T).

Invalid: Control line fails to appear.

QUALITY CONTROL

A procedural control is included in the test. A colored line appearing in the control line region (C) is an internal procedural control. It confirms sufficient specimen volume, adequate membrane wicking and correct procedural technique.

Control standards are not supplied with this kit; however, it is recommended that positive and negative controls be tested as a good laboratory practice to confirm the test procedure and to verify proper test performance.

LIMITATIONS

1. The Assay Procedure and the Assay Result Interpretation must be followed closely when testing the presence of H. Pylori antigen in feces from individual subjects. Failure to follow the procedure may give inaccurate results.
2. H. pylori Ag Rapid Test Cassette (Feces) is limited to the qualitative detection of H. Pylori antigen in feces. The intensity of the test band does not have linear correlation with the antigen titer in the specimen.
3. A negative result for an individual subject indicates absence of detectable H. Pylori antigen. However, a negative test result does not preclude the possibility of exposure to or infection with H. Pylori.
4. A negative result can occur if the quantity of the H. Pylori antigen present in the specimen is below the detection limits of the assay, or the antigen that are detected are not present during the stage of disease in which a sample is collected.
5. The results obtained with this test should only be interpreted in conjunction with other diagnostic procedures and clinical findings.

PERFORMANCE CHARACTERISTICS

A study was performed with 165 patient feces samples including both symptomatic gastrointestinal disorders and samples from non-symptomatic patients and 100 normal feces samples. Comparison for all subjects with H. pylori Ag Rapid Test Cassette (Feces) and reference ELISA kit is showed in the following table:

Method		EIA		Total Results
H.P Test Cassette	Results	Positive	Negative	
	Positive	163	0	163
	Negative	2	100	102
Total Results		165	100	265

Relative sensitivity: 98.8%

Relative specificity: 100%

Accuracy:98.9%

REFERENCE









1. Marshall,B.J.et.al. Pyloric Campylobacter infection and gastroduodenal disease. Med. J. Australia.149:439-44, 1985.
2. Marshall,B.J.et.al. Prospective double-blind trial of duodenal ulcer relapse after eradication of Campylobacter pylori. Lancet. Dec.1437-42,1988.
3. Megraud,F.et.al. Seroepidemiology of Campylobacter pylori infection in virious populations J.Clin.Microbiology. 27:1870-3,1989.
4. Soll,A.H. Pathogenesis of peptic ulcer and implications for therapy. New England J. Med.322:909-916,1990.

5. Parsonnet,J.et.al. Helicobacter pylori infection and the risk of gastric carcinoma. New England J.Med. 325:1127-31,1991.

6. Ansong,R. et.al. Evaluation of techniques for isolation, subcultivation and preservation of Helicobacter pylori. J.Clin.Micro. 29:51-53,1991.

7. Pronovost,A.P.et.al. Evaluation of a new immunodiagnostic assay for Helicobacter pylori antibody detection: Correlation with histopathological and microbiological results. J.Clin.Microbiol.32:46-50,1994.

INDEX OF SYMBOLS

	Consult instructions for use		Tests per kit		Authorized Representative
	For <i>in vitro</i> diagnostic use only		Use by		Do not reuse
	Store between 2~30°C		Lot Number		Catalog#



Zhejiang Orient Gene Biotech Co.,Ltd
Address: 3787#, East Yangguang Avenue, Dipu Street,
Anji 313300, Huzhou, Zhejiang, China.
TEL: +86-572-5226111 FAX: +86-572-5226222
Website: www.orientgene.com

 Shanghai International Holding Corp. GmbH (Europe)
Add: Eiffestrasse 80, 20537 Hamburg, Germany

 GCHP-602a

Revision Date: 2022-03-08
B20435-03

Rotavirus Rapid Test Cassette (Feces)



INTENDED USE

The Rotavirus Rapid Test Cassette (Feces) is a rapid visual immunoassay for the qualitative presumptive detection of rotavirus in human fecal specimens. This kit is intended to be used as an aid in the diagnosis of rotavirus infection.

INTRODUCTION

Rotavirus is the most common agent responsible for acute gastroenteritis, mainly in young children. Its discovery in 1973 and its association with infantile gastro-enteritis represented a very important advancement in the study of gastro-enteritis not caused by acute bacterial infection. The rotavirus may still be found while diarrhoea continues.

Rotaviral gastroenteritis may result in mortality for populations at risk such as infants, the elderly, and immunocompromised patients. In temperate climates, rotavirus infections occur mainly in the winter months.

Endemics as well as epidemics affecting some thousand people have been reported. With hospitalised children suffering from acute enteric disease up to 50% of the analysed specimen were positive for rotavirus. The viruses replicate in the cell nucleus and tend to be host species specific producing a characteristic cytopathic effect (CPE). Because rotavirus is extremely difficult to culture, it is unusual to use isolation of the virus in diagnosing an infection. Instead, a variety of techniques have been developed to detect rotavirus in feces.

PRINCIPLE

The Rotavirus Rapid Test Cassette (Feces) has been designed to detect rotavirus through visual interpretation of color development in the internal strip. The membrane was immobilized with anti-rotavirus antibodies on the test region. During the test, the specimen is allowed to react with colored anti-rotavirus antibodies color particles conjugates, which were precoated on the sample pad of the test. The mixture then moves on the membrane by a capillary action, and interact with reagents on the membrane. If there were enough rotavirus in specimens, a colored band will form at the T region of the membrane. Presence of colored band indicates a positive result, while its absence indicates a negative result. Appearance of a colored band at the control region serves as a procedural control. This indicates that proper volume of specimen has been added and membrane wicking has occurred.

MATERIALS PROVIDED

- 20 Sealed pouches each containing a test cassette, a dropper and a desiccant
- 20 Specimen collection tubes with extraction buffer, 2.0 mL
- 1 Package insert

MATERIALS REQUIRED BUT NOT PROVIDED

- 1. Clock or timer
- 2. Specimen collection containers

PRECAUTIONS

- For professional *in vitro* diagnostic use only.
- Do not use after expiration date indicated on the package. Do not use the test if its foil pouch is damaged. Do not reuse tests.
- This kit contains products of animal origin. Certified knowledge of the origin and/or sanitary state of the animals does not totally guarantee the absence of transmissible pathogenic agents. It is therefore, recommended that these products be treated as potentially infectious, and handled observing the usual safety precautions (do not ingest or inhale).
- Avoid cross-contamination of specimens by using a new specimen collection container for each specimen obtained.
- Read the entire procedure carefully prior to performing any tests.
- Do not eat, drink or smoke in the area where the specimens and kits are handled. Handle all specimens as if they contain infectious agents. Observe established precautions against microbiological hazards throughout the procedure and follow the standard procedures for proper disposal of specimens. Wear protective clothing such as laboratory coats, disposable gloves and eye protection when specimens are assayed.
- Do not interchange or mix reagents from different lots.
- Humidity and temperature can adversely affect results.
- The used testing materials should be discarded in accordance with local, state and/or federal regulations.

STORAGE AND STABILITY

- The kit should be stored at 2-30°C until the expiry date printed on the sealed pouch. **Do not**

freeze.

- The test must remain in the sealed pouch until use.
- Cares should be taken to protect components in this kit from contamination. Do not use if there is evidence of microbial bcontamination or precipitation. Biological contamination of dispensing equipments, containers or reagents can lead to false results.

SPECIMEN COLLECTION AND STORAGE

- The Rotavirus Rapid Test Cassette(Feces) is intended only for use with human fecal specimens.
- Viral detection is improved by collecting the specimens at the onset of the symptoms. It has been reported that the maximum excretion of rotavirus in the feces of patients with gastroenteritis occurs 3-5 days after onset of symptoms. If the specimens are collected long after the onset of diarrheic symptoms, the quantity of antigen may not be sufficient to obtain a positive reaction or the antigens detected may not be linked to the diarrheic episode.
- Perform the testing immediately after the specimen collection. Do not leave the specimens at room temperature for prolonged periods. Specimens may be stored at 2-8°C for up to 72 hours. Bring specimens to room temperature prior to testing.
- Pack the specimens in compliance with applicable regulations for transportation of etiological agents, in case they need to be shipped.

PROCEDURE

Bring tests, specimens, buffer and/or controls to room temperature (15-30°C) before use.

1. Specimen collection and pre-treatment.

- Best results will be obtained if the assay is performed within 6 hours after collection.
- Unscrew and remove the dilution tube applicator. Be careful not to spill or spatter solution from the tube. Collect specimens by inserting the applicator stick into at least 3 different sites of the feces to collect approximately 50 mg of feces (equivalent to 1/4 of a pea).
- Place the applicator back into the tube and screw the cap tightly.
- Shake the specimen collection tube vigorously to mix the specimen and the extraction buffer. Specimens prepared in the specimen collection tube may be stored for 6 months at -20°C if not tested within 1 hour after preparation.

2. Testing

- Remove the test from its sealed pouch, and place it on a clean, level surface. Label the test with patient or control identification. To obtain a best result, the assay should be performed within one hour.
- Hold the specimen collection tube upright and then unscrew and open the upper cap. **Hold the tube vertically and dispense 2 drops of solution into the specimen well (S)** of the test cassette. Avoid trapping air bubbles in the specimen well (S), and do not drop any solution in observation window.
- Wait for the colored band to appear. The result should be read at 10 minutes. Do not interpret the result after 15 minutes.

Note: If the specimen does not migrate (presence of particles), centrifuge the extracted specimens contained in the extraction buffer vial. Collect 80µL of supernatant, dispense into the specimen well (S) of a new test device and start afresh following the instructions mentioned above.

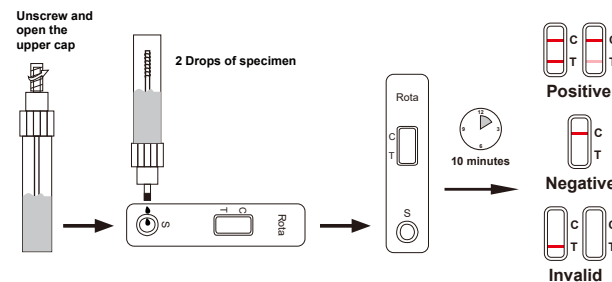

INTERPRETATION OF RESULTS

POSITIVE: A colored band appears in the control band region (C) and another colored band appears in the R band region (T).

NEGATIVE: One colored band appears in the control band region (C). No band appears in the test band region (T).

INVALID: Control band fails to appear. Results from any test which has not produced a control band at the specified reading time must be discarded. Please review the procedure and repeat with a new test. If the problem persists, discontinue using the kit immediately and contact your local distributor.

QUALITY CONTROL

Internal procedural controls are included in the test. A colored band appearing in the control region (C) is considered an internal positive procedural control. It confirms sufficient specimen volume and correct procedural technique.

External controls are not supplied with this kit. It is recommended that positive and negative controls be tested as a good laboratory practice to confirm the test procedure and to verify proper test performance.

LIMITATIONS OF THE TEST

- The Rotavirus Rapid Test Cassette (Feces) is for professional in vitro diagnostic use, and should be used for the qualitative detection of rotavirus only.
- As with all diagnostic tests, a definitive clinical diagnosis should not be based on the results of a single test, but should only be made by the physician after all clinical and laboratory findings have been evaluated.
- If the test result is negative and clinical symptoms persist, additional testing using other clinical methods is recommended. A negative result does not at any time preclude the possibility of rotavirus infection with low concentration of virus particles.

PERFORMANCE CHARACTERISTICS

Table: Rotavirus Rapid Test vs. Latex Agglutination

		Rotavirus Rapid Test		Total
		Positive	Negative	
Latex Agglutination	Positive	224	2	226
	Negative	0	156	156
Total		224	158	382

Relative Sensitivity: 99.1% (96.8%-99.9%)*

Relative Specificity: >99.9% (97.7%-100.0%)*

Overall Agreement: 99.5% (98.1%-99.9%)* *95% Confidence Interval

Cross reactivity:

Cross reactivity with following organisms has been studied at 1.0 x 10⁹ organisms/mL. The following organisms were found negative when tested with the Rotavirus Rapid Test Cassette (Feces).

<i>Staphylococcus aureus</i>	<i>Proteus mirabilis</i>	<i>Neisseria gonorrhoea</i>
<i>Pseudomonas aeruginosa</i>	<i>Acinetobacter spp</i>	Group B <i>Streptococcus</i>
<i>Enterococcus faecalis</i>	<i>Salmonella choleraesuis</i>	<i>Proteus vulgaris</i>
Group C <i>Streptococcus</i>	<i>Gardnerella vaginalis</i>	<i>Enterococcus faecium</i>
<i>Klebsiella pneumoniae</i>	<i>Acinetobacter calcoaceticus</i>	<i>Hemophilus influenzae</i>
<i>Branhamella catarrhalis</i>	<i>E.coli</i>	<i>Neisseria meningitidis</i>
<i>Candida albicans</i>	<i>Chlamydia trachomatis</i>	

LITERATURE REFERENCES

- Wadell, G. Laboratory Diagnosis of Infectious Diseases: Principles and Practices. New York: Springer-Verlag, Volume II, 1988: 284-300.
- WILHELM I, ROMAN E, SANCHEZ-FAUQUIER A. Viruses causing gastroenteritis. Clin Microbiol Infect. April. 2003, vol.9:247-262

INDEX OF SYMBOLS

	Consult instructions for use		Tests per kit		Authorized Representative
	For <i>in vitro</i> diagnostic use only		Use by		Do not reuse
	Store between 2~30°C		Lot Number		Catalog#

Zhejiang Orient Gene Biotech Co.,Ltd
Address: 3787#, East Yangguang Avenue, Dipu Street,
Anji 313300, Huzhou, Zhejiang, China
Tel: +86-572-5226111 Fax: +86-572-5226222
Website: www.orientgene.com

Shanghai International Holding Corp. GmbH (Europe)
Add: Eiffestrasse 80, 20537 Hamburg, Germany

GCROA-602a

Adenovirus Rapid Test Cassette (Feces)



INTENDED USE

The Adenovirus Rapid Test Cassette (Feces) is a rapid visual immunoassay for the qualitative presumptive detection of adenovirus in human fecal specimens. This kit is intended to be used as an aid in the diagnosis of adenovirus infection.

INTRODUCTION

Acute diarrheal disease in young children is a major cause of morbidity worldwide and is a leading cause of mortality in developing countries. Research has shown that enteric adenoviruses, primarily Ad40 and Ad41, are a leading cause of diarrhea in many of these children, second only to the rotaviruses. These viral pathogens have been isolated throughout the world, and can cause diarrhea in children year round. Infections are most frequently seen in children less than two years of age, but have been found in patients of all ages. Further studies indicate that adenoviruses are associated with 4-15% of all hospitalized cases of viral gastroenteritis.

Rapid and accurate diagnosis of gastroenteritis due to adenovirus is helpful in establishing the etiology of gastroenteritis and related patient management. Other diagnostic techniques such as electron microscopy (EM) and nucleic acid hybridization are expensive and labor-intensive. With the self-limiting nature of adenovirus infection, such expensive and labor-intensive tests may not be necessary.

PRINCIPLE

The Adenovirus Rapid Test Cassette (Feces) has been designed to detect adenovirus through visual interpretation of color development in the internal strip. The membrane was immobilized with anti-adenovirus on the test region. During the test, the specimen is allowed to react with colored anti-adenovirus antibodies latex particle conjugates, which were precoated on the sample pad of the test. The mixture then moves on the membrane by a capillary action, and interact with reagents on the membrane. If there were enough adenovirus in specimens, a colored band will form at the T region of the membrane. Presence of colored band indicates a positive result, while its absence indicates a negative result. Appearance of a colored band at the control region serves as a procedural control. This indicates that proper volume of specimen has been added and membrane wicking has occurred.

MATERIALS PROVIDED

20 Sealed pouches each containing a test cassette, a dropper and a desiccant
20 Specimen Collection tubes with extraction buffer, 2.0 mL
1 Package insert

MATERIALS REQUIRED BUT NOT PROVIDED

1. Timer
2. Centrifuge

PRECAUTIONS

- For professional *in vitro* diagnostic use only.
- Do not use after expiration date indicated on the package. Do not use the test if its foil pouch is damaged. Do not reuse tests.
- This kit contains products of animal origin. Certified knowledge of the origin and/or sanitary state of the animals does not totally guarantee the absence of transmissible pathogenic agents. It is therefore, recommended that these products be treated as potentially infectious, and handled observing the usual safety precautions (do not ingest or inhale).
- Avoid cross-contamination of specimens by using a new specimen collection container for each specimen obtained.
- Read the entire procedure carefully prior to performing any tests.
- Do not eat, drink or smoke in the area where the specimens and kits are handled. Handle all specimens as if they contain infectious agents. Observe established precautions against microbiological hazards throughout the procedure and follow the standard procedures for proper disposal of specimens. Wear protective clothing such as laboratory coats, disposable gloves and eye protection when specimens are assayed.
- Do not interchange or mix reagents from different lots.
- Humidity and temperature can adversely affect results.
- The used testing materials should be discarded in accordance with local, state and/or federal regulations.

STORAGE AND STABILITY

- The kit should be stored at 2-30°C until the expiry date printed on the sealed pouch.
- The test must remain in the sealed pouch until use.
- **Do not freeze.**
- Cares should be taken to protect components in this kit from contamination. Do not use if there is evidence of microbial contamination or precipitation. Biological contamination of dispensing equipments, containers or reagents can lead to false results.

SPECIMEN COLLECTION AND STORAGE

- The Adenovirus Rapid Test Cassette (Feces) is intended only for use with human fecal specimens.
- Viral detection is improved by collecting the specimens at the onset of the symptoms.
- Perform the testing immediately after the specimen collection. Do not leave the specimens at room temperature for prolonged periods. Specimens may be stored at 2-8°C for up to 72 hours.
- Bring specimens to room temperature prior to testing.
- Pack the specimens in compliance with applicable regulations for transportation of etiological agents, in case they need to be shipped.

PROCEDURE

Bring tests, specimens, buffer and/or controls to room temperature (15-30°C) before use.

1. Specimen collection and pre-treatment:
 - 1) Best results will be obtained if the assay is performed within 6 hours after collection.
 - 2) Unscrew and remove the dilution tube applicator. Be careful not to spill or spatter solution from the tube. Collect specimens by inserting the applicator stick into at least 3 different sites of the feces to collect approximately 50 mg of feces (equivalent to 1/4 of a pea).
 - 3) Place the applicator back into the tube and screw the cap tightly. Be careful not to break the tip of the dilution tube.
 - 4) Shake the specimen collection tube vigorously to mix the specimen and the extraction buffer. Specimens prepared in the specimen collection tube may be stored for 6 months at -20°C if not tested within 1 hour after preparation.
2. Testing
 - 1) Remove the test from its sealed pouch, and place it on a clean, level surface. Label the test with patient or control identification. To obtain a best result, the assay should be performed within one hour.
 - 2) Using a piece of tissue paper, break the tip of the dilution tube. Hold the tube vertically and dispense 2 drops of solution into the specimen well (S) of the test device.
Avoid trapping air bubbles in the specimen well (S), and do not drop any solution in observation window. As the test begins to work, you will see color move across the membrane.
 3. Wait for the colored band(s) to appear. The result should be read at 10 minutes. Do not interpret the result after 15 minutes.

Note: If the specimen does not migrate (presence of particles), centrifuge the extracted specimens contained in the extraction buffer vial. Collect 80 µL of supernatant, dispense into the specimen well (S) of a new test device and start afresh following the instructions mentioned above.

INTERPRETATION OF RESULTS

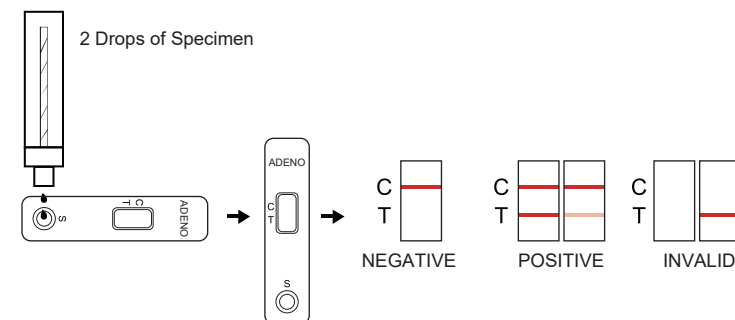

NEGATIVE: One colored band appears in the control band region (C). No band appears in the test band region (T).
POSITIVE: A colored band appears in the control band region (C) and another colored band appears in the A line region (T).
INVALID: Control band fails to appear. Results from any test which has not produced a control band at the specified reading time must be discarded. Please review the procedure and repeat with a new test. If the problem persists, discontinue using the kit immediately and contact your local distributor.

NOTE:
 Insufficient specimen volume, incorrect operation procedure, or performing expired tests are the most likely reasons for control band failure.

QUALITY CONTROL

- Internal procedural controls are included in the test. A colored band appearing in the control region (C) is considered an internal positive procedural control. It confirms sufficient specimen volume and correct procedural technique.
- External controls are not supplied with this kit. It is recommended that positive and negative controls be tested as a good laboratory practice to confirm the test procedure and to verify proper test performance.

LIMITATIONS OF THE TEST

- The Adenovirus Rapid Test Cassette (Feces) is for professional *in vitro* diagnostic use, and should be used for the qualitative detection of Adenovirus only.
- As with all diagnostic tests, a definitive clinical diagnosis should not be based on the results of a single test, but should only be made by the physician after all clinical and laboratory findings have been evaluated.
- If the test result is negative and clinical symptoms persist, additional testing using other clinical methods is recommended. A negative result does not at any time preclude the possibility of adenovirus infection with low concentration of virus particles.

PERFORMANCE CHARACTERISTICS

Table: Adenovirus Rapid Test vs. Latex Agglutination

Relative Sensitivity: >99.9% (95.6%-99.9%)* Relative Specificity: 99.4% (96.5%-99.9%)* Overall Agreement: 99.6% (97.7%-99.9%)* *95% Confidence Interval			Adenovirus Rapid Test		
			+	-	Total
	Latex Agglutination	+	82	0	82
		-	1	156	157
Total		83	156	239	









Specificity:
 Cross reactivity with following organisms has been studied at 1.0×10^9 organisms/mL. The following organisms were found negative when tested with the Adenovirus Rapid Test Cassette (Feces).

<i>Staphylococcus aureus</i>	<i>Proteus mirabilis</i>	<i>Neisseria gonorrhoea</i>
<i>Pseudomonas aeruginosa</i>	<i>Acinetobacter spp</i>	<i>Group B Streptococcus</i>
<i>Enterococcus faecalis</i>	<i>Salmonella choleraesuis</i>	<i>Proteus vulgaris</i>
<i>Group C Streptococcus</i>	<i>Gardnerella vaginalis</i>	<i>Enterococcus faecium</i>
<i>Klebsiella pneumoniae</i>	<i>Acinetobacter calcoaceticus</i>	<i>Hemophilus influenzae</i>
<i>Branhamella catarrhalis</i>	<i>E.coli</i>	<i>Neisseria meningitidis</i>
<i>Candida albicans</i>	<i>Chlamydia trachomatis</i>	

LITERATURE REFERENCES

- Wadell, G. Laboratory Diagnosis of Infectious Diseases: Principles and Practices. New York: Springer-Verlag, Volume II, 1988: 284-300.
- WILHELM I, ROMAN E, SANCHEZ-FAUQUIER A. Viruses causing gastroenteritis. Clin Microbiol Infect. April. 2003, vol.9:247-262
- Wood, D. J., K. Bijlsma, J. C. de Jong, and C. Tonkin. "Evaluation of a Commercial Monoclonal AntibodyBased Enzyme Immunoassay for Detection of Adenovirus Types 40 and 41 in Stool Specimens." Journal of Clinical Microbiology, June 1989; 27(6): 1155-1158.
- Thomas, Eva. E., D. Roscoe, L. Book, B. Bone, L. Browne, and V. Mah. "The Utility of Latex Agglutination Assays in the Diagnosis of Pediatric Viral Gastroenteritis." Am. J. Clin. Pathol. 1994; 101:742-746.

INDEX OF SYMBOLS

	Consult instructions for use		Tests per kit		Authorized Representative
	For <i>in vitro</i> diagnostic use only		Use by		Do not reuse
	Store between 2~30°C		Lot Number		Catalog#

 Zhejiang Orient Gene Biotech Co.,Ltd
 Address: 3787#, East Yangguang Avenue, Dipu Street,
 Anji 313300, Huzhou, Zhejiang, China.
 TEL: +86-572-5226111 FAX: +86-572-5226222
 Website: www.orientgene.com

 Shanghai International Holding Corp. GmbH (Europe)
 Add: Eiffestrasse 80, 20537 Hamburg, Germany

 GCADE-602a

Malaria P.f./P.v. Ag Rapid Test Cassette (Whole Blood)



INTENDED USE

The Malaria P.f./P.v. Ag Rapid Test Cassette (Whole Blood) is a rapid lateral flow chromatographic immunoassay for the simultaneous detection and differentiation of Malaria P.falciparum specific histidine rich protein-2 (Pf HRP-II) and Malaria P.vivax specific lactate dehydrogenase (Pv-LDH) in human blood specimen as an aid in the diagnosis of Malaria infection. It is for *In-Vitro* Diagnostic use only.

INTRODUCTION

Malaria is a serious, sometimes fatal, parasitic disease characterized by fever, chills, and anemia and is caused by a parasite that is transmitted from one human to another by the bite of infected Anopheles mosquitoes. There are four kinds of malaria that can infect humans: Plasmodium falciparum, P. vivax, P. ovale, and P. malariae. In humans, the parasites (called sporozoites) migrate to the liver where they mature and release another form, the merozoites. The disease now occurs in more than 90 countries worldwide, and it is estimated that there are over 500 million clinical cases and 2.7 million malaria-caused deaths per year. At the present, malaria is diagnosed by looking for the parasites in a drop of blood. Blood will be put onto a microscope slide and stained so that the parasites will be visible under a microscope.

PRINCIPLE

The Malaria P.f./P.v. Ag Rapid Test Cassette (Whole Blood) contains a membrane, which is precoated with mouse monoclonal antibodies specific to HRP-II of P. falciparum on test line Pf region and with mouse monoclonal antibodies specific to lactate dehydrogenase of P.vivax species on test line Pv region respectively. Conjugate pad is dispensed with monoclonal antibodies conjugated to colloidal gold, which are specific to P.falciparum histidine rich protein-2 (Pf HRP-II) and specific to the lactate dehydrogenase of P.vivax.

During the assay, an adequate volume of the blood specimen is dispensed into the sample well (S) of the test cassette, a lysis buffer is added to the buffer well (B). The buffer contains a detergent that lyses the red blood cells and releases various antigens, which migrate by capillary action across the strip held in the cassette. Pv-LDH if presents in the specimen will bind to the Pv-LDH-gold conjugates. The immunocomplex is then captured on the membrane by the pre-coated anti-Pv-LDH antibody, forming a burgundy colored Pv band, indicating a Pv positive test result.

Alternatively, pHRP-II if presents in the specimen will bind to the pHRP-II-gold conjugates. The immunocomplex is then captured on the membrane by the pre-coated anti-pHRP-II antibodies, forming a burgundy colored Pf band, indicating a Pf positive test result.

Absence of any T bands suggests a negative result. The test contains an internal control (C band) which should exhibit a burgundy colored band of the immunocomplex of goat anti- mouse IgG I mouse IgG (anti-Pv-LDH and anti-pHRP-II)-gold conjugates regardless of the color development on any of the T bands. Otherwise, the test result is invalid and the specimen must be retested with another device.

MATERIALS SUPPLIED

25 Sealed pouches each containing a test cassette, a dropper and a desiccant
1 Buffer, 7.0 mL
1 Package insert

MATERIAL REQUIRED BUT NOT PROVIDED

1. Clock or timer
2. Collection by venipuncture: collection tube (containing EDTA, citrate or heparin)
3. Collection using a lancet: sterile lancet

STORAGE AND STABILITY

All reagents are ready to use as supplied. Store unused test device unopened, preferably at 2°C-30°C. Do not expose the kit over 30°C. Do not freeze the kit. Ensure that the test device is brought to room temperature before opening. The test device is stable through the expiration date printed on the sealed pouch if it is stored at 2°C-30°C.

WARNINGS AND PRECAUTIONS

1. For professional *in vitro* diagnostic use only. Do not use after expiration date.
2. The instruction must be followed exactly to get accurate results. Failure to follow the insert gives inaccurate test results.
3. Do not eat, drink or smoke in the area where the specimens or kits are handled.
4. Handle all specimens as if they contain infectious agents. Observe established precautions against microbiological hazards throughout testing and follow the standard procedures for proper disposal of specimens.

5. Hemolized blood may be used for the testing, but do not take precipitants.
6. Wear protective clothing such as laboratory coats, disposable gloves and eye protection when specimens are being tested.
7. Humidity and temperature can adversely affect results.
8. Do not perform the test in a room with strong air flow, ie. an electric fan or strong airconditioning.

SPECIMEN COLLECTION

Collection by venipuncture:

- 1) Collect whole blood into a collection tube (containing EDTA, citrate or heparin) by venipuncture.
- 2) If specimens are not immediately tested, they should be refrigerated at 2-8°C. For storage periods greater than three days, freezing is recommended. They should be brought to room temperature prior to use. Using the specimen after long-term storage of more than three days can cause non-specific reaction.
- 3) When stored at 2-8°C, the whole blood sample should be used within three days.

Collection using a lancet:

- 1) Clean the area to be lanced with an alcohol swab.
- 2) Squeeze the end of the fingertip and pierce with a sterile lancet.
- 3) Wipe away the first drop of blood with sterile gauze or cotton.
- 4) Using the dropper provided, while gently squeezing the tube, immerse the open end in the blood drop and then gently release the pressure to draw blood into the dropper.

TEST PROCEDURE

Allow the test device, specimen, buffer, and/or controls to equilibrate to room temperature (15-30°C) prior to testing.

1. Remove the test cassette from the foil pouch and use it as soon as possible. Best results will be obtained if the assay is performed within one hour.
2. Place the test cassette on a clean and level surface. Be sure to label the device with specimen's ID number.
3. With a 5 µL mini plastic dropper provided, draw whole blood specimen to exceed the specimen line as showed in the following image and then transfer drawn whole blood into the sample well (S). Then add 3 drops (about 120 µL) of Lysis Buffer to the buffer well (B) immediately.

Note: Practice a few times prior to testing if you are not familiar with the mini dropper. For better precision, transfer specimen by pipette capable to deliver 5 µL of volume.

4. Set up timer.

If preferred, after 5 minutes of adding specimen and buffer, you may add one more drop of Lysis Buffer to help the background become clearer.

5. Results can be read in 20 to 30 minutes. It may take more than 20 minutes to have the background become clearer. Don't read results after 30 minutes. To avoid confusion, discard the test cassette after interpreting the result.

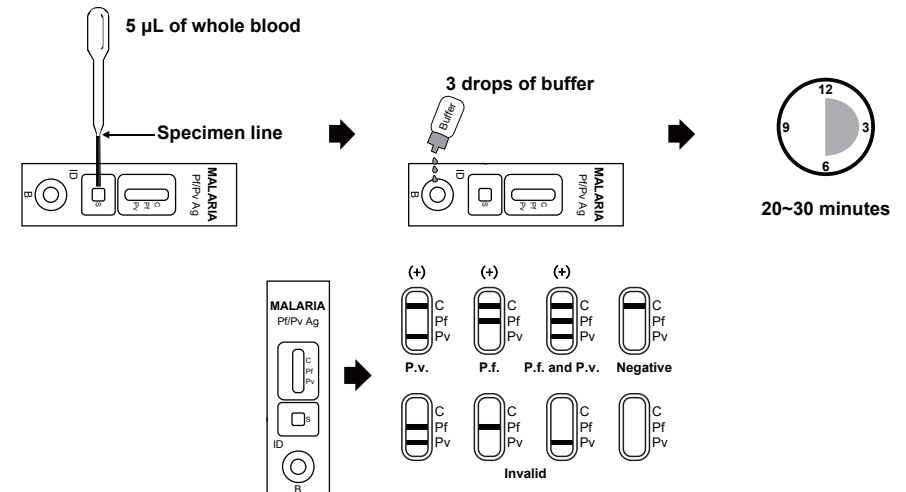

Malaria P.f./P.v. Ag Rapid Test Cassette (Whole Blood)

INTERPRETATION OF RESULTS

(Please refer to the illustration above)

POSITIVE:

P.f Positive: One line appears in the control region, and one line appears in P.f. line region.

P.v Positive: One line appears in the control region and one line appears in Pv line region.

P.f and P.v Positive: One line appears in the control region, one line appears in Pv line region and one line appears in P.f. line region.

NEGATIVE: Only one colored line appears in the control region.

INVALID: Control line fails to appear. Insufficient specimen volume or incorrect procedural techniques are the most likely reasons for control line failure. Review the procedure and repeat the test with a new test device. If the problem persists, discontinue using the test kit immediately and contact your local distributor.

QUALITY CONTROL

Internal procedural controls are included in the test. A colored line appearing in the control region (C) is an internal procedural control. It confirms sufficient specimen volume and correct procedural technique. Control standards are not supplied with this kit; however, it is recommended that positive and negative controls be tested as a good laboratory practice to confirm the test procedure and to verify proper test performance.

LIMITATIONS

- The Malaria P.f./P.v. Ag Rapid Test Cassette (Whole Blood) is for *in vitro* diagnostic use only. This test should be used for the detection of P.f and P.v antigens in whole blood specimens only. Neither the quantitative value nor the rate of increase in P.f and P.v concentration can be determined by this qualitative test.
- The Malaria P.f./P.v. Ag Rapid Test Cassette (Whole Blood) will only indicate the presence of antigens of P.f and / or P.v in the specimen and should not be used as the sole criterion for the diagnosis of malaria infection.
- As known relevant interference, haemolytic samples, rheumatoid factors-contained samples and lipaemic, icteric samples can lead to impair the test results.
- The test is limited to the detection of antigen to Malaria Plasmodium sp. Although the test is very accurate in detecting HRP-II specific to P.f or pLDH specific to P.v, a low incidence of false results can occur. Other clinically available tests are required if questionable results are obtained.
- If the test result is negative and clinical symptoms persist, additional testing using other clinical methods is recommended. A negative result does not at any time preclude the possibility of malaria infection.
- As with all diagnostic tests, a definitive clinical diagnosis should not be based on the results of a single test, but should only be made by the physician after all clinical and laboratory findings have been evaluated.

PERFORMANCE CHARACTERISTICS

1. Clinical Performance for P.f Ag test:

A total of 352 samples from susceptible subjects were tested by the Malaria P.f./P.v. Ag Rapid Test Cassette (Whole Blood) and by thick blood smear test.

Method		Smear Test		Total Results
Malaria Pf/Pv Ag Rapid Test	Results	Positive	Negative	
	Positive	50	4	54
	Negative	0	298	298
Total Results		50	302	352

Relative Sensitivity: 100%

Relative Specificity: 98.7%

Overall Agreement: 98.9%

2. Clinical Performance for P.v Ag test:

A total of 289 samples from susceptible subjects were tested by the Malaria P.f./P.v. Ag Rapid Test Cassette (Whole Blood) and by thick blood smear test.

Method		Smear Test		Total Results
Malaria Pf/Pv Ag Rapid Test	Results	Positive	Negative	
	Positive	63	3	66
	Negative	0	223	223
Total Results		63	226	289

Relative Sensitivity: 100%

Relative Specificity: 98.7%

Overall Agreement: 99.0%

3. Precision: Within-run and between-run have been determined by the testing 10 replicates of four specimens: a negative, a low positive, a medium positive and a strong positive. All values were correctly identified 100% of the time.

4. Interference: To evaluate the interference of Malaria P.f./P.v. Ag Rapid Test Cassette (Whole Blood) with known relevant interfering specimens, the haemolytic samples, rheumatoid factors-contained samples and lipaemic, icteric samples were investigated. In these studies, those specimens did not interfere with the Malaria P.f./P.v. Ag Rapid Test Cassette (Whole Blood).

REFERENCE

- Leonard K. Basco, Frederique Marquet, Michael M. Makler, and Jacques Le Bras.: Plasmodium falciparum and Plasmodium vivax: Lactate Dehydrogenase Activity and its Application for *in vitro* Drug Susceptibility Assay. Experimental Parasitology 80, 260-271 (1995)
- David L. Vander Jagt, Lucy A. Hunsaker and John E. Heidrich : Partial Purification and Characterization of Lactate Dehydrogenase from Plasmodium falciparum. Molecular and Biochemical Parasitology, 4 (1981) 255-264
- David J. Bzik, Barbara A. Fox and Kenneth Gonyer : Expression of Plasmodium falciparum lactate dehydrogenase in Escherichia coli Molecular and Biochemical Parasitology, 59(1993) 155-166
- Histidine-Rich Protein II: a Novel Approach to Malaria Drug Sensitivity Testing ANTIMICROBIAL AGENTS AND CHEMOTHERAPY, June 2002, p. 1658©1664 Vol. 46, No. 6

INDEX OF SYMBOLS

	Consult instructions for use		Tests per kit		Authorized Representative
	For <i>in vitro</i> diagnostic use only		Use by		Do not reuse
	Store between 2~30°C		Lot Number		Catalog#

Zhejiang Orient Gene Biotech Co., Ltd
Address: 3787#, East Yangguang Avenue, Dipu Street,
Anji 313300, Huzhou, Zhejiang, China
Tel: +86-572-5226111 Fax: +86-572-5226222
Website: www.orientgene.com

QARAD BV
Cipalstraat 3, 2440 Geel BELGIUM

GCMAL(pf/pv)-402a

Influenza A & B Ag Rapid Test Cassette (Swab)

INTENDED USE

The Influenza A & B Ag Rapid Test Cassette (Swab) is an *in vitro* immunochromatographic assay for the qualitative detection of influenza A (including the subtype H1N1) and B nucleoprotein antigens in nasopharyngeal swabs, nasal swabs, throat swabs or nasal aspirates specimens. It is intended to aid in the rapid differential diagnosis of influenza A and B viral infections.

SUMMARY AND EXPLANATION

Influenza is an acute and highly contagious viral infection of the respiratory tract. The causative agents of the disease are immunologically diverse, single-strand RNA virus known as influenza viruses. There are three types of influenza viruses: A, B and C.

Type A Viruses are the most prevalent and are associated with most serious epidemics, while Type B infection is generally milder. Type C virus have never been associated with a large epidemic of human disease. Both type A and B viruses can circulate simultaneously, but usually one type is dominant during a given season and particular epidemic area. The disease is easily transmitted through coughing and sneezing of aerosolized droplets containing live virus. Influenza outbreaks normally occur each year during fall and winter seasons. Rapid diagnosis of influenza infection will help healthcare professionals to treat patients and control the disease more efficiently and effectively.

PRINCIPLE OF THE TEST

The Influenza A&B Ag Rapid Test Cassette (Swab) is an immunochromatographic membrane assay that uses highly sensitive monoclonal antibodies to detect influenza type A and B nucleoprotein antigens in nasopharyngeal swabs, nasal swabs, throat swabs or nasal aspirates specimens. The test strip is composed of the following parts: namely sample pad, reagent pad, reaction membrane, and absorbing pad. The reagent pad contains the colloidal-gold conjugated with the monoclonal antibodies against Influenza virus A and B; the reaction membrane contains the secondary antibodies either for virus A or for B. The whole strip is fixed inside a plastic device. When the sample is added into the sample well, conjugates dried in the reagent pad are dissolved and migrate along with the sample. If influenza A presents in the sample, a complex formed between the anti-influenza A conjugate and the virus will be captured by the specific anti-influenza A monoclonal antibodies coated on the A region (A). If the sample contains influenza B, a complex formed between the anti-influenza B conjugate and the virus will be captured by the specific anti-influenza B monoclonal antibodies coated on the B region (B).

Results appear at 10 minutes in the form of a red line that develops on the membrane. To serve as a procedural control, a red line will always appear in the control region (C) indicating that proper volume of sample has been added and membrane wicking has occurred.

MATERIALS PROVIDED

- 20 Test cassettes
- 20 Sterile swabs
- 20 Extraction tubes and tips
- 1 Workstation
- 2 Buffers
- 1 Package inset

MATERIALS REQUIRED BUT NOT PROVIDED

1. Clock, timer, or stopwatch

WARNINGS AND PRECAUTIONS

1. For professional *in vitro* diagnostic use only.
2. The test cassette should remain in the sealed pouch until use.
3. Do not use kit past its expiration date.
4. Swabs, tubes and test cassettes are for single use only.
5. Solutions that contain sodium azide may react explosively with lead or copper plumbing. Use large quantities of water to flush discarded solutions down a sink.
6. Do not interchange or mix components from different kit lots.
7. Humidity and temperature can adversely affect results.
8. Used testing materials should be discarded in accordance with local regulations.

STORAGE AND STABILITY

1. The kit can be stored at room temperature or refrigerated (2-30°C).
2. Do not freeze any of the test kit components.
3. Do not use test cassette and reagents after expiration date.
4. Test cassettes that have been outside of the sealed pouch for more than 1 hour should be discarded.
5. Close the kit box and secure its contents when not in use.

SPECIMEN COLLECTION

It is applicable to the diagnosis of the influenza virus A and B from the samples of nasopharyngeal swabs, nasal swabs, throat swabs or nasal aspirates. Use freshly collected samples for optimal test performance. Inadequate sample collection or improper sample handling may yield a false-negative result.

For Nasopharyngeal Swab Specimen Collection:

1. Using the sterile swab provided in the kit, carefully insert the swab in the patient's nostril.
2. Swab over the surface of the posterior nasopharynx and rotate the swab several times.
3. Withdraw the swab from the nasal cavity. The specimen is now ready for preparation using the extraction buffer provided in the test kit.



For Nasal Swab Specimen Collection:

1. Using the sterile swab provided in the kit, carefully insert the swab into one nostril of the patient. The swab tip should be inserted up to 2-4 cm until resistance is met.
2. Roll the swab 5 times along the mucosa inside the nostril to ensure that both mucus and cells are collected.
3. Using the same swab, repeat this process for the other nostril to ensure that an adequate sample is collected from both nasal cavities.
4. Withdraw the swab from the nasal cavity. The sample is now ready for processing using the Influenza A & B Ag Rapid Test Cassette (Swab).

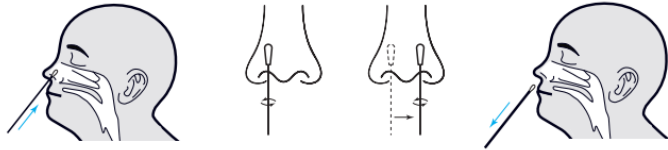

For Throat Swab Specimen Collection:

1. Deeply insert the sterilized swab into the throat and swab several times to collect the epidermal cells of the mucus. Caution has to be paid to avoid the swab to be contaminated with saliva.
2. Withdraw the swab from the throat. The sample is now ready for processing using the Influenza A & B Ag Rapid Test Cassette (Swab).



For Nasal Aspirates Specimen Collection:

Nasal aspirator is not provided in the kit. Collect nasal aspirate fluids according to the instructions for use of the used nasal aspirator.



SAMPLE PREPARATION PROCEDURE

Insert the test extraction tube into the workstation provided in the kit. Make sure that the tube is standing upright and reaches the bottom of the workstation. Add the sample buffer to extraction tube until it reaches the lower mark (about 13-17 drops, 0.5 mL)

For nasopharyngeal, nasal or throat swabs:

Insert the swab into the extraction tube which contains 0.5 mL of the extraction buffer. After mixing, squeeze the tube several times with fingers from outside of the tube to immerse the swab. Remove the swab. The extracted solution will be used as test sample.

For nasal aspirate fluids:

Add 0.5 mL of the nasal aspirate fluids into the extraction tube which contains 0.5 mL of the extraction buffer, and mix well to be used as test sample.

SPECIMEN TRANSPORT AND STORAGE

Specimens should be tested as soon as possible after collection. If transport of the samples is required, the following transport media are recommended and have been tested and shown not to interfere with the performance of the test: Hank's Balanced salt solution, M5 Media, or saline. Alternatively, samples may be stored refrigerated (2-8°C), or at room temperature (15-30°C), in a clean, dry, closed container for up to eight hours prior to testing. Nasal wash/aspirate specimens may also be stored frozen (-70°C or colder) for up to one month.

TEST PROCEDURE

Allow the test cassette, test sample and buffer to equilibrate to room temperature (15-30°C) prior to testing.

1. Just prior to testing remove the test cassette from the sealed pouch and lay it on a flat surface.
2. Push the nozzle which contains the filter onto the extraction tube. Ensure the nozzle has a tight fit.
3. Hold the extraction tube vertically and add 4 drops (approximately 100 µL) of test sample solution into the sample well.
4. Start the timer.
5. Read the results at 10 minutes. Do not interpret the result after 20 minutes.

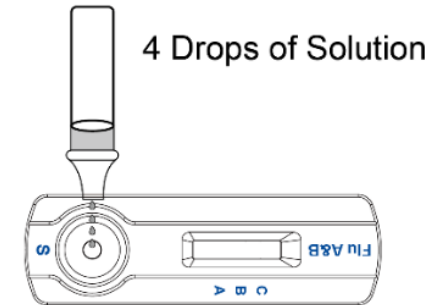

INTERPRETATION OF RESULTS

	<p>POSITIVE</p> <p>1. Flu A Positive: The presence of two lines as control line (C) and A test line within the result window indicates a positive result for Influenza A viral antigen.</p> <p>2. Flu B Positive: The presence of two lines as control line (C) and B test line within the result window indicates a positive result for Influenza B viral antigen.</p> <p>3. Flu A+B Positive: The presence of three lines as control line (C), A test line and B test line within the result window indicates a positive result for Influenza A and Influenza B viral antigen.</p>
	<p>NEGATIVE</p> <p>The presence of only control band (C) within the result window indicates a negative result.</p>

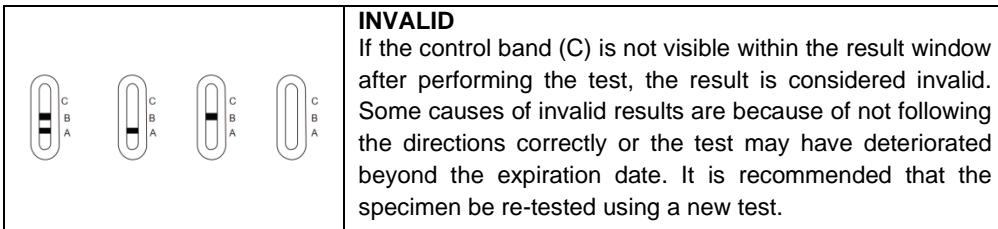

NOTE:

1. The intensity of color in the test region (A/B) may vary depending on the concentration of analyses present in the specimen. Therefore, any shade of color in the test region (A/B) should be considered positive. Please note that this is a qualitative test only, and cannot determine the concentration of analytes in the specimen.
2. Insufficient specimen volume, incorrect operating procedure or expired tests are the most likely reasons for control band failure.

QUALITY CONTROL

A procedural control is included in the test. A red line appearing in the control line region (C) is the internal procedural control. It confirms sufficient specimen volume and correct procedural technique. Control standards are not supplied with this test. However, it is recommended that positive and negative controls are sourced from a local competent authority and tested as a good laboratory practice, to confirm the test procedure and verify the test performance.

LIMITATIONS

1. The Influenza A&B Ag Rapid Test Cassette (Swab) is for professional in vitro diagnostic use, and should only be used for the qualitative detection of influenza A and/or B.
2. The etiology of respiratory infection caused by microorganisms other than influenza A or B virus will not be established with this test. The Influenza A&B Ag Rapid Test Cassette (Swab) is capable of detecting both viable and non-viable influenza particles. The performance of the Influenza A&B Ag Rapid Test depends on antigen load and may not correlate with cell culture performed on the same specimen.
3. If the test result is negative and clinical symptoms persist, additional testing using other clinical methods is recommended. A negative result does not at anytime rule out the presence of influenza A and/or B viral antigens in specimen, as they may be present below the minimum detection level of the test. As with all diagnostic tests, a confirmed diagnosis should only be made by a physician after all clinical and laboratory findings have been evaluated.
4. The validity of Influenza A&B Ag Rapid Test Cassette (Swab) has not been proven for identification or confirmation of cell culture isolates.
5. Inadequate or inappropriate specimen collection, storage, and transport may yield false negative test result.
6. Although this test has been shown to detect cultured avian influenza viruses, including avian influenza A subtype H5N1 virus, the performance characteristics of this test with specimens from humans infected with H5N1 or other avian influenza viruses are unknown.
7. Performance characteristics for influenza A were established when influenza A/H3 and A/H1 were the predominant influenza A viruses in circulation. When other influenza A viruses are emerging, performance characteristics may vary.
8. Children tend to shed virus for longer periods of time than adults, which may result in differences in sensitivity between adults and children.
9. Positive and negative predictive values are highly dependent on prevalence. False positive

test results are more likely during periods of low influenza activity when prevalence is moderate to low.

PERFORMANCE CHARACTERISTICS

1. Analytical Sensitivity

The minimum detection limit is 1.5×10^4 TCID₅₀/test for the Influenza A virus antigen and is 1.5×10^5 TCID₅₀/test for the Influenza B virus antigen.

2. Analytical Reactivity

The influenza A strain listed tested positive in the Influenza A&B Ag Rapid Test Cassette (Swab). Although the specific influenza strains causing infection in human can vary, all contain the conserved nucleoproteins targeted by Influenza A&B Ag Rapid Test Cassette (Swab).

Strains	Sources	Subtypes	Concentration
Flu A/Hubei/PR 8/2001	Human	H1N1	1.8×10^4 TCID ₅₀ /test
Flu A/New Kaledonia/20/99	Human	H1N1	1.8×10^4 TCID ₅₀ /test
Flu A/Yamagata/32/89	Human	H1N1	1.8×10^4 TCID ₅₀ /test
Flu A/Beijing/262/95	Human	H1N1	1.8×10^4 TCID ₅₀ /test
Flu A/Singapore/1/57	Human	H2N2	3.0×10^4 TCID ₅₀ /test
Flu A/Hubei/3/2005	Human	H3N2	3.0×10^4 TCID ₅₀ /test
Flu A/Akita/1/94	Human	H3N2	3.0×10^4 TCID ₅₀ /test
Flu A/Iowa/15/30	Swine	H1N1	3.0×10^4 TCID ₅₀ /test
Flu A/Hongkong/168/93	Swine	H1N1	3.0×10^4 TCID ₅₀ /test
Flu A/Anhui/24/2004	Swine	H5N1	6.0×10^4 TCID ₅₀ /test
Flu A/Hubei/134/2000	Swine	H9N2	6.0×10^5 TCID ₅₀ /test
Flu A/Hubei/251/2001	Swine	H9N2	6.0×10^5 TCID ₅₀ /test
Flu A/Yuyao/1/2006	Chicken	H5N1	6.0×10^4 TCID ₅₀ /test
Flu A/Yuyao/2/2006	Chicken	H5N1	6.0×10^4 TCID ₅₀ /test
Flu A/Jiangsu/2/2004	Chicken	H5N1	6.0×10^4 TCID ₅₀ /test
Flu A/Hubei/216/83	Duck	H7N8	3.0×10^5 TCID ₅₀ /test
Flu A/Hubei/118/2003	Duck	H9N2	1.5×10^5 TC ID ₅₀ /test
Flu A/Hubei/155/2003	Duck	H9N2	6.0×10^5 TCID ₅₀ /test
Flu A/Hubei/137/1982	Duck	H10N4	3.0×10^5 TCID ₅₀ /test
Flu A/Singapore/3/97	Duck	H5N3	6.0×10^4 TCID ₅₀ /test
Flu A/Henan/1/2004	Tree sparrow	H5N1	6.0×10^5 TCID ₅₀ /test
Flu A/Henan/2/2004	Tree sparrow	H5N1	3.0×10^5 TCID ₅₀ /test
Flu A/Henan/4/2004	Tree sparrow	H5N1	6.0×10^4 TCID ₅₀ /test
Flu A/Wisconsin/66	Turkey	H9N2	6.0×10^4 TCID ₅₀ /test
Flu A/England/1/63	Turkey	H7N3	6.0×10^4 TCID ₅₀ /test
Flu A/Singapore/1/57	Bird	H5N1	6.0×10^4 TCID ₅₀ /test
Flu A/Hunan/71/2004	Bird	H5N1	6.0×10^4 TCID ₅₀ /test
Flu A/Shanxi/50/2006	Bird	H5N1	6.0×10^4 TCID ₅₀ /test
Flu A/Shanxi/42/2006	Bird	H5N1	6.0×10^4 TCID ₅₀ /test
Flu A/Fujian/320/2004	Bird	H5N1	3.0×10^5 TCID ₅₀ /test

Influenza A&B Ag Rapid Test Cassette (Swab) can detect all nine influenza B strains.

3. Clinical Study Data Summary

The Influenza A&B Ag Rapid Test performance vs. Cell Culture

Kind of samples	Type	Sensitivity (%)	Specificity (%)	Accuracy (%)
Nasopharyngeal/Nasal Swab	A	92.6 (25/27)	96.4 (81/84)	95.5 (106/111)
	B	90.0 (27/30)	95.8 (91/95)	94.4 (118/125)

Throat Swab	A	83.3 (20/24)	95.2 (59/62)	91.9 (79/86)
	B	82.6 (19/23)	91.8 (67/73)	89.6 (86/96)
Nasal Aspirate	A	88.9 (48/54)	93.3 (125/134)	92.0 (173/188)
	B	91.2 (52/57)	95.4 (98/103)	93.8 (150/160)

4. Analytical Specificity and Cross-reactivity

The Influenza A&B Ag Rapid Test Cassette (Swab) was evaluated with a total of 30 bacterial and viral isolates. Bacterial isolates were evaluated at a concentration between 10^7 and 10^9 or g/mL. Viral isolates were evaluated at a concentration of at least 10^4 - 10^8 TCID₅₀/mL. Adenovirus 18 and Parainfluenza virus 3 were tested at 10^2 TCID₅₀/mL. None of the organisms or viruses listed below gave a positive result in the Influenza A&B Ag Rapid Test Cassette (Swab).

Bacterial Panel:

Acinetobacter calcoaceticus	Bacteroides fragilis
Neisseria gonorrhoeae	Neisseria meningitidis
Pseudomonas aeruginosa	Staphylococcus aureus
Streptococcus pneumoniae	Streptococcus sanguis
Proteus vulgaris	Streptococcus sp. Gp. B
Streptococcus sp. Gp. C	Streptococcus sp. Gp. G
Mycobacterium tuberculosis	Mycoplasma orale

Viral Panel:

Human Adenovirus B	Human Rhinovirus 2
Human Adenovirus C	Human Rhinovirus 14
Adenovirus type 10	Human Rhinovirus 16
Adenovirus type 18	Measles
Human Coronavirus OC43	Mumps
Human Coxsackievirus A9	Sendai virus
Coxsackievirus B5	Parainfluenza virus 2
Human herpesvirus2	Parainfluenza virus 3









5. Interfering Substances

Whole blood, and several over-the-counter (OTC) products and common chemicals were evaluated and did not interfere with the Influenza A&B Ag Rapid Test Cassette (Swab) at the levels tested: whole blood (2%); three OTC mouthwashes (25%); three OTC throat drops (25%); three OTC nasal sprays (10%); 4-Acetamidophenol (10 mg/mL); Acetylsalicylic Acid (20 mg/mL); Chlorpheniramine (5 mg/mL); Dextromethorphan (10 mg/mL); Diphenhydramine (5 mg/mL); Ephedrine (20 mg/mL); Guaiacol glyceryl ether (20 mg/mL); Oxymetazoline (10 mg/mL); Phenylephrine (100 mg/mL); and Phenylpropanolamine (20 mg/mL).

REFERENCES

1. Williams, KM, Jackson MA, Hamilton M. (2002) Rapid Diagnostic Testing for URIs in Children: Impact on Physician Decision Making and Cost. Infect. Med. 19(3): 109-111.
2. Dowdle, W.R, Kendal, A.P., and Noble, G.R. (1980). Influenza Virus, p 836-844. Manual of Clinical Microbiology, 3rd edition, in Lennette, et. al (ed.). American Society for Microbiology, Washington, D.C.
3. "Key Facts about Avian Influenza (Bird Flu) and Avian Influenza A (H5N1) Virus" CDC Publication, May 24, 2005. <http://www.cdc.gov/flu/avian/gen-info/facts.htm>
4. "Avian Influenza Infection in Humans" CDC Publication, May 24, 2005. <http://www.cdc.gov/flu/avian/gen-info/avian-flu-humans.htm>
5. "Updated Interim Guidance for Laboratory Testing of Persons with Suspected Infection with Avian Influenza A (H5N1) Virus in the United States" CDC Health Alert, June 7, 2006. <http://www.phppo.cdc.gov/HAN/ArchiveSys/ViewMsgV.asp?AlertNum=00246>

INDEX OF SYMBOLS

	Consult instructions for use		Tests per kit		Authorized Representative
	For <i>in vitro</i> diagnostic use only		Use by		Do not reuse
	Store between 2~30°C		Lot Number		Catalog#

 Zhejiang Orient Gene Biotech Co.,Ltd
Address: 3787#, East Yangguang Avenue, Dipu Street,
Anji 313300, Huzhou, Zhejiang, China
Tel: +86-572-5226111 Fax: +86-572-5226222
Website: www.orientgene.com

 Shanghai International Holding Corp. GmbH (Europe)
Add: Eiffestrasse 80, 20537 Hamburg, Germany

 GCFLU(A/B)-502a

Revision Date: 2022-11-14
B21900-03

Clostridium difficile Antigen GDH Rapid Test Cassette (Feces)



INTENDED USE

The Clostridium difficile Antigen GDH Rapid Test Cassette (Feces) a rapid visual immunoassay for the qualitative, presumptive detection of Clostridium difficile Glutamate Dehydrogenase (GDH) in human fecal specimens, as a screening test and as an aid in the diagnosis of Clostridium difficile infection.

INTRODUCTION

Clostridium difficile (C.difficile), a Gram-positive spore bearing anaerobic bacterium is the major aetiological agent of diarrhoea and colitis associated with antibiotics. C. difficile is the most common cause of health care-associated diarrhoea in developed countries and is a major source of nosocomial morbidity and mortality worldwide

Disease due to C. difficile develops when the organism is allowed to proliferate in the colon, most commonly after antibiotic use has eliminated competing flora. C.difficile can release two high-molecular-weight toxins, toxin A and toxin B, which are responsible for the clinical manifestations, which range from mild, self-limited watery diarrhoea to fulminant pseudomembranous colitis, toxic megacolon and death.

Clostridium difficile Glutamate Dehydrogenase (GDH) is an enzyme produced in large quantities by all toxigenic and non-toxigenic strains, making it an excellent marker for the organism.

The toxigenic culture (TC) is used as the gold standard technique to determine Clostridium difficile infection. This method consists in culture and isolation of C. difficile from faeces, followed by toxin testing of the isolate, a labour-intensive assay to obtain a result.

The Clostridium difficile Antigen GDH Rapid Test Cassette (Feces) is a rapid test to qualitatively detect Clostridium difficile Glutamate Dehydrogenase (GDH) in human feces in 10 minutes. The test can be performed by untrained or minimally skilled personnel, without cumbersome laboratory equipment.

PRINCIPLE

The Clostridium difficile Antigen GDH Rapid Test Cassette (Feces) is a qualitative lateral flow immunoassay for the detection of Clostridium difficile GDH in human feces samples. The membrane is pre-coated with monoclonal antibodies against GDH on the test line region. During testing, the sample reacts with the particle coated with anti-GDH antibodies, which were pre-dried on the test strip. The mixture moves upward on the membrane by capillary action. If there is sufficient Clostridium difficile GDH in the specimen, a colored band will form at the test region of the membrane. The presence of this colored band indicates a positive result, while its absence indicates a negative result. The appearance of a colored band at the control region serves as a procedural control, indicating that the proper volume of specimen has been added and membrane wicking has occurred. If the control line does not appear, the test result is not valid.

PRODUCT CONTENTS

The Clostridium difficile Antigen GDH Rapid Test Cassette (Feces) containing Clostridium difficile GDH-specific antibodies coated particles and GDH-specific antibodies coated on the membrane.

MATERIALS SUPPLIED

- 20 Test cassettes
- 20 Extraction tubes with buffer
- 1 Package insert

MATERIAL REQUIRED BUT NOT PROVIDED

Timer

STORAGE AND STABILITY

The kit can be stored at room temperature or refrigerated (2-30°C). The test Cassette is stable through the expiration date printed on the sealed pouch. The test Cassette must remain in the sealed pouch until use. DO NOT FREEZE. Do not use beyond the expiration date.

WARNINGS AND PRECAUTIONS

1. For professional in vitro diagnostic use only.
2. Do not use after the expiration date indicated on the package. Do not use the test if the foil pouch is damaged.
3. Test is for single use only. Do not re-use under any circumstances.
4. Avoid cross-contamination of specimens by using a new extraction tube for each specimen obtained.

5. Read the entire procedure carefully prior to testing.
6. Do not eat, drink or smoke in any area where specimens and kits are handled.
7. Handle all specimens as if they contain infectious agents. Observe established precautions against microbiological hazards throughout the procedure and follow standard procedures for the proper disposal of specimens. Wear protective clothing such as laboratory coats, disposable gloves and eye protection when specimens are assayed.
8. Do not interchange or mix reagents from different lots. Do not mix solution bottle caps.
9. Humidity and temperature can adversely affect results.
10. Do not perform the test in a room with strong air flow, ie. electric fan or strong airconditioning.

SPECIMEN COLLECTION AND PREPARATION

- The Clostridium difficile Antigen GDH Rapid Test Cassette (Feces) is intended for use with human fecal specimens only.
- Stool samples should be collected in clean containers. The samples can be stored in the refrigerator (2-8°C) for 7 days prior to testing. For longer storage, maximum 1 year, the specimen must be kept frozen a-20°C. In this case, the sample will be totally thawed and brought to room temperature before testing. Ensure only the amount needed is thawed because of freezing and defrosting cycles are not recommended. Homogenise stool samples as thoroughly as possible prior to preparation.

SPECIMEN PREPARATION

Consider any materials of human origin as infectious and handle them using standard biosafety procedures.

1. Collect a random sample of feces in a clean, dry receptacle. Best results will be obtained if the assay is performed within 6 hours after collection.
2. Unscrew and remove the dilution tube applicator. Be careful not to spill or spatter solution from the tube. Collect specimens by inserting the applicator stick into at least 5 different sites of the feces to collect approximately 50 mg of feces (equivalent to 1/4 of a pea).
3. **For liquid specimens:** Hold the pipette vertically, aspirate fecal specimens, and then transfer 3 drops (approximately 80µL) into the specimen collection tube containing the extraction buffer.
4. Replace the stick in the tube and tighten securely.
5. Shake the specimen collection tube vigorously to mix the specimen and the extraction buffer. Specimens prepared in the specimen collection tube may be stored for 6 months at -20° C if not tested within 1 hour after preparation.

TEST PROCEDURE

Bring tests, specimens, reagents and/or controls to room temperature (15-30°C) prior to testing.

1. Remove the test from the sealed pouch and place it on a clean, level surface. Label the device with patient or control identification. For best results, the assay should be performed immediately after opening the foil pouch.
2. Holding the sample collection device upright, carefully break off the tip of collection device.
3. Squeeze 3 drops (~90µL) of the sample solution in the sample well of the device and start the timer.
4. Wait for the colored line(s) to appear. Read results in 10 minutes. Do not interpret the result after 10 minutes.

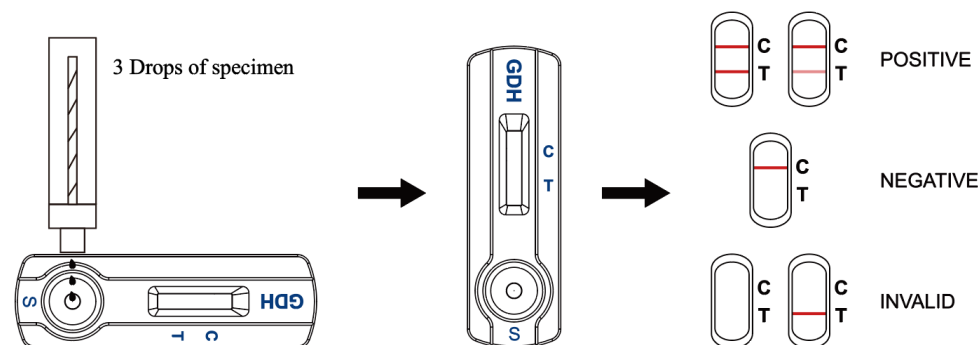

INTERPRETATION OF RESULTS

(Please refer to the illustration above)

Positive: Two lines appear. One colored line should be in the control line region (C) and another apparent colored line should be in the test line region (T).

Negative: One colored line appears in the control line region(C). No line appears in the test line region (T).

Invalid: Control line fails to appear. Insufficient specimen volume or incorrect procedural techniques are the most likely reasons for control line failure. Review the procedure and repeat the test with a new test cassette. If the problem persists, discontinue using the test kit immediately and contact your local distributor.

QUALITY CONTROL

A procedural control is included in the test. A red line appearing in the control region (C) is the internal procedural control. It confirms sufficient specimen volume and correct procedural technique. Control standards are not supplied with this test. However, it is recommended that positive and negative controls are sourced from a local competent authority and tested as a good laboratory practice, to confirm the test procedure and verify the test performance.

LIMITATIONS

- The Clostridium difficile Antigen GDH Rapid Test Cassette (Feces) will only indicate the presence of parasites in the specimen (qualitative detection) and should be used for the detection of Clostridium difficile GDH in faeces specimens only. Neither the quantitative value nor the rate of increase in antigen concentration can be determined by this test.
- An excess of sample could cause wrong results (brown bands appear). Dilute the sample with the buffer and repeat the test.
- The Clostridium difficile Antigen GDH Rapid Test Cassette (Feces) should be used only with samples from human faeces. The use of other samples has not been established. The quality of the test depends on the quality of the sample; proper faecal specimens must be obtained
- Positive results determine the presence of Clostridium difficile in faecal samples; never the less it can be due to toxigenic or non-toxigenic strains of Clostridium difficile. A positive result should be flowed up with additional laboratory techniques (toxigenic culture) to determine the strain.
- A negative result is not meaningful because of it is possible the antigen concentration in the stool samples is lower than the detection limit value. If the symptoms or situation still persist, a Clostridium difficile determination should be carried out, on a sample from an enrichment culture.
- As with all diagnostic tests, a definitive clinical diagnosis should not be based on the results of a single test, but should only be made by the physician after all clinical and laboratory findings have been evaluated.

PERFORMANCE CHARACTERISTICS

1. Clinical Sensitivity, Specificity and Accuracy

The Clostridium difficile Antigen GDH Rapid Test Cassette (Feces) has been evaluated with specimens obtained from patients. ELISA method was used as the reference method. The results show that the Clostridium difficile Antigen GDH Rapid Test Cassette (Feces) has a high overall relative accuracy.

Table 1: The Clostridium difficile Antigen GDH Rapid Test vs ELISA

Method		ELISA		Total Results
Clostridium difficile Antigen GDH Rapid Test Cassette	Results	Positive	Negative	
	Positive	62	1	63
	Negative	0	50	50
Total Results		62	51	113

Relative Sensitivity: 100%

Relative Specificity: 98.0%

Accuracy: 99.1%

2. Analytical Sensitivity

The Clostridium difficile Antigen GDH Rapid Test Cassette (Feces) was determined by testing serial dilutions of recombinant antigen. The Clostridium difficile Antigen GDH Rapid Test Cassette (Feces) can detect the levels of Clostridium difficile GDH recombinant antigen as low as 1ng/mL.

3. Cross-Reactivity









Cross-reactivity to samples positive for the following pathogens was tested and found to be negative: *Campylobacter*

<i>Campylobacter coli</i>	<i>Salmonella enteritidis</i>	<i>Shigella dysenteriae</i>
<i>Campylobacter jejuni</i>	<i>Salmonella paratyphi</i>	<i>Shigella flexneri</i>
<i>E. Coli O157: H7</i>	<i>Salmonella typhi</i>	<i>Shigella sonnei</i>
<i>H. Pylori</i>	<i>Salmonella typhimurium</i>	<i>Staphylococcus aureus</i>
<i>Listeria monocytogenes</i>	<i>Shigella boydii</i>	<i>Yersinia enterocolitica</i>

REFERENCE

- Knoop, F.C. et al.: Clostridium difficile: Clinical disease and diagnosis. Clin.Microbiol. Rev. (1993); 6: 251-265.
- Kelly, C.P. et al.: Clostridium difficile Colitis. New Engl. J. Med. (1994); 330: 257-262.
- Sullivan, N.M. et al.: Purification and characterization of toxins A and B of Clostridium difficile. Infect. Immun. (1982); 35: 1032-1040.
- McDonald, L.C. et al.: An epidemic, toxin gene-variant strain of Clostridium difficile.N. Engl. J. Med. (2005); 353: 23.
- Loo, V.G. et al.: A predominantly clonal multi-institutional outbreak of Clostridium difficile-associated diarrhea with high morbidity and mortality. N. Engl. J. Med. (2005); 353.23.
- Bartlett, J.G., Gerding, D.N.: Clinical recognition and diagnosis of Clostridium difficile infection. CID (2008); 46(Suppl. 1): 12-18.

INDEX OF SYMBOLS

	Consult instructions for use		Tests per kit		Authorized Representative
	For <i>in vitro</i> diagnostic use only		Use by		Do not reuse
	Store between 2~30°C		Lot Number		Catalog#

 Zhejiang Orient Gene Biotech Co.,Ltd
Address: 3787#, East Yangguang Avenue, Dipu Street,
Anji 313300, Huzhou, Zhejiang, China
Tel: +86-572-5226111 Fax: +86-572-5226222
Website: www.orientgene.com

 CMC Medical Devices & Drugs S.L
C/Horacio Lengo Nº 18 CP 29006, Málaga-Spain
Tel: +34951214054 Fax: +34952330100
Email-info@cmcmedicaldevices.com

 GCCD(GDH)-602a

Clostridium difficile Toxin A&B Rapid Test Cassette (Feces)



INTENDED USE

The Clostridium difficile Toxin A&B Rapid Test Cassette (Feces) is a rapid visual immunoassay for the qualitative, presumptive detection of Clostridium difficile Toxin A&B in human fecal specimens, as a screening test and as an aid in the diagnosis of Clostridium difficile infection.

INTRODUCTION

Clostridium difficile (C. difficile), a Gram-positive spore bearing anaerobic bacterium is the major aetiological agent of diarrhoea and colitis associated with antibiotics. C. difficile is the most common cause of health care-associated diarrhoea in developed countries and is a major source of nosocomial morbidity and mortality worldwide.

Disease due to C. difficile develops when the organism is allowed to proliferate in the colon, most commonly after antibiotic use has eliminated competing flora. C. difficile can release two high-molecular-weight toxins, toxin A and toxin B, which are responsible for the clinical manifestations, which range from mild, self-limited watery diarrhoea to fulminant pseudomembranous colitis, toxic megacolon and death.

Clostridium difficile Glutamate Dehydrogenase (GDH) is an enzyme produced in large quantities by all toxigenic and non-toxigenic strains, making it an excellent marker for the organism.

The toxigenic culture (TC) is used as the gold standard technique to determine Clostridium difficile infection. This method consists in culture and isolation of C. difficile from feces, followed by toxin testing of the isolate, a labor-intensive assay to obtain a result.

The Clostridium difficile Toxin A&B Rapid Test Cassette (Feces) is a rapid test to qualitatively detect Clostridium difficile Toxin A&B in human feces in 10 minutes. The test can be performed by untrained or minimally skilled personnel, without cumbersome laboratory equipment.

PRINCIPLE

The Clostridium difficile Toxin A&B Rapid Test Cassette (Feces) is a qualitative lateral flow immunoassay for the detection of Clostridium difficile Toxin A&B in human feces samples. The membrane is pre-coated with monoclonal antibodies against Toxin A on the A test line region and monoclonal antibodies against Toxin B on the B test line region. During testing, the sample reacts with the particle coated with anti-Toxin A and anti-Toxin B antibodies, which were pre-dried on the test strip. The mixture moves upward on the membrane by capillary action. If there is sufficient Clostridium difficile Toxin or Toxin B in the specimen, a colored band will form at the test region of the membrane. The presence of this colored band indicates a positive result, while its absence indicates a negative result. The appearance of a colored band at the control region serves as a procedural control, indicating that the proper volume of specimen has been added and membrane wicking has occurred. If the control line does not appear, the test result is not valid.

PRODUCT CONTENTS

The Clostridium difficile Toxin A&B Rapid Test Cassette (Feces) containing Clostridium difficile Toxin A and Toxin B antibodies coated particles and Toxin A-specific antibodies and Toxin B-specific antibodies coated on the membrane.

MATERIALS SUPPLIED

20 Test cassettes
20 Extraction tubes with buffer
1 Package insert

MATERIAL REQUIRED BUT NOT PROVIDED

Timer

STORAGE AND STABILITY

The kit can be stored at room temperature or refrigerated (2-30°C). The test cassette is stable through the expiration date printed on the sealed pouch. The test cassette must remain in the sealed pouch until use. DO NOT FREEZE. Do not use beyond the expiration date.

WARNINGS AND PRECAUTIONS

1. For professional *in vitro* diagnostic use only.
2. Do not use after the expiration date indicated on the package. Do not use the test if the foil pouch is damaged.
3. Test is for single use only. Do not re-use under any circumstances.

4. Avoid cross-contamination of specimens by using a new extraction tube for each specimen obtained.
5. Read the entire procedure carefully prior to testing.
6. Do not eat, drink or smoke in any area where specimens and kits are handled.
7. Handle all specimens as if they contain infectious agents. Observe established precautions against microbiological hazards throughout the procedure and follow standard procedures for the proper disposal of specimens. Wear protective clothing such as laboratory coats, disposable gloves and eye protection when specimens are assayed.
8. Do not interchange or mix reagents from different lots. Do not mix solution bottle caps.
9. Humidity and temperature can adversely affect results.
10. Do not perform the test in a room with strong air flow, ie. electric fan or strong airconditioning.

SPECIMEN COLLECTION AND PREPARATION

- The Clostridium difficile Toxin A&B Rapid Test Cassette (Feces) is intended for use with human fecal specimens only.
- Stool samples should be collected in clean containers. The samples can be stored in the refrigerator (2-8°C) for 7 days prior to testing. For longer storage, maximum 1 year, the specimen must be kept frozen at -20°C. In this case, the sample will be totally thawed and brought to room temperature before testing. Ensure only the amount needed is thawed because of freezing and defrosting cycles are not recommended. Homogenise stool samples as thoroughly as possible prior to preparation.

SPECIMEN PREPARATION

Consider any materials of human origin as infectious and handle them using standard biosafety procedures.

1. Collect a random sample of feces in a clean, dry receptacle. Best results will be obtained if the assay is performed within 6 hours after collection.
2. Unscrew and remove the dilution tube applicator. Be careful not to spill or spatter solution from the tube. Collect specimens by inserting the applicator stick into at least 5 different sites of the feces to collect approximately 50 mg of feces (equivalent to 1/4 of a pea).
3. **For liquid specimens:** Hold the pipette vertically, aspirate fecal specimens, and then transfer 3 drops (approximately 80 µL) into the specimen collection tube containing the extraction buffer.
4. Replace the stick in the tube and tighten securely.
5. Shake the specimen collection tube vigorously to mix the specimen and the extraction buffer. Specimens prepared in the specimen collection tube may be stored for 6 months at -20°C if not tested within 1 hour after preparation.

TEST PROCEDURE

Bring tests, specimens, reagents and/or controls to room temperature (15-30°C) prior to testing.

1. Remove the test from the sealed pouch and place it on a clean, level surface. Label the device with patient or control identification. For best results, the assay should be performed immediately after opening the foil pouch.
2. Holding the sample collection device upright, carefully break off the tip of collection device.
3. Squeeze 3 drops (~90 µL) of the sample solution in the sample well of the device and start the timer.
4. Wait for the colored line(s) to appear. Read results in 10 minutes. Do not interpret the result after 10 minutes.

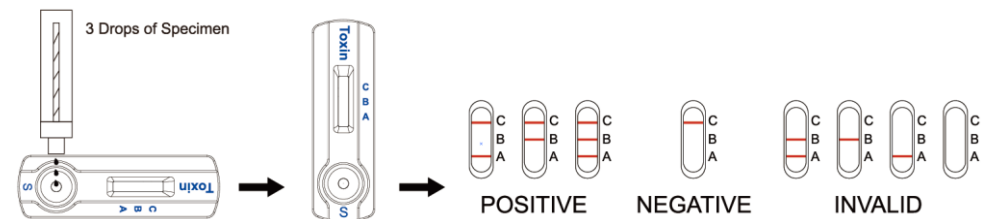

INTERPRETATION OF RESULTS

(Please refer to the illustration above)

1. Positive:

1.1 Toxin A Positive:

The presence of two lines as control line (C) and A test line within the result window indicates a positive result for Toxin A.

1.2 Toxin B Positive:

The presence of two lines as control line (C) and B test line within the result window indicates a positive result for Toxin B.

1.3 Toxin A & B Positive:

The presence of three lines as control line (C), A test line and B test line within the result window indicates a positive result for both Toxin A and Toxin B.

2. Negative:

One colored line appears in the control line region (C). No line appears in the test line region (T).

3. Invalid:

If the control band (C) is not visible within the result window after performing the test, the result is considered invalid. Some causes of invalid results are because of not following the directions correctly or the test may have deteriorated beyond the expiration date. It is recommended that the specimen be re-tested using a new test. If the problem persists, discontinue using the test kit immediately and contact your local distributor.

QUALITY CONTROL

A procedural control is included in the test. A red line appearing in the control region (C) is the internal procedural control. It confirms sufficient specimen volume and correct procedural technique. Control standards are not supplied with this test. However, it is recommended that positive and negative controls are sourced from a local competent authority and tested as a good laboratory practice, to confirm the test procedure and verify the test performance.

LIMITATIONS

1. The Clostridium difficile Toxin A&B Rapid Test Cassette (Feces) will only indicate the presence of parasites in the specimen (qualitative detection) and should be used for the detection of Clostridium difficile Toxin A&B in feces specimens only. Neither the quantitative value nor the rate of increase in antigen concentration can be determined by this test.
2. An excess of sample could cause wrong results (brown bands appear). Dilute the sample with the buffer and repeat the test.
3. The Clostridium difficile Toxin A&B Rapid Test Cassette (Feces) should be used only with samples from human feces. The use of other samples has not been established. The quality of the test depends on the quality of the sample; proper fecal specimens must be obtained.
4. A negative result is not meaningful because of it is possible the antigen concentration in the stool samples is lower than the detection limit value. If the symptoms or situation still persist, a Clostridium difficile determination should be carried out, on a sample from an enrichment culture.
5. As with all diagnostic tests, a definitive clinical diagnosis should not be based on the results of a single test, but should only be made by the physician after all clinical and laboratory findings have been evaluated.

PERFORMANCE CHARACTERISTICS

1. Clinical Sensitivity, Specificity and Accuracy

The Clostridium difficile Toxin A&B Rapid Test Cassette (Feces) has been evaluated with specimens obtained from patients. ELISA method was used as the reference method. The results show that the Clostridium difficile Toxin A&B Rapid Test Cassette (Feces) has a high overall relative accuracy.

Table 1: The Clostridium difficile Toxin A Rapid Test vs ELISA

Method	ELISA		Total Results	
	Results	Positive		Negative
Clostridium difficile Toxin A&B Rapid Test Cassette	Positive	43	1	44
	Negative	0	69	69
Total Results		43	70	113

Relative Sensitivity: 100%

Relative Specificity: 98.6%

Accuracy: 99.1%

Table 2: The Clostridium difficile Toxin B Rapid Test vs ELISA

Method	ELISA		Total Results	
	Results	Positive		Negative
Clostridium difficile Toxin A&B Rapid Test Cassette	Positive	36	1	37
	Negative	0	76	76
Total Results		36	77	113

Relative Sensitivity: 100%

Relative Specificity: 98.6%

Accuracy: 99.1%

2. Analytical Sensitivity

The Clostridium difficile Toxin A&B Rapid Test Cassette (Feces) was determined by testing serial dilutions of recombinant antigen. Detection limit values of Clostridium difficile Toxin A&B are 2 ng/mL for Toxin A and 1 ng/mL for Toxin B.

3. Cross-Reactivity









Cross-reactivity to samples positive for the following pathogens was tested and found to be negative:

<i>Campylobacter coli</i>	<i>Salmonella enteritidis</i>	<i>Shigella dysenteriae</i>
<i>Campylobacter jejuni</i>	<i>Salmonella paratyphi</i>	<i>Shigella flexneri</i>
<i>E. Coli O157: H7</i>	<i>Salmonella typhi</i>	<i>Shigella sonnei</i>
<i>H. pylori</i>	<i>Salmonella typhimurium</i>	<i>Staphylococcus aureus</i>
<i>Listeria monocytogenes</i>	<i>Shigella boydii</i>	<i>Yersinia enterocolitica</i>

REFERENCE

1. Knoop, F.C. et al.: Clostridium difficile: Clinical disease and diagnosis. Clin. Microbiol. Rev. (1993); 6: 251-265.
2. Kelly, C.P. et al.: Clostridium difficile Colitis. New Engl. J. Med. (1994); 330: 257-262.
3. Sullivan, N.M. et al.: Purification and characterization of toxins A and B of Clostridium difficile. Infect. Immun. (1982); 35: 1032-1040.
4. McDonald, L.C. et al.: An epidemic, toxin gene-variant strain of Clostridium difficile. N. Engl. J. Med. (2005); 353: 23.
5. Loo, V.G. et al.: A predominantly clonal multi-institutional outbreak of Clostridium difficile-associated diarrhea with high morbidity and mortality. N. Engl. J. Med. (2005); 353:23
6. Bartlett, J.G., Gerding, D.N.: Clinical recognition and diagnosis of Clostridium difficile infection. CID (2008); 46 (Suppl. 1): 12-18.

INDEX OF SYMBOLS

	Consult instructions for use		Tests per kit		Authorized Representative
	For <i>in vitro</i> diagnostic use only		Use by		Do not reuse
	Store between 2~30°C		Lot Number		Catalog#

 Zhejiang Orient Gene Biotech Co.,Ltd
Address: 3787#, East Yangguang Avenue, Dipu Street,
Anji 313300, Huzhou, Zhejiang, China
Tel: +86-572-5226111 Fax: +86-572-5226222
Website: www.orientgene.com

 CMC Medical Devices & Drugs S.L
C/Horacio Lengo N° 18 CP 29006, Málaga-Spain
Tel: +34951214054 Fax: +34952330100
Email-info@cmcmedicaldevices.com

 GCCD(Toxin A&B)-602a

Revision Date: 2022-02-21
B22718-01



SYNTESYS S.A.S. DI RINALDO R. & C.

VIA G. GALILEI, 10/3
35037 Z.I. SELVE DI TEOLO (PD)
TEL. +39 049 9903866 R.A. FAX +39 049 9903867
COD. FISCALE P.IVA N.REG.IMP. PADOVA 03573950288
E-MAIL INFO@SYNTESYS.IT · WEB WWW.SYNTESYS.IT

DICHIARAZIONE DI CONFORMITA'
Conformity declaration



Il sottoscritto, Rinaldo Ruggero legale rappresentante della ditta:
The undersigned, Rinaldo Ruggero legal representative of the company:

produttore/manufacturer

SYNTESYS S.a.s. di Rinaldo R. & C.

indirizzo/address

Via G. Galilei, 10/3 35037 Zona Industriale SELVE DI TEOLO (PADOVA) ITALY

ò rappresentante il mandatario autorizzato entro la Unione Europea
or representing the authorized mandatary within the European Community

Mandatario autorizzato/authorized mandatary

indirizzo/address

Dichiara sotto la propria responsabilità che il prodotto/*declares under his own responsibility that the product:*

Denominazione/Description

Padella per ammalati, urinali uomo e donna, speculum vaginali, tamponcini cotonati, tamponi sterili in provetta, tamponi sterili con terreno Amies e Stuart in provetta/ *Bed pan, Urinal's man and woman, Vaginal speculum, Cotton swab, Sterile swab in test tube, Sterile swab with medium Amies or Stuart in test tube*

Materiale/Material

Polipropilene, Polietilene, Legno/ *Polypropylene, Polyethylene, Wood*

È conforme alle disposizioni della direttiva 93/42/CE e smi, concernente i dispositivi medici ed al Decreto Legislativo di recepimento con D.lgs. del 24/02/1997 n° 46/97 e soddisfa a tutti i requisiti specificati.

Il dispositivo è stato classificato appartenente alla classe I° secondo i criteri stabiliti in base a quanto previsto dall'Art. 9 ed allegato IX della direttiva sopra citata /*It meets the EC Directive 93/42 about Medical Device, specifications established by the Italian law n 46/97, dated 24th February 1997. The device was classified as belonging to the 1st class, according to the specifications of the established by the art.9, IX enclosure of the above mentioned directive.*

Dichiara inoltre che la documentazione tecnica di supporto alla presente dichiarazione di conformità è conservata presso gli uffici dell'azienda e sarà posta alla disposizione di chi la richiede/ *declares that all technical documents attached to this conformity statment are filed in our company and can be consulted by any authorized body on demand.*

Data 07.01.2016
Issued on January 7th 2016

SYNTESYS S.A.S.
Il legale rappresentante
Rinaldo Ruggero



SYNTESYS



SYNTESYS S.A.S. DI RINALDO R. & C.
VIA G. GALILEI, 10/3
35037 Z.I. SELVE DI TEOLO (PD)

TEL. +39 049 9903866 R.A. FAX +39 049 9903867

COD. FISCALE P.IVA N.REG.IMP. PADOVA 03573950288
E-MAIL INFO@SYNTESYS.IT - WEB WWW.SYNTESYS.IT

DICHIARAZIONE DI CONFORMITA'
Conformity declaration



Il sottoscritto, Rinaldo Ruggero legale rappresentante della ditta:
The undersigned, Rinaldo Ruggero legal representative of the company:

produttore/manufacturer

SYNTESYS S.a.s. di Rinaldo Ruggero & C.
indirizzo/address

Via G. Galilei, 10/3 35037 Zona Industriale SELVE DI TEOLO (PADOVA) ITALY

o rappresentante il mandatario autorizzato entro la Unione Europea or representing the authorized mandatary within the European Community

Mandatario autorizzato/authorized mandatary

indirizzo/address

Dichiara sotto la propria responsabilità che il prodotto/*declares under his own responsibility that the product:*

Denominazione degli
articoli
prodotti/*Description of
Manufacturer*

Contenitori per urina, contenitori per feci,
contenitori universali, Pipette Pasteur, Piastre di
Petri, Anse Sterili per batteriologia, Aste a "L",
Puntali Eppendorf gialli e blue, cuvette per
spettrofotometro, tazzine per campionamento siero,
bacchette per distacco ed estrazione del coagulo,
pinzette in polistirolo monouso, provette monouso in
plastica, tappi alettati per provette diam. 12 mm e
16mm, provette con granuli ed acceleratore, provette
sottovuoto per prelievo, Sistema SEDIPLAST,
Microprovette, Portavetrini, Vetrini precolorati,
Portaprovette, supporti per microprovette, bottiglie
per raccolta urine.

*Urine container, faeces container, universal
container, Pasteur pipette, Petri dishes, Sterile
loops, Sterile loops open "L", Eppendorf tips yellow
and blue, cuvettes for spectrophotometer, samples
cups, Rod to detach clot, disposable forceps,
Disposable plastic tubes, winged stoppers for tubes
diam. 12mm & 16mm, Test tube with granules and clot
activator, vacuum test tube, SEDIPLAST system,
micro test tubes, Slides Mailer, "TESTSIMPLETS" slide,
rack for test tubes, rack for micro test tubes,
Bottles for urine collection.*



SYNTESYS



ISO9001:2008
Cert. N. 6574/0

SYNTESYS S.A.S. DI RINALDO R. & C.
VIA G. GALILEI, 10/3
35037 Z.I. SELVE DI TEOLO (PD)
TEL. +39 049 9903866 R.A. FAX +39 049 9903867
COD.FISCALE P.IVA N.REG.IMP. PADOVA 03573950288
E-MAIL INFO@SYNTESYS.IT - WEB WWW.SYNTESYS.IT

Materiale/ Material

**Polipropilene, Polistirolo, Polietilene e
Polimetilmetacrilato**

***Polypropylene, Polystyrene, Polyethylene and
Polymethylmetacrylate***

È conforme alle disposizioni della direttiva 98/79/CE concernente i dispositivi medici diagnostici in vitro e recepito in Italia con D.L. del 08/09/2000 n° 332 allegato 1 (requisiti essenziali) ed è fabbricato in accordo ai requisiti di cui all'Allegato III della sopra citata direttiva / *It meets the CE Directive 98/79 CE about in vitro diagnostic device specifications established by the Italian law n. 332, dated 8th September 2000. The device is made according to the specifications of the III attached of the above-mentioned directive.*

Dichiara inoltre che la documentazione tecnica di supporto alla presente dichiarazione di conformità è conservata presso gli uffici dell'azienda e sarà posta alla disposizione di chi la richiede/declares that all technical documents attached to this conformity statement are filed in our company and can be consulted by any authorized body on demand.

Data 07/01/2016
Issued on January 7th 2016

SYNTESYS S.a.s.
Il legale rappresentante
Rinaldo Ruggero

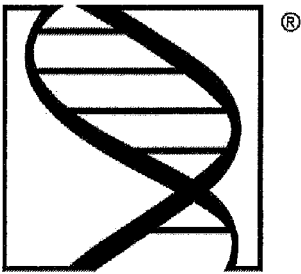

SYNTESSYS



Cert. N.7111/2



Cert. N.6574/2



SYNTESSYS S.R.L. UNIPERSONALE

VIA G. GALILEI, 10/3 - 35037 Z.I. SELVE DI TEOLO (PD)
TEL. +39 049 9903866 R.A. FAX +39 049 9903867
C.F./P.I./N.REG.IMP. PADOVA 03573950288
REA PD-320123 - CAP.SOC. 20.700,00€
E-MAIL INFO@SYNTESSYS.IT - WEB WWW.SYNTESSYS.IT
PEC POSTA@PEC.SYNTESSYS.IT

AUTHORIZATION LETTER

We, **Syntesys S.R.L.** having a registered office at Via G. Galilei 10/3, 35037 Selve di Teolo - PD - Italy, assign **Sanmedico SRL** having a registered office at A.Corobceanu str., apt. 9, Chişinău MD-2012, Moldova, as authorized representative.

We declare that the company mentioned above is authorized to register, notify, renew or modify the registration of medical devices on the territory of the Republic of Moldova.

This letter is valid till 31.12.2021

Teolo, 05.01.2021

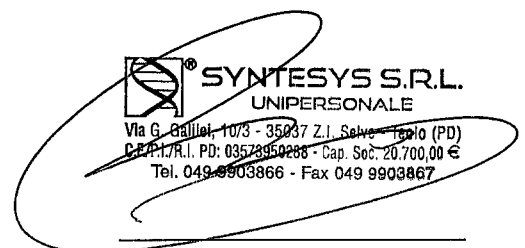

 **SYNTESSYS S.R.L.**
UNIPERSONALE
Via G. Galilei, 10/3 - 35037 Z.I. Selve di Teolo (PD)
C.F./P.I./R.I. PD: 03573950288 - Cap. Soc. 20.700,00 €
Tel. 049.9903866 - Fax 049 9903867

Rinaldo Ruggero
CEO and Legal Representative
SYNTESSYS S.R.L.

Certificate

CISQ/ICIM S.P.A. has issued an IQNet recognized certificate that the organization:

SYNTESYS S.R.L.

Head Office and Operative Unit

Via G. Galilei, 10/1-2-3 - Zona Industriale - I-35037 Selve di Teolo (PD)

Operative Units

Via G. Galilei, 16/1 - Zona Industriale - I-35037 Selve di Teolo (PD)

Via San Benedetto, 48/A - Zona Industriale - I-35037 Selve di Teolo (PD)

Via G. Galilei, 3 - Zona Industriale - I-35037 Selve di Teolo (PD)

has implemented and maintains a/an

Quality Management System

for the following scope:

Trading of products for laboratory analysis. Manufacturing of products for laboratory analysis and sanitary products. Design and production management of sterile swabs for the collection and the preservation of biological samples, also for surgical application, with or without transport medium.

which fulfils the requirements of the following standard:

ISO 9001:2015

Issued on: **2022-06-05**

First issued on: **2013-06-05**

Expires on: **2025-06-04**

This attestation is directly linked to the IQNet Partner's original certificate and shall not be used as a stand-alone document.

Registration Number: **IT-83562**



Alex Stoichitoiu
President of IQNET



Mario Romersi
President of CISQ



This attestation is directly linked to the IQNET Member's original certificate and shall not be used as a stand-alone document.

IQNET Members*:

AENOR Spain **AFNOR Certification** France **APCER** Portugal **CCC** Cyprus **CISQ** Italy **CQC** China **CQM** China **CQS** Czech Republic
Cro Cert Croatia **DQS Holding GmbH** Germany **EAGLE Certification Group** USA **FCAV** Brazil **FONDONORMA** Venezuela **ICONTEC**
Colombia **ICS** Bosnia and Herzegovina **Inspecta Sertifointi Oy** Finland **INTECO** Costa Rica **IRAM** Argentina **JQA** Japan **KFQ** Korea
LSQA Uruguay **MIRTEC** Greece **MSZT** Hungary **Nemko AS** Norway **NSAI** Ireland **NYCE-SIGE** México **PCBC** Poland **Quality Austria**
Austria **SII** Israel **SIQ** Slovenia **SIRIM QAS International** Malaysia **SQS** Switzerland **SRAC** Romania **TSE** Turkey **YUQS** Serbia

* The list of IQNET Members is valid at the time of issue of this certificate. Updated information is available under www.iqnet-certification.com

Certificate

CISQ/ICIM S.P.A. has issued an IQNet recognized certificate that the organization:

SYNTESYS S.R.L.

Head Office and Operative Unit

Via G. Galilei, 10/1-2-3 - Zona Industriale - I-35037 Selve di Teolo (PD)

Operative Units

Via G. Galilei, 16/1 - Zona Industriale - I-35037 Selve di Teolo (PD)

Via San Benedetto, 48/A - Zona Industriale - I-35037 Selve di Teolo (PD)

Via G. Galilei, 3 - Zona Industriale - I-35037 Selve di Teolo (PD)

has implemented and maintains a/an

Quality Management System

for the following scope:

Trading of products for laboratory analysis. Manufacturing of products for laboratory analysis and sanitary products. Design and production management of sterile swabs for the collection and the preservation of biological samples, also for surgical application, with or without transport medium.

which fulfils the requirements of the following standard:

ISO 13485:2016

Issued on: **2022-06-05**

First issued on: **2014-06-21**

Expires on: **2025-06-04**

This attestation is directly linked to the IQNet Partner's original certificate and shall not be used as a stand-alone document.

Registration Number: **IT-93779**



Alex Stoichitoiu
President of IQNET



Mario Romersi
President of CISQ



This attestation is directly linked to the IQNET Member's original certificate and shall not be used as a stand-alone document.

IQNET Members*:

AENOR Spain **AFNOR Certification** France **APCER** Portugal **CCC** Cyprus **CISQ** Italy **CQC** China **CQM** China **CQS** Czech Republic
Cro Cert Croatia **DQS Holding GmbH** Germany **EAGLE Certification Group** USA **FCAV** Brazil **FONDONORMA** Venezuela **ICONTEC**
Colombia **ICS** Bosnia and Herzegovina **Inspecta Sertifointi Oy** Finland **INTECO** Costa Rica **IRAM** Argentina **JQA** Japan **KFQ** Korea
LSQA Uruguay **MIRTEC** Greece **MSZT** Hungary **Nemko AS** Norway **NSAI** Ireland **NYCE-SIGE** México **PCBC** Poland **Quality Austria**
Austria **SII** Israel **SIQ** Slovenia **SIRIM QAS International** Malaysia **SQS** Switzerland **SRAC** Romania **TSE** Turkey **YUQS** Serbia

* The list of IQNET Members is valid at the time of issue of this certificate. Updated information is available under www.iqnet-certification.com

Certificate of Registration

QUALITY MANAGEMENT SYSTEM - ISO 9001:2015

This is to certify that:

TCS Biosciences Limited
Botolph Claydon
Buckingham
MK18 2LR
United Kingdom

Holds Certificate Number:

FS 28907

and operates a Quality Management System which complies with the requirements of ISO 9001:2015 for the following scope:

The procurement, manufacture, design, development and sale of a range of diagnostic products for clinical, pharmaceutical, food and environmental laboratory testing.

For and on behalf of BSI:

Matt Page, Managing Director Assurance - UK & Ireland

Original Registration Date: 1994-08-11

Latest Revision Date: 2022-01-14

Effective Date: 2022-01-27

Expiry Date: 2025-01-26

Page: 1 of 1



...making excellence a habit.™

Certificate of Registration

ENVIRONMENTAL MANAGEMENT SYSTEM - ISO 14001:2015

This is to certify that:

TCS Biosciences Ltd
Botolph Claydon
Buckingham
MK18 2LR
United Kingdom

Holds Certificate Number:

EMS 590359

and operates an Environmental Management System which complies with the requirements of ISO 14001:2015 for the following scope:

The procurement, manufacture, design, development and sale of a range of diagnostic products for clinical, pharmaceutical, food and environmental laboratory testing.

For and on behalf of BSI:

Matt Page, Managing Director Assurance - UK & Ireland

Original Registration Date: 2013-06-10

Latest Revision Date: 2022-01-14

Effective Date: 2022-01-27

Expiry Date: 2025-01-26

Page: 1 of 1



...making excellence a habit.™

Certificate of Registration

QUALITY MANAGEMENT SYSTEM - ISO 9001:2015

This is to certify that:

TCS Biosciences Limited
Botolph Claydon
Buckingham
MK18 2LR
United Kingdom

Holds Certificate Number:

FS 28907

and operates a Quality Management System which complies with the requirements of ISO 9001:2015 for the following scope:

The procurement, manufacture, design, development and sale of a range of diagnostic products for clinical, pharmaceutical, food and environmental laboratory testing.

For and on behalf of BSI:

Matt Page, Managing Director Assurance - UK & Ireland

Original Registration Date: 1994-08-11

Latest Revision Date: 2022-01-14

Effective Date: 2022-01-27

Expiry Date: 2025-01-26

Page: 1 of 1



...making excellence a habit.™

Certificate of Registration

ENVIRONMENTAL MANAGEMENT SYSTEM - ISO 14001:2015

This is to certify that:

TCS Biosciences Ltd
Botolph Claydon
Buckingham
MK18 2LR
United Kingdom

Holds Certificate Number:

EMS 590359

and operates an Environmental Management System which complies with the requirements of ISO 14001:2015 for the following scope:

The procurement, manufacture, design, development and sale of a range of diagnostic products for clinical, pharmaceutical, food and environmental laboratory testing.

For and on behalf of BSI:

Matt Page, Managing Director Assurance - UK & Ireland

Original Registration Date: 2013-06-10

Latest Revision Date: 2022-01-14

Effective Date: 2022-01-27

Expiry Date: 2025-01-26

Page: 1 of 1



...making excellence a habit.™

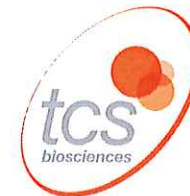

SELF DECLARATION OF CONFORMITY

We declare under our sole responsibility in accordance with MHRA account number 0000009546 that the following CE marked products:

GMDN Term	GMDN Code	TCS product code and description
General microbial isolate identification control IVD	63319	Selectrol – All MM codes

conform to the relevant provisions of the In-vitro Diagnostic Medical Devices Directive 98/79/EC and The Medical Devices Regulations 2002 (SI 2002 No.618) and The Medical Devices (Amendment) Regulations 2003 (SI 2003 No.1697) for in-vitro diagnostic medical devices.

This declaration is made on the basis of meeting the requirements of Annexes I and III of the In-Vitro Diagnostic Medical Devices Directive 98/79/EC and continued maintenance of an approved Quality Management System meeting the requirements of ISO 9001, as certified by BSI, certificate number FS 28907.

Signed by: Sue Brown

Date: September 2020

Name: Sue Brown
Position: Quality Assurance & Regulatory Affairs Manager

Signed by: Lynda Preston

Date: September 2020

Name: Lynda Preston
Position: Managing Director

Manufacturer
TCS Biosciences Ltd
Botolph Claydon
Buckingham MK18 2LR
UK

EC Authorised Representative
TCS Biosciences Europe B.V.
Provincialeweg 6
9864 PD Kornhorn
The Netherlands

STATEMENT

We, TCS Biosciences Ltd., having a registered office at Botolph Claydon, Buckingham, MK 18 2LR, England assign Sanmedico SRL having a registered office at str. A. Corobceanu 7A, apt. 9, Chişinău MD-2012, Moldova, as Authorized Representative in correspondence with the conditions of directive 98/79/EEC.

We declare that the company mentioned above is authorized to register, notify, renew or modify the registration of medical devices on the territory of the Republic of Moldova.

Date : 21 August 2018

Signature: *Jul Brown*

accuracy and quality as a science

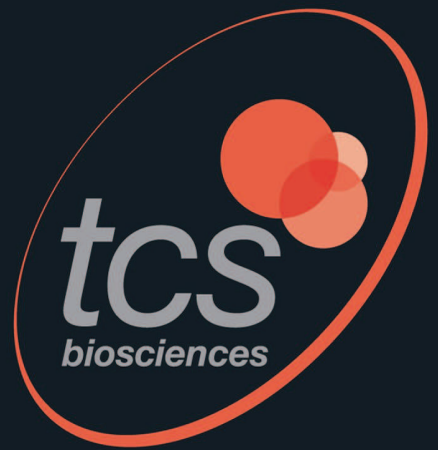

Selectrol®
Technical
Guide



Selectrol® : Manufactured under licence from Public Health England Culture Collections

SELECTROL® - FREEZE-DRIED ORGANISMS IN A DISC

Quality control of microbial characterisation tests, culture media and antimicrobial susceptibility determinations is best accomplished by the use of microorganisms with well-documented and stable phenotypic and genotypic characteristics.

Bacterial and fungal strains have been selected and recommended by expert bodies, such as **EUCAST**, **CLSI** and the European Pharmacopoeia, on the basis of their suitability for monitoring test performance and ensuring the validity of results for testing used in clinical, food, pharmaceutical, water and veterinary laboratories.

Products derived from the cultures in the collections should be manufactured using the minimum number of sub-cultures, to minimise the possibility of alterations to the phenotype due to mutations. See also page 14.

Selectrol strains are manufactured exclusively from Public Health England Culture Collections (NCTC® and NCPF®) and are first generation subcultures, unlike many products on the market which are 2nd, 3rd or 4th generation subcultures. They are preserved by long-term storage as freeze-dried cells in order to minimise any alterations to the phenotype caused by mutations.

Passages

A Selectrol® disc is a first generation subculture from a **master culture** sourced from Public Health England Culture Collections, and is designed to be used to obtain **working stock** cultures for use in testing. It is generally accepted that no more than a total of five passages should be made from the **master culture**, in order to avoid genetic drift and mutant selection. Therefore, no more than four passages (fresh cultures) from the **working stock** should be made.

Shelf life

For most strains, Selectrol® discs are guaranteed to contain at least 10⁶ organisms at the time of purchase; this number is sufficient to ensure that when the discs are used and stored as directed there will be viable organisms cultivable up to the stated end of the shelf life, which is usually 9 months from the time the vial is first opened.

Quality Control

Selectrol® batches are tested in our UKAS accredited testing laboratory number 2496. A test report for each batch of Selectrol® can be accessed via our website. The reporting of Selectrol® test results via the website comes under our UKAS accreditation.

Selectrol® cultures are rigorously tested to confirm identity, to confirm the possession of essential phenotypic characteristics and to exclude contamination with other organisms. Photographic evidence of the test results is retained for each batch, along with retained appropriately stored samples.



Glossary

AMRHAI: Antimicrobial Resistance and Healthcare Associated Infections reference unit

ATCC®: American Type Culture Collection. ATCC® strains are listed for reference only. ATCC® is a registered trademark of the American Type Culture Collection.

BSAC: British Society for Antimicrobial Chemotherapy - Now superseded by EUCAST

CLSI: Clinical Laboratory Standards Institute. (USA)

CPE: Carbapenemase Producing Enterobacteriaceae

CRE: Carbapenem Resistant Enterobacteriaceae

Culture collection: Cultures of fully characterised organisms maintained in such a way as to minimise sub-culturing. See page 14.

ESBL: Extended Spectrum Beta-Lactamase-producing organism.

EUCAST: European Committee on Antimicrobial Susceptibility Testing.

First generation derivative: A single passage from a master culture, for example a Selectrol® disc.

Master culture: Culture derived from a reference culture vial.

NCPF®: National Collection of Pathogenic Fungi. NCPF® is a registered trademark of Public Health England.

NCTC®: National Collection of Type Cultures. NCTC® is a registered trademark of Public Health England.

Passage: An equivalent term for a subculture.

PHE: Public Health England.

Reference cultures: Quality control strains selected on the basis of their phenotypic biochemical and antimicrobial susceptibility characteristics to be used as controls in microbiological testing. These are obtained as freeze-dried vials from culture collections.

Stock culture: Cultures derived from a Selectrol® disc, which can be stored for up to a week, usually on agar slants.

Working cultures: Stock cultures further sub-cultured to provide 18-24 hour growth for use in testing.

WDCM: World Data Centre for Microorganisms

WFCC: World Federation for Culture Collections

SIGNIFICANT PROPERTIES AND USES OF SELECTROL® ORGANISMS

Aspergillus brasiliensis (formerly *Aspergillus niger*):

MM94 – NCPF® 2275 / ATCC® 16404 / WDCM 00053 – used in pharmaceutical industry for testing media and preservatives. Colonies are initially white or yellowish and on the reverse greyish or greenish-yellow. Sporing heads on the colony surface are initially pale, becoming dark brown to black. Sporulation may be inhibited in sealed plates.

Bacillus cereus:

MM21 – NCTC® 10320 / ATCC® 9634 / WDCM 00001 (recently renamed *Bacillus toyonensis*) – ISO 11133 recommended media and ID test control organism.

MM86 – NCTC® 7464 / ATCC® 10876 – **PHE** recommended media and ID test control organism.

Bacillus subtilis (*Bacillus subtilis* subsp. *spizizenii*):

MM29 – NCTC® 10400 / ATCC® 6633 / WDCM 00003 – used in antibiotic assays (fully sensitive), **PHE** recommended media and ID test control organism.



Bacteroides fragilis:

MM44 – NCTC® 9343 / ATCC® 25285 – type strain, **PHE** recommended strain for media and sensitivity test control.

Campylobacter jejuni (*Campylobacter jejuni* subsp. *jejuni*):

MM82 – NCTC® 11322 / ATCC® 29428 / WDCM 00156 – **PHE** recommended strain for media control.

MM36 – NCTC® 11351 / ATCC® 33560 – **EUCAST** recommended strain for susceptibility testing.

Candida albicans:

MM28 – NCPF® 3255 / ATCC® 2091 / WDCM 00055 – sensitivity control / industrial use.

MM42 – NCPF® 3179 / ATCC® 10231 / WDCM 00054 – pharmaceutical / media testing / **PHE** recommended strain for media control.

CRE ≡ ‘Carbapenem Resistant Enterobacteriaceae’ / CPE ≡ ‘Carbapenemase Producing Enterobacteriaceae’

There are 5 carbapenemases which are currently a significant problem in the UK – KPC, OXA-48, IMP, NDM and VIM – and PHE recommend that all clinically-significant Gram-negative bacteria should be routinely screened for carbapenemase production, using a recommended carbapenem² such as ertapenem or meropenem. Resistant isolates may be investigated further to determine which resistance mechanism is involved using the Modified Hodge Test, MALDI-TOF, PCR or a reference laboratory.

MM55 *Klebsiella pneumoniae* – NCTC® 13440 – produces a Class B VIM-1 Carbapenemase.

MM56 *Klebsiella pneumoniae* – NCTC® 13443 – produces a Class B NDM-1 Carbapenemase.

MM58 *Klebsiella pneumoniae* – NCTC® 13438 – produces a Class A KPC-3 Carbapenemase.

MM59 *Klebsiella pneumoniae* – NCTC® 13442 – produces a Class D OXA-48 Carbapenemase.

MM57 *Escherichia coli* – NCTC® 13476 – produces a Class B IMP Carbapenemase.

MM33 *Escherichia coli* – NCTC® 10418 / ATCC® 10536 – recommended by **PHE** as a negative control for CRE testing.

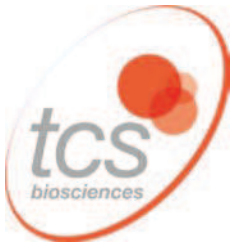

Citrobacter freundii:

MM27 – NCTC® 9750 / ATCC® 8090 – type strain.

Clostridium perfringens:

MM45 – NCTC® 8237 / ATCC® 13124 / WDCM 00007 – type strain. **PHE** recommended strain for food testing (Tryptose Sulphite Cycloserine agar – lactose and gelatin positive) and sensitivity test control. *Clostridium perfringens* is listed in Schedule 5 of the Anti-terrorism, Crime and Security Act 2001, and should be securely stored in accordance with the guidelines of the Act. However, MM45 is a type A strain, which does not produce the lethal epsilon toxin of potential interest to bioterrorists.

Clostridium sporogenes:

MM31 – NCTC® 532 / ATCC® 19404 / WDCM 00008 – used for media control. **PHE** recommended strain for media QC (lactose gelatin medium for ID of *C. perfringens* lactose negative and gelatin positive).

Enterobacter aerogenes:

MM26 – NCTC® 10006 / ATCC® 13048 / WDCM 00175 – type strain; used in water, paint and adhesive testing.

Enterobacter cloacae:

MM01 – NCTC® 13380 / ATCC® 23355 / WDCM 00082 – disinfectant control, media testing.

MM51 – NCTC® 13406 – **PHE** recommended strain for QC of AmpC (de-repressed) detection.

Enterococcus faecalis:

MM52 – NCTC® 13379 / ATCC® 51299 / WDCM 00085 – is vancomycin resistant (low-level VanB mediated) and also shows high-level resistance to aminoglycosides. It is used to confirm methodologies used to detect these resistances are working correctly. Lancefield group D.

MM17 – NCTC® 775 / ATCC® 19433 / WDCM 00009 – used in water industry and QC. **PHE** recommended strain for media control. Fully sensitive. Lancefield group D.

MM18 – NCTC® 12697 / ATCC® 29212 / WDCM 00087 – is fully sensitive to vancomycin and gentamicin. **PHE** recommended positive control strain for aesculin test. **CLSI, EUCAST** recommended media control for sulpha / trimethoprim testing and general susceptibility testing control. Lancefield group D.





Enterococcus hirae:

MM35 – NCTC® 13383 / ATCC® 10541 / WDCM 00011 – disinfectant control. Used in microbiological assays. Colonies are alpha-haemolytic on sheep blood agar.

***Escherichia coli* strains:**

MM02 – NCTC® 12241 / ATCC® 25922 / WDCM 00013 – **EUCAST, CLSI, PHE** recommended control strain for susceptibility testing (fully sensitive). Exhibits 2 colony types – the most prevalent type is slightly irregular, smooth and translucent. The secondary type appears more opaque. It is preferable to maintain cultures on agar as passage in broth can result in a change in MIC levels.

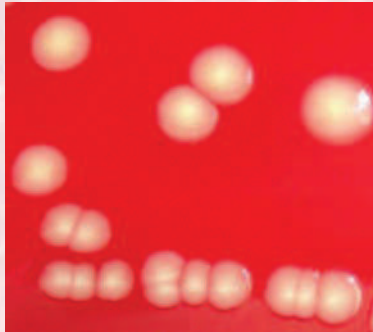

MM57 – NCTC® 13476 – CRE testing control; produces a Class B IMP Carbapenemase.

MM33 – NCTC® 10418 / ATCC® 10536 – (**PHE** recommended alternative to NCTC 12241) fully sensitive control strain. **PHE** recommended positive control for indole test, ONPG test, negative control for oxidase test, **PHE** recommended negative control for CRE and ESBL testing.

MM24 – NCTC® 11954 / ATCC® 35218 – beta-lactamase positive strain. **CLSI** recommended strain for susceptibility testing ONLY for penicillin / beta-lactamase inhibitor combinations. Sensitive to amoxicillin / clavulanic acid.

MM75 – NCTC® 9001 / ATCC® 11775 / WDCM 00090 – used in water / chemical industry. **PHE** recommended strain for media QC.

MM93 – NCTC® 12900 / ATCC® 700728 / WDCM 00014 – O157 strain (non-toxigenic). **PHE** recommended strain for media QC.

MM63 – NCTC® 11560 – beta-lactamase positive strain.

MM38 – NCTC® 12923 / ATCC® 8739 / WDCM 00012 – used in pharmaceutical / water industry. Three colony types: A) Entire, glistening, smooth and translucent. B) Entire, glistening smooth and opaque. C) Irregular, rough and translucent. The rough colonies appear after 48 hours incubation.

MM34 – NCTC® 13846 – Possesses the plasmid-mediated *mcr-1* colistin resistance mechanism gene and is recommended by **PHE** and **EUCAST** as a control for tests to detect this increasingly prevalent resistance, in conjunction with NCTC® 12241 / ATCC® 25922 (Selectrol strain MM02) as a negative control.

***Haemophilus influenzae* strains:**

MM81 - NCTC® 12699 / ATCC® 49247 – is a ‘BLNAR’ strain – (beta-lactamase non-producing ampicillin / amoxycillin resistant). These strains are important clinically because the susceptibility results obtained using conventional testing procedures maybe misleading in the case cephalosporins. **PHE**, **CLSI** recommended QC strain for susceptibility testing media.

MM98 – NCTC® 11931 – a fully sensitive strain. **PHE** recommended strain for porphyrin synthesis test, chocolate agar control.

MM100 – NCTC® 8468 / ATCC® 9334 / CCUG 23946 – another fully sensitive strain, which reportedly gives results which are easier to interpret when Mueller-Hinton medium is used in preference to Iso-Sensitest medium. MIC for amoxycillin is 0.5 mg/l.

MM37 – NCTC® 12975 / ATCC® 49766 – recommended by **EUCAST**.

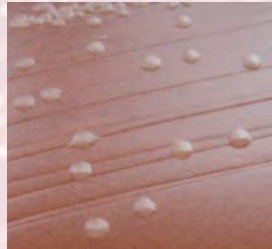

***Klebsiella* strains:**

MM04 *Klebsiella pneumoniae* – NCTC® 9633 / ATCC® 13883 / WDCM 00097 – type strain. Two colony types may be seen. The predominant type is entire and opaque. The secondary type is slightly smaller and translucent.

MM83 *Klebsiella pneumoniae* – NCTC® 13368 / ATCC® 700603 – ESBL-producing strain used as control for ESBL testing. There are two colony types.

MM55 *Klebsiella pneumoniae* – NCTC® 13440 – CRE testing control; produces a Class B VIM-1 Carbapenemase.

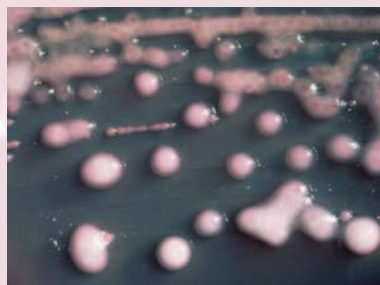

MM56 *Klebsiella pneumoniae* – NCTC® 13443 – CRE testing control; produces a Class B NDM-1 Carbapenemase.

MM58 *Klebsiella pneumoniae* – NCTC® 13438 – CRE testing control; produces a Class A KPC-3 Carbapenemase.

MM59 *Klebsiella pneumoniae* – NCTC® 13442 – CRE testing control; produces a Class D OXA-48 Carbapenemase.

MM88 *Klebsiella aerogenes* (*Raoultella planticola*) – NCTC® 9528 – used in water / pharmaceutical industry. **PHE** recommended negative control for Tryptone Bile X-Glucuronide agar and Yeast Extract agar.



Lactobacillus brevis:

MM76 – NCTC® 13386 / ATCC® 8287 – used in food industry.

Legionella pneumophila serogroup 1:

MM08 – NCTC® 11192 / ATCC® 33152 / WDCM 00107 – derived from strain isolated from first recognised outbreak of legionellosis in Philadelphia at the Legionnaires' Convention 1976

Listeria innocua:

MM92 – NCTC® 11288 / ATCC® 33090 / WDCM 00017 – type strain. Non-pathogenic.

Listeria monocytogenes:

MM87 – NCTC® 11994 / WDCM 00019 – type strain, **PHE** recommended positive control strain for Listeria detection in food. Serotype 4b, most common serovar isolated from human infections.

MM48 – NCTC® 7973 / ATCC® 35152 / WDCM 00109 – produces 2 phenotypes, one is beta-haemolytic and virulent, the other non-haemolytic and non-virulent. Serovar 1/2a.

MM77 – NCTC® 13372 / ATCC® 7644 – used in food microbiology Q.C. Colonies exhibit beta-haemolysis on sheep blood agar.

Neisseria gonorrhoeae:

MM96 – NCTC® 12700 / ATCC® 49226 – has low-level, but clinically relevant, resistance to penicillin – MIC of penicillin is 0.5 mg/l. **PHE** recommended control for susceptibility testing – methodology assesses the ability of testing to detect resistance rather than sensitivity; this strain has low-level, but clinically relevant, resistance to penicillin – MIC of penicillin is 0.5 mg/l. Some variation in size and texture of colonies may be observed. Increased CO₂ is helpful in growth.

MM05 – NCTC® 8375 / ATCC® 19424 – is fully sensitive – MIC of penicillin is 0.06 mg/l. **PHE** recommended strain for media QC.

Proteus mirabilis:

MM43 – NCTC® 13376 / ATCC® 14153 – pharmaceutical / disinfectant / media control.

MM68 – NCTC® 10975 – media control. **PHE** recommended control for motility test.



Proteus vulgaris:

MM09 – NCTC® 4175 / ATCC® 13315 – was the type strain, but is atypical and has been recognised as a separate species – *Proteus hauseri* – it is used for media control. Colonies are glistening with spreading edges.

***Pseudomonas aeruginosa* strains:**

MM10 – NCTC® 12903 / ATCC® 27853 / WDCM 00025 – is fully sensitive to anti-pseudomonal antibiotics (EUCAST susceptibility test control). 2 colony types may be observed: A) predominantly flat, spreading edges and rough surface; B) small and compact. Produces both fluorescein and pyocyanin pigments.

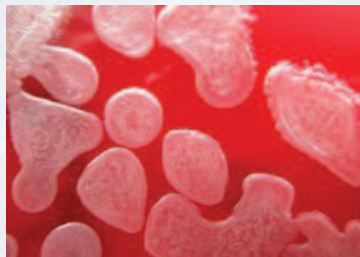

MM65 – NCTC® 10662 / ATCC® 25668 / WDCM 00114 – is fully sensitive. PHE recommended control strain for media control

MM40 – NCTC® 12924 / ATCC® 9027 / WDCM 00026 – used in water industry / disinfectant testing. Colonies on agar plates are entire, glistening and mucoid with a grainy surface. This strain also produces both fluorescein and pyocyanin pigments.

MM41 – NCTC® 13359 / ATCC® 15442 – used in water industry / disinfectant testing. May produce up to 3 different colony types. Pyocyanin is not produced.

Rhodococcus equi:

MM97 – NCTC® 1621 / ATCC® 6939 / WDCM 00028 – type strain.

Saccharomyces cerevisiae:

MM73 – NCPF® 3178 – PHE recommended strain for food testing and enumeration of yeasts and moulds.

MM50 – NCTC® 10716 / WDCM 00058 – used for QC of culture media and for antifungal susceptibility testing.

***Salmonella* serotypes:**

MM11 *Salmonella* Typhimurium – NCTC® 12023 / ATCC® 14028 / WDCM 00031 – (1,4,5,12: i: 1,2) Used for media/test QC. This is a common serotype from animals and from human infections.

The strains listed below are unusual serotypes, used to avoid any chance of confusion with strains commonly found in animals, food, etc, and are used to control media and detection methods in the food industry:

MM89 *Salmonella* Poona – NCTC® 4840 – (13,22: z: 1,6) PHE recommended control strain for food testing.

MM84 *Salmonella* Nottingham – NCTC® 7832 – (16: d: e,n,z15) PHE recommended control for water testing.

Serratia marcescens:

MM12 – NCTC® 13382 / ATCC® 8100 – used for disinfectant testing. PHE recommended negative control for indole test. Colonies are entire, glistening, smooth and translucent. Non-pigmented.

Staphylococcus aureus:

(A) Fully sensitive:

MM85 – NCTC® 6571 / ATCC® 9144 / WDCM 00035 – historically used for susceptibility testing ('Oxford staph'), but largely superseded by MM13 as it has unusually low MIC's and so is unrepresentative of normal range of Staph aureus strains. Sensitive to penicillin and ceftazidime / methicillin / oxacillin. **PHE** recommended coagulase, DNase and catalase positive control.

MM13 – NCTC® 12981 / ATCC® 25923 / WDCM 00034 – used in susceptibility and media testing/QC. Fully sensitive to all anti-staphylococcal antibiotics (including penicillin and methicillin / oxacillin). It is preferable to maintain cultures on agar as passage in broth can result in a change in MIC levels. Colonies are circular white to cream, convex to flat in elevation. After 48 hours incubation a few grey/translucent variants may be noted. Beta-haemolytic on sheep blood agar.

B) Penicillin resistant:

MM14 – NCTC® 12973 / ATCC® 29213 / WDCM 00131 – used for susceptibility testing, especially for automated methodology. **EUCAST**, **CLSI** strain. Sensitive to ceftazidime / methicillin / oxacillin. Penicillin resistant – weak beta-lactamase producer. Colonies are beta-haemolytic, and a golden-orange colour.

MM30 – NCTC® 7447 / ATCC® 6538P / WDCM 00033 – used for susceptibility testing/antibiotic assay, disinfectant testing. Ceftazidime / methicillin / oxacillin sensitive. Penicillin resistant. Colonies are weakly beta-haemolytic, coagulase positive and beta-lactamase negative.

(C) MRSA (ceftazidime / methicillin / oxacillin resistant):

MM91 – NCTC® 13373 / ATCC® 43300 / WDCM 00211 (MRSA) – Possesses mecA gene but is hetero-resistant, (so as few as one per thousand cells demonstrate the resistance) and consequently has low-level ceftazidime / oxacillin / methicillin resistance (4.0 mg/l MIC of oxacillin, 8.0 mg/l MIC of ceftazidime – methicillin sensitive strains have MIC of 0.12-0.5 for oxacillin and 1-4 for ceftazidime.); it is used to confirm testing procedures for methicillin resistance are working and provides a more stringent test than testing with an MRSA which shows homogeneous resistance and has a much higher MIC. This organism will have a zone of inhibition reduced in size compared to a fully ceftazidime / oxacillin / methicillin sensitive strain (such as MM13). **CLSI** recommended strain for MRSA testing. There are two colony types: 1) Beta-haemolytic with a slight yellow tint. 2) Non-haemolytic and white.

MM64 – NCTC® 12493 / WDCM 00212 (MRSA) – possesses mecA gene and shows homogeneous resistance with MIC of >64 for methicillin, which produces high-level ceftazidime / methicillin / oxacillin resistance. **EUCAST** recommended strain. Instances have been reported where loss of the mecA gene has occurred during storage.

D) Other:

MM46 – NCTC® 10788 / ATCC® 6538 / WDCM 00032 – used in pharmaceutical industry for testing disinfectants etc. Usually yellow pigmented colonies, or can produce a white colonial variant. Beta-haemolytic.



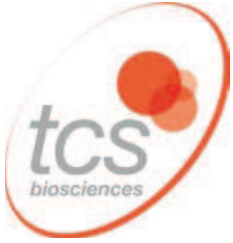

Staphylococcus epidermidis:

MM15 – NCTC® 13360 / ATCC® 12228 / WDCM 00036 – used for media control / antibiotic assay. Colonies are small and beta-haemolytic.

Streptococcus agalactiae: (Beta-haemolytic Streptococcus group B)

MM16 – NCTC® 8181 / ATCC® 13813 – type strain, used for QC. PHE recommended negative control for aesculin test.

Streptococcus pneumoniae strains:

MM95 – NCTC® 12977 / ATCC® 49619 – has low-level, but clinically relevant, resistance to penicillin – this organism is used to assess detection of resistance rather than sensitivity. PHE recommended positive control for bile solubility test. CLSI, EUCAST recommended control strain for susceptibility testing. Serotype 19F.

MM19 – NCTC® 12695 / ATCC® 6303 – is fully sensitive. Colonies are mucoid and alpha-haemolytic. A few colonies may have an irregular edge. Serotype 3.



Streptococcus pyogenes:

MM20 – NCTC® 12696 / ATCC® 19615 – used for QC and media testing. Lancefield group A, beta-haemolytic. PHE recommended blood agar control.

Vibrio parahaemolyticus:

MM06 – NCTC® 10885 / WDCM 00185 – used for QC of media and ID testing. PHE recommended strain used mainly in the food industry.

Yersinia enterocolitica:

MM80 – NCTC® 12982 / ATCC® 9610 / WDCM 00038 – type strain, used for media control. Serotype O:8, which is a pathogenic serotype, commonest in USA.

References:

- 1 European Committee on Antimicrobial Susceptibility Testing (EUCAST). Routine and Extended Internal Quality Control for MIC Determination and Disc Diffusion. Version 7.0 - 01.01.2017.
- 2 UK Standards for Microbiology Investigations. Example Reference Strains for Microbiology Investigations Test Procedures: Bacteriology—Test Procedures | TP 1 | Issue No. 2 | 05.01.2015. Public Health England (PHE).
- 3 Performance Standards for Antimicrobial Disc Susceptibility Tests: Approved Standard—11th Edition. Clinical and Laboratory Standards Institute (CLSI).

How to use Selectrol®

Always warm the vial to ambient temperature before opening.

Be sure to use non-selective culture media to revive the organisms.

For the more fastidious organisms, such as anaerobes, it is generally better to use agar rather than broth for revival.

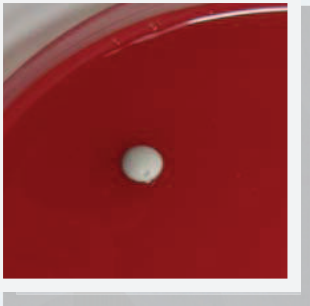

Place disc on suitable growth medium such as blood agar

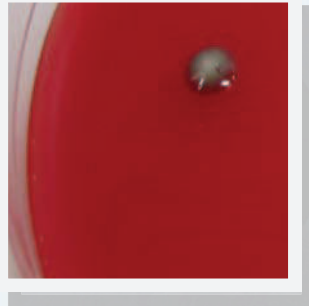

Leave disc for a few minutes to liquefy, then spread plate and incubate to produce isolated colonies



Obtain a stock culture which can be used to prepare an inoculum for biochemical and antibiotic susceptibility tests

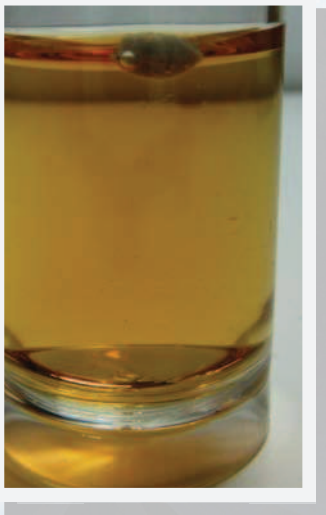

Place disc in a small volume of a suitable broth medium such as brain-heart infusion

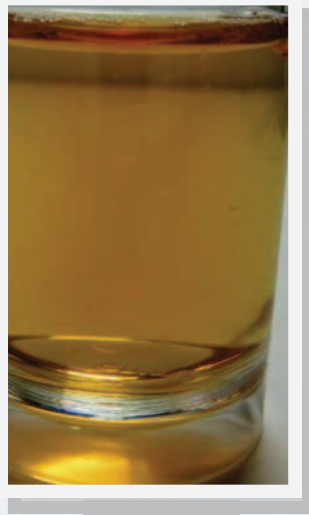

Allow disc a few minutes to dissolve, then spread aliquot onto a plate of suitable growth medium



Out-of-specification results

Laboratories use Selectrol® for Quality Control of culture media, biochemical identification tests and antimicrobial susceptibility testing. When a laboratory test result, an MIC or biochemical reaction, is unexpected or out-of-specification, the test should first be repeated to confirm it; an out-of-specification result is an indication that the testing procedure should be reviewed; it is not, in the first instance, a sign of a problem with the control organism.

If incorrect results are obtained on retesting, the explanation could be:

- The test procedure was not followed correctly – check standard operating procedures
- There is an instrumentation error – check calibration, mechanical functioning, etc
- There is a problem with the consumables – out of date, incorrect storage, etc
- The culture of the control organism has become contaminated

Technical Support

If no explanation for out-of-spec results can be found, but repeated tests still give unacceptable results, please contact TCS and / or your relevant reference laboratory or instrument manufacturer for advice. For example, contact AMRHAI at Colindale, London if MIC results are consistently outside the acceptable range. Please retain any remaining discs of organisms about which you have concerns so they can be returned to TCS and investigated alongside retained samples.

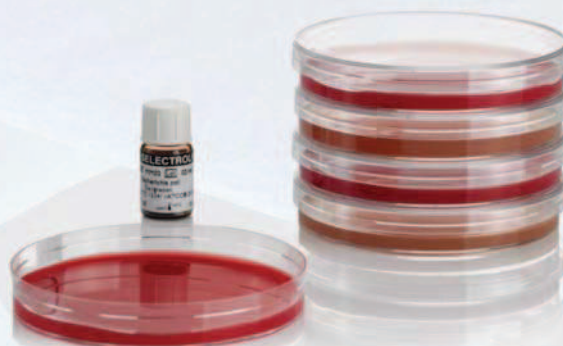

Preparing QC and Validation Spikes from Selectrol®

Preparing the spike

- Place a Selectrol® disc in Brain Heart Infusion (BHI) broth* or equivalent, and culture (typically for 18 hours) at the appropriate temperature for the organism (typically 37°C)
- Assume the count in the broth to be 10^8 organisms per ml ----- (A)
- Mix and transfer 100 μ l of (A) to 100 ml of saline or $\frac{1}{4}$ strength Ringer's solution -- (B)
- Mix and transfer 100 μ l of (B) to 10 ml of saline or $\frac{1}{4}$ strength Ringer's solution --- (C)
- Mix and transfer 100 μ l of (C) to your homogenised food sample.

Verifying the inoculum

- Pipette 5 x 10 μ l drops from (C) onto each of two agar plates for Miles and Misra counts.

Using the assumptions and dilutions above:

- (A) contains 10^8 organisms per ml
- (B) contains 10^5 organisms per ml
- (C) contains 10^3 organisms per ml

If the Miles and Misra counts indicate that the required count was not achieved:

- If the count was too high by a factor of 10, reduce the volume transferred from (A) to (B) from 100 μ l to 10 μ l
- If the count was too low by a factor of 10, increase the volume transferred from (A) to (B) from 100 μ l to 1 ml.

Keep a record of the correct dilutions for each organism type for future use. You will find that this method is very repeatable.

*Note: BHI broth will work for most of the Selectrol® organisms; however, for fastidious organisms an appropriate culture broth must be selected, e.g. Fastidious Anaerobe Broth for strictly anaerobic organisms.





Culture Collections

Cultures of microorganisms have been deposited and subsequently maintained in 589 collections in 68 countries, and many of the cultures are derived from the same original isolate; the history of each organism, its properties and names of the culture collections which hold it are detailed in the relevant catalogues and websites.

Some of the organisms have been selected and recommended by expert organisations to be supplied as controls for microbiological tests, and when the identical cultures are present in more than one collection they will have a specific designation for each, incorporating the abbreviation for the collection and a reference number.

For example:- *Staphylococcus aureus* NCTC 7447, widely recommended as a control for antimicrobial susceptibility testing, is held in 30 collections, and consequently the phenotypically and genotypically identical organism has 30 different references, such as ATCC 6538P, CIP 53.156, DSM 346 and so on.

In an effort to minimise potential confusion and help users find local sources of reference strains, the WFCC and the WDCM initiated a system that ascribes each recommended QC strain a reference number (WDCM 00001 onwards), cites all collections that contain it and provides contact details and each collection's unique reference. For example, the strain of *Staphylococcus aureus* NCTC 7447 (Selectrol® strain MM33) mentioned above is designated WDCM 00033.

***Staphylococcus aureus* WDCM 00033**

AHU 1142; **ATCC™ 6538P**; BCRC 10451 ; BTCC 209P; BU 395; CCM 2022; CCTM 596; CCUG 1828; CECT 240; CIP 53.156; CN 3784; CNCTC Mau 28/58; DSM 346; FIRDI 451; IAM 1011; IAM 12082; IEM Mau 28/58; IFO 12732; IFO 3061; IID 671; IMET 10904; JCM 2151; LMG 8195; NCIMB 8625; **NCTC 7447**; NRRL B-313; OUT 8232; PCI 1209; PZH 8/54; RIMD 3109007; VNIIA 209P;

Products derived from the cultures in the collections should be manufactured using the minimum number of sub-cultures, to minimise the possibility of alterations to the phenotype due to mutations. Ideally, as in the case of **Selectrol®**, a single sub-culture only is used, so the **Selectrol®** product is a 'first generation derivative' of a culture supplied by NCTC, and will be identical with regard to its properties and suitability for use in QC applications to a culture of the particular organism obtained from any of the other WDCM listed culture collections.

Every effort has been made to ensure the accuracy of the information in this document, however TCS makes no warranties, expressed or implied, regarding errors or omissions and assumes no legal liability or responsibility for loss or damage resulting from the use of information contained within.

Selectrol Strain Index

Strain Name	Designation	Code	WDCM
<i>Aspergillus brasiliensis</i>	NCPF [®] 2275 / ATCC [®] 16404	MM94	00053
<i>Bacillus cereus</i>	NCTC [®] 10320 / ATCC [®] 9634	MM21	00001
<i>Bacillus cereus</i>	NCTC [®] 7464 / ATCC [®] 10876	MM86	
<i>Bacillus subtilis</i>	NCTC [®] 10400 / ATCC [®] 6633	MM29	00003
<i>Bacteroides fragilis</i>	NCTC [®] 9343 / ATCC [®] 25285	MM44	
<i>Campylobacter jejuni</i>	NCTC [®] 11351 / ATCC [®] 33560	MM36	
<i>Campylobacter jejuni</i>	NCTC [®] 11322 / ATCC [®] 29428	MM82	00156
<i>Candida albicans</i>	NCPF [®] 3255 / ATCC [®] 2091	MM28	00055
<i>Candida albicans</i>	NCPF [®] 3179 / ATCC [®] 10231	MM42	00054
<i>Citrobacter freundii</i>	NCTC [®] 9750 / ATCC [®] 8090	MM27	
<i>Clostridium perfringens</i>	NCTC [®] 8237 / ATCC [®] 13124	MM45	00007
<i>Clostridium sporogenes</i>	NCTC [®] 532 / ATCC [®] 19404	MM31	00008
<i>Enterobacter aerogenes</i>	NCTC [®] 10006 / ATCC [®] 13048	MM26	00175
<i>Enterobacter cloacae</i>	NCTC [®] 13380 / ATCC [®] 23355	MM01	00082
<i>Enterobacter cloacae</i>	NCTC [®] 13406	MM51	
<i>Enterococcus faecalis</i>	NCTC [®] 775 / ATCC [®] 19433	MM17	00009
<i>Enterococcus faecalis</i>	NCTC [®] 12697 / ATCC [®] 29212	MM18	00087
<i>Enterococcus faecalis</i>	NCTC [®] 13379 / ATCC [®] 51299	MM52	00085
<i>Enterococcus hirae</i>	NCTC [®] 13383 / ATCC [®] 10541	MM35	00011
<i>Escherichia coli</i>	NCTC [®] 12241 / ATCC [®] 25922	MM02	00013
<i>Escherichia coli</i>	NCTC [®] 11954 / ATCC [®] 35218	MM24	
<i>Escherichia coli</i>	NCTC [®] 10418 / ATCC [®] 10536	MM33	
<i>Escherichia coli</i>	NCTC [®] 12923 / ATCC [®] 8739	MM38	00012
<i>Escherichia coli</i>	NCTC [®] 11560	MM63	
<i>Escherichia coli</i>	NCTC [®] 9001 / ATCC [®] 11775	MM75	00090
<i>Escherichia coli</i> CRE	NCTC [®] 13476	MM57	
<i>Escherichia coli</i> (mcr-1)	NCTC [®] 13846	MM34	
<i>Escherichia coli</i> O157 (non-toxigenic)	NCTC [®] 12900 / ATCC [®] 700728	MM93	00014
<i>Haemophilus influenzae</i>	NCTC [®] 8468 / ATCC [®] 9334	MM100	
<i>Haemophilus influenzae</i>	NCTC [®] 12975 / ATCC [®] 49766	MM37	
<i>Haemophilus influenzae</i>	NCTC [®] 12699 / ATCC [®] 49247	MM81	
<i>Haemophilus influenzae</i>	NCTC [®] 11931	MM98	
<i>Klebsiella aerogenes</i>	NCTC [®] 9528	MM88	
<i>Klebsiella pneumoniae</i>	NCTC [®] 9633 / ATCC [®] 13883	MM04	00097
<i>Klebsiella pneumoniae</i>	NCTC [®] 13368 / ATCC [®] 700603	MM83	
<i>Klebsiella pneumoniae</i> CRE	NCTC [®] 13440	MM55	
<i>Klebsiella pneumoniae</i> CRE	NCTC [®] 13443	MM56	
<i>Klebsiella pneumoniae</i> CRE	NCTC [®] 13438	MM58	

Selectrol Strain Index

Strain Name	Designation	Code	WDCM
<i>Klebsiella pneumoniae</i> CRE	NCTC [®] 13442	MM59	
<i>Lactobacillus brevis</i>	NCTC [®] 13386 / ATCC [®] 8287	MM76	
<i>Legionella pneumophila</i> serogroup 1	NCTC [®] 11192 / ATCC [®] 33152	MM08	00107
<i>Listeria innocua</i>	NCTC [®] 11288 / ATCC [®] 33090	MM92	00017
<i>Listeria monocytogenes</i>	NCTC [®] 7973 / ATCC [®] 35152	MM48	00109
<i>Listeria monocytogenes</i>	NCTC [®] 13372 ATCC [®] 7644	MM77	
<i>Listeria monocytogenes</i>	NCTC [®] 11994	MM87	00019
<i>Neisseria gonorrhoeae</i>	NCTC [®] 8375 / ATCC [®] 19424	MM05	
<i>Neisseria gonorrhoeae</i>	NCTC [®] 12700 / ATCC [®] 49226	MM96	
<i>Proteus mirabilis</i>	NCTC [®] 13376 / ATCC [®] 14153	MM43	
<i>Proteus mirabilis</i>	NCTC [®] 10975	MM68	
<i>Proteus vulgaris</i>	NCTC [®] 4175 / ATCC [®] 13315	MM09	
<i>Pseudomonas aeruginosa</i>	NCTC [®] 12903 / ATCC [®] 27853	MM10	00025
<i>Pseudomonas aeruginosa</i>	NCTC [®] 12924 / ATCC [®] 9027	MM40	00026
<i>Pseudomonas aeruginosa</i>	NCTC [®] 13359 / ATCC [®] 15442	MM41	
<i>Pseudomonas aeruginosa</i>	NCTC [®] 10662 / ATCC [®] 25668	MM65	00114
<i>Rhodococcus equi</i>	NCTC [®] 1621 / ATCC [®] 6939	MM97	00028
<i>Saccharomyces cerevisiae</i>	NCTC [®] 10716/ ATCC [®] 9763	MM50	00058
<i>Saccharomyces cerevisiae</i>	NCPF [®] 3178	MM73	
<i>Salmonella</i> Nottingham	NCTC [®] 7832	MM84	
<i>Salmonella</i> Poona	NCTC [®] 4840	MM89	
<i>Salmonella</i> Typhimurium	NCTC [®] 12023/ ATCC [®] 14028	MM11	00031
<i>Serratia marcescens</i>	NCTC [®] 13382 / ATCC [®] 8100	MM12	
<i>Staphylococcus aureus</i>	NCTC [®] 12981 / ATCC [®] 25923	MM13	00034
<i>Staphylococcus aureus</i>	NCTC [®] 12973 / ATCC [®] 29213	MM14	00131
<i>Staphylococcus aureus</i>	NCTC [®] 7447 / ATCC [®] 6538P	MM30	00033
<i>Staphylococcus aureus</i>	NCTC [®] 10788 / ATCC [®] 6538	MM46	00032
<i>Staphylococcus aureus</i>	NCTC [®] 6571 / ATCC [®] 9144	MM85	00035
<i>Staphylococcus aureus</i> (MRSA)	NCTC [®] 12493	MM64	00212
<i>Staphylococcus aureus</i> (MRSA)	NCTC [®] 13373 / ATCC [®] 43300	MM91	00211
<i>Staphylococcus epidermidis</i>	NCTC [®] 13360 / ATCC [®] 12228	MM15	00036
<i>Streptococcus agalactiae</i>	NCTC [®] 8181 / ATCC [®] 13813	MM16	
<i>Streptococcus pneumoniae</i>	NCTC [®] 12695 / ATCC [®] 6303	MM19	
<i>Streptococcus pneumoniae</i>	NCTC [®] 12977 / ATCC [®] 49619	MM95	
<i>Streptococcus pyogenes</i>	NCTC [®] 12696 / ATCC [®] 19615	MM20	
<i>Vibrio parahaemolyticus</i>	NCTC [®] 10885	MM06	00185
<i>Yersinia enterocolitica</i>	NCTC [®] 12982 / ATCC [®] 9610	MM80	00038

Selectrol Strains Listed by WDCM Number

WDCM	Strain Name	Designation	Code
00001	<i>Bacillus cereus</i>	NCTC [®] 10320 / ATCC [®] 9634	MM21
00003	<i>Bacillus subtilis</i>	NCTC [®] 10400 / ATCC [®] 6633	MM29
00007	<i>Clostridium perfringens</i>	NCTC [®] 8237 / ATCC [®] 13124	MM45
00008	<i>Clostridium sporogenes</i>	NCTC [®] 532 / ATCC [®] 19404	MM31
00009	<i>Enterococcus faecalis</i>	NCTC [®] 775 / ATCC [®] 19433	MM17
00011	<i>Enterococcus hirae</i>	NCTC [®] 13383 / ATCC [®] 10541	MM35
00012	<i>Escherichia coli</i>	NCTC [®] 12923 / ATCC [®] 8739	MM38
00013	<i>Escherichia coli</i>	NCTC [®] 12241 / ATCC [®] 25922	MM02
00014	<i>Escherichia coli</i> O157 (non-toxigenic)	NCTC [®] 12900 / ATCC [®] 700728	MM93
00017	<i>Listeria innocua</i>	NCTC [®] 11288 / ATCC [®] 33090	MM92
00019	<i>Listeria monocytogenes</i>	NCTC [®] 11994	MM87
00025	<i>Pseudomonas aeruginosa</i>	NCTC [®] 12903 / ATCC [®] 27853	MM10
00026	<i>Pseudomonas aeruginosa</i>	NCTC [®] 12924 / ATCC [®] 9027	MM40
00028	<i>Rhodococcus equi</i>	NCTC [®] 1621 / ATCC [®] 6939	MM97
00031	<i>Salmonella</i> Typhimurium	NCTC [®] 12023 / ATCC [®] 14028	MM11
00032	<i>Staphylococcus aureus</i>	NCTC [®] 10788 / ATCC [®] 6538	MM46
00033	<i>Staphylococcus aureus</i>	NCTC [®] 7447 / ATCC [®] 6538P	MM30
00034	<i>Staphylococcus aureus</i>	NCTC [®] 12981 / ATCC [®] 25923	MM13
00035	<i>Staphylococcus aureus</i>	NCTC [®] 6571 / ATCC [®] 9144	MM85
00036	<i>Staphylococcus epidermidis</i>	NCTC [®] 13360 / ATCC [®] 12228	MM15
00038	<i>Yersinia enterocolitica</i>	NCTC [®] 12982 / ATCC [®] 9610	MM80
00053	<i>Aspergillus brasiliensis</i>	NCPF [®] 2275 / ATCC [®] 16404	MM94
00054	<i>Candida albicans</i>	NCPF [®] 3179 / ATCC [®] 10231	MM42
00055	<i>Candida albicans</i>	NCPF [®] 3255 / ATCC [®] 2091	MM28
00058	<i>Saccharomyces cerevisiae</i>	NCTC [®] 10716 / ATCC [®] 9763	MM50
00082	<i>Enterobacter cloacae</i>	NCTC [®] 13380 / ATCC [®] 23355	MM01
00085	<i>Enterococcus faecalis</i>	NCTC [®] 13379 / ATCC [®] 51299	MM52
00087	<i>Enterococcus faecalis</i>	NCTC [®] 12697 / ATCC [®] 29212	MM18
00090	<i>Escherichia coli</i>	NCTC [®] 9001 / ATCC [®] 11775	MM75
00097	<i>Klebsiella pneumoniae</i>	NCTC [®] 9633 / ATCC [®] 13883	MM04
00107	<i>Legionella pneumophila</i> serogroup 1	NCTC [®] 11192 / ATCC [®] 33152	MM08
00109	<i>Listeria monocytogenes</i>	NCTC [®] 7973 / ATCC [®] 35152	MM48
00114	<i>Pseudomonas aeruginosa</i>	NCTC [®] 10662 / ATCC [®] 25668	MM65
00131	<i>Staphylococcus aureus</i>	NCTC [®] 12973 / ATCC [®] 29213	MM14
00156	<i>Campylobacter jejuni</i>	NCTC [®] 11322 / ATCC [®] 29428	MM82
00175	<i>Enterobacter aerogenes</i>	NCTC [®] 10006 / ATCC [®] 13048	MM26
00185	<i>Vibrio parahaemolyticus</i>	NCTC [®] 10885	MM06
00211	<i>Staphylococcus aureus</i> (MRSA)	NCTC [®] 13373 / ATCC [®] 43300	MM91
00212	<i>Staphylococcus aureus</i> (MRSA)	NCTC [®] 12493	MM64

Notes





www.tcsbiosciences.co.uk



TCS Biosciences Ltd

Botolph Claydon, Buckingham, MK18 2LR, United Kingdom

t: +44 (0) 1296 714222, f: +44 (0) 1296 714806, e: sales@tcsgroup.co.uk

Date: 23rd January 2023**STATEMENT**

We, **HiMedia Laboratories Pvt. Ltd.**, having a registered office at **Plot No.:C40, Road No.:21Y, MIDC, Wagle Industrial Area, Thane (West) - 400 604, Maharashtra, INDIA** assign **SRL SANMEDICO** having a registered office at **A. Corobceanu street 7A, apt. 9, Chişinău MD-2012, Moldova** , as authorized representative in correspondence with the conditions of directive 98/79/EEC.

We declare that the company mentioned above is authorized to register, notify, renew or modify the registration of medical devices on the territory of the Republic of Moldova.

For **HIMEDIA LABORATORIES PVT. LTD.**,

V.M.WARKE.



DIRECTOR – SALES & MARKETING

REGISTERED OFFICE -

Plot No. C40, Road No. 21Y, MIDC, Wagle Industrial Area, Thane (West) - 400604, Maharashtra, India.
Tel: +91-22-6147 1919 / 6116 9797 / 6903 4800 | Fax: +91-22-6147 1920
Email: info@himedialabs.com | Web: www.himedialabs.com



... expect only quality from us™
CIN: U85195MH1982PTC028194

Certificate of CE-Registration

This is to certify that, in accordance with the *In Vitro* Diagnostic Medical Device Directive 98/79/EC, **CEpartner4U BV** agrees to perform all duties and responsibilities as the Authorized Representative for

Himedia Laboratories PVT. LTD

23 Vadhani Industrial Estate,
LBS Marg, Mumbai - 86, MS,
India

as stipulated and demanded by the aforementioned Directive. The Dutch Competent Authorities have accepted the manufacturer's medical device registrations by CEpartner4U as listed on the product list attached to the manufacturer's Declaration of Conformity:

IVD devices were registered under number:

Group 1 : Dehydrated Culture Media & Supplements	Registration No: NL-CA002-26442
Group 2 : Ready Prepared Media	Registration No: NL-CA002-26448
Group 3 : Epidemiological Screening Kit	Registration No: NL-CA002-24117
Group 4 : Antimicrobial Susceptibility Systems	Registration No: NL-CA002-26444
Group 5 : Bacteriological Differentiation Aids	Registration No: NL-CA002-26445
Group 6 : Cell Culture Media	Registration No: NL-CA002-26446
Group 7 : Molecular Biology Products	Registration No: NL-CA002-26447

see appendix

with Dutch Competent Authorities as a consequently these IVD devices were entered in EUDAMED by Dutch Competent Authorities

The manufacturer has provided CEpartner4U with all necessary documentation, together with an appropriate Declaration of Conformity that the IVD medical devices fulfil the essential requirements of Directive 98/79/EC.

Issue date: 2019-07-03



Olga Teirlinck
Consultant CEpartner4U BV

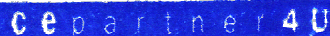

Esdoornlaan13
3951 DB Maarn NL
tel: +31 (0)343 442 524
www.cepartner4u.nl

Appendix

Product group	Type/ Model / Ref number	Device Name	Risk Class	Date of CE compliance
Product Group 1: Dehydrated Culture Media & Supplements Registration No: NL-CA002-26442				
DCM	M1739	A7 Agar Base (Shepard's Differential Agar Base)	Low risk	20/12/2012
DCM	MCD884	Aeromonas Isolation HiCynth™ Medium Base	Low risk	12/08/2015
DCM	MV884	Aeromonas Isolation HiVeg™ Medium Base	Low risk	20/12/2012
DCM	M884	Aeromonas Isolation Medium Base	Low risk	20/12/2012
DCM	M1284	Aeromonas Starch DNA Agar Base	Low risk	20/12/2012
DCM	M016B	Agar Medium L (Brilliant Green, Phenol Red, Lactose Monohydrate, Sucrose Agar)	Low risk	20/12/2012
DCM	ME016	Agar Medium L (Brilliant Green, Phenol Red, Lactose Monohydrate, Sucrose Agar)	Low risk	20/12/2012
DCM	MCD618	Alkaline HiCynth™ Peptone Water	Low risk	12/08/2015
DCM	MV618	Alkaline HiVeg™ Peptone Water	Low risk	20/12/2012
DCM	M618	Alkaline Peptone Water	Low risk	20/12/2012
DCM	M651	Amies Transport Medium w/ Charcoal	Low risk	20/12/2012
DCM	M684A	Amies Transport Medium, Liquid w/o charcoal	Low risk	25/08/2016
DCM	M228	Anaerobic Agar	Low risk	20/12/2012
DCM	M491	Anaerobic Agar (Brewer)	Low risk	20/12/2012
DCM	M230	Anaerobic Agar w/o Dextrose	Low risk	20/12/2012
DCM	M229	Anaerobic Agar w/o Dextrose and Eh Indicator	Low risk	20/12/2012
DCM	M1635	Anaerobic Basal Agar	Low risk	20/12/2012
DCM	M1636	Anaerobic Basal Broth	Low risk	20/12/2012
DCM	M1345	Anaerobic Blood Agar Base	Low risk	20/12/2012
DCM	M975A	Anaerobic Blood Agar Base	Low risk	20/12/2012
DCM	M1034	Anaerobic CNA Agar Base	Low risk	20/12/2012
DCM	MV228	Anaerobic HiVeg™ Agar	Low risk	20/12/2012
DCM	MV491	Anaerobic HiVeg™ Agar (Brewer)	Low risk	20/12/2012
DCM	MV230	Anaerobic HiVeg™ Agar w/o Dextrose	Low risk	20/12/2012
DCM	MV229	Anaerobic HiVeg™ Agar w/o Dextrose and Eh Indicator	Low risk	20/12/2012
DCM	MV909	Andrade Peptone Water w/ HiVeg™ Extract No. 1	Low risk	20/12/2012
DCM	M909	Andrade Peptone Water w/ HM Extract	Low risk	20/12/2012
DCM	M1485	Antibiotic Sulphonamide Sensitivity Test Agar (ASS Agar)	Low risk	20/12/2012
DCM	M1576	Arabinose Agar Base	Low risk	30/10/2018
DCM	M672	Asparagine Broth (Coccidioidin and Histoplasmin Broth)	Low risk	20/12/2012
DCM	M158	Azide Blood Agar Base	Low risk	20/12/2012
DCM	MV158	Azide Blood Agar Base, HiVeg™	Low risk	20/12/2012
DCM	M220	B.A.G.G. Broth Base (Buffered Azide Glucose Glycerol Broth Base)	Low risk	20/12/2012

DCM	MV220	B.A.G.G. HiVeg™ Broth Base (Buffered Azide Glucose Glycerol HiVeg™ Broth Base)	Low risk	20/12/2012
DCM	M106	B.C.G. - Dextrose Agar (Snyder Test Agar)	Low risk	20/12/2012
DCM	MV106	B.C.G. - Dextrose HiVeg™ Agar (Snyder Test HiVeg™ Agar)	Low risk	20/12/2012
DCM	MCD462	B.Q.Vaccine HiCynth™ Medium (Thioglycollate HiCynth™ Broth)	Low risk	28/04/2017
DCM	MV462	B.Q.Vaccine HiVeg™ Medium (Thioglycollate Broth w/ HiVeg™ Extract No. 2)	Low risk	20/12/2012
DCM	M462	B.Q.Vaccine Medium (Thioglycollate Broth w/ HL Extract)	Low risk	20/12/2012
DCM	M861	B.T.B. Lactose Agar	Low risk	20/12/2012
DCM	MCD861	B.T.B. Lactose HiCynth™ Agar	Low risk	28/04/2017
DCM	MCD1081	B.T.B. Lactose HiCynth™ Agar, Modified	Low risk	28/04/2017
DCM	MV861	B.T.B. Lactose HiVeg™ Agar	Low risk	20/12/2012
DCM	MV833	Bacillus Cereus HiVeg™ Agar Base	Low risk	22/04/2019
DCM	M833	Bacillus Cereus Agar Base	Low risk	22/04/2019
DCM	M805	Bacteroides Bile Esculin Agar Base (BBE)	Low risk	20/12/2012
DCM	MV805	Bacteroides HiVeg™ Agar Base (BBE)	Low risk	20/12/2012
DCM	M043	Baird Parker Agar Base	Low risk	20/12/2012
DCM	M2093	Baird Parker Agar Base w/o Egg Yolk Emulsion	Low risk	22/04/2019
DCM	MCD043	Baird Parker HiCynth™ Agar Base	Low risk	12/08/2015
DCM	MV043	Baird Parker HiVeg™ Agar Base	Low risk	20/12/2012
DCM	M694	Bennet's Agar	Low risk	20/12/2012
DCM	M1683	Bennet's Broth	Low risk	20/12/2012
DCM	MV694	Bennet's HiVeg™ Agar	Low risk	20/12/2012
DCM	M1888	BETA-SSA Agar (Group A Streptococci Selective Agar)	Low risk	20/12/2012
DCM	M211	BHI Agar (Special Infusion Agar)	Low risk	20/12/2012
DCM	M211A	BHI Agar w/ 1% Agar	Low risk	20/12/2012
DCM	MV211A	BHI Agar w/ 1% Agar, HiVeg™	Low risk	20/12/2012
DCM	M1069	BHI Agar w/ 3.0% Agar	Low risk	20/12/2012
DCM	MV211	BHI Agar, HiVeg™ (Special Infusion Agar, HiVeg™)	Low risk	20/12/2012
DCM	M1611	BHI Agar, Modified	Low risk	20/12/2012
DCM	M210	BHI Broth	Low risk	20/12/2012
DCM	M210I	BHI Broth	Low risk	20/12/2012
DCM	M209	BHI CC Agar	Low risk	20/12/2012
DCM	MV209	BHI CC Agar, HiVeg™	Low risk	20/12/2012
DCM	MCD211	BHI HiCynth™ Agar (Special Insusion HiCynth™ Agar)	Low risk	12/08/2015
DCM	MCD210	BHI HiCynth™ Broth	Low risk	12/08/2015
DCM	M1036	BHI w/ 0.1% Agar	Low risk	20/12/2012
DCM	M1037	BHI w/ 6.5% NaCl	Low risk	20/12/2012
DCM	MV1037	BHI w/ 6.5% NaCl, HiVeg™	Low risk	20/12/2012
DCM	M212	BHI w/ PABA	Low risk	20/12/2012
DCM	M213	BHI w/ PABA and Agar	Low risk	20/12/2012

DCM	MV213	BHI w/ PABA and Agar, HiVeg™	Low risk	20/12/2012
DCM	MV212	BHI w/ PABA, HiVeg™	Low risk	20/12/2012
DCM	MV1036	BHI with 0.1% Agar, HiVeg™	Low risk	20/12/2012
DCM	MV210	BHI, HiVeg™	Low risk	20/12/2012
DCM	M217	Bi.G.G.Y. Agar (Nickerson Medium)	Low risk	20/12/2012
DCM	MCD217	Bi.G.G.Y. HiCynth™ Agar (Nickerson HiCynth™ Agar)	Low risk	25/08/2016
DCM	M1960R	Bifidobacterium Agar (HiCrome™)	Low risk	25/08/2016
DCM	M1396R	Bifidobacterium Agar (Modified, Selective Medium, Kit)	Low risk	04/07/2018
DCM	M1858	Bifidobacterium Agar, Modified	Low risk	20/12/2012
DCM	M071	Bile Broth Base	Low risk	20/12/2012
DCM	MV071	Bile Broth Base, HiVeg™	Low risk	20/12/2012
DCM	M972A	Bile Esculin Agar, Modified	Low risk	22/04/2019
DCM	M481	Bile Peptone Transport Medium	Low risk	20/12/2012
DCM	M739	Bile Salt Agar	Low risk	20/12/2012
DCM	MCD027	Bismuth Sulphite HiCynth™ Agar	Low risk	12/08/2015
DCM	M027	Bismuth Sulphite Agar	Low risk	20/12/2012
DCM	M027L	Bismuth Sulphite Agar	Low risk	04/07/2018
DCM	MU027	Bismuth Sulphite Agar Medium	Low risk	20/12/2012
DCM	M1004	Bismuth Sulphite Agar, Modified	Low risk	20/12/2012
DCM	MV027	Bismuth Sulphite HiVeg™ Agar	Low risk	20/12/2012
DCM	MV1004	Bismuth Sulphite HiVeg™ Agar, Modified	Low risk	20/12/2012
DCM	M073	Blood Agar Base (Infusion Agar)	Low risk	20/12/2012
DCM	M834	Blood Agar Base No. 2	Low risk	20/12/2012
DCM	M834A	Blood Agar Base No. 2 w/ 1.2% Agar	Low risk	20/12/2012
DCM	MV834A	Blood Agar Base No. 2 w/ 1.2% Agar, HiVeg™	Low risk	20/12/2012
DCM	MV834	Blood Agar Base No. 2, HiVeg™	Low risk	20/12/2012
DCM	M834Z	Blood Agar Base No.2	Low risk	28/04/2017
DCM	M089	Blood Agar Base w/ Low pH	Low risk	20/12/2012
DCM	MV089	Blood Agar Base w/ Low pH, HiVeg™	Low risk	20/12/2012
DCM	M1904	Blood Agar Base w/ Nalidixic Acid	Low risk	20/12/2012
DCM	MV073	Blood Agar Base, HiVeg™ (Infusion Agar, HiVeg™)	Low risk	20/12/2012
DCM	M1989	Blood Agar Base, Modified	Low risk	20/12/2012
DCM	M1318	Blood Free Campylobacter Broth Base	Low risk	20/12/2012
DCM	MCD073	Blood HiCynth™ Agar Base (Infusion HiCynth™ Agar Base)	Low risk	25/08/2016
DCM	MCD834	Blood HiCynth™ Agar Base No.2	Low risk	25/08/2016
DCM	MCD089	Blood HiCynth™ Agar Base w/ Low pH	Low risk	25/08/2016
DCM	M175	Bordet Gengou Agar Base	Low risk	20/12/2012
DCM	M175A	Bordet Gengou Agar Base w/ 1.6% Agar	Low risk	20/12/2012
DCM	M175SB	Bordet Gengou Agar Base, Modified	Low risk	16/12/2017
DCM	M2012	Bordet Gengou Broth	Low risk	25/08/2016

DCM	MV175	Bordet Gengou HiVeg™ Agar Base	Low risk	20/12/2012
DCM	MV175A	Bordet Gengou HiVeg™ Agar Base w/ 1.6% Agar	Low risk	20/12/2012
DCM	M1020	BPL Agar	Low risk	20/12/2012
DCM	MV1020	BPL HiVeg™ Agar	Low risk	20/12/2012
DCM	M016A	Brilliant Green Agar Base w/ 1.2% Agar	Low risk	20/12/2012
DCM	M971	Brilliant Green Agar Base w/ Phosphates	Low risk	20/12/2012
DCM	M016	Brilliant Green Agar Base, Modified	Low risk	20/12/2012
DCM	MCD016	Brilliant Green Agar HiCynth™ Base, Modified	Low risk	12/08/2015
DCM	MU016	Brilliant Green Agar Medium	Low risk	20/12/2012
DCM	MM016	Brilliant Green Agar Medium 16	Low risk	20/12/2012
DCM	MV016A	Brilliant Green HiVeg™ Agar Base w/ 1.2% Agar	Low risk	20/12/2012
DCM	MV971	Brilliant Green HiVeg™ Agar Base w/ Phosphates	Low risk	20/12/2012
DCM	MV016	Brilliant Green HiVeg™ Agar Base, Modified	Low risk	20/12/2012
DCM	M016B	Brilliant Green, Phenol Red, Lactose Monohydrate, Sucrose Agar (Agar Medium L)	Low risk	20/12/2012
DCM	ME016	Brilliant Green, Phenol Red, Lactose Monohydrate, Sucrose Agar (Agar Medium L)	Low risk	20/12/2012
DCM	M1822	Bromo Thymol Lactose Blue Agar	Low risk	16/12/2017
DCM	M074	Brucella Agar Base	Low risk	20/12/2012
DCM	M1638	Brucella Agar Base w/ 1.0% Dextrose	Low risk	20/12/2012
DCM	M1039	Brucella Agar Base w/ Hemin and Vitamin K	Low risk	20/12/2012
DCM	M074A	Brucella Agar Base, Modified	Low risk	20/12/2012
DCM	M5392	Brucella Broth Base	Low risk	30/10/2018
DCM	M348	Brucella Broth Base	Low risk	20/12/2012
DCM	MV074	Brucella HiVeg™ Agar Base	Low risk	20/12/2012
DCM	MV074A	Brucella HiVeg™ Agar Base, Modified	Low risk	20/12/2012
DCM	MV348	Brucella HiVeg™ Broth Base	Low risk	20/12/2012
DCM	M822	Brucella Selective Medium Base	Low risk	20/12/2012
DCM	M1668	BSK - H Medium Base	Low risk	20/12/2012
DCM	M1668B	BSK - H Medium Base w/o BSA	Low risk	28/04/2017
DCM	M813	Buffered Charcoal Yeast Extract Agar Base	Low risk	20/12/2012
DCM	M813I	Buffered Charcoal Yeast Extract Agar Medium (BCYE Medium)	Low risk	20/12/2012
DCM	MCD813	Buffered Charcoal Yeast Extract HiCynth™ Medium	Low risk	25/08/2016
DCM	M204	Buffered Glycerol Saline Base	Low risk	20/12/2012
DCM	MCD1275	Buffered HiCynth™ Peptone Water w/ NaCl	Low risk	12/08/2015
DCM	MV614	Buffered HiVeg™ Peptone Water	Low risk	22/04/2019
DCM	MV1275	Buffered HiVeg™ Peptone Water w/NaCl	Low risk	20/12/2012
DCM	M614	Buffered Peptone Water	Low risk	22/04/2019
DCM	M1275	Buffered Peptone Water w/ NaCl	Low risk	20/12/2012
DCM	M1851	Buffered Peptone Water w/ Pyruvate	Low risk	20/12/2012
DCM	MH1275	Buffered Sodium Chloride-Peptone Solution pH 7.0	Low risk	22/04/2019
DCM	M1640	Burkholderia Cepacia Agar Base	Low risk	20/12/2012

DCM	MCD1640	Burkholderia cepacia HiCynth™ Agar Base	Low risk	25/08/2016
DCM	M2089	Burkholderia Cepacia Selective Agar	Low risk	30/10/2018
DCM	M470	BYE Agar	Low risk	20/12/2012
DCM	MV470	BYE HiVeg™ Agar	Low risk	20/12/2012
DCM	M911	C. botulinum Isolation Agar Base	Low risk	20/12/2012
DCM	MV911	C. botulinum Isolation HiVeg™ Agar Base	Low risk	20/12/2012
DCM	M1146	C.L.E.D. Agar Base w/o Indicator	Low risk	20/12/2012
DCM	M792	C.L.E.D. Agar w/ Bromo Thymol Blue	Low risk	20/12/2012
DCM	MCD792	C.L.E.D. HiCynth™ Agar w/BTB	Low risk	12/08/2015
DCM	MCD352	C.L.E.D. HiCynth™ Agar w/Andrade Indicator	Low risk	12/08/2015
DCM	MV1146	C.L.E.D. HiVeg™ Agar Base w/o Indicator	Low risk	20/12/2012
DCM	MV352	C.L.E.D. HiVeg™ Agar w/ Andrade Indicator	Low risk	20/12/2012
DCM	MV792	C.L.E.D. HiVeg™ Agar w/ Bromo Thymol Blue	Low risk	20/12/2012
DCM	M352	C.L.E.D. Agar w/ Andrade Indicator	Low risk	20/12/2012
DCM	M352M	C.L.E.D. Agar w/ Andrades Indicator	Low risk	22/04/2019
DCM	M352A	C.L.E.D. Agar w/o Lactose & w/ Andrades Indicator	Low risk	22/04/2019
DCM	M563	Caffeic Acid Ferric Citrate Test Agar (CAFC Medium)	Low risk	20/12/2012
DCM	M893	CAL Agar (Cellobiose Arginine Lysine Agar)	Low risk	20/12/2012
DCM	M894	CAL Broth (Cellobiose Arginine Lysine Broth)	Low risk	20/12/2012
DCM	MV893	CAL HiVeg™ Agar (Cellobiose Arginine Lysine HiVeg™ Agar)	Low risk	20/12/2012
DCM	MV894	CAL HiVeg™ Broth (Cellobiose Arginine Lysine HiVeg™ Broth)	Low risk	20/12/2012
DCM	MV908	Campylo Thioglycollate HiVeg™ Medium Base	Low risk	20/12/2012
DCM	M908	Campylo Thioglycollate Medium Base	Low risk	20/12/2012
DCM	M994	Campylobacter Agar Base	Low risk	20/12/2012
DCM	M1267	Campylobacter Cefex Agar Base	Low risk	20/12/2012
DCM	M899	Campylobacter Enrichment Broth Base (Preston Enrichment Broth Base)	Low risk	20/12/2012
DCM	MV899	Campylobacter Enrichment HiVeg™ Broth Base (Preston Enrichment HiVeg™ Broth Base)	Low risk	20/12/2012
DCM	MV994	Campylobacter HiVeg™ Agar Base	Low risk	20/12/2012
DCM	M1240	Campylobacter Nitrate Broth	Low risk	20/12/2012
DCM	MV1240	Campylobacter Nitrate HiVeg™ Broth	Low risk	20/12/2012
DCM	M1602	Candida Agar	Low risk	20/12/2012
DCM	M355	Candida BCG Agar Base	Low risk	20/12/2012
DCM	MV355	Candida BCG HiVeg™ Agar Base	Low risk	20/12/2012
DCM	MV104	Candida HiVeg™ Medium	Low risk	20/12/2012
DCM	M104	Candida Medium	Low risk	20/12/2012
DCM	M202	Cary - Blair Medium Base (Transport Medium w/o Charcoal)	Low risk	20/12/2012
DCM	M202A	Cary Blair Medium, Liquid w/o charcoal	Low risk	25/08/2016
DCM	M794	Casitose Agar w/ 2.5% Agar	Low risk	20/12/2012
DCM	M200	Casitose Broth	Low risk	20/12/2012

DCM	M910	Casitose Yeast Extract Broth (CAYE)	Low risk	20/12/2012
DCM	MV910	Casitose Yeast Extract HiVeg™ Broth (CAYE)	Low risk	20/12/2012
DCM	M201	Casman Agar Base	Low risk	20/12/2012
DCM	M766	Casman Broth Base	Low risk	20/12/2012
DCM	MV201	Casman HiVeg™ Agar Base	Low risk	20/12/2012
DCM	MV766	Casman HiVeg™ Broth Base	Low risk	20/12/2012
DCM	MH024	Cetrimide Agar	Low risk	22/04/2019
DCM	M024	Cetrimide Agar Base	Low risk	20/12/2012
DCM	M1742	Cetrimide Agar Base (w 1.3% Agar)	Low risk	20/12/2012
DCM	M862	Cetrimide Broth	Low risk	20/12/2012
DCM	MCD024	Cetrimide HiCynth™ Agar Base	Low risk	12/08/2015
DCM	MV024	Cetrimide HiVeg™ Agar Base	Low risk	20/12/2012
DCM	MV862	Cetrimide HiVeg™ Broth	Low risk	20/12/2012
DCM	M1053	Charcoal Agar Base with Niacin	Low risk	16/12/2017
DCM	M103	Chocolate Agar Base	Low risk	20/12/2012
DCM	MV103	Chocolate HiVeg™ Agar Base	Low risk	20/12/2012
DCM	M1548	Chocolate No. 2 Agar Base	Low risk	20/12/2012
DCM	MV1548	Chocolate No. 2 HiVeg™ Agar Base	Low risk	20/12/2012
DCM	MV558	Cholera HiVeg™ Medium Base	Low risk	20/12/2012
DCM	M558	Cholera Medium Base	Low risk	20/12/2012
DCM	M143	Christensen Citrate Agar	Low risk	20/12/2012
DCM	M1820	Chrysoidin Agar with MUG	Low risk	16/12/2017
DCM	M497	Clostridial Agar	Low risk	20/12/2012
DCM	MV497	Clostridial HiVeg™ Agar	Low risk	20/12/2012
DCM	M836	Clostridium Difficile Agar Base	Low risk	20/12/2012
DCM	MV836	Clostridium Difficile HiVeg™ Agar Base	Low risk	20/12/2012
DCM	M1976	Clostridium difficile Mannitol Taurocholate Broth base (CCMB -TAL Broth)	Low risk	20/12/2012
DCM	M272	Coagulase Mannitol Agar Base	Low risk	20/12/2012
DCM	M277	Coagulase Mannitol Broth Base	Low risk	20/12/2012
DCM	MV272	Coagulase Mannitol HiVeg™ Agar Base	Low risk	20/12/2012
DCM	MV277	Coagulase Mannitol HiVeg™ Broth Base	Low risk	20/12/2012
DCM	M1826	Coliform Broth w/SLS	Low risk	22/04/2019
DCM	M1826	Coliform Broth w/SLS	Low risk	22/04/2019
DCM	MV1826	Coliform HiVeg Broth w/ SLS	Low risk	22/04/2019
DCM	MH144	Columbia Agar	Low risk	22/04/2019
DCM	M144M	Columbia Agar	Low risk	22/04/2019
DCM	M144PM	Columbia Blood Agar Base	Low risk	22/04/2019
DCM	M144R	Columbia Blood Agar Base	Low risk	25/08/2016
DCM	M144	Columbia Blood Agar Base	Low risk	20/12/2012
DCM	M144A	Columbia Blood Agar Base w/ 1% Agar	Low risk	20/12/2012

DCM	MV144A	Columbia Blood Agar Base w/ 1% Agar, HiVeg™	Low risk	20/12/2012
DCM	M1133	Columbia Blood Agar Base w/ Hemin	Low risk	20/12/2012
DCM	MV144	Columbia Blood Agar Base, HiVeg™	Low risk	20/12/2012
DCM	MCD144	Columbia Blood HiCynth™ Agar Base	Low risk	12/08/2015
DCM	MCD144A	Columbia Blood HiCynth™ Agar Base w/1% Agar	Low risk	12/08/2015
DCM	M145	Columbia Broth Base	Low risk	20/12/2012
DCM	MV145	Columbia Broth Base, HiVeg™	Low risk	20/12/2012
DCM	M560	Columbia C.N.A. Agar Base	Low risk	20/12/2012
DCM	M560A	Columbia C.N.A. Agar Base w/ 1% Agar	Low risk	20/12/2012
DCM	MV560	Columbia C.N.A. HiVeg™ Agar Base	Low risk	20/12/2012
DCM	MV560A	Columbia C.N.A. HiVeg™ Agar Base w/ 1% Agar	Low risk	20/12/2012
DCM	MCD145	Columbia HiCynth™ Broth	Low risk	12/08/2015
DCM	M2103	Congo Red Magnesium Oxalate (CR-MOX) Agar	Low risk	22/04/2019
DCM	M730	Conn's Agar	Low risk	20/12/2012
DCM	M149	Cooked M Medium (R.C. Medium)	Low risk	16/12/2017
DCM	M1040	Cooked M Medium w/ Glucose, Hemin & Vitamin K	Low risk	16/12/2017
DCM	MV731	Corn Meal HiVeg™ Peptone Yeast Agar	Low risk	20/12/2012
DCM	M731	Corn Meal Peptone Yeast Agar	Low risk	20/12/2012
DCM	M1892	CTAS Agar Base (Carnobacterium Selective Agar Base)	Low risk	20/12/2012
DCM	M172	Cystine H Agar Base	Low risk	20/12/2012
DCM	MV172	Cystine HiVeg™ Agar Base	Low risk	20/12/2012
DCM	M881	Cystine Tellurite Agar Base	Low risk	20/12/2012
DCM	M160	D.C.L.S. Agar	Low risk	20/12/2012
DCM	M178	D.C.L.S. Agar, Hajna	Low risk	20/12/2012
DCM	MV160	D.C.L.S. HiVeg™ Agar	Low risk	20/12/2012
DCM	MV178	D.C.L.S. HiVeg™ Agar	Low risk	20/12/2012
DCM	M188	D.T.M. Agar Base (Dermatophyte Test Agar Base)	Low risk	20/12/2012
DCM	M501	Decarboxylase Agar Base	Low risk	20/12/2012
DCM	M393	Decarboxylase Broth Base, Moeller (Moeller Decarboxylase Broth Base)	Low risk	20/12/2012
DCM	MV501	Decarboxylase HiVeg™ Agar Base	Low risk	20/12/2012
DCM	MV393	Decarboxylase HiVeg™ Broth Base, Moeller (Moeller Decarboxylase HiVeg™ Broth Base)	Low risk	20/12/2012
DCM	M030	Deoxycholate Agar	Low risk	20/12/2012
DCM	MV030	Deoxycholate Agar, HiVeg™	Low risk	20/12/2012
DCM	M065	Deoxycholate Citrate Agar	Low risk	20/12/2012
DCM	M1639	Deoxycholate Citrate Agar w/1.5% Agar	Low risk	20/12/2012
DCM	M222	Deoxycholate Citrate Agar w/o Sucrose	Low risk	20/12/2012
DCM	MV065	Deoxycholate Citrate Agar, HiVeg™	Low risk	20/12/2012
DCM	MCD065	Deoxycholate Citrate HiCynth™ Agar	Low risk	12/08/2015
DCM	M084	Dextrose Agar	Low risk	20/12/2012
DCM	M286	Dextrose Agar Base, Emmons (Sabouraud Dextrose Agar Base, Modified)	Low risk	20/12/2012

DCM	MV084	Dextrose HiVeg™ Agar	Low risk	20/12/2012
DCM	MV286	Dextrose HiVeg™ Agar Base, Emmons (Sabouraud Dextrose HiVeg™ AgarBase, Modified)	Low risk	20/12/2012
DCM	M734	Dextrose Proteose Peptone Agar Base	Low risk	20/12/2012
DCM	MV734	Dextrose Proteose Peptone HiVeg™ Agar Base	Low risk	20/12/2012
DCM	M502	Diagnostic Sensitivity Test Agar (D.S.T. Agar)	Low risk	20/12/2012
DCM	M111	Diagnostic Stuart's Urea Broth Base (Urea Broth Base)	Low risk	20/12/2012
DCM	MV191	Diagnostic Thioglycollate HiVeg™ Medium (Thioglycollate HiVeg™ Medium w/o Indicator)	Low risk	20/12/2012
DCM	M191	Diagnostic Thioglycollate Medium (Thioglycollate Medium w/o Indicator)	Low risk	20/12/2012
DCM	M1129	Dichloran Glycerol Medium Base	Low risk	22/04/2019
DCM	M814	Differential Buffered Charcoal Yeast Extract Agar Base	Low risk	20/12/2012
DCM	M915	Dihydrolase Broth Base	Low risk	20/12/2012
DCM	MV915	Dihydrolase HiVeg™ Broth Base	Low risk	20/12/2012
DCM	MM1276	Dilute Sautans Medium (Twin Pack)	Low risk	20/12/2012
DCM	M882	Diphtheria Virulence Agar Base	Low risk	25/08/2016
DCM	M882R	Diphtheria Virulence Agar Base Modified	Low risk	25/08/2016
DCM	MV882	Diphtheria Virulence HiVeg™ Agar Base	Low risk	25/08/2016
DCM	M1984	Dixon's Agar	Low risk	20/12/2012
DCM	M057	Double Sugar Agar, Russell (Russell Double Sugar Agar)	Low risk	20/12/2012
DCM	MV057	Double Sugar HiVeg™ Agar (Russell Double Sugar HiVeg™ Agar)	Low risk	20/12/2012
DCM	M916	Doyle's Enrichment Broth Base	Low risk	20/12/2012
DCM	MV916	Doyle's Enrichment HiVeg™ Broth Base	Low risk	20/12/2012
DCM	M1378	Drigalski Lactose Agar, Modified	Low risk	20/12/2012
DCM	M1761	Drigalski Lactose Selective Agar	Low risk	20/12/2012
DCM	M659	Drigalski Litmus Lactose Agar	Low risk	20/12/2012
DCM	MV659	Drigalski Litmus Lactose HiVeg™ Agar	Low risk	20/12/2012
DCM	M5349	DTP Medium	Low risk	30/10/2018
DCM	M067	Dubos Broth Base	Low risk	20/12/2012
DCM	MV067	Dubos HiVeg™ Broth Base	Low risk	20/12/2012
DCM	M179	Dubos Oleic Agar Base	Low risk	20/12/2012
DCM	M839	Dubos Oleic Broth Base	Low risk	20/12/2012
DCM	MV179	Dubos Oleic HiVeg™ Agar Base	Low risk	20/12/2012
DCM	MV839	Dubos Oleic HiVeg™ Broth Base	Low risk	20/12/2012
DCM	M1536	Dulcitol Selenite Broth (Selenite-F Broth w/ Dulcitol) (Twin Pack)	Low risk	20/12/2012
DCM	M854	E.T. Medium	Low risk	20/12/2012
DCM	M1768	EC Blue Broth	Low risk	20/12/2012
DCM	MV1768	EC Blue HiVeg™ Broth	Low risk	20/12/2012
DCM	M127	EC Broth	Low risk	20/12/2012
DCM	M127I	EC Broth	Low risk	20/12/2012
DCM	MV127	EC HiVeg™ Broth	Low risk	20/12/2012

DCM	M748	Edward's Medium Base, Modified	Low risk	20/12/2012
DCM	MV748	Edward's Medium HiVeg™ Base, Modified	Low risk	20/12/2012
DCM	M294	Edwards and Bruner Semisolid Medium	Low risk	20/12/2012
DCM	M808	Egg Yolk Agar Base	Low risk	20/12/2012
DCM	MV808	Egg Yolk Agar Base, HiVeg™	Low risk	20/12/2012
DCM	M1043	Egg Yolk Agar Base, Modified	Low risk	20/12/2012
DCM	M086	Eijkman Lactose Broth	Low risk	20/12/2012
DCM	MV086	Eijkman Lactose HiVeg™ Broth	Low risk	20/12/2012
DCM	M317	EMB Agar	Low risk	20/12/2012
DCM	M301	EMB Agar Base	Low risk	20/12/2012
DCM	M022	EMB Agar, Levine	Low risk	20/12/2012
DCM	M022S	EMB Agar, Levine	Low risk	20/12/2012
DCM	M503	EMB Broth	Low risk	20/12/2012
DCM	MV317	EMB HiVeg™ Agar	Low risk	20/12/2012
DCM	MV022	EMB HiVeg™ Agar, Levine	Low risk	20/12/2012
DCM	MV503	EMB HiVeg™ Broth	Low risk	20/12/2012
DCM	M325	Emerson Agar	Low risk	20/12/2012
DCM	MV325	Emerson HiVeg™ Agar	Low risk	20/12/2012
DCM	M773	Emerson YSS Agar	Low risk	20/12/2012
DCM	M029	Endo Agar	Low risk	20/12/2012
DCM	M1077	Endo Agar Base	Low risk	20/12/2012
DCM	M1258	Endo Agar w/ NaCl	Low risk	20/12/2012
DCM	M1075	Endo Agar, Modified	Low risk	20/12/2012
DCM	M029R	Endo Agar, Special	Low risk	25/08/2016
DCM	MCD029	Endo HiCynth™ Agar	Low risk	12/08/2015
DCM	MV029	Endo HiVeg™ Agar	Low risk	20/12/2012
DCM	MV1077	Endo HiVeg™ Agar Base	Low risk	20/12/2012
DCM	MV1258	Endo HiVeg™ Agar w/ NaCl	Low risk	20/12/2012
DCM	MV1075	Endo HiVeg™ Agar, Modified	Low risk	20/12/2012
DCM	M738	Enriched Thioglycollate Broth	Low risk	20/12/2012
DCM	MV738	Enriched Thioglycollate HiVeg™ Broth	Low risk	20/12/2012
DCM	MV077	Entamoeba HiVeg™ Medium	Low risk	20/12/2012
DCM	M077	Entamoeba Medium	Low risk	20/12/2012
DCM	M1662	Enteric Fermentation Base	Low risk	20/12/2012
DCM	MH287	Enterobacteria Enrichment Broth, Mossel	Low risk	22/04/2019
DCM	M426	Ethyl Violet Azide Broth (E.V.A. Broth)	Low risk	20/12/2012
DCM	M426S	Ethyl Violet Azide Broth (E.V.A. Broth)	Low risk	20/12/2012
DCM	M1397	Ethyl Violet Azide Dextrose Agar	Low risk	20/12/2012
DCM	MV426	Ethyl Violet Azide HiVeg™ Broth (E.V.A. HiVeg™ Broth)	Low risk	20/12/2012
DCM	M428	Eugonic Agar	Low risk	20/12/2012
DCM	M429	Eugonic Broth	Low risk	20/12/2012

DCM	MV428	Eugonic HiVeg™ Agar	Low risk	20/12/2012
DCM	MV429	Eugonic HiVeg™ Broth	Low risk	20/12/2012
DCM	M1517	Eugonic LT 100 Broth Base w/o Tween 80	Low risk	20/12/2012
DCM	M811	Feeley Gorman Agar (F.G. Agar)	Low risk	20/12/2012
DCM	M812	Feeley Gorman Broth (F.G. Broth)	Low risk	20/12/2012
DCM	MV811	Feeley Gorman HiVeg™ Agar (F.G. HiVeg™ Agar)	Low risk	20/12/2012
DCM	MV812	Feeley Gorman HiVeg™ Broth (F.G. HiVeg™ Broth)	Low risk	20/12/2012
DCM	M827	Fermentation Medium for Staphylococcus and Micrococcus	Low risk	20/12/2012
DCM	MV919	Fermentation HiVeg™ Medium Base for C. perfringens	Low risk	20/12/2012
DCM	MV825	Fermentation HiVeg™ Medium for Neisseriae	Low risk	20/12/2012
DCM	MV827	Fermentation HiVeg™ Medium for Staphylococcus and Micrococcus	Low risk	20/12/2012
DCM	M919	Fermentation Medium Base for C. perfringens	Low risk	20/12/2012
DCM	M825	Fermentation Medium for Neisseriae	Low risk	20/12/2012
DCM	M1028	Field's Tryptic Digest Broth (Tryptic Digest Broth)	Low risk	20/12/2012
DCM	MV1028	Field's Tryptic digest Broth, HiVeg™ (Tryptic Digest Broth, HiVeg™)	Low risk	20/12/2012
DCM	MV239	Fletcher Leptospira HiVeg™ Medium Base (Leptospira HiVeg™ MediumBase, Fletcher)	Low risk	20/12/2012
DCM	M239	Fletcher Leptospira Medium Base (Leptospira Medium Base, Fletcher)	Low risk	20/12/2012
DCM	M1209	Fluconazole Testing Medium (Twin Pack)	Low risk	20/12/2012
DCM	MV013	Fluid Sabouraud HiVeg™ Medium (Sabouraud Medium, Fluid, HiVeg™)	Low risk	20/12/2012
DCM	M013	Fluid Sabouraud Medium (Sabouraud Medium, Fluid)	Low risk	20/12/2012
DCM	M1533I	Fluid Selenite Cystine Broth (Twin Pack)	Low risk	20/12/2012
DCM	MV025	Fluid Selenite Cystine HiVeg™ Medium (Selenite Cystine HiVeg™ Broth) (Twin Pack)	Low risk	20/12/2012
DCM	M025	Fluid Selenite Cystine Medium (Selenite Cystine Broth) (Twin Pack)	Low risk	20/12/2012
DCM	MM025	Fluid Selenite Cystine Medium (Twin Pack)	Low risk	20/12/2012
DCM	MU025	Fluid Selenite Cystine Medium (Twin Pack)	Low risk	20/12/2012
DCM	MCD032	Fluid Tetrathionate HiCynth™ Medium w/o Iodine and BG	Low risk	25/08/2016
DCM	MV032	Fluid Tetrathionate HiVeg™ Medium w/o Iodine and BG (Tetrathionate HiVeg™ Broth Base w/o Iodine & BG)	Low risk	20/12/2012
DCM	M032	Fluid Tetrathionate Medium w/o Iodine and BG (Tetrathionate Broth Base w/o Iodine and BG)	Low risk	20/12/2012
DCM	MV009	Fluid Thioglycollate HiVeg™ Medium	Low risk	22/04/2019
DCM	M009	Fluid Thioglycollate medium (Thioglycollate medium Fluid)	Low risk	22/04/2019
DCM	M543	Folic Acid Casei Medium	Low risk	20/12/2012
DCM	M2014	Folic Acid Casei Medium, Modified	Low risk	25/08/2016
DCM	M1050	Frey Mycoplasma Broth Base	Low risk	20/12/2012
DCM	M1073	GBS Medium Base	Low risk	28/04/2017
DCM	M434	GC Agar Base	Low risk	25/08/2016
DCM	MV434	GC HiVeg™ Agar Base	Low risk	04/07/2018

DCM	M5397	Gifu Anaerobic Broth w/o starch & dextrose	Low risk	22/04/2019
DCM	M2079	Gifu Anaerobic Broth, Modified (GAM)	Low risk	04/07/2018
DCM	M435	Glucose Citrate Broth Base	Low risk	20/12/2012
DCM	M433	Glucose Cysteine Agar Base w/ Thiamine	Low risk	20/12/2012
DCM	MV433	Glucose Cysteine HiVeg™ Agar Base w/ Thiamine	Low risk	20/12/2012
DCM	M070	Glucose Phosphate Broth (Buffered Glucose Broth)	Low risk	20/12/2012
DCM	MV070	Glucose Phosphate HiVeg™ Broth (Buffered Glucose HiVeg™ Broth)	Low risk	20/12/2012
DCM	M621	Glucose Salt Teepol Broth (Twin Pack)	Low risk	20/12/2012
DCM	MV621	Glucose Salt Teepol HiVeg™ Broth (Twin Pack)	Low risk	20/12/2012
DCM	M1935	Glycerol Mannitol Acetamide Cetrimide Agar	Low risk	20/12/2012
DCM	M242	GN Broth, Hajna	Low risk	20/12/2012
DCM	MV242	GN HiVeg™ Broth	Low risk	20/12/2012
DCM	M1888	Group A Streptococci Selective Agar (BETA-SSA Agar)	Low risk	20/12/2012
DCM	M1607	Gum Listeria Medium	Low risk	20/12/2012
DCM	M243	H Broth	Low risk	20/12/2012
DCM	MV116	H.S. Vaccine HiVeg™ Medium (Standard Nutrient HiVeg™ Broth)	Low risk	20/12/2012
DCM	M116	H.S. Vaccine Medium (Standard Nutrient Broth)	Low risk	20/12/2012
DCM	M1259	Haemophilus Test Agar Base	Low risk	20/12/2012
DCM	M551	Hartley's Digest Broth	Low risk	20/12/2012
DCM	MV551	Hartley's Digest HiVeg™ Broth	Low risk	20/12/2012
DCM	M467	Hektoen Enteric Agar	Low risk	20/12/2012
DCM	MU467	Hektoen Enteric Agar Medium	Low risk	20/12/2012
DCM	MCD467	Hektoen Enteric HiCynth™ Agar	Low risk	12/08/2015
DCM	MV467	Hektoen Enteric HiVeg™ Agar	Low risk	20/12/2012
DCM	M5390	Helicobacter Pylori Selective Agar	Low risk	30/10/2018
DCM	M1158	Hemorrhagic Coli (HC) Agar	Low risk	20/12/2012
DCM	M169	HI Agar	Low risk	20/12/2012
DCM	MV169	HI Agar, HiVeg™	Low risk	20/12/2012
DCM	M170	HI Broth	Low risk	20/12/2012
DCM	MV170	HI Broth, HiVeg™	Low risk	20/12/2012
DCM	M1832	HiCrome Coliform Agar Modified	Low risk	22/04/2019
DCM	MV1300	HiCrome Coliform HiVeg Agar w/ SLS	Low risk	22/04/2019
DCM	MV1295	HiCrome E. coli HiVeg™ Agar	Low risk	22/04/2019
DCM	MV1293	HiCrome ECC HiVeg™ Agar	Low risk	22/04/2019
DCM	MV1294	HiCrome ECC Selective HiVeg Agar Base	Low risk	22/04/2019
DCM	M1598	HiCrome Enrichment Broth Base for EC O157:H7	Low risk	22/04/2019
DCM	M1641	HiCrome Enterobacter sakazakii Agar, Modified	Low risk	22/04/2019
DCM	MV1577	HiCrome Enterobacter sakazakii HiVeg™ Agar	Low risk	22/04/2019
DCM	MV1641	HiCrome Enterobacter sakazakii HiVeg™ Agar, Modified	Low risk	22/04/2019
DCM	M1569	HiCrome M-Lauryl Sulphate Agar	Low risk	22/04/2019

DCM	M1862	HiCrome M-Modified ECO157:H7 Selective Agar Base	Low risk	22/04/2019
DCM	M1571	HiCrome M-TEC Agar	Low risk	22/04/2019
DCM	M1713	HiCrome M-TEC Broth	Low risk	22/04/2019
DCM	M1842	HiCrome Selective Salmonella Agar Base	Low risk	22/04/2019
DCM	MV1682	HiCrome Vibrio HiVeg™ Agar	Low risk	22/04/2019
DCM	M1651	HiCrome™ Bacillus Agar	Low risk	25/08/2016
DCM	MCD1651	HiCrome™ Bacillus HiCynth™ Agar	Low risk	25/08/2016
DCM	M1456AR	HiCrome™ Candida Differential Agar, Modified	Low risk	25/08/2016
DCM	MCD1297A	HiCrome™ Candida Differential HiCynth™ Agar	Low risk	12/08/2015
DCM	M1577	HiCrome™ Enterobacter sakazakii Agar	Low risk	22/04/2019
DCM	M1580	HiCrome™ Enterococcus faecium Agar Base	Low risk	25/08/2016
DCM	MCD1466	HiCrome™ Improved Salmonella HiCynth™ Agar	Low risk	12/08/2015
DCM	M1985	HiCrome™ Malassezia Agar	Low risk	20/12/2012
DCM	M1953R	HiCrome™ MeReSa Agar Base (Modified)	Low risk	25/08/2016
DCM	M1953	HiCrome™ MeReSa Agar Base (Modified)	Low risk	25/08/2016
DCM	M2010	HiCrome™ Mueller Hinton Agar	Low risk	25/08/2016
DCM	M1974	HiCrome™ Rapid MRSA Agar Base	Low risk	20/12/2012
DCM	M1353R	HiCrome™ UTI Agar	Low risk	25/08/2016
DCM	MCD1353	HiCrome™ UTI HiCynth™ Agar	Low risk	12/08/2015
DCM	MV1353R	HiCrome™ UTI HiVeg™ Agar	Low risk	25/08/2016
DCM	M1938	HiCrome™ Acinetobacter Agar Base	Low risk	20/12/2012
DCM	M1960	HiCrome™ Bifidobacterium Agar	Low risk	20/12/2012
DCM	M2020	HiCrome™ Campylobacter Agar Base	Low risk	16/12/2017
DCM	M1297A	HiCrome™ Candida Differential Agar	Low risk	20/12/2012
DCM	M1297AR	HiCrome™ Candida Differential Agar Base	Low risk	20/12/2012
DCM	M1456A	HiCrome™ Candida Differential Agar Base, Modified	Low risk	20/12/2012
DCM	MV1297A	HiCrome™ Candida Differential HiVeg™ Agar	Low risk	20/12/2012
DCM	MV1456A	HiCrome™ Candida Differential HiVeg™ Agar Base, Modified	Low risk	20/12/2012
DCM	M2099	HiCrome™ CarbaResist Agar Base	Low risk	22/04/2019
DCM	M1991I	HiCrome™ Chromogenic Coliform Agar (CCA)	Low risk	22/04/2019
DCM	M2026	HiCrome™ Clostridial Agar Base	Low risk	25/08/2016
DCM	M1300	HiCrome™ Coliform Agar w/ SLS	Low risk	22/04/2019
DCM	M2094	HiCrome™ Colistin Resistant Agar Base	Low risk	30/10/2018
DCM	M1295	HiCrome™ E. coli Agar	Low risk	22/04/2019
DCM	M1295I	HiCrome™ E. coli Agar	Low risk	22/04/2019
DCM	M1295	HiCrome™ E. coli Agar	Low risk	22/04/2019
DCM	MCD1295	HiCrome™ E.coli HiCynth™ Agar	Low risk	22/04/2019
DCM	MCD1580	HiCrome™ E.faecium HiCynth™ Agar Base	Low risk	25/08/2016
DCM	M1574A	HiCrome™ EC O157:H7 Agar, Modified	Low risk	22/04/2019
DCM	M1293	HiCrome™ ECC Agar	Low risk	22/04/2019

DCM	M1294	HiCrome™ ECC Selective Agar Base	Low risk	22/04/2019
DCM	M2056	HiCrome™ ECC Selective Agar Base, Modified	Low risk	22/04/2019
DCM	M1829	HiCrome™ ESBL Agar Base	Low risk	20/12/2012
DCM	M1466	HiCrome™ Improved Salmonella Agar	Low risk	20/12/2012
DCM	MV1466	HiCrome™ Improved Salmonella HiVeg™ Agar	Low risk	20/12/2012
DCM	M1831	HiCrome™ KPC Agar Base	Low risk	20/12/2012
DCM	M1340	HiCrome™ MacConkey Sorbitol Agar Base	Low risk	20/12/2012
DCM	MCD1340	HiCrome™ MacConkey Sorbitol HiCynth™ Agar	Low risk	25/08/2016
DCM	M2064	HiCrome™ m-Coliconfirm Broth Base	Low risk	22/04/2019
DCM	M1674	HiCrome™ MeReSa Agar Base	Low risk	20/12/2012
DCM	MCD1674	HiCrome™ MeReSa HiCynth™ Agar Base	Low risk	25/08/2016
DCM	MV1674	HiCrome™ MeReSa HiVeg™ Agar Base	Low risk	20/12/2012
DCM	M1393	HiCrome™ MM Agar	Low risk	20/12/2012
DCM	M1816	HiCrome™ MM Agar , Modified	Low risk	04/07/2018
DCM	M1816R	HiCrome™ MM Agar , Modified	Low risk	04/07/2018
DCM	MV1393	HiCrome™ MM HiVeg™ Agar	Low risk	20/12/2012
DCM	M1953	HiCrome™ MRSA Agar Base,Modified	Low risk	25/08/2016
DCM	M2067	HiCrome™ Mueller Hinton Agar (for antifungal)	Low risk	16/12/2017
DCM	MCD1633	HiCrome™ RajHans HiCynth™ Medium (Salmonella HiCynth™ Agar)	Low risk	25/08/2016
DCM	M1633	HiCrome™ RajHans Medium (Salmonella Agar)	Low risk	20/12/2012
DCM	M1634	HiCrome™ RajHans Medium, Modified (Salmonella Agar, Modified)	Low risk	20/12/2012
DCM	M2011	HiCrome™ Rapid ECC Broth	Low risk	22/04/2019
DCM	MCD1974	HiCrome™ Rapid MRSA HiCynth™ Agar Base	Low risk	25/08/2016
DCM	M1296	HiCrome™ Salmonella Agar	Low risk	20/12/2012
DCM	MV1296	HiCrome™ Salmonella HiVeg™ Agar	Low risk	20/12/2012
DCM	M1837	HiCrome™ Staph Agar Base, Modified	Low risk	20/12/2012
DCM	M2092	HiCrome™ STEC Agar Base	Low risk	30/10/2018
DCM	M1840	HiCrome™ Strep B Selective Agar Base	Low risk	04/07/2018
DCM	M1966	HiCrome™ Strep B Selective Agar Base, Modified	Low risk	20/12/2012
DCM	MCD1840	HiCrome™ Strep B Selective HiCynth™ Agar Base	Low risk	04/07/2018
DCM	M1600	HiCrome™ Universal Differential Medium	Low risk	20/12/2012
DCM	MCD1418	HiCrome™ UTI HiCynth™ Agar, Modified	Low risk	25/08/2016
DCM	M1353	HiCrome™ UTI Agar	Low risk	20/12/2012
DCM	M1353R	HiCrome™ UTI Agar	Low risk	20/12/2012
DCM	M1418	HiCrome™ UTI Agar, Modified	Low risk	20/12/2012
DCM	MV1353	HiCrome™ UTI HiVeg™ Agar	Low risk	20/12/2012
DCM	MV1418	HiCrome™ UTI HiVeg™ Agar, Modified	Low risk	20/12/2012
DCM	M1505	HiCrome™ UTI Selective Agar	Low risk	20/12/2012
DCM	MV1505	HiCrome™ UTI Selective HiVeg™ Agar	Low risk	20/12/2012
DCM	M1682	HiCrome™ Vibrio Agar	Low risk	22/04/2019

DCM	M1830	HiCrome™ VRE Agar Base	Low risk	20/12/2012
DCM	M1925	HiCrome™ VRE Agar Base, Modified	Low risk	20/12/2012
DCM	M2025	HiCrome™ Yersinia Agar Base	Low risk	25/08/2016
DCM	M1951	HiCrome™M-Coliform Differential Agar Base	Low risk	22/04/2019
DCM	M1469	HiFluoro Pseudomonas Agar Base	Low risk	20/12/2012
DCM	MV1469	HiFluoro Pseudomonas HiVeg™ Agar Base	Low risk	20/12/2012
DCM	M1218	High Salt Nutrient Agar	Low risk	20/12/2012
DCM	M1219	High Salt Peptone Yeast Extract Agar	Low risk	20/12/2012
DCM	M1054	Hippurate Hydrolysis Broth	Low risk	20/12/2012
DCM	M485	Hi-Sensitivity Test Agar	Low risk	20/12/2012
DCM	M486	Hi-Sensitivity Test Broth	Low risk	20/12/2012
DCM	MV485	Hi-Sensitivity Test HiVeg™ Agar	Low risk	20/12/2012
DCM	MV486	Hi-Sensitivity Test HiVeg™ Broth	Low risk	20/12/2012
DCM	M485A	HiSitest Agar	Low risk	20/12/2012
DCM	MV806	HiVeg™ Extract Agar	Low risk	20/12/2012
DCM	MV807	HiVeg™ Extract Broth	Low risk	20/12/2012
DCM	MV028	HiVeg™ Peptone Water	Low risk	20/12/2012
DCM	M806	HM Peptone B Agar	Low risk	20/12/2012
DCM	M807	HM Peptone B Broth	Low risk	20/12/2012
DCM	M924	Horie Arabinose Ethyl Violet Broth	Low risk	20/12/2012
DCM	M5385	Horse Blood agar	Low risk	30/10/2018
DCM	M1425	Hottinger Broth	Low risk	20/12/2012
DCM	MV015	Hoyle HiVeg™ Medium Base	Low risk	20/12/2012
DCM	M015	Hoyle Medium Base	Low risk	20/12/2012
DCM	MV871	Hugh Leifson Glucose HiVeg™ Medium	Low risk	20/12/2012
DCM	M871	Hugh Leifson Glucose Medium	Low risk	20/12/2012
DCM	MV826	Hugh Leifson HiVeg™ Medium	Low risk	20/12/2012
DCM	M826	Hugh Leifson Medium	Low risk	20/12/2012
DCM	M826S	Hugh Leifson Medium	Low risk	20/12/2012
DCM	MV364	Indole Nitrate HiVeg™ Medium (Tryptone Nitrate HiVeg™ Medium)	Low risk	20/12/2012
DCM	M364	Indole Nitrate Medium (Tryptone Nitrate Medium)	Low risk	20/12/2012
DCM	M574	Inositol Brilliant Green Bile Agar (Plesiomonas Differential Agar)	Low risk	20/12/2012
DCM	MV574	Inositol Brilliant Green HiVeg™ Agar (Plesiomonas Differential HiVeg™ Agar)	Low risk	20/12/2012
DCM	M248	KF Streptococcal Agar Base	Low risk	22/04/2019
DCM	M249	KF Streptococcal Broth Base	Low risk	20/12/2012
DCM	MV248	KF Streptococcal HiVeg™ Agar Base	Low risk	22/04/2019
DCM	MV248	KF Streptococcal HiVeg™ Agar Base	Low risk	22/04/2019
DCM	MV249	KF Streptococcal HiVeg™ Broth Base	Low risk	20/12/2012
DCM	M1007	KF Streptococcus Agar Base w/ BCP	Low risk	20/12/2012
DCM	M1021	KF Streptococcus Broth Base w/ BCP	Low risk	20/12/2012

DCM	MV1021	KF Streptococcus HiVeg™ Broth Base w/ BCP	Low risk	20/12/2012
DCM	M1232	Kimmig Fungi Agar Base	Low risk	20/12/2012
DCM	MV1232	Kimmig Fungi HiVeg™ Agar Base	Low risk	20/12/2012
DCM	M1543	King's Medium A Base	Low risk	20/12/2012
DCM	M1235	King's OF Medium Base	Low risk	20/12/2012
DCM	MV1235	Kings OF Medium Base, HiVeg™	Low risk	20/12/2012
DCM	M2040	Kirchner Medium Base	Low risk	28/04/2017
DCM	M161	Kirchner Medium Base, Modified	Low risk	20/12/2012
DCM	M078	Kligler Iron Agar	Low risk	20/12/2012
DCM	M078I	Kligler Iron Agar	Low risk	20/12/2012
DCM	M078A	Kligler Iron Agar, Modified	Low risk	20/12/2012
DCM	MCD078	Kligler Iron HiCynth™ Agar	Low risk	12/08/2015
DCM	MV078	Kligler Iron HiVeg™ Agar	Low risk	20/12/2012
DCM	MV142	Kohn Two Tube HiVeg™ Medium No.1 Base	Low risk	20/12/2012
DCM	MV802	Kohn Two Tube HiVeg™ Medium No.2	Low risk	20/12/2012
DCM	M142	Kohn Two Tube Medium No.1 Base	Low risk	20/12/2012
DCM	M802	Kohn Two Tube Medium No.2	Low risk	20/12/2012
DCM	M069	Koser Citrate Medium	Low risk	20/12/2012
DCM	MV171	Kracke Blood Culture HiVeg™ Medium	Low risk	20/12/2012
DCM	M171	Kracke Blood Culture Medium	Low risk	20/12/2012
DCM	M305	Kupferberg Trichomonas Broth Base (Trichomonas Broth Base, Kupferberg)	Low risk	20/12/2012
DCM	MV305	Kupferberg Trichomonas HiVeg™ Broth Base	Low risk	20/12/2012
DCM	M928	L Broth	Low risk	20/12/2012
DCM	M1312	L Broth, Modified	Low risk	20/12/2012
DCM	M162R	L J Medium Base, Modified	Low risk	25/08/2016
DCM	M1552	L. mono Confirmatory Agar Base	Low risk	20/12/2012
DCM	MV1552	L. mono Confirmatory HiVeg™ Agar Base	Low risk	20/12/2012
DCM	M1540	L.mono Differential Agar Base	Low risk	22/04/2019
DCM	MCD1540	L.mono Differential HiCynth™ Agar Base	Low risk	22/04/2019
DCM	MV1540	L.mono Differential HiVeg™ Agar Base	Low risk	22/04/2019
DCM	M742	L.D. Agar	Low risk	20/12/2012
DCM	M744	L.D. Egg Yolk Agar Base	Low risk	20/12/2012
DCM	M743	L.D. Esculin Agar	Low risk	20/12/2012
DCM	MV743	L.D. Esculin HiVeg™ Agar	Low risk	20/12/2012
DCM	MV742	L.D. HiVeg™ Agar	Low risk	20/12/2012
DCM	M926	Lactic Streak Agar (Reddy's Differential Agar, Modified)	Low risk	20/12/2012
DCM	MV926	Lactic Streak HiVeg™ Agar	Low risk	20/12/2012
DCM	MV368	Lactobacilli HiVeg™ Broth	Low risk	20/12/2012
DCM	M927	Lactobacillus Bulgaricus Agar Base	Low risk	20/12/2012
DCM	MV927	Lactobacillus Bulgaricus HiVeg™ Agar Base	Low risk	20/12/2012

DCM	M641	Lactobacillus MRS Agar (MRS Agar)	Low risk	20/12/2012
DCM	M641I	Lactobacillus MRS Agar (MRS Agar)	Low risk	20/12/2012
DCM	M369	Lactobacillus MRS Broth (MRS Broth)	Low risk	20/12/2012
DCM	MV641	Lactobacillus MRS HiVeg™ Agar (MRS HiVeg™ Agar)	Low risk	20/12/2012
DCM	MV369	Lactobacillus MRS HiVeg™ Broth (MRS HiVeg™ Broth)	Low risk	20/12/2012
DCM	M1165	Lactobacillus Selection Bile Agar Base (LBS Bile Agar)	Low risk	20/12/2012
DCM	M1081	Lactose Blue Agar (B.T.B. Lactose Agar, Modified)	Low risk	20/12/2012
DCM	MV1081	Lactose Blue HiVeg™ Agar (B.T.B. Lactose HiVeg™ Agar, Modified)	Low risk	20/12/2012
DCM	M1003	Lactose Broth	Low risk	22/04/2019
DCM	MV1003	Lactose HiVeg™ Broth	Low risk	22/04/2019
DCM	M1047	Lactose Lecithin Agar	Low risk	04/07/2018
DCM	M080	Lauryl Sulphate Broth (Lauryl Tryptose Broth)	Low risk	22/04/2019
DCM	MV080	Lauryl SulphateHiVeg™ Broth (Lauryl Tryptose HiVeg™ Broth)	Low risk	22/04/2019
DCM	M1839	Leeds Acinetobacter Agar Base	Low risk	20/12/2012
DCM	M1938R	Leeds Acinetobacter Agar Base (HiCrome™ Acinetobacter Agar Base)	Low risk	25/08/2016
DCM	M1380	Leifson Agar	Low risk	20/12/2012
DCM	MV1380	Leifson HiVeg™ Agar	Low risk	20/12/2012
DCM	M1138	Leifson's Deoxycholate Agar, Modified	Low risk	20/12/2012
DCM	MV1138	Leifson's Deoxycholate HiVeg™ Agar, Modified	Low risk	20/12/2012
DCM	MV239	Leptospira HiVeg™ Medium Base, Fletcher	Low risk	20/12/2012
DCM	MV457	Leptospira HiVeg™ Medium Base, Korthof, Modified	Low risk	20/12/2012
DCM	M1009	Leptospira Medium Base	Low risk	20/12/2012
DCM	M239	Leptospira Medium Base, Fletcher	Low risk	20/12/2012
DCM	M457	Leptospira Medium Base, Korthof, Modified	Low risk	20/12/2012
DCM	MV472	Levinthal's HiVeg™ Medium Base	Low risk	20/12/2012
DCM	M472	Levinthal's Medium Base	Low risk	20/12/2012
DCM	M374	LI Agar	Low risk	20/12/2012
DCM	MV374	LI Agar, HiVeg™	Low risk	20/12/2012
DCM	M153	LI Broth	Low risk	20/12/2012
DCM	MV153	LI Broth, HiVeg™	Low risk	20/12/2012
DCM	M627	Lipovitellin Salt Mannitol Agar Base	Low risk	20/12/2012
DCM	M817	Liquoid Broth	Low risk	20/12/2012
DCM	MV817	Liquoid HiVeg™ Broth	Low risk	20/12/2012
DCM	M569	Listeria Enrichment Broth (Twin Pack)	Low risk	20/12/2012
DCM	MV569	Listeria Enrichment HiVeg™ Broth (Twin Pack)	Low risk	20/12/2012
DCM	MV890A	Listeria Enrichment HiVeg™ Medium Base (UVM)	Low risk	20/12/2012
DCM	M890A	Listeria Enrichment Medium Base (UVM)	Low risk	20/12/2012
DCM	M1064	Listeria Identification Agar Base (PALCAM)	Low risk	22/04/2019
DCM	M1090	Listeria Identification Broth Base (PALCAM)	Low risk	22/04/2019
DCM	MV1064	Listeria Identification HiVeg Agar Base (PALCAM)	Low risk	22/04/2019
DCM	MV1090	Listeria Identification HiVeg Broth Base (PALCAM)	Low risk	22/04/2019

DCM	MCD1145	Listeria Oxford HiCynth™ Medium Base	Low risk	25/08/2016
DCM	MV1145	Listeria Oxford HiVeg™ Medium Base	Low risk	20/12/2012
DCM	M1145R	Listeria Oxford Medium Base	Low risk	25/08/2016
DCM	M1145	Listeria Oxford Medium Base	Low risk	20/12/2012
DCM	M1781	Listeria Oxford Medium Base, Modified	Low risk	20/12/2012
DCM	M567	Listeria Selective Agar (Twin Pack)	Low risk	20/12/2012
DCM	M1474	Listeria Selective Agar Base	Low risk	20/12/2012
DCM	M889	Listeria Selective Broth Base	Low risk	20/12/2012
DCM	M1865	Listeria Selective Enrichment Broth	Low risk	22/04/2019
DCM	MV567	Listeria Selective HiVeg™ Agar (Twin Pack)	Low risk	20/12/2012
DCM	MV889	Listeria Selective HiVeg™ Broth Base	Low risk	20/12/2012
DCM	M373	Littman Bile Agar Base	Low risk	20/12/2012
DCM	M663	Littman Bile Broth Base	Low risk	20/12/2012
DCM	MV373	Littman HiVeg™ Agar Base	Low risk	20/12/2012
DCM	MV663	Littman HiVeg™ Broth Base	Low risk	20/12/2012
DCM	M1001	LM Agar	Low risk	20/12/2012
DCM	M1934	LM Agar, Modified	Low risk	20/12/2012
DCM	MV537	Loeffler HiVeg™ Medium Base	Low risk	20/12/2012
DCM	M537	Loeffler Medium Base	Low risk	20/12/2012
DCM	M1189	Loeffler Serum Medium Base	Low risk	20/12/2012
DCM	MM162	Lowenstein - Jensen Medium (L.J. Medium) (Twin Pack)	Low risk	20/12/2012
DCM	M162R	Lowenstein Jensen Medium Base Modified	Low risk	25/08/2016
DCM	M162	Lowenstein Jensen Medium Base (L.J. Medium)	Low risk	20/12/2012
DCM	M1542	Lowenstein Jensen Medium Base w/o Starch	Low risk	20/12/2012
DCM	M2032	Lowenstein Jensen Medium Base, Modified	Low risk	25/08/2016
DCM	MH081	MacConkey Agar	Low risk	22/04/2019
DCM	M1024	MacConkey Agar Base	Low risk	20/12/2012
DCM	M1819	MacConkey Agar II w/o CV	Low risk	20/12/2012
DCM	M008E	MacConkey Agar Medium	Low risk	20/12/2012
DCM	M081	MacConkey Agar w/ 0.15% Bile Salts, CV and NaCl	Low risk	20/12/2012
DCM	M061	MacConkey Agar w/ Bromo Thymol Blue	Low risk	20/12/2012
DCM	M1582	MacConkey Agar w/ CV and w/o NaCl	Low risk	20/12/2012
DCM	M081A	MacConkey Agar w/ CV, NaCl, and 0.15% Bile Salts	Low risk	20/12/2012
DCM	M008	MacConkey Agar w/o CV w/ 0.15% Bile Salts	Low risk	20/12/2012
DCM	M082A	MacConkey Agar w/o CV, NaCl w/ 0.5% Bile Salts	Low risk	20/12/2012
DCM	M082	MacConkey Agar w/o CV, NaCl w/ 0.5% Sodium Taurocholate	Low risk	20/12/2012
DCM	M008A	MacConkey Agar w/o CV, w/ 0.5% Bile Salts	Low risk	20/12/2012
DCM	M008B	MacConkey Agar w/o CV, w/ 1.2% Agar	Low risk	20/12/2012
DCM	M1785	MacConkey Agar w/o CV, w/0.5% Sodium Taurocholate	Low risk	20/12/2012
DCM	M1702	MacConkey Agar, RS	Low risk	20/12/2012

DCM	MH083	MacConkey Broth	Low risk	22/04/2019
DCM	M083	MacConkey Broth Purple w/BCP	Low risk	22/04/2019
DCM	MCD081	MacConkey HiCynth™ Agar w/ 0.15% Bile Salts	Low risk	25/08/2016
DCM	MCD082	MacConkey HiCynth™ Agar w/o CV, NaCl	Low risk	25/08/2016
DCM	MV1024	MacConkey HiVeg™ Agar Base	Low risk	20/12/2012
DCM	MV061	MacConkey HiVeg™ Agar w/ Bromo Thymol Blue	Low risk	20/12/2012
DCM	MV081	MacConkey HiVeg™ Agar w/ CV, NaCl, 0.003% NR and 1.5% Agar	Low risk	20/12/2012
DCM	MV081A	MacConkey HiVeg™ Agar w/ CV, NaCl, 0.005% NR and 1.5% Agar	Low risk	20/12/2012
DCM	MV082	MacConkey HiVeg™ Agar w/o CV and NaCl, w/ 0.004% NR and 2.0% Agar	Low risk	20/12/2012
DCM	MV082A	MacConkey HiVeg™ Agar w/o CV and NaCl, w/ 0.0075% NR and 1.2% Agar	Low risk	20/12/2012
DCM	MV008B	MacConkey HiVeg™ Agar w/o CV, w/ 0.003% NR and 1.2% Agar	Low risk	20/12/2012
DCM	MV008	MacConkey HiVeg™ Agar w/o CV, w/ 0.003% NR and 1.5% Agar	Low risk	20/12/2012
DCM	MV008A	MacConkey HiVeg™ Agar w/o CV, w/ 0.0075% NR and 1.2% Agar	Low risk	20/12/2012
DCM	MV083	MacConkey HiVeg™ Broth Purple w/ BCP	Low risk	22/04/2019
DCM	M298	MacConkey Sorbitol Agar	Low risk	20/12/2012
DCM	M298I	MacConkey Sorbitol Agar Base	Low risk	20/12/2012
DCM	M1727R	MacConkey Sorbitol Agar Base (w/ Rhamnose)	Low risk	25/08/2016
DCM	M1727	MacConkey Sorbitol Agar Base w/ Rhamnose	Low risk	20/12/2012
DCM	MCD298	MacConkey Sorbitol HiCynth™ Agar (Sorbitol HiCynth™ Agar)	Low risk	28/04/2017
DCM	MV298	MacConkey Sorbitol HiVeg™ Agar	Low risk	20/12/2012
DCM	M2074	MacConkey Sorbitol Rhamnose Selective Agar Base	Low risk	16/12/2017
DCM	M382	Malonate Broth	Low risk	25/08/2016
DCM	M137	Malt Extract Agar Base (w/ Mycological Peptone)	Low risk	20/12/2012
DCM	M995	Malt Extract Agar Base, Modified as per Thom and Church	Low risk	20/12/2012
DCM	M255	Malt Extract Broth Base	Low risk	20/12/2012
DCM	M1128	Malt Extract Broth, Modified as per Thom and Church	Low risk	20/12/2012
DCM	MV137	Malt Extract HiVeg™ Agar Base	Low risk	20/12/2012
DCM	MV995	Malt Extract HiVeg™ Agar Base, Modified	Low risk	20/12/2012
DCM	MV255	Malt Extract HiVeg™ Broth Base	Low risk	20/12/2012
DCM	M1967	Malt Yeast Agar	Low risk	20/12/2012
DCM	M1624	Mannitol Agar w/Prilion	Low risk	20/12/2012
DCM	M1071	Mannitol Lysine Agar	Low risk	20/12/2012
DCM	MCD1071	Mannitol Lysine HiCynth™ Agar	Low risk	25/08/2016
DCM	M1320	Mannitol Motility Nitrate Medium	Low risk	20/12/2012
DCM	MV770	Mannitol Motility Test HiVeg™ Medium	Low risk	20/12/2012
DCM	M770	Mannitol Motility Test Medium	Low risk	20/12/2012
DCM	MH118	Mannitol Salt Agar	Low risk	22/04/2019

DCM	M118	Mannitol Salt Agar Base	Low risk	20/12/2012
DCM	M383	Mannitol Salt Broth	Low risk	20/12/2012
DCM	MCD118	Mannitol Salt HiCynth™ Agar Base	Low risk	12/08/2015
DCM	MV118	Mannitol Salt HiVeg™ Agar Base	Low risk	20/12/2012
DCM	MV383	Mannitol Salt HiVeg™ Broth	Low risk	20/12/2012
DCM	M1534	Mannitol Selenite Broth (Selenite Mannitol Broth) (Twin Pack)	Low risk	20/12/2012
DCM	M1537	Mannitol Selenite Broth w/Brilliant Green (Twin Pack)	Low risk	04/07/2018
DCM	MV379	Marine Oxidation Fermentation HiVeg™ Medium	Low risk	20/12/2012
DCM	M379	Marine Oxidation Fermentation Medium	Low risk	20/12/2012
DCM	M2085	Martin Lewis Agar Base	Low risk	22/04/2019
DCM	M1030	Maximum Recovery Diluent	Low risk	22/04/2019
DCM	MV1030	Maximum Recovery Diluent HiVeg™	Low risk	22/04/2019
DCM	M386	McBride Listeria Agar Base	Low risk	20/12/2012
DCM	MV386	McBride Listeria HiVeg™ Agar Base	Low risk	20/12/2012
DCM	M1426	M-E.coli Broth	Low risk	22/04/2019
DCM	M1594	MeReSa Agar Base	Low risk	20/12/2012
DCM	M1974R	MeReSa Agar Base (HiCrome™ Rapid MRSA Agar)	Low risk	25/08/2016
DCM	M199	Middlebrook 7H10 Agar Base	Low risk	20/12/2012
DCM	M196	Middlebrook 7H10 Agar Base, Special	Low risk	20/12/2012
DCM	M511	Middlebrook 7H11 Agar Base	Low risk	20/12/2012
DCM	M511A	Middlebrook 7H11 Agar Base w/o Malachite Green	Low risk	20/12/2012
DCM	MV511	Middlebrook 7H11 HiVeg™ Agar Base	Low risk	20/12/2012
DCM	M197	Middlebrook 7H9 Agar Base	Low risk	20/12/2012
DCM	M198	Middlebrook 7H9 Broth Base	Low risk	20/12/2012
DCM	M259	Mitis Salivarius Agar Base	Low risk	20/12/2012
DCM	MV259	Mitis Salivarius HiVeg™ Agar Base	Low risk	20/12/2012
DCM	M5319	Modified B.Q. Vaccine Medium	Low risk	28/04/2017
DCM	M1150	Modified Bile Esculin Azide Agar	Low risk	20/12/2012
DCM	M892	Modified Buffered Charcoal Agar Base	Low risk	20/12/2012
DCM	MV892	Modified Buffered Charcoal HiVeg™ Agar Base	Low risk	20/12/2012
DCM	M1660	Modified Cary-Blair Medium	Low risk	20/12/2012
DCM	MV460	Modified CPLM HiVeg™ Medium Base (Trichomonas Modified CPLM HiVeg™ Medium Base)	Low risk	20/12/2012
DCM	M460	Modified CPLM Medium Base (Trichomonas Modified CPLM Medium Base)	Low risk	20/12/2012
DCM	M1170	Modified Czapek Dox Agar	Low risk	20/12/2012
DCM	M1285	Modified EC Broth Base	Low risk	20/12/2012
DCM	M1445	Modified Lactobacillus Agar	Low risk	20/12/2012
DCM	M1643	Modified Lauryl Sulphate Tryptose Broth Base	Low risk	20/12/2012
DCM	M1457R	Modified Listeria Lecithinase Agar Base	Low risk	25/08/2016
DCM	M1897	Modified Listeria Oxford Agar Base	Low risk	25/11/2017
DCM	M891	Modified McBride Listeria Agar Base	Low risk	20/12/2012

DCM	MV891	Modified McBride Listeria HiVeg™™ Agar Base	Low risk	20/12/2012
DCM	M1139	Modified MYP Agar Base	Low risk	20/12/2012
DCM	MV1139	Modified MYP HiVeg™ Agar Base	Low risk	20/12/2012
DCM	M1606	Modified Protease Agar	Low risk	20/12/2012
DCM	M1681	Modified Sabourauds Chloramphenicol Agar	Low risk	20/12/2012
DCM	M1068	Modified Salt Broth	Low risk	20/12/2012
DCM	M2049	Modified Shieh Agar (LMG Medium 215)	Low risk	28/04/2017
DCM	M1286I	Modified Soyabean Bile Broth Base	Low risk	22/04/2019
DCM	M795	Modified Thayer Martin Medium Base (w/o Supplement)	Low risk	20/12/2012
DCM	M393	Moeller Decarboxylase Broth Base	Low risk	25/08/2016
DCM	MCD393	Moeller Decarboxylase HiCynth™ Broth Bas	Low risk	25/08/2016
DCM	M246	Mold Inhibitory Agar, Ulrich	Low risk	20/12/2012
DCM	M474	Monsur Medium Base	Low risk	20/12/2012
DCM	M1864	MSM Broth Base	Low risk	20/12/2012
DCM	M173	Mueller Hinton Agar	Low risk	20/12/2012
DCM	M1825	Mueller Hinton Agar 2% Glucose w/ Methylene blue	Low risk	20/12/2012
DCM	M1825R	Mueller Hinton Agar Modified (As per CLSI)	Low risk	25/08/2016
DCM	M1084	Mueller Hinton Agar No. 2	Low risk	20/12/2012
DCM	M5389	Mueller Hinton Agar w/ 2% NaCL	Low risk	30/10/2018
DCM	M391	Mueller Hinton Broth	Low risk	20/12/2012
DCM	M1657	Mueller Hinton Broth No. 2 Control Cations	Low risk	20/12/2012
DCM	MV173	Mueller Hinton HiVeg™ Agar	Low risk	20/12/2012
DCM	MV1084	Mueller Hinton HiVeg™ Agar No. 2	Low risk	20/12/2012
DCM	MV391	Mueller Hinton HiVeg™ Broth	Low risk	20/12/2012
DCM	M1202	Mueller Tellurite Agar Base	Low risk	20/12/2012
DCM	M1373	MUG EC O157 Agar	Low risk	16/12/2017
DCM	M1429	MUG EC O157 Agar, Modified	Low risk	20/12/2012
DCM	M1080	MUG MacConkey Agar	Low risk	20/12/2012
DCM	MV1080	MUG MacConkey HiVeg™ Agar	Low risk	20/12/2012
DCM	M1205	MUG Sorbitol Agar	Low risk	20/12/2012
DCM	M977	Mutans-Sanguis Agar	Low risk	20/12/2012
DCM	M094	Mycological Agar	Low risk	20/12/2012
DCM	M095	Mycological Agar w/ Low pH	Low risk	20/12/2012
DCM	M1422	Mycological Agar, Modified	Low risk	20/12/2012
DCM	M264	Mycological Broth	Low risk	20/12/2012
DCM	M265	Mycological Broth w/ Low pH	Low risk	20/12/2012
DCM	M266	Mycoplasma Agar Base (PPLO Agar Base)	Low risk	20/12/2012
DCM	M268	Mycoplasma Broth Base w/ CV (PPLO Broth Base w/ CV)	Low risk	20/12/2012
DCM	M267	Mycoplasma Broth Base w/o CV (PPLO Broth Base w/o CV)	Low risk	20/12/2012
DCM	M1498	Mycoplasma Cultivation Broth Base	Low risk	20/12/2012

DCM	MV266	Mycoplasma HiVeg™ Agar Base (PPLO HiVeg™ Agar Base)	Low risk	20/12/2012
DCM	MV268	Mycoplasma HiVeg™ Broth Base w/ CV (PPLO HiVeg™ Broth Base w/ CV)	Low risk	20/12/2012
DCM	MV267	Mycoplasma HiVeg™ Broth Base w/o CV (PPLO HiVeg™ Broth Base w/o CV)	Low risk	20/12/2012
DCM	MV624	Mycoplasma Synoviae HiVeg™ Medium Base	Low risk	20/12/2012
DCM	M624	Mycoplasma Synoviae Medium Base	Low risk	20/12/2012
DCM	M1374	Mycoplasma Urogenital Broth Base (Urogenital Mycoplasma Broth Base)	Low risk	20/12/2012
DCM	M636	MYP Agar Base (Phenol Red Egg Yolk Polymyxin Agar Base)	Low risk	20/12/2012
DCM	MCD636	MYP HiCynth™ Agar Base (Phenol Red Egg Yolk Polymyxin HiCynth™ Agar Base)	Low risk	28/04/2017
DCM	MV636	MYP HiVeg™ Agar Base (Phenol Red Polymyxin HiVeg™ Agar Base)	Low risk	20/12/2012
DCM	MV217	Nickerson HiVeg™ Medium (Bi.G.G.Y. HiVeg™ Agar)	Low risk	20/12/2012
DCM	M217	Nickerson Medium	Low risk	20/12/2012
DCM	M001	Nutrient Agar	Low risk	20/12/2012
DCM	M001A	Nutrient Agar	Low risk	20/12/2012
DCM	M087	Nutrient Agar 1.5%	Low risk	20/12/2012
DCM	M1269	Nutrient Agar No.2	Low risk	20/12/2012
DCM	M012	Nutrient Agar w/ 1% Peptone	Low risk	20/12/2012
DCM	M561	Nutrient Agar, pH 6.8	Low risk	20/12/2012
DCM	M002	Nutrient Broth	Low risk	20/12/2012
DCM	M1362	Nutrient Broth No. 2	Low risk	20/12/2012
DCM	M1902	Nutrient Broth No.3	Low risk	20/12/2012
DCM	M060	Nutrient Gelatin	Low risk	20/12/2012
DCM	MCD001	Nutrient HiCynth™ Agar	Low risk	12/08/2015
DCM	MCD002	Nutrient HiCynth™ Broth	Low risk	12/08/2015
DCM	MV001	Nutrient HiVeg™ Agar	Low risk	20/12/2012
DCM	MV087	Nutrient HiVeg™ Agar 1.5%	Low risk	20/12/2012
DCM	MV1269	Nutrient HiVeg™ Agar No.2	Low risk	20/12/2012
DCM	MV012	Nutrient HiVeg™ Agar w/ 1% HiVeg™ Peptone	Low risk	20/12/2012
DCM	MV561	Nutrient HiVeg™ Agar, pH 6.8	Low risk	20/12/2012
DCM	MV002	Nutrient HiVeg™ Broth	Low risk	20/12/2012
DCM	M1348	NYC Agar Base	Low risk	20/12/2012
DCM	MCD395	OF Basal HiCynth™ Medium	Low risk	25/08/2016
DCM	MV395	OF Basal HiVeg™ Medium	Low risk	20/12/2012
DCM	M395	OF Basal Medium	Low risk	20/12/2012
DCM	M1811	OF PBL Agar Base (Oxidation Fermentation Polymyxin Bacitracin Lactose Agar Base)	Low risk	20/12/2012
DCM	M1930	ONPG BROTH	Low risk	20/12/2012
DCM	M933	Orange Serum Agar	Low risk	22/04/2019
DCM	MV933	Orange SerumHiVeg™ Agar	Low risk	22/04/2019

DCM	M1454	Oxacillin Resistance Screening Agar Base	Low risk	20/12/2012
DCM	M1390	Pagano Levin Base	Low risk	20/12/2012
DCM	M867	Peizer TB Medium Base	Low risk	20/12/2012
DCM	M1207	Pepted M Broth	Low risk	20/12/2012
DCM	M028	Peptone Water	Low risk	20/12/2012
DCM	MCD837	Perfringens HiCynth™ Agar Base (T.S.C/S.F.P HiCynth™ Agar Base)	Low risk	28/04/2017
DCM	MV837	Perfringens HiVeg™ Agar Base (T.S.C/S.F.P HiCynth™ Agar Base)	Low risk	28/04/2017
DCM	M269A	Phenylethanol Agar Base	Low risk	20/12/2012
DCM	M269	Phenylethyl Alcohol Agar Base	Low risk	20/12/2012
DCM	MV269	Phenylethyl Alcohol HiVeg™ Agar Base	Low risk	20/12/2012
DCM	M540	Phenylethyl Blood Agar Base (Anaerobic)	Low risk	20/12/2012
DCM	M1866	Phosphate Buffered Saline (PBS) pH 7.4	Low risk	22/04/2019
DCM	M519	Pike Streptococcal Broth Base	Low risk	20/12/2012
DCM	MV519	Pike Streptococcal HiVeg™ Broth Base	Low risk	20/12/2012
DCM	M282	PKU Test Agar Base	Low risk	20/12/2012
DCM	M398	PKU Test Agar w/ Thienylalanine	Low risk	20/12/2012
DCM	M091	Plate Count Agar (Standard Methods Agar)	Low risk	28/04/2017
DCM	MCD091	Plate Count HiCynth™ Agar (Standard Methods HiCynth™ Agar)	Low risk	28/04/2017
DCM	MV091	Plate Count HiVeg™ Agar (Standard Methods HiVeg™ Agar)	Low risk	28/04/2017
DCM	M574	Plesiomonas Differential Agar	Low risk	20/12/2012
DCM	MV574	Plesiomonas Differential HiVeg™ Agar	Low risk	20/12/2012
DCM	M1446	PLET Agar Base	Low risk	20/12/2012
DCM	M1451	PLET Agar Base, Modified	Low risk	20/12/2012
DCM	M835	PNY Medium	Low risk	20/12/2012
DCM	MH096	Potato Dextrose Agar	Low risk	22/04/2019
DCM	M096	Potato Dextrose Agar	Low risk	22/04/2019
DCM	M5391	PPLO Agar Base	Low risk	30/10/2018
DCM	M1586	PPLO Modified Broth Base w/o CV	Low risk	20/12/2012
DCM	M899	Preston Enrichment Broth Base	Low risk	20/12/2012
DCM	MV899	Preston Enrichment HiVeg™ Broth Base	Low risk	20/12/2012
DCM	M956	Propionibacter Isolation Agar Base	Low risk	20/12/2012
DCM	M1697	Proskauer Beck medium	Low risk	20/12/2012
DCM	M085	Pseudomonas Agar Base	Low risk	22/04/2019
DCM	M085	Pseudomonas Agar Base	Low risk	22/04/2019
DCM	MV085	Pseudomonas HiVeg™ Agar Base	Low risk	22/04/2019
DCM	M406	Pseudomonas Isolation Agar Base	Low risk	20/12/2012
DCM	MCD406	Pseudomonas Isolation HiCynth™ Agar	Low risk	25/08/2016
DCM	MV406	Pseudomonas Isolation HiVeg™ Agar Base	Low risk	20/12/2012
DCM	M1743	RZA Agar, Modified	Low risk	22/04/2019

DCM	MV1078	RajHans HiVeg™ Medium (Twin Pack)	Low risk	20/12/2012
DCM	M1078	RajHans Medium (Twin Pack)	Low risk	20/12/2012
DCM	M1453A	Rapid HiColiform Broth w/Tryptophan	Low risk	22/04/2019
DCM	MCD1491	Rappaport Vassiliadis HiCynth™ Broth	Low risk	12/08/2015
DCM	M1530	Rappaport Vassiliadis R10 Medium	Low risk	20/12/2012
DCM	MH1491	Rappaport Vassiliadis Salmonella Enrichment Broth	Low risk	22/04/2019
DCM	M1491	Rappaport Vassiliadis Soya Broth (RVS Broth)	Low risk	20/12/2012
DCM	MCD1491	Rappaport Vassiliadis Soya HiCynth™ Broth	Low risk	25/08/2016
DCM	M1448	Rappaport Vassiliadis Soyabean Meal Broth (RVSM)	Low risk	20/12/2012
DCM	MH443	Reinforced Medium for Clostridia	Low risk	22/04/2019
DCM	M1626	Reuter's Sorbic Acid Agar Base	Low risk	20/12/2012
DCM	M459	Robinson Medium for Entamoeba (Twin Pack)	Low risk	20/12/2012
DCM	M149	Robinson's Cooked M Medium (R.C. Medium)	Low risk	16/12/2017
DCM	M1899	Rogosa Agar, Modified	Low risk	20/12/2012
DCM	M130	Rogosa SL Agar	Low risk	20/12/2012
DCM	M958	Rogosa SL Agar w/ 0.15% Bile	Low risk	20/12/2012
DCM	M407	Rogosa SL Broth	Low risk	20/12/2012
DCM	MCD130	Rogosa SL HiCynth™ Agar	Low risk	28/04/2017
DCM	MV130	Rogosa SL HiVeg™ Agar	Low risk	20/12/2012
DCM	MV407	Rogosa SL HiVeg™ Broth	Low risk	20/12/2012
DCM	M842	Rose Bengal Agar Base	Low risk	20/12/2012
DCM	M640	Rose Bengal Chloramphenicol Agar	Low risk	22/04/2019
DCM	MV640	Rose Bengal Chloramphenicol HiVeg™ Agar	Low risk	22/04/2019
DCM	M1972	RPMI 1640 Agar w/ MOPS & 2% Glucose w/o Sodium Bicarbonate (Twin Pack)	Low risk	20/12/2012
DCM	MV576	RS HiVeg Medium Base	Low risk	22/04/2019
DCM	M576	RS Medium Base	Low risk	22/04/2019
DCM	M409	SABHI Agar Base	Low risk	20/12/2012
DCM	MV409	SABHI HiVeg™ Agar Base	Low risk	20/12/2012
DCM	M1744	Sabouraud Agar Glucose 4%	Low risk	20/12/2012
DCM	M1067	Sabouraud Chloramphenicol Agar	Low risk	20/12/2012
DCM	MV1067	Sabouraud Chloramphenicol HiVeg™ Agar	Low risk	20/12/2012
DCM	M664	Sabouraud Cycloheximide Chloramphenicol Agar	Low risk	20/12/2012
DCM	MV664	Sabouraud Cycloheximide Chloramphenicol HiVeg™ Agar	Low risk	20/12/2012
DCM	MH063	Sabouraud Dextrose Agar	Low risk	22/04/2019
DCM	M063	Sabouraud Dextrose Agar	Low risk	20/12/2012
DCM	M286	Sabouraud Dextrose Agar Base, Modified	Low risk	20/12/2012
DCM	MH033	Sabouraud Dextrose Broth	Low risk	22/04/2019
DCM	M033	Sabouraud Dextrose Broth (Sabouraud Liquid Medium)	Low risk	20/12/2012
DCM	MCD063	Sabouraud Dextrose HiCynth™ Agar	Low risk	12/08/2015
DCM	MCD033	Sabouraud Dextrose HiCynth™ Broth	Low risk	12/08/2015

DCM	MV063	Sabouraud Dextrose HiVeg™ Agar	Low risk	20/12/2012
DCM	MV286	Sabouraud Dextrose HiVeg™ Agar Base, Modified	Low risk	20/12/2012
DCM	MV033	Sabouraud Dextrose HiVeg™ Broth (Sabouraud Liquid HiVeg™ Medium)	Low risk	20/12/2012
DCM	M1313	Sabouraud Dextrose Maltose Agar	Low risk	20/12/2012
DCM	M1460	Sabouraud Dextrose Maltose Broth	Low risk	20/12/2012
DCM	MV1313	Sabouraud Dextrose Maltose HiVeg™ Agar	Low risk	20/12/2012
DCM	MCD013	Sabouraud Fluid HiCynth™ Medium	Low risk	12/08/2015
DCM	M1472	Sabouraud Glucose Agar Base w/ Antibiotics	Low risk	20/12/2012
DCM	M062	Sabouraud Maltose Agar	Low risk	20/12/2012
DCM	M064	Sabouraud Maltose Broth	Low risk	20/12/2012
DCM	MV062	Sabouraud Maltose HiVeg™ Agar	Low risk	20/12/2012
DCM	MV064	Sabouraud Maltose HiVeg™ Broth	Low risk	20/12/2012
DCM	M844	Saccharose Broth	Low risk	20/12/2012
DCM	M1619	Sakazakii DHL Agar	Low risk	20/12/2012
DCM	M942	Saline Agar	Low risk	20/12/2012
DCM	M1778	Saline Lysine Decarboxylase Medium	Low risk	20/12/2012
DCM	M1633	Salmonella Agar (HiCrome™ RajHans Medium)	Low risk	20/12/2012
DCM	M1634	Salmonella Agar, Modified (HiCrome™ RajHans Medium, Modified)	Low risk	20/12/2012
DCM	M573	Salmonella Agar, ONOZ	Low risk	20/12/2012
DCM	M1078	Salmonella Differential Agar (Twin Pack) (RajHans Medium)	Low risk	20/12/2012
DCM	M1082	Salmonella Differential Agar, Modified (Twin Pack)	Low risk	20/12/2012
DCM	MCD1078	Salmonella Differential HiCynth™ Agar (Twin Pack)	Low risk	25/08/2016
DCM	MV1078	Salmonella Differential HiVeg™ Agar (RajHans HiVeg™ Medium) (Twin Pack)	Low risk	20/12/2012
DCM	MV1082	Salmonella Differential HiVeg™ Agar, Modified (Twin Pack)	Low risk	20/12/2012
DCM	MV573	Salmonella HiVeg™ Agar, ONOZ	Low risk	20/12/2012
DCM	M1767	Salt Agar, Modified	Low risk	20/12/2012
DCM	M1290	Salt Broth, Modified	Low risk	20/12/2012
DCM	M155	Salt M Broth	Low risk	20/12/2012
DCM	M821	Salt Polymyxin Broth Base	Low risk	20/12/2012
DCM	MV821	Salt Polymyxin HiVeg™ Broth Base	Low risk	20/12/2012
DCM	M1276	Sauton's Fluid Medium Base	Low risk	20/12/2012
DCM	M1535	SBG Enrichment Broth (Twin Pack)	Low risk	20/12/2012
DCM	M291	Schaedler Agar	Low risk	20/12/2012
DCM	M292	Schaedler Broth	Low risk	20/12/2012
DCM	MV291	Schaedler HiVeg™ Agar	Low risk	20/12/2012
DCM	MV292	Schaedler HiVeg™ Broth	Low risk	20/12/2012
DCM	M1882	Selective Broth for MRSA	Low risk	20/12/2012
DCM	M052	Selenite Broth (Selenite F Broth) (Twin Pack)	Low risk	20/12/2012
DCM	M970	Selenite Broth Base w/o Biselenite	Low risk	20/12/2012

DCM	M1079	Selenite Cystine Broth Base w/o Biselenite	Low risk	20/12/2012
DCM	M1536	Selenite F Broth w/ Dulcitol (Twin Pack)	Low risk	20/12/2012
DCM	M1534	Selenite Mannitol Broth (Twin Pack)	Low risk	20/12/2012
DCM	M1321	Semisolid LM Medium	Low risk	20/12/2012
DCM	M1282	Semisolid Rappaport Vassiliadis Medium, Modified	Low risk	22/04/2019
DCM	M1998	Semisolid RV Medium w/ 0.9% Agar	Low risk	25/08/2016
DCM	MV296	Sensitivity Test HiVeg™ Medium	Low risk	20/12/2012
DCM	M296	Sensitivity Test Medium	Low risk	20/12/2012
DCM	M1301	Sheep Blood Agar Base	Low risk	20/12/2012
DCM	M1739	Shepard's Differential Agar Base	Low risk	20/12/2012
DCM	M411	Simmons Agar Base	Low risk	20/12/2012
DCM	M099	Simmons Citrate Agar	Low risk	20/12/2012
DCM	M099S	Simmons Citrate Agar	Low risk	20/12/2012
DCM	M5296	SM Tryptone Glucose Glycerin Medium	Low risk	25/11/2017
DCM	M960	Smibert's Semisolid Brucella Medium	Low risk	20/12/2012
DCM	M106	Snyder Test Agar	Low risk	20/12/2012
DCM	MV106	Snyder Test HiVeg™ Agar	Low risk	20/12/2012
DCM	M767	Sodium Azide Crystal Violet Blood Agar Base	Low risk	20/12/2012
DCM	M1079B	Sodium Biselenite	Low risk	22/04/2019
DCM	M298	Sorbitol Agar (MacConkey Sorbitol Agar)	Low risk	20/12/2012
DCM	MV298	Sorbitol HiVeg™ Agar (MacConkey Sorbitol HiVeg™ Agar)	Low risk	20/12/2012
DCM	M299	Sorbitol Iron Agar	Low risk	20/12/2012
DCM	MV299	Sorbitol Iron HiVeg™ Agar	Low risk	20/12/2012
DCM	M935	Soya Peptone Yeast Extract Agar	Low risk	20/12/2012
DCM	M1286	Soyabean Bile Broth Base	Low risk	20/12/2012
DCM	M290	Soyabean Casein Digest Agar (Tryptone Soya Agar)	Low risk	22/04/2019
DCM	M109	Soyabean Casein Digest Agar w/ Yeast Extract and Hemin (Tryptone Soya Agar w/ Yeast Extract and Hemin)	Low risk	20/12/2012
DCM	M011	Soyabean Casein Digest Medium (Tryptone Soya Broth)	Low risk	22/04/2019
DCM	M323	Soyabean Casein Digest Medium w/ 0.1% Agar (Tryptone Soya Broth w/ 0.1% Agar)	Low risk	20/12/2012
DCM	M207	Soyabean Casein Digest Medium w/ Yeast Extract and Ferric pyrophosphate	Low risk	20/12/2012
DCM	M322	Soyabean Casein Digest Medium w/o Dextrose (Tryptone SoyaBroth w/o Dextrose)	Low risk	28/04/2017
DCM	MV1286	Soyabean HiVeg™ Broth Base	Low risk	20/12/2012
DCM	MV011	Soyabean HiVeg™ Medium	Low risk	22/04/2019
DCM	MV323	Soyabean HiVeg™ Medium w/ 0.1% Agar (Tryptone Soya HiVeg™ Broth w/ 0.1% Agar)	Low risk	20/12/2012
DCM	MV207	Soyabean HiVeg™ Medium w/ Yeast Extract and Ferric pyrophosphate	Low risk	20/12/2012
DCM	MV290	SoyabeanHiVeg™ Agar	Low risk	22/04/2019

DCM	MH011	Soybean Casein Digest Medium (Casein Soybean Digest Broth)	Low risk	22/04/2019
DCM	MH290	Soybean-Casein Digest Agar (Casein Soyabean Digest Agar)	Low risk	22/04/2019
DCM	M211	Special Infusion Agar	Low risk	20/12/2012
DCM	MV211	Special Infusion Agar, HiVeg™	Low risk	20/12/2012
DCM	M1613	Special YM Medium	Low risk	20/12/2012
DCM	M300	Specimen Preservative Medium Base (SP Hajna)	Low risk	20/12/2012
DCM	M445	Spirit Blue Agar	Low risk	20/12/2012
DCM	MV445	Spirit Blue HiVeg™ Agar	Low risk	20/12/2012
DCM	M412	Spirolate Broth, OMATA	Low risk	20/12/2012
DCM	MV412	Spirolate HiVeg™ Broth, OMATA	Low risk	20/12/2012
DCM	MCD108	SS HiCynth™ Agar (Salmonella Shigella HiCynth™ Agar)	Low risk	12/08/2015
DCM	M108	SS Agar (Salmonella Shigella Agar)	Low risk	20/12/2012
DCM	M108D	SS Agar (Salmonella Shigella Agar)	Low risk	16/12/2017
DCM	M1979R	SS Agar Modified (w/sucrose)	Low risk	25/08/2016
DCM	M1979	SS Agar w/sucrose	Low risk	20/12/2012
DCM	M1032	SS Agar, Modified	Low risk	20/12/2012
DCM	MV108	SS HiVeg™ Agar (Salmonella Shigella HiVeg™ Agar)	Low risk	20/12/2012
DCM	M1959	SS Selective Agar, Improved	Low risk	20/12/2012
DCM	M1703	S5DC agar	Low risk	20/12/2012
DCM	M1608	β-Streptococcus Selective Agar Base	Low risk	20/12/2012
DCM	M675	Staib's Medium (Bird Seed Agar)	Low risk	20/12/2012
DCM	M883	Standard Infusion Agar	Low risk	20/12/2012
DCM	M883	Standard Infusion Agar	Low risk	20/12/2012
DCM	MV883	Standard Infusion Agar, HiVeg™	Low risk	20/12/2012
DCM	MV883	Standard Infusion Agar, HiVeg™	Low risk	20/12/2012
DCM	M116	Standard Nutrient Broth	Low risk	20/12/2012
DCM	MV116	Standard Nutrient HiVeg™ Broth	Low risk	20/12/2012
DCM	M578	Standard Staphylococcus Broth	Low risk	20/12/2012
DCM	MV578	Standard Staphylococcus HiVeg™ Broth	Low risk	20/12/2012
DCM	M156	Staphylococcus Agar No. 110 w/ Azide	Low risk	20/12/2012
DCM	M521	Staphylococcus Agar No.110	Low risk	20/12/2012
DCM	MV521	Staphylococcus HiVeg™ Agar No. 110	Low risk	20/12/2012
DCM	M1965	Stenotrophomonas Selective Agar Base	Low risk	20/12/2012
DCM	M1840R	Streptococcus Agalactiae Selective Agar Base (HiCrome™ Strep B Selective Agar Base)	Low risk	30/10/2018
DCM	M465	Streptococcus Enrichment Broth (SE Broth)	Low risk	20/12/2012
DCM	MV465	Streptococcus Enrichment HiVeg™ Broth (SE HiVeg™ Broth)	Low risk	20/12/2012
DCM	M304	Streptococcus Selection Agar	Low risk	20/12/2012
DCM	M303	Streptococcus Selection Broth	Low risk	20/12/2012
DCM	MV304	Streptococcus Selection HiVeg™ Agar	Low risk	20/12/2012

DCM	MV303	Streptococcus Selection HiVeg™ Broth	Low risk	20/12/2012
DCM	M1735	Stuart Medium w/o Methylene Blue with Charcoal	Low risk	20/12/2012
DCM	M306	Stuart Transport Medium (Transport Medium, Stuart)	Low risk	20/12/2012
DCM	M1131	Stuart Transport Medium w/o Methylene Blue	Low risk	20/12/2012
DCM	M1203	Stuart Transport Medium w/o Sodium Glycerophosphate	Low risk	20/12/2012
DCM	M308	Sulpha Sensitivity Test Agar	Low risk	20/12/2012
DCM	MV837	T.S.C./S.F.P. HiVeg™ Agar Base	Low risk	20/12/2012
DCM	M100	TB Broth Base	Low risk	20/12/2012
DCM	M034	TB Broth Base w/o Tween 80	Low risk	20/12/2012
DCM	MV100	TB HiVeg™ Broth Base	Low risk	20/12/2012
DCM	MV034	TB HiVeg™ Broth Base w/o Tween 80	Low risk	20/12/2012
DCM	M189	TCBS Agar	Low risk	20/12/2012
DCM	M870	TCBS Agar (Selective)	Low risk	20/12/2012
DCM	M870A	TCBS Agar, Modified	Low risk	20/12/2012
DCM	MCD870	TCBS HiCynth™ Agar (Selective)	Low risk	25/08/2016
DCM	MV189	TCBS HiVeg™ Agar	Low risk	20/12/2012
DCM	MV870	TCBS HiVeg™ Agar (Selective)	Low risk	20/12/2012
DCM	M1260	Tellurite Blood Agar Base	Low risk	20/12/2012
DCM	M448	Tellurite Glycine Agar Base	Low risk	20/12/2012
DCM	M616	Tergitol-7 Agar Base	Low risk	20/12/2012
DCM	M850	Tergitol-7 Agar H	Low risk	20/12/2012
DCM	M851	Tergitol-7 Broth	Low risk	20/12/2012
DCM	MV616	Tergitol-7 HiVeg™ Agar Base	Low risk	20/12/2012
DCM	MV850	Tergitol-7 HiVeg™ Agar H	Low risk	20/12/2012
DCM	MV851	Tergitol-7 HiVeg™ Broth	Low risk	20/12/2012
DCM	M032	Tetrathionate Broth Base (w/o Iodine and BG)	Low risk	20/12/2012
DCM	MV032	Tetrathionate HiVeg™ Broth Base (w/o Iodine and BG)	Low risk	20/12/2012
DCM	MV413	Thayer Martin HiVeg™ Medium Base	Low risk	20/12/2012
DCM	M413	Thayer Martin Medium Base	Low risk	20/12/2012
DCM	M610	Thiogel Medium	Low risk	20/12/2012
DCM	M608	Thioglycollate Agar	Low risk	20/12/2012
DCM	M010	Thioglycollate Broth, Alternative (Alternative Thioglycollate Medium)(NIH Thioglycollate Broth)	Low risk	20/12/2012
DCM	MCD010	Thioglycollate HiCynth™ Broth, Alternative (Alternative Thioglycollate HiCynth™ Medium)(NIH Thioglycollate HiCynth™ Broth)	Low risk	12/08/2015
DCM	MV608	Thioglycollate HiVeg™ Agar	Low risk	20/12/2012
DCM	MV010	Thioglycollate HiVeg™ Broth, Alternative (Alternative Thioglycollate HiVeg™ Medium)(NIH HiVeg™ Thioglycollate Broth)	Low risk	20/12/2012
DCM	MV195	Thioglycollate HiVeg™ Medium, Linden (Brewer Thioglycollate HiVeg™ Medium, Modified)	Low risk	20/12/2012
DCM	M979	Thioglycollate Medium w/ Hemin and Vitamin K	Low risk	20/12/2012

DCM	M195	Thioglycollate Medium, Linden (Brewer Thioglycollate Medium, Modified)	Low risk	20/12/2012
DCM	M853	Thiol Broth	Low risk	20/12/2012
DCM	MV853	Thiol HiVeg™ Broth	Low risk	20/12/2012
DCM	MV852	Thiol HiVeg™ Medium	Low risk	20/12/2012
DCM	M852	Thiol Medium	Low risk	20/12/2012
DCM	M314	Tinsdale Agar Base	Low risk	20/12/2012
DCM	MV314	Tinsdale HiVeg™ Agar Base	Low risk	20/12/2012
DCM	M313	Todd Hewitt Broth	Low risk	20/12/2012
DCM	MV313	Todd Hewitt HiVeg™ Broth	Low risk	20/12/2012
DCM	M879	Tomato Juice Agar, Special	Low risk	20/12/2012
DCM	MV879	Tomato Juice HiVeg™ Agar, Special	Low risk	20/12/2012
DCM	M1149	Transgrow Medium Base	Low risk	20/12/2012
DCM	M315	Transport Charcoal Medium	Low risk	20/12/2012
DCM	M1487	Transport Liquid Medium	Low risk	20/12/2012
DCM	M306	Transport Medium Stuart	Low risk	20/12/2012
DCM	M202	Transport Medium w/o Charcoal	Low risk	20/12/2012
DCM	M684	Transport Medium, Amies w/o Charcoal	Low risk	20/12/2012
DCM	M665	Trichomonas Agar Base	Low risk	20/12/2012
DCM	M1204	Trichomonas Broth Base No. 2	Low risk	20/12/2012
DCM	M305	Trichomonas Broth Base, Kupferberg	Low risk	20/12/2012
DCM	MV665	Trichomonas HiVeg™ Agar Base	Low risk	20/12/2012
DCM	MV305	Trichomonas HiVeg™ Broth Base, Kupferberg (Kupferberg Trichomonas HiVeg™ Broth Base)	Low risk	20/12/2012
DCM	MV460	Trichomonas Modified CPLM HiVeg™ Medium Base	Low risk	20/12/2012
DCM	M460	Trichomonas Modified CPLM Medium Base	Low risk	20/12/2012
DCM	M531	Trichophyton Agar-1	Low risk	20/12/2012
DCM	M532	Trichophyton Agar-2	Low risk	20/12/2012
DCM	M533	Trichophyton Agar-3	Low risk	20/12/2012
DCM	M534	Trichophyton Agar-4	Low risk	20/12/2012
DCM	M535	Trichophyton Agar-5	Low risk	20/12/2012
DCM	M536	Trichophyton Agar-6	Low risk	20/12/2012
DCM	M152	Trichophyton Agar-7	Low risk	20/12/2012
DCM	MV531	Trichophyton HiVeg™ Agar-1	Low risk	20/12/2012
DCM	MV532	Trichophyton HiVeg™ Agar-2	Low risk	20/12/2012
DCM	MV533	Trichophyton HiVeg™ Agar-3	Low risk	20/12/2012
DCM	MV534	Trichophyton HiVeg™ Agar-4	Low risk	20/12/2012
DCM	MV535	Trichophyton HiVeg™ Agar-5	Low risk	20/12/2012
DCM	M021	Triple Sugar Iron Agar	Low risk	22/04/2019
DCM	MV021	Triple Sugar Iron HiVeg™ Agar	Low risk	22/04/2019
DCM	M1028	Tryptic Digest Broth(Field's Tryptic Digest Broth)	Low risk	20/12/2012
DCM	MV1028	Tryptic Digest Broth, HiVeg™ (Field's Tryptic Digest Broth, HiVeg™)	Low risk	20/12/2012

DCM	M1591	Tryptone Bile Glucuronic Agar (TBX Agar)	Low risk	22/04/2019
DCM	M463	Tryptone Broth (Tryptone Water)	Low risk	22/04/2019
DCM	MV364	Tryptone Nitrate HiVeg™ Medium	Low risk	20/12/2012
DCM	M364	Tryptone Nitrate Medium	Low risk	20/12/2012
DCM	M969	Tryptone Peptone Glucose Yeast Extract Broth Base w/o Trypsin	Low risk	20/12/2012
DCM	MV969	Tryptone Peptone Glucose Yeast Extract HiVeg™ Broth Base w/o Trypsin	Low risk	20/12/2012
DCM	M323	Tryptone Soya Broth w/ 0.1% Agar	Low risk	20/12/2012
DCM	MV323	Tryptone Soya HiVeg™ Broth w/ 0.1% Agar	Low risk	20/12/2012
DCM	M1948	Tryptone Soya Serum Bacitracin Vancomycin Agar (TSBV)	Low risk	08/12/2017
DCM	M1217	Tryptone Sucrose Tetrazolium Agar Base (TSTA)	Low risk	20/12/2012
DCM	M1056	Tryptone Tellurite Agar Base	Low risk	20/12/2012
DCM	MV463	Tryptone Water, HiVeg™ (Tryptone Broth,HiVeg™)	Low risk	22/04/2019
DCM	M1975	Tryptone yeast extract cystine w/sucrose and w/O bacitracin agar (TYCSB)	Low risk	20/12/2012
DCM	M538	Tryptose Agar	Low risk	20/12/2012
DCM	M996	Tryptose Agar w/ Thiamine HCl	Low risk	20/12/2012
DCM	MV996	Tryptose Agar w/ Thiamine HCl, HiVeg™	Low risk	20/12/2012
DCM	MV538	Tryptose Agar, HiVeg™	Low risk	20/12/2012
DCM	M097	Tryptose Blood Agar Base	Low risk	20/12/2012
DCM	M450	Tryptose Blood Agar Base w/ Yeast Extract	Low risk	20/12/2012
DCM	MV450	Tryptose Blood Agar Base w/ Yeast Extract, HiVeg™	Low risk	20/12/2012
DCM	MV097	Tryptose Blood Agar Base, HiVeg™	Low risk	20/12/2012
DCM	M177	Tryptose Broth	Low risk	20/12/2012
DCM	M997	Tryptose Broth w/ Thiamine HCl	Low risk	20/12/2012
DCM	MV177	Tryptose Broth, HiVeg™	Low risk	20/12/2012
DCM	M5393	Tryptose Phosphate Broth	Low risk	30/10/2018
DCM	M093	Tryptose Phosphate Broth	Low risk	20/12/2012
DCM	MV093	Tryptose Phosphate Broth, HiVeg™	Low risk	20/12/2012
DCM	M1532	Tryptose Phosphate Broth, Modified	Low risk	20/12/2012
DCM	M093G	Tryptose Phosphate Broth, Sterile	Low risk	22/04/2019
DCM	M2019	Tryptose Serum Broth Base(Modified Newin	Low risk	25/08/2016
DCM	M837	Tryptose Sulphite Cycloserine (T.S.C. / S.F.P.) Agar Base (Perfringens Agar Base)	Low risk	20/12/2012
DCM	M1780	TS Saline Agar (Triple Sugar Saline Iron Agar)	Low risk	20/12/2012
DCM	M2016	TSB w/6.5% NaCl	Low risk	25/08/2016
DCM	M1220	TTC Broth Base (Triclosan Ticarcillin Chlorate Broth)	Low risk	20/12/2012
DCM	MV1220	TTC HiVeg™ Broth Base	Low risk	20/12/2012
DCM	M1912	Tween Esterase Test Agar Base	Low risk	20/12/2012
DCM	M1817	Universal Fastidious Culture Agar	Low risk	20/12/2012
DCM	M112S	Urea Agar Base (Christensen)	Low risk	20/12/2012
DCM	M112	Urea Agar Base (Christensen) (Autoclavable)	Low risk	20/12/2012

DCM	M112A	Urea Agar Base (Filter Sterilizable) (w/o Agar)	Low risk	20/12/2012
DCM	M112I	Urea Agar Base, Christensen	Low risk	20/12/2012
DCM	M111A	Urea Broth (Filter Sterilizable)	Low risk	20/12/2012
DCM	M111	Urea Broth Base	Low risk	20/12/2012
DCM	MV112	Urea HiVeg™ Agar Base (Christensen) (Autoclavable)	Low risk	20/12/2012
DCM	M1784I	Urea Indole Broth, Modified	Low risk	20/12/2012
DCM	M1784	Urea Indole Medium	Low risk	20/12/2012
DCM	M328	V Infusion Agar	Low risk	20/12/2012
DCM	M329	V Infusion Broth	Low risk	20/12/2012
DCM	M1057	Vaginalis Agar Base	Low risk	20/12/2012
DCM	M1763	Vancomycin Resistant Enterococci (VRE) Agar Base	Low risk	20/12/2012
DCM	M1762	Vancomycin Resistant Enterococci (VRE) Broth Base	Low risk	20/12/2012
DCM	M416	Veillonella Agar Base	Low risk	20/12/2012
DCM	MV416	Veillonella HiVeg™ Agar Base	Low risk	20/12/2012
DCM	M820	Vibrio Agar	Low risk	20/12/2012
DCM	MV820	Vibrio HiVeg™ Agar	Low risk	20/12/2012
DCM	M049	Violet Red Bile Agar	Low risk	28/04/2017
DCM	M049A	Violet Red Bile Agar	Low risk	16/12/2017
DCM	M1684	Violet Red Bile Agar w/ Glucose and Lactose	Low risk	22/04/2019
DCM	MH581	Violet Red Bile Glucose Agar	Low risk	22/04/2019
DCM	M581	Violet Red Bile Glucose Agar w/o Lactose	Low risk	25/11/2017
DCM	MCD581	Violet Red Bile Glucose HiCynth™ Agar w/o Lactose	Low risk	04/07/2018
DCM	MV581	Violet Red Bile Glucose HiVeg™ Agar w/o Lactose	Low risk	04/07/2018
DCM	MCD049	Violet Red Bile HiCynth™ Agar	Low risk	28/04/2017
DCM	MV049	Violet Red HiVeg™ Agar	Low risk	28/04/2017
DCM	MCD023	Vogel Johnson HiCynth™ Agar Base w/o Tellurite (V.J. HiCynth™ Agar)	Low risk	12/08/2015
DCM	M023	Vogel-Johnson Agar Base w/o Tellurite (V.J. Agar)	Low risk	20/12/2012
DCM	MU023	Vogel-Johnson Agar Medium	Low risk	20/12/2012
DCM	MV023	Vogel-Johnson HiVeg™ Agar Base w/o Tellurite (V. J. HiVeg™ Agar)	Low risk	20/12/2012
DCM	MV662	VP HiVeg™ Medium	Low risk	20/12/2012
DCM	M662	VP Medium	Low risk	20/12/2012
DCM	M626	Wagatsuma Agar Base	Low risk	20/12/2012
DCM	MV626	Wagatsuma HiVeg™ Agar Base	Low risk	20/12/2012
DCM	M1059	Wayne Sulphatase Agar Base	Low risk	20/12/2012
DCM	M832	Wilkins Chalgren Anaerobic Agar Base	Low risk	20/12/2012
DCM	M863	Wilkins Chalgren Anaerobic Broth Base	Low risk	20/12/2012
DCM	MV832	Wilkins Chalgren Anaerobic HiVeg™ Agar Base	Low risk	20/12/2012
DCM	MV863	Wilkins Chalgren Anaerobic HiVeg™ Broth Base	Low risk	25/08/2016
DCM	M331	Wilson Blair Agar Base	Low risk	20/12/2012
DCM	M332	Wilson Blair Agar w/ BG	Low risk	20/12/2012

DCM	MV331	Wilson Blair HiVeg™ Agar Base	Low risk	20/12/2012
DCM	MV332	Wilson Blair HiVeg™ Agar w/ BG	Low risk	20/12/2012
DCM	MV031	XLD HiVeg™ Agar	Low risk	20/12/2012
DCM	M1147	XLT4 Agar Base	Low risk	20/12/2012
DCM	MV1147	XLT4 HiVeg™ Agar Base	Low risk	20/12/2012
DCM	M336	Xylose Lysine Agar Base	Low risk	20/12/2012
DCM	M031	Xylose Lysine Deoxycholate Agar (XLD Agar)	Low risk	20/12/2012
DCM	MCD031	Xylose Lysine Deoxycholate HiCynth™ Agar (XLD HiCynth™ Agar)	Low risk	12/08/2015
DCM	MH031	Xylose-Lysine-Deoxycholate Agar	Low risk	22/04/2019
DCM	M424	Yeast Malt Agar (YM Agar) (ISP Medium No. 2)	Low risk	22/04/2019
DCM	M425	Yeast Malt Broth (YM Broth)	Low risk	20/12/2012
DCM	MV424	Yeast Malt HiVeg™ Agar (YM HiVeg™ Agar)	Low risk	22/04/2019
DCM	MV425	Yeast Malt HiVeg™ Broth (YM HiVeg™ Broth)	Low risk	20/12/2012
DCM	M1421	YEP Agar	Low risk	30/10/2018
DCM	M1367	Yersinia Enrichment Broth Base	Low risk	20/12/2012
DCM	M843	Yersinia Selective Agar Base	Low risk	20/12/2012
DCM	M1861	Yersinia Selective Broth Base	Low risk	20/12/2012
DCM	MV843	Yersinia Selective HiVeg™ Agar Base	Low risk	20/12/2012
DCM	EC073DR	Blood Agar Base (HiEncap™ water-soluble capsule)	Low risk	25/08/2016
DCM	EC073DR	Blood Agar Base (HiEncap™ water-soluble capsule)	Low risk	25/08/2016
DCM	EC211CR	BHI Agar (HiEncap™ water-soluble capsule)	Low risk	25/08/2016
DCM	EC211CR	BHI Agar (HiEncap™ water-soluble capsule)	Low risk	25/08/2016
DCM	EC210CR	BHI Broth (HiEncap™ water-soluble capsule)	Low risk	25/08/2016
DCM	EC210CR	BHI Broth (HiEncap™ water-soluble capsule)	Low risk	25/08/2016
DCM	EC1297ACR	HiCrome™ Candida Differential Agar (HiEncap™ water-soluble capsule)	Low risk	25/08/2016
DCM	EC1297ADR	HiCrome™ Candida Differential Agar (HiEncap™ water-soluble capsule)	Low risk	25/08/2016
DCM	EC1297ARDR	HiCrome™ Candida Differential Agar (HiEncap™ water-soluble capsule)	Low risk	25/08/2016
DCM	EC1297ACR	HiCrome™ Candida Differential Agar (HiEncap™ water-soluble capsule)	Low risk	25/08/2016
DCM	EC1297ADR	HiCrome™ Candida Differential Agar (HiEncap™ water-soluble capsule)	Low risk	25/08/2016
DCM	EC1297ARDR	HiCrome™ Candida Differential Agar (HiEncap™ water-soluble capsule)	Low risk	25/08/2016
DCM	EC1674CCLR	HiCrome™ MeReSa Agar Base (HiEncap™ water-soluble capsule)	Low risk	25/08/2016
DCM	EC1674CCLR	HiCrome™ MeReSa Agar Base (HiEncap™ water-soluble capsule)	Low risk	25/08/2016
DCM	EC1353CCLR	HiCrome™ UTI Agar (HiEncap™ water-soluble capsule)	Low risk	25/08/2016
DCM	EC1353CR	HiCrome™ UTI Agar (HiEncap™ water-soluble capsule)	Low risk	25/08/2016
DCM	EC1353DR	HiCrome™ UTI Agar (HiEncap™ water-soluble capsule)	Low risk	25/08/2016
DCM	EC1353CCLR	HiCrome™ UTI Agar (HiEncap™ water-soluble capsule)	Low risk	25/08/2016
DCM	EC1353CR	HiCrome™ UTI Agar (HiEncap™ water-soluble capsule)	Low risk	25/08/2016
DCM	EC1353DR	HiCrome™ UTI Agar (HiEncap™ water-soluble capsule)	Low risk	25/08/2016
DCM	EC073D	HiEncap™ Blood Agar Base	Low risk	12/08/2015
DCM	EC073CCL	HiEncap™ Blood Agar Base	Low risk	12/08/2015

DCM	EC211CCL	HiEncap™ BHI Agar (HiEncap™ Special Infusion Agar)	Low risk	12/08/2015
DCM	EC210D	HiEncap™ BHI Broth	Low risk	12/08/2015
DCM	EC210CCL	HiEncap™ BHI Broth	Low risk	12/08/2015
DCM	EC081CCL	HiEncap™ MacConkey Agar w/0.15% Bile Salt	Low risk	12/08/2015
DCM	EC082ACCL	HiEncap™ MacConkey Agar w/o CV, NaCl w/Bile Salts	Low risk	12/08/2015
DCM	EC173CCL	HiEncap™ Mueller Hinton Agar	Low risk	12/08/2015
DCM	EC173D	HiEncap™ Mueller Hinton Agar	Low risk	12/08/2015
DCM	EC1084CCL	HiEncap™ Mueller Hinton Agar No.2	Low risk	12/08/2015
DCM	EC1084D	HiEncap™ Mueller Hinton Agar No.2	Low risk	12/08/2015
DCM	EC391CCL	HiEncap™ Mueller Hinton Broth	Low risk	12/08/2015
DCM	EC391D	HiEncap™ Mueller Hinton Broth	Low risk	12/08/2015
DCM	EC001DR	HiEncap™ Nutrient Agar	Low risk	25/08/2016
DCM	EC001CCL	HiEncap™ Nutrient Agar	Low risk	12/08/2015
DCM	EC001D	HiEncap™ Nutrient Agar	Low risk	12/08/2015
DCM	EC001DR	HiEncap™ Nutrient Agar	Low risk	25/08/2016
DCM	EC002CCL	HiEncap™ Nutrient Broth	Low risk	12/08/2015
DCM	EC002D	HiEncap™ Nutrient Broth	Low risk	12/08/2015
DCM	EC002M	HiEncap™ Nutrient Broth	Low risk	12/08/2015
DCM	EC091D	HiEncap™ Plate Count Agar	Low risk	16/12/2017
DCM	EC091CCL	HiEncap™ Plate Count Agar	Low risk	16/12/2017
DCM	EC063CCL	HiEncap™ Sabouraud Dextrose Agar	Low risk	12/08/2015
DCM	EC033CCL	HiEncap™ Sabouraud Dextrose Broth	Low risk	12/08/2015
DCM	EC033D	HiEncap™ Sabouraud Dextrose Broth	Low risk	12/08/2015
DCM	EC173DR	Mueller Hinton Agar (HiEncap™ water-soluble capsule)	Low risk	25/08/2016
DCM	EC173DR	Mueller Hinton Agar (HiEncap™ water-soluble capsule)	Low risk	25/08/2016
DCM	EC1084DR	Mueller Hinton Agar No.2 (HiEncap™ water-soluble capsule)	Low risk	25/08/2016
DCM	EC1084DR	Mueller Hinton Agar No.2 (HiEncap™ water-soluble capsule)	Low risk	25/08/2016
DCM	EC391CR	Mueller Hinton Broth (HiEncap™ water-soluble capsule)	Low risk	25/08/2016
DCM	EC391CR	Mueller Hinton Broth (HiEncap™ water-soluble capsule)	Low risk	25/08/2016
DCM	EC001DR	Nutrient Agar (HiEncap™ water-soluble capsule)	Low risk	25/08/2016
DCM	EC001DR	Nutrient Agar (HiEncap™ water-soluble capsule)	Low risk	25/08/2016
DCM	EC002CR	Nutrient Broth (HiEncap™ water-soluble capsule)	Low risk	25/08/2016
DCM	EC002CR	Nutrient Broth (HiEncap™ water-soluble capsule)	Low risk	25/08/2016
DCM	EC063CCLR	Sabouraud Dextrose Agar (HiEncap™ water-soluble capsule)	Low risk	25/08/2016
DCM	EC063CCLR	Sabouraud Dextrose Agar (HiEncap™ water-soluble capsule)	Low risk	25/08/2016
DCM	EC033CR	Sabouraud Dextrose Broth (HiEncap™ water-soluble capsule)	Low risk	25/08/2016
DCM	EC033CR	Sabouraud Dextrose Broth (HiEncap™ water-soluble capsule)	Low risk	25/08/2016
DCM	EC031CCLR	Xylose Deoxycholate Agar (XLD Agar) (HiEncap™ water-soluble capsule)	Low risk	25/08/2016
DCM	EC031CCLR	Xylose Deoxycholate Agar (XLD Agar) (HiEncap™ water-soluble capsule)	Low risk	25/08/2016
DCM	GM618	Alkaline Peptone Water, Granulated	Low Risk	12/08/2015
DCM	GM491	Anaerobic Agar (Brewer) , Granulated	Low Risk	12/08/2015

DCM	GM672	Asparagine Broth (Coccidioidin and Histoplasmin Broth) , Granulated	Low Risk	12/08/2015
DCM	GM043	Baird Parker Agar Base,Granulated	Low Risk	12/08/2015
DCM	GM211	BHI Agar (Special Infusion Agar) , Granulated	Low Risk	12/08/2015
DCM	GM210	BHI Broth, Granulated	Low Risk	12/08/2015
DCM	GM217	Bi.G.G.Y. Agar (Nickerson Medium) , Granulated	Low Risk	12/08/2015
DCM	GM027	Bismuth Sulphite Agar, Granulated	Low Risk	12/08/2015
DCM	GM073	Blood Agar Base (Infusion Agar) , Granulated	Low Risk	12/08/2015
DCM	GM073R	Blood Agar Base (Infusion Agar) w/o Blood, Granulated	Low risk	25/08/2016
DCM	GM834A	Blood Agar Base No. 2 w/ 1.2% Agar, Granulated	Low Risk	12/08/2015
DCM	GM016A	Brilliant Green Agar Base w/ 1.2% Agar, Granulated	Low Risk	12/08/2015
DCM	GM971	Brilliant Green Agar Base w/ Phosphates, Granulated	Low risk	20/12/2012
DCM	GM074	Brucella Agar Base, Granulated	Low Risk	12/08/2015
DCM	GM614	Buffered Peptone Water , Granulated	Low risk	22/04/2019
DCM	GM1275	Buffered Peptone Water w/ NaCl, Granulated	Low Risk	12/08/2015
DCM	GMH1275	Buffered Sodium Chloride-Peptone Solution pH 7.0 , Granulated	Low risk	22/04/2019
DCM	GM792	C.L.E.D. Agar w/ Bromo Thymol Blue, Granulated	Low Risk	12/08/2015
DCM	GMH024	Cetrimide Agar , Granulated	Low risk	22/04/2019
DCM	GM024	Cetrimide Agar Base, Granulated	Low Risk	12/08/2015
DCM	GM497	Clostridial Agar, Granulated	Low risk	25/08/2016
DCM	GMH144	Columbia Agar , Granulated	Low risk	22/04/2019
DCM	GM144	Columbia Blood Agar Base, Granulated	Low Risk	12/08/2015
DCM	GM188	D.T.M. Agar Base (Dermatophyte Test Agar Base) , Granulated	Low Risk	12/08/2015
DCM	GM030	Deoxycholate Agar, Granulated	Low Risk	12/08/2015
DCM	GM065	Deoxycholate Citrate Agar, Granulated	Low Risk	12/08/2015
DCM	GM286	Dextrose Agar Base, Emmons (Sabouraud Dextrose Agar Base, Modified) , Granulated	Low Risk	12/08/2015
DCM	GM1129	Dichloran Glycerol Medium Base , Granulated	Low risk	22/04/2019
DCM	GM127	EC Broth, Granulated	Low Risk	12/08/2015
DCM	GM317	EMB Agar, Granulated	Low Risk	12/08/2015
DCM	GM022	EMB Agar, Levine, Granulated	Low Risk	12/08/2015
DCM	GM029	Endo Agar, Granulated	Low Risk	12/08/2015
DCM	GM029R	Endo Agar, Special	Low risk	25/08/2016
DCM	GM1075	Endo Agar,Modified, Granulated	Low Risk	12/08/2015
DCM	GMH287	Enterobacteria Enrichment Broth, Mossel , Granulated	Low risk	22/04/2019
DCM	GM013	Fluid Sabouraud Medium (Sabouraud Medium,Fluid) , Granulated	Low Risk	12/08/2015
DCM	GM025	Fluid Selenite Cystine Medium (Selenite Cystine Broth) (Twin Pack) , Granulated	Low Risk	12/08/2015
DCM	GM032	Fluid Tetrathionate Medium w/o Iodine and BG (Tetrathionate Broth Base w/o Iodine and BG) , Granulated	Low Risk	12/08/2015
DCM	GM009	Fluid Thioglycollate medium (Thioglycollate medium Fluid) , Granulated	Low risk	22/04/2019

DCM	GM434	GC Agar Base, Granulated	Low Risk	04/07/2018
DCM	GM070	Glucose Phosphate Broth (Buffered Glucose Broth) , Granulated	Low risk	12/08/2015
DCM	GM070R	Glucose Phosphate Broth (Buffered Glucose Broth) , Granulated	Low risk	04/07/2018
DCM	GMV070	Glucose Phosphate HiVeg™ Broth (Buffered Glucose HiVeg™ Broth) , Granulated	Low risk	20/12/2012
DCM	GM242	GN Broth, Hajna, Granulated	Low Risk	12/08/2015
DCM	GM467	Hektoen Enteric Agar, Granulated	Low Risk	12/08/2015
DCM	GM1297A	HiCrome™ Candida Differential Agar, Granulated	Low Risk	12/08/2015
DCM	GM1353	HiCrome™ UTI Agar, Granulated	Low Risk	12/08/2015
DCM	GM1007	KF Streptococcus Agar Base w/ BCP, Granulated	Low Risk	12/08/2015
DCM	GM1232	Kimmig Fungi Agar Base, Granulated	Low Risk	12/08/2015
DCM	GM1543	King's Medium A Base, Granulated	Low Risk	12/08/2015
DCM	GM078	Kligler Iron Agar, Granulated	Low Risk	12/08/2015
DCM	GM641	Lactobacillus MRS Agar (MRS Agar) , Granulated	Low Risk	12/08/2015
DCM	GM369	Lactobacillus MRS Broth (MRS Broth) , Granulated	Low Risk	12/08/2015
DCM	GM1003	Lactose Broth , Granulated	Low risk	22/04/2019
DCM	GM080	Lauryl Sulphate Broth (Lauryl Tryptose Broth) , Granulated	Low risk	22/04/2019
DCM	GM1380	Leifson Agar, Granulated	Low Risk	12/08/2015
DCM	GM890A	Listeria Enrichment Medium Base (UVM) , Granulated	Low Risk	12/08/2015
DCM	GM1064	Listeria Identification Agar Base (PALCAM) , Granulated	Low risk	22/04/2019
DCM	GM1064	Listeria Identification Agar Base (PALCAM), Granulated	Low Risk	22/04/2019
DCM	GM1090	Listeria Identification Broth Base (PALCAM) , Granulated	Low risk	22/04/2019
DCM	GM1090	Listeria Identification Broth Base (PALCAM), Granulated	Low Risk	22/04/2019
DCM	GM1145	Listeria Oxford Medium Base, Granulated	Low Risk	12/08/2015
DCM	GM889	Listeria Selective Broth Base, Granulated	Low Risk	12/08/2015
DCM	GM1865	Listeria Selective Enrichment Broth , Granulated	Low risk	22/04/2019
DCM	GM1001	LM Agar, Granulated	Low Risk	12/08/2015
DCM	GM162	Lowenstein Jensen Medium Base (L.J. Medium) , Granulated	Low Risk	12/08/2015
DCM	GMH081	MacConkey Agar , Granulated	Low risk	22/04/2019
DCM	GM081	MacConkey Agar w/0.15% Bile Salts, CV and NaCl, Granulated	Low Risk	12/08/2015
DCM	GM082A	MacConkey Agar w/o CV, NaCl w/0.5% Bile Salts, Granulated	Low Risk	12/08/2015
DCM	GM082	MacConkey Agar w/o CV, NaCl w/0.5% Sodium Taurocholate, Granulated	Low Risk	12/08/2015
DCM	GMH083	MacConkey Broth , Granulated	Low risk	22/04/2019
DCM	GM083	MacConkey Broth Purple w/BCP , Granulated	Low risk	22/04/2019
DCM	GM137	Malt Extract Agar Base (w/ Mycological Peptone) , Granulated	Low Risk	12/08/2015
DCM	GM255	Malt Extract Broth Base, Granulated	Low Risk	12/08/2015
DCM	GMH118	Mannitol Salt Agar , Granulated	Low risk	22/04/2019

DCM	GM118	Mannitol Salt Agar Base , Granulated	Low risk	12/08/2015
DCM	GM1030	Maximum Recovery Diluent , Granulated	Low risk	22/04/2019
DCM	GM1170	Modified Czapek Dox Agar, Granulated	Low risk	25/08/2016
DCM	GM1285	Modified EC Broth Base, Granulated	Low Risk	12/08/2015
DCM	GM1286I	Modified Soyabean Bile Broth Base , Granulated	Low risk	22/04/2019
DCM	GM1084	Mueller Hinton Agar No. 2, Granulated	Low Risk	12/08/2015
DCM	GM173	Mueller Hinton Agar, Granulated	Low Risk	12/08/2015
DCM	GM391	Mueller Hinton Broth, Granulated	Low Risk	12/08/2015
DCM	GM636	MYP Agar Base (Phenol Red Egg Yolk Polymyxin Agar Base) , Granulated	Low Risk	12/08/2015
DCM	GM1269	Nutrient Agar No.2 , Granulated	Low risk	12/08/2015
DCM	GM001	Nutrient Agar, Granulated	Low Risk	12/08/2015
DCM	GM002	Nutrient Broth, Granulated	Low Risk	12/08/2015
DCM	GM395	OF Basal Medium, Granulated	Low Risk	12/08/2015
DCM	GM933	Orange Serum Agar , Granulated	Low risk	22/04/2019
DCM	GM028	Peptone Water, Granulated	Low Risk	04/07/2018
DCM	GM837	Perfringens Agar Base (Tryptose Sulphite Cycloserine Agar Base) (T.S.C./S.F.P. Agar Base) , Granulated	Low Risk	12/08/2015
DCM	GM091	Plate Count Agar (Standard Methods Agar),Granulated	Low Risk	28/04/2017
DCM	GMH096	Potato Dextrose Agar , Granulated	Low risk	22/04/2019
DCM	GM096	Potato Dextrose Agar , Granulated	Low risk	22/04/2019
DCM	GM085	Pseudomonas Agar Base , Granulated	Low risk	22/04/2019
DCM	GM085	Pseudomonas Agar Base, Granulated	Low Risk	22/04/2019
DCM	GMH1491	Rappaport Vassiliadis Salmonella Enrichment Broth , Granulated	Low risk	22/04/2019
DCM	GM1491	Rappaport Vassiliadis Soya Broth (RVS Broth) , Granulated	Low Risk	12/08/2015
DCM	GMH443	Reinforced Medium for Clostridia , Granulated	Low risk	22/04/2019
DCM	GM149	Robinson's Cooked M Medium (R.C. Medium), Granulated	Low Risk	16/12/2017
DCM	GM130	Rogosa SL Agar, Granulated	Low Risk	12/08/2015
DCM	GM842	Rose Bengal Agar Base, Granulated	Low risk	12/08/2015
DCM	GM1067	Sabouraud Chloramphenicol Agar, Granulated	Low risk	25/08/2016
DCM	GM063	Sabouraud Dextrose Agar , Granulated	Low Risk	12/08/2015
DCM	GMH063	Sabouraud Dextrose Agar , Granulated	Low risk	22/04/2019
DCM	GM033	Sabouraud Dextrose Broth (Sabouraud Liquid Medium) , Granulated	Low Risk	12/08/2015
DCM	GMH033	Sabouraud Dextrose Broth , Granulated	Low risk	22/04/2019
DCM	GMV033	Sabouraud Dextrose HiVeg™ Broth (Sabouraud Liquid HiVeg™ Medium) , Granulated	Low Risk	12/08/2015
DCM	GM1313	Sabouraud Dextrose Maltose Agar, Granulated	Low Risk	12/08/2015
DCM	GM062	Sabouraud Maltose Agar, Granulated	Low Risk	12/08/2015
DCM	GM1619	Sakazakii DHL Agar, Granulated	Low Risk	12/08/2015
DCM	GM1078	Salmonella Differential Agar (Twin Pack), Raj Hans Medium (Twin Pack) , Granulated	Low Risk	12/08/2015

DCM	GM052	Selenite Broth (Selenite F Broth) (Twin Pack) , Granulated	Low Risk	12/08/2015
DCM	GM298R	Sorbitol Agar (Sorbitol MacConkey Agar)	Low risk	25/08/2016
DCM	GM290	Soyabean Casein Digest Agar (Tryptone Soya Agar) , Granulated	Low risk	22/04/2019
DCM	GM011	Soyabean Casein Digest Medium (Tryptone Soya Broth) , Granulated	Low risk	22/04/2019
DCM	GMH011	Soybean Casein Digest Medium (Casein Soybean Digest Broth) , Granulated	Low risk	22/04/2019
DCM	GMH290	Soybean-Casein Digest Agar (Casein Soyabean Digest Agar) , Granulated	Low risk	22/04/2019
DCM	GM108	SS Agar (Salmonella Shigella Agar) , Granulated	Low Risk	12/08/2015
DCM	GM189	TCBS Agar, Granulated	Low Risk	12/08/2015
DCM	GM010	Thioglycollate Broth, Alternative (Alternative Thioglycollate Medium)(NIH Thioglycollate Broth) , Granulated	Low risk	12/08/2015
DCM	GM021	Triple Sugar Iron Agar , Granulated	Low risk	22/04/2019
DCM	GM463	Tryptone Broth (Tryptone Water) , Granulated	Low risk	22/04/2019
DCM	GM177	Tryptose Broth, Granulated	Low Risk	12/08/2015
DCM	GM112	Urea Agar Base (Christensen) (Autoclavable)	Low Risk	30/10/2018
DCM	GM112A	Urea Agar Base (Filter sterilizable), Granulated	Low risk	25/08/2016
DCM	GM111A	Urea Broth (Filter sterilizable), Granulated	Low risk	25/08/2016
DCM	GM049	Violet Red Bile Agar, Granulated	Low risk	28/04/2017
DCM	GMH581	Violet Red Bile Glucose Agar , Granulated	Low risk	22/04/2019
DCM	GM581	Violet Red Bile Glucose Agar w/o Lactose, Granulated	Low risk	04/07/2018
DCM	GM031	Xylose Lysine Deoxycholate Agar (XLD Agar) , Granulated	Low Risk	12/08/2015
DCM	GMH031	Xylose-Lysine-Deoxycholate Agar , Granulated	Low risk	22/04/2019

Product group	Type/ Model / Ref number	Device Name	Risk Class	Date of CE compliance
Dehydrated Culture Media				
DCM-S	FD001	Non Spore Anaerobic Supplement	Low risk	20/12/2012
DCM-S	FD002	G.N. Spore Anaerobic Supplement	Low risk	20/12/2012
DCM-S	FD003	Polymyxin B Selective Supplement	Low risk	20/12/2012
DCM-S	FD003B	Polymyxin B Selective Supplement	Low risk	04/07/2018
DCM-S	FD004	Bordetella Selective Supplement	Low risk	20/12/2012
DCM-S	FD005	Brucella Selective Supplement	Low risk	20/12/2012
DCM-S	FD006	Campylobacter Supplement-I (Blaser-Wang)	Low risk	20/12/2012
DCM-S	FD007	Campylobacter Supplement - II (Butzler)	Low risk	20/12/2012
DCM-S	FD008	Campylobacter Supplement- III (Skirrow)	Low risk	20/12/2012
DCM-S	FD009	Campylobacter Growth Supplement	Low risk	20/12/2012
DCM-S	FD010	Clostridium Difficile Supplement	Low risk	20/12/2012
DCM-S	FD013	S.F.P. Supplement (Perfringens S.F.P. Supplement)	Low risk	20/12/2012
DCM-S	FD014	T.S.C. Supplement (Perfringens T.S.C. Supplement)	Low risk	20/12/2012
DCM-S	FD015	Dermato Supplement	Low risk	20/12/2012
DCM-S	FD017	Legionella Selective Supplement	Low risk	20/12/2012

DCM-S	FD018	Middlebrook OADC Growth Supplement	Low risk	20/12/2012
DCM-S	FD019	Middlebrook ADC Growth Supplement	Low risk	20/12/2012
DCM-S	FD020	Oleic Albumin Supplement	Low risk	20/12/2012
DCM-S	FD021	GC Supplement w/ Antibiotics	Low risk	20/12/2012
DCM-S	FD022	Haemoglobin Powder	Low risk	20/12/2012
DCM-S	FD023	V.C.N. Supplement	Low risk	20/12/2012
DCM-S	FD024	V.C.N.T. Supplement	Low risk	20/12/2012
DCM-S	FD025	Vitamino Growth Supplement (Twin Pack)	Low risk	20/12/2012
DCM-S	FD026	Linco T Supplement	Low risk	20/12/2012
DCM-S	FD027	Yeast Autolysate Supplement	Low risk	20/12/2012
DCM-S	FD028	Vanclo T Supplement	Low risk	20/12/2012
DCM-S	FD029	Cetrinix Supplement	Low risk	22/04/2019
DCM-S	FD030	Staph-Strepto Supplement	Low risk	20/12/2012
DCM-S	FD031	Strepto supplement	Low risk	25/08/2016
DCM-S	FD033	Chloramphenicol Selective Supplement	Low risk	20/12/2012
DCM-S	FD034	Yersinia Selective Supplement	Low risk	20/12/2012
DCM-S	FD035	CC Supplement	Low risk	20/12/2012
DCM-S	FD036	CFC Supplement	Low risk	22/04/2019
DCM-S	FD037	Legionella Selective Supplement II	Low risk	20/12/2012
DCM-S	FD038	Legionella Selective Supplement III	Low risk	20/12/2012
DCM-S	FD039	Aeromonas Selective Supplement	Low risk	20/12/2012
DCM-S	FD040	Legionella Selective Supplement IV (MWY)	Low risk	20/12/2012
DCM-S	FD041A	Legionella Supplement (Twin Pack)	Low risk	20/12/2012
DCM-S	FD041AR	Legionella Growth Supplement (Legionella	Low risk	25/08/2016
DCM-S	FD042	Campylobacter Selective Supplement IV (Preston Selective Supplement)	Low risk	20/12/2012
DCM-S	FD043	Doyle's Antibiotic Supplement	Low risk	20/12/2012
DCM-S	FD045	Egg Yolk Emulsion (100 ml per vial)	Low risk	20/12/2012
DCM-S	FD045B	Egg Yolk Emulsion	Low risk	04/07/2018
DCM-S	FD045L	Egg Yolk Emulsion (50ml per vial)	Low risk	04/07/2018
DCM-S	FD045R	Egg Yolk Emulsion (100 ml per vial)	Low risk	25/08/2016
DCM-S	FD046	Egg Yolk Tellurite Emulsion (100 ml per vial)	Low risk	20/12/2012
DCM-S	FD046B	Egg Yolk Tellurite Emulsion	Low risk	04/07/2018
DCM-S	FD046L	Egg Yolk Tellurite Emulsion (50ml per vial)	Low risk	04/07/2018
DCM-S	FD046N	Egg Yolk Tellurite Emulsion, Modified	Low risk	04/07/2018
DCM-S	FD046NL	Egg Yolk Tellurite Emulsion, Modified	Low risk	04/07/2018
DCM-S	FD047	Potassium Tellurite 3.5% (1 ml per vial)	Low risk	20/12/2012
DCM-S	FD048	Urea 40% (5 ml per vial)	Low risk	20/12/2012
DCM-S	FD049	C.B.I. Supplement	Low risk	20/12/2012
DCM-S	FD052	Potassium Tellurite 1% (1 ml per vial)	Low risk	20/12/2012
DCM-S	FD053	Gruft Mycobacterial Supplement	Low risk	20/12/2012

DCM-S	FD054	GBS Supplement	Low risk	20/12/2012
DCM-S	FD056	G. Vaginalis Selective Supplement	Low risk	20/12/2012
DCM-S	FD057	TTC Solution 1% (10 ml per vial)	Low risk	20/12/2012
DCM-S	FD059	Basic Fuchsin (6.0 gm per vial)	Low risk	20/12/2012
DCM-S	FD061	Listeria Selective Supplement (PALCAM)	Low risk	22/04/2019
DCM-S	FD061R	Listeria Selective Supplement (PALCAM)	Low risk	04/07/2018
DCM-S	FD062	Bacteroides Selective Supplement	Low risk	20/12/2012
DCM-S	FD063	Listeria Selective Supplement II	Low risk	20/12/2012
DCM-S	FD063I	Listeria Selective Supplement II	Low risk	20/12/2012
DCM-S	FD066	Leptospira Enrichment	Low risk	20/12/2012
DCM-S	FD068	Sulpha Supplement	Low risk	20/12/2012
DCM-S	FD069	B P Sulpha Supplement	Low risk	20/12/2012
DCM-S	FD070	McBride Listeria Supplement	Low risk	20/12/2012
DCM-S	FD071	Oxford Listeria Supplement	Low risk	20/12/2012
DCM-S	FD072	KL Virulence Enrichment (20 ml per vial)	Low risk	20/12/2012
DCM-S	FD073	Diphtheria Virulence Supplement (Part A & B)	Low risk	20/12/2012
DCM-S	FD075	Mycoplasma Enrichment Supplement	Low risk	20/12/2012
DCM-S	FD082	Ampicillin Supplement	Low risk	20/12/2012
DCM-S	FD090	Campylobacter Selective Supplement	Low risk	20/12/2012
DCM-S	FD091	Bromo Thymol Blue Supplement (20 mg per vial)	Low risk	20/12/2012
DCM-S	FD093	Bromo Cresol Purple	Low risk	22/04/2019
DCM-S	FD094	Trichomonas Selective Supplement II	Low risk	20/12/2012
DCM-S	FD095	10% Lactic Acid Solution (10 ml per vial)	Low risk	20/12/2012
DCM-S	FD096	Novobiocin Supplement	Low risk	22/04/2019
DCM-S	FD099	Trichomonas Selective Supplement I	Low risk	20/12/2012
DCM-S	FD100	Mueller Tellurite Serum (25 ml per vial)	Low risk	20/12/2012
DCM-S	FD102	Ticarcillin Supplement	Low risk	20/12/2012
DCM-S	FD103	Potassium Chlorate Supplement	Low risk	20/12/2012
DCM-S	FD105	Park and Sanders Selective Supplement II	Low risk	20/12/2012
DCM-S	FD106	Campylobacter Supplement VI (Butzler)	Low risk	20/12/2012
DCM-S	FD111	Kimmig Selective Supplement (Twin Pack)	Low risk	20/12/2012
DCM-S	FD112	George Kimmig Selective Supplement	Low risk	20/12/2012
DCM-S	FD114	Vitamin K1 Supplement	Low risk	20/12/2012
DCM-S	FD117	Haemophilus Growth Supplement	Low risk	20/12/2012
DCM-S	FD118	Mucosal	Low risk	20/12/2012
DCM-S	FD119	Streptococcus Selective Supplement	Low risk	20/12/2012
DCM-S	FD120	Chlortetracycline Selective Supplement	Low risk	20/12/2012
DCM-S	FD126	Listeria Moxalactam Supplement	Low risk	20/12/2012
DCM-S	FD130	Nalidixic Selective Supplement	Low risk	20/12/2012
DCM-S	FD135	CCDA Selective Supplement	Low risk	20/12/2012
DCM-S	FD136	Listeria UVM Supplement I	Low risk	20/12/2012

DCM-S	FD137	Listeria UVM Supplement II	Low risk	20/12/2012
DCM-S	FD143	Legionella (GVPC) Selective Supplement	Low risk	20/12/2012
DCM-S	FD147	Tellurite - Cefixime Supplement	Low risk	20/12/2012
DCM-S	FD149	Neomycin Supplement	Low risk	20/12/2012
DCM-S	FD150	NYC Supplement	Low risk	20/12/2012
DCM-S	FD152	XLT4 Supplement	Low risk	20/12/2012
DCM-S	FD157	Urea 5% (5 ml per vial)	Low risk	20/12/2012
DCM-S	FD158	Campylobacter Selective Supplement IV (Preston), Modified	Low risk	20/12/2012
DCM-S	FD159	Doyle'S Antibiotic Supplement, Modified	Low risk	04/07/2018
DCM-S	FD160	Legionella (GVPA) Selective Supplement, Modified	Low risk	04/07/2018
DCM-S	FD161	Brucella Selective Supplement, Modified	Low risk	04/07/2018
DCM-S	FD163	Listeria Selective Supplement II, Modified	Low risk	04/07/2018
DCM-S	FD163-I	Listeria Selective Supplement II, Modified	Low risk	04/07/2018
DCM-S	FD164	Park and Sanders Selective Supplement II, Modified	Low risk	04/07/2018
DCM-S	FD165	Campylobacter Supplement -II (Butzler), Modified	Low risk	04/07/2018
DCM-S	FD169	CC Supplement, Modified	Low risk	04/07/2018
DCM-S	FD171	McBride Listeria Supplement, Modified	Low risk	04/07/2018
DCM-S	FD172	Oxford Listeria Supplement, Modified	Low risk	28/04/2017
DCM-S	FD172R	Oxford Listeria Supplement, Modified	Low risk	04/07/2018
DCM-S	FD173	Mycoprep (for 2 tests)	Low risk	16/12/2017
DCM-S	FD173B	Mycoprep (for 10 tests)	Low risk	16/12/2017
DCM-S	FD175	Mycoplasma Urogenital Selective Supplement	Low risk	20/12/2012
DCM-S	FD176	Dermato Supplement, Modified	Low risk	04/07/2018
DCM-S	FD179	Antibiotic Mixture for Borrelia (100 X) (5 ml per vial)	Low risk	20/12/2012
DCM-S	FD180	Rabbit serum	Low risk	25/08/2016
DCM-S	FD183	Legionella Selective Supplement II, Modified	Low risk	04/07/2018
DCM-S	FD185	Anthraxis Selective Supplement	Low risk	20/12/2012
DCM-S	FD190	HiCrome®Hicrome ECC Selective Supplement	Low risk	22/04/2019
DCM-S	FD191	Oxacillin Resistance Selective Supplement	Low risk	20/12/2012
DCM-S	FD192	HiCrome™™ Candida Selective Supplement	Low risk	20/12/2012
DCM-S	FD195	Fibrinogen Plasma Trypsin Inhibitor Supplement	Low risk	20/12/2012
DCM-S	FD196	Tetracycline Selective Supplement	Low risk	20/12/2012
DCM-S	FD198	Mycoplasma Cultivation Supplement	Low risk	20/12/2012
DCM-S	FD201	Albumin Glucose Supplement	Low risk	20/12/2012
DCM-S	FD212	L. mono Selective Supplement I	Low risk	20/12/2012
DCM-S	FD212B	L. mono Selective Supplement I	Low risk	04/07/2018
DCM-S	FD213	L. mono Selective Supplement II	Low risk	20/12/2012
DCM-S	FD214	L. mono Enrichment Supplement I	Low risk	20/12/2012
DCM-S	FD215	Vitamino Growth Supplement, Modified (Twin Pack)	Low risk	20/12/2012
DCM-S	FD215B	Vitamino Growth Supplement, Modified	Low risk	22/04/2019
DCM-S	FD227	L. mono Enrichment Supplement II	Low risk	20/12/2012

DCM-S	FD229	MeReSa Selective Supplement	Low risk	20/12/2012
DCM-S	FD230	HiCrome EC 0157: H7 Selective Supplement	Low risk	22/04/2019
DCM-S	FD232	Burkholderia Cepacia Selective Supplement	Low risk	20/12/2012
DCM-S	FD233	Vancomycin Supplement	Low risk	20/12/2012
DCM-S	FD236	Sorbic Acid Supplement	Low risk	20/12/2012
DCM-S	FD241	Poctri supplement	Low risk	25/08/2016
DCM-S	FD242	Legionella Selective Supplement(GVPN)	Low risk	20/12/2012
DCM-S	FD243	Clostridium Difficile Supplement	Low risk	20/12/2012
DCM-S	FD246	Cefixime Supplement	Low risk	20/12/2012
DCM-S	FD247	ECO157:H7 Selective Supplement	Low risk	22/04/2019
DCM-S	FD248	Coagulase Plasma	Low risk	04/07/2018
DCM-S	FD248A	Coagulase Plasma w/ EDTA (From Rabbit)	Low risk	22/04/2019
DCM-S	FD248B	Rabbit plasma with EDTA and 15% NaCl	Low risk	22/04/2019
DCM-S	FD248R	Coagulase Supplement for Staphilococci >>>>	Low risk	22/04/2019
DCM-S	FD252	Gentamycin Selective Supplement	Low risk	22/04/2019
DCM-S	FD253	Urea Solution	Low risk	20/12/2012
DCM-S	FD254	Ureaplasma Selective Supplement	Low risk	04/07/2018
DCM-S	FD255	Ureaplasma Growth Supplement	Low risk	20/12/2012
DCM-S	FD259	Cefoxitin Supplement	Low risk	20/12/2012
DCM-S	FD261	Vancomycin Supplement	Low risk	20/12/2012
DCM-S	FD266	Listeria Moxalactam Supplement Modified	Low risk	20/12/2012
DCM-S	FD269	OPBBL Selective Supplement	Low risk	25/11/2017
DCM-S	FD271	MDR Acinetobacter Selective Supplement	Low risk	25/08/2016
DCM-S	FD274	HiCrome Selective Salmonella Agar Supplement	Low risk	22/04/2019
DCM-S	FD277	HiCrome™ VRE Agar supplement	Low risk	20/12/2012
DCM-S	FD278	HiCrome™ ESBL Agar Supplement	Low risk	20/12/2012
DCM-S	FD279	HiCrome™ KPC Agar Supplement	Low risk	20/12/2012
DCM-S	FD283R	HiCrome™ Candida Differential Selective Supplement	Low risk	20/12/2012
DCM-S	FD284	Acriflavin-Cefsulodin-Vancomycin Supplement (ACV Supplement)	Low risk	20/12/2012
DCM-S	FD285	Bifidobacterium Selective Supplement	Low risk	20/12/2012
DCM-S	FD286	Yersinia Selective Supplement	Low risk	20/12/2012
DCM-S	FD287	Growth Supplement I for MSM	Low risk	20/12/2012
DCM-S	FD288	Growth Supplement II for MSM	Low risk	20/12/2012
DCM-S	FD290	Novobiocin Selective Supplement	Low risk	20/12/2012
DCM-S	FD295	HiCrome ECO157:H7 Selective Supplement Modified	Low risk	22/04/2019
DCM-S	FD299	Selective Supplement for MRSA	Low risk	20/12/2012
DCM-S	FD300	Hayflick Supplement	Low risk	20/12/2012
DCM-S	FD302	Group A Selective Supplement	Low risk	20/12/2012
DCM-S	FD306	Modified Listeria Oxford Selective Supplement	Low risk	22/04/2019
DCM-S	FD309	Monensin Selective Supplement	Low risk	22/04/2019

DCM-S	FD312	VIA Supplement	Low risk	20/12/2012
DCM-S	FD319	MRSA Supplement	Low risk	25/08/2016
DCM-S	FD319R	MeReSa Selective Supplement (MRSA Selective Supplement)	Low risk	25/08/2016
DCM-S	FD320	C. diff Selective Supplement	Low risk	25/08/2016
DCM-S	FD321	TVCSB Supplement	Low risk	25/08/2016
DCM-S	FD322	Middlebrook ADC Growth Supplement, Modified	Low risk	25/08/2016
DCM-S	FD323	TSBV Supplement	Low risk	25/08/2016
DCM-S	FD324	Bacillus Selective Supplement	Low risk	25/08/2016
DCM-S	FD327	NAD Supplement	Low risk	25/08/2016
DCM-S	FD329	Middlebrook OADC Enrichment Supplement	Low risk	25/08/2016
DCM-S	FD334	Mycoplasma selective supplement	Low risk	25/08/2016
DCM-S	FD335	Leeds Acinetobacter selective supplement	Low risk	25/08/2016
DCM-S	FD335R	MDR Acinetobacter Selective Supplement	Low risk	25/08/2016
DCM-S	FD338	LCN Supplement	Low risk	25/08/2016
DCM-S	FD340	PACT Supplement	Low risk	28/04/2017
DCM-S	FD343	Growth Supplement for Fastidious Organism	Low risk	16/12/2017
DCM-S	FD344	ECC Selective Supplement Modified	Low risk	22/04/2019
DCM-S	FD347	PCP Supplement	Low risk	04/07/2018
DCM-S	FD348	OADS Supplement	Low risk	16/12/2017
DCM-S	FD349	Vancomycin Polymyxin B Supplement	Low risk	04/07/2018
DCM-S	FD352	Acinetobacter Selective Supplement	Low risk	30/10/2018
DCM-S	FD353	VCAT Supplement	Low risk	30/10/2018
DCM-S	FD354	STEC Selective Supplement	Low risk	30/10/2018
DCM-S	FD355	HiCrome™ Colistin Resistant Selective Supplement	Low risk	30/10/2018
DCM-S	FD356	Diphenyl supplement	Low risk	22/04/2019
DCM-S	FD725R	Mycoprep (Modified, Bulk powder)	Low risk	25/08/2016
DCM-S	FD726	Mycoprep (Modified, powder for 1000ml)	Low risk	25/08/2016
DCM-S	FD743R	Bifido Selective Supplement C	Low risk	25/08/2016
DCM-S	FD744R	Bifido Selective Supplement D	Low risk	25/08/2016
DCM-S	FD745R	Bifido Selective Supplement E	Low risk	25/08/2016
DCM-S	FD749	Supplement for HiCrome™ Candida Agar	Low risk	04/07/2018
DCM-S	FD750	L. J. Media Supplement w/ Capreomycin	Low risk	25/08/2016
DCM-S	FD751	L. J. Medium Supplement w/ Clarithromycin	Low risk	25/08/2016
DCM-S	FD752	L. J. Media Supplement w/ D-Cycloserine	Low risk	25/08/2016
DCM-S	FD753	L. J. Media Supplement w/ Ethambutol	Low risk	25/08/2016
DCM-S	FD754	L. J. Media Supplement w/ Ethionamide	Low risk	25/08/2016
DCM-S	FD755	L. J. Medium Supplement w/ Gatifloxacin	Low risk	25/08/2016
DCM-S	FD756	L. J. Media Supplement w/ Isoniazide	Low risk	25/08/2016
DCM-S	FD757	L. J. Media Supplement w/ Kanamycin	Low risk	25/08/2016
DCM-S	FD758	L. J. Medium Supplement w/ Levofloxacin	Low risk	25/08/2016
DCM-S	FD759	L. J. Medium Supplement w/ Lomefloxacin	Low risk	04/07/2018

DCM-S	FD760	L. J. Medium Supplement w/ Ofloxacin	Low risk	04/07/2018
DCM-S	FD761	L. J. Medium Supplement w/ p-Aminosalicylic acid	Low risk	04/07/2018
DCM-S	FD762	L. J. Medium Supplement w/ Pyrazinamide	Low risk	04/07/2018
DCM-S	FD763	L.J.Medium Supplementw/Rifabutin	Low risk	04/07/2018
DCM-S	FD764	L.J.Medium Supplementw/Rifampicin	Low risk	04/07/2018
DCM-S	FD765	L.J.Medium Supplementw/Sodium Salicylate	Low risk	04/07/2018
DCM-S	FD766	L.J.Medium Supplementw/Streptomycin	Low risk	04/07/2018
DCM-S	FD767	L.J.Medium Supplementw/TCH	Low risk	04/07/2018
DCM-S	FD768	Chloramphenicol Supplement	Low risk	04/07/2018
DCM-S	FD772	L.J. Media Supplement w/Amikacin	Low risk	04/07/2018
DCM-S	FD775	L.J. Media Supplement w/ p-Nitrobenzoic acid	Low risk	04/07/2018
DCM-S	FD780	L.J. Media Supplement w/Moxifloxacin	Low risk	04/07/2018
DCM-S	FD804	Enriched growth Supplement for Mycobacteria	Low risk	04/07/2018

Product group	Type/ Model / Ref number	Device Name	Risk Class	Date of CE compliance
Product Group 2: Ready Prepared Media		Registration No: NL-CA002-26448		
RPM - Ready Prepared Plates	HB001	HiCombi™ Nutrient - MacConkey Agar Plate	Low risk	20/12/2012
RPM - Ready Prepared Plates	HB003	HiCombi™ CLED - MacConkey Agar Plate	Low risk	20/12/2012
RPM - Ready Prepared Plates	HB004	HiCombi™ XLD - MacConkey Agar Plate	Low risk	20/12/2012
RPM - Ready Prepared Plates	HB005	HiCombi™ Cetrimide - MacConkey Agar Plate	Low risk	20/12/2012
RPM - Ready Prepared Plates	HB006	HiCombi™ Blood- MacConkey Agar Plate	Low risk	20/12/2012
RPM - Ready Prepared Plates	HB007	HiCombi™ MacConkey-Mannitol Salt Agar	Low risk	20/12/2012
RPM - Ready Prepared Plates	HB008	HiCombi™ Blood -Chocolate Agar	Low risk	20/12/2012
RPM - Ready Prepared Plates	HB009	HiCombi™ Blood -Mannitol Salt Agar	Low risk	20/12/2012
RPM - Ready Prepared Plates	HB010	HiCombi™ Chocolate - MacConkey Agar Plate	Low risk	20/12/2012
RPM- HiDip Slides	HD001	HiDip™ Cled-Cetri-Mac Medium	Low risk	20/12/2012
RPM- HiDip Slides	HD002	HiDip™ Mac-Cled-Sab Medium	Low risk	20/12/2012
RPM- HiDip Slides	HD003	HiDip™ Mac-Cled-Bile Esculin Medium	Low risk	20/12/2012
RPM- HiDip Slides	HD004	HiDip™ Cled-Mac Medium	Low risk	20/12/2012
RPM- HiDip Slides	HD005	HiDip™ Cled-MUG Mac Medium	Low risk	20/12/2012
RPM- HiDip Slides	HD006	HiDip™ Cled-HiCrome™ UTI Medium	Low risk	20/12/2012
RPM- HiDip Slides	HD007	HiDip™ Mac-HiCrome™ UTI Medium	Low risk	20/12/2012
RPM- HiDip Slides	HD018	HiDip™ TSA-CLED Agar w/ B.T.B Indicator Medium	Low Risk	20/12/2012
RPM- HiDip Slides	HD020	HiDip™ Pseudomonas Agar - MacConkey Agar Medium	Low risk	20/12/2012
RPM- HiDip Slides	HD021	HiDip™ PCA - MacConkey Agar Medium	Low risk	20/12/2012
RPM- HiDip Slides	HD024	HiDip™ Modified Rogosa Medium-Modified Rogosa Medium	Low risk	20/12/2012
RPM- HiDip Slides	HD025	HiDip™ Modified Nickerson Medium-Modified Nickerson Medium	Low risk	20/12/2012
RPM- HiDip Slides	HD041	HiDip HiCrome™ Universal Agar-PCA	Low risk	28/04/2017
RPM- HiDip Slides	HD042	HiDip HiCrome™ UTI Agar - Dey Engley Neutralzing agar	Low risk	28/04/2017
RPM- HiDip Slides	HD046	HiDip TSA-TCBS	Low risk	30/10/2018
RPM- HiDip Slides	HD047	HiDip TSA-MRS	Low risk	30/10/2018
RPM- HiSafe Blood Culturing System	LQ003	BHI	Low risk	20/12/2012
RPM- HiSafe Blood Culturing System	LQ003A	BHI	Low risk	20/12/2012
RPM- HiSafe Blood Culturing System	LQ004	BHI - Supplemented w/ 0.05% SPS	Low risk	20/12/2012
RPM- HiSafe Blood Culturing System	LQ004A	BHI - Supplemented w/ 0.05% SPS	Low risk	20/12/2012

RPM- HiSafe Blood Culturing System	LQ005	TSB - Tryptone Soya Broth w/ 10% Sucrose	Low risk	20/12/2012
RPM- HiSafe Blood Culturing System	LQ005A	TSB - Tryptone Soya Broth w/ 10% Sucrose	Low risk	20/12/2012
RPM- HiSafe Blood Culturing System	LQ006	Columbia Broth	Low risk	20/12/2012
RPM- HiSafe Blood Culturing System	LQ006A	Columbia Broth	Low risk	20/12/2012
RPM- HiSafe Blood Culturing System	LQ007	Thioglycollate Broth	Low Risk	20/12/2012
RPM- HiSafe Blood Culturing System	LQ007A	Thioglycollate Broth	Low Risk	20/12/2012
RPM- HiSafe Blood Culturing System	LQ008	Schaedler Broth	Low Risk	20/12/2012
RPM- HiSafe Blood Culturing System	LQ008A	Schaedler Broth	Low Risk	20/12/2012
RPM- HiSafe Blood Culturing System	LQ009	TSB - Tryptone Soya Broth	Low risk	20/12/2012
RPM- HiSafe Blood Culturing System	LQ009A	TSB - Tryptone Soya Broth	Low risk	20/12/2012
RPM- HiSafe Blood Culturing System	LQ010	Glucose Broth Supplemented w/ 0.05% SPS	Low risk	20/12/2012
RPM- HiSafe Blood Culturing System	LQ010A	Glucose Broth Supplemented w/ 0.05% SPS	Low risk	20/12/2012
RPM- HiSafe Blood Culturing System	LQ010V	Glucose Broth supplemented w/0.05% SPS	Low risk	22/04/2019
RPM- HiSafe Blood Culturing System	LQ011	TSB - Tryptone Soya Broth Supplemented w/ 0.05% SPS	Low risk	20/12/2012
RPM- HiSafe Blood Culturing System	LQ011A	TSB - Tryptone Soya Broth Supplemented w/ 0.05% SPS	Low risk	20/12/2012
RPM- HiSafe Blood Culturing System	LQ013V	Hartley Broth	Low risk	22/04/2019
RPM- HiSafe Blood Culturing System	LQ014	Modified Wilkins Chalgren Broth	Low risk	20/12/2012
RPM- HiSafe Blood Culturing System	LQ014A	Modified Wilkins Chalgren Broth	Low risk	20/12/2012
RPM- HiSafe Blood Culturing System	LQ012	HiCombi™ Dual Performance Medium	Low Risk	20/12/2012
RPM- HiSafe Blood Culturing System	LQ013	Hartley Broth	Low Risk	20/12/2012
RPM- HiSafe Blood Culturing System	LQ013A	Hartley Broth	Low Risk	20/12/2012
RPM- HiSafe Blood Culturing System	LQ023	Fluid thioglycollate Medium w/0.05% SPS	Low Risk	20/12/2012
RPM- HiSafe Blood Culturing System	LQ023A	Fluid thioglycollate Medium w/0.05% SPS	Low Risk	20/12/2012
RPM- Ready Prepared Dual Media	LQ029	HiCombi™ Dual Performance Salmonella Medium - SS	Low Risk	20/12/2012
RPM- Ready Prepared Dual Media	LQ029A	HiCombi™ Dual Performance Salmonella Medium - SS	Low Risk	20/12/2012
RPM- Ready Prepared Dual Media	LQ030	HiCombi™ Dual Performance Salmonella Medium - XLD	Low risk	20/12/2012
RPM- Ready Prepared Dual Media	LQ030A	HiCombi™ Dual Performance Salmonella Medium - XLD	Low risk	20/12/2012
RPM- Ready Prepared Dual Media	LQ031	HiCombi™ Dual Performance Salmonella Medium - DCA	Low risk	20/12/2012
RPM- Ready Prepared Dual Media	LQ031A	HiCombi™ Dual Performance Salmonella Medium - DCA	Low risk	20/12/2012
RPM- Ready Prepared Dual Media	LQ032	HiCombi™ Dual Performance Salmonella Medium - HEA	Low risk	20/12/2012
RPM- Ready Prepared Dual Media	LQ032A	HiCombi™ Dual Performance Salmonella Medium - HEA	Low risk	20/12/2012
RPM- Ready Prepared Dual Media	LQ033	HiCombi™ Dual Performance Medium	Low risk	20/12/2012
RPM- Ready Prepared Dual Media	LQ034	HiCombi™ Dual Performnace Fungal Medium Kit	Low risk	20/12/2012
RPM- Ready Prepared Dual Media	LQ034A	HiCombi™ Dual Performnace Fungal Medium Kit	Low Risk	20/12/2012
RPM- Ready Prepared Dual Media	LQ035	HiCombi™ Dual Performance Selective Medium - HEA	Low risk	20/12/2012
RPM- Ready Prepared Dual Media	LQ035A	HiCombi™ Dual Performance Selective Medium - HEA	Low risk	20/12/2012
RPM- Ready Prepared Dual Media	LQ036	HiCombi™ Dual Performance Selective Medium - SS	Low risk	20/12/2012
RPM- Ready Prepared Dual Media	LQ036A	HiCombi™ Dual Performance Selective Medium - SS	Low risk	20/12/2012
RPM- Ready Prepared Dual Media	LQ037	HiCombi™ Dual Performance Selective Medium - HEA	Low risk	20/12/2012
RPM- Ready Prepared Dual Media	LQ038	HiCombi™ Dual Performance Selective Medium - SS	Low risk	20/12/2012
RPM- Ready Prepared Dual Media	LQ038A	HiCombi™ Dual Performance Selective Medium - SS	Low risk	25/08/2016
RPM- Ready Prepared Liquid Medium	LQ004AI	BHI-Supplemented w/0.05% SPS	Low risk	25/08/2016
RPM- Ready Prepared Liquid Medium	LQ004AL	BHI-Supplemented w/0.05% SPS	Low risk	25/08/2016
RPM- Ready Prepared Liquid Medium	LQ004V	BHI - Supplemented w/ 0.05% SPS	Low risk	25/08/2016
RPM- Ready Prepared Liquid Medium	LQ0151	Medium 11. GN Broth	Low risk	04/07/2018
RPM- Ready Prepared Liquid Medium	LQ069	Alkaline Peptone Water	Low Risk	20/12/2012
RPM- Ready Prepared Liquid Medium	LQ069R	Enrichment Medium For Vibrio	Low Risk	25/08/2016
RPM- Ready Prepared Liquid Medium	LQ070	Selenite Broth	Low risk	20/12/2012
RPM- Ready Prepared Liquid Medium	LQ070V	Selenite Broth	Low Risk	25/08/2016
RPM- Ready Prepared Liquid Medium	LQ077	BHI Broth	Low risk	20/12/2012
RPM- Ready Prepared Liquid Medium	LQ077V	BHI Broth	Low risk	20/12/2012
RPM- Ready Prepared Liquid Medium	LQ077R	Enrichment Medium	Low risk	25/08/2016
RPM- Ready Prepared Liquid Medium	LQ079	Bile Broth	Low Risk	20/12/2012
RPM- Ready Prepared Liquid Medium	LQ079V	Bile Broth	Low Risk	22/04/2019

RPM- Ready Prepared Liquid Medium	LQ080	Cooked M Medium	Low Risk	20/12/2012
RPM- Ready Prepared Liquid Medium	LQ080C	Cooked M Medium	Low Risk	04/07/2018
RPM- Ready Prepared Liquid Medium	LQ080V	Cooked M Medium	Low Risk	20/12/2012
RPM- Ready Prepared Liquid Medium	LQ088	Tetrathionate Broth	Low risk	20/12/2012
RPM- Ready Prepared Liquid Medium	LQ089	Peptone Water	Low risk	04/07/2018
RPM- Ready Prepared Liquid Medium	LQ089X	Peptone Water	Low risk	04/07/2018
RPM- Ready Prepared Liquid Medium	LQ093	Cooked M Medium w/ Glucose, Hemin & Vitamin K	Low Risk	20/12/2012
RPM- HiSafe Blood Culturing System	LQ095	Hartley Broth w/ 0.05% SPS	Low Risk	20/12/2012
RPM- HiSafe Blood Culturing System	LQ095A	Hartley Broth w/ 0.05% SPS	Low Risk	20/12/2012
RPM- Ready Prepared Liquid Medium	LQ104	Rappaport Vassiliadis Salmonella Enrichment Broth	Low Risk	20/12/2012
RPM- Ready Prepared Liquid Medium	LQ104C	Rappaport Vassiliadis Salmonella Enrichment Broth	Low Risk	04/07/2018
RPM- Ready Prepared Liquid Medium	LQ104V	Rappaport Vassiliadis Salmonella Enrichment Broth	Low Risk	20/12/2012
RPM- Ready Prepared Liquid Medium	LQ104XX	Rappaport Vassiliadis Salmonella Enrichment Broth	Low Risk	28/04/2017
RPM- Ready Prepared Liquid Medium	LQ105	Kirchner Medium Base	Low Risk	20/12/2012
RPM- Ready Prepared Dual Media	LQ109	HiCombi™ Dual Performance Trans Isolate Medium	Low risk	20/12/2012
RPM- Ready Prepared Liquid Medium	LQ126	Urea Indole Medium	Low risk	04/07/2018
RPM- Ready Prepared Liquid Medium	LQ129	Sabouraud's Dextrose Broth	Low risk	04/07/2018
RPM- Ready Prepared Liquid Medium	LQ129V	Sabouraud's Dextrose Broth	Low risk	25/08/2016
RPM- Ready Prepared Liquid Medium	LQ132	Campylo Thioglycollate Broth w/Selective Supplement	Low Risk	20/12/2012
RPM- Ready Prepared Liquid Medium	LQ134	L Broth	Low Risk	20/12/2012
RPM- Ready Prepared Liquid Medium	LQ146	Mannitol Selenite Broth	Low risk	20/12/2012
RPM- Ready Prepared Liquid Medium	LQ157	GN Broth, Hajna	Low risk	20/12/2012
RPM- Ready Prepared Liquid Medium	LQ159	Hayflick Medium	Low risk	20/12/2012
RPM- Ready Prepared Liquid Medium	LQ170	Selective Enrichment Medium For Group B	Low risk	25/08/2016
RPM- Ready Prepared Liquid Medium	LQ180V	Bruceella Broth	Low risk	20/12/2012
RPM- Ready Prepared Liquid Medium	LQ181V	Mannitol Salt Broth	Low risk	20/12/2012
RPM- Ready Prepared Liquid Medium	LQ182V	Mueller Hinton Broth	Low risk	20/12/2012
RPM- HiSafe Blood Culturing System	LQ188	HiCombi™ Dual Performance Fungal Medium, Modified	Low risk	20/12/2012
RPM- HiSafe Blood Culturing System	LQ208	Eugonic LT100 Broth	Low Risk	22/04/2019
RPM- Ready Prepared Liquid Medium	LQ208L	Eugonic LT100 Broth	Low risk	28/04/2017
RPM- Ready Prepared Liquid Medium	LQ208CCL	Eugonic LT100 Broth	Low risk	28/04/2017
RPM- Ready Prepared Liquid Medium	LQ210C	BHI Broth	Low risk	20/12/2012
RPM- Ready Prepared Liquid Medium	LQ210D	BHI Broth	Low risk	20/12/2012
RPM- Ready Prepared Dual Media	LQ241	HiCombi Trans Isolate Medium	Low risk	28/04/2017
RPM- Ready Prepared Liquid Medium	LQ246CCL	Sauton's Fluid Medium Base	Low risk	16/12/2017
RPM -Ready Prepared Plates	MP001	Nutrient Agar Plate	Low Risk	20/12/2012
RPM -Ready Prepared Plates	MP001L	Nutrient Agar Plate (150mm plate)	Low Risk	20/12/2012
RPM -Ready Prepared Plates	MP015	Hoyles Media Plate with supplements.	Low Risk	20/12/2012
RPM -Ready Prepared Plates	MP016	Brilliant Green Agar, Modified Plate	Low Risk	30/10/2018
RPM -Ready Prepared Plates	MP022	EMB Agar, Levine Plate	Low Risk	20/12/2012
RPM -Ready Prepared Plates	MP023	Vogel Johnson Agar Plate (V.J. Agar Plate)	Low Risk	22/04/2019
RPM -Ready Prepared Plates	MP024	Cetrimide Agar Plate	Low Risk	20/12/2012
RPM -Ready Prepared Plates	MP029	Endo Agar Plate	Low Risk	20/12/2012
RPM -Ready Prepared Plates	MP031	Xylose Lysine Deoxycholate Agar (XLD Agar) Plate	Low risk	20/12/2012
RPM -Ready Prepared Plates	MP043	Baird Parker Agar Plate	Low risk	25/08/2016
RPM -Ready Prepared Plates	MP043L	Baird Parker Agar Plate	Low risk	04/07/2018
RPM -Ready Prepared Plates	MP043M	Baird Parker Agar Plate (150mm)	Low risk	16/12/2017
RPM -Ready Prepared Plates	MP049	Violet Red Bile Agar Plate	Low risk	16/12/2017
RPM -Ready Prepared Plates	MP063	Sabouraud Dextrose Agar Plate	Low Risk	20/12/2012
RPM -Ready Prepared Plates	MP063L	Sabouraud Dextrose Agar Plate (150 mm plate)	Low Risk	20/12/2012
RPM -Ready Prepared Plates	MP063M	Sabouraud Dextrose Agar Plate (120 mm plate)	Low Risk	20/12/2012
RPM -Ready Prepared Plates	MP065	Deoxycholate Citrate Agar Plate	Low Risk	30/10/2018
RPM -Ready Prepared Plates	MP074	Bruceella Agar Plate	Low Risk	22/04/2019
RPM -Ready Prepared Plates	MP081	MacConkey Agar w/ 0.15% Bile Salts, CV and NaCl Plate	Low risk	20/12/2012
RPM -Ready Prepared Plates	MP081XL	MacConkey Agar w/ 0.15% Bile Salts, CV and NaCl Plate (200mm plate)	Low risk	20/12/2012
RPM -Ready Prepared Plates	MP082	MacConkey Agar w/o CV, NaCl w/ 0.5% Sodium Taurocholate Plate	Low risk	20/12/2012
RPM -Ready Prepared Plates	MP091	Plate Count Agar Plate	Low risk	16/12/2017

RPM -Ready Prepared Plates	MP103	Chocolate Agar Plate	Low Risk	20/12/2012
RPM -Ready Prepared Plates	MP108	SS Agar (Salmonella Shigella Agar) Plate	Low risk	20/12/2012
RPM -Ready Prepared Plates	MP1039	Brucella Agar Plate with Hemin & Vitamin K1	Low Risk	20/12/2012
RPM -Ready Prepared Plates	MP1057	G. vaginalis Selective Agar Plate	Low Risk	30/10/2018
RPM -Ready Prepared Plates	MP1067	Sabouraud Chloramphenicol Agar Plate	Low Risk	20/12/2012
RPM -Ready Prepared Plates	MP1084	Mueller Hinton Agar No. 2 Plate	Low Risk	20/12/2012
RPM -Ready Prepared Plates	MP118	Mannitol Salt Agar Plate	Low Risk	20/12/2012
RPM -Ready Prepared Plates	MP1259	Haemophilus Test Agar Plate	Low Risk	30/10/2018
RPM -Ready Prepared Plates	MP1260	Tellurite Blood Agar Plate	Low Risk	20/12/2012
RPM -Ready Prepared Plates	MP1297A	HiCrome™TM Candida Differential Agar Plate	Low Risk	20/12/2012
RPM -Ready Prepared Plates	MP1301	Sheep Blood Agar Plate	Low risk	20/12/2012
RPM -Ready Prepared Plates	MP1301C	Sheep Blood Agar Plate (Individually Packed)	Low risk	28/04/2017
RPM -Ready Prepared Plates	MP1301M	Sheep Blood Agar Plate	Low risk	04/07/2018
RPM -Ready Prepared Plates	MP1259	Haemophilus Test Agar Plate	Low risk	30/10/2018
RPM -Ready Prepared Plates	MP1345	Anaerobic Blood Agar Plate w/Neomycin	Low risk	30/10/2018
RPM -Ready Prepared Plates	MP1353	HiCrome™ UTI Agar Plate	Low risk	20/12/2012
RPM -Ready Prepared Plates	MP137	Malt Extract Agar Plate	Low risk	30/10/2018
RPM -Ready Prepared Plates	MP144	Columbia 5% Sheep Blood Agar Plate	Low risk	20/12/2012
RPM -Ready Prepared Plates	MP1454	Oxacillin Resistant Screening Agar Plate	Low Risk	20/12/2012
RPM -Ready Prepared Plates	MP1594	MeReSa Agar Plate	Low Risk	30/10/2018
RPM -Ready Prepared Plates	MP160	DCLS Agar Plate	Low Risk	30/10/2018
RPM -Ready Prepared Plates	MP1600	HiCrome™ Universal Agar Plate	Low Risk	20/12/2012
RPM -Ready Prepared Plates	MP1640	Burkholderia Cepacia Agar Plate	Low Risk	04/07/2018
RPM -Ready Prepared Plates	MP1674	HiCrome™ MeReSa Agar Plate	Low Risk	20/12/2012
RPM -Ready Prepared Plates	MP1702	MacConkey Agar RS Plate	Low Risk	30/10/2018
RPM -Ready Prepared Plates	MP173	Mueller Hinton Agar Plate	Low Risk	20/12/2012
RPM -Ready Prepared Plates	MP173C	Mueller Hinton Agar Plate (100 mm Plate)	Low Risk	20/12/2012
RPM -Ready Prepared Plates	MP173L	Mueller Hinton Agar Plate (150mm plate)	Low Risk	20/12/2012
RPM -Ready Prepared Plates	MP173M	Mueller Hinton Agar Plate (120mm plate)	Low Risk	20/12/2012
RPM -Ready Prepared Plates	MP173XL	Mueller Hinton Agar Plate (200mm plate)	Low Risk	20/12/2012
RPM -Ready Prepared Plates	MP173SP	Mueller Hinton Agar Plate (150 mm scored plate)	Low Risk	20/12/2012
RPM -Ready Prepared Plates	MP175	Bordet Gengou Agar Plate w/15% Sheep blood	Low Risk	25/08/2016
RPM -Ready Prepared Plates	MP175SB	Bordet Gengou Agar Plate with 25% Sheep Blood	Low Risk	20/12/2012
RPM -Ready Prepared Plates	MP1763	VRE Agar Plate	Low Risk	30/10/2018
RPM -Ready Prepared Plates	MP180	Lead Acetate Agar Plate	Low risk	20/12/2012
RPM -Ready Prepared Plates	MP1806	Mueller Hinton Agar plate w/ 5% Sheep Blood	Low Risk	20/12/2012
RPM -Ready Prepared Plates	MP1806M	Mueller Hinton Agar plate w/ 5% Sheep Blood	Low Risk	04/07/2018
RPM -Ready Prepared Plates	MP1825	Mueller Hinton Agar Plate with 2% Glucose w/Methylene Blue	Low Risk	20/12/2012
RPM -Ready Prepared Plates	MP1829	HiCrome™ ESBL Agar Plate	Low Risk	30/10/2018
RPM -Ready Prepared Plates	MP1831	HiCrome™ KPC Agar Plate	Low Risk	28/04/2017
RPM -Ready Prepared Plates	MP1837	HiCrome™ Staph Agar Plate, Modified	Low Risk	28/04/2017
RPM -Ready Prepared Plates	MP1858	Bifidobacterium Agar Modified Plate	Low Risk	20/12/2012
RPM -Ready Prepared Plates	MP188	D.T.M Agar Plate	Low Risk	30/10/2018
RPM -Ready Prepared Plates	MP1925	HiCrome™ VRE Agar Plate	Low Risk	30/10/2018
RPM -Ready Prepared Plates	MP1938	HiCrome™ Acinetobacter Agar Plate	Low Risk	16/12/2017
RPM -Ready Prepared Plates	MP1947	Enriched Tryptone Soya Agar Plate (ETSA)	Low risk	20/12/2012
RPM -Ready Prepared Plates	MP1948	Tryptone Soya Serum Bacitracin Vancomycin Agar (TSBV)	Low risk	20/12/2012
RPM -Ready Prepared Plates	MP1949	Tryptone Soya Agar w/ Hemin & Menadione	Low risk	20/12/2012
RPM -Ready Prepared Plates	MP1966	HiCrome™ Strep B Selective Agar Plate	Low risk	30/10/2018
RPM -Ready Prepared Plates	MP1974	HiCrome™ Rapid MRSA Agar Plate	Low risk	25/08/2016
RPM -Ready Prepared Plates	MP2085	Martin Lewin Agar	Low risk	30/10/2018
RPM -Ready Prepared Plates	MP211	BHI Agar Plate	Low risk	20/12/2012
RPM -Ready Prepared Plates	MP217	Bi.G.G.Y. Agar Plate (Nickerson Agar Plate)	Low risk	20/12/2012
RPM -Ready Prepared Plates	MP291	Schaedler Agar Plate	Low risk	16/12/2017
RPM -Ready Prepared Plates	MP1296	HiCrome™ Salmonella Agar Plate	Low risk	30/10/2018
RPM -Ready Prepared Plates	MP298	MacConkey Sorbitol Agar Plate	Low risk	16/12/2017
RPM -Ready Prepared Plates	MP317	EMB Agar Plate	Low risk	20/12/2012
RPM -Ready Prepared Plates	MP406	Pseudomonas Isolation Agar Plate	Low risk	30/10/2018
RPM -Ready Prepared Plates	MP413	Thayer Martin Agar Plate w/VCNT	Low risk	16/12/2017

RPM -Ready Prepared Plates	MP467	Hektoen Enteric Agar Plate	Low risk	04/07/2018
RPM -Ready Prepared Plates	MP491	Anaerobic Agar (Brewer) Plate	Low risk	04/07/2018
RPM -Ready Prepared Plates	MP540	Phenylethyl Blood Agar Plate w/ 5% Sheep Blood	Low risk	25/08/2016
RPM -Ready Prepared Plates	MP5269	Modified Nickerson Medium	Low risk	30/10/2018
RPM -Ready Prepared Plates	MP5208	CNA Agar Plate with 5% Sheep Blood	Low Risk	20/12/2012
RPM -Ready Prepared Plates	MP5304	Blood agar Plate w/5mg/l Gentamicin	Low risk	25/08/2016
RPM -Ready Prepared Plates	MP5316	Chocolate Agar Plate w/ 5% Sheep Blood	Low risk	28/04/2017
RPM -Ready Prepared Plates	MP5332	Sabouraud Dextrose Agar Plate w/Chloramphenicol & gentamicin	Low risk	04/07/2018
RPM -Ready Prepared Plates	MP5333	Chocolate Agar Plate w/ Bacitracin	Low risk	04/07/2018
RPM -Ready Prepared Plates	MP5334	Sabouraud Dextrose Agar plate w/Penicillin & Streptomycin	Low risk	04/07/2018
RPM -Ready Prepared Plates	MP5339	Regan Lowe Agar Plate (Charcoal Blood Plate w/Cephalexin)	Low risk	16/12/2017
RPM -Ready Prepared Plates	MP5340	Bordet Gengou Blood Agar Plate w/Cephalexin	Low risk	16/12/2017
RPM -Ready Prepared Plates	MP5380	BHI Agar Plate w/ Blood	Low risk	30/10/2018
RPM -Ready Prepared Plates	MP5381	BHI Agar Plate w/ Vancomycin	Low risk	30/10/2018
RPM -Ready Prepared Plates	MP5382	BHI Blood agar plate w/ Vancomycin	Low risk	30/10/2018
RPM -Ready Prepared Plates	MP5383	BCYE Selective Agar Plate	Low risk	30/10/2018
RPM -Ready Prepared Plates	MP5384	GBS Agar	Low risk	30/10/2018
RPM -Ready Prepared Plates	MP5386	Sabouraud Dextrose Agar Plate w/Gentamicin	Low risk	30/10/2018
RPM -Ready Prepared Plates	MP5387	Sabouraud Dextrose Agar Plate w/ Cycloheximide	Low risk	30/10/2018
RPM -Ready Prepared Plates	MP5389	Mueller Hinton Agar Plate w/ 2% NaCl	Low risk	30/10/2018
RPM -Ready Prepared Plates	MP5390	Helicobacter Pylori Selective Agar	Low risk	30/10/2018
RPM -Ready Prepared Plates	MP511	Middlebrook 7H11 Agar w/TCH	Low risk	04/07/2018
RPM -Ready Prepared Plates	MP616	Tergitol-7 Agar Plate	Low risk	25/08/2016
RPM -Ready Prepared Plates	MP641	MRS Agar Plate	Low risk	28/04/2017
RPM -Ready Prepared Plates	MP641-I	MRS Agar w/ 10 ppm cycloheximide	Low risk	28/04/2017
RPM -Ready Prepared Plates	MP664	Sabouraud Dextrose Agar Plate w/Chloramphenicol (50mg/L) and Cycloheximide 500mg/L	Low Risk	20/12/2012
RPM -Ready Prepared Plates	MP792	CLED Agar w/ Bromothymol Blue Plate	Low risk	20/12/2012
RPM -Ready Prepared Plates	MP805	Bacteroides Bile Esculin Agar Plate	Low risk	25/08/2016
RPM -Ready Prepared Plates	MP813I	BCYE Agar Plate	Low risk	30/10/2018
RPM -Ready Prepared Plates	MP843	Yersinia Selective Agar Plate	Low risk	30/10/2018
RPM -Ready Prepared Plates	MP870	TCBS Agar Plate	Low risk	25/08/2016
RPM -Ready Prepared Plates	MP975A	Anaerobic Blood Agar Plate	Low risk	25/08/2016
RPM -Ready Prepared Plates	MP994	Campylobacter Agar Plate	Low risk	20/12/2012
RPM -Ready Prepared Plates	QP001	Middlebrooke 7H11 Agar Plate	Low risk	04/07/2018
RPM- Transport Medium w/ swabs	MQ651P	HiCulture™ Transport Swabs w/ Amies Medium w/ Charcoal	Low risk	20/12/2012
RPM- Transport Medium w/ swabs	MQ5203P	HiCulture™ Transport Swab w/ Enteric Pathogen Transport Medium	Low risk	20/12/2012
RPM- Transport Medium w/ swabs	MQ306P	HiCulture™ Transport Swabs w/ Stuart Transport Medium	Low risk	20/12/2012
RPM- Viral Transport Medium w/ swabs	AL167	HiViral Transport Medium	Low risk	20/12/2012
RPM- Viral Transport Medium w/ swabs	MS052A	HiCulture™ Transport Swabs w/Selenite Medium (A)	Low risk	25/08/2016
RPM- Viral Transport Medium w/ swabs	MS316	HiCulture™ Transport Swabs w/CVTR Medium	Low risk	20/12/2012
RPM- Viral Transport Medium w/ swabs	MS316A	HiCulture™ Transport Swabs w/CVTR Medium,Modified	Low risk	25/08/2016
RPM- Viral Transport Medium w/ swabs	MS1145	HiCulture™ Listeria Isolation and Transport Swabs	Low risk	20/12/2012
RPM- Viral Transport Medium w/ swabs	MS1145S	HiCulture™ Listeria Isolation and Transport Swabs with metal stick	Low risk	20/12/2012
RPM- Transport Medium w/ swabs	MS1514	Hiculture™ Transport swabs w/Modified Campylobacter Thioglycollate Medium	Low risk	25/08/2016
RPM- Transport Medium w/ swabs	MS1557	Hiculture™ Transport swabs w/BHI broth for H.pylori	Low risk	25/08/2016
RPM- Transport Medium w/ swabs	MS1759	Hiculture™ Transport swabs	Low risk	25/08/2016
RPM- Viral Transport Medium w/ swabs	MS2760	HiViral™ Transport Kit	Low risk	20/12/2012
RPM- Viral Transport Medium w/ swabs	MS2760A	HiViral™ Transport Kit (A)	Low risk	20/12/2012

RPM- Viral Transport Medium w/ swabs	MS2760B	HiViral™ Transport Kit (B)	Low risk	20/12/2012
RPM- Viral Transport Medium w/ swabs	MS2760C	HiViral™ Transport Kit (C)	Low risk	20/12/2012
RPM- Viral Transport Medium w/ swabs	MS2760D	HiViral™ Transport Kit (D)	Low risk	20/12/2012
RPM- Viral Transport Medium w/ swabs	MS2760E	HiViral™ Transport Kit (E)	Low risk	20/12/2012
RPM- Viral Transport Medium w/ swabs	MS2760F	HiViral™ Transport Kit (F)	Low risk	20/12/2012
RPM- Viral Transport Medium w/ swabs	MS2760G	HiViral™ Transport Kit (G)	Low risk	20/12/2012
RPM- Viral Transport Medium w/ swabs	MS2760H	HiViral™ Transport Kit (H)	Low risk	28/04/2017
RPM- Transport Medium w/ swabs	MS2016A	HiCulture™ Transport Swabs w/ Soyabean Casein Digest Medium w/6.5% NaCL	Low risk	25/08/2016
RPM- Transport Medium w/ swabs	MS2016B	HiCulture™ Transport Swabs w/ Soyabean Casein Digest Medium w/6.5% NaCL	Low risk	25/08/2016
RPM- Transport Medium w/ swabs	MS202	HiCulture™ Transport Swabs w/ Cary Blair Medium	Low risk	20/12/2012
RPM- Transport Medium w/ swabs	MS202A	HiCulture™ Transport Swabs w/ Cary Blair Medium (A)	Low risk	20/12/2012
RPM- Transport Medium w/ swabs	MS202S	HiCulture™ Transport Swabs w/ Cary Blair Medium with metal stick	Low risk	20/12/2012
RPM- Transport Medium w/ swabs	MS2055	HiCulture™ Transport Medium for Helicobacter pylori	Low risk	28/04/2017
RPM- Transport Medium w/ swabs	MS306	HiCulture™ Transport Swabs w/ Stuart Transport Medium	Low risk	20/12/2012
RPM- Transport Medium w/ swabs	MS306S	HiCulture™ Transport Swabs w/ Stuart Transport Medium with metal stick	Low risk	20/12/2012
RPM- Transport Medium w/ swabs	MS5002	HiCulture™ Transport Swabs w/ 0.85% Sodium chloride and 0.1% Buffered Ppetone Water in polystyrene tube	Low risk	04/07/2018
RPM- Transport Medium w/ swabs	MS5215	HiViral™ Transport Medium for Cloacal Samples	Low risk	25/08/2016
RPM- Transport Medium w/ swabs	MS5296	HiCulture™ Skim Milk Tryptone Glucose Glycerin Medium swabs	Low risk	25/08/2016
RPM- Transport Medium w/ swabs	MS5321	HiCulture Sterile swabs w/ 0.9% Saline	Low risk	22/04/2019
RPM- Transport Medium w/ swabs	MS651	HiCulture™ Transport Swabs w/ Amies Medium w/ Charcoal	Low risk	20/12/2012
RPM- Transport Medium w/ swabs	MS651S	HiCulture™ Transport Swabs w/ Amies Medium w/ Charcoal with metal stick	Low risk	20/12/2012
RPM- Transport Medium w/ swabs	MS684	HiCulture™ Transport Swabs w/ Amies Medium w/o Charcoal	Low risk	20/12/2012
RPM- Transport Medium w/ swabs	MS684A	HiCulture™ Transport Swabs w/ Amies Medium (A)	Low risk	25/08/2016
RPM- Transport Medium w/ swabs	MS684B	HiCulture™ Transport Swabs w/ Amies Medium (B)	Low risk	25/08/2016
RPM- Transport Medium w/ swabs	MS684C	HiCulture™ Transport Swabs w/ Amies Medium (C)	Low risk	25/08/2016
RPM- Transport Medium w/ swabs	MS684D	HiCulture™ Transport Swabs w/ Amies Medium (D)	Low risk	25/08/2016
RPM- Transport Medium w/ swabs	MS684S	HiCulture™ Transport Swabs w/ Amies Medium w/o Charcoal with metal stick	Low risk	20/12/2012
RPM- Transport Medium w/ swabs	MS010	HiCulture™ Transport Swabs w/ Alternative Thioglycollate Medium	Low risk	20/12/2012
RPM- Transport Medium w/ swabs	MS010S	HiCulture™ Transport Swabs w/ Alternative Thioglycollate Medium with metal stick	Low risk	20/12/2012
RPM- Transport Medium w/ swabs	MS113	HiCulture™ Transport Swabs w/ Chlamyospore Medium	Low risk	20/12/2012
RPM- Transport Medium w/ swabs	MS113S	HiCulture™ Transport Swabs w/ Chlamyospore Medium with metal stick	Low risk	20/12/2012
RPM- Transport Medium w/ swabs	MS198S	HiCulture™ Transport Swab w/ Middlebrook 7H9 Broth w/metal stick	Low risk	20/12/2012
RPM- Transport Medium w/ swabs	MS2055	HiCulture™ Transport Medium for w/Helicobacter pylori	Low risk	16/12/2017
RPM- Ready Prepared Medium	MT001	Modified Middlebrook 7H9 Broth with Indicator	Low risk	20/12/2012
RPM- L.J.Medium Slants	SL001	L.J. Medium Slant	Low risk	20/12/2012
RPM- L.J.Medium Slants	SL001H	L.J. Medium in glass bottle	Low risk	04/07/2018
RPM- L.J.Medium Slants	SL001B	L.J. Medium Slant	Low risk	20/12/2012
RPM- L.J.Medium Slants	SL001L	L.J. Medium Slant in long tube	Low risk	20/12/2012
RPM- L.J.Medium Slants	SL001LD	L.J. Medium Slant (in long tube)	Low risk	20/12/2012
RPM- L.J.Medium Slants	SL001M	L.J.Medium Slant (In Medium Length tube)	Low risk	20/12/2012
RPM- L.J.Medium Slants	SL001T	L.J. Medium Slant in thick glass bottles	Low risk	20/12/2012

RPM- L.J.Medium Slants	SL002	L.J.Medium Kit	Low risk	20/12/2012
RPM- L.J.Medium Slants	SL003	L.J.Medium Plus Kit	Low risk	20/12/2012
RPM- L.J.Medium Slants	SL004	L.J.Medium w/ Pyruvate	Low risk	20/12/2012
RPM- L.J.Medium Slants	SL004L	L.J.Medium w/ Pyruvate (0.2%)	Low risk	20/12/2012
RPM- L.J.Medium Slants	SL005	L.J.Medium w/ Streptomycin (4 mcg/ml)	Low risk	20/12/2012
RPM- L.J.Medium Slants	SL005L	L.J.Medium w/Streptomycin (4 mcg / ml)	Low risk	20/12/2012
RPM- L.J.Medium Slants	SL006	L.J.Medium w/ INH	Low risk	20/12/2012
RPM- L.J.Medium Slants	SL007	L.J.Medium Slant w/ Rifampicin (40µg/ml)	Low risk	20/12/2012
RPM- L.J.Medium Slants	SL008	Acid Egg Medium Slant	Low risk	20/12/2012
RPM- L.J.Medium Slants	SL009	Acid Egg Medium Slant w/ pyruvate	Low risk	20/12/2012
RPM- L.J.Medium Slants	SL010	Modified L. J. Medium Plus Kit	Low risk	20/12/2012
RPM- L.J.Medium Slants	SL011	L.J. Medium Slant w/ Ciprofloxacin	Low risk	20/12/2012
RPM- L.J.Medium Slants	SL011L	L.J. Medium Slant w/ Ciprofloxacin (12.5 mcg/ml)	Low risk	20/12/2012
RPM- L.J.Medium Slants	SL012	L.J. Medium Slant w/ Amikacin	Low risk	20/12/2012
RPM- L.J.Medium Slants	SL013	L.J. Medium Slant w/ Clarithromycin	Low risk	20/12/2012
RPM- L.J.Medium Slants	SL014	L.J. Medium Slant w/Ethionamide (20µg/ml)	Low risk	20/12/2012
RPM- L.J.Medium Slants	SL015	L.J. Medium Slant w/Rifabutin (0.5 µg/ml)	Low risk	20/12/2012
RPM- L.J.Medium Slants	SL016	L. J. Medium Plus Kit w/ kanamycin µg/ml)	Low risk	20/12/2012
RPM- L.J.Medium Slants	SL017	L.J. Medium Slant w/ D-Cycloserine (30 µg/ml)	Low risk	20/12/2012
RPM- L.J.Medium Slants	SL017L	L.J. Medium Slant w/ D-Cycloserine (30 µg/ml)	Low risk	20/12/2012
RPM- L.J.Medium Slants	SL018	L.J.Medium w/Pyrazinamide of pH 5.5	Low risk	20/12/2012
RPM- L.J.Medium Slants	SL018L	L.J. Medium Slant w/ Pyrazinamide pH 5.5	Low risk	20/12/2012
RPM- L.J.Medium Slants	SL019	L.M. Slant (Loeffler Medium)	Low risk	20/12/2012
RPM- L.J.Medium Slants	SL020	L.J. Medium w/TCH	Low risk	20/12/2012
RPM- L.J.Medium Slants	SL021	L.J. Medium Slant w/ p-Nitrobenzoic acid (500 µg/ml)	Low risk	20/12/2012
RPM- L.J.Medium Slants	SL021L	L.J. Medium Slant w/ p-Nitrobenzoic acid	Low risk	20/12/2012
RPM- L.J.Medium Slants	SL022	L.J. Medium Slant w/o Glycerol	Low risk	20/12/2012
RPM- L.J.Medium Slants	SL023	Tuberculosis First Line Kit (Total 7 slants)	Low risk	20/12/2012
RPM- L.J.Medium Slants	SL023L	Tuberculosis First Line Kit (Total 7 slants)	Low risk	20/12/2012
RPM- L.J.Medium Slants	SL023LD	Tuberculosis First Line Kit (Total 7slants)	Low risk	20/12/2012
RPM- L.J.Medium Slants	SL023R	Tuberculosis First Line Kit (Total 7 slants)	Low risk	20/12/2012
RPM- L.J.Medium Slants	SL024	Tuberculosis Second Line Kit (Total 10 slants)	Low risk	20/12/2012
RPM- L.J.Medium Slants	SL024L	Tuberculosis Second Line Kit (Total 10 slants)	Low risk	20/12/2012
RPM- L.J.Medium Slants	SL024LD	Tuberculosis Second Line Kit (Total 10 slants)	Low risk	20/12/2012
RPM- L.J.Medium Slants	SL024R	Tuberculosis Second Line Kit (Total 8 slants)	Low risk	20/12/2012
RPM- L.J.Medium Slants	SL025	Dorset Egg Medium Slant	Low risk	20/12/2012
RPM- L.J.Medium Slants	SL026	L.J. Medium Slant w/Streptomycin (5mcg)	Low risk	20/12/2012
RPM- L.J.Medium Slants	SL027	L.J. Medium Slant w/Ethambutol (2mcg)	Low risk	20/12/2012
RPM- L.J.Medium Slants	SL029	L.J. Medium Slant w/P-Amino Salicylic acid	Low risk	20/12/2012
RPM- L.J.Medium Slants	SL029L	L.J. Medium Slant w/ p-Aminosalicylic acid	Low risk	20/12/2012
RPM- Ready Prepared Slants	SL031	Dermatophyte Test Medium Slant	Low risk	20/12/2012
RPM- Ready Prepared Slants	SL032	Kligler Iron Agar Slant	Low risk	20/12/2012
RPM- Ready Prepared Slants	SL033	Motility Indole Lysine Agar Slant	Low risk	20/12/2012
RPM- Ready Prepared Slants	SL034	Simmons Citrate Agar Slant	Low risk	20/12/2012
RPM- Ready Prepared Slants	SL034T	Simmon Citrate Agar Slant in long tubes	Low risk	20/12/2012
RPM- Ready Prepared Slants	SL035	Urea Agar Slant	Low risk	20/12/2012
RPM- Ready Prepared Slants	SL035T	Urea Agar Slant in Tube	Low risk	20/12/2012
RPM- Ready Prepared Slants	SL036	Sabouraud Dextrose Agar Slant	Low risk	20/12/2012
RPM- Ready Prepared Slants	SL036L	Sabouraud Dextrose Agar Slant	Low risk	08/12/2017
RPM- L.J.Medium Slants	SL037	Tuberculosis First Line Plus Kit (Total 9 slants)	Low risk	20/12/2012
RPM- L.J.Medium Slants	SL037R	Tuberculosis First Line Plus Kit (9 slants)	Low risk	20/12/2012
RPM- L.J.Medium Slants	SL038	Tuberculosis Second Line Plus Kit (Total 11 slants)	Low risk	20/12/2012
RPM- L.J.Medium Slants	SL038R	Tuberculosis Second Line Plus Kit (11 slants)	Low risk	20/12/2012
RPM- L.J.Medium Slants	SL038U	Lowenstein - Jensen Medium Slant with tu	Low risk	20/12/2012
RPM- L.J.Medium Slants	SL040	L.J. Medium Slant w/ Moxifloxacin	Low risk	20/12/2012
RPM- Ready Prepared Slants	SL041	Gelatin Agar Slant	Low risk	20/12/2012
RPM- Ready Prepared Slants	SL042	MIU Medium Slant	Low risk	20/12/2012
RPM- Ready Prepared Slants	SL043	Nitrate Agar Slant	Low risk	20/12/2012
RPM- Ready Prepared Slants	SL044	Phenyl Alanine Agar Slant	Low risk	20/12/2012
RPM- Ready Prepared Slants	SL045	Triple Sugar Iron Agar Slant	Low risk	20/12/2012
RPM- Ready Prepared Slants	SL045T	Triple Sugar Iron Agar Slant in Tube	Low risk	20/12/2012

RPM- L.J.Medium Slants	SL047	L.J.Medium Slant w/ Ethambutol (2µg/ml)	Low risk	20/12/2012
RPM- L.J.Medium Slants	SL049	L.J. Medium Slant w/ Ofloxacin (2 µg/ml)	Low risk	20/12/2012
RPM- L.J.Medium Slants	SL049L	L.J Medium Slant w/ Ofloxacin (2µg/ml) (long tube)	Low risk	20/12/2012
RPM- L.J.Medium Slants	SL055L	L.J.Medium Slant w/ Isoniazide (0.2 mcg/ml)	Low risk	20/12/2012
RPM- L.J.Medium Slants	SL061	L.J. Medium Slant w/ Pyrazinamide (50 µg/ml)	Low risk	20/12/2012
RPM- L.J.Medium Slants	SL066	L.J. Medium Slant w/ Capreomycin (20 µg/ml)	Low risk	20/12/2012
RPM- L.J.Medium Slants	SL067	L.J. Medium Slant w/ Capreomycin (40 µg/ml)	Low risk	20/12/2012
RPM- L.J.Medium Slants	SL067L	L.J Medium Slant w/ Capreomycin (40 µg/ml) (long tube)	Low risk	20/12/2012
RPM- L.J.Medium Slants	SL070	L.J. Medium Slant w/ D-Cycloserine (40 µg/ml)	Low risk	20/12/2012
RPM- L.J.Medium Slants	SL071	L.J. Medium Slant w/ Ethambutol (4 µg/ml)	Low risk	20/12/2012
RPM- L.J.Medium Slants	SL072	L.J. Medium Slant w/ Ethambutol (5 µg/ml)	Low risk	20/12/2012
RPM- L.J.Medium Slants	SL076	L.J. Medium Slant w/Ethionamide (40µg/ml)	Low risk	20/12/2012
RPM- L.J.Medium Slants	SL078	L.J. Medium Slant w/ Isoniazide (0.2 µg/ml)	Low risk	20/12/2012
RPM- L.J.Medium Slants	SL079	L.J. Medium Slant w/ Isoniazide (5 µg/ml)	Low risk	20/12/2012
RPM- L.J.Medium Slants	SL081	L.J. Medium Slant w/ Kanamycin (20 µg/ml)	Low risk	20/12/2012
RPM- L.J.Medium Slants	SL081L	L.J. Medium Slant w/ Kanamycin (20µg/ml)	Low risk	20/12/2012
RPM- L.J.Medium Slants	SL082	L.J. Medium Slant w/ Kanamycin (30 µg/ml)	Low risk	20/12/2012
RPM- L.J.Medium Slants	SL091	L.J. Medium Slant w/ p-Aminosalicylic acid (0.25 µg/ml)	Low risk	20/12/2012
RPM- L.J.Medium Slants	SL092	L.J. Medium Slant w/ p-Aminosalicylic acid (0.5 µg/ml)	Low risk	20/12/2012
RPM- L.J.Medium Slants	SL092L	L.J. Medium Slant w/ p-Aminosalicylic acid	Low risk	20/12/2012
RPM- L.J.Medium Slants	SL094	L.J. Medium Slant w/ Ciprofloxacin 2µg/ml	Low risk	20/12/2012
RPM- L.J.Medium Slants	SL098	L.J. Medium Slant w/ Pyruvate (0.2%)	Low risk	20/12/2012
RPM- L.J.Medium Slants	SL099	L.J.Medium Slants w/ Isoniazid (0.2 µg/ml)	Low risk	20/12/2012
RPM- L.J.Medium Slants	SL105L	L.J.Medium Slant w/ Rifampicin (20mcg/ml)	Low risk	20/12/2012
RPM- L.J.Medium Slants	SL107	L.J. Medium Slant w/ Rifampicin (50 µg/ml)	Low risk	20/12/2012
RPM- L.J.Medium Slants	SL109	L.J. Medium Slant w/ Streptomycin (8 µg/ml)	Low risk	20/12/2012
RPM- L.J.Medium Slants	SL110	L.J. Medium Slant w/ Streptomycin (25 µg/ml)	Low risk	20/12/2012
RPM- L.J.Medium Slants	SL115	L.J. Medium Slant w/ Pyrazinamide of pH 5.5	Low risk	20/12/2012
RPM- L.J.Medium Slants	SL115L	L.J. Medium Slant w/ Pyrazinamide pH 5.5	Low risk	20/12/2012
RPM- Ready Prepared Slants	SL116	Rapid UTI Diagnostic Slants	Low risk	20/12/2012
RPM- L.J.Medium Slants	SL120L	L.J. Medium Slant pH 5.5	Low risk	20/12/2012
RPM- L.J.Medium Slants	SL121	HiPyrazide glass tube w/ PYZ agar	Low risk	20/12/2012
RPM- L.J.Medium Slants	SL122	HiCatalase glass tubes w/ 5ml of L.J. medium	Low risk	20/12/2012
RPM- L.J.Medium Slants	SL123	Tuberculosis first line plus kit (Modified)	Low risk	20/12/2012
RPM- L.J.Medium Slants	SL124	L.J. Medium slant (Tubes with Aluminium caps)	Low risk	20/12/2012
RPM- L.J.Medium Slants	SL125	L.J. Medium w/Isoniazid (1.0µg/ml) (Tube)	Low risk	20/12/2012
RPM- L.J.Medium Slants	SL125L	L.J.Medium Slant w/ Isoniazide (1mcg/ml)	Low risk	20/12/2012
RPM- L.J.Medium Slants	SL125M	L.J.Medium Slant w/ Isoniazid in Maccart	Low risk	20/12/2012
RPM- L.J.Medium Slants	SL126	L.J. Medium w/Rifampicin (40.0µg/ml)	Low risk	20/12/2012
RPM- L.J.Medium Slants	SL126L	L.J.Medium Slant w/ Rifampicin (40mcg/ml)	Low risk	20/12/2012
RPM- L.J.Medium Slants	SL126M	L.J.Medium Slant w/ Rifampicin in Maccar	Low risk	20/12/2012
RPM- L.J.Medium Slants	SL127	L.J. Medium w/Ethambutol (2.0µg/ml)	Low risk	20/12/2012
RPM- L.J.Medium Slants	SL127L	L.J. Medium Slant w/Ethambutol (2µg/ml)	Low risk	20/12/2012
RPM- L.J.Medium Slants	SL128	L.J. Medium w/Streptomycin (10.0µg/ml)	Low risk	20/12/2012
RPM- L.J.Medium Slants	SL128L	L.J.Medium w/Streptomycin - 10mcg / Ml	Low risk	20/12/2012
RPM- L.J.Medium Slants	SL129	L.J. Medium w/Ethionamide (30.0µg/ml)	Low risk	20/12/2012
RPM- L.J.Medium Slants	SL130	L.J. Medium w/Kanamycin (30.0µg/ml)	Low risk	20/12/2012
RPM- L.J.Medium Slants	SL130L	L.J. Medium Slant w/ Kanamycin (30µg/ml)	Low risk	20/12/2012
RPM- L.J.Medium Slants	SL131	L.J. Medium w/Ofloxacin (2.0µg/ml)	Low risk	20/12/2012
RPM- L.J.Medium Slants	SL132	L.J. Medium w/Capreomycin (30.0µg/ml)	Low risk	20/12/2012
RPM- L.J.Medium Slants	SL133	L.J. Medium w/P-aminosalicylic acid (1.0	Low risk	20/12/2012
RPM- L.J.Medium Slants	SL136L	Tuberculosis Second Line Kit, Modified	Low risk	20/12/2012
RPM- L.J.Medium Slants	SL141	Modified L. J. Medium Plus Kit	Low risk	20/12/2012
RPM- Ready Prepared Slants	SL142	Cystine Tryptone Agar with 1% Sugars	Low risk	20/12/2012
RPM- Ready Prepared Slants	SL143	Tuberculosis First Line Kit, Modified	Low risk	20/12/2012
RPM- L.J.Medium Slants	SL144	L.J Medium slant w/ Amikacin (1.0 µg/ml)	Low risk	20/12/2012
RPM- L.J.Medium Slants	SL147	L.J. Medium Slant w/Rifampicin (64µg/ml)	Low risk	20/12/2012
RPM- L.J.Medium Slants	SL147	L.J Medium slant w/ Rifampicin (64 µg/ml)	Low risk	20/12/2012

RPM- L.J.Medium Slants	SL148	L.J. Medium Slant w/Ethambutol (6µg/ml)	Low risk	20/12/2012
RPM- L.J.Medium Slants	SL148	L.J Medium slant w/ Ethambutol (6 µg/ml)	Low risk	20/12/2012
RPM- L.J.Medium Slants	SL149	L.J. Medium Slant w/Streptomycin (16µg/ml)	Low risk	20/12/2012
RPM- L.J.Medium Slants	SL149	L.J Medium slant w/ Streptomycin (16 µg/ml)	Low risk	20/12/2012
RPM- L.J.Medium Slants	SL150	L.J Medium slant w/ Streptomycin (32 µg/ml)	Low risk	20/12/2012
RPM- L.J.Medium Slants	SL151	TB Five Antitubercular Kit w/o Control	Low risk	20/12/2012
RPM- L.J.Medium Slants	SL152	Kit for Mycobiograve in Lowenstein Jensen	Low risk	20/12/2012
RPM- L.J.Medium Slants	SL153	Tuberculosis First Line Plus Kit (Modified)	Low risk	20/12/2012
RPM- L.J.Medium Slants	SL154	L.J. Medium Plus Kit (total 9 slants)	Low risk	20/12/2012
RPM- L.J.Medium Slants	SL155L	L.J. Medium Slant w/ TCH	Low risk	20/12/2012
RPM- L.J.Medium Slants	SL156	L.J.Medium Slant w/Rifampicin (128 µg /ml)	Low risk	20/12/2012
RPM- L.J.Medium Slants	SL157	L.J.Medium Slant w/Pyrazinamide pH 5.5	Low risk	20/12/2012
RPM- L.J.Medium Slants	SL158	L.J.Medium Slant w/Ethambutol (8 µg/ml)	Low risk	20/12/2012
RPM- L.J.Medium Slants	SL159	L.J. Medium Slant w/Ethambutol (16 µg/ml)	Low risk	20/12/2012
RPM- L.J.Medium Slants	SL160L	Tuberculosis kit with antitubercular Age	Low risk	20/12/2012
RPM- L.J.Medium Slants	SL161	L.J. Medium Slant w/ Ciprofloxacin (16 µg/ml)	Low risk	20/12/2012
RPM- L.J.Medium Slants	SL162	L.J. Medium Slant w/ Ciprofloxacin	Low risk	20/12/2012
RPM- L.J.Medium Slants	SL163	L.J. Medium Slant w/Amikacin (20 µg/ml)	Low risk	20/12/2012
RPM- L.J.Medium Slants	SL164	L.J. Medium Slant w/Amikacin (700 µg/ml)	Low risk	20/12/2012
RPM- L.J.Medium Slants	SL165L	L.J.Medium w/ Pyruvate (0.48%)	Low risk	20/12/2012
RPM- L.J.Medium Slants	SL166L	Tuberculosis kit with antitubercular Agent	Low risk	20/12/2012
RPM- L.J.Medium Slants	SL167	L.J. Medium slants w/ Augmentin(20µg/ml)	Low risk	20/12/2012
RPM- L.J.Medium Slants	SL168	L.J.Medium Slant w/ Ofloxacin (40µg/ml)	Low risk	25/08/2016
RPM- L.J.Medium Slants	SL168L	L.J.Medium Slant w/ Ofloxacin (40µg/ml) (long tube)	Low risk	20/12/2012
RPM- L.J.Medium Slants	SL169	L.J.Medium Slant w/ Ethionamide (20µg/ml)	Low risk	25/08/2016
RPM- L.J.Medium Slants	SL169L	L.J.Medium Slant w/ Ethionamide (20µg/ml) (long tube)	Low risk	20/12/2012
RPM- L.J.Medium Slants	SL170L	L.J Medium Slant w/ Ethionamide (40µg/ml) (long tube)	Low risk	20/12/2012
RPM- L.J.Medium Slants	SL171L	L.J Medium Slant w/ p-Amino salicylic acid (1µg/ml) (long tube)	Low risk	20/12/2012
RPM- Ready Prepared Slants	SL172	Chocolate Agar Slant	Low risk	20/12/2012
RPM- Ready Prepared Slants	SL173	Nutrient Agar Slant	Low risk	20/12/2012
RPM- Ready Prepared Slants	SL174	B.C.G.-Dextrose Agar Butt (Synder Test Agar)	Low risk	20/12/2012
RPM- L.J.Medium Slants	SL175L	L.J.Medium Slant w/ Amikacin (30mcg/ml)	Low risk	20/12/2012
RPM- L.J.Medium Slants	SL176L	L.J.Medium Slant w/ Ofloxacin (4mcg/ml)	Low risk	20/12/2012
RPM- L.J.Medium Slants	SL177	Tuberculosis First Line Kit, Modified (Total 5 slants)	Low risk	20/12/2012
RPM- L.J.Medium Slants	SL179	L.J.Slopes for BCG Vaccines	Low risk	20/12/2012
RPM- Ready Prepared Slants	SL180	BHI Agar Slant w/5% Sheep Blood	Low risk	20/12/2012
RPM- Ready Prepared Slants	SL181	BHI Agar Slant w/10 % Sheep Blood,Chloramphenicol and Gentamicin	Low risk	20/12/2012
RPM- Ready Prepared Slants	SL182	BHI CC Agar Slant w/10 % Sheep Blood and Gentamicin	Low risk	20/12/2012
RPM- L.J.Medium Slants	SL187	L.J.Medium slants w/ LCN Supplement	Low risk	25/08/2016
RPM- L.J.Medium Slants	SL188L	L.J.Medium Slant w/ Levofloxacin (2 mg/ml)	Low risk	16/12/2017
RPM- L.J.Medium Slants	SL189L	L.J.Medium Slant w/ Levofloxacin (2.5 mg/ml)	Low risk	16/12/2017
RPM- L.J.Medium Slants	SL190	L.J.Medium Slant w/ Rifampicin (20mcg/ml)	Low risk	04/07/2018
RPM- L.J.Medium Slants	SL191	L.J.Medium Slant w/ Amikacin (8mcg/ml)	Low risk	04/07/2018
RPM- L.J.Medium Slants	SL192	L.J.Medium Slant w/ Ofloxacin (5mcg/ml)	Low risk	04/07/2018
RPM- L.J.Medium Slants	SL193	L.J.Medium Slant w/ Levofloxacin (5 mcg/ml)	Low risk	04/07/2018
RPM- L.J.Medium Slants	SL194	L.J.Medium Slant w/ Ethionamide (5 mcg/ml)	Low risk	04/07/2018
RPM- L.J.Medium Slants	SL195	L.J.Medium Slant w/ Ethionamide (25 mcg/ml)	Low risk	04/07/2018
RPM- L.J.Medium Slants	SL196	L.J.Medium Slant w/ Prothionamide (5 mcg/ml)	Low risk	04/07/2018
RPM- L.J.Medium Slants	SL197	L.J.Medium Slant w/ Prothionamide (25 mcg/ml)	Low risk	04/07/2018
RPM- L.J.Medium Slants	SL198	L.J.Medium Slant w/ Linezolid (30 mcg/ml)	Low risk	04/07/2018
RPM- L.J.Medium Slants	SL199	L.J.Medium Slant w/ Clofazimine (1 mcg/ml)	Low risk	04/07/2018
RPM- L.J.Medium Slants	SL202	Middlebrook 7H10 Agar Slant	Low risk	30/10/2018
RPM- L.J.Medium Slants	SL204	L.J. Medium Slant w/ Prothionamide (40 mcg/ml)	Low risk	22/04/2019
RPM- L.J.Medium Slants	SL205	L.J. Medium Slant w/ Amikacin (40 mcg/ml)	Low risk	22/04/2019
RPM- L.J.Medium Slants	SL211	BHI Agar Slant	Low risk	30/10/2018
RPM- L.J.Medium Slants	SL1067L	Sabouraus Chloramphenicol Agar Slant	Low risk	16/12/2017
RPM- Ready Prepared Solid Medium	SM001	Nutrient Agar	Low risk	20/12/2012

RPM- Ready Prepared Solid Medium	SM001CCL	Nutrient Agar	Low risk	22/04/2019
RPM- Ready Prepared Solid Medium	SM001D	Nutrient Agar	Low risk	20/12/2012
RPM- Ready Prepared Solid Medium	SM016C	Brilliant Green Agar, Modified	Low risk	22/04/2019
RPM- Ready Prepared Solid Medium	SM027C	Bismuth Sulphite Agar	Low risk	22/04/2019
RPM- Ready Prepared Solid Medium	SM049D	Violet Red Bile Agar	Low risk	22/04/2019
RPM- Ready Prepared Solid Medium	SM063	Sabouraud Dextrose Agar	Low risk	04/07/2018
RPM- Ready Prepared Solid Medium	SM063D	Sabouraud Dextrose Agar	Low risk	25/08/2016
RPM- Ready Prepared Solid Medium	SM078	Kligler Iron Agar	Low risk	25/08/2016
RPM- Ready Prepared Solid Medium	SM081	MacConkey Agar	Low risk	20/12/2012
RPM- Ready Prepared Solid Medium	SM081D	MacConkey Agar	Low risk	20/12/2012
RPM- Ready Prepared Solid Medium	SM082	MacConkey Agar	Low risk	20/12/2012
RPM- Ready Prepared Solid Medium	SM082D	MacConkey Agar	Low risk	20/12/2012
RPM- Ready Prepared Solid Medium	SM091	Plate Count Agar	Low risk	04/07/2018
RPM- Ready Prepared Solid Medium	SM091D	Plate Count Agar	Low risk	22/04/2019
RPM- Ready Prepared Solid Medium	SM091DCC	Plate Count Agar	Low risk	04/07/2018
RPM- Ready Prepared Solid Medium	SM091M	Plate Count Agar	Low risk	04/07/2018
RPM- Ready Prepared Solid Medium	SM103A	Modified Chocolate Agar Kit w/o Selective	Low risk	25/08/2016
RPM- Ready Prepared Solid Medium	SM103H	Modified Chocolate Agar kit	Low risk	25/08/2016
RPM- Ready Prepared Solid Medium	SM1067	Sabouraud Chloramphenicol Agar Plate	Low risk	04/07/2018
RPM- Ready Prepared Solid Medium	SM1067C	Sabouraud Chloramphenicol Agar Plate	Low risk	04/07/2018
RPM- Ready Prepared Solid Medium	SM1067DCC	Sabouraud Chloramphenicol Agar Plate	Low risk	
RPM- Ready Prepared Solid Medium	SM1067CCL	Sabouraud Chloramphenicol Agar Plate	Low risk	04/07/2018
RPM- Ready Prepared Solid Medium	SM1296D	HiCrome™ Salmonella Agar	Low risk	04/07/2018
RPM- Ready Prepared Solid Medium	SM1297A	HiCrome™ Candida Differential Agar	Low risk	25/08/2016
RPM- Ready Prepared Solid Medium	SM1353	HiCrome™ UTI Agar	Low risk	20/12/2012
RPM- Ready Prepared Solid Medium	SM1353CC	HiCrome™ UTI Agar	Low risk	04/07/2018
RPM- Ready Prepared Solid Medium	SM173	Mueller Hinton Agar	Low risk	20/12/2012
RPM- Ready Prepared Solid Medium	SM173CCL	Mueller Hinton Agar	Low risk	22/04/2019
RPM- Ready Prepared Solid Medium	SM173D	Mueller Hinton Agar	Low risk	20/12/2012
RPM- Ready Prepared Solid Medium	SM211	BHI Agar	Low risk	20/12/2012
RPM- Ready Prepared Solid Medium	SM211D	BHI Agar	Low risk	20/12/2012
RPM- Ready Prepared Solid Medium	SM331C	Wilson Blair Agar	Low risk	22/04/2019
RPM- Ready Prepared Solid Medium	SM434	GC Agar	Low risk	25/08/2016
RPM- Ready Prepared Solid Medium	SM434H	GC Agar,Modified	Low risk	25/08/2016
RPM- Ready Prepared Solid Medium	SM467	Hektoen Enteric Agar	Low risk	20/12/2012
RPM- Ready Prepared Solid Medium	SM467D	Hektoen Enteric Agar	Low risk	20/12/2012
RPM- Ready Prepared Solid Medium	SM792	C.L.E.D. Agar w/ Bromothymol Blue	Low risk	30/10/2018
RPM- Ready Prepared Solid Medium	SM933D	Orange Serum Agar	Low risk	22/04/2019
RPM- Ready Prepared UTI Diagnostic Kits	K041	Rapid UTI ABST Kit	Low Risk	20/12/2012
RPM- Ready Prepared UTI Diagnostic Kits	K084A	Ecopathology Uro Kit-1	Low risk	20/12/2012
RPM- Ready Prepared UTI Diagnostic Kits	K084B	Ecopathology Uro Kit-1, Modified	Low risk	30/10/2018
RPM- Ready Prepared UTI Diagnostic Kits	K085A	Ecopathology Uro Kit-2	Low risk	20/12/2012
RPM- Ready Prepared UTI Diagnostic Kits	K089	Ecopathology Uro Kit-3	Low risk	20/12/2012
RPM- Ready Prepared UTI Diagnostic Kits	K090	Ecopathology Uro Kit-4	Low risk	20/12/2012
RPM- Biochemical Kits for Mycobacteria	K043	Nitrate Reduction Test Kit for Mycobacteria	Low risk	20/12/2012
RPM- Biochemical Kits for Mycobacteria	K044	Catalase Test Kit for Mycobacteria	Low risk	20/12/2012
RPM- Biochemical Kits for Mycobacteria	K045	Pyrazinimadase Test Kit for Mycobacteria	Low risk	20/12/2012
RPM- Biochemical Kits for Mycobacteria	K046	Thiopene Carboxylic Hydrazide Test Kit for Mycobacteria	Low risk	20/12/2012
RPM- Biochemical Kits for Mycobacteria	K047	Niacin Detection Kit w/ syringe	Low risk	20/12/2012
RPM- Biochemical Kits for Mycobacteria	K048	Niacin Detection Kit Modified w/o syringe	Low risk	20/12/2012
RPM- Biochemical Kits for	K050	Kit for Selective Isolation of M.tuberculosis	Low risk	20/12/2012

Mycobacteria				
RPM-MRSA Kits	K058S	MRSA Alert kit (w/swabs)	Low risk	25/08/2016
RPM-MRSA Kits	K058SR	MeReSa Agar Base,MRSA Alert Kit (w/swabs)	Low risk	25/08/2016
RPM-MRSA Kits	K086R	Enterococcus Presumptive Broth (VRE Alert)	Low risk	25/08/2016
RPM- Biochemical Identification Kits	KB001	HiIMVIC™ Biochemical Test Kit	Low risk	20/12/2012
RPM- Biochemical Identification Kits	KB001R	HiIMVIC Biochemical Test Kit	Low risk	25/08/2016
RPM- Biochemical Identification Kits	KB002	HiAssorted™ Biochemical Test Kit	Low risk	20/12/2012
RPM- Biochemical Identification Kits	KB002R	HiAssorted Biochemical Test Kit	Low risk	25/08/2016
RPM- Biochemical Identification Kits	KB003	Hi25™ Enterobacteriaceae Identification Kit	Low risk	20/12/2012
RPM- Biochemical Identification Kits	KB003R	Hi25 Enterobacteriaceae Identification Kit	Low risk	25/08/2016
RPM- Biochemical Identification Kits	KB004	HiStaph™ Identification Kit	Low risk	20/12/2012
RPM- Biochemical Identification Kits	KB004R	HiStaph Identification Kit	Low risk	25/08/2016
RPM- Biochemical Identification Kits	KB005A	HiStrep™ Identification Kit	Low risk	20/12/2012
RPM- Biochemical Identification Kits	KB005AR	HiStrep Identification Kit	Low risk	25/08/2016
RPM- Biochemical Identification Kits	KB006	HiCandida™ Identification Kit	Low risk	20/12/2012
RPM- Biochemical Identification Kits	KB006R	HiCandida Identification Kit	Low risk	25/08/2016
RPM- Biochemical Identification Kits	KB007	HiVibrio™ Identification Kit	Low risk	20/12/2012
RPM- Biochemical Identification Kits	KB007R	HiVibrio Identification Kit	Low risk	25/08/2016
RPM- Biochemical Identification Kits	KB008	HiNeisseria™ Identification Kit	Low risk	20/12/2012
RPM- Biochemical Identification Kits	KB008R	HiNeisseria Identification Kit	Low risk	25/08/2016
RPM- Biochemical Identification Kits	KB009	HiCarbo™ Kit	Low risk	20/12/2012
RPM- Biochemical Identification Kits	KB009R	HiCarbo Kit	Low risk	25/08/2016
RPM- Biochemical Identification Kits	KB009A	HiCarbo™ Kit- Part A	Low risk	20/12/2012
RPM- Biochemical Identification Kits	KB009AR	HiCarbo Kit- Part A	Low risk	25/08/2016
RPM- Biochemical Identification Kits	KB009B1	HiCarbo™ Kit- Part B	Low risk	20/12/2012
RPM- Biochemical Identification Kits	KB009C	HiCarbo™ Kit- Part C	Low risk	20/12/2012
RPM- Biochemical Identification Kits	KB010	HiE. coli™ Identification Kit	Low risk	20/12/2012
RPM- Biochemical Identification Kits	KB010R	HiE.coli™ Identification Kit	Low risk	25/08/2016
RPM- Biochemical Identification Kits	KB011	HiSalmonella™ Identification Kit	Low risk	20/12/2012
RPM- Biochemical Identification Kits	KB011R	HiSalmonella Identification Kit	Low risk	25/08/2016
RPM- Biochemical Identification Kits	KB012A	HiListeria™ Identification Kit	Low risk	20/12/2012
RPM- Biochemical Identification Kits	KB012AR	HiListeria Identification Kit	Low risk	25/08/2016
RPM- Biochemical Identification Kits	KB013	HiBacillus™ Identification Kit	Low risk	20/12/2012
RPM- Biochemical Identification Kits	KB013R	HiCarbo Kit (HiBacillus Identification Kit)	Low risk	25/08/2016
RPM- Biochemical Identification Kits	KB014	HiAcinetobacter™ Identification Kit	Low risk	20/12/2012
RPM- Biochemical Identification Kits	KB014R	HiCarbo Kit (HiAcinetobacter Identification Kit)	Low risk	25/08/2016
RPM- Biochemical Identification Kits	KB015	HiCorynebacteria Identification Kit	Low risk	12/08/2015
RPM- Biochemical Identification Kits	KB016	Hi24™ Enterobacteriaceae Identification Kit,Modified	Low risk	12/08/2015
RPM- Biochemical Identification Kits	KB019	Hi24™ Nonfermenters Identification Kit	Low risk	28/04/2017
RPM- Biochemical Identification Kits	KB020	HiLacto Identification Kit	Low risk	28/04/2017
RPM- Biochemical Identification Kits	KB021	HiBifido Identification Kit	Low risk	28/04/2017
RPM- Biochemical Identification Kits	KBM001	HiMotility™ Biochemical Kit for E.coli	Low risk	20/12/2012
RPM- Biochemical Identification Kits	KBM001R	HiMotility Biochemical Kit for E.coli	Low risk	25/08/2016
RPM- Biochemical Identification Kits	KBM002	HiMotility™ Biochemical Kit for Salmonella	Low risk	20/12/2012
RPM- Biochemical Identification Kits	KBM002R	HiMotility™ Biochemical Kit for Salmonella	Low risk	25/08/2016
RPM- Biochemical Identification Kits	KBM003A	HiMotility™ Biochemical Kit for Listeria	Low risk	20/12/2012
RPM- Biochemical Identification Kits	KBM003AR	HiMotility™ Biochemical Kit for Listeria	Low risk	25/08/2016

Product group	Type/ Model / Ref number	Device Name	Risk Class	Date of CE compliance
Product Group 3: Epidemiological Screening Kit		Registration No: NL-CA002-24117		
ESK- Hi Aureus Confirmation Kits	K053AD	Hiaureus Coagulase Confirmation Kit (w/o swabs)	Low risk	07/02/2012
ESK- Hi Aureus Confirmation Kits	K053ADS	Hiaureus Coagulase Confirmation Kit (w/ swabs)	Low risk	07/02/2012

Product group	Type/ Model / Ref number	Device Name	Risk Class	Date of CE compliance
Product Group 5: Bacteriological Differentiation Aids		Registration No: NL-CA002-26445		
BDA- HiDtect Rapid Identification Discs	DT001	HiDtect™ UTI Identification Disc	Low risk	20/12/2012
BDA- HiDtect Rapid Identification Discs	DT003	HiDtect™ Pseudomonas Identification Disc	Low risk	20/12/2012
BDA- HiDtect Rapid Identification Discs	DT015	HiDtect™ Universal Enviro Identification Disc	Low risk	20/12/2012
BDA- Readymade Indicators in Liquid	I001	Andrade's Indicator	Low risk	20/12/2012
BDA- Readymade Indicators in Liquid	I002	Bromocresol Green Indicator	Low risk	20/12/2012
BDA- Readymade Indicators in Liquid	I003	Bromocresol Purple Indicator	Low risk	20/12/2012
BDA- Readymade Indicators in Liquid	I004	Bromophenol Blue Indicator	Low risk	20/12/2012
BDA- Readymade Indicators in Liquid	I005	Bromothymol Blue Indicator	Low risk	20/12/2012
BDA- Readymade Indicators in Liquid	I006	Methyl Orange Indicator	Low risk	20/12/2012
BDA- Readymade Indicators in Liquid	I007	Methyl Red Indicator	Low risk	20/12/2012
BDA- Readymade Indicators in Liquid	I008	Neutral Red Indicator	Low risk	20/12/2012
BDA- Readymade Indicators in Liquid	I009	Phenolphthalein, 0.1% w/v	Low risk	20/12/2012
BDA- Readymade Indicators in Liquid	I010	Phenol Red Indicator	Low risk	20/12/2012
BDA- Readymade Indicators in Liquid	I011	Thymol Blue Indicator	Low risk	20/12/2012
BDA- Readymade Indicators in Liquid	I012	Thymolphthalein Indicator	Low risk	20/12/2012
BDA- Readymade Indicators in Liquid	I013	Universal Indicator	Low risk	20/12/2012
BDA- Readymade Indicators in Liquid	I014	Mixed Indicator Solution (25X)	Low risk	20/12/2012
BDA- Readymade Stains in Liquid	K001	Gram Stains - Kit (contains S012, S032, S013 and S027 or S038)	Low risk	20/12/2012
BDA- Readymade Stains in Liquid	K001CCL	Gram Stains - Kit (contains S012, S032, S013 and S027 or S038)	Low risk	04/07/2018
BDA- Readymade Stains in Liquid	K001D	Gram Staining Kit	Low risk	04/07/2018
BDA- Readymade Stains in Liquid	K001L	Gram Stains - Kit (contains S012, S032, S013 and S027 or S038)	Low risk	20/12/2012
BDA- Readymade Stains in Liquid	K001M	Gram Stains - Kit	Low risk	22/04/2019
BDA- Readymade Stains in Liquid	K002	Albert's Metachromatic Stains - Kit	Low risk	20/12/2012
BDA- Readymade Stains in Liquid	K002L	Albert's Metachromatic Stains - Kit	Low risk	20/12/2012
BDA- Readymade Stains in Liquid	K003	Neisser's Metachromatic Stains - Kit (contains S013, S023 and S037)	Low risk	20/12/2012
BDA- Readymade Stains in Liquid	K003L	Neisser's Metachromatic Stains - Kit (contains S013, S023 and S037)	Low risk	20/12/2012
BDA- Readymade Stains in Liquid	K004	Capsule Stains - Kit (contains S021, S025 and S047)	Low risk	20/12/2012
BDA- Readymade Stains in Liquid	K004L	Capsule Stains - Kit (contains S021, S025 and S047)	Low risk	20/12/2012
BDA- Readymade Stains in Liquid	K005	ZN Acid Fast Stains - Kit (contains S033, S005 and S022)	Low risk	20/12/2012
BDA- Readymade Stains in Liquid	K005CCL	ZN Acid Fast Stains - Kit (contains S033, S005 and S022)	Low risk	04/07/2018
BDA- Readymade Stains in Liquid	K005D	ZN Acid Fast Stains - Kit	Low risk	04/07/2018
BDA- Readymade Stains in Liquid	K005L	ZN Acid Fast Stains - Kit (contains S033, S005 & S022)	Low risk	20/12/2012
BDA- Readymade Stains in Liquid	K005M	ZN Acid Fast Stains - Kit (contains S033, S005 & S022)	Low risk	22/04/2019
BDA- Readymade Stains in Liquid	K006	Schaeffer & Fulton's Spore Stains - Kit (contains S028)	Low risk	20/12/2012

		and S029)		
BDA- Readymade Stains in Liquid	K006L	Schaeffer & Fulton's Spore Stains - Kit (contains S028 and S029)	Low risk	20/12/2012
BDA- Readymade Stains in Liquid	K011	Malarial Parasite - Kit (contains S008 and S009)	Low risk	20/12/2012
BDA- Readymade Stains in Liquid	K011L	Malarial Parasite - Kit (contains S008 and S009)	Low risk	20/12/2012
BDA- Readymade Stains in Liquid	K021	Fluorescent Stains - Kit for Mycobacteria (contains S042, S043 and S044)	Low risk	20/12/2012
BDA- Readymade Stains in Liquid	K021L	Fluorescent Stains - Kit for Mycobacteria (contains S042, S043 and S044)	Low risk	20/12/2012
BDA- Readymade Stains in Liquid	K021R	Fluorescent Stains Kit for Mycobacteria (contains S054,S055,S056)	Low risk	20/12/2012
BDA- Readymade Stains in Liquid	K021Y	Fluorescent Stains Kit for Mycobacteria (contains S042Y,S043Y,S044Y)	Low risk	04/07/2018
BDA- Readymade Stains in Liquid	K049	Malarial Parasite - Kit (contains S008 and S009)	Low risk	20/12/2012
BDA- Readymade Stains in Liquid	K061	HiFluo-Phenol Free Stain - kit for Mycobacteria [Kit contains 200ml each of Auramine – Rhodamine solution (Phenol free)-S082, Decolourizer-S099 (2 x200), Potassium Permanganate Solution-S083]	Low risk	20/12/2012
BDA- Readymade Stains in Liquid	K062	HiCold Stain TB - Kit for Mycobacteria [Kit contains 500ml each of Carbol Fuchsin Solution-S080, Decolourizer-S099, Counter Stain (Loeffler's Methylene Blue)-S081]	Low risk	20/12/2012
BDA- Readymade Stains in Liquid	K062S	HiCold Stain TB - Kit for Mycobacteria [Kit contains 100ml each of Carbol Fuchsin Solution-S080, Decolourizer-S099, Counter Stain (Loeffler's Methylene Blue) S081]	Low risk	20/12/2012
BDA- Readymade Stains in Liquid	K063	Modified Neisser's Metachromatic Stains - Kit (1 minute staining)	Low risk	20/12/2012
BDA - Readymade Reagents in Liquid	R001	Barium Chloride Solution, 10% w/v	Low risk	20/12/2012
BDA - Readymade Reagents in Liquid	R002	Benedict's Qualitative Reagent	Low risk	20/12/2012
BDA - Readymade Reagents in Liquid	R002	Benedict's Qualitative Reagent	Low risk	20/12/2012
BDA - Readymade Reagents in Liquid	R003	Benedict's Quantitative Reagent	Low risk	20/12/2012
BDA - Readymade Reagents in Liquid	R003	Benedict's Quantitative Reagent	Low risk	20/12/2012
BDA - Readymade Reagents in Liquid	R004	C.S.F. Diluting Fluid	Low risk	20/12/2012
BDA - Readymade Reagents in Liquid	R005	Ehrlich's Aldehyde Reagent	Low risk	20/12/2012
BDA - Readymade Reagents in Liquid	R005	Ehrlich's Aldehyde Reagent	Low risk	20/12/2012
BDA - Readymade Reagents in Liquid	R006	Folin & Wu's Alkaline Copper Solution	Low risk	20/12/2012
BDA - Readymade Reagents in Liquid	R007	Folin & Wu's Phosphate, Molybdate Solution	Low risk	20/12/2012
BDA - Readymade Reagents in Liquid	R008	Kovac's Indole Reagent	Low risk	20/12/2012
BDA - Readymade Reagents in Liquid	R009	a-Naphthylamine solution	Low risk	20/12/2012
BDA - Readymade Reagents in Liquid	R010	Nessler's Reagent	Low risk	20/12/2012
BDA - Readymade Reagents in Liquid	R011	Potassium Chromate, 5% w/v	Low risk	20/12/2012
BDA - Readymade Reagents in Liquid	R012	Potassium Oxalate, 5% w/v	Low risk	20/12/2012
BDA - Readymade Reagents in Liquid	R013	R.B.C. Diluting Fluid (Hayemis)	Low risk	20/12/2012
BDA - Readymade Reagents in Liquid	R014	Sodium Citrate, 3.8% w/v	Low risk	20/12/2012
BDA - Readymade Reagents in Liquid	R015	Sulphanilic acid, 0.8%	Low risk	20/12/2012
BDA - Readymade Reagents in Liquid	R016	W.B.C. Diluting Fluid	Low risk	20/12/2012

BDA - Readymade Reagents in Liquid	R017	Nessler's Reagent	Low risk	20/12/2012
BDA - Readymade Reagents in Liquid	R018	Fouchet's Reagent	Low risk	20/12/2012
BDA - Readymade Reagents in Liquid	R019	E.D.T.A. (di-sodium) 5%	Low risk	20/12/2012
BDA - Readymade Reagents in Liquid	R020	Sulphosalicylic Acid 3%	Low risk	20/12/2012
BDA - Readymade Reagents in Liquid	R021	Topfer Reagent	Low risk	20/12/2012
BDA - Readymade Reagents in Liquid	R022	o-Toluidine reagent	Low risk	20/12/2012
BDA - Readymade Reagents in Liquid	R023	R.B.C. Diluting Fluid (Grower's)	Low risk	20/12/2012
BDA - Readymade Reagents in Liquid	R024	o-Toluidine Reagent	Low risk	20/12/2012
BDA - Readymade Reagents in Liquid	R026	Gordon-McLeod Reagent (Oxidase reagent)	Low risk	20/12/2012
BDA - Readymade Reagents in Liquid	R027	Gaby-Hadley Reagent A	Low risk	20/12/2012
BDA - Readymade Reagents in Liquid	R028	Gaby-Hadley Reagent B	Low risk	20/12/2012
BDA - Readymade Reagents in Liquid	R029	Barritt Reagent A (for VP test)	Low risk	20/12/2012
BDA - Readymade Reagents in Liquid	R030	Barritt Reagent B (for VP test)	Low risk	20/12/2012
BDA - Readymade Reagents in Liquid	R031	O'Meara Reagent	Low risk	20/12/2012
BDA - Readymade Reagents in Liquid	R035	DMACA Reagent	Low risk	20/12/2012
BDA - Readymade Reagents in Liquid	R036	TDA Reagent	Low risk	20/12/2012
BDA - Readymade Reagents in Liquid	R037	Fehling Solution No. 1	Low risk	20/12/2012
BDA - Readymade Reagents in Liquid	R038	Fehling Solution No. 2	Low risk	20/12/2012
BDA - Readymade Reagents in Liquid	R043	PYR Reagent	Low risk	20/12/2012
BDA - Readymade Reagents in Liquid	R044	Iodine Solution	Low risk	20/12/2012
BDA - Readymade Reagents in Liquid	R075	10X RBC Lysis Buffer Solution	Low risk	20/12/2012
BDA - Readymade Reagents in Liquid	R083	Thrombocount reagent	Low risk	20/12/2012
BDA - Readymade Reagents in Liquid	R084	HiDecal (mild decalcifying solution)	Low risk	20/12/2012
BDA - Readymade Reagents in Liquid	R085	HiDecal (strong decalcifying solution)	Low risk	20/12/2012
BDA - Readymade Reagents in Liquid	R092	McFarland Standard Tube	Low risk	20/12/2012
BDA - Readymade Reagents in Liquid	R092A	Mcfarland standard 0.5	Low risk	22/04/2019
BDA - Readymade Reagents in Liquid	R092B	Mcfarland standard 1	Low risk	22/04/2019
BDA - Readymade Reagents in Liquid	R092C	Mcfarland standard 2	Low risk	22/04/2019
BDA - Readymade Reagents in Liquid	R092D	Mcfarland standard 3	Low risk	22/04/2019
BDA - Readymade Reagents in Liquid	R092E	Mcfarland standard 4	Low risk	22/04/2019
BDA - Readymade Reagents in Liquid	R092R	Test Tubes (McFarland Standard Tube)	Low risk	25/08/2016
BDA - Readymade Reagents in Liquid	R092S	McFarland Standard Set (0.5,1,2)	Low risk	04/07/2018
BDA - Readymade Reagents in Liquid	R097	Millons reagent	Low risk	28/04/2017

BDA- Readymade Stains in Liquid	S001	Albert's Stain A	Low risk	20/12/2012
BDA- Readymade Stains in Liquid	S002	Albert's Stain B	Low risk	20/12/2012
BDA- Readymade Stains in Liquid	S003	Borax Carmine (Grenacher's), Alcoholic Stain	Low risk	20/12/2012
BDA- Readymade Stains in Liquid	S004	Borax Carmine (Grenacher's), Aqueous Stain	Low risk	20/12/2012
BDA- Readymade Stains in Liquid	S005	Carbol Fuchsin (ZN,Strong)	Low risk	20/12/2012
BDA- Readymade Stains in Liquid	S005D	Carbol Fuchsin (ZN,Strong)	Low risk	04/07/2018
BDA- Readymade Stains in Liquid	S005M	Carbol Fuchsin (ZN,Strong)	Low risk	22/04/2019
BDA- Readymade Stains in Liquid	S006	Carbol Fuchsin (ZN, Dilute)	Low risk	20/12/2012
BDA- Readymade Stains in Liquid	S007	Eosin, 2% w/v	Low risk	20/12/2012
BDA- Readymade Stains in Liquid	S008	Field's Stain A	Low risk	20/12/2012
BDA- Readymade Stains in Liquid	S009	Field's Stain B	Low risk	20/12/2012
BDA- Readymade Stains in Liquid	S010	Gentian Violet	Low risk	20/12/2012
BDA- Readymade Stains in Liquid	S011	Giemsa's Stain	Low risk	20/12/2012
BDA- Readymade Stains in Liquid	S012	Gram's Crystal Violet	Low risk	20/12/2012
BDA- Readymade Stains in Liquid	S012D	Gram's Crystal Violet	Low risk	04/07/2018
BDA- Readymade Stains in Liquid	S012M	Gram's Crystal Violet	Low risk	22/04/2019
BDA- Readymade Stains in Liquid	S013	Gram's Iodine	Low risk	20/12/2012
BDA- Readymade Stains in Liquid	S013D	Gram's Iodine	Low risk	04/07/2018
BDA- Readymade Stains in Liquid	S013M	Gram's Iodine	Low risk	22/04/2019
BDA- Readymade Stains in Liquid	S014	Haematoxylin (Delafield's)	Low risk	20/12/2012
BDA- Readymade Stains in Liquid	S015	Lactophenol	Low risk	20/12/2012
BDA- Readymade Stains in Liquid	S016	Lactophenol Cotton Blue	Low risk	20/12/2012
BDA- Readymade Stains in Liquid	S017	Lactophenol Picric Acid	Low risk	20/12/2012
BDA- Readymade Stains in Liquid	S018	Leishman's Stain (Twin Pack)	Low risk	20/12/2012
BDA- Readymade Stains in Liquid	S018S	Leishman's Stain Solution	Low risk	25/11/2017
BDA- Readymade Stains in Liquid	S019	Lugol's Iodine	Low risk	20/12/2012
BDA- Readymade Stains in Liquid	S020	Malachite Green, 1% w/v	Low risk	20/12/2012
BDA- Readymade Stains in Liquid	S021	Methylene Blue (Aqueous)	Low risk	20/12/2012
BDA- Readymade Stains in Liquid	S022	Methylene Blue (Loeffler's)	Low risk	20/12/2012
BDA- Readymade Stains in Liquid	S022D	Methylene Blue (Loeffler's)	Low risk	04/07/2018
BDA- Readymade Stains in Liquid	S022M	Methylene Blue (Loeffler's)	Low risk	22/04/2019
BDA- Readymade Stains in Liquid	S023	Neisser's Methylene Blue	Low risk	20/12/2012
BDA- Readymade Stains in Liquid	S024	Newman's Stain, Modified	Low risk	20/12/2012
BDA- Readymade Stains in Liquid	S025	Nigrosin Stain,10% w/v	Low risk	20/12/2012
BDA- Readymade Stains in Liquid	S026	Picric Acid (Saturated, Aqueous)	Low risk	20/12/2012
BDA- Readymade Stains in Liquid	S027	Safranin, 0.5% w/v	Low risk	20/12/2012
BDA- Readymade Stains in Liquid	S027D	Safranin, 0.5% w/v	Low risk	04/07/2018
BDA- Readymade Stains in Liquid	S027M	Safranin, 0.5% w/v	Low risk	22/04/2019
BDA- Readymade Stains in Liquid	S028	Schaeffer & Fulton's Spore Stain A	Low risk	20/12/2012
BDA- Readymade Stains in Liquid	S029	Schaeffer & Fulton's Spore Stain B	Low risk	20/12/2012
BDA- Readymade Stains in Liquid	S030	Wright's Stain	Low risk	20/12/2012
BDA- Readymade Stains in Liquid	S031	Mayer's Mucicarmine Stain	Low risk	20/12/2012
BDA- Readymade Stains in Liquid	S032	Gram's Decolourizer	Low risk	20/12/2012
BDA- Readymade Stains in Liquid	S032D	Gram's Decolourizer	Low risk	04/07/2018
BDA- Readymade Stains in Liquid	S032M	Gram's Decolourizer	Low risk	22/04/2019
BDA- Readymade Stains in Liquid	S033	Acid Fast Decolourizer	Low risk	20/12/2012
BDA- Readymade Stains in Liquid	S033D	Acid Fast Decolourizer	Low risk	04/07/2018
BDA- Readymade Stains in Liquid	S033M	Acid Fast Decolourizer	Low risk	22/04/2019
BDA- Readymade Stains in Liquid	S034	Haematoxylin (Harris)	Low risk	20/12/2012
BDA- Readymade Stains in Liquid	S035	Papanicolaou-OG-6	Low risk	20/12/2012
BDA- Readymade Stains in Liquid	S036	Papanicolaou-EA-36	Low risk	20/12/2012
BDA- Readymade Stains in Liquid	S037	Neutral Red Solution	Low risk	20/12/2012
BDA- Readymade Stains in Liquid	S038	Basic Fuchsin 0.1% w/v	Low risk	20/12/2012
BDA- Readymade Stains in Liquid	S038D	Basic Fuchsin 0.1% w/v	Low risk	04/07/2018
BDA- Readymade Stains in Liquid	S038M	Basic Fuchsin 0.1% w/v	Low risk	22/04/2019
BDA- Readymade Stains in Liquid	S039	May-Grunwald's Stain	Low risk	20/12/2012
BDA- Readymade Stains in Liquid	S041	FA Rhodamine Counterstain	Low risk	20/12/2012
BDA- Readymade Stains in Liquid	S042	Phenolic auramine	Low risk	20/12/2012

BDA- Readymade Stains in Liquid	S042Y	Phenolic auramine O	Low risk	08/12/2017
BDA- Readymade Stains in Liquid	S043	Mycobacteria decolourizer	Low risk	20/12/2012
BDA- Readymade Stains in Liquid	S043Y	Mycobacteria decolourizer	Low risk	16/12/2017
BDA- Readymade Stains in Liquid	S044	Potassium permanganate	Low risk	20/12/2012
BDA- Readymade Stains in Liquid	S044Y	Potassium permanganate	Low risk	08/12/2017
BDA- Readymade Stains in Liquid	S047	M'Fadyean Stain (Polychrome Methylene Blue)	Low risk	20/12/2012
BDA- Readymade Stains in Liquid	S054	Fluorochrome Solution	Low risk	20/12/2012
BDA- Readymade Stains in Liquid	S055	Decolourising Solution	Low risk	20/12/2012
BDA- Readymade Stains in Liquid	S056	Background Solution	Low risk	20/12/2012
BDA- Readymade Stains in Liquid	S057	Grams Iodine, Stabilized	Low risk	20/12/2012
BDA- Readymade Stains in Liquid	S058	Haematoxylin (Mayer)	Low risk	20/12/2012
BDA- Readymade Stains in Liquid	S059	Haematoxylin (Ehrlich)	Low risk	20/12/2012
BDA- Readymade Stains in Liquid	S062	Fixing solution, for fixing Haematological samples	Low risk	20/12/2012
BDA- Readymade Stains in Liquid	S066	Brilliant Cresyl Blue Solution	Low risk	20/12/2012
BDA- Readymade Stains in Liquid	S067	Congo red (1% aqueous)Solution	Low risk	20/12/2012
BDA- Readymade Stains in Liquid	S068	Papanicolaou-EA-50	Low risk	20/12/2012
BDA- Readymade Stains in Liquid	S070	Schiff's fuchsin-sulphite reagent	Low risk	20/12/2012
BDA- Readymade Stains in Liquid	S073	Periodic Acid Solution (PAS)	Low risk	20/12/2012
BDA- Readymade Stains in Liquid	S074	Schiff's Reagent	Low risk	20/12/2012
BDA- Readymade Stains in Liquid	S076	Haematoxylin (Gill No.3)	Low risk	20/12/2012
BDA- Readymade Stains in Liquid	S102	Fixative, for fixing cytological or histological samples	Low risk	20/12/2012
BDA- Readymade Stains in Liquid	S109	Fixative (Buffered Formalin fixative) for fixing cytological or histological samples	Low risk	20/12/2012
BDA- Readymade Stains in Liquid	S118	Fixative, for rapid fixing of haematological samples	Low risk	20/12/2012
BDA- Readymade Stains in Liquid	S119	Fixative (BFA), for Rapid fixing of haematological samples	Low risk	20/12/2012
BDA- Readymade Stains in Liquid	S125	Romanowsky-Giemsa (RG) stain	Low risk	20/12/2012
BDA- Readymade Stains in Liquid	S126	Shorr's Stain solution	Low risk	20/12/2012
BDA- Readymade Stains in Liquid	S127	Gabbett Counterstaining Solution	Low risk	16/12/2017
BDA- Readymade Stains in Liquid	S128	HiGrams Stain Crystal Violet	Low risk	16/12/2017
BDA- Readymade Stains in Liquid	S129	HiGrams Iodine	Low risk	16/12/2017
BDA- Readymade Stains in Liquid	S130	HiGrams Decolouriser	Low risk	16/12/2017
BDA- Readymade Stains in Liquid	S131	HiGrams Counter Stain	Low risk	16/12/2017
BDA- Readymade Stains in Liquid	S132	HiCarbol Fuchsin	Low risk	16/12/2017
BDA- Readymade Stains in Liquid	S133	HiAcid Fast Decolouriser	Low risk	16/12/2017
BDA- Readymade Stains in Liquid	S134	HiAcid Fast Counter Stain	Low risk	16/12/2017
BDA- Readymade Stains in Liquid	S135	Solution for Leishman's Stain L (Twin Pack)	Low risk	16/12/2017
BDA- Readymade Stains in Liquid	S136	Solution for Leishman's Stain R (Twin Pack)	Low risk	16/12/2017
BDA- Readymade Stains in Liquid	S137	Solution for Leishman's Stain HP (Twin Pack)	Low risk	16/12/2017
BDA- Readymade Stains in Liquid	S138	Gentian Violet 1 % Solution	Low risk	22/04/2019
BDA- Differentiation Discs	DD015	Bacitracin	Low risk	20/12/2012
BDA- Differentiation Discs	DD024	Bile Esculin	Low risk	20/12/2012
BDA- Differentiation Discs	DD040	DMACA Indole	Low risk	20/12/2012
BDA- Differentiation Discs	DD035	Hippurate hydrolysis	Low risk	20/12/2012
BDA- Differentiation Strips	DD034	Lead Acetate Paper strips	Low risk	20/12/2012
BDA- Differentiation Discs	DD041	Nitrate Discs	Low risk	20/12/2012
BDA- Differentiation Discs	DD042	Nitrate Reagent Discs	Low risk	20/12/2012
BDA- Differentiation Discs	DD008	ONPG	Low risk	20/12/2012
BDA- Differentiation Discs	DD009	Optochin	Low risk	20/12/2012
BDA- Differentiation Discs	DD009R	Optochin (5mcg)	Low risk	25/08/2016
BDA- Differentiation Discs	DD018	Oxidase	Low risk	20/12/2012
BDA- Differentiation Discs	DD020	X factor	Low risk	20/12/2012
BDA- Differentiation Discs	DD022	X+V Factor	Low risk	20/12/2012
BDA- Differentiation Discs	DD021	V Factor	Low risk	20/12/2012
BDA- Differentiation Discs	DD047	Vibrio 0129 Differential Disc	Low risk	20/12/2012
BDA- Differentiation Discs	DD048	Vibrio 0129 Differential Disc	Low risk	20/12/2012
BDA- Differentiation Discs	DD055	Bacitracin B	Low risk	25/08/2016
BDA- Differentiation Discs	DD056	Sodium Biselenite Disc	Low risk	04/07/2018
BDA- Differentiation Discs	DB001	Sodium Biselenite Bud	Low risk	04/07/2018

Product group	Type/ Model / Ref number	Device Name	Risk Class	Date of CE compliance
Product Group 4: Antimicrobial Susceptibility Systems Registration No: NL-CA002-26444				
ASS- Sensitivity Discs (Multi Discs)	DE001	Dodeca Universal-I	Low risk	20/12/2012
ASS- Sensitivity Discs (Multi Discs)	DE002	Dodeca G-I-Plus	Low risk	20/12/2012
ASS- Sensitivity Discs (Multi Discs)	DE003	Dodeca G-I-Minus	Low risk	20/12/2012
ASS- Sensitivity Discs (Multi Discs)	DE004	Dodeca UTI-I	Low risk	20/12/2012
ASS- Sensitivity Discs (Multi Discs)	DE005	Dodeca UTI-II	Low risk	20/12/2012
ASS- Sensitivity Discs (Multi Discs)	DE006	Dodeca UTI-III	Low risk	25/08/2016
ASS- Sensitivity Discs (Multi Discs)	DE007	Dodeca Universal-II	Low risk	20/12/2012
ASS- Sensitivity Discs (Multi Discs)	DE008	Dodeca Universal-III	Low risk	20/12/2012
ASS- Sensitivity Discs (Multi Discs)	DE009	Dodeca G-II-Plus	Low risk	20/12/2012
ASS- Sensitivity Discs (Multi Discs)	DE010	Dodeca G-II-Minus	Low risk	20/12/2012
ASS- Sensitivity Discs (Multi Discs)	DE011	Dodeca UTI-IV	Low risk	20/12/2012
ASS- Sensitivity Discs (Multi Discs)	DE012	Dodeca Universal-IV	Low risk	20/12/2012
ASS- Sensitivity Discs (Multi Discs)	DE013	Dodeca Universal-V	Low risk	20/12/2012
ASS- Sensitivity Discs (Multi Discs)	DE014	Dodeca Universal-VI	Low risk	20/12/2012
ASS- Sensitivity Discs (Multi Discs)	DE015	Dodeca Universal-VII	Low risk	20/12/2012
ASS- Sensitivity Discs (Multi Discs)	DE016	Dodeca Universal III	Low risk	25/08/2016
ASS- Sensitivity Discs (Multi Discs)	DE017	Dodeca Universal-IX	Low risk	20/12/2012
ASS- Sensitivity Discs (Multi Discs)	DE018	Dodeca G-III-Plus	Low risk	20/12/2012
ASS- Sensitivity Discs (Multi Discs)	DE019	Dodeca G-III-Minus	Low risk	20/12/2012
ASS- Sensitivity Discs (Multi Discs)	DE020	Dodeca Pseudo-I	Low risk	20/12/2012
ASS- Sensitivity Discs (Multi Discs)	DE021	Dodeca UTI-V	Low risk	20/12/2012
ASS- Sensitivity Discs (Multi Discs)	DE022	Dodeca Universal X	Low risk	25/08/2016
ASS- Sensitivity Discs (Multi Discs)	DE023	Dodeca G-IV Plus	Low risk	20/12/2012
ASS- Sensitivity Discs (Multi Discs)	DE024	Dodeca G-IV minus	Low risk	25/08/2016
ASS- Sensitivity Discs (Multi Discs)	DE025	Dodeca UTI-VI	Low risk	20/12/2012
ASS- Sensitivity Discs (Multi Discs)	DE026	Dodeca Universal -XI	Low risk	20/12/2012
ASS- Sensitivity Discs (Multi Discs)	DE027	Dodeca Universal -XII	Low risk	20/12/2012
ASS- Sensitivity Discs (Multi Discs)	DE028	Dodeca Universal -XIII	Low risk	20/12/2012
ASS- Sensitivity Discs (Multi Discs)	DE029	Dodeca G-V minus	Low risk	20/12/2012
ASS- Sensitivity Discs (Multi Discs)	DE030	Dodeca UTI-VII	Low risk	20/12/2012
ASS- Sensitivity Discs (Multi Discs)	DE031	Dodeca G-VI minus	Low risk	20/12/2012
ASS- Sensitivity Discs (Multi Discs)	DE032	Dodeca G-V Plus	Low risk	20/12/2012
ASS- Sensitivity Discs (Multi Discs)	DE033	Dodeca G-VII Minus	Low risk	20/12/2012
ASS- Sensitivity Discs (Multi Discs)	DE034	Dodeca UTI-VIII	Low risk	20/12/2012
ASS- Sensitivity Discs (Multi Discs)	DE035	Dodeca Universal XIV	Low risk	20/12/2012
ASS- Sensitivity Discs (Multi Discs)	DE036	Dodeca G-VI Plus	Low risk	20/12/2012
ASS- Sensitivity Discs (Multi Discs)	DE037	Dodeca G-VIII Minus	Low risk	20/12/2012
ASS- Sensitivity Discs (Multi Discs)	DE038	Dodeca G-VII Plus	Low risk	20/12/2012
ASS- Sensitivity Discs (Multi Discs)	DE039	Dodeca G-IX Minus	Low risk	20/12/2012
ASS- Sensitivity Discs (Multi Discs)	DE040	Dodeca UTI-IX	Low risk	20/12/2012
ASS- Sensitivity Discs (Multi Discs)	DE041	Dodeca Pseudo-II	Low risk	20/12/2012
ASS- Sensitivity Discs (Multi Discs)	DE042	Dodeca Universal XV	Low risk	20/12/2012
ASS- Sensitivity Discs (Multi Discs)	DE043	Dodeca G-X Minus	Low risk	25/08/2016
ASS- Sensitivity Discs (Multi Discs)	DE044	Dodeca - G-VIII Plus	Low risk	25/08/2016
ASS- Sensitivity Discs (Multi Discs)	DE045	Dodeca G-XI Minus	Low risk	20/12/2012
ASS- Sensitivity Discs (Multi Discs)	DE046	Dodeca G-XII Minus	Low risk	20/12/2012
ASS- Sensitivity Discs (Multi Discs)	DE047	Dodeca G-IX Plus	Low risk	20/12/2012
ASS- Sensitivity Discs (Multi Discs)	DE048	Dodeca Staphylococci - 1	Low risk	20/12/2012
ASS- Sensitivity Discs (Multi Discs)	DE049	Dodeca Staphylococci - 2	Low risk	20/12/2012
ASS- Sensitivity Discs (Multi Discs)	DE050	Dodeca Enterococcus -1	Low risk	20/12/2012
ASS- Sensitivity Discs (Multi Discs)	DE051	Dodeca Pseudomonas -1	Low risk	20/12/2012
ASS- Sensitivity Discs (Multi Discs)	DE052	Dodeca Pseudomonas 2	Low risk	25/08/2016

ASS- Sensitivity Discs (Multi Discs)	DE053	Dodeca Enterobacteriaceae - 1	Low risk	20/12/2012
ASS- Sensitivity Discs (Multi Discs)	DE054	Dodeca Enterobacteriaceae - 2	Low risk	20/12/2012
ASS- Sensitivity Discs (Multi Discs)	DE700	Dodeca Staphylococci - 1	Low risk	25/08/2016
ASS- Sensitivity Discs (Multi Discs)	DE701	Dodeca Staphylococci - 2	Low risk	25/08/2016
ASS- Sensitivity Discs (Multi Discs)	DE702	Dodeca Enterococcus - 1	Low risk	25/08/2016
ASS- Sensitivity Discs (Multi Discs)	DE703	Dodeca Pseudomonas - 1	Low risk	25/08/2016
ASS- Sensitivity Discs (Multi Discs)	DE704	Dodeca Pseudomonas - 2	Low risk	25/08/2016
ASS- Sensitivity Discs (Multi Discs)	DE705	Dodeca Enterobacteriaceae - 1	Low risk	25/08/2016
ASS- Sensitivity Discs (Multi Discs)	DE706	Dodeca Enterobacteriaceae - 2	Low risk	25/08/2016
ASS- Sensitivity Discs (Multi Discs)	DE707	Dodeca Universal - 16	Low risk	25/08/2016
ASS- Sensitivity Discs (Multi Discs)	DE708	Dodeca UTI - 10	Low risk	25/08/2016
ASS- Sensitivity Discs (Multi Discs)	DE709	Dodeca G-Minus 13	Low risk	25/08/2016
ASS- Sensitivity Discs (Multi Discs)	DE710	Dodeca G-Plus 10	Low risk	25/08/2016
ASS- Sensitivity Discs (Multi Discs)	DE711	Dodeca G minus XIV	Low risk	25/08/2016
ASS- Sensitivity Discs (Multi Discs)	DE712	Dodeca G minus XV	Low risk	25/08/2016
ASS- Sensitivity Discs (Multi Discs)	DE713	Dodeca G minus 16	Low risk	25/08/2016
ASS- Sensitivity Discs (Multi Discs)	DE714	Dodeca G minus 17	Low risk	25/08/2016
ASS- Sensitivity Discs (Multi Discs)	DE715	Dodeca G minus 18	Low risk	25/08/2016
ASS- Sensitivity Discs (Multi Discs)	DE716	Dodeca G plus 11	Low risk	25/08/2016
ASS- Sensitivity Discs (Multi Discs)	DE717	Dodeca G plus 12	Low risk	25/08/2016
ASS- Sensitivity Discs (Multi Discs)	DE718	Dodeca G minus 19	Low risk	25/08/2016
ASS- Sensitivity Discs (Multi Discs)	DE719	Dodeca UTI 10	Low risk	25/08/2016
ASS- Sensitivity Discs (Multi Discs)	DE720	Dodeca UTI 11	Low risk	25/08/2016
ASS- Sensitivity Discs (Multi Discs)	DE721	Dodeca Universal 16	Low risk	25/08/2016
ASS- Sensitivity Discs (Multi Discs)	DE722	Dodeca Universal 17	Low risk	25/08/2016
ASS- Sensitivity Discs (Multi Discs)	DE723	Dodeca G Plus 13	Low risk	25/08/2016
ASS- Sensitivity Discs (Multi Discs)	DE724	Dodeca UTI-12	Low risk	25/08/2016
ASS- Sensitivity Discs (Multi Discs)	DE725	Dodeca Universal-18	Low risk	25/08/2016
ASS- Sensitivity Discs (Multi Discs)	DE726	Dodeca UTI - 13	Low risk	25/08/2016
ASS- Sensitivity Discs (Multi Discs)	DE727	Dodeca G-minus 20	Low risk	25/08/2016
ASS- Sensitivity Discs (Multi Discs)	DE728	Dodeca UTI 14	Low risk	25/08/2016
ASS- Sensitivity Discs (Multi Discs)	DE729	Dodeca G-Plus 14	Low risk	25/08/2016
ASS- Sensitivity Discs (Multi Discs)	DE730	Dodeca G-Minus 21	Low risk	25/08/2016
ASS- Sensitivity Discs (Multi Discs)	DE731	Dodeca G-Minus 22	Low risk	25/08/2016
ASS- Sensitivity Discs (Multi Discs)	DE732	Dodeca Universal 19	Low risk	25/08/2016
ASS- Sensitivity Discs (Multi Discs)	DE733	Dodeca Universal 20	Low risk	25/08/2016
ASS- Sensitivity Discs (Multi Discs)	DE734	Dodeca Universal 21	Low risk	25/08/2016
ASS- Sensitivity Discs (Multi Discs)	DE735	Dodeca Universal 22	Low risk	25/08/2016
ASS- Sensitivity Discs (Multi Discs)	DE736	Dodeca G-Plus 15	Low risk	25/08/2016
ASS- Sensitivity Discs (Multi Discs)	DE737	Dodeca G-Minus 23	Low risk	25/08/2016
ASS- Sensitivity Discs (Multi Discs)	DE738	Dodeca G-Minus 24	Low risk	25/08/2016
ASS- Sensitivity Discs (Multi Discs)	DE739	Dodeca UTI 13	Low risk	25/08/2016
ASS- Sensitivity Discs (Multi Discs)	DE740	Dodeca G-Plus 16	Low risk	25/08/2016
ASS- Sensitivity Discs (Multi Discs)	DE741	Dodeca G-Minus 25	Low risk	25/08/2016
ASS- Sensitivity Discs (Multi Discs)	DE742	Dodeca Pseudomonas -3	Low risk	25/08/2016
ASS- Sensitivity Discs (Multi Discs)	DE743	Dodeca G-Minus 26	Low risk	04/07/2018
ASS- Sensitivity Discs (Multi Discs)	DE744	Dodeca UTI 15	Low risk	04/07/2018
ASS- Sensitivity Discs (Multi Discs)	DE745	Dodeca Pseudomonas -4	Low risk	04/07/2018
ASS- Sensitivity Discs (Multi Discs)	DE746	Dodeca G-Plus 17	Low risk	04/07/2018
ASS- Sensitivity Discs (Multi Discs)	DE747	Dodeca G-Minus 27	Low risk	04/07/2018
ASS- Sensitivity Discs (Multi Discs)	DE748	Dodeca UTI 16	Low risk	04/07/2018
ASS- Ezy MIC Strips	EM001	Amikacin	Low risk	20/12/2012
ASS- Ezy MIC Strips	EM002	Amoxycillin	Low risk	20/12/2012
ASS- Ezy MIC Strips	EM003	Amoxyclav (2:1)	Low risk	20/12/2012
ASS- Ezy MIC Strips	EM004	Azithromycin	Low risk	20/12/2012
ASS- Ezy MIC Strips	EM006	Aztreonam	Low risk	20/12/2012
ASS- Ezy MIC Strips	EM008	Cefazolin	Low risk	20/12/2012
ASS- Ezy MIC Strips	EM009	Cefdinir	Low risk	20/12/2012

ASS- Ezy MIC Strips	EM011	Cefpirome	Low risk	20/12/2012
ASS- Ezy MIC Strips	EM012	Ceftazidime	Low risk	20/12/2012
ASS- Ezy MIC Strips	EM013	Ceftriaxone	Low risk	20/12/2012
ASS- Ezy MIC Strips	EM016	Chloramphenicol	Low risk	20/12/2012
ASS- Ezy MIC Strips	EM017	Ciprofloxacin	Low risk	20/12/2012
ASS- Ezy MIC Strips	EM018	Clarithromycin	Low risk	20/12/2012
ASS- Ezy MIC Strips	EM019	Clindamycin	Low risk	20/12/2012
ASS- Ezy MIC Strips	EM020	Colistin	Low risk	20/12/2012
ASS- Ezy MIC Strips	EM020S	Colistin	Low risk	04/07/2018
ASS- Ezy MIC Strips	EM021	Co-Trimoxazole (1:19)	Low risk	20/12/2012
ASS- Ezy MIC Strips	EM021S	Co-Trimoxazole (1:19)	Low risk	04/07/2018
ASS- Ezy MIC Strips	EM022	Erythromycin	Low risk	20/12/2012
ASS- Ezy MIC Strips	EM023	Fusidic Acid	Low risk	20/12/2012
ASS- Ezy MIC Strips	EM024	Gatifloxacin	Low risk	20/12/2012
ASS- Ezy MIC Strips	EM025	Gentamicin	Low risk	20/12/2012
ASS- Ezy MIC Strips	EM026	Kanamycin	Low risk	20/12/2012
ASS- Ezy MIC Strips	EM027	Levofloxacin	Low risk	20/12/2012
ASS- Ezy MIC Strips	EM029	Linezolid	Low risk	20/12/2012
ASS- Ezy MIC Strips	EM032	Minocycline	Low risk	20/12/2012
ASS- Ezy MIC Strips	EM033	Moxifloxacin	Low risk	20/12/2012
ASS- Ezy MIC Strips	EM035	Nalidixic acid	Low risk	20/12/2012
ASS- Ezy MIC Strips	EM037	Nitrofurantoin	Low risk	20/12/2012
ASS- Ezy MIC Strips	EM038	Norfloxacin	Low risk	20/12/2012
ASS- Ezy MIC Strips	EM039	Ofloxacin	Low risk	20/12/2012
ASS- Ezy MIC Strips	EM041	Piperacillin	Low risk	20/12/2012
ASS- Ezy MIC Strips	EM042	Piperacillin/Tazobactam	Low risk	20/12/2012
ASS- Ezy MIC Strips	EM043	Polymixin B	Low risk	20/12/2012
ASS- Ezy MIC Strips	EM044	Pristinomyacin (Quinupristin/Dalfopristin)	Low risk	20/12/2012
ASS- Ezy MIC Strips	EM045	Rifampicin	Low risk	20/12/2012
ASS- Ezy MIC Strips	EM046	Roxithromycin	Low risk	20/12/2012
ASS- Ezy MIC Strips	EM047	Sparfloxacin	Low risk	20/12/2012
ASS- Ezy MIC Strips	EM048	Streptomycin	Low risk	20/12/2012
ASS- Ezy MIC Strips	EM055	Teicoplanin	Low risk	20/12/2012
ASS- Ezy MIC Strips	EM055S	Teicoplanin	Low risk	04/07/2018
ASS- Ezy MIC Strips	EM056	Tetracycline	Low risk	20/12/2012
ASS- Ezy MIC Strips	EM057	Ticarcillin	Low risk	20/12/2012
ASS- Ezy MIC Strips	EM058	Tobramycin	Low risk	20/12/2012
ASS- Ezy MIC Strips	EM059	Trimethoprim	Low risk	20/12/2012
ASS- Ezy MIC Strips	EM060	Vancomycin	Low risk	20/12/2012
ASS- Ezy MIC Strips	EM060S	Vancomycin	Low risk	04/07/2018
ASS- Ezy MIC Strips	EM061	Gentamicin	Low risk	20/12/2012
ASS- Ezy MIC Strips	EM062	Penicillin	Low risk	20/12/2012
ASS- Ezy MIC Strips	EM063	Oxacillin - Vancomycin	Low risk	20/12/2012
ASS- Ezy MIC Strips	EM064	Cefotaxime	Low risk	20/12/2012
ASS- Ezy MIC Strips	EM065	Oxacillin	Low risk	20/12/2012
ASS- Ezy MIC Strips	EM066	Ceftriaxone	Low risk	20/12/2012
ASS- Ezy MIC Strips	EM066S	Ceftriaxone	Low risk	04/07/2018
ASS- Ezy MIC Strips	EM068	Ampicillin	Low risk	20/12/2012
ASS- Ezy MIC Strips	EM070	Cefepime	Low risk	20/12/2012
ASS- Ezy MIC Strips	EM071	Amphotericin-B	Low risk	20/12/2012
ASS- Ezy MIC Strips	EM072	Fluconazole	Low risk	20/12/2012
ASS- Ezy MIC Strips	EM073	Itraconazole	Low risk	20/12/2012
ASS- Ezy MIC Strips	EM074	Ketoconazole	Low risk	20/12/2012
ASS- Ezy MIC Strips	EM076	Gemifloxacin	Low risk	20/12/2012
ASS- Ezy MIC Strips	EM077	Vancomycin -Cefoxitin	Low risk	20/12/2012
ASS- Ezy MIC Strips	EM078	Imipenem w&w/o EDTA	Low risk	20/12/2012
ASS- Ezy MIC Strips	EM079A	Triple ESBL detection Strip	Low risk	20/12/2012
ASS- Ezy MIC Strips	EM080	Meropenem	Low risk	20/12/2012

ASS- Ezy MIC Strips	EM081A	ESBL & AmpC Detection Strip	Low risk	20/12/2012
ASS- Ezy MIC Strips	EM082	Ciprofloxacin	Low risk	20/12/2012
ASS- Ezy MIC Strips	EM083	Co-Trimoxazole (1:19)	Low risk	20/12/2012
ASS- Ezy MIC Strips	EM084	Penicillin	Low risk	20/12/2012
ASS- Ezy MIC Strips	EM085	Ertapenem	Low risk	20/12/2012
ASS- Ezy MIC Strips	EM086	Voriconazole	Low risk	20/12/2012
ASS- Ezy MIC Strips	EM087	Mupirocin	Low risk	20/12/2012
ASS- Ezy MIC Strips	EM088	Daptomycin (Supplemented with Calcium ions)	Low risk	20/12/2012
ASS- Ezy MIC Strips	EM089	Tigecycline	Low risk	20/12/2012
ASS- Ezy MIC Strips	EM090	Doripenem	Low risk	20/12/2012
ASS- Ezy MIC Strips	EM091	Faropenem	Low risk	20/12/2012
ASS- Ezy MIC Strips	EM092	Meropenem with & without EDTA	Low risk	20/12/2012
ASS- Ezy MIC Strips	EM093	Cefepime/Tazobactam (2:1)	Low risk	20/12/2012
ASS- Ezy MIC Strips	EM094	Cefoperazone/Sulbactam (2:1)	Low risk	20/12/2012
ASS- Ezy MIC Strips	EM095	Netilmicin	Low risk	20/12/2012
ASS- Ezy MIC Strips	EM097	Ceftriaxone/Sulbactam (2:1)	Low risk	20/12/2012
ASS- Ezy MIC Strips	EM098	Ceftazidime / Ceftazidime+ Clavulanic acid	Low risk	20/12/2012
ASS- Ezy MIC Strips	EM099	Cefotaxime / Cefotaxime + Clavulanic acid	Low risk	20/12/2012
ASS- Ezy MIC Strips	EM100	Cefotaxime	Low risk	20/12/2012
ASS- Ezy MIC Strips	EM101	Cefoxitin	Low risk	20/12/2012
ASS- Ezy MIC Strips	EM102	Cefuroxime	Low risk	20/12/2012
ASS- Ezy MIC Strips	EM103	Doxycycline	Low risk	20/12/2012
ASS- Ezy MIC Strips	EM104	Imipenem	Low risk	20/12/2012
ASS- Ezy MIC Strips	EM105	Cefotetan	Low risk	20/12/2012
ASS- Ezy MIC Strips	EM106	Cephalothin	Low risk	20/12/2012
ASS- Ezy MIC Strips	EM107	Cefaclor	Low risk	20/12/2012
ASS- Ezy MIC Strips	EM108	Fosfomycin	Low risk	20/12/2012
ASS- Ezy MIC Strips	EM109	Ampicillin/Sulbactam	Low risk	20/12/2012
ASS- Ezy MIC Strips	EM110	Cefixime	Low risk	20/12/2012
ASS- Ezy MIC Strips	EM111	Vancomycin - Teicoplanin	Low risk	20/12/2012
ASS- Ezy MIC Strips	EM112	Cefoperazone	Low risk	20/12/2012
ASS- Ezy MIC Strips	EM113	Cefonicid	Low risk	20/12/2012
ASS- Ezy MIC Strips	EM114	Cefmetazole	Low risk	20/12/2012
ASS- Ezy MIC Strips	EM115	Enrofloxacin	Low risk	20/12/2012
ASS- Ezy MIC Strips	EM116	Cefepime / cefepime + Clavulanic acid	Low risk	20/12/2012
ASS- Ezy MIC Strips	EM117	Ceftriaxone / Ceftriaxone + Clavulanic acid	Low risk	20/12/2012
ASS- Ezy MIC Strips	EM118	Flucytosine	Low risk	20/12/2012
ASS- Ezy MIC Strips	EM119	Caspofungin	Low risk	20/12/2012
ASS- Ezy MIC Strips	EM120	Posaconazole	Low risk	20/12/2012
ASS- Ezy MIC Strips	EM121	Micafungin	Low risk	20/12/2012
ASS- Ezy MIC Strips	EM122	Anidulafungin	Low risk	20/12/2012
ASS- Ezy MIC Strips	EM123	Ceftizoxime	Low risk	20/12/2012
ASS- Ezy MIC Strips	EM124	Mecillinam	Low risk	20/12/2012
ASS- Ezy MIC Strips	EM125	Ticarcillin/Clavulanic Acid	Low risk	20/12/2012
ASS- Ezy MIC Strips	EM126	Bacitracin	Low risk	20/12/2012
ASS- Ezy MIC Strips	EM127	Cefotetan / Cefotetan + Cloxacillin	Low risk	20/12/2012
ASS- Ezy MIC Strips	EM128	Metronidazole	Low risk	20/12/2012
ASS- Ezy MIC Strips	EM129	Cefpodoxime	Low risk	20/12/2012
ASS- Ezy MIC Strips	EM130	Cefprozil	Low risk	20/12/2012
ASS- Ezy MIC Strips	EM131	Sulbactam	Low risk	20/12/2012
ASS- Ezy MIC Strips	EM132	Improved ESBL Detection Ezy MIC Strip (Mix+/Mix)	Low risk	25/08/2016
ASS- Ezy MIC Strips	EM133	Improved AmpC Detection Ezy MIC Strip (Mix+/Mix)	Low risk	25/08/2016
ASS- Ezy MIC Strips	EM134	MBL Plus ESBL Detection Ezy MIC Strip (ESBL+/ESBL)	Low risk	25/08/2016
ASS- Ezy MIC Strips	EM135	MBL Plus AmpC Detection Ezy MIC Strip (AmpC+/Amp)	Low risk	25/08/2016
ASS- Ezy MIC Strips	EM136	ESBL-AmpC Coexistence Detection Ezy MIC Kit	Low risk	25/08/2016
ASS- Ezy MIC Strips	EM137	MBL-ESBL-AmpC Co-existence Detection Ezy MIC Kit	Low risk	25/08/2016
ASS- Ezy MIC Strips	EM138	Cefpodoxime/Clavulanic Acid Ezy MIC Strip	Low risk	25/08/2016

ASS- Ezy MIC Strips	EM139	Amoxyclav Ezy MIC Strip (AUG) (0.016-256 mcg/ml)	Low risk	25/08/2016
ASS- Ezy MIC Strips	EM140	Ampicillin/Sulbactam Ezy MIC Strip (SAM) (4 mcg/ml)	Low risk	25/08/2016
ASS- Ezy MIC Strips	EM141	Ertapenem/Ertapenem + Boronic acid Ezy MIC Strip (ETP+ETP)	Low risk	25/08/2016
ASS- Ezy MIC Strips	EM142	Terbinafine Ezy MIC Strip(TRB) (0.002-32 mcg/ml)	Low risk	25/08/2016
ASS- Ezy MIC Strips	EM143	Griseofulvin Ezy MIC Strip (GRI) (0.002-32 mcg/ml)	Low risk	25/08/2016
ASS- Ezy MIC Strips	EM144	Clotrimazole Ezy MIC Strip (CLO) (0.002-32 mcg/ml)	Low risk	25/08/2016
ASS- Ezy MIC Strips	EM145	Terbinafine Ezy MIC Strip(TRB) (0.002-32 mcg/ml)	Low risk	25/08/2016
ASS- Ezy MIC Strips	EM146	Miconazole Ezy MIC Strip (MIC) (0.002-32 mcg/ml)	Low risk	25/08/2016
ASS- Ezy MIC Strips	EM147	Flucloxacillin Ezy MIC Stripr (FLC) (0.016-256 mcg/ml)	Low risk	04/07/2018
ASS- Ezy MIC Strips	EM148	Cefepime/Clavulanic acid Ezy MIC Stripr (FIC) (0.016-256 mcg/ml)	Low risk	04/07/2018
ASS- Ezy MIC Strips	EM149	Ceftazidime /Tazobactam Ezy MIC Strip (CAT) (0.016-256 mcg/ml)	Low risk	04/07/2018
ASS- Ezy MIC Strips	EM150	Natamycin Ezy MIC Strip (NAT) (0.016-256 mcg/ml)	Low risk	22/04/2019
ASS- Ezy MIC Strips	EM701	Xylomonas Ezy MIC Strip (0.016-256mcg/ml)	Low risk	25/08/2016
ASS- Ezy MIC Strips	EM702	Arbekacin Ezy MIC Strip (ABK) (0.016-256 mcg/ml)	Low risk	25/08/2016
ASS- Ezy MIC Strips	EM703	Garenoxacin Ezy MIC Strip (0.002-32 mcg/ml)	Low risk	25/08/2016
ASS- Ezy MIC Strips	EM705	Biapenem Ezy MIC Strip (BPM) (0.002-32 mcg/ml)	Low risk	25/08/2016
ASS- Ezy MIC Strips	EM706	Reinvexin Ezy MIC Strip (PB) (0.016-256 mcg/ml)	Low risk	16/12/2017
ASS- Sensitivity Discs (Multi Discs)	HX001	Hexa G-plus 1	Low risk	20/12/2012
ASS- Sensitivity Discs (Multi Discs)	HX002	Hexa G-plus 2	Low risk	20/12/2012
ASS- Sensitivity Discs (Multi Discs)	HX003	Hexa G-plus 3	Low risk	20/12/2012
ASS- Sensitivity Discs (Multi Discs)	HX004	Hexa G-plus 4	Low risk	20/12/2012
ASS- Sensitivity Discs (Multi Discs)	HX005	Hexa G-plus 5	Low risk	20/12/2012
ASS- Sensitivity Discs (Multi Discs)	HX006	Hexa G-minus 1	Low risk	20/12/2012
ASS- Sensitivity Discs (Multi Discs)	HX007	Hexa G-minus 2	Low risk	20/12/2012
ASS- Sensitivity Discs (Multi Discs)	HX008	Hexa G-minus 3	Low risk	20/12/2012
ASS- Sensitivity Discs (Multi Discs)	HX009	Hexa G-minus 4	Low risk	25/08/2016
ASS- Sensitivity Discs (Multi Discs)	HX010	Hexa G-minus 5	Low risk	20/12/2012
ASS- Sensitivity Discs (Multi Discs)	HX011	Hexa Pseudo 1	Low risk	20/12/2012
ASS- Sensitivity Discs (Multi Discs)	HX012	Hexa Pseudo 2	Low risk	20/12/2012
ASS- Sensitivity Discs (Multi Discs)	HX013	Hexa Pseudo 3	Low risk	20/12/2012
ASS- Sensitivity Discs (Multi Discs)	HX014	Hexa UTI-1	Low risk	20/12/2012
ASS- Sensitivity Discs (Multi Discs)	HX015	Hexa UTI-2	Low risk	20/12/2012
ASS- Sensitivity Discs (Multi Discs)	HX016	Hexa Haemophilus 1	Low risk	25/08/2016
ASS- Sensitivity Discs (Multi Discs)	HX017	Hexa Haemophilus 2	Low risk	20/12/2012
ASS- Sensitivity Discs (Multi Discs)	HX018	Hexa Haemophilus 3	Low risk	25/08/2016
ASS- Sensitivity Discs (Multi Discs)	HX019	Hexa Pneumococci 1	Low risk	25/08/2016
ASS- Sensitivity Discs (Multi Discs)	HX020	Hexa Pneumococci 2	Low risk	20/12/2012
ASS- Sensitivity Discs (Multi Discs)	HX021	Hexa Anaerobic 1	Low risk	20/12/2012
ASS- Sensitivity Discs (Multi Discs)	HX022	Hexa G-plus 6	Low risk	20/12/2012
ASS- Sensitivity Discs (Multi Discs)	HX023	Hexa G-plus 7	Low risk	20/12/2012
ASS- Sensitivity Discs (Multi Discs)	HX024	Hexa G-plus 8	Low risk	20/12/2012
ASS- Sensitivity Discs (Multi Discs)	HX025	Hexa G-Minus 6	Low risk	25/08/2016
ASS- Sensitivity Discs (Multi Discs)	HX026	Hexa Pseudo 4	Low risk	20/12/2012
ASS- Sensitivity Discs (Multi Discs)	HX027	Hexa G-Plus 9	Low risk	20/12/2012
ASS- Sensitivity Discs (Multi Discs)	HX028	Hexa G-minus 7	Low risk	20/12/2012
ASS- Sensitivity Discs (Multi Discs)	HX029	Hexa Pseudo 5	Low risk	20/12/2012
ASS- Sensitivity Discs (Multi Discs)	HX030	Hexa G-Minus 8	Low risk	20/12/2012
ASS- Sensitivity Discs (Multi Discs)	HX031	Hexa G-Plus 10	Low risk	20/12/2012
ASS- Sensitivity Discs (Multi Discs)	HX032	Hexa Universal - 1	Low risk	20/12/2012
ASS- Sensitivity Discs (Multi Discs)	HX033	Hexa UTI 3	Low risk	20/12/2012
ASS- Sensitivity Discs (Multi Discs)	HX034	Hexa G-plus11	Low risk	20/12/2012
ASS- Sensitivity Discs (Multi Discs)	HX035	Hexa G-minus 9	Low risk	20/12/2012
ASS- Sensitivity Discs (Multi Discs)	HX036	Hexa G-minus 29	Low risk	20/12/2012
ASS- Sensitivity Discs (Multi Discs)	HX037	Hexa UTI 4	Low risk	20/12/2012
ASS- Sensitivity Discs (Multi Discs)	HX038	Hexa Universal-2	Low risk	20/12/2012
ASS- Sensitivity Discs (Multi Discs)	HX039	Hexa G-plus 12	Low risk	20/12/2012

ASS- Sensitivity Discs (Multi Discs)	HX040	Hexa G-plus 13	Low risk	20/12/2012
ASS- Sensitivity Discs (Multi Discs)	HX041	Hexa Pneumococci - 3	Low risk	25/08/2016
ASS- Sensitivity Discs (Multi Discs)	HX042	Hexa Pneumococci-4	Low risk	20/12/2012
ASS- Sensitivity Discs (Multi Discs)	HX043	Hexa Pneumococci - 5	Low risk	25/08/2016
ASS- Sensitivity Discs (Multi Discs)	HX044	Hexa Pneumococci - 6	Low risk	25/08/2016
ASS- Sensitivity Discs (Multi Discs)	HX045	Hexa Pneumococci-7	Low risk	20/12/2012
ASS- Sensitivity Discs (Multi Discs)	HX046	Hexa Pneumococci-8	Low risk	20/12/2012
ASS- Sensitivity Discs (Multi Discs)	HX047	Hexa G-plus 25	Low risk	20/12/2012
ASS- Sensitivity Discs (Multi Discs)	HX048	Hexa G-plus 26	Low risk	20/12/2012
ASS- Sensitivity Discs (Multi Discs)	HX049	Hexa G-plus 27	Low risk	20/12/2012
ASS- Sensitivity Discs (Multi Discs)	HX050	Hexa Pseudo 6	Low risk	25/08/2016
ASS- Sensitivity Discs (Multi Discs)	HX051	Hexa Pseudo 7	Low risk	20/12/2012
ASS- Sensitivity Discs (Multi Discs)	HX052	Hexa Pseudo 8	Low risk	25/08/2016
ASS- Sensitivity Discs (Multi Discs)	HX053	Hexa Pseudo 9	Low risk	20/12/2012
ASS- Sensitivity Discs (Multi Discs)	HX054	Hexa Pseudo 10	Low risk	20/12/2012
ASS- Sensitivity Discs (Multi Discs)	HX055	Hexa Pseudo 11	Low risk	20/12/2012
ASS- Sensitivity Discs (Multi Discs)	HX056	Hexa G-minus 26	Low risk	20/12/2012
ASS- Sensitivity Discs (Multi Discs)	HX057	Hexa G-minus 27	Low risk	20/12/2012
ASS- Sensitivity Discs (Multi Discs)	HX058	Hexa G-minus 28	Low risk	20/12/2012
ASS- Sensitivity Discs (Multi Discs)	HX059	Hexa G-minus 10	Low risk	20/12/2012
ASS- Sensitivity Discs (Multi Discs)	HX060	Hexa G-minus 11	Low risk	20/12/2012
ASS- Sensitivity Discs (Multi Discs)	HX061	Hexa G-Minus 12	Low risk	25/08/2016
ASS- Sensitivity Discs (Multi Discs)	HX062	Hexa G-minus 13	Low risk	20/12/2012
ASS- Sensitivity Discs (Multi Discs)	HX063	Hexa G-minus 14	Low risk	20/12/2012
ASS- Sensitivity Discs (Multi Discs)	HX064	Hexa G-minus 15	Low risk	20/12/2012
ASS- Sensitivity Discs (Multi Discs)	HX065	Hexa G-Minus 16	Low risk	25/08/2016
ASS- Sensitivity Discs (Multi Discs)	HX066	Hexa G-minus 17	Low risk	20/12/2012
ASS- Sensitivity Discs (Multi Discs)	HX067	Hexa G-minus 18	Low risk	20/12/2012
ASS- Sensitivity Discs (Multi Discs)	HX068	Hexa G-minus 19	Low risk	20/12/2012
ASS- Sensitivity Discs (Multi Discs)	HX069	Hexa G-minus 20	Low risk	20/12/2012
ASS- Sensitivity Discs (Multi Discs)	HX070	Hexa G-minus 21	Low risk	20/12/2012
ASS- Sensitivity Discs (Multi Discs)	HX071	Hexa G-Minus 22	Low risk	25/08/2016
ASS- Sensitivity Discs (Multi Discs)	HX072	Hexa UTI 4 (Modified)	Low risk	20/12/2012
ASS- Sensitivity Discs (Multi Discs)	HX073	Hexa UTI 5	Low risk	20/12/2012
ASS- Sensitivity Discs (Multi Discs)	HX074	Hexa UTI 6	Low risk	20/12/2012
ASS- Sensitivity Discs (Multi Discs)	HX075	Hexa UTI 7	Low risk	20/12/2012
ASS- Sensitivity Discs (Multi Discs)	HX076	Hexa UTI 8	Low risk	20/12/2012
ASS- Sensitivity Discs (Multi Discs)	HX077	Hexa UTI 9	Low risk	20/12/2012
ASS- Sensitivity Discs (Multi Discs)	HX078	Hexa UTI 10	Low risk	25/08/2016
ASS- Sensitivity Discs (Multi Discs)	HX079	Hexa UTI 11	Low risk	20/12/2012
ASS- Sensitivity Discs (Multi Discs)	HX080	Hexa G-plus 14	Low risk	20/12/2012
ASS- Sensitivity Discs (Multi Discs)	HX081	Hexa G-plus 15	Low risk	20/12/2012
ASS- Sensitivity Discs (Multi Discs)	HX082	Hexa G-Plus 16	Low risk	25/08/2016
ASS- Sensitivity Discs (Multi Discs)	HX083	Hexa G-plus 17	Low risk	20/12/2012
ASS- Sensitivity Discs (Multi Discs)	HX084	Hexa Haemophilus 4	Low risk	20/12/2012
ASS- Sensitivity Discs (Multi Discs)	HX085	Hexa Haemophilus 5	Low risk	25/08/2016
ASS- Sensitivity Discs (Multi Discs)	HX086	Hexa Haemophilus 6	Low risk	20/12/2012
ASS- Sensitivity Discs (Multi Discs)	HX087	Hexa Haemophilus 7	Low risk	20/12/2012
ASS- Sensitivity Discs (Multi Discs)	HX088	Hexa Haemophilus 8	Low risk	20/12/2012
ASS- Sensitivity Discs (Multi Discs)	HX089	Hexa Haemophilus 9	Low risk	20/12/2012
ASS- Sensitivity Discs (Multi Discs)	HX090	Hexa G-plus 18	Low risk	20/12/2012
ASS- Sensitivity Discs (Multi Discs)	HX091	Hexa G-plus 19	Low risk	20/12/2012
ASS- Sensitivity Discs (Multi Discs)	HX092	Hexa G-plus 20	Low risk	20/12/2012
ASS- Sensitivity Discs (Multi Discs)	HX093	Hexa G-plus 21	Low risk	20/12/2012
ASS- Sensitivity Discs (Multi Discs)	HX094	Hexa G-Plus 22	Low risk	25/08/2016
ASS- Sensitivity Discs (Multi Discs)	HX095	Hexa G-minus 23	Low risk	20/12/2012
ASS- Sensitivity Discs (Multi Discs)	HX096	Hexa G-minus 24	Low risk	20/12/2012
ASS- Sensitivity Discs (Multi Discs)	HX097	Hexa Universal-2	Low risk	25/08/2016

ASS- Sensitivity Discs (Multi Discs)	HX098	Hexa Universal-3	Low risk	25/08/2016
ASS- Sensitivity Discs (Multi Discs)	HX099	Hexa UTI 12	Low risk	25/08/2016
ASS- Sensitivity Discs (Multi Discs)	HX100	Hexa G-Plus 23	Low risk	25/08/2016
ASS- Sensitivity Discs (Multi Discs)	HX101	Hexa G-plus 24	Low risk	20/12/2012
ASS- Sensitivity Discs (Multi Discs)	HX102	Hexa G-minus 25	Low risk	20/12/2012
ASS- Sensitivity Discs (Multi Discs)	HX103	Hexa Pseudo 12	Low risk	20/12/2012
ASS- Sensitivity Discs (Multi Discs)	HX104	Hexa Antimycoc-01	Low risk	20/12/2012
ASS- Sensitivity Discs (Multi Discs)	HX700	Hexa G-Plus 25	Low risk	25/08/2016
ASS- Sensitivity Discs (Multi Discs)	HX701	Hexa G-Minus 26	Low risk	25/08/2016
ASS- Sensitivity Discs (Multi Discs)	HX703	Hexa Pseudo-13	Low risk	25/08/2016
ASS- Sensitivity Discs (Multi Discs)	HX704	Hexa G-Minus 27	Low risk	25/08/2016
ASS- Sensitivity Discs (Multi Discs)	HX705	Hexa Anaerobic 2	Low risk	25/08/2016
ASS- Sensitivity Discs (Multi Discs)	HX706	Hexa UTI 14	Low risk	25/08/2016
ASS- Sensitivity Discs (Multi Discs)	HX707	Hexa G-Plus 26	Low risk	25/08/2016
ASS- Sensitivity Discs (Multi Discs)	HX708	Hexa G-Minus 28	Low risk	25/08/2016
ASS- Sensitivity Discs (Multi Discs)	HX709	Hexa Pseudo 14	Low risk	25/08/2016
ASS- Sensitivity Discs (Multi Discs)	HX710	Hexa UTI-15	Low risk	25/08/2016
ASS- Sensitivity Discs (Multi Discs)	HX711	Hexa G-Plus 27	Low risk	25/08/2016
ASS- Sensitivity Discs (Multi Discs)	HX712	Hexa Pseudo 15	Low risk	25/08/2016
ASS- Sensitivity Discs (Multi Discs)	HX713	Hexa Anaerobic-3	Low risk	25/08/2016
ASS- Sensitivity Discs (Multi Discs)	HX714	Hexa Combi 1	Low risk	25/08/2016
ASS- Sensitivity Discs (Multi Discs)	HX715	Hexa Universal 4	Low risk	25/08/2016
ASS- Sensitivity Discs (Multi Discs)	HX716	Hexa Universal 5	Low risk	25/08/2016
ASS- Sensitivity Discs (Multi Discs)	HX717	Hexa Combi 2	Low risk	25/08/2016
ASS- Sensitivity Discs (Multi Discs)	HX718	Hexa Combi 3	Low risk	25/08/2016
ASS- Sensitivity Discs (Multi Discs)	HX719	Hexa Combi 4	Low risk	25/08/2016
ASS- Sensitivity Discs (Multi Discs)	HX720	Hexa Combi 5	Low risk	25/08/2016
ASS- Sensitivity Discs (Multi Discs)	HX721	Hexa Combi 6	Low risk	25/08/2016
ASS- Sensitivity Discs (Multi Discs)	HX722	Hexa Combi 7	Low risk	25/08/2016
ASS- Sensitivity Discs (Multi Discs)	HX723	Hexa Combi 8	Low risk	25/08/2016
ASS- Sensitivity Discs (Multi Discs)	HX724	Hexa Combi 9	Low risk	28/04/2017
ASS- Sensitivity Discs (Multi Discs)	HX725	Hexa Combi 10	Low risk	28/04/2017
ASS- Sensitivity Discs (Multi Discs)	HX726	Hexa Combi 11	Low risk	28/04/2017
ASS- Sensitivity Discs (Multi Discs)	IC001	Icosa Universal - 1	Low risk	20/12/2012
ASS- Sensitivity Discs (Multi Discs)	IC002	Icosa G-I-Plus	Low risk	20/12/2012
ASS- Sensitivity Discs (Multi Discs)	IC003	Icosa G-I-Minus	Low risk	20/12/2012
ASS- Sensitivity Discs (Multi Discs)	IC004	Icosa UTI - 1	Low risk	20/12/2012
ASS- Sensitivity Discs (Multi Discs)	IC005	Icosa Pseudo - 1	Low risk	20/12/2012
ASS- Sensitivity Discs (Multi Discs)	IC006	Icosa Universal - 2	Low risk	20/12/2012
ASS- Sensitivity Discs (Multi Discs)	IC007	Icosa Pseudo - 2	Low risk	20/12/2012
ASS- Sensitivity Discs (Multi Discs)	IC008	Icosa G-II-Minus	Low risk	20/12/2012
ASS- Sensitivity Discs (Multi Discs)	IC701	Icosa Universal - 3	Low risk	25/08/2016
ASS- Sensitivity Discs (Multi Discs)	IC702	Icosa Universal - 4	Low risk	25/08/2016
ASS- Sensitivity Discs (Multi Discs)	IC703	Icosa Universal 5	Low risk	25/08/2016
ASS-HiComb MIC Strips	MD001	Amikacin	Low risk	20/12/2012
ASS-HiComb MIC Strips	MD002	Amoxycillin	Low risk	20/12/2012
ASS-HiComb MIC Strips	MD003	Amoxyclav (Amoxycillin/ Clavulanic acid)	Low risk	20/12/2012
ASS-HiComb MIC Strips	MD004	Azithromycin	Low risk	20/12/2012
ASS-HiComb MIC Strips	MD005	Azlocillin	Low risk	20/12/2012
ASS-HiComb MIC Strips	MD006	Aztreonam	Low risk	20/12/2012
ASS-HiComb MIC Strips	MD007	Carbencillin	Low risk	20/12/2012
ASS-HiComb MIC Strips	MD008	Cefazolin	Low risk	20/12/2012
ASS-HiComb MIC Strips	MD009	Cefdinir	Low risk	20/12/2012
ASS-HiComb MIC Strips	MD010	Cefepime	Low risk	20/12/2012
ASS-HiComb MIC Strips	MD011	Cefpirome	Low risk	20/12/2012
ASS-HiComb MIC Strips	MD012	Ceftazidime	Low risk	20/12/2012
ASS-HiComb MIC Strips	MD013	Ceftriaxone	Low risk	20/12/2012
ASS-HiComb MIC Strips	MD014	Cefalexin (Cephalexin)	Low risk	20/12/2012

ASS-HiComb MIC Strips	MD015	Cefotaxime (Cephotaxime)	Low risk	20/12/2012
ASS-HiComb MIC Strips	MD016	Chloramphenicol	Low risk	20/12/2012
ASS-HiComb MIC Strips	MD017	Ciprofloxacin	Low risk	20/12/2012
ASS-HiComb MIC Strips	MD018	Clarithromycin	Low risk	20/12/2012
ASS-HiComb MIC Strips	MD019	Clindamycin	Low risk	20/12/2012
ASS-HiComb MIC Strips	MD020	Colistin (Methane Sulphonate)	Low risk	20/12/2012
ASS-HiComb MIC Strips	MD021	Co-Trimoxazole (Sulpha/Trimethoprim)	Low risk	20/12/2012
ASS-HiComb MIC Strips	MD022	Erythromycin	Low risk	20/12/2012
ASS-HiComb MIC Strips	MD023	Fusidic Acid	Low risk	20/12/2012
ASS-HiComb MIC Strips	MD024	Gatifloxacin	Low risk	20/12/2012
ASS-HiComb MIC Strips	MD025	Gentamicin	Low risk	20/12/2012
ASS-HiComb MIC Strips	MD026	Kanamycin	Low risk	20/12/2012
ASS-HiComb MIC Strips	MD027	Levofloxacin	Low risk	20/12/2012
ASS-HiComb MIC Strips	MD028	Lincomycin	Low risk	20/12/2012
ASS-HiComb MIC Strips	MD029	Linezolid	Low risk	20/12/2012
ASS-HiComb MIC Strips	MD030	Lomefloxacin	Low risk	20/12/2012
ASS-HiComb MIC Strips	MD031	Methicillin	Low risk	20/12/2012
ASS-HiComb MIC Strips	MD032	Minocycline	Low risk	20/12/2012
ASS-HiComb MIC Strips	MD033	Moxifloxacin	Low risk	20/12/2012
ASS-HiComb MIC Strips	MD034	Mupirocin	Low risk	20/12/2012
ASS-HiComb MIC Strips	MD035	Nalidixic Acid	Low risk	20/12/2012
ASS-HiComb MIC Strips	MD036	Neomycin	Low risk	20/12/2012
ASS-HiComb MIC Strips	MD037	Nitrofurantoin	Low risk	20/12/2012
ASS-HiComb MIC Strips	MD038	Norfloxacin	Low risk	20/12/2012
ASS-HiComb MIC Strips	MD039	Ofloxacin	Low risk	20/12/2012
ASS-HiComb MIC Strips	MD040	Pefloxacin	Low risk	20/12/2012
ASS-HiComb MIC Strips	MD041	Piperacillin	Low risk	20/12/2012
ASS-HiComb MIC Strips	MD042	Piperacillin/Tazobactam	Low risk	20/12/2012
ASS-HiComb MIC Strips	MD043	Polymyxin-B	Low risk	20/12/2012
ASS-HiComb MIC Strips	MD044	Pristinomycin (Quinupristin/Dalfopristin)	Low risk	20/12/2012
ASS-HiComb MIC Strips	MD045	Rifampicin	Low risk	20/12/2012
ASS-HiComb MIC Strips	MD046	Roxithromycin	Low risk	20/12/2012
ASS-HiComb MIC Strips	MD047	Sparfloxacin	Low risk	20/12/2012
ASS-HiComb MIC Strips	MD048	Streptomycin	Low risk	20/12/2012
ASS-HiComb MIC Strips	MD049	Sulfasomidine	Low risk	20/12/2012
ASS-HiComb MIC Strips	MD050	Sulphadiazine	Low risk	20/12/2012
ASS-HiComb MIC Strips	MD051	Sulphafurazole (Sulfisoxazole)	Low risk	20/12/2012
ASS-HiComb MIC Strips	MD052	Sulphamethizole	Low risk	20/12/2012
ASS-HiComb MIC Strips	MD053	Sulphamethoxyipyridazine	Low risk	20/12/2012
ASS-HiComb MIC Strips	MD054	Sulphaphenazole	Low risk	20/12/2012
ASS-HiComb MIC Strips	MD055	Teicoplanin	Low risk	20/12/2012
ASS-HiComb MIC Strips	MD056	Tetracycline	Low risk	20/12/2012
ASS-HiComb MIC Strips	MD057	Ticarcillin	Low risk	20/12/2012
ASS-HiComb MIC Strips	MD058	Tobramycin	Low risk	20/12/2012
ASS-HiComb MIC Strips	MD059	Trimethoprim	Low risk	20/12/2012
ASS-HiComb MIC Strips	MD060	Vancomycin	Low risk	20/12/2012
ASS-HiComb MIC Strips	MD061	Gentamicin	Low risk	20/12/2012
ASS-HiComb MIC Strips	MD062	Benzyl Penicillin	Low risk	20/12/2012
ASS-HiComb MIC Strips	MD063	Vancomycin	Low risk	20/12/2012
ASS-HiComb MIC Strips	MD064	Cefotaxime (Cephotaxime)	Low risk	20/12/2012
ASS-HiComb MIC Strips	MD065	Oxacillin	Low risk	20/12/2012
ASS-HiComb MIC Strips	MD066	Ceftriaxone	Low risk	20/12/2012
ASS-HiComb MIC Strips	MD067	Amikacin	Low risk	20/12/2012
ASS-HiComb MIC Strips	MD068	Ampicillin	Low risk	20/12/2012
ASS-HiComb MIC Strips	MD069	Ceftazidime	Low risk	20/12/2012
ASS-HiComb MIC Strips	MD070	Cefepime	Low risk	20/12/2012
ASS-HiComb MIC Strips	MD071	Amphotericin B	Low risk	20/12/2012
ASS-HiComb MIC Strips	MD072	Fluconazole	Low risk	20/12/2012

ASS-HiComb MIC Strips	MD073	Itraconazole	Low risk	20/12/2012
ASS-HiComb MIC Strips	MD074	Ketoconazole	Low risk	20/12/2012
ASS-HiComb MIC Strips	MD076	Gemifloxacin	Low risk	20/12/2012
ASS-HiComb MIC Strips	MD701	Cefepime/Tazobactam	Low risk	25/08/2016
ASS-HiComb MIC Strips	MD702	Ceftazidime/Tazobactam	Low risk	25/08/2016
ASS-HiComb MIC Strips	MD704	Nadifloxacin	Low risk	25/08/2016
ASS-HiComb MIC Strips	MD706	Cefoperazone/Tazobactam CST	Low risk	25/08/2016
ASS-HiComb MIC Strips	MD707	Balofloxacin	Low risk	25/08/2016
ASS-HiComb MIC Strips	MD708	Cefuroxime CXM	Low risk	25/08/2016
ASS-HiComb MIC Strips	MD709	Cefpodaxime CPD	Low risk	25/08/2016
ASS-HiComb MIC Strips	MD710	Cefpodaxime / Clavulanic acid (2:1)	Low risk	25/08/2016
ASS-HiComb MIC Strips	MD711	Netilmicin NET	Low risk	25/08/2016
ASS-HiComb MIC Strips	MD712	Cefixime CFM	Low risk	25/08/2016
ASS-HiComb MIC Strips	MD713	Pazufloxacin	Low risk	25/08/2016
ASS- Sensitivity Discs (Multi Discs)	OD001	G-I-plus	Low risk	20/12/2012
ASS- Sensitivity Discs (Multi Discs)	OD001R	G-I-plus	Low risk	20/12/2012
ASS- Sensitivity Discs (Multi Discs)	OD002	G-II-plus	Low risk	20/12/2012
ASS- Sensitivity Discs (Multi Discs)	OD002R	G-II-plus	Low risk	20/12/2012
ASS- Sensitivity Discs (Multi Discs)	OD003	G-III-plus	Low risk	20/12/2012
ASS- Sensitivity Discs (Multi Discs)	OD0032R	Combi I	Low risk	25/08/2016
ASS- Sensitivity Discs (Multi Discs)	OD003R	G-III-plus	Low risk	20/12/2012
ASS- Sensitivity Discs (Multi Discs)	OD004	G-IV-plus	Low risk	20/12/2012
ASS- Sensitivity Discs (Multi Discs)	OD004R	G-IV-plus	Low risk	20/12/2012
ASS- Sensitivity Discs (Multi Discs)	OD005	G-I-minus	Low risk	20/12/2012
ASS- Sensitivity Discs (Multi Discs)	OD005R	G-I-minus	Low risk	20/12/2012
ASS- Sensitivity Discs (Multi Discs)	OD006	G-II-minus	Low risk	20/12/2012
ASS- Sensitivity Discs (Multi Discs)	OD006R	G-II-minus	Low risk	20/12/2012
ASS- Sensitivity Discs (Multi Discs)	OD007	G-III-minus	Low risk	20/12/2012
ASS- Sensitivity Discs (Multi Discs)	OD007R	G-III-minus	Low risk	20/12/2012
ASS- Sensitivity Discs (Multi Discs)	OD008	Pseudo	Low risk	20/12/2012
ASS- Sensitivity Discs (Multi Discs)	OD008R	Pseudo	Low risk	20/12/2012
ASS- Sensitivity Discs (Multi Discs)	OD009	UTI-I	Low risk	20/12/2012
ASS- Sensitivity Discs (Multi Discs)	OD009R	UTI-I	Low risk	20/12/2012
ASS- Sensitivity Discs (Multi Discs)	OD010	UTI-II	Low risk	20/12/2012
ASS- Sensitivity Discs (Multi Discs)	OD010R	UTI-II	Low risk	20/12/2012
ASS- Sensitivity Discs (Multi Discs)	OD011	G-X-plus	Low risk	20/12/2012
ASS- Sensitivity Discs (Multi Discs)	OD011R	G-X-plus	Low risk	20/12/2012
ASS- Sensitivity Discs (Multi Discs)	OD012	G-IX-plus	Low risk	25/08/2016
ASS- Sensitivity Discs (Multi Discs)	OD012R	G-IX-plus	Low risk	25/08/2016
ASS- Sensitivity Discs (Multi Discs)	OD014	G-IV-minus	Low risk	20/12/2012
ASS- Sensitivity Discs (Multi Discs)	OD014R	G-IV-minus	Low risk	20/12/2012
ASS- Sensitivity Discs (Multi Discs)	OD015	G-V-minus	Low risk	20/12/2012
ASS- Sensitivity Discs (Multi Discs)	OD015R	G-V-minus	Low risk	20/12/2012
ASS- Sensitivity Discs (Multi Discs)	OD016	UTI-IV	Low risk	25/08/2016
ASS- Sensitivity Discs (Multi Discs)	OD016R	UTI-IV	Low risk	25/08/2016
ASS- Sensitivity Discs (Multi Discs)	OD017	UTI-VI	Low risk	20/12/2012
ASS- Sensitivity Discs (Multi Discs)	OD017R	UTI-VI	Low risk	20/12/2012
ASS- Sensitivity Discs (Multi Discs)	OD018	UTI-VII	Low risk	20/12/2012
ASS- Sensitivity Discs (Multi Discs)	OD018R	UTI-VII	Low risk	20/12/2012
ASS- Sensitivity Discs (Multi Discs)	OD019	UTI-V	Low risk	20/12/2012
ASS- Sensitivity Discs (Multi Discs)	OD019R	UTI-V	Low risk	20/12/2012
ASS- Sensitivity Discs (Multi Discs)	OD020	Combi I	Low risk	20/12/2012
ASS- Sensitivity Discs (Multi Discs)	OD020R	Combi I	Low risk	20/12/2012
ASS- Sensitivity Discs (Multi Discs)	OD021	Combi II	Low risk	20/12/2012
ASS- Sensitivity Discs (Multi Discs)	OD021R	Combi II	Low risk	20/12/2012
ASS- Sensitivity Discs (Multi Discs)	OD022	Combi III	Low risk	20/12/2012
ASS- Sensitivity Discs (Multi Discs)	OD022R	Combi III	Low risk	20/12/2012
ASS- Sensitivity Discs (Multi Discs)	OD023	Combi IV	Low risk	20/12/2012

ASS- Sensitivity Discs (Multi Discs)	OD023R	Combi IV	Low risk	20/12/2012
ASS- Sensitivity Discs (Multi Discs)	OD024	Combi V	Low risk	25/08/2016
ASS- Sensitivity Discs (Multi Discs)	OD024R	Combi V	Low risk	25/08/2016
ASS- Sensitivity Discs (Multi Discs)	OD025	Combi VI	Low risk	20/12/2012
ASS- Sensitivity Discs (Multi Discs)	OD025R	Combi VI	Low risk	20/12/2012
ASS- Sensitivity Discs (Multi Discs)	OD026	Combi VII	Low risk	20/12/2012
ASS- Sensitivity Discs (Multi Discs)	OD026R	Combi VII	Low risk	20/12/2012
ASS- Sensitivity Discs (Multi Discs)	OD027	Combi VIII	Low risk	25/08/2016
ASS- Sensitivity Discs (Multi Discs)	OD027R	Combi VIII	Low risk	25/08/2016
ASS- Sensitivity Discs (Multi Discs)	OD028	Combi IX	Low risk	25/08/2016
ASS- Sensitivity Discs (Multi Discs)	OD028R	Combi IX	Low risk	25/08/2016
ASS- Sensitivity Discs (Multi Discs)	OD029	Combi X	Low risk	25/08/2016
ASS- Sensitivity Discs (Multi Discs)	OD029R	Combi X	Low risk	25/08/2016
ASS- Sensitivity Discs (Multi Discs)	OD030	Combi XI	Low risk	20/12/2012
ASS- Sensitivity Discs (Multi Discs)	OD030R	Combi XI	Low risk	20/12/2012
ASS- Sensitivity Discs (Multi Discs)	OD031	Combi XII	Low risk	20/12/2012
ASS- Sensitivity Discs (Multi Discs)	OD031R	Combi XII	Low risk	20/12/2012
ASS- Sensitivity Discs (Multi Discs)	OD032	Combi XIII	Low risk	20/12/2012
ASS- Sensitivity Discs (Multi Discs)	OD032R	Combi XIII	Low risk	20/12/2012
ASS- Sensitivity Discs (Multi Discs)	OD033	G-V-plus	Low risk	20/12/2012
ASS- Sensitivity Discs (Multi Discs)	OD033R	G-V-plus	Low risk	20/12/2012
ASS- Sensitivity Discs (Multi Discs)	OD034	G-VI-plus	Low risk	20/12/2012
ASS- Sensitivity Discs (Multi Discs)	OD034R	G-VI-plus	Low risk	20/12/2012
ASS- Sensitivity Discs (Multi Discs)	OD035	UTI III	Low risk	20/12/2012
ASS- Sensitivity Discs (Multi Discs)	OD035R	UTI III	Low risk	20/12/2012
ASS- Sensitivity Discs (Multi Discs)	OD036	Pseudo I	Low risk	20/12/2012
ASS- Sensitivity Discs (Multi Discs)	OD036R	Pseudo I	Low risk	20/12/2012
ASS- Sensitivity Discs (Multi Discs)	OD037	G-VII-plus	Low risk	25/08/2016
ASS- Sensitivity Discs (Multi Discs)	OD037R	G-VII-plus	Low risk	25/08/2016
ASS- Sensitivity Discs (Multi Discs)	OD038	G-VIII-plus	Low risk	20/12/2012
ASS- Sensitivity Discs (Multi Discs)	OD038R	G-VIII-plus	Low risk	20/12/2012
ASS- Sensitivity Discs (Multi Discs)	OD039	G-XI-plus	Low risk	25/08/2016
ASS- Sensitivity Discs (Multi Discs)	OD039R	G-XI-plus	Low risk	25/08/2016
ASS- Sensitivity Discs (Multi Discs)	OD040	UTI-VIII	Low risk	25/08/2016
ASS- Sensitivity Discs (Multi Discs)	OD040R	UTI-VIII	Low risk	25/08/2016
ASS- Sensitivity Discs (Multi Discs)	OD041	G-XII-plus	Low risk	20/12/2012
ASS- Sensitivity Discs (Multi Discs)	OD041R	G-XII-plus	Low risk	20/12/2012
ASS- Sensitivity Discs (Multi Discs)	OD042	G-VI-minus	Low risk	20/12/2012
ASS- Sensitivity Discs (Multi Discs)	OD042R	G-VI-minus	Low risk	20/12/2012
ASS- Sensitivity Discs (Multi Discs)	OD043	G-VII-minus	Low risk	20/12/2012
ASS- Sensitivity Discs (Multi Discs)	OD043R	G-VII-minus	Low risk	20/12/2012
ASS- Sensitivity Discs (Multi Discs)	OD044	G-VIII-minus	Low risk	20/12/2012
ASS- Sensitivity Discs (Multi Discs)	OD044R	G-VIII-minus	Low risk	20/12/2012
ASS- Sensitivity Discs (Multi Discs)	OD045	G-IX-minus	Low risk	20/12/2012
ASS- Sensitivity Discs (Multi Discs)	OD045R	G-IX-minus	Low risk	20/12/2012
ASS- Sensitivity Discs (Multi Discs)	OD046	G-X-minus	Low risk	25/08/2016
ASS- Sensitivity Discs (Multi Discs)	OD046R	G-X-minus	Low risk	25/08/2016
ASS- Sensitivity Discs (Multi Discs)	OD047	G-XI-minus	Low risk	20/12/2012
ASS- Sensitivity Discs (Multi Discs)	OD047R	G-XI-minus	Low risk	20/12/2012
ASS- Sensitivity Discs (Multi Discs)	OD048	UTI-IX	Low risk	25/08/2016
ASS- Sensitivity Discs (Multi Discs)	OD048R	UTI-IX	Low risk	25/08/2016
ASS- Sensitivity Discs (Multi Discs)	OD049	G-XIII- plus	Low risk	25/08/2016
ASS- Sensitivity Discs (Multi Discs)	OD049R	G-XIII- plus	Low risk	25/08/2016
ASS- Sensitivity Discs (Multi Discs)	OD050	G-XIV- plus	Low risk	20/12/2012
ASS- Sensitivity Discs (Multi Discs)	OD050R	G-XIV- plus	Low risk	20/12/2012
ASS- Sensitivity Discs (Multi Discs)	OD051	UTI-X	Low risk	20/12/2012
ASS- Sensitivity Discs (Multi Discs)	OD051R	UTI-X	Low risk	20/12/2012
ASS- Sensitivity Discs (Multi Discs)	OD052	UTI-XI	Low risk	25/08/2016

ASS- Sensitivity Discs (Multi Discs)	OD052R	UTI-XI	Low risk	25/08/2016
ASS- Sensitivity Discs (Multi Discs)	OD053	G-XII-minus	Low risk	20/12/2012
ASS- Sensitivity Discs (Multi Discs)	OD053R	G-XII-minus	Low risk	20/12/2012
ASS- Sensitivity Discs (Multi Discs)	OD054	UTI-XII	Low risk	20/12/2012
ASS- Sensitivity Discs (Multi Discs)	OD054R	UTI-XII	Low risk	20/12/2012
ASS- Sensitivity Discs (Multi Discs)	OD055	G-XIII-minus	Low risk	20/12/2012
ASS- Sensitivity Discs (Multi Discs)	OD055R	G-XIII-minus	Low risk	20/12/2012
ASS- Sensitivity Discs (Multi Discs)	OD056	Combi 59	Low risk	25/08/2016
ASS- Sensitivity Discs (Multi Discs)	OD056R	Combi 59	Low risk	25/08/2016
ASS- Sensitivity Discs (Multi Discs)	OD057	G-XVIII-minus	Low risk	20/12/2012
ASS- Sensitivity Discs (Multi Discs)	OD057R	G-XVIII-minus	Low risk	20/12/2012
ASS- Sensitivity Discs (Multi Discs)	OD058	G-XIX-minus	Low risk	25/08/2016
ASS- Sensitivity Discs (Multi Discs)	OD058R	G-XIX-minus	Low risk	25/08/2016
ASS- Sensitivity Discs (Multi Discs)	OD059	G-XX-minus	Low risk	25/08/2016
ASS- Sensitivity Discs (Multi Discs)	OD059R	G-XX-minus	Low risk	25/08/2016
ASS- Sensitivity Discs (Multi Discs)	OD060	G-XXI-minus	Low risk	20/12/2012
ASS- Sensitivity Discs (Multi Discs)	OD060R	G-XXI-minus	Low risk	20/12/2012
ASS- Sensitivity Discs (Multi Discs)	OD061	G-XXII-minus	Low risk	20/12/2012
ASS- Sensitivity Discs (Multi Discs)	OD061R	G-XXII-minus	Low risk	20/12/2012
ASS- Sensitivity Discs (Multi Discs)	OD062	G-XXIII-minus	Low risk	25/08/2016
ASS- Sensitivity Discs (Multi Discs)	OD062R	G-XXIII-minus	Low risk	25/08/2016
ASS- Sensitivity Discs (Multi Discs)	OD063	Pseudo V	Low risk	20/12/2012
ASS- Sensitivity Discs (Multi Discs)	OD063R	Pseudo V	Low risk	20/12/2012
ASS- Sensitivity Discs (Multi Discs)	OD064	Combi-XIV	Low risk	25/08/2016
ASS- Sensitivity Discs (Multi Discs)	OD064R	Combi XIV	Low risk	25/08/2016
ASS- Sensitivity Discs (Multi Discs)	OD064R	Combi XIV	Low risk	25/08/2016
ASS- Sensitivity Discs (Multi Discs)	OD065	UTI-XVII	Low risk	25/08/2016
ASS- Sensitivity Discs (Multi Discs)	OD065R	UTI-XVII	Low risk	25/08/2016
ASS- Sensitivity Discs (Multi Discs)	OD066	Combi 82	Low risk	20/12/2012
ASS- Sensitivity Discs (Multi Discs)	OD066R	Combi 82	Low risk	20/12/2012
ASS- Sensitivity Discs (Multi Discs)	OD067	Combi 83	Low risk	20/12/2012
ASS- Sensitivity Discs (Multi Discs)	OD067R	Combi 83	Low risk	20/12/2012
ASS- Sensitivity Discs (Multi Discs)	OD202	Comb XXI	Low risk	25/08/2016
ASS- Sensitivity Discs (Multi Discs)	OD209	Combi 28	Low risk	25/08/2016
ASS- Sensitivity Discs (Multi Discs)	OD211	Combi 30	Low risk	25/08/2016
ASS- Sensitivity Discs (Multi Discs)	OD211R	Combi 30	Low risk	25/08/2016
ASS- Sensitivity Discs (Multi Discs)	OD212	Combi 31	Low risk	25/08/2016
ASS- Sensitivity Discs (Multi Discs)	OD215	Combi 34	Low risk	25/08/2016
ASS- Sensitivity Discs (Multi Discs)	OD215R	Combi 34	Low risk	25/08/2016
ASS- Sensitivity Discs (Multi Discs)	OD216	Combi 35	Low risk	25/08/2016
ASS- Sensitivity Discs (Multi Discs)	OD216	Combi 35	Low risk	25/08/2016
ASS- Sensitivity Discs (Multi Discs)	OD216R	Combi 35	Low risk	25/08/2016
ASS- Sensitivity Discs (Multi Discs)	OD220	Combi 39	Low risk	25/08/2016
ASS- Sensitivity Discs (Multi Discs)	OD221	Combi 40	Low risk	25/08/2016
ASS- Sensitivity Discs (Multi Discs)	OD223	G XIV minus	Low risk	25/08/2016
ASS- Sensitivity Discs (Multi Discs)	OD224	G XV plus	Low risk	25/08/2016
ASS- Sensitivity Discs (Multi Discs)	OD225	UTI XIII	Low risk	25/08/2016
ASS- Sensitivity Discs (Multi Discs)	OD226	Combi 41	Low risk	25/08/2016
ASS- Sensitivity Discs (Multi Discs)	OD227	UTI-XIV	Low risk	25/08/2016
ASS- Sensitivity Discs (Multi Discs)	OD228	Pseudo II	Low risk	25/08/2016
ASS- Sensitivity Discs (Multi Discs)	OD229	G-XV-minus	Low risk	25/08/2016
ASS- Sensitivity Discs (Multi Discs)	OD230	G-XVI-plus	Low risk	25/08/2016
ASS- Sensitivity Discs (Multi Discs)	OD231	Combi -42	Low risk	25/08/2016
ASS- Sensitivity Discs (Multi Discs)	OD232	Combi 43	Low risk	25/08/2016
ASS- Sensitivity Discs (Multi Discs)	OD233	Combi 44	Low risk	25/08/2016
ASS- Sensitivity Discs (Multi Discs)	OD233	Combi 44	Low risk	25/08/2016
ASS- Sensitivity Discs (Multi Discs)	OD233R	Combi 44	Low risk	25/08/2016
ASS- Sensitivity Discs (Multi Discs)	OD233R	Combi 44	Low risk	25/08/2016

ASS- Sensitivity Discs (Multi Discs)	OD234	Combi 45	Low risk	25/08/2016
ASS- Sensitivity Discs (Multi Discs)	OD234R	Combi 45	Low risk	25/08/2016
ASS- Sensitivity Discs (Multi Discs)	OD241	Combi 49	Low risk	25/08/2016
ASS- Sensitivity Discs (Multi Discs)	OD241R	Combi 49	Low risk	25/08/2016
ASS- Sensitivity Discs (Multi Discs)	OD243	G XVII minus	Low risk	25/08/2016
ASS- Sensitivity Discs (Multi Discs)	OD244	G XIX plus	Low risk	25/08/2016
ASS- Sensitivity Discs (Multi Discs)	OD248	Combi-53	Low risk	25/08/2016
ASS- Sensitivity Discs (Multi Discs)	OD249	Combi-54	Low risk	25/08/2016
ASS- Sensitivity Discs (Multi Discs)	OD250	Pseudo - III for Pseudomonas	Low risk	25/08/2016
ASS- Sensitivity Discs (Multi Discs)	OD251	GXX plus	Low risk	25/08/2016
ASS- Sensitivity Discs (Multi Discs)	OD253	Combi 56	Low risk	25/08/2016
ASS- Sensitivity Discs (Multi Discs)	OD256	Combi 59	Low risk	20/12/2012
ASS- Sensitivity Discs (Multi Discs)	OD256R	Combi 59	Low risk	20/12/2012
ASS- Sensitivity Discs (Multi Discs)	OD257	Combi 60	Low risk	20/12/2012
ASS- Sensitivity Discs (Multi Discs)	OD257R	Combi 60	Low risk	20/12/2012
ASS- Sensitivity Discs (Multi Discs)	OD258	Combi 61	Low risk	20/12/2012
ASS- Sensitivity Discs (Multi Discs)	OD258R	Combi 61	Low risk	20/12/2012
ASS- Sensitivity Discs (Multi Discs)	OD259	Combi 62	Low risk	25/08/2016
ASS- Sensitivity Discs (Multi Discs)	OD259R	Combi 62	Low risk	25/08/2016
ASS- Sensitivity Discs (Multi Discs)	OD260	UTI-XIII	Low risk	25/08/2016
ASS- Sensitivity Discs (Multi Discs)	OD261	UTI-XIV	Low risk	25/08/2016
ASS- Sensitivity Discs (Multi Discs)	OD262	UTI-E	Low risk	25/08/2016
ASS- Sensitivity Discs (Multi Discs)	OD263	UTI-XV	Low risk	25/08/2016
ASS- Sensitivity Discs (Multi Discs)	OD264	Pseudo II	Low risk	25/08/2016
ASS- Sensitivity Discs (Multi Discs)	OD265	Combi 63	Low risk	25/08/2016
ASS- Sensitivity Discs (Multi Discs)	OD266	Combi 64	Low risk	25/08/2016
ASS- Sensitivity Discs (Multi Discs)	OD267	Combi 65	Low risk	25/08/2016
ASS- Sensitivity Discs (Multi Discs)	OD268	Combi 66	Low risk	25/08/2016
ASS- Sensitivity Discs (Multi Discs)	OD269	Combi 67	Low risk	20/12/2012
ASS- Sensitivity Discs (Multi Discs)	OD269R	Combi 67	Low risk	20/12/2012
ASS- Sensitivity Discs (Multi Discs)	OD270	Combi 68	Low risk	20/12/2012
ASS- Sensitivity Discs (Multi Discs)	OD270R	Combi 68	Low risk	20/12/2012
ASS- Sensitivity Discs (Multi Discs)	OD271	Combi 69	Low risk	20/12/2012
ASS- Sensitivity Discs (Multi Discs)	OD271R	Combi 69	Low risk	20/12/2012
ASS- Sensitivity Discs (Multi Discs)	OD272	Combi 70	Low risk	20/12/2012
ASS- Sensitivity Discs (Multi Discs)	OD272R	Combi 70	Low risk	20/12/2012
ASS- Sensitivity Discs (Multi Discs)	OD273	Combi 71	Low risk	20/12/2012
ASS- Sensitivity Discs (Multi Discs)	OD273R	Combi 71	Low risk	20/12/2012
ASS- Sensitivity Discs (Multi Discs)	OD274	Combi 72	Low risk	25/08/2016
ASS- Sensitivity Discs (Multi Discs)	OD274R	Combi 72	Low risk	25/08/2016
ASS- Sensitivity Discs (Multi Discs)	OD275	Combi 73	Low risk	25/08/2016
ASS- Sensitivity Discs (Multi Discs)	OD275R	Combi 73	Low risk	25/08/2016
ASS- Sensitivity Discs (Multi Discs)	OD275RS	Combi 60	Low risk	25/08/2016
ASS- Sensitivity Discs (Multi Discs)	OD275S	Combi 60	Low risk	25/08/2016
ASS- Sensitivity Discs (Multi Discs)	OD276	Combi 84	Low risk	20/12/2012
ASS- Sensitivity Discs (Multi Discs)	OD276R	Combi 84	Low risk	20/12/2012
ASS- Sensitivity Discs (Multi Discs)	OD277	Combi 77	Low risk	20/12/2012
ASS- Sensitivity Discs (Multi Discs)	OD277R	Combi 77	Low risk	20/12/2012
ASS- Sensitivity Discs (Multi Discs)	OD278	Combi 78	Low risk	20/12/2012
ASS- Sensitivity Discs (Multi Discs)	OD278R	Combi 78	Low risk	20/12/2012
ASS- Sensitivity Discs (Multi Discs)	OD279	Combi 79	Low risk	25/08/2016
ASS- Sensitivity Discs (Multi Discs)	OD279R	Combi 79	Low risk	25/08/2016
ASS- Sensitivity Discs (Multi Discs)	OD280	Combi 80	Low risk	20/12/2012
ASS- Sensitivity Discs (Multi Discs)	OD280R	Combi 80	Low risk	20/12/2012
ASS- Sensitivity Discs (Multi Discs)	OD281	Combi 85	Low risk	20/12/2012
ASS- Sensitivity Discs (Multi Discs)	OD281R	Combi 85	Low risk	20/12/2012
ASS- Sensitivity Discs (Multi Discs)	OD282	Combi 505	Low risk	20/12/2012
ASS- Sensitivity Discs (Multi Discs)	OD282R	Combi 505	Low risk	20/12/2012

ASS- Sensitivity Discs (Multi Discs)	OD283	Combi 506	Low risk	20/12/2012
ASS- Sensitivity Discs (Multi Discs)	OD283R	Combi 506	Low risk	20/12/2012
ASS- Sensitivity Discs (Multi Discs)	OD284	Combi 508	Low risk	20/12/2012
ASS- Sensitivity Discs (Multi Discs)	OD284R	Combi 508	Low risk	20/12/2012
ASS- Sensitivity Discs (Multi Discs)	OD285	Combi 509	Low risk	20/12/2012
ASS- Sensitivity Discs (Multi Discs)	OD285R	Combi 509	Low risk	20/12/2012
ASS- Sensitivity Discs (Multi Discs)	OD286	Combi 510	Low risk	20/12/2012
ASS- Sensitivity Discs (Multi Discs)	OD286R	Combi 510	Low risk	20/12/2012
ASS- Sensitivity Discs (Multi Discs)	OD287	Combi 511	Low risk	20/12/2012
ASS- Sensitivity Discs (Multi Discs)	OD287R	Combi 511	Low risk	20/12/2012
ASS- Sensitivity Discs (Multi Discs)	OD288	Combi 512	Low risk	25/08/2016
ASS- Sensitivity Discs (Multi Discs)	OD288R	Combi 512	Low risk	25/08/2016
ASS- Sensitivity Discs (Multi Discs)	OD289	Combi 513	Low risk	20/12/2012
ASS- Sensitivity Discs (Multi Discs)	OD289R	Combi 513	Low risk	20/12/2012
ASS- Sensitivity Discs (Multi Discs)	OD290	Combi 514	Low risk	20/12/2012
ASS- Sensitivity Discs (Multi Discs)	OD290R	Combi 514	Low risk	20/12/2012
ASS- Sensitivity Discs (Multi Discs)	OD291	Combi 90	Low risk	20/12/2012
ASS- Sensitivity Discs (Multi Discs)	OD291R	Combi 90	Low risk	20/12/2012
ASS- Sensitivity Discs (Multi Discs)	OD292	Combi 91	Low risk	20/12/2012
ASS- Sensitivity Discs (Multi Discs)	OD292R	Combi 91	Low risk	20/12/2012
ASS- Sensitivity Discs (Multi Discs)	OD293	Combi 92	Low risk	20/12/2012
ASS- Sensitivity Discs (Multi Discs)	OD293R	Combi 92	Low risk	20/12/2012
ASS- Sensitivity Discs (Multi Discs)	OD294	Combi 93	Low risk	20/12/2012
ASS- Sensitivity Discs (Multi Discs)	OD294R	Combi 93	Low risk	20/12/2012
ASS- Sensitivity Discs (Multi Discs)	OD295	Combi 516	Low risk	20/12/2012
ASS- Sensitivity Discs (Multi Discs)	OD295R	Combi 516	Low risk	20/12/2012
ASS- Sensitivity Discs (Multi Discs)	OD296	Combi 517	Low risk	20/12/2012
ASS- Sensitivity Discs (Multi Discs)	OD296R	Combi 517	Low risk	20/12/2012
ASS- Sensitivity Discs (Multi Discs)	OD297	Combi 518	Low risk	20/12/2012
ASS- Sensitivity Discs (Multi Discs)	OD297R	Combi 518	Low risk	20/12/2012
ASS- Sensitivity Discs (Multi Discs)	OD298	Combi 94	Low risk	20/12/2012
ASS- Sensitivity Discs (Multi Discs)	OD298R	Combi 94	Low risk	20/12/2012
ASS- Sensitivity Discs (Multi Discs)	OD299	Combi 95	Low risk	20/12/2012
ASS- Sensitivity Discs (Multi Discs)	OD299R	Combi 95	Low risk	20/12/2012
ASS- Sensitivity Discs (Multi Discs)	OD300	Combi 96	Low risk	20/12/2012
ASS- Sensitivity Discs (Multi Discs)	OD300R	Combi 96	Low risk	20/12/2012
ASS- Sensitivity Discs (Multi Discs)	OD301	G minus-24	Low risk	20/12/2012
ASS- Sensitivity Discs (Multi Discs)	OD301R	G minus-24	Low risk	20/12/2012
ASS- Sensitivity Discs (Multi Discs)	OD302	G minus-25	Low risk	20/12/2012
ASS- Sensitivity Discs (Multi Discs)	OD302R	G minus-25	Low risk	20/12/2012
ASS- Sensitivity Discs (Multi Discs)	OD303	G Plus-15	Low risk	20/12/2012
ASS- Sensitivity Discs (Multi Discs)	OD303R	G Plus-15	Low risk	20/12/2012
ASS- Sensitivity Discs (Multi Discs)	OD304	G Plus-16	Low risk	20/12/2012
ASS- Sensitivity Discs (Multi Discs)	OD304R	G Plus-16	Low risk	20/12/2012
ASS- Sensitivity Discs (Multi Discs)	OD305	G Plus-17	Low risk	20/12/2012
ASS- Sensitivity Discs (Multi Discs)	OD305R	G Plus-17	Low risk	20/12/2012
ASS- Sensitivity Discs (Multi Discs)	OD306	UTI-18	Low risk	20/12/2012
ASS- Sensitivity Discs (Multi Discs)	OD306R	UTI-18	Low risk	20/12/2012
ASS- Sensitivity Discs (Multi Discs)	OD307	Pseudo VI	Low risk	20/12/2012
ASS- Sensitivity Discs (Multi Discs)	OD307R	Pseudo VI	Low risk	20/12/2012
ASS- Sensitivity Discs (Multi Discs)	OD308	Universal - 1	Low risk	20/12/2012
ASS- Sensitivity Discs (Multi Discs)	OD308R	Universal - 1	Low risk	20/12/2012
ASS- Sensitivity Discs (Multi Discs)	OD309	G Plus-18	Low risk	20/12/2012
ASS- Sensitivity Discs (Multi Discs)	OD309R	G Plus-18	Low risk	20/12/2012
ASS- Sensitivity Discs (Multi Discs)	OD310	G minus-26	Low risk	20/12/2012
ASS- Sensitivity Discs (Multi Discs)	OD310R	G minus-26	Low risk	20/12/2012
ASS- Sensitivity Discs (Multi Discs)	OD311	G minus-27	Low risk	20/12/2012
ASS- Sensitivity Discs (Multi Discs)	OD311R	G minus-27	Low risk	20/12/2012

ASS- Sensitivity Discs (Multi Discs)	OD312	G Minus - 28	Low risk	20/12/2012
ASS- Sensitivity Discs (Multi Discs)	OD312R	G Minus - 28	Low risk	20/12/2012
ASS- Sensitivity Discs (Multi Discs)	OD313	G Minus - 29	Low risk	20/12/2012
ASS- Sensitivity Discs (Multi Discs)	OD313R	G Minus - 29	Low risk	20/12/2012
ASS- Sensitivity Discs (Multi Discs)	OD704	Combi 77	Low risk	25/08/2016
ASS- Sensitivity Discs (Multi Discs)	OD705	Combi 78	Low risk	25/08/2016
ASS- Sensitivity Discs (Multi Discs)	OD706	Combi 79	Low risk	25/08/2016
ASS- Sensitivity Discs (Multi Discs)	OD707	Combi 80	Low risk	25/08/2016
ASS- Sensitivity Discs (Multi Discs)	OD708	Combi 81	Low risk	25/08/2016
ASS- Sensitivity Discs (Multi Discs)	OD709	Combi 85	Low risk	25/08/2016
ASS- Sensitivity Discs (Multi Discs)	OD710	Combi 86	Low risk	25/08/2016
ASS- Sensitivity Discs (Multi Discs)	OD711	Combi 501	Low risk	25/08/2016
ASS- Sensitivity Discs (Multi Discs)	OD712	Combi 502	Low risk	25/08/2016
ASS- Sensitivity Discs (Multi Discs)	OD713	Combi 503	Low risk	25/08/2016
ASS- Sensitivity Discs (Multi Discs)	OD714	Combi 504	Low risk	25/08/2016
ASS- Sensitivity Discs (Multi Discs)	OD715	Combi 505	Low risk	25/08/2016
ASS- Sensitivity Discs (Multi Discs)	OD716	Combi 506	Low risk	25/08/2016
ASS- Sensitivity Discs (Multi Discs)	OD717	Octodiscs-A	Low risk	25/08/2016
ASS- Sensitivity Discs (Multi Discs)	OD718	Octodiscs-B	Low risk	25/08/2016
ASS- Sensitivity Discs (Multi Discs)	OD719	Octodiscs-C	Low risk	25/08/2016
ASS- Sensitivity Discs (Multi Discs)	OD720	Octodiscs-D	Low risk	25/08/2016
ASS- Sensitivity Discs (Multi Discs)	OD721	Octodiscs-E	Low risk	25/08/2016
ASS- Sensitivity Discs (Multi Discs)	OD722	Octodiscs-F	Low risk	25/08/2016
ASS- Sensitivity Discs (Multi Discs)	OD723	Octodiscs-G	Low risk	25/08/2016
ASS- Sensitivity Discs (Multi Discs)	OD724	Combi 507	Low risk	25/08/2016
ASS- Sensitivity Discs (Multi Discs)	OD725	Combi 508	Low risk	25/08/2016
ASS- Sensitivity Discs (Multi Discs)	OD725	Combi 508	Low risk	25/08/2016
ASS- Sensitivity Discs (Multi Discs)	OD726	Combi 509	Low risk	25/08/2016
ASS- Sensitivity Discs (Multi Discs)	OD726	Combi 509	Low risk	25/08/2016
ASS- Sensitivity Discs (Multi Discs)	OD727	Combi 510	Low risk	25/08/2016
ASS- Sensitivity Discs (Multi Discs)	OD727	Combi 510	Low risk	25/08/2016
ASS- Sensitivity Discs (Multi Discs)	OD728	Combi 511	Low risk	25/08/2016
ASS- Sensitivity Discs (Multi Discs)	OD729	Combi 512	Low risk	25/08/2016
ASS- Sensitivity Discs (Multi Discs)	OD730	Combi 513	Low risk	25/08/2016
ASS- Sensitivity Discs (Multi Discs)	OD731	Combi 514	Low risk	25/08/2016
ASS- Sensitivity Discs (Multi Discs)	OD732	Combi 515	Low risk	25/08/2016
ASS- Sensitivity Discs (Multi Discs)	OD733	Combi 516	Low risk	25/08/2016
ASS- Sensitivity Discs (Multi Discs)	OD734	Combi 517	Low risk	25/08/2016
ASS- Sensitivity Discs (Multi Discs)	OD735	Combi 518	Low risk	25/08/2016
ASS- Sensitivity Discs (Multi Discs)	OD736R	Combi 519	Low risk	25/08/2016
ASS- Sensitivity Discs (Multi Discs)	OD736R	Combi 519	Low risk	25/08/2016
ASS- Sensitivity Discs (Multi Discs)	OD737	Combi 520	Low risk	25/08/2016
ASS- Sensitivity Discs (Multi Discs)	OD737R	Combi 520	Low risk	25/08/2016
ASS- Sensitivity Discs (Multi Discs)	OD738	Combi 521	Low risk	25/08/2016
ASS- Sensitivity Discs (Multi Discs)	OD738R	Combi 521	Low risk	25/08/2016
ASS- Sensitivity Discs (Multi Discs)	OD739	Combi 522	Low risk	25/08/2016
ASS- Sensitivity Discs (Multi Discs)	OD739R	Combi 522	Low risk	25/08/2016
ASS- Sensitivity Discs (Multi Discs)	OD740	Combi 523	Low risk	25/08/2016
ASS- Sensitivity Discs (Multi Discs)	OD740R	Combi 523	Low risk	25/08/2016
ASS- Sensitivity Discs (Multi Discs)	OD741	Combi 524	Low risk	25/08/2016
ASS- Sensitivity Discs (Multi Discs)	OD741R	Combi 524	Low risk	25/08/2016
ASS- Sensitivity Discs (Multi Discs)	OD742	Combi 525	Low risk	25/08/2016
ASS- Sensitivity Discs (Multi Discs)	OD742R	Combi 525	Low risk	25/08/2016
ASS- Sensitivity Discs (Multi Discs)	OD743	Combi 526	Low risk	25/08/2016
ASS- Sensitivity Discs (Multi Discs)	OD743R	Combi 526	Low risk	25/08/2016
ASS- Sensitivity Discs (Multi Discs)	OD744	Combi 527	Low risk	25/08/2016
ASS- Sensitivity Discs (Multi Discs)	OD744R	Combi 527	Low risk	25/08/2016
ASS- Sensitivity Discs (Multi Discs)	OD745	Combi 528	Low risk	25/08/2016

ASS- Sensitivity Discs (Multi Discs)	OD745R	Combi 528	Low risk	25/08/2016
ASS- Sensitivity Discs (Multi Discs)	OD746	Combi 529	Low risk	25/08/2016
ASS- Sensitivity Discs (Multi Discs)	OD746R	Combi 529	Low risk	25/08/2016
ASS- Sensitivity Discs (Multi Discs)	OD747	Combi 530	Low risk	25/08/2016
ASS- Sensitivity Discs (Multi Discs)	OD747R	Combi 530	Low risk	25/08/2016
ASS- Sensitivity Discs (Multi Discs)	OD748	Combi 531	Low risk	25/08/2016
ASS- Sensitivity Discs (Multi Discs)	OD748R	Combi 531	Low risk	25/08/2016
ASS- Sensitivity Discs (Multi Discs)	OD749	Combi 532	Low risk	25/08/2016
ASS- Sensitivity Discs (Multi Discs)	OD749R	Combi 532	Low risk	25/08/2016
ASS- Sensitivity Discs (Multi Discs)	OD750	Combi 533	Low risk	25/08/2016
ASS- Sensitivity Discs (Multi Discs)	OD750R	Combi 533	Low risk	25/08/2016
ASS- Sensitivity Discs (Multi Discs)	OD751	Combi 534	Low risk	25/08/2016
ASS- Sensitivity Discs (Multi Discs)	OD751R	Combi 534	Low risk	25/08/2016
ASS- Sensitivity Discs (Multi Discs)	OD752	Combi 535	Low risk	25/08/2016
ASS- Sensitivity Discs (Multi Discs)	OD752R	Combi 535	Low risk	25/08/2016
ASS- Sensitivity Discs (Multi Discs)	OD753	Combi 536	Low risk	25/08/2016
ASS- Sensitivity Discs (Multi Discs)	OD753R	Combi 536	Low risk	25/08/2016
ASS- Sensitivity Discs (Multi Discs)	OD754	Combi 537	Low risk	25/08/2016
ASS- Sensitivity Discs (Multi Discs)	OD754R	Combi 537	Low risk	25/08/2016
ASS- Sensitivity Discs (Multi Discs)	OD755	Combi 538	Low risk	25/08/2016
ASS- Sensitivity Discs (Multi Discs)	OD755R	Combi 538	Low risk	25/08/2016
ASS- Sensitivity Discs (Multi Discs)	OD756	Combi 539	Low risk	25/08/2016
ASS- Sensitivity Discs (Multi Discs)	OD756R	Combi 539	Low risk	25/08/2016
ASS- Sensitivity Discs (Multi Discs)	OD757	Combi 540	Low risk	25/08/2016
ASS- Sensitivity Discs (Multi Discs)	OD757R	Combi 540	Low risk	25/08/2016
ASS- Sensitivity Discs (Multi Discs)	OD758	Combi 541	Low risk	25/08/2016
ASS- Sensitivity Discs (Multi Discs)	OD758R	Combi 541	Low risk	25/08/2016
ASS- Sensitivity Discs (Multi Discs)	OD759	Combi 542	Low risk	25/08/2016
ASS- Sensitivity Discs (Multi Discs)	OD759R	Combi 542	Low risk	25/08/2016
ASS- Sensitivity Discs (Multi Discs)	OD760	Combi 543	Low risk	25/08/2016
ASS- Sensitivity Discs (Multi Discs)	OD760R	Combi 543	Low risk	25/08/2016
ASS- Sensitivity Discs (Multi Discs)	OD761	Combi 544	Low risk	25/08/2016
ASS- Sensitivity Discs (Multi Discs)	OD761R	Combi 544	Low risk	25/08/2016
ASS- Sensitivity Discs (Multi Discs)	OD762	Combi 545	Low risk	25/08/2016
ASS- Sensitivity Discs (Multi Discs)	OD762R	Combi 545	Low risk	25/08/2016
ASS- Sensitivity Discs (Multi Discs)	OD763	Combi 546	Low risk	25/08/2016
ASS- Sensitivity Discs (Multi Discs)	OD763R	Combi 546	Low risk	25/08/2016
ASS- Sensitivity Discs (Multi Discs)	OD764	Combi 547	Low risk	25/08/2016
ASS- Sensitivity Discs (Multi Discs)	OD764R	Combi 547	Low risk	25/08/2016
ASS- Sensitivity Discs (Multi Discs)	OD765	Combi 548	Low risk	25/08/2016
ASS- Sensitivity Discs (Multi Discs)	OD765R	Combi 548	Low risk	25/08/2016
ASS- Sensitivity Discs (Multi Discs)	OD766	Combi 549	Low risk	25/08/2016
ASS- Sensitivity Discs (Multi Discs)	OD766R	Combi 549	Low risk	25/08/2016
ASS- Sensitivity Discs (Multi Discs)	OD767	Combi 550	Low risk	25/08/2016
ASS- Sensitivity Discs (Multi Discs)	OD767R	Combi 550	Low risk	25/08/2016
ASS- Sensitivity Discs (Multi Discs)	OD768	Combi 551	Low risk	25/08/2016
ASS- Sensitivity Discs (Multi Discs)	OD768R	Combi 551	Low risk	25/08/2016
ASS- Sensitivity Discs (Multi Discs)	OD769	Combi 552	Low risk	25/08/2016
ASS- Sensitivity Discs (Multi Discs)	OD769R	Combi 552	Low risk	25/08/2016
ASS- Sensitivity Discs (Multi Discs)	OD770	Combi 553	Low risk	25/08/2016
ASS- Sensitivity Discs (Multi Discs)	OD770R	Combi 553	Low risk	25/08/2016
ASS- Sensitivity Discs (Multi Discs)	OD771	Combi 554	Low risk	25/08/2016
ASS- Sensitivity Discs (Multi Discs)	OD771R	Combi 554	Low risk	25/08/2016
ASS- Sensitivity Discs (Multi Discs)	OD772	Combi 555	Low risk	16/12/2017
ASS- Sensitivity Discs (Multi Discs)	OD772R	Combi 555	Low risk	16/12/2017
ASS- Sensitivity Discs (Multi Discs)	OD773	Combi 556	Low risk	16/12/2017
ASS- Sensitivity Discs (Multi Discs)	OD773R	Combi 556	Low risk	16/12/2017
ASS- Sensitivity Discs (Multi Discs)	OD774	Combi 557	Low risk	16/12/2017

ASS- Sensitivity Discs (Multi Discs)	OD774R	Combi 557	Low risk	16/12/2017
ASS- Sensitivity Discs (Multi Discs)	OD775	Combi 558	Low risk	16/12/2017
ASS- Sensitivity Discs (Multi Discs)	OD775R	Combi 558	Low risk	16/12/2017
ASS- Sensitivity Discs (Multi Discs)	OD776	Combi 559	Low risk	04/07/2018
ASS- Sensitivity Discs (Multi Discs)	OD776R	Combi 559	Low risk	04/07/2018
ASS- Sensitivity Discs (Multi Discs)	OD777	Combi 560	Low risk	04/07/2018
ASS- Sensitivity Discs (Multi Discs)	OD777R	Combi 560	Low risk	04/07/2018
ASS- Sensitivity Discs (Multi Discs)	OD778	Combi 561	Low risk	04/07/2018
ASS- Sensitivity Discs (Multi Discs)	OD778R	Combi 561	Low risk	04/07/2018
ASS- Sensitivity Discs (Multi Discs)	OD779	Combi 562	Low risk	22/04/2019
ASS- Sensitivity Discs (Multi Discs)	OD779R	Combi 562	Low risk	22/04/2019
ASS- Sensitivity Discs (Single Discs)	SD001	Amoxicillin	Low risk	20/12/2012
ASS- Sensitivity Discs (Single Discs)	SD002	Ampicillin	Low risk	20/12/2012
ASS- Sensitivity Discs (Single Discs)	SD002A	Ampicillin	Low risk	20/12/2012
ASS- Sensitivity Discs (Single Discs)	SD003	Bacitracin	Low risk	20/12/2012
ASS- Sensitivity Discs (Single Discs)	SD004	Carbenicillin	Low risk	20/12/2012
ASS- Sensitivity Discs (Single Discs)	SD005	Cefaloridine (Cephaloridine)	Low risk	20/12/2012
ASS- Sensitivity Discs (Single Discs)	SD006	Chloramphenicol	Low risk	20/12/2012
ASS- Sensitivity Discs (Single Discs)	SD006B	Chloramphenicol(2 mcg)	Low risk	25/08/2016
ASS- Sensitivity Discs (Single Discs)	SD007	Chlortetracycline	Low risk	20/12/2012
ASS- Sensitivity Discs (Single Discs)	SD008	Cloxacillin	Low risk	20/12/2012
ASS- Sensitivity Discs (Single Discs)	SD009	Colistin (Methane Sulphonate)	Low risk	20/12/2012
ASS- Sensitivity Discs (Single Discs)	SD010	Co-Trimoxazole (Sulpha/Trimethoprim)	Low risk	20/12/2012
ASS- Sensitivity Discs (Single Discs)	SD012	Doxycycline Hydrochloride	Low risk	20/12/2012
ASS- Sensitivity Discs (Single Discs)	SD013	Erythromycin	Low risk	20/12/2012
ASS- Sensitivity Discs (Single Discs)	SD014	Framycetin	Low risk	20/12/2012
ASS- Sensitivity Discs (Single Discs)	SD015	Furazolidone	Low risk	20/12/2012
ASS- Sensitivity Discs (Single Discs)	SD016	Gentamicin	Low risk	20/12/2012
ASS- Sensitivity Discs (Single Discs)	SD017	Kanamycin	Low risk	20/12/2012
ASS- Sensitivity Discs (Single Discs)	SD018	Lincomycin	Low risk	20/12/2012
ASS- Sensitivity Discs (Single Discs)	SD019	Methicillin	Low risk	20/12/2012
ASS- Sensitivity Discs (Single Discs)	SD020	Metronidazole	Low risk	20/12/2012
ASS- Sensitivity Discs (Single Discs)	SD021	Nalidixic Acid	Low risk	20/12/2012
ASS- Sensitivity Discs (Single Discs)	SD022	Neomycin	Low risk	20/12/2012
ASS- Sensitivity Discs (Single Discs)	SD023	Nitrofurantoin	Low risk	20/12/2012
ASS- Sensitivity Discs (Single Discs)	SD023A	Nitrofurantoin	Low risk	25/08/2016
ASS- Sensitivity Discs (Single Discs)	SD024	Nitrofurazone	Low risk	20/12/2012
ASS- Sensitivity Discs (Single Discs)	SD025	Nystatin	Low risk	20/12/2012
ASS- Sensitivity Discs (Single Discs)	SD026	Oleandomycin	Low risk	20/12/2012
ASS- Sensitivity Discs (Single Discs)	SD027	Oxytetracycline	Low risk	20/12/2012
ASS- Sensitivity Discs (Single Discs)	SD028	Penicillin-G	Low risk	20/12/2012
ASS- Sensitivity Discs (Single Discs)	SD029	Polymyxin-B	Low risk	20/12/2012
ASS- Sensitivity Discs (Single Discs)	SD030	Rifampicin	Low risk	20/12/2012
ASS- Sensitivity Discs (Single Discs)	SD031	Streptomycin	Low risk	20/12/2012
ASS- Sensitivity Discs (Single Discs)	SD032	Sulphafurazole (Sulfisoxazole)	Low risk	20/12/2012
ASS- Sensitivity Discs (Single Discs)	SD033	Sulphamethizole	Low risk	20/12/2012
ASS- Sensitivity Discs (Single Discs)	SD034	Sulphadiazine	Low risk	20/12/2012
ASS- Sensitivity Discs (Single Discs)	SD035	Amikacin	Low risk	20/12/2012
ASS- Sensitivity Discs (Single Discs)	SD036	Sulphaphenazole	Low risk	20/12/2012
ASS- Sensitivity Discs (Single Discs)	SD037	Tetracycline	Low risk	20/12/2012
ASS- Sensitivity Discs (Single Discs)	SD038	Triple Sulphas	Low risk	20/12/2012
ASS- Sensitivity Discs (Single Discs)	SD039	Trimethoprim	Low risk	20/12/2012
ASS- Sensitivity Discs (Single Discs)	SD040	Cefotaxime	Low risk	20/12/2012
ASS- Sensitivity Discs (Single Discs)	SD040A	Cefotaxime	Low risk	20/12/2012
ASS- Sensitivity Discs (Single Discs)	SD041	Cefoxitin	Low risk	20/12/2012
ASS- Sensitivity Discs (Single Discs)	SD042	Furoxone	Low risk	20/12/2012
ASS- Sensitivity Discs (Single Discs)	SD043	Oxacillin	Low risk	20/12/2012
ASS- Sensitivity Discs (Single Discs)	SD044	Tobramycin	Low risk	20/12/2012

ASS- Sensitivity Discs (Single Discs)	SD045	Vancomycin	Low risk	20/12/2012
ASS- Sensitivity Discs (Single Discs)	SD046	Netillin	Low risk	20/12/2012
ASS- Sensitivity Discs (Single Discs)	SD047	Cefazolin	Low risk	20/12/2012
ASS- Sensitivity Discs (Single Discs)	SD048	Cefalexin(Cephalexin)	Low risk	20/12/2012
ASS- Sensitivity Discs (Single Discs)	SD049	Cycloserine	Low risk	25/08/2016
ASS- Sensitivity Discs (Single Discs)	SD050	Cephalothin	Low risk	20/12/2012
ASS- Sensitivity Discs (Single Discs)	SD051	Clindamycin	Low risk	20/12/2012
ASS- Sensitivity Discs (Single Discs)	SD052	Dicloxacillin	Low risk	20/12/2012
ASS- Sensitivity Discs (Single Discs)	SD053	Novobiocin	Low risk	20/12/2012
ASS- Sensitivity Discs (Single Discs)	SD054	Spiramycin	Low risk	20/12/2012
ASS- Sensitivity Discs (Single Discs)	SD055	Sulphamethoxypyridazine	Low risk	20/12/2012
ASS- Sensitivity Discs (Single Discs)	SD056	Sulfasomidine	Low risk	20/12/2012
ASS- Sensitivity Discs (Single Discs)	SD056A	Sulphamethoxazole	Low risk	25/08/2016
ASS- Sensitivity Discs (Single Discs)	SD057	Norfloxacin	Low risk	20/12/2012
ASS- Sensitivity Discs (Single Discs)	SD058	Co-Trimazine (Vet.)	Low risk	25/08/2016
ASS- Sensitivity Discs (Single Discs)	SD059	Sisomicin	Low risk	20/12/2012
ASS- Sensitivity Discs (Single Discs)	SD060	Ciprofloxacin	Low risk	20/12/2012
ASS- Sensitivity Discs (Single Discs)	SD060A	Ciprofloxacin	Low risk	20/12/2012
ASS- Sensitivity Discs (Single Discs)	SD061	Cefuroxime	Low risk	20/12/2012
ASS- Sensitivity Discs (Single Discs)	SD062	Ceftazidime	Low risk	20/12/2012
ASS- Sensitivity Discs (Single Discs)	SD062A	Ceftazidime	Low risk	20/12/2012
ASS- Sensitivity Discs (Single Discs)	SD063	Amoxyclav (Amoxycillin/Clavulanic acid)	Low risk	20/12/2012
ASS- Sensitivity Discs (Single Discs)	SD063A	Augmentine	Low risk	25/08/2016
ASS- Sensitivity Discs (Single Discs)	SD064	Azlocillin	Low risk	20/12/2012
ASS- Sensitivity Discs (Single Discs)	SD065	Ceftriaxone	Low risk	20/12/2012
ASS- Sensitivity Discs (Single Discs)	SD066	Piperacillin	Low risk	20/12/2012
ASS- Sensitivity Discs (Single Discs)	SD066A	Piperacillin	Low risk	20/12/2012
ASS- Sensitivity Discs (Single Discs)	SD067	Sterile Discs	Low risk	20/12/2012
ASS- Sensitivity Discs (Single Discs)	SD068	Methanamine Mandalate	Low risk	20/12/2012
ASS- Sensitivity Discs (Single Discs)	SD069	Ofloxacin	Low risk	20/12/2012
ASS- Sensitivity Discs (Single Discs)	SD070	Pefloxacin	Low risk	20/12/2012
ASS- Sensitivity Discs (Single Discs)	SD071	Co-Trimazine (Human)	Low risk	20/12/2012
ASS- Sensitivity Discs (Single Discs)	SD072	Cefoperazone	Low risk	20/12/2012
ASS- Sensitivity Discs (Single Discs)	SD073	Imipenem	Low risk	20/12/2012
ASS- Sensitivity Discs (Single Discs)	SD074	Ticarcillin	Low risk	20/12/2012
ASS- Sensitivity Discs (Single Discs)	SD075	Cloxacillin	Low risk	20/12/2012
ASS- Sensitivity Discs (Single Discs)	SD076	Amoxycillin	Low risk	20/12/2012
ASS- Sensitivity Discs (Single Discs)	SD077	Ampicillin	Low risk	20/12/2012
ASS- Sensitivity Discs (Single Discs)	SD078	Amoxyclav	Low risk	20/12/2012
ASS- Sensitivity Discs (Single Discs)	SD079	Cefaloridine	Low risk	20/12/2012
ASS- Sensitivity Discs (Single Discs)	SD080	Ciprofloxacin	Low risk	20/12/2012
ASS- Sensitivity Discs (Single Discs)	SD081	Chloramphenicol	Low risk	20/12/2012
ASS- Sensitivity Discs (Single Discs)	SD082	Amikacin	Low risk	20/12/2012
ASS- Sensitivity Discs (Single Discs)	SD083	Erythromycin	Low risk	20/12/2012
ASS- Sensitivity Discs (Single Discs)	SD084	Lincomycin	Low risk	20/12/2012
ASS- Sensitivity Discs (Single Discs)	SD085	Netillin	Low risk	20/12/2012
ASS- Sensitivity Discs (Single Discs)	SD086	Nitrofurantoin	Low risk	20/12/2012
ASS- Sensitivity Discs (Single Discs)	SD087	Ofloxacin	Low risk	20/12/2012
ASS- Sensitivity Discs (Single Discs)	SD088	Oxacillin	Low risk	20/12/2012
ASS- Sensitivity Discs (Single Discs)	SD089	Penicillin-G	Low risk	20/12/2012
ASS- Sensitivity Discs (Single Discs)	SD090	Nitrofurantoin	Low risk	20/12/2012
ASS- Sensitivity Discs (Single Discs)	SD091	Streptomycin	Low risk	20/12/2012
ASS- Sensitivity Discs (Single Discs)	SD092	Sulphadiazine	Low risk	20/12/2012
ASS- Sensitivity Discs (Single Discs)	SD093	Trimethoprim	Low risk	20/12/2012
ASS- Sensitivity Discs (Single Discs)	SD094	Azlocillin	Low risk	20/12/2012
ASS- Sensitivity Discs (Single Discs)	SD096	Rifampicin	Low risk	20/12/2012
ASS- Sensitivity Discs (Single Discs)	SD097	Colistin (Methane Sulphonate)	Low risk	20/12/2012
ASS- Sensitivity Discs (Single Discs)	SD098	Lincomycin	Low risk	20/12/2012

ASS- Sensitivity Discs (Single Discs)	SD099	Metronidazole	Low risk	20/12/2012
ASS- Sensitivity Discs (Single Discs)	SD101	Spiramycin	Low risk	20/12/2012
ASS- Sensitivity Discs (Single Discs)	SD102	Penicillin-G (1.5 units)	Low risk	25/08/2016
ASS- Sensitivity Discs (Single Discs)	SD103	Nitrofurantoin NIT	Low risk	25/08/2016
ASS- Sensitivity Discs (Single Discs)	SD104	Neomycin N	Low risk	25/08/2016
ASS- Sensitivity Discs (Single Discs)	SD105	Bacitracin	Low risk	20/12/2012
ASS- Sensitivity Discs (Single Discs)	SD106	Polymyxin-B	Low risk	20/12/2012
ASS- Sensitivity Discs (Single Discs)	SD107	Metronidazole	Low risk	25/08/2016
ASS- Sensitivity Discs (Single Discs)	SD108	Colistin (Methane Sulphonate)	Low risk	20/12/2012
ASS- Sensitivity Discs (Single Discs)	SD109	Ceftriaxone	Low risk	20/12/2012
ASS- Sensitivity Discs (Single Discs)	SD110	Ceftizoxime	Low risk	20/12/2012
ASS- Sensitivity Discs (Single Discs)	SD111	Amphotericin-B	Low risk	20/12/2012
ASS- Sensitivity Discs (Single Discs)	SD112	Ampicillin/Sulbactam	Low risk	20/12/2012
ASS- Sensitivity Discs (Single Discs)	SD113	Ampicillin/Cloxacillin	Low risk	20/12/2012
ASS- Sensitivity Discs (Single Discs)	SD114	Fluconazole	Low risk	20/12/2012
ASS- Sensitivity Discs (Single Discs)	SD115	Clotrimazole	Low risk	20/12/2012
ASS- Sensitivity Discs (Single Discs)	SD116	Cefadroxil (Cephadroxil)	Low risk	20/12/2012
ASS- Sensitivity Discs (Single Discs)	SD117	Bacitracin (0.1 units)	Low risk	25/08/2016
ASS- Sensitivity Discs (Single Discs)	SD118	Bacitracin (2 units)	Low risk	25/08/2016
ASS- Sensitivity Discs (Single Discs)	SD119	Bacitracin (1 unit)	Low risk	25/08/2016
ASS- Sensitivity Discs (Single Discs)	SD120	Doxycycline Hydrochloride	Low risk	20/12/2012
ASS- Sensitivity Discs (Single Discs)	SD121	Novobiocin	Low risk	20/12/2012
ASS- Sensitivity Discs (Single Discs)	SD123	Tetracycline T	Low risk	25/08/2016
ASS- Sensitivity Discs (Single Discs)	SD124	Azithromycin	Low risk	20/12/2012
ASS- Sensitivity Discs (Single Discs)	SD125	Lomefloxacin	Low risk	20/12/2012
ASS- Sensitivity Discs (Single Discs)	SD126	Roxithromycin	Low risk	20/12/2012
ASS- Sensitivity Discs (Single Discs)	SD127	Rifampicin	Low risk	20/12/2012
ASS- Sensitivity Discs (Single Discs)	SD128	Rifampicin	Low risk	20/12/2012
ASS- Sensitivity Discs (Single Discs)	SD129	Amoxycillin	Low risk	20/12/2012
ASS- Sensitivity Discs (Single Discs)	SD130	Cephaloridine	Low risk	25/08/2016
ASS- Sensitivity Discs (Single Discs)	SD131	Chloramphenicol	Low risk	20/12/2012
ASS- Sensitivity Discs (Single Discs)	SD132	Piperacillin	Low risk	20/12/2012
ASS- Sensitivity Discs (Single Discs)	SD133	Tetracycline	Low risk	20/12/2012
ASS- Sensitivity Discs (Single Discs)	SD134	Tobramycin TB	Low risk	25/08/2016
ASS- Sensitivity Discs (Single Discs)	SD135	Trimethoprim	Low risk	25/08/2016
ASS- Sensitivity Discs (Single Discs)	SD136	Methicillin	Low risk	20/12/2012
ASS- Sensitivity Discs (Single Discs)	SD137	Methicillin	Low risk	20/12/2012
ASS- Sensitivity Discs (Single Discs)	SD138	Erythromycin	Low risk	25/08/2016
ASS- Sensitivity Discs (Single Discs)	SD139	Polymyxin-B	Low risk	20/12/2012
ASS- Sensitivity Discs (Single Discs)	SD140	Floxidin	Low risk	20/12/2012
ASS- Sensitivity Discs (Single Discs)	SD141	Floxidin	Low risk	20/12/2012
ASS- Sensitivity Discs (Single Discs)	SD142	Ciprofloxacin	Low risk	20/12/2012
ASS- Sensitivity Discs (Single Discs)	SD143	Cloxacillin	Low risk	20/12/2012
ASS- Sensitivity Discs (Single Discs)	SD144	Penicillin-G	Low risk	20/12/2012
ASS- Sensitivity Discs (Single Discs)	SD145	Penicillin-G	Low risk	25/08/2016
ASS- Sensitivity Discs (Single Discs)	SD147	Tetracycline	Low risk	25/08/2016
ASS- Sensitivity Discs (Single Discs)	SD148	Trimethoprim	Low risk	20/12/2012
ASS- Sensitivity Discs (Single Discs)	SD149	Trimethoprim	Low risk	20/12/2012
ASS- Sensitivity Discs (Single Discs)	SD150	Enrofloxacin	Low risk	20/12/2012
ASS- Sensitivity Discs (Single Discs)	SD152	Penicillin-G	Low risk	25/08/2016
ASS- Sensitivity Discs (Single Discs)	SD153	Chloramphenicol	Low risk	20/12/2012
ASS- Sensitivity Discs (Single Discs)	SD154	Tobramycin	Low risk	20/12/2012
ASS- Sensitivity Discs (Single Discs)	SD156	Enrofloxacin	Low risk	20/12/2012
ASS- Sensitivity Discs (Single Discs)	SD157	Cefaclor	Low risk	20/12/2012
ASS- Sensitivity Discs (Single Discs)	SD158	Minocycline	Low risk	20/12/2012
ASS- Sensitivity Discs (Single Discs)	SD159	Cephadrine	Low risk	25/08/2016
ASS- Sensitivity Discs (Single Discs)	SD160	Cefradine	Low risk	20/12/2012
ASS- Sensitivity Discs (Single Discs)	SD161	Trimethoprim	Low risk	25/08/2016

ASS- Sensitivity Discs (Single Discs)	SD162	Sparfloxacin	Low risk	20/12/2012
ASS- Sensitivity Discs (Single Discs)	SD163	Vancomycin	Low risk	20/12/2012
ASS- Sensitivity Discs (Single Discs)	SD164	Clindamycin	Low risk	20/12/2012
ASS- Sensitivity Discs (Single Discs)	SD165	Cloxacillin	Low risk	20/12/2012
ASS- Sensitivity Discs (Single Discs)	SD166	Gentamicin	Low risk	20/12/2012
ASS- Sensitivity Discs (Single Discs)	SD167	Penicillin-G	Low risk	25/08/2016
ASS- Sensitivity Discs (Single Discs)	SD168	Ceftriaxone Ci	Low risk	25/08/2016
ASS- Sensitivity Discs (Single Discs)	SD169	Fusidic Acid	Low risk	20/12/2012
ASS- Sensitivity Discs (Single Discs)	SD170	Gentamicin	Low risk	20/12/2012
ASS- Sensitivity Discs (Single Discs)	SD171	Fusidic Acid	Low risk	20/12/2012
ASS- Sensitivity Discs (Single Discs)	SD174	Polymyxin-B Pb	Low risk	25/08/2016
ASS- Sensitivity Discs (Single Discs)	SD175	Pipemidic Acid	Low risk	20/12/2012
ASS- Sensitivity Discs (Single Discs)	SD176	Mecillinam	Low risk	20/12/2012
ASS- Sensitivity Discs (Single Discs)	SD177	Mecillinam	Low risk	20/12/2012
ASS- Sensitivity Discs (Single Discs)	SD178	Pristinomycin	Low risk	20/12/2012
ASS- Sensitivity Discs (Single Discs)	SD179	Fosfomycin	Low risk	20/12/2012
ASS- Sensitivity Discs (Single Discs)	SD180	Oxolinic Acid (10 mcg)	Low risk	25/08/2016
ASS- Sensitivity Discs (Single Discs)	SD181	Spectinomycin	Low risk	20/12/2012
ASS- Sensitivity Discs (Single Discs)	SD182	Virginamycin	Low risk	20/12/2012
ASS- Sensitivity Discs (Single Discs)	SD184	Norfloxacin	Low risk	20/12/2012
ASS- Sensitivity Discs (Single Discs)	SD185	Pipemidic Acid	Low risk	20/12/2012
ASS- Sensitivity Discs (Single Discs)	SD186	Oxolinic Acid (2 mcg)	Low risk	25/08/2016
ASS- Sensitivity Discs (Single Discs)	SD187	Flumequine (2 mcg)	Low risk	25/08/2016
ASS- Sensitivity Discs (Single Discs)	SD188	Dibekacine (10 mcg)	Low risk	25/08/2016
ASS- Sensitivity Discs (Single Discs)	SD189	Oxolinic Acid (5 mcg)	Low risk	25/08/2016
ASS- Sensitivity Discs (Single Discs)	SD190	Flumequine (5 mcg)	Low risk	25/08/2016
ASS- Sensitivity Discs (Single Discs)	SD191	Kanamycin (1 mcg) (K1)	Low risk	25/08/2016
ASS- Sensitivity Discs (Single Discs)	SD192	Clarithromycin	Low risk	20/12/2012
ASS- Sensitivity Discs (Single Discs)	SD195	Gentamicin	Low risk	20/12/2012
ASS- Sensitivity Discs (Single Discs)	SD196	Nitroxoline	Low risk	20/12/2012
ASS- Sensitivity Discs (Single Discs)	SD197	Furazolidone	Low risk	20/12/2012
ASS- Sensitivity Discs (Single Discs)	SD198	Flumequine	Low risk	25/08/2016
ASS- Sensitivity Discs (Single Discs)	SD199	Tylosine	Low risk	20/12/2012
ASS- Sensitivity Discs (Single Discs)	SD200	Cefamandole	Low risk	20/12/2012
ASS- Sensitivity Discs (Single Discs)	SD201	Ticarcillin	Low risk	20/12/2012
ASS- Sensitivity Discs (Single Discs)	SD203	Cefoperazone	Low risk	20/12/2012
ASS- Sensitivity Discs (Single Discs)	SD204	Azithromycin	Low risk	20/12/2012
ASS- Sensitivity Discs (Single Discs)	SD205	Fosfomycin	Low risk	20/12/2012
ASS- Sensitivity Discs (Single Discs)	SD206	Lomefloxacin	Low risk	20/12/2012
ASS- Sensitivity Discs (Single Discs)	SD207	Ceftazidime /Clavulanic acid	Low risk	20/12/2012
ASS- Sensitivity Discs (Single Discs)	SD209	Cefprozil	Low risk	20/12/2012
ASS- Sensitivity Discs (Single Discs)	SD210	Piperacillin/Tazobactam	Low risk	20/12/2012
ASS- Sensitivity Discs (Single Discs)	SD211	Cefixime	Low risk	20/12/2012
ASS- Sensitivity Discs (Single Discs)	SD212	Aztreonam	Low risk	20/12/2012
ASS- Sensitivity Discs (Single Discs)	SD213	Teicoplanin	Low risk	20/12/2012
ASS- Sensitivity Discs (Single Discs)	SD214	Isepamicin	Low risk	20/12/2012
ASS- Sensitivity Discs (Single Discs)	SD215	Linezolid	Low risk	20/12/2012
ASS- Sensitivity Discs (Single Discs)	SD216	Levofloxacin	Low risk	20/12/2012
ASS- Sensitivity Discs (Single Discs)	SD217	Moxifloxacin	Low risk	20/12/2012
ASS- Sensitivity Discs (Single Discs)	SD218	Cefdinir	Low risk	20/12/2012
ASS- Sensitivity Discs (Single Discs)	SD219	Cefepime	Low risk	20/12/2012
ASS- Sensitivity Discs (Single Discs)	SD220	Moxalactam	Low risk	20/12/2012
ASS- Sensitivity Discs (Single Discs)	SD221	Itraconazole	Low risk	20/12/2012
ASS- Sensitivity Discs (Single Discs)	SD222	Erythromycin	Low risk	20/12/2012
ASS- Sensitivity Discs (Single Discs)	SD223	Kanamycin	Low risk	20/12/2012
ASS- Sensitivity Discs (Single Discs)	SD224	Ketoconazole	Low risk	20/12/2012
ASS- Sensitivity Discs (Single Discs)	SD225	Mezlocillin	Low risk	20/12/2012
ASS- Sensitivity Discs (Single Discs)	SD231	Cefoperazone :Sulbactam (30mcg:10mcg)	Low risk	25/08/2016

ASS- Sensitivity Discs (Single Discs)	SD232	Fluconazole	Low risk	20/12/2012
ASS- Sensitivity Discs (Single Discs)	SD233	Amphotericin B	Low risk	20/12/2012
ASS- Sensitivity Discs (Single Discs)	SD234	Cefepime	Low risk	20/12/2012
ASS- Sensitivity Discs (Single Discs)	SD235	Cefpirome	Low risk	20/12/2012
ASS- Sensitivity Discs (Single Discs)	SD236	Streptomycin For detection of HLAR Strains.	Low risk	20/12/2012
ASS- Sensitivity Discs (Single Discs)	SD237	Enoxacin	Low risk	20/12/2012
ASS- Sensitivity Discs (Single Discs)	SD238	Kit I for ESBL Identification, Cefotaxime (Cephotaxime) Kit contains 6 cartridges (6CT): 3CT of SD040 Cefotaxime (Cephotaxime) 30 mcg, 3CT of SD724 Cefotaxime (Cephotaxime)/Clavulanic acid 30/10 mcg	Low risk	20/12/2012
ASS- Sensitivity Discs (Single Discs)	SD239	Kit II for ESBL Identification, Cefepime Kit contains 6 cartridges (6CT): 3CT of SD219 Cefepime 30 mcg, 3CT of SD234 Cefepime /Clavulanic acid 30/10 mcg	Low risk	20/12/2012
ASS- Sensitivity Discs (Single Discs)	SD240	Kit III for ESBL Identification, Ceftazidime Kit contains 6 cartridges (6CT): 3CT of SD062 Ceftazidime 30 mcg, 3CT of SD207 Ceftazidime /Clavulanic acid 30/10 mcg	Low risk	20/12/2012
ASS- Sensitivity Discs (Single Discs)	SD241	Kit IV for ESBL Identification, Cefpirome Kit contains 6 cartridges (6CT): 3CT of SD738 Cefpirome 30 mcg, 3CT of SD235 Cefpirome /Clavulanic acid 30/7.5 mcg	Low risk	20/12/2012
ASS- Sensitivity Discs (Single Discs)	SD242	Kit V for ESBL identif	Low risk	25/08/2016
ASS- Sensitivity Discs (Single Discs)	SD243	Amoxyclav (Amoxycillin / Clavulanic acid)	Low risk	25/08/2016
ASS- Sensitivity Discs (Single Discs)	SD244	Cefmetazole	Low risk	20/12/2012
ASS- Sensitivity Discs (Single Discs)	SD245	Cinoxacin	Low risk	20/12/2012
ASS- Sensitivity Discs (Single Discs)	SD246	Nafcillin	Low risk	20/12/2012
ASS- Sensitivity Discs (Single Discs)	SD247	Cefepime/Tazobactam	Low risk	20/12/2012
ASS- Sensitivity Discs (Single Discs)	SD248	Cefonicid	Low risk	20/12/2012
ASS- Sensitivity Discs (Single Discs)	SD249	Cefotetan	Low risk	20/12/2012
ASS- Sensitivity Discs (Single Discs)	SD250	Gemifloxacin	Low risk	20/12/2012
ASS- Sensitivity Discs (Single Discs)	SD251	Ceftriaxone/Tazobactam	Low risk	20/12/2012
ASS- Sensitivity Discs (Single Discs)	SD252	Ceftazidime/Tazobactam	Low risk	20/12/2012
ASS- Sensitivity Discs (Single Discs)	SD253	Cefoperazone/Tazobactam	Low risk	20/12/2012
ASS- Sensitivity Discs (Single Discs)	SD254	Cefoperazone/	Low risk	20/12/2012
ASS- Sensitivity Discs (Single Discs)	SD255	Cefpodoxime/ Clavulanic acid	Low risk	25/08/2016
ASS- Sensitivity Discs (Single Discs)	SD256	Ceftriaxone/Tazobactam	Low risk	20/12/2012
ASS- Sensitivity Discs (Single Discs)	SD257	Cefepime/Tazobactam	Low risk	20/12/2012
ASS- Sensitivity Discs (Single Discs)	SD258	Nadifloxacin	Low risk	20/12/2012
ASS- Sensitivity Discs (Single Discs)	SD259	Cefoperazone/Sulbactam	Low risk	20/12/2012
ASS- Sensitivity Discs (Single Discs)	SD260	Lomefloxacin	Low risk	20/12/2012
ASS- Sensitivity Discs (Single Discs)	SD261	Ceftriaxone/ Sulbactam	Low risk	20/12/2012
ASS- Sensitivity Discs (Single Discs)	SD262	Cefepime	Low risk	20/12/2012
ASS- Sensitivity Discs (Single Discs)	SD263	Aztreonam	Low risk	20/12/2012
ASS- Sensitivity Discs (Single Discs)	SD264	Amoxycillin/	Low risk	20/12/2012
ASS- Sensitivity Discs (Single Discs)	SD265	Imipenem/Cilastin	Low risk	20/12/2012
ASS- Sensitivity Discs (Single Discs)	SD266	Cefixime/	Low risk	20/12/2012
ASS- Sensitivity Discs (Single Discs)	SD267	Prulifloxacin	Low risk	20/12/2012
ASS- Sensitivity Discs (Single Discs)	SD268	Prulifloxacin	Low risk	20/12/2012
ASS- Sensitivity Discs (Single Discs)	SD269	Ceftazidime/Tazobactam	Low risk	20/12/2012
ASS- Sensitivity Discs (Single Discs)	SD270	Amphotericin B	Low risk	20/12/2012
ASS- Sensitivity Discs (Single Discs)	SD271	Nystatin	Low risk	20/12/2012
ASS- Sensitivity Discs (Single Discs)	SD272	Miconazole	Low risk	20/12/2012
ASS- Sensitivity Discs (Single Discs)	SD273	Miconazole	Low risk	20/12/2012
ASS- Sensitivity Discs (Single Discs)	SD274	Ketoconazole	Low risk	20/12/2012
ASS- Sensitivity Discs (Single Discs)	SD275	Ketoconazole	Low risk	20/12/2012
ASS- Sensitivity Discs (Single Discs)	SD276	Itraconazole	Low risk	20/12/2012
ASS- Sensitivity Discs (Single Discs)	SD277	Voriconazole	Low risk	20/12/2012
ASS- Sensitivity Discs (Single Discs)	SD278	Tigecycline	Low risk	20/12/2012
ASS- Sensitivity Discs (Single Discs)	SD279	Faropenem	Low risk	20/12/2012
ASS- Sensitivity Discs (Single Discs)	SD280	Ertapenem	Low risk	20/12/2012
ASS- Sensitivity Discs (Single Discs)	SD281	Amoxyclav	Low risk	20/12/2012

ASS- Sensitivity Discs (Single Discs)	SD282	Imipenem-EDTA	Low risk	20/12/2012
ASS- Sensitivity Discs (Single Discs)	SD283	Doripenem	Low risk	20/12/2012
ASS- Sensitivity Discs (Single Discs)	SD284	Cloxacillin	Low risk	20/12/2012
ASS- Sensitivity Discs (Single Discs)	SD285	Cefoxitin-	Low risk	20/12/2012
ASS- Sensitivity Discs (Single Discs)	SD286	Amoxicillin/Sulbactam	Low risk	25/08/2016
ASS- Sensitivity Discs (Single Discs)	SD287	Ampicillin/Sulbactam	Low risk	25/08/2016
ASS- Sensitivity Discs (Single Discs)	SD288	Cefotaxime CTX	Low risk	25/08/2016
ASS- Sensitivity Discs (Single Discs)	SD288	Cefotaxime CTX	Low risk	25/08/2016
ASS- Sensitivity Discs (Single Discs)	SD289	Ceftriaxone CTR	Low risk	25/08/2016
ASS- Sensitivity Discs (Single Discs)	SD290E	Ceftaroline	Low risk	20/12/2012
ASS- Sensitivity Discs (Single Discs)	SD291E	Telithromycin	Low risk	20/12/2012
ASS- Sensitivity Discs (Single Discs)	SD292E	Piperacillin / Tazobactam	Low risk	20/12/2012
ASS- Sensitivity Discs (Single Discs)	SD293E	Mupirocin	Low risk	20/12/2012
ASS- Sensitivity Discs (Single Discs)	SD294E	Ceftibuten	Low risk	20/12/2012
ASS- Sensitivity Discs (Single Discs)	SD295E	Cefotaxime CTX	Low risk	25/08/2016
ASS- Sensitivity Discs (Single Discs)	SD296E	Linezolid LZ	Low risk	25/08/2016
ASS- Sensitivity Discs (Single Discs)	SD701	Carbenicilline	Low risk	25/08/2016
ASS- Sensitivity Discs (Single Discs)	SD704	Cefradine	Low risk	20/12/2012
ASS- Sensitivity Discs (Single Discs)	SD705	Amoxicillin (2 mcg)	Low risk	25/08/2016
ASS- Sensitivity Discs (Single Discs)	SD709	Novobiocin (5mcg)	Low risk	25/08/2016
ASS- Sensitivity Discs (Single Discs)	SD712	Oleandomycin (5 mcg)	Low risk	25/08/2016
ASS- Sensitivity Discs (Single Discs)	SD715	Fluconazole (25 mcg)	Low risk	25/08/2016
ASS- Sensitivity Discs (Single Discs)	SD722	Penicillin-G (2mcg)	Low risk	25/08/2016
ASS- Sensitivity Discs (Single Discs)	SD723	Ampicillin (20mcg)	Low risk	25/08/2016
ASS- Sensitivity Discs (Single Discs)	SD724	Cefotaxime/Clavulanic acid (30/10 mcg)SD725	Low risk	20/12/2012
ASS- Sensitivity Discs (Single Discs)	SD725	Cefpodoxime	Low risk	20/12/2012
ASS- Sensitivity Discs (Single Discs)	SD726	Ceftazidime/Clavulanic (3/10 mcg)	Low risk	25/08/2016
ASS- Sensitivity Discs (Single Discs)	SD727	Meropenem	Low risk	20/12/2012
ASS- Sensitivity Discs (Single Discs)	SD730	Metronidazole (50 mcg)	Low risk	25/08/2016
ASS- Sensitivity Discs (Single Discs)	SD731	Neomycin	Low risk	20/12/2012
ASS- Sensitivity Discs (Single Discs)	SD732	Novobiocin (5mcg)	Low risk	25/08/2016
ASS- Sensitivity Discs (Single Discs)	SD736	Bacitracin B 0.05 units /disc	Low risk	25/08/2016
ASS- Sensitivity Discs (Single Discs)	SD737	Gatifloxacin	Low risk	20/12/2012
ASS- Sensitivity Discs (Single Discs)	SD738	Cefpirome (Cfp) (30mcg)	Low risk	25/08/2016
ASS- Sensitivity Discs (Single Discs)	SD740	Gatifloxacin	Low risk	20/12/2012
ASS- Sensitivity Discs (Single Discs)	SD741	Cephotaxime/Sulbactam (30/15 mcg)	Low risk	25/08/2016
ASS- Sensitivity Discs (Single Discs)	SD744	Ofloxacin (30mcg)	Low risk	25/08/2016
ASS- Sensitivity Discs (Single Discs)	SD744	Ofloxacin Of 30 mcg	Low risk	25/08/2016
ASS- Sensitivity Discs (Single Discs)	SD745	Norfloxacin (30mcg)	Low risk	25/08/2016
ASS- Sensitivity Discs (Single Discs)	SD746	Gentamicin (200mcg)	Low risk	25/08/2016
ASS- Sensitivity Discs (Single Discs)	SD748	Mupirocin MU 5 mcg	Low risk	25/08/2016
ASS- Sensitivity Discs (Single Discs)	SD751	Cefpodoxime/ Clavulanic acid (10/1 MCG)	Low risk	25/08/2016
ASS- Sensitivity Discs (Single Discs)	SD753	Gatifloxacin	Low risk	20/12/2012
ASS- Sensitivity Discs (Single Discs)	SD755	Ceftiofur (0.2mcg)	Low risk	25/08/2016
ASS- Sensitivity Discs (Single Discs)	SD756	Ceftiaxone (30 mcg) / Sulbactam (15 mcg)	Low risk	25/08/2016
ASS- Sensitivity Discs (Single Discs)	SD761	Sparfloxacin Sc (10mcg)	Low risk	25/08/2016
ASS- Sensitivity Discs (Single Discs)	SD764	Ceftriaxone/ Tazobactam (80/10 mcg)	Low risk	25/08/2016
ASS- Sensitivity Discs (Single Discs)	SD765	Gemifloxacin (GEM) 5mcg	Low risk	25/08/2016
ASS- Sensitivity Discs (Single Discs)	SD767	Ceftazidime-Tazobactam (CaT) (30/10 mcg)	Low risk	25/08/2016
ASS- Sensitivity Discs (Single Discs)	SD768	Cefoperazone-tazobactam (75/10mcg)	Low risk	25/08/2016
ASS- Sensitivity Discs (Single Discs)	SD769	Cefoperazone-Sulbactam (Cfs) (75/10 mcg)	Low risk	25/08/2016
ASS- Sensitivity Discs (Single Discs)	SD770	Cefepime/Tazobactam (30/10 mcg)	Low risk	25/08/2016
ASS- Sensitivity Discs (Single Discs)	SD771	Cefpodoxime / Clavulanic acid (10/5 mcg)	Low risk	25/08/2016
ASS- Sensitivity Discs (Single Discs)	SD773	Piperacillin / Sulbactam (100/10 mcg)	Low risk	25/08/2016
ASS- Sensitivity Discs (Single Discs)	SD774	Faropenem (5 mcg)	Low risk	25/08/2016
ASS- Sensitivity Discs (Single Discs)	SD775	Ceftriaxone (30 mcg) / Tazobactam (10 mcg)	Low risk	25/08/2016
ASS- Sensitivity Discs (Single Discs)	SD776	Cefepime (80 mcg) / Tazobactam (10 mcg)	Low risk	25/08/2016
ASS- Sensitivity Discs (Single Discs)	SD777	Nadifloxacin (5 mcg)	Low risk	25/08/2016

ASS- Sensitivity Discs (Single Discs)	SD779	Cefoperazone / Sulbactam (50 / 50 mcg)	Low risk	25/08/2016
ASS- Sensitivity Discs (Single Discs)	SD780	Lomefloxacin Lo (15 mcg)	Low risk	25/08/2016
ASS- Sensitivity Discs (Single Discs)	SD781	Cefixime/Clavulanic acid Cmc (200/125 mcg)	Low risk	25/08/2016
ASS- Sensitivity Discs (Single Discs)	SD782	Cefepime Cpm (50 mcg)	Low risk	25/08/2016
ASS- Sensitivity Discs (Single Discs)	SD783	Aztreonam Ao (50 mcg)	Low risk	25/08/2016
ASS- Sensitivity Discs (Single Discs)	SD784	Amoxycillin/Sulbactam Ams (30/15 mcg)	Low risk	25/08/2016
ASS- Sensitivity Discs (Single Discs)	SD785	Imipenem/Cilastatin Ic (10/10 mcg)	Low risk	25/08/2016
ASS- Sensitivity Discs (Single Discs)	SD786	Cefixime / Clavulanic acid Cmc (5/10 mcg)	Low risk	25/08/2016
ASS- Sensitivity Discs (Single Discs)	SD787	Prulifloxacin Pr (10 mcg)	Low risk	25/08/2016
ASS- Sensitivity Discs (Single Discs)	SD788	Prulifloxacin Pr (5 mcg)	Low risk	25/08/2016
ASS- Sensitivity Discs (Single Discs)	SD789	Ceftriaxone / Sulbactam (500/250 mcg)	Low risk	25/08/2016
ASS- Sensitivity Discs (Single Discs)	SD790	Ceftriaxone / Sulbactam (1000/500 mcg)	Low risk	25/08/2016
ASS- Sensitivity Discs (Single Discs)	SD791	Piperacilin + Tazobactam (80:10 mcg)	Low risk	25/08/2016
ASS- Sensitivity Discs (Single Discs)	SD792	Pazufloxacin (PZ) (25 mcg)	Low risk	25/08/2016
ASS- Sensitivity Discs (Single Discs)	SD793	Cefditoren (10 mcg)	Low risk	25/08/2016
ASS- Sensitivity Discs (Single Discs)	SD794	Cefpodoxime/Clavulanic acid (10/6.25mcg)	Low risk	25/08/2016
ASS- Sensitivity Discs (Single Discs)	SD795	Cefipime / Amikacin (30 / 7.5 mcg)	Low risk	25/08/2016
ASS- Sensitivity Discs (Single Discs)	SD796	Cefepime / Sulbactam (30/15 mcg) CPS	Low risk	25/08/2016
ASS- Sensitivity Discs (Single Discs)	SD797	Ceftazidime / Sulbactam (30/15 mcg) CAS	Low risk	25/08/2016
ASS- Sensitivity Discs (Single Discs)	SD798	Ceftriaxone/Tobramycin (30/5.4 mcg) CTB	Low risk	25/08/2016
ASS- Sensitivity Discs (Single Discs)	SD799	Ceftriaxone/Vancomycin (30/15 mcg) CVA	Low risk	25/08/2016
ASS- Sensitivity Discs (Single Discs)	SD800	Cefpirome / Sulbactam (30/15 mcg) CRS	Low risk	25/08/2016
ASS- Sensitivity Discs (Single Discs)	SD801	Cefaperazone / Sulbactum (70 / 35 mcg) C	Low risk	25/08/2016
ASS- Sensitivity Discs (Single Discs)	SD801	Cefaperazone/Sulbactum (70/35mcg)(CSB)	Low risk	25/08/2016
ASS- Sensitivity Discs (Single Discs)	SD802	Ceftazidime Tobramycin (30+3.6 mcg) CFT	Low risk	25/08/2016
ASS- Sensitivity Discs (Single Discs)	SD803	Amoxycillin/Clavulanic acid AC 50/10 mcg	Low risk	25/08/2016
ASS- Sensitivity Discs (Single Discs)	SD804	Cefpodoxime / Clavulanic acid (24:15mcg)	Low risk	25/08/2016
ASS- Sensitivity Discs (Single Discs)	SD805	Cefixime : Ofloxacin COF 5:5 mcg	Low risk	25/08/2016
ASS- Sensitivity Discs (Single Discs)	SD806	Balofloxacin BF 5 mcg	Low risk	25/08/2016
ASS- Sensitivity Discs (Single Discs)	SD807	Tigecycline TGC 20 mcg	Low risk	25/08/2016
ASS- Sensitivity Discs (Single Discs)	SD808	Ampicillin / Cloxacillin 128/128µg Ax	Low risk	25/08/2016
ASS- Sensitivity Discs (Single Discs)	SD809	Amoxycillin/Cloxacillin 128/128µg ACX	Low risk	25/08/2016
ASS- Sensitivity Discs (Single Discs)	SD810	Gentamicin GEN 128µg	Low risk	25/08/2016
ASS- Sensitivity Discs (Single Discs)	SD811	Enrofloxacin EX 8µg	Low risk	25/08/2016
ASS- Sensitivity Discs (Single Discs)	SD812	Ciprofloxacin CIP 8µg	Low risk	25/08/2016
ASS- Sensitivity Discs (Single Discs)	SD813	Tetracyclin TE 128µg	Low risk	25/08/2016
ASS- Sensitivity Discs (Single Discs)	SD814	Chloramphenicol C 8 mcg	Low risk	25/08/2016
ASS- Sensitivity Discs (Single Discs)	SD815	Streptomycin/Penicillin SPN 128/128mcg	Low risk	25/08/2016
ASS- Sensitivity Discs (Single Discs)	SD816	Ceftazidime/Tobramycin CFT 30/10mcg	Low risk	25/08/2016
ASS- Sensitivity Discs (Single Discs)	SD816V	Ceftazidime/Tobramycin CFT (30:10)	Low risk	25/08/2016
ASS- Sensitivity Discs (Single Discs)	SD816V	Ceftazidime :Tobramycin	Low risk	25/08/2016
ASS- Sensitivity Discs (Single Discs)	SD817	Cefepime / Amikacin CPA 30/10mcg	Low risk	25/08/2016
ASS- Sensitivity Discs (Single Discs)	SD818	Balofloxacin BF 10mcg	Low risk	25/08/2016
ASS- Sensitivity Discs (Single Discs)	SD819	Oxacillin Ox 10mcg	Low risk	25/08/2016
ASS- Sensitivity Discs (Single Discs)	SD820	Cefixime	Low risk	20/12/2012
ASS- Sensitivity Discs (Single Discs)	SD821	Cefpodoxim CPD 30mcg	Low risk	25/08/2016
ASS- Sensitivity Discs (Single Discs)	SD822	Garenoxacin GRN 5 mcg	Low risk	25/08/2016
ASS- Sensitivity Discs (Single Discs)	SD823	Sitafloxacin STX 5 mcg	Low risk	25/08/2016
ASS- Sensitivity Discs (Single Discs)	SD824	Tosufloxacin TOS 5 mcg	Low risk	25/08/2016
ASS- Sensitivity Discs (Single Discs)	SD825	Biapenem BPM 10 mcg	Low risk	25/08/2016
ASS- Sensitivity Discs (Single Discs)	SD826	Cefepime Amikacin 58.8:14.6.mcg CPA	Low risk	25/08/2016
ASS- Sensitivity Discs (Single Discs)	SD827	Florfenikol FLO 30mcg	Low risk	25/08/2016
ASS- Sensitivity Discs (Single Discs)	SD828	Cefpodoxime:Levofloxacin 10:5 mcg	Low risk	25/08/2016
ASS- Sensitivity Discs (Single Discs)	SD829	Meropenem/Sulbactam MRS 10:5 mcg	Low risk	25/08/2016
ASS- Sensitivity Discs (Single Discs)	SD830V	Ceftriazone Vancomycin CVA (30:30)	Low risk	25/08/2016
ASS- Sensitivity Discs (Single Discs)	SD831	Ampicillin/Sulbactum (A/S) 20:10	Low risk	25/08/2016
ASS- Sensitivity Discs (Single Discs)	SD832	Cefixime : Azithromycin CFA 5:15 mcg	Low risk	25/08/2016
ASS- Sensitivity Discs (Single Discs)	SD833	Cefquinome CEQ 30mcg	Low risk	25/08/2016

ASS- Sensitivity Discs (Single Discs)	SD834	Ceftriaxone CTR 128 mcg	Low risk	25/08/2016
ASS- Sensitivity Discs (Single Discs)	SD835	Sulphatrimethoprim STM 128/128 mcg	Low risk	25/08/2016
ASS- Sensitivity Discs (Single Discs)	SD836	Erythromycin E 60 mcg	Low risk	25/08/2016
ASS- Sensitivity Discs (Single Discs)	SD837	Kanmycin K 1000 mcg	Low risk	25/08/2016
ASS- Sensitivity Discs (Single Discs)	SD837	Kanmycin K 1000 mcg	Low risk	20/12/2012
ASS- Sensitivity Discs (Single Discs)	SD838	Quinupristin/Dalfopristin RP 15/15 mcg	Low risk	25/08/2016
ASS- Sensitivity Discs (Single Discs)	SD839	Levofloxacin/Cefpodoxime LEC 250 : 200 mcg	Low risk	25/08/2016
ASS- Sensitivity Discs (Single Discs)	SD840	Ampicillin/Sulbactam A/S 20/12.5 mcg	Low risk	25/08/2016
ASS- Sensitivity Discs (Single Discs)	SD841	Garenoxacin GRN 1mcg	Low risk	25/08/2016
ASS- Sensitivity Discs (Single Discs)	SD842	Garenoxacin GRN 5mcg	Low risk	25/08/2016
ASS- Sensitivity Discs (Single Discs)	SD843	Mipenem (Meropenem) MIP 10 mcg	Low risk	25/08/2016
ASS- Sensitivity Discs (Single Discs)	SD844	Ranicef (Cefdinir) RNF 5 mcg	Low risk	25/08/2016
ASS- Sensitivity Discs (Single Discs)	SD845	Clavamox (Amoxycillin / Clavulanic acid)	Low risk	25/08/2016
ASS- Sensitivity Discs (Single Discs)	SD846	Ciprotab (Ciprofloxacin) CPT 5 mcg	Low risk	25/08/2016
ASS- Sensitivity Discs (Single Discs)	SD847	Ciprotab (Ciprofloxacin) CPT 10mcg	Low risk	25/08/2016
ASS- Sensitivity Discs (Single Discs)	SD848	Meropenem/Sulbactam MRS 2/200mcg	Low risk	25/08/2016
ASS- Sensitivity Discs (Single Discs)	SD849	Flucloxacillin FCO 30mcg	Low risk	25/08/2016
ASS- Sensitivity Discs (Single Discs)	SD850	Cefuroxime/Clavulanic acid CCV 30/7.5mcg	Low risk	28/04/2017
ASS- Sensitivity Discs (Single Discs)	SD851	Cefixime/Dicloxacillin CDC 5/12.5mcg	Low risk	28/04/2017
ASS- Sensitivity Discs (Single Discs)	SD852	Cefpodoxime / Clavulanic acid CCL 10/5mcg	Low risk	16/12/2017
ASS- Sensitivity Discs (Single Discs)	SD853	Nafithromycin NFT 15mcg	Low risk	30/10/2018
ASS- Sensitivity Discs (Single Discs)	SD854	Levonadifloxacin LEN 10mcg	Low risk	30/10/2018
ASS- Sensitivity Discs (Single Discs)	SD855	Dicrysticin-S DCR 50mcg	Low risk	22/04/2019
ASS- Sensitivity Discs (Single Discs)	SD856	Garenoxacin GRN 10mcg	Low risk	22/04/2019

Product group	Type/ Model / Ref number	Device Name	Risk Class	Date of CE compliance
Product Group 6: Cell Culture Media		Registration No: NL-CA002-26446		
CCM- Karyotyping Media	AL165A	HiKaryoXL™ RPMI Medium w/ L-Glutamine, FBS, PHA-M, Penicillin, Streptomycin and Sodium bicarbonate	Low risk	20/12/2012
CCM- Karyotyping Media	AL169A	HiKaryoXL™ Nutrient Mixture F10 Medium w/ L-Glutamine, FBS, PHA-M, Penicillin, Streptomycin and Sodium bicarbonate	Low risk	20/12/2012
CCM- Karyotyping Media	AL173A	HiKaryoXL™ RPMI Medium w/ L-Glutamine, FBS, Penicillin, Streptomycin and Sodium bicarbonate 1X Liquid Karyotyping Medium	Low risk	20/12/2012
CCM- Karyotyping Media	AL185A	HiKaryoXL™ Nutrient Mixture F-10 Ham Medium w/ L-Glutamine, FBS, Penicillin, Streptomycin and Sodium bicarbonate 1X Liquid Cell Culture Medium	Low risk	20/12/2012
CCM- Karyotyping Media	AL249A	HiKaryoXL™ RPMI Medium w/ L-Glutamine, FBS, PHA-P, Penicillin, Streptomycin and Sodium bicarbonate	Low risk	20/12/2012
CCM- Stem Cell Differentiation Media	AL512	HiMesoXL™ Mesenchymal Stem Cell Expansion Medium	Low risk	28/04/2017
CCM- Stem Cell Differentiation Media	AL519	HiMesoXL™ Mesenchymal Stem Cell Expansion Medium, Reduced Serum	Low risk	28/04/2017
CCM- Stem Cell Differentiation Media	AL250A	HiPer® Dulbecco's Modified Eagle Medium, High Glucose	Low risk	28/04/2017
CCM- Stem Cell Differentiation Media	AL250	HiPer® Dulbecco's Modified Eagle Medium, High Glucose	Low risk	28/04/2017
CCM- Viral Transport Media	AL296	HiViral™ Transport Medium	Low risk	22/04/2019
CCM- Viral Transport Media	AL297	HiViral™ Transport Medium	Low risk	22/04/2019
CCM- Stem Cell Differentiation Media	AL521	HiAdipoXL™ Adipocyte Differentiation Medium	Low risk	28/04/2017
CCM- Stem Cell Differentiation Media	AL522	HiOsteoXL™ Osteocyte Differentiation Medium	Low risk	28/04/2017
CCM- Stem Cell Differentiation Media	AL523	HiChondroXL™ Chondrocyte Differentiation Medium	Low risk	28/04/2017
CCM- Stem Cell Differentiation Media Supplement	TCL167	HiAdipoXL™ Adipocyte Differentiation Supplement	Low risk	28/04/2017
CCM- Stem Cell Differentiation Media	TCL168	HiOsteoXL™ Osteocyte Differentiation	Low risk	28/04/2017

Supplement		Supplement		
CCM- Stem Cell Differentiation Media Supplement	TCL169	HiChondroXL™ Chondrocyte Differentiation Supplement	Low risk	28/04/2017
CCM- Stem Cell Freezing Medium	TCL107	CryoXL™ Stem Cell Freezing Medium	Low risk	28/04/2017
CCM- Stem Cell Freezing Medium	TC450U	CryoXL™DMSO, Sterile Sterile Filtered, Cell Culture Tested, Meets USP specifications	Low risk	08/12/2017
CCM-Stem Cell Differentiation Staining Kits	CCK013	EZstain™ Adipocyte Staining Kit	Low risk	28/04/2017
CCM-Stem Cell Differentiation Staining Kits	CCK029	EZstain™ Chondrocyte Staining Kit	Low risk	28/04/2017
CCM-Stem Cell Differentiation Staining Kits	CCK030	EZstain™ Osteocyte Staining Kit	Low risk	28/04/2017
CCM-Balanced Salt Solutions	TL1006	Dulbecco's Phosphate Buffered Saline 1X w/o Phenol red, Calcium and Magnesium w/o Phenol red, Calcium and Magnesium	Low risk	16/12/2017
CCM-Balanced Salt Solutions	TL1098	Hanks' Balanced Salt Solution 1X w/ Sodium bicarbonate w/o Calcium, Magnesium and Phenol red w/o Calcium, Magnesium and Phenol red	Low risk	16/12/2017
CCM-Antibiotic Solutions	A033	Amphotericin B 250microgram per ml with 250 microgram per ml amphotericin B in normal saline	Low risk	16/12/2017
CCM-Antibiotic Solutions	A002	Antibiotic Antimycotic Solution 100X Liquid w/10,000 U Penicillin, 10mg Streptomycin and 25µg Amphotericin B per ml in 0.9% normal saline	Low risk	16/12/2017
CCM- Animal Cell Culture Medium Liquid	AL183	Dulbecco's Modified Eagle Medium (DMEM), Low glucose w/ 1gm Glucose per litre, Sodium bicarbonate and Sodium pyruvate w/o L- Glutamine and Phenol red	Low risk	16/12/2017

Product group	Type/ Model / Ref number	Device Name	Risk Class	Date of CE compliance
Product Group 7: Molecular Biology Products		Registration No: NL-CA002-26447		
MBP- DNA Isolation Kits	MB541	HiPurA™ SPP Blood DNA Isolation Kit	Low risk	20/12/2012
MBP- DNA Isolation Kits	MB504	HiPurA™ Blood Genomic DNA Miniprep Purification Kit	Low risk	20/12/2012
MBP- DNA Isolation Kits	MB506	HiPurA™ Mammalian Genomic DNA Purification Kit	Low risk	20/12/2012
MBP- DNA Isolation Kits	MB516	HiPurA™ Blood Genomic DNA Midiprep Purification Kit	Low risk	20/12/2012
MBP- DNA Isolation Kits	MB517	HiPurA™ Blood Genomic DNA Maxiprep Purification Kit	Low risk	20/12/2012
MBP- DNA Isolation Kits	MB521	HiPurA™ 96 Blood Genomic DNA Purification Kit	Low risk	20/12/2012
MBP- DNA Isolation Kits	MB522	HiPurA™ Sperm Genomic DNA Purification Kit	Low risk	20/12/2012
MBP- DNA Isolation Kits	MB525	HiPurA™ Bone DNA Purification Kit	Low risk	20/12/2012
MBP- DNA Isolation Kits	MB531	HiPurA™ Buccal DNA Purification Kit	Low risk	20/12/2012
MBP- DNA Isolation Kits	MB544	HiPurA™ Stool DNA Purification Kit	Low risk	20/12/2012
MBP- DNA Isolation Kits	MB545	HiPurA™ Mycobacterium tuberculosis DNA Purification Kit	Low risk	20/12/2012
MBP- DNA Isolation Kits	MB545D	HiPurA™ Mycobacterium tuberculosis Decontamination Kit	Low risk	28/04/2017
MBP- DNA Isolation Kits	MB554	HiPurA™ Multi-Sample DNA Purification Kit	Low risk	28/04/2017
MBP-RNA Extraction Kits	MB615	HiPurA™ Viral RNA Purification Kit	Low risk	28/04/2017
MBP-RNA Extraction Kits	MB617	HiPurA™ All Blood RNA Purification Kit	Low risk	25/08/2016
MBP- DNA Isolation Kits	MB573	HiPurA™Urine DNA Purification Kit	Low risk	04/07/2018
MBP- DNA Isolation Kits	MB575	HiPurA™ Viral DNA Purification Kit	Low risk	04/07/2018
MBP- DNA Isolation Kits	MB578	HiPurA™ QuickBone DNA Purification Kit (Column Based)	Low risk	22/04/2019
MBP- DNA Isolation Kits	MB579	HiPurA™ Fast MTB (Mycobacterium tuberculosis) Genomic DNA Purification Kit	Low risk	22/04/2019
MBP- Latex Agglutination Kits	LK01	HiClostridium™ difficile Latex Test Kit	Low risk	20/12/2012
MBP- Latex Agglutination Kits	LK02	HiSalmonella™ Latex Test Kit	Low risk	20/12/2012

MBP- Latex Agglutination Kits	LK03	HiStaph™ Latex Test Kit	Low risk	20/12/2012
MBP- Latex Agglutination Kits	LK04	HiLegionella™ Latex Test Kit	Low risk	20/12/2012
MBP- Latex Agglutination Kits	LK06	HiStrep™ Latex Test Kit	Low risk	20/12/2012
MBP- Latex Agglutination Kits	LK07	HiListeria™ Latex Test Kit	Low risk	20/12/2012
MBP- Latex Agglutination Kits	LK08	HiRotavirus™ Latex Test Kit	Low risk	20/12/2012
MBP- Latex Agglutination Kits	LK13	HiE.coli™ Latex Test Kit	Low risk	20/12/2012
MBP- PCR Kits	MBPCR001	Campylobacter Detection Kit	Low risk	20/12/2012
MBP- PCR Kits	MBPCR002	E. coli O157:H7 Detection Kit	Low risk	20/12/2012
MBP- PCR Kits	MBPCR003	Vibrio cholerae Detection Kit	Low risk	20/12/2012
MBP- PCR Kits	MBPCR004	Salmonella Detection Kit	Low risk	20/12/2012
MBP- PCR Kits	MBPCR005	Listeria Detection Kit	Low risk	20/12/2012
MBP- PCR Kits	MBPCR006	Legionella Detection Kit	Low risk	20/12/2012
MBP- PCR Kits	MBPCR008	Methicillin Resistant Staphylococcus aureus (MRSA) Detection Kit (Uniplex)	Low risk	20/12/2012
MBP- PCR Kits	MBPCR009	Mycobacterium Detection Kit	Low risk	20/12/2012
MBP- PCR Kits	MBPCR014	Beta-Thalassemia Detection Kit	Low risk	20/12/2012
MBP- PCR Kits	MBPCR014A	Beta Thalassemia Detection Kit (Uniplex)	Low risk	25/08/2016
MBP- PCR Kits	MBPCR016	Malaria Detection Kit (Multiplex)	Low risk	20/12/2012
MBP- PCR Kits	MBPCR017	Mycobacterium Detection Kit	Low risk	20/12/2012
MBP- PCR Kits	MBPCR019	Staphylococcus Cassette Chromosome (SCC) mec typing MRSA Detection Kit (Multiplex)	Low risk	12/08/2015
MBP- PCR Kits	MBPCR020	Methicillin Resistant Staphylococcus aureus (MRSA) Detection Kit (Multiplex)	Low risk	12/08/2015
MBP- PCR Kits	MBPCR022	Multi-Drug Resistant Mycobacterium Tuberculosis Detection Kit (Multiplex)	Low risk	12/08/2015
MBP- PCR Kits	MBPCR023	E. coli O157:H7 Detection Kit	Low risk	12/08/2015
MBP- PCR Kits	MBPCR024	Salmonella Detection Kit	Low risk	12/08/2015
MBP- PCR Kits	MBPCR025	Listeria monocytogenes Detection Kit	Low risk	12/08/2015
MBP- PCR Kits	MBPCR026	Campylobacter jejuni Detection Kit	Low risk	12/08/2015
MBP- PCR Kits	MBPCR027	Vibrio cholerae Detection Kit	Low risk	12/08/2015
MBP- PCR Kits	MBPCR028	Legionella pneumophila Detection Kit	Low risk	12/08/2015
MBP- PCR Kits	MBPCR029	Chronobacter sakazakii Detection Kit	Low risk	12/08/2015
MBP- PCR Kits	MBPCR030	Chronobacter sakazakii Detection Kit	Low risk	12/08/2015
MBP- PCR Kits	MBPCR032	Palm E.coli O157:H7 Detection Kit	Low risk	12/08/2015
MBP- PCR Kits	MBPCR033	Palm Salmonella Detection Kit	Low risk	12/08/2015
MBP- PCR Kits	MBPCR034	Palm Mycobacterium tuberculosis Detection Kit	Low risk	12/08/2015
MBP- PCR Kits	MBPCR035	Palm Malaria Detection Kit	Low risk	12/08/2015
MBP- PCR Kits	MBPCR036	Palm Listeria monocytogens Detection Kit	Low risk	12/08/2015
MBP- PCR Kits	MBPCR037	Palm Multi-Drug Resistant Mycobacterium Tuberculosis (MDR-TB) Detection Kit	Low risk	12/08/2015
MBP- PCR Kits	MBPCR038	Acinetobacter baumannii Detection kit	Low risk	25/08/2016
MBP- PCR Kits	MBPCR039	Diarrhoeogenic E.coli (Multiplex) Detection Kit	Low risk	25/08/2016
MBP- PCR Kits	MBPCR040	Palm Bacillus subtilis Detection Kit	Low risk	25/08/2016
MBP- PCR Kits	MBPCR041	Palm Candida albicans Detection Kit	Low risk	25/08/2016

MBP- PCR Kits	MBPCR042	Palm Pseudomonas aeruginosa Detection Kit	Low risk	25/08/2016
MBP- PCR Kits	MBPCR043	Palm Staphylococcus aureus Detection Kit	Low risk	25/08/2016
MBP- PCR Kits	MBPCR044	Klebsiella pneumoniae Detection Kit	Low risk	25/08/2016
MBP- PCR Kits	MBPCR045	Palm Generic E.coli Detection Kit	Low risk	25/08/2016
MBP- PCR Kits	MBPCR046	Palm Diarrhoeogenic E.coli Detection Kit	Low risk	25/08/2016
MBP- PCR Kits	MBPCR047	Palm Shigella Spp. Detection Kit	Low risk	25/08/2016
MBP- PCR Kits	MBPCR049	Palm Klebsiella pneumoniae Detection Kit	Low risk	25/08/2016
MBP- PCR Kits	MBPCR050	Pseudomonas aeruginosa Detection Kit	Low risk	25/08/2016
MBP- PCR Kits	MBPCR051	Generic E.coli Detection Kit	Low risk	25/08/2016
MBP- PCR Kits	MBPCR052	Candida albicans Detection Kit	Low risk	25/08/2016
MBP- PCR Kits	MBPCR053	Bacillus subtilis Detection Kit	Low risk	25/08/2016
MBP- PCR Kits	MBPCR054	Shigella spp. Detection Kit	Low risk	25/08/2016
MBP- PCR Kits	MBPCR056	Staphylococcus aureus Detection Kit	Low risk	25/08/2016
MBP- PCR Kits	MBPCR057	Klebsiella pneumoniae Detection Kit	Low risk	25/08/2016
MBP- PCR Kits	MBPCR058	Pseudomonas aeruginosa Detection Kit	Low risk	25/08/2016
MBP- PCR Kits	MBPCR059	Generic E.coli Detection Kit	Low risk	25/08/2016
MBP- PCR Kits	MBPCR060	Candida albicans Detection Kit	Low risk	25/08/2016
MBP- PCR Kits	MBPCR061	Bacillus subtilis Detection Kit	Low risk	25/08/2016
MBP- PCR Kits	MBPCR062	Shigella Spp. Detection Kit	Low risk	25/08/2016
MBP- PCR Kits	MBPCR064	Staphylococcus aureus Detection Kit	Low risk	25/08/2016
MBP- PCR Kits	MBPCR065	Acinetobacter baumannii Detection kit	Low risk	25/08/2016
MBP- PCR Kits	MBPCR066	Palm Acinetobacter baumannii Detection kit	Low risk	25/08/2016
MBP- PCR Kits	MBPCR067	Palm Clostridium sporogenes Detection kit	Low risk	25/08/2016
MBP- PCR Kits	MBPCR068	Palm Salmonella enterica subsp. enterica Detection kit	Low risk	25/08/2016
MBP- PCR Kits	MBPCR069	Palm Aspergillus brasiliensis Detection kit	Low risk	25/08/2016
MBP- PCR Kits	MBPCR073	Multi-Drug Resistant Mycobacterium tuberculosis Detection Kit (Uniplex)	Low risk	28/04/2017
MBP- PCR Kits	MBPCR074	Clostridium sporogenes Detection Kit	Low risk	28/04/2017
MBP- PCR Kits	MBPCR075	Zika Detection Kit (One Step Real time PCR)	Low risk	25/08/2016
MBP- PCR Kits	MBPCR076	Zika Detection Kit (One Step Semi quantitative PCR)	Low risk	25/08/2016
MBP- PCR Kits	MBPCR077	Zika Detection Kit (Two Step Semi quantitative PCR)	Low risk	25/08/2016
MBP- PCR Kits	MBPCR078	Palm Zika Detection Kit	Low risk	25/08/2016
MBP- PCR Kits	MBPCR079	Dengue Detection Kit (One Step Real time PCR)	Low risk	25/08/2016
MBP- PCR Kits	MBPCR080	Dengue Detection Kit (One Step Semi quantitative PCR)	Low risk	25/08/2016
MBP- PCR Kits	MBPCR081	Dengue Detection Kit (Two Step Semi quantitative PCR)	Low risk	25/08/2016
MBP- PCR Kits	MBPCR082	Palm Dengue Detection Kit (One Step RT-PCR)	Low risk	25/08/2016
MBP- PCR Kits	MBPCR083	Chikungunya Detection Kit (One Step Real time PCR)	Low risk	25/08/2016
MBP- PCR Kits	MBPCR084	Chikungunya Detection Kit (One Step Semi quantitative PCR)	Low risk	25/08/2016
MBP- PCR Kits	MBPCR085	Chikungunya Detection Kit (Two Step Semi quantitative PCR)	Low risk	25/08/2016
MBP- PCR Kits	MBPCR086	Palm Chikungunya Detection Kit	Low risk	25/08/2016
MBP- PCR Kits	MBPCR092	Malaria Detection Kit (Real-Time PCR)	Low risk	25/08/2016

MBP- PCR Kits	MBPCR099	Salmonella Detection Kit (Real-Time Probe Based PCR)	Low risk	28/04/2017
MBP- PCR Kits	MBPCR101	Generic Dengue Detection Kit (Real-Time Probe Based PCR)	Low risk	28/04/2017
MBP- PCR Kits	MBPCR102	Generic Dengue Detection Kit (One-Step Semi-Q PCR Based)	Low risk	28/04/2017
MBP- PCR Kits	MBPCR103	Generic Dengue Detection Kit (One-Step Real-Time SYBr based PCR)	Low risk	28/04/2017
MBP- PCR Kits	MBPCR104	Leptospira Detection Kit (Real Time PCR Probe Based)	Low risk	28/04/2017
MBP- PCR Kits	MBPCR108	Mycobacterium tuberculosis Detection Kit (Real Time Probe Based PCR)	Low risk	16/12/2017
MBP- PCR Kits	MBPCR111	Malaria Detection Kit (Real Time Probe Based PCR)	Low risk	16/12/2017
MBP- PCR Kits	MBPCR112	Chikungunya Detection Kit (Real Time Probe Based PCR)	Low risk	16/12/2017
MBP- PCR Kits	MBPCR130	Palm MRSA Detection Kit	Low risk	16/12/2017
MBP- PCR Kits	MBPCR131	Extended Spectrum β -Lactamase Typing Kit (Multiplex) (Real-Time Probe Based PCR)	Low risk	04/07/2018
MBP- PCR Kits	MBPCR132	Carbapenemase Resistance Typing Kit (Multiplex) (Real-Time Probe Based PCR)	Low risk	04/07/2018
MBP- PCR Kits	MBPCR133	Methicillin Resistant Staphylococcus aureus Detection Kit (Multiplex) (Real-Time Probe Based PCR)	Low risk	04/07/2018
MBP- PCR Kits	MBPCR134	Vancomycin Resistant Enterococci (VRE) Detection Kit (Multiplex)	Low risk	04/07/2018
MBP- PCR Kits	MBPCR135	Plasmodium Species Detection Kit (Multiplex) (Real-Time Probe Based PCR)	Low risk	04/07/2018
MBP- PCR Kits	MBPCR140	Legionella species Detection Kit (Real-Time Probe Based PCR)	Low risk	04/07/2018
MBP- PCR Kits	MBPCR151	Rotavirus Detection Kit (Real-Time Probe Based PCR)	Low risk	04/07/2018
MBP- PCR Kits	MBPCR152	Campylobacter species Detection Kit (Real-Time Probe Based PCR)	Low risk	04/07/2018
MBP- PCR Kits	MBPCR157	Acute Febrile Illness Panel Detection Kit (Real-Time Probe Based PCR)	Low risk	04/07/2018
MBP- PCR Kits	MBPCR159	Sepsis Pathogen Detection Kit (Multiplex) (Semi-Q PCR Based PCR Kit)	Low risk	22/04/2019
MBP- PCR Kits	MBPCR180	Salmonella enterica subsp. enterica Detection Kit	Low risk	22/04/2019
MBP- Haematology Kits	MBP001	Alkaline Hemoglobin Electrophoresis Kit	Low risk	20/12/2012
MBP- Haematology Kits	MBP003	Hi-Speed Sickle Kit (Centrifugation based detection of Hemoglobin 'S')	Low risk	20/12/2012
MBP- Haematology Kits	MBP006	Hi-Super Speed Sickle Kit (Solubility Test for detection of Hemoglobin 'S')	Low risk	20/12/2012
MBP- Haematology Kits	MBP007	Hi- Sickle Kit(Solubility Test)	Low risk	28/04/2017
MBP- Haematology Kits	MBP008	Alkaline Haemoglobin Electrophoresis Kit	Low risk	25/08/2016
MBP- Haematology Kits	MBP009	Alkaline Paper Hemoglobin Electrophoresis Kit	Low risk	16/12/2017
MBP- Haematology Kits	MBP010	Hi-Thal Kit	Low risk	16/12/2017
MBP- Density gradient Separation Medium	LS001	HiSep™ LSM 1077	Low risk	20/12/2012
MBP- DNA Isolation Kits	MBIN001	InstaNx™ Blood Genomic DNA Purification Kit	Low risk	04/07/2018
MBP- DNA Isolation Kits	MBIN003	Insta NX® Tissue Genomic DNA Purification Kit	Low risk	22/04/2019
MBP- DNA Isolation Kits	MBIN004	InstaNx™ Urine DNA Purification Kit	Low risk	04/07/2018
MBP- DNA Isolation Kits	MBIN007	InstaNx™ Stool DNA Purification Kit	Low risk	04/07/2018
MBP- DNA Isolation Kits	MBIN011	Insta NX® Cell Genomic DNA Purification Kit	Low risk	22/04/2019
MBP- DNA Isolation Kits	MBIN012	InstaNx™ Bone DNA Purification Kit	Low risk	04/07/2018
MBP-RNA Extraction Kits	MBIN013	InstaNx™ Viral RNA Purification Kit	Low risk	04/07/2018

MBP- DNA Isolation Kits	MBIN015	InstaNX™ Viral DNA Purification Kit	Low risk	04/07/2018
MBP- DNA Isolation Kits	MBIN017	Insta NX® Mycobacterium tuberculosis DNA Purification Kit	Low risk	22/04/2019
MBP- DNA Isolation Kits	MBIN019	Insta NX® Mycobacterium tuberculosis DNA Purification Kit	Low risk	22/04/2019
MBP- DNA Isolation Kits	MBIN021	Insta NX® Blood RNA Purification Kit	Low risk	22/04/2019

DECLARATION OF CONFORMITY**MICROBIOLOGY PRODUCTS**

1) Manufacturer (Name, department): **HiMedia Laboratories Pvt. Ltd.**
Address: 23 Vadhani Industrial Estate, LBS Marg, Mumbai - 86, MS, India
 and

2) European authorized representative: **CEpartner4U BV**,
Address: ESDOORNLAAN 13, 3951DB MAARN, THE NETHERLANDS;
 (on product labels printed as:
 CPartner4U, ESDOORNLAAN 13, 3951DB MAARN, THE NETHERLANDS. www.cepartner4u.eu)

3) Product(s) (groupnames /.):

Group	Group name	NL registration no.	No.
DCM&S	Dehydrated Culture Media & Supplements	NL-CA002-2013-26442	1
RPM	Ready Prepared Media Subgroups: Ready Prepared Plates, Ready Prepared Liquid & Solid Medium, Ready Prepared Slants, Ready Prepared Dual Media, HiDip Slides, HiSafe Blood Culturing System, Transport Medium w/ swabs, Viral Transport Medium w/ swabs, L.J. Medium Slants & Kits, Biochemical Kits for Mycobacteria, UTI Diagnostic Kits, Biochemical Identification Kits	NL-CA002-2013-26448	2
ESK	Epidemiological Screening Kit: Subgroups: Hi Aureus Confirmation Kits	NL-CA002-2012-24117	3
ASS	Antimicrobial Susceptibility Systems Subgroups: Sensitivity Discs-Single & Multi Discs MIC Strips: HiComb Strips, HiComb™ MIC Strip, Modified & Ezy MIC Strips, HiMIC™ Plate Kit	NL-CA002-2013-26444	4
BDA	Bacteriological Differentiation Aids Subgroups: Readymade Stains, Indicators & Reagents in liquid, Differentiation Discs & Strips, HiDtect Rapid Identification Discs	NL-CA002-2013-26445	5

type and model numbers: see appendix

4) The product(s) described above is in conformity with:

Title	Document No.
<i>In vitro</i> Diagnostic Medical Devices Directive	98/79/EC

5) Additional information (Conformity procedure, Notified Body, CE certificate, Registration nr., etc.):
 Conformity assessment procedure for CE marking: *In vitro* Diagnostic Medical Device Directive, Annex III

Mumbai, India; 2020-11-10

(Place & date of issue (yyyy-mm-dd))

 Dr. G.M. Warke, Managing Director

(name; function and signature of manufacturer)

Appendix

Date: 2020-11-10

List of devices:

Product group	Type/ Model / Ref number	Device Name	Risk Class	Date of CE compliance
Dehydrated Culture Media				
DCM	M1739	A7 Agar Base (Shepard's Differential Agar Base)	Low risk	20/12/2012
DCM	MCD884	Aeromonas Isolation HiCynth™ Medium Base	Low risk	12/08/2015
DCM	MV884	Aeromonas Isolation HiVeg™ Medium Base	Low risk	20/12/2012
DCM	M884	Aeromonas Isolation Medium Base	Low risk	20/12/2012
DCM	M1284	Aeromonas Starch DNA Agar Base	Low risk	20/12/2012
DCM	M016B	Agar Medium L (Brilliant Green, Phenol Red, Lactose Monohydrate, Sucrose Agar)	Low risk	20/12/2012
DCM	ME016	Agar Medium L (Brilliant Green, Phenol Red, Lactose Monohydrate, Sucrose Agar)	Low risk	20/12/2012
DCM	MCD618	Alkaline HiCynth™ Peptone Water	Low risk	12/08/2015
DCM	MV618	Alkaline HiVeg™ Peptone Water	Low risk	20/12/2012
DCM	M618	Alkaline Peptone Water	Low risk	20/12/2012
DCM	M1887	Alkaline Saline Peptone Water (ASPW)	Low risk	10/11/2020
DCM	M651	Amies Transport Medium w/ Charcoal	Low risk	20/12/2012
DCM	M684A	Amies Transport Medium, Liquid w/o charcoal	Low risk	25/08/2016
DCM	M228	Anaerobic Agar	Low risk	20/12/2012
DCM	M491	Anaerobic Agar (Brewer)	Low risk	20/12/2012
DCM	M230	Anaerobic Agar w/o Dextrose	Low risk	20/12/2012
DCM	M229	Anaerobic Agar w/o Dextrose and Eh Indicator	Low risk	20/12/2012
DCM	M1635	Anaerobic Basal Agar	Low risk	20/12/2012
DCM	M1636	Anaerobic Basal Broth	Low risk	20/12/2012
DCM	M1345	Anaerobic Blood Agar Base	Low risk	20/12/2012
DCM	M975A	Anaerobic Blood Agar Base	Low risk	20/12/2012
DCM	M1034	Anaerobic CNA Agar Base	Low risk	20/12/2012
DCM	MV228	Anaerobic HiVeg™ Agar	Low risk	20/12/2012
DCM	MV491	Anaerobic HiVeg™ Agar (Brewer)	Low risk	20/12/2012
DCM	MV230	Anaerobic HiVeg™ Agar w/o Dextrose	Low risk	20/12/2012
DCM	MV229	Anaerobic HiVeg™ Agar w/o Dextrose and Eh Indicator	Low risk	20/12/2012
DCM	MV909	Andrade Peptone Water w/ HiVeg™ Extract No. 1	Low risk	20/12/2012
DCM	M909	Andrade Peptone Water w/ HM Extract	Low risk	20/12/2012
DCM	M1485	Antibiotic Sulphonamide Sensitivity Test Agar (ASS Agar)	Low risk	20/12/2012
DCM	M1576	Arabinose Agar Base	Low risk	30/10/2018
DCM	M1637	Arcobacter Broth Base	Low risk	10/11/2020
DCM	M1894	Arcobacter Selective Broth Base	Low risk	10/11/2020
DCM	M672	Asparagine Broth (Coccidioidin and Histoplasmin Broth)	Low risk	20/12/2012
DCM	M158	Azide Blood Agar Base	Low risk	20/12/2012
DCM	MV158	Azide Blood Agar Base, HiVeg™	Low risk	20/12/2012

DCM	M1271	Azide Dextrose Broth w/ BCP	Low risk	10/11/2020
DCM	M220	B.A.G.G. Broth Base (Buffered Azide Glucose Glycerol Broth Base)	Low risk	20/12/2012
DCM	MV220	B.A.G.G. HiVeg™ Broth Base (Buffered Azide Glucose Glycerol HiVeg™ Broth Base)	Low risk	20/12/2012
DCM	M106	B.C.G. - Dextrose Agar (Snyder Test Agar)	Low risk	20/12/2012
DCM	MV106	B.C.G. - Dextrose HiVeg™ Agar (Snyder Test HiVeg™ Agar)	Low risk	20/12/2012
DCM	MCD462	B.Q.Vaccine HiCynth™ Medium (Thioglycollate HiCynth™ Broth)	Low risk	28/04/2017
DCM	MV462	B.Q.Vaccine HiVeg™ Medium (Thioglycollate Broth w/ HiVeg™ Extract No. 2)	Low risk	20/12/2012
DCM	M462	B.Q.Vaccine Medium (Thioglycollate Broth w/ HL Extract)	Low risk	20/12/2012
DCM	M861	B.T.B. Lactose Agar	Low risk	20/12/2012
DCM	MCD861	B.T.B. Lactose HiCynth™ Agar	Low risk	28/04/2017
DCM	MCD1081	B.T.B. Lactose HiCynth™ Agar, Modified	Low risk	28/04/2017
DCM	MV861	B.T.B. Lactose HiVeg™ Agar	Low risk	20/12/2012
DCM	MV833	Bacillus Cereus HiVeg™ Agar Base	Low risk	22/04/2019
DCM	M833	Bacillus Cereus Agar Base	Low risk	22/04/2019
DCM	M805	Bacteroides Bile Esculin Agar Base (BBE)	Low risk	20/12/2012
DCM	MV805	Bacteroides HiVeg™ Agar Base (BBE)	Low risk	20/12/2012
DCM	M043	Baird Parker Agar Base	Low risk	20/12/2012
DCM	M2093	Baird Parker Agar Base w/o Egg Yolk Emulsion	Low risk	22/04/2019
DCM	MCD043	Baird Parker HiCynth™ Agar Base	Low risk	12/08/2015
DCM	MV043	Baird Parker HiVeg™ Agar Base	Low risk	20/12/2012
DCM	M1091	Baird Staphylococcus Enrichment Broth Base	Low risk	10/11/2020
DCM	M694	Bennet's Agar	Low risk	20/12/2012
DCM	M1683	Bennet's Broth	Low risk	20/12/2012
DCM	MV694	Bennet's HiVeg™ Agar	Low risk	20/12/2012
DCM	M1888	BETA-SSA Agar (Group A Streptococci Selective Agar)	Low risk	20/12/2012
DCM	M211	BHI Agar (Special Infusion Agar)	Low risk	20/12/2012
DCM	M211A	BHI Agar w/ 1% Agar	Low risk	20/12/2012
DCM	MV211A	BHI Agar w/ 1% Agar, HiVeg™	Low risk	20/12/2012
DCM	M1069	BHI Agar w/ 3.0% Agar	Low risk	20/12/2012
DCM	MV211	BHI Agar, HiVeg™ (Special Infusion Agar, HiVeg™)	Low risk	20/12/2012
DCM	M1611	BHI Agar, Modified	Low risk	20/12/2012
DCM	M210	BHI Broth	Low risk	20/12/2012
DCM	M210I	BHI Broth	Low risk	20/12/2012
DCM	M209	BHI CC Agar	Low risk	20/12/2012
DCM	MV209	BHI CC Agar, HiVeg™	Low risk	20/12/2012
DCM	MCD211	BHI HiCynth™ Agar (Special Infusion HiCynth™ Agar)	Low risk	12/08/2015
DCM	MCD210	BHI HiCynth™ Broth	Low risk	12/08/2015
DCM	M1036	BHI w/ 0.1% Agar	Low risk	20/12/2012
DCM	M1037	BHI w/ 6.5% NaCl	Low risk	20/12/2012
DCM	MV1037	BHI w/ 6.5% NaCl, HiVeg™	Low risk	20/12/2012
DCM	M212	BHI w/ PABA	Low risk	20/12/2012
DCM	M213	BHI w/ PABA and Agar	Low risk	20/12/2012
DCM	MV213	BHI w/ PABA and Agar, HiVeg™	Low risk	20/12/2012
DCM	MV212	BHI w/ PABA, HiVeg™	Low risk	20/12/2012

DCM	MV1036	BHI with 0.1% Agar, HiVeg™	Low risk	20/12/2012
DCM	MV210	BHI, HiVeg™	Low risk	20/12/2012
DCM	M217	Bi.G.G.Y. Agar (Nickerson Medium)	Low risk	20/12/2012
DCM	MCD217	Bi.G.G.Y. HiCynth™ Agar (Nickerson HiCynth™ Agar)	Low risk	25/08/2016
DCM	M1396	Bifidobacterium Agar	Low risk	10/11/2020
DCM	M1960R	Bifidobacterium Agar (HiCrome™)	Low risk	25/08/2016
DCM	M1396R	Bifidobacterium Agar (Modified, Selective Medium, Kit)	Low risk	04/07/2018
DCM	M1858	Bifidobacterium Agar, Modified	Low risk	20/12/2012
DCM	M1395	Bifidobacterium Broth	Low risk	10/11/2020
DCM	M071	Bile Broth Base	Low risk	20/12/2012
DCM	MV071	Bile Broth Base, HiVeg™	Low risk	20/12/2012
DCM	M972A	Bile Esculin Agar, Modified	Low risk	22/04/2019
DCM	M493	Bile Esculin Azide Agar	Low risk	10/11/2020
DCM	MV493	Bile Esculin Azide HiVeg™ Agar	Low risk	10/11/2020
DCM	MCD493	Bile Esculin Azide HiCynth™ Agar	Low risk	10/11/2020
DCM	M481	Bile Peptone Transport Medium	Low risk	20/12/2012
DCM	M739	Bile Salt Agar	Low risk	20/12/2012
DCM	MCD027	Bismuth Sulphite HiCynth™ Agar	Low risk	12/08/2015
DCM	M027	Bismuth Sulphite Agar	Low risk	20/12/2012
DCM	M027L	Bismuth Sulphite Agar	Low risk	04/07/2018
DCM	MU027	Bismuth Sulphite Agar Medium	Low risk	20/12/2012
DCM	M1004	Bismuth Sulphite Agar, Modified	Low risk	20/12/2012
DCM	MV027	Bismuth Sulphite HiVeg™ Agar	Low risk	20/12/2012
DCM	MV1004	Bismuth Sulphite HiVeg™ Agar, Modified	Low risk	20/12/2012
DCM	M073	Blood Agar Base (Infusion Agar)	Low risk	20/12/2012
DCM	M834	Blood Agar Base No. 2	Low risk	20/12/2012
DCM	M834A	Blood Agar Base No. 2 w/ 1.2% Agar	Low risk	20/12/2012
DCM	MV834A	Blood Agar Base No. 2 w/ 1.2% Agar, HiVeg™	Low risk	20/12/2012
DCM	MV834	Blood Agar Base No. 2, HiVeg™	Low risk	20/12/2012
DCM	M834Z	Blood Agar Base No.2	Low risk	28/04/2017
DCM	M089	Blood Agar Base w/ Low pH	Low risk	20/12/2012
DCM	MV089	Blood Agar Base w/ Low pH, HiVeg™	Low risk	20/12/2012
DCM	M1904	Blood Agar Base w/ Nalidixic Acid	Low risk	20/12/2012
DCM	MV073	Blood Agar Base, HiVeg™ (Infusion Agar, HiVeg™)	Low risk	20/12/2012
DCM	M1989	Blood Agar Base, Modified	Low risk	20/12/2012
DCM	M1318	Blood Free Campylobacter Broth Base	Low risk	20/12/2012
DCM	MCD073	Blood HiCynth™ Agar Base (Infusion HiCynth™ Agar Base)	Low risk	25/08/2016
DCM	MCD834	Blood HiCynth™ Agar Base No.2	Low risk	25/08/2016
DCM	MCD089	Blood HiCynth™ Agar Base w/ Low pH	Low risk	25/08/2016
DCM	M175	Bordet Gengou Agar Base	Low risk	20/12/2012
DCM	M175A	Bordet Gengou Agar Base w/ 1.6% Agar	Low risk	20/12/2012
DCM	M175SB	Bordet Gengou Agar Base, Modified	Low risk	16/12/2017
DCM	M2012	Bordet Gengou Broth	Low risk	25/08/2016
DCM	MV175	Bordet Gengou HiVeg™ Agar Base	Low risk	20/12/2012
DCM	MV175A	Bordet Gengou HiVeg™ Agar Base w/ 1.6% Agar	Low risk	20/12/2012

DCM	M1020	BPL Agar	Low risk	20/12/2012
DCM	MV1020	BPL HiVeg™ Agar	Low risk	20/12/2012
DCM	M016A	Brilliant Green Agar Base w/ 1.2% Agar	Low risk	20/12/2012
DCM	M971	Brilliant Green Agar Base w/ Phosphates	Low risk	20/12/2012
DCM	M016	Brilliant Green Agar Base, Modified	Low risk	20/12/2012
DCM	MCD016	Brilliant Green Agar HiCynth™ Base, Modified	Low risk	12/08/2015
DCM	MU016	Brilliant Green Agar Medium	Low risk	20/12/2012
DCM	MM016	Brilliant Green Agar Medium 16	Low risk	20/12/2012
DCM	MV016A	Brilliant Green HiVeg™ Agar Base w/ 1.2% Agar	Low risk	20/12/2012
DCM	MV971	Brilliant Green HiVeg™ Agar Base w/ Phosphates	Low risk	20/12/2012
DCM	MV016	Brilliant Green HiVeg™ Agar Base, Modified	Low risk	20/12/2012
DCM	M016B	Brilliant Green, Phenol Red, Lactose Monohydrate, Sucrose Agar (Agar Medium L)	Low risk	20/12/2012
DCM	ME016	Brilliant Green, Phenol Red, Lactose Monohydrate, Sucrose Agar (Agar Medium L)	Low risk	20/12/2012
DCM	M1822	Bromo Thymol Lactose Blue Agar	Low risk	16/12/2017
DCM	M074	Brucella Agar Base	Low risk	20/12/2012
DCM	M1638	Brucella Agar Base w/ 1.0% Dextrose	Low risk	20/12/2012
DCM	M1039	Brucella Agar Base w/ Hemin and Vitamin K	Low risk	20/12/2012
DCM	M074A	Brucella Agar Base, Modified	Low risk	20/12/2012
DCM	M5392	Brucella Broth Base	Low risk	30/10/2018
DCM	M348	Brucella Broth Base	Low risk	20/12/2012
DCM	MV074	Brucella HiVeg™ Agar Base	Low risk	20/12/2012
DCM	MV074A	Brucella HiVeg™ Agar Base, Modified	Low risk	20/12/2012
DCM	MV348	Brucella HiVeg™ Broth Base	Low risk	20/12/2012
DCM	M822	Brucella Selective Medium Base	Low risk	20/12/2012
DCM	M1890	BSIBG Agar (Aeromonas Selective Agar)	Low risk	10/11/2020
DCM	M1668	BSK - H Medium Base	Low risk	20/12/2012
DCM	M1668B	BSK - H Medium Base w/o BSA	Low risk	28/04/2017
DCM	M813	Buffered Charcoal Yeast Extract Agar Base	Low risk	20/12/2012
DCM	M813I	Buffered Charcoal Yeast Extract Agar Medium (BCYE Medium)	Low risk	20/12/2012
DCM	MCD813	Buffered Charcoal Yeast Extract HiCynth™ Medium	Low risk	25/08/2016
DCM	M204	Buffered Glycerol Saline Base	Low risk	20/12/2012
DCM	MCD1275	Buffered HiCynth™ Peptone Water w/ NaCl	Low risk	12/08/2015
DCM	MV614	Buffered HiVeg™ Peptone Water	Low risk	22/04/2019
DCM	MV1275	Buffered HiVeg™ Peptone Water w/NaCl	Low risk	20/12/2012
DCM	M614	Buffered Peptone Water	Low risk	22/04/2019
DCM	M1275	Buffered Peptone Water w/ NaCl	Low risk	20/12/2012
DCM	M1851	Buffered Peptone Water w/ Pyruvate	Low risk	20/12/2012
DCM	MH1275	Buffered Sodium Chloride-Peptone Solution pH 7.0	Low risk	22/04/2019
DCM	M1640	Burkholderia Cepacia Agar Base	Low risk	20/12/2012
DCM	MCD1640	Burkholderia cepacia HiCynth™ Agar Base	Low risk	25/08/2016
DCM	M2089	Burkholderia Cepacia Selectie Agar	Low risk	10/11/2020
DCM	M2089	Burkholderia Cepacia Selective Agar	Low risk	30/10/2018
DCM	MU2089	Burkholderia Cepacia Selective Agar (BCSA)	Low risk	10/11/2020
DCM	M470	BYE Agar	Low risk	20/12/2012

DCM	MV470	BYE HiVeg™ Agar	Low risk	20/12/2012
DCM	M911	C. botulinum Isolation Agar Base	Low risk	20/12/2012
DCM	MV911	C. botulinum Isolation HiVeg™ Agar Base	Low risk	20/12/2012
DCM	M1146	C.L.E.D. Agar Base w/o Indicator	Low risk	20/12/2012
DCM	M792	C.L.E.D. Agar w/ Bromo Thymol Blue	Low risk	20/12/2012
DCM	MCD792	C.L.E.D. HiCynth™ Agar w/BTB	Low risk	12/08/2015
DCM	MCD352	C.L.E.D. HiCynth™ Agar w/Andrade Indicator	Low risk	12/08/2015
DCM	MV1146	C.L.E.D. HiVeg™ Agar Base w/o Indicator	Low risk	20/12/2012
DCM	MV352	C.L.E.D. HiVeg™ Agar w/ Andrade Indicator	Low risk	20/12/2012
DCM	MV792	C.L.E.D. HiVeg™ Agar w/ Bromo Thymol Blue	Low risk	20/12/2012
DCM	M352	C.L.E.D. Agar w/ Andrade Indicator	Low risk	20/12/2012
DCM	M352M	C.L.E.D. Agar w/ Andrades Indicator	Low risk	22/04/2019
DCM	M352A	C.L.E.D. Agar w/o Lactose & w/ Andrades Indicator	Low risk	22/04/2019
DCM	M563	Caffeic Acid Ferric Citrate Test Agar (CAFC Medium)	Low risk	20/12/2012
DCM	M893	CAL Agar (Cellobiose Arginine Lysine Agar)	Low risk	20/12/2012
DCM	M894	CAL Broth (Cellobiose Arginine Lysine Broth)	Low risk	20/12/2012
DCM	MV893	CAL HiVeg™ Agar (Cellobiose Arginine Lysine HiVeg™ Agar)	Low risk	20/12/2012
DCM	MV894	CAL HiVeg™ Broth (Cellobiose Arginine Lysine HiVeg™ Broth)	Low risk	20/12/2012
DCM	MV908	Campylo Thioglycollate HiVeg™ Medium Base	Low risk	20/12/2012
DCM	M908	Campylo Thioglycollate Medium Base	Low risk	20/12/2012
DCM	M994	Campylobacter Agar Base	Low risk	20/12/2012
DCM	M1267	Campylobacter Cefex Agar Base	Low risk	20/12/2012
DCM	M899	Campylobacter Enrichment Broth Base (Preston Enrichment Broth Base)	Low risk	20/12/2012
DCM	MV899	Campylobacter Enrichment HiVeg™ Broth Base (Preston Enrichment HiVeg™ Broth Base)	Low risk	20/12/2012
DCM	MV994	Campylobacter HiVeg™ Agar Base	Low risk	20/12/2012
DCM	M1240	Campylobacter Nitrate Broth	Low risk	20/12/2012
DCM	MV1240	Campylobacter Nitrate HiVeg™ Broth	Low risk	20/12/2012
DCM	M1602	Candida Agar	Low risk	20/12/2012
DCM	M355	Candida BCG Agar Base	Low risk	20/12/2012
DCM	MV355	Candida BCG HiVeg™ Agar Base	Low risk	20/12/2012
DCM	MV104	Candida HiVeg™ Medium	Low risk	20/12/2012
DCM	M104	Candida Medium	Low risk	20/12/2012
DCM	M202	Cary - Blair Medium Base (Transport Medium w/o Charcoal)	Low risk	20/12/2012
DCM	M202A	Cary Blair Medium, Liquid w/o charcoal	Low risk	25/08/2016
DCM	M794	Casitose Agar w/ 2.5% Agar	Low risk	20/12/2012
DCM	M200	Casitose Broth	Low risk	20/12/2012
DCM	M910	Casitose Yeast Extract Broth (CAYE)	Low risk	20/12/2012
DCM	MV910	Casitose Yeast Extract HiVeg™ Broth (CAYE)	Low risk	20/12/2012
DCM	M201	Casman Agar Base	Low risk	20/12/2012
DCM	M766	Casman Broth Base	Low risk	20/12/2012
DCM	MV201	Casman HiVeg™ Agar Base	Low risk	20/12/2012
DCM	MV766	Casman HiVeg™ Broth Base	Low risk	20/12/2012
DCM	MH024	Cetrimide Agar	Low risk	22/04/2019
DCM	M024	Cetrimide Agar Base	Low risk	20/12/2012

DCM	M1742	Cetrimide Agar Base (w 1.3% Agar)	Low risk	20/12/2012
DCM	M862	Cetrimide Broth	Low risk	20/12/2012
DCM	MCD024	Cetrimide HiCynth™ Agar Base	Low risk	12/08/2015
DCM	MV024	Cetrimide HiVeg™ Agar Base	Low risk	20/12/2012
DCM	MV862	Cetrimide HiVeg™ Broth	Low risk	20/12/2012
DCM	M344	Charcoal Agar Base	Low risk	10/11/2020
DCM	MV344	Charcoal Agar Base, HiVeg™	Low risk	10/11/2020
DCM	M1053	Charcoal Agar Base with Niacin	Low risk	16/12/2017
DCM	M646	Charcoal Blood Agar Base	Low risk	10/11/2020
DCM	MV646	Charcoal Blood Agar Base, HiVeg™	Low risk	10/11/2020
DCM	M103	Chocolate Agar Base	Low risk	20/12/2012
DCM	MV103	Chocolate HiVeg™ Agar Base	Low risk	20/12/2012
DCM	M1548	Chocolate No. 2 Agar Base	Low risk	20/12/2012
DCM	MV1548	Chocolate No. 2 HiVeg™ Agar Base	Low risk	20/12/2012
DCM	MV558	Cholera HiVeg™ Medium Base	Low risk	20/12/2012
DCM	M558	Cholera Medium Base	Low risk	20/12/2012
DCM	M143	Christensen Citrate Agar	Low risk	20/12/2012
DCM	M1820	Chrysoidin Agar with MUG	Low risk	16/12/2017
DCM	M497	Clostridial Agar	Low risk	20/12/2012
DCM	MV497	Clostridial HiVeg™ Agar	Low risk	20/12/2012
DCM	M836	Clostridium Difficile Agar Base	Low risk	20/12/2012
DCM	MV836	Clostridium Difficile HiVeg™ Agar Base	Low risk	20/12/2012
DCM	M1976	Clostridium difficile Mannitol Taurocholate Broth base (CCMB - TAL Broth)	Low risk	20/12/2012
DCM	M272	Coagulase Mannitol Agar Base	Low risk	20/12/2012
DCM	M277	Coagulase Mannitol Broth Base	Low risk	20/12/2012
DCM	MV272	Coagulase Mannitol HiVeg™ Agar Base	Low risk	20/12/2012
DCM	MV277	Coagulase Mannitol HiVeg™ Broth Base	Low risk	20/12/2012
DCM	M1826	Coliform Broth w/SLS	Low risk	22/04/2019
DCM	M1826	Coliform Broth w/SLS	Low risk	22/04/2019
DCM	MV1826	Coliform HiVeg Broth w/ SLS	Low risk	22/04/2019
DCM	MH144	Columbia Agar	Low risk	22/04/2019
DCM	M144M	Columbia Agar	Low risk	22/04/2019
DCM	M144PM	Columbia Blood Agar Base	Low risk	22/04/2019
DCM	M144R	Columbia Blood Agar Base	Low risk	25/08/2016
DCM	M144	Columbia Blood Agar Base	Low risk	20/12/2012
DCM	M144A	Columbia Blood Agar Base w/ 1% Agar	Low risk	20/12/2012
DCM	MV144A	Columbia Blood Agar Base w/ 1% Agar, HiVeg™	Low risk	20/12/2012
DCM	M1133	Columbia Blood Agar Base w/ Hemin	Low risk	20/12/2012
DCM	MV144	Columbia Blood Agar Base, HiVeg™	Low risk	20/12/2012
DCM	MCD144	Columbia Blood HiCynth™ Agar Base	Low risk	12/08/2015
DCM	MCD144A	Columbia Blood HiCynth™ Agar Base w/1% Agar	Low risk	12/08/2015
DCM	M145	Columbia Broth Base	Low risk	20/12/2012
DCM	MV145	Columbia Broth Base, HiVeg™	Low risk	20/12/2012
DCM	M560	Columbia C.N.A. Agar Base	Low risk	20/12/2012
DCM	M560A	Columbia C.N.A. Agar Base w/ 1% Agar	Low risk	20/12/2012

DCM	MV560	Columbia C.N.A. HiVeg™ Agar Base	Low risk	20/12/2012
DCM	MV560A	Columbia C.N.A. HiVeg™ Agar Base w/ 1% Agar	Low risk	20/12/2012
DCM	MCD145	Columbia HiCynth™ Broth	Low risk	12/08/2015
DCM	M2103	Congo Red Magnesium Oxalate (CR-MOX) Agar	Low risk	22/04/2019
DCM	M730	Conn's Agar	Low risk	20/12/2012
DCM	M149	Cooked M Medium (R.C. Medium)	Low risk	16/12/2017
DCM	M1040	Cooked M Medium w/ Glucose, Hemin & Vitamin K	Low risk	16/12/2017
DCM	MV731	Corn Meal HiVeg™ Peptone Yeast Agar	Low risk	20/12/2012
DCM	M731	Corn Meal Peptone Yeast Agar	Low risk	20/12/2012
DCM	M897	Crystal Violet Lactose Agar	Low risk	10/11/2020
DCM	MV897	Crystal Violet Lactose HiVeg™ Agar	Low risk	10/11/2020
DCM	M1892	CTAS Agar Base (Carnobacterium Selective Agar Base)	Low risk	20/12/2012
DCM	M172	Cystine H Agar Base	Low risk	20/12/2012
DCM	MV172	Cystine HiVeg™ Agar Base	Low risk	20/12/2012
DCM	M881	Cystine Tellurite Agar Base	Low risk	20/12/2012
DCM	M160	D.C.L.S. Agar	Low risk	20/12/2012
DCM	M178	D.C.L.S. Agar, Hajna	Low risk	20/12/2012
DCM	MV160	D.C.L.S. HiVeg™ Agar	Low risk	20/12/2012
DCM	MV178	D.C.L.S. HiVeg™ Agar	Low risk	20/12/2012
DCM	M188	D.T.M. Agar Base (Dermatophyte Test Agar Base)	Low risk	20/12/2012
DCM	M501	Decarboxylase Agar Base	Low risk	20/12/2012
DCM	M393	Decarboxylase Broth Base, Moeller (Moeller Decarboxylase Broth Base)	Low risk	20/12/2012
DCM	MV501	Decarboxylase HiVeg™ Agar Base	Low risk	20/12/2012
DCM	MV393	Decarboxylase HiVeg™ Broth Base, Moeller (Moeller Decarboxylase HiVeg™ Broth Base)	Low risk	20/12/2012
DCM	M030	Deoxycholate Agar	Low risk	20/12/2012
DCM	MV030	Deoxycholate Agar, HiVeg™	Low risk	20/12/2012
DCM	M065	Deoxycholate Citrate Agar	Low risk	20/12/2012
DCM	M1639	Deoxycholate Citrate Agar w/1.5% Agar	Low risk	20/12/2012
DCM	M222	Deoxycholate Citrate Agar w/o Sucrose	Low risk	20/12/2012
DCM	MV065	Deoxycholate Citrate Agar, HiVeg™	Low risk	20/12/2012
DCM	MCD065	Deoxycholate Citrate HiCynth™ Agar	Low risk	12/08/2015
DCM	M084	Dextrose Agar	Low risk	20/12/2012
DCM	M286	Dextrose Agar Base, Emmons (Sabouraud Dextrose Agar Base, Modified)	Low risk	20/12/2012
DCM	MV084	Dextrose HiVeg™ Agar	Low risk	20/12/2012
DCM	MV286	Dextrose HiVeg™ Agar Base, Emmons (Sabouraud Dextrose HiVeg™ AgarBase, Modified)	Low risk	20/12/2012
DCM	M734	Dextrose Proteose Peptone Agar Base	Low risk	20/12/2012
DCM	MV734	Dextrose Proteose Peptone HiVeg™ Agar Base	Low risk	20/12/2012
DCM	M502	Diagnostic Sensitivity Test Agar (D.S.T. Agar)	Low risk	20/12/2012
DCM	M111	Diagnostic Stuart's Urea Broth Base (Urea Broth Base)	Low risk	20/12/2012
DCM	MV191	Diagnostic Thioglycollate HiVeg™ Medium (Thioglycollate HiVeg™ Medium w/o Indicator)	Low risk	20/12/2012
DCM	M191	Diagnostic Thioglycollate Medium (Thioglycollate Medium w/o Indicator)	Low risk	20/12/2012
DCM	M1129	Dichloran Glycerol Medium Base	Low risk	22/04/2019
DCM	M1049	Differential Agar for Group D Streptococci	Low risk	10/11/2020

DCM	M814	Differential Buffered Charcoal Yeast Extract Agar Base	Low risk	20/12/2012
DCM	M1603	Differential Reinforced Clostridial Agar	Low risk	10/11/2020
DCM	M915	Dihydrolase Broth Base	Low risk	20/12/2012
DCM	MV915	Dihydrolase HiVeg™ Broth Base	Low risk	20/12/2012
DCM	MM1276	Dilute Sautans Medium (Twin Pack)	Low risk	20/12/2012
DCM	M882	Diphtheria Virulence Agar Base	Low risk	25/08/2016
DCM	M882R	Diphtheria Virulence Agar Base Modified	Low risk	25/08/2016
DCM	MV882	Diphtheria Virulence HiVeg™ Agar Base	Low risk	25/08/2016
DCM	M1984	Dixon's Agar	Low risk	20/12/2012
DCM	M1419	DNase Test Agar w/ Methyl Green	Low risk	10/11/2020
DCM	M057	Double Sugar Agar, Russell (Russell Double Sugar Agar)	Low risk	20/12/2012
DCM	MV057	Double Sugar HiVeg™ Agar (Russell Double Sugar HiVeg™ Agar)	Low risk	20/12/2012
DCM	M916	Doyle's Enrichment Broth Base	Low risk	20/12/2012
DCM	MV916	Doyle's Enrichment HiVeg™ Broth Base	Low risk	20/12/2012
DCM	M1378	Drigalski Lactose Agar, Modified	Low risk	20/12/2012
DCM	M1761	Drigalski Lactose Selective Agar	Low risk	20/12/2012
DCM	M659	Drigalski Litmus Lactose Agar	Low risk	20/12/2012
DCM	MV659	Drigalski Litmus Lactose HiVeg™ Agar	Low risk	20/12/2012
DCM	M5349	DTP Medium	Low risk	30/10/2018
DCM	M067	Dubos Broth Base	Low risk	20/12/2012
DCM	MV067	Dubos HiVeg™ Broth Base	Low risk	20/12/2012
DCM	M179	Dubos Oleic Agar Base	Low risk	20/12/2012
DCM	M839	Dubos Oleic Broth Base	Low risk	20/12/2012
DCM	MV179	Dubos Oleic HiVeg™ Agar Base	Low risk	20/12/2012
DCM	MV839	Dubos Oleic HiVeg™ Broth Base	Low risk	20/12/2012
DCM	M1536	Dulcitol Selenite Broth (Selenite-F Broth w/ Dulcitol) (Twin Pack)	Low risk	20/12/2012
DCM	M854	E.T. Medium	Low risk	20/12/2012
DCM	M1768	EC Blue Broth	Low risk	20/12/2012
DCM	MV1768	EC Blue HiVeg™ Broth	Low risk	20/12/2012
DCM	M127	EC Broth	Low risk	20/12/2012
DCM	M127I	EC Broth	Low risk	20/12/2012
DCM	MV127	EC HiVeg™ Broth	Low risk	20/12/2012
DCM	M748	Edward's Medium Base, Modified	Low risk	20/12/2012
DCM	MV748	Edward's Medium HiVeg™ Base, Modified	Low risk	20/12/2012
DCM	M294	Edwards and Bruner Semisolid Medium	Low risk	20/12/2012
DCM	M808	Egg Yolk Agar Base	Low risk	20/12/2012
DCM	MV808	Egg Yolk Agar Base, HiVeg™	Low risk	20/12/2012
DCM	M1043	Egg Yolk Agar Base, Modified	Low risk	20/12/2012
DCM	M086	Eijkman Lactose Broth	Low risk	20/12/2012
DCM	MV086	Eijkman Lactose HiVeg™ Broth	Low risk	20/12/2012
DCM	M368	Elliker Broth (Lactobacilli Broth)	Low risk	10/11/2020
DCM	MV368	Elliker HiVeg™ Broth (Lactobacilli HiVeg™ Broth)	Low risk	10/11/2020
DCM	M317	EMB Agar	Low risk	20/12/2012
DCM	M301	EMB Agar Base	Low risk	20/12/2012
DCM	M022	EMB Agar, Levine	Low risk	20/12/2012

DCM	M022S	EMB Agar, Levine	Low risk	20/12/2012
DCM	M503	EMB Broth	Low risk	20/12/2012
DCM	MV317	EMB HiVeg™ Agar	Low risk	20/12/2012
DCM	MV022	EMB HiVeg™ Agar, Levine	Low risk	20/12/2012
DCM	MV503	EMB HiVeg™ Broth	Low risk	20/12/2012
DCM	M325	Emerson Agar	Low risk	20/12/2012
DCM	MV325	Emerson HiVeg™ Agar	Low risk	20/12/2012
DCM	M773	Emerson YSS Agar	Low risk	20/12/2012
DCM	M029	Endo Agar	Low risk	20/12/2012
DCM	M1077	Endo Agar Base	Low risk	20/12/2012
DCM	M1258	Endo Agar w/ NaCl	Low risk	20/12/2012
DCM	M1075	Endo Agar, Modified	Low risk	20/12/2012
DCM	M029R	Endo Agar, Special	Low risk	25/08/2016
DCM	MCD029	Endo HiCynth™ Agar	Low risk	12/08/2015
DCM	MV029	Endo HiVeg™ Agar	Low risk	20/12/2012
DCM	MV1077	Endo HiVeg™ Agar Base	Low risk	20/12/2012
DCM	MV1258	Endo HiVeg™ Agar w/ NaCl	Low risk	20/12/2012
DCM	MV1075	Endo HiVeg™ Agar, Modified	Low risk	20/12/2012
DCM	M738	Enriched Thioglycollate Broth	Low risk	20/12/2012
DCM	MV738	Enriched Thioglycollate HiVeg™ Broth	Low risk	20/12/2012
DCM	MV077	Entamoeba HiVeg™ Medium	Low risk	20/12/2012
DCM	M077	Entamoeba Medium	Low risk	20/12/2012
DCM	M1662	Enteric Fermentation Base	Low risk	20/12/2012
DCM	MH287	Enterobacteria Enrichment Broth, Mossel	Low risk	22/04/2019
DCM	M426	Ethyl Violet Azide Broth (E.V.A. Broth)	Low risk	20/12/2012
DCM	M426S	Ethyl Violet Azide Broth (E.V.A. Broth)	Low risk	20/12/2012
DCM	M1397	Ethyl Violet Azide Dextrose Agar	Low risk	20/12/2012
DCM	MV426	Ethyl Violet Azide HiVeg™ Broth (E.V.A. HiVeg™ Broth)	Low risk	20/12/2012
DCM	M428	Eugonic Agar	Low risk	20/12/2012
DCM	M429	Eugonic Broth	Low risk	20/12/2012
DCM	MV428	Eugonic HiVeg™ Agar	Low risk	20/12/2012
DCM	MV429	Eugonic HiVeg™ Broth	Low risk	20/12/2012
DCM	M1517	Eugonic LT 100 Broth Base w/o Tween 80	Low risk	20/12/2012
DCM	M811	Feeley Gorman Agar (F.G. Agar)	Low risk	20/12/2012
DCM	M812	Feeley Gorman Broth (F.G. Broth)	Low risk	20/12/2012
DCM	MV811	Feeley Gorman HiVeg™ Agar (F.G. HiVeg™ Agar)	Low risk	20/12/2012
DCM	MV812	Feeley Gorman HiVeg™ Broth (F.G. HiVeg™ Broth)	Low risk	20/12/2012
DCM	M827	Fermentation Medium for Staphylococcus and Micrococcus	Low risk	20/12/2012
DCM	MV919	Fermentation HiVeg™ Medium Base for C. perfringens	Low risk	20/12/2012
DCM	MV825	Fermentation HiVeg™ Medium for Neisseriae	Low risk	20/12/2012
DCM	MV827	Fermentation HiVeg™ Medium for Staphylococcus and Micrococcus	Low risk	20/12/2012
DCM	M919	Fermentation Medium Base for C. perfringens	Low risk	20/12/2012
DCM	M825	Fermentation Medium for Neisseriae	Low risk	20/12/2012
DCM	M1028	Field's Tryptic Digest Broth (Tryptic Digest Broth)	Low risk	20/12/2012
DCM	MV1028	Field's Tryptic digest Broth, HiVeg™ (Tryptic Digest Broth,	Low risk	20/12/2012

		HiVeg™)		
DCM	MV239	Fletcher Leptospira HiVeg™ Medium Base (Leptospira HiVeg™ MediumBase, Fletcher)	Low risk	20/12/2012
DCM	M239	Fletcher Leptospira Medium Base (Leptospira Medium Base, Fletcher)	Low risk	20/12/2012
DCM	M1209	Fluconazole Testing Medium (Twin Pack)	Low risk	20/12/2012
DCM	MV013	Fluid Sabouraud HiVeg™ Medium (Sabouraud Medium, Fluid, HiVeg™)	Low risk	20/12/2012
DCM	M013	Fluid Sabouraud Medium (Sabouraud Medium, Fluid)	Low risk	20/12/2012
DCM	M1533I	Fluid Selenite Cystine Broth (Twin Pack)	Low risk	20/12/2012
DCM	MV025	Fluid Selenite Cystine HiVeg™ Medium (Selenite Cystine HiVeg™ Broth) (Twin Pack)	Low risk	20/12/2012
DCM	M025	Fluid Selenite Cystine Medium (Selenite Cystine Broth) (Twin Pack)	Low risk	20/12/2012
DCM	MM025	Fluid Selenite Cystine Medium (Twin Pack)	Low risk	20/12/2012
DCM	MU025	Fluid Selenite Cystine Medium (Twin Pack)	Low risk	20/12/2012
DCM	MCD032	Fluid Tetrathionate HiCynth™ Medium w/o Iodine and BG	Low risk	25/08/2016
DCM	MV032	Fluid Tetrathionate HiVeg™ Medium w/o Iodine and BG (Tetrathionate HiVeg™ Broth Base w/o Iodine & BG)	Low risk	20/12/2012
DCM	M032	Fluid Tetrathionate Medium w/o Iodine and BG (Tetrathionate Broth Base w/o Iodine and BG)	Low risk	20/12/2012
DCM	MV009	Fluid Thioglycollate HiVeg™ Medium	Low risk	22/04/2019
DCM	M009	Fluid Thioglycollate medium (Thioglycollate medium Fluid)	Low risk	22/04/2019
DCM	M543	Folic Acid Casei Medium	Low risk	20/12/2012
DCM	M2014	Folic Acid Casei Medium, Modified	Low risk	25/08/2016
DCM	M1050	Frey Mycoplasma Broth Base	Low risk	20/12/2012
DCM	M475	Fungobiotic Agar (Mycobio Agar)	Low risk	10/11/2020
DCM	M476	Garrod Actinomyces Medium	Low risk	10/11/2020
DCM	M1073	GBS Medium Base	Low risk	28/04/2017
DCM	M434	GC Agar Base	Low risk	25/08/2016
DCM	MV434	GC HiVeg™ Agar Base	Low risk	04/07/2018
DCM	M5397	Gifu Anaerobic Broth w/o starch & dextrose	Low risk	22/04/2019
DCM	M2079	Gifu Anaerobic Broth, Modified (GAM)	Low risk	04/07/2018
DCM	M1746	Glucose Agar	Low risk	10/11/2020
DCM	M435	Glucose Citrate Broth Base	Low risk	20/12/2012
DCM	M433	Glucose Cysteine Agar Base w/ Thiamine	Low risk	20/12/2012
DCM	MV433	Glucose Cysteine HiVeg™ Agar Base w/ Thiamine	Low risk	20/12/2012
DCM	M070	Glucose Phosphate Broth (Buffered Glucose Broth)	Low risk	20/12/2012
DCM	MV070	Glucose Phosphate HiVeg™ Broth (Buffered Glucose HiVeg™ Broth)	Low risk	20/12/2012
DCM	M621	Glucose Salt Teepol Broth (Twin Pack)	Low risk	20/12/2012
DCM	MV621	Glucose Salt Teepol HiVeg™ Broth (Twin Pack)	Low risk	20/12/2012
DCM	M1935	Glycerol Mannitol Acetamide Cetrimide Agar	Low risk	20/12/2012
DCM	M242	GN Broth, Hajna	Low risk	20/12/2012
DCM	MV242	GN HiVeg™ Broth	Low risk	20/12/2012
DCM	M1888	Group A Streptococci Selective Agar (BETA-SSA Agar)	Low risk	20/12/2012
DCM	M1607	Gum Listeria Medium	Low risk	20/12/2012
DCM	M243	H Broth	Low risk	20/12/2012
DCM	MV116	H.S. Vaccine HiVeg™ Medium (Standard Nutrient HiVeg™ Broth)	Low risk	20/12/2012
DCM	M116	H.S. Vaccine Medium (Standard Nutrient Broth)	Low risk	20/12/2012

DCM	M1259	Haemophilus Test Agar Base	Low risk	20/12/2012
DCM	M551	Hartley's Digest Broth	Low risk	20/12/2012
DCM	MV551	Hartley's Digest HiVeg™ Broth	Low risk	20/12/2012
DCM	M467	Hektoen Enteric Agar	Low risk	20/12/2012
DCM	MU467	Hektoen Enteric Agar Medium	Low risk	20/12/2012
DCM	MCD467	Hektoen Enteric HiCynth™ Agar	Low risk	12/08/2015
DCM	MV467	Hektoen Enteric HiVeg™ Agar	Low risk	20/12/2012
DCM	M5390	Helicobacter Pylori Selective Agar	Low risk	30/10/2018
DCM	M1158	Hemorrhagic Coli (HC) Agar	Low risk	20/12/2012
DCM	M169	HI Agar	Low risk	20/12/2012
DCM	MV169	HI Agar, HiVeg™	Low risk	20/12/2012
DCM	M170	HI Broth	Low risk	20/12/2012
DCM	MV170	HI Broth, HiVeg™	Low risk	20/12/2012
DCM	M1832	HiCrome Coliform Agar Modified	Low risk	22/04/2019
DCM	MV1300	HiCrome Coliform HiVeg Agar w/ SLS	Low risk	22/04/2019
DCM	MV1295	HiCrome E. coli HiVeg™ Agar	Low risk	22/04/2019
DCM	MV1293	HiCrome ECC HiVeg™ Agar	Low risk	22/04/2019
DCM	MV1294	HiCrome ECC Selective HiVeg Agar Base	Low risk	22/04/2019
DCM	M1598	HiCrome Enrichment Broth Base for EC O157:H7	Low risk	22/04/2019
DCM	M1641	HiCrome Enterobacter sakazakii Agar, Modified	Low risk	22/04/2019
DCM	MV1577	HiCrome Enterobacter sakazakii HiVeg™ Agar	Low risk	22/04/2019
DCM	MV1641	HiCrome Enterobacter sakazakii HiVeg™ Agar, Modified	Low risk	22/04/2019
DCM	M1569	HiCrome M-Lauryl Sulphate Agar	Low risk	22/04/2019
DCM	M1862	HiCrome M-Modified ECO157:H7 Selective Agar Base	Low risk	22/04/2019
DCM	M1571	HiCrome M-TEC Agar	Low risk	22/04/2019
DCM	M1713	HiCrome M-TEC Broth	Low risk	22/04/2019
DCM	M1842	HiCrome Selective Salmonella Agar Base	Low risk	22/04/2019
DCM	MV1682	HiCrome Vibrio HiVeg™ Agar	Low risk	22/04/2019
DCM	M1651	HiCrome™ Bacillus Agar	Low risk	25/08/2016
DCM	MCD1651	HiCrome™ Bacillus HiCynth™ Agar	Low risk	25/08/2016
DCM	M1456AR	HiCrome™ Candida Differential Agar, Modified	Low risk	25/08/2016
DCM	MCD1297A	HiCrome™ Candida Differential HiCynth™ Agar	Low risk	12/08/2015
DCM	M1577	HiCrome™ Enterobacter sakazakii Agar	Low risk	22/04/2019
DCM	M1580	HiCrome™ Enterococcus faecium Agar Base	Low risk	25/08/2016
DCM	MCD1466	HiCrome™ Improved Salmonella HiCynth™ Agar	Low risk	12/08/2015
DCM	M1985	HiCrome™ Malassezia Agar	Low risk	20/12/2012
DCM	M1953R	HiCrome™ MeReSa Agar Base (Modified)	Low risk	25/08/2016
DCM	M1953	HiCrome™ MeReSa Agar Base (Modified)	Low risk	25/08/2016
DCM	M2010	HiCrome™ Mueller Hinton Agar	Low risk	25/08/2016
DCM	M1974	HiCrome™ Rapid MRSA Agar Base	Low risk	20/12/2012
DCM	M1353R	HiCrome™ UTI Agar	Low risk	25/08/2016
DCM	MCD1353	HiCrome™ UTI HiCynth™™ Agar	Low risk	12/08/2015
DCM	MV1353R	HiCrome™ UTI HiVeg™ Agar	Low risk	25/08/2016
DCM	M1938	HiCrome™ Acinetobacter Agar Base	Low risk	20/12/2012
DCM	M1960	HiCrome™ Bifidobacterium Agar	Low risk	20/12/2012

DCM	M2114	HiCrome™ C.auris (MDR) Selective Agar Base	Low risk	10/11/2020
DCM	M2020	HiCrome™ Campylobacter Agar Base	Low risk	16/12/2017
DCM	M1297A	HiCrome™ Candida Differential Agar	Low risk	20/12/2012
DCM	M1297AR	HiCrome™ Candida Differential Agar Base	Low risk	20/12/2012
DCM	M1456A	HiCrome™ Candida Differential Agar Base, Modified	Low risk	20/12/2012
DCM	MV1297A	HiCrome™ Candida Differential HiVeg™ Agar	Low risk	20/12/2012
DCM	MV1456A	HiCrome™ Candida Differential HiVeg™ Agar Base, Modified	Low risk	20/12/2012
DCM	M2099	HiCrome™ CarbaResist Agar Base	Low risk	22/04/2019
DCM	M1991I	HiCrome™ Chromogenic Coliform Agar (CCA)	Low risk	22/04/2019
DCM	M2026	HiCrome™ Clostridial Agar Base	Low risk	25/08/2016
DCM	M1300	HiCrome™ Coliform Agar w/ SLS	Low risk	22/04/2019
DCM	MCD1300	HiCrome™ Coliform HiCynth™ Agar w/ SLS	Low risk	10/11/2020
DCM	M2094	HiCrome™ Colistin Resistant Agar Base	Low risk	30/10/2018
DCM	M2062I	HiCrome™ Cronobacter Isolation Agar (CCI Agar)	Low risk	10/11/2020
DCM	M1295	HiCrome™ E. coli Agar	Low risk	22/04/2019
DCM	M1295I	HiCrome™ E. coli Agar	Low risk	22/04/2019
DCM	M1295	HiCrome™ E. coli Agar	Low risk	22/04/2019
DCM	MCD1295	HiCrome™ E.coli HiCynth™ Agar	Low risk	22/04/2019
DCM	MCD1580	HiCrome™ E.faecium HiCynth™ Agar Base	Low risk	25/08/2016
DCM	M1575A	HiCrome™ EC O157 : H7 Selective Agar Base, Modified	Low risk	10/11/2020
DCM	MV1575A	HiCrome™ EC O157 : H7 Selective HiVeg™ Agar Base, Modified	Low risk	10/11/2020
DCM	MCD1575A	HiCrome™ EC O157:H7 HiCynth™ Agar Base, Modified	Low risk	10/11/2020
DCM	M1574A	HiCrome™ EC O157:H7 Agar, Modified	Low risk	22/04/2019
DCM	M1293	HiCrome™ ECC Agar	Low risk	22/04/2019
DCM	M1294	HiCrome™ ECC Selective Agar Base	Low risk	22/04/2019
DCM	M2056	HiCrome™ ECC Selective Agar Base, Modified	Low risk	22/04/2019
DCM	M1488	HiCrome™ ECD Agar w/ MUG	Low risk	10/11/2020
DCM	MV1488	HiCrome™ ECD HiVeg™ Agar w/ MUG	Low risk	10/11/2020
DCM	MCD1598	HiCrome™ Enrichment HiCynth™ Broth Base for ECO157:H7	Low risk	10/11/2020
DCM	MCD1641	HiCrome™ Enterobacter sakazakii HiCynth™ Agar, Modified (HiCrome™ Cronobacter sakazakii HiCynth™ Agar, Modified)	Low risk	10/11/2020
DCM	M1376	HiCrome™ Enterococci Broth	Low risk	10/11/2020
DCM	MCD1376	HiCrome™ Enterococci HiCynth™ Broth	Low risk	10/11/2020
DCM	MV1376	HiCrome™ Enterococci HiVeg™ Broth	Low risk	10/11/2020
DCM	MV1580	HiCrome™ Enterococcus faecium HiVeg™ Agar Base	Low risk	10/11/2020
DCM	M1829	HiCrome™ ESBL Agar Base	Low risk	20/12/2012
DCM	M1466	HiCrome™ Improved Salmonella Agar	Low risk	20/12/2012
DCM	MV1466	HiCrome™ Improved Salmonella HiVeg™ Agar	Low risk	20/12/2012
DCM	M1573	HiCrome™ Klebsiella Selective Agar Base	Low risk	10/11/2020
DCM	MV1573	HiCrome™ Klebsiella Selective HiVeg™ Agar Base	Low risk	10/11/2020
DCM	M1831	HiCrome™ KPC Agar Base	Low risk	20/12/2012
DCM	M2009	HiCrome™ L mono differential Agar Base	Low risk	10/11/2020
DCM	M1924	HiCrome™ L.mono Rapid Differential Agar Base	Low risk	10/11/2020
DCM	M2065	HiCrome™ Lactobacillus Selective Agar Base	Low risk	10/11/2020
DCM	M1417F	HiCrome™ Listeria Agar Base	Low risk	10/11/2020
DCM	M1417	HiCrome™ Listeria Agar Base, Modified	Low risk	10/11/2020

DCM	MCD1417	HiCrome™ Listeria HiCynth™ Agar Base, Modified	Low risk	10/11/2020
DCM	M1340	HiCrome™ MacConkey Sorbitol Agar Base	Low risk	20/12/2012
DCM	MCD1340	HiCrome™ MacConkey Sorbitol HiCynth™ Agar	Low risk	25/08/2016
DCM	M2058	HiCrome™ M-Coliconfirm Agar Base	Low risk	10/11/2020
DCM	M2064	HiCrome™ m-Coliconfirm Broth Base	Low risk	22/04/2019
DCM	M1674	HiCrome™ MeReSa Agar Base	Low risk	20/12/2012
DCM	MCD1674	HiCrome™ MeReSa HiCynth™ Agar Base	Low risk	25/08/2016
DCM	MV1674	HiCrome™ MeReSa HiVeg™ Agar Base	Low risk	20/12/2012
DCM	M1393	HiCrome™ MM Agar	Low risk	20/12/2012
DCM	M1816	HiCrome™ MM Agar , Modified	Low risk	04/07/2018
DCM	M1816R	HiCrome™ MM Agar , Modified	Low risk	04/07/2018
DCM	MCD1816	HiCrome™ MM HiCynth™ Agar, Modified (HiCrome™ Miller and Mallinson HiCynth™ Agar)	Low risk	10/11/2020
DCM	MV1393	HiCrome™ MM HiVeg™ Agar	Low risk	20/12/2012
DCM	M1953	HiCrome™ MRSA Agar Base,Modified	Low risk	25/08/2016
DCM	MCD1571	HiCrome™ M-TEC HiCynth™ Agar	Low risk	10/11/2020
DCM	MCD1713	HiCrome™ M-TEC HiCynth™ Broth	Low risk	10/11/2020
DCM	M2067	HiCrome™ Mueller Hinton Agar (for antifungal)	Low risk	16/12/2017
DCM	M1712	HiCrome™ Nickels and Leesment Medium	Low risk	10/11/2020
DCM	MV1712	HiCrome™ Nickels & Leesment HiVeg™ Agar Base	Low risk	10/11/2020
DCM	MCD1633	HiCrome™ RajHans HiCynth™ Medium (Salmonella HiCynth™ Agar)	Low risk	25/08/2016
DCM	M1633	HiCrome™ RajHans Medium (Salmonella Agar)	Low risk	20/12/2012
DCM	M1634	HiCrome™ RajHans Medium, Modified (Salmonella Agar, Modified)	Low risk	20/12/2012
DCM	M2011	HiCrome™ Rapid ECC Broth	Low risk	22/04/2019
DCM	MCD1974	HiCrome™ Rapid MRSA HiCynth™ Agar Base	Low risk	25/08/2016
DCM	M2116	HiCrome™ Salmoconfirm Selective Agar	Low risk	10/11/2020
DCM	M1296	HiCrome™ Salmonella Agar	Low risk	20/12/2012
DCM	MV1296	HiCrome™ Salmonella HiVeg™ Agar	Low risk	20/12/2012
DCM	MCD1842	HiCrome™ Selective Salmonella HiCynth™ Agar Base	Low risk	10/11/2020
DCM	M1837	HiCrome™ Staph Agar Base, Modified	Low risk	20/12/2012
DCM	M1931	HiCrome™ Staph Selective Agar	Low risk	10/11/2020
DCM	M2092	HiCrome™ STEC Agar Base	Low risk	30/10/2018
DCM	M1840	HiCrome™ Strep B Selective Agar Base	Low risk	04/07/2018
DCM	M1966	HiCrome™ Strep B Selective Agar Base, Modified	Low risk	20/12/2012
DCM	MCD1840	HiCrome™ Strep B Selective HiCynth™ Agar Base	Low risk	04/07/2018
DCM	M1600	HiCrome™ Universal Differential Medium	Low risk	20/12/2012
DCM	MCD1418	HiCrome™ UTI HiCynth™ Agar, Modified	Low risk	25/08/2016
DCM	M1353	HiCrome™ UTI Agar	Low risk	20/12/2012
DCM	M1353R	HiCrome™ UTI Agar	Low risk	20/12/2012
DCM	M1418	HiCrome™ UTI Agar, Modified	Low risk	20/12/2012
DCM	MV1353	HiCrome™ UTI HiVeg™ Agar	Low risk	20/12/2012
DCM	MV1418	HiCrome™ UTI HiVeg™ Agar, Modified	Low risk	20/12/2012
DCM	M1505	HiCrome™ UTI Selective Agar	Low risk	20/12/2012
DCM	MV1505	HiCrome™ UTI Selective HiVeg™ Agar	Low risk	20/12/2012
DCM	M1682	HiCrome™ Vibrio Agar	Low risk	22/04/2019

DCM	MCD1682	HiCrome™ Vibrio HiCynth™ Agar	Low risk	10/11/2020
DCM	M1830	HiCrome™ VRE Agar Base	Low risk	20/12/2012
DCM	M1925	HiCrome™ VRE Agar Base, Modified	Low risk	20/12/2012
DCM	M2025	HiCrome™ Yersinia Agar Base	Low risk	25/08/2016
DCM	M1951	HiCrome™ M-Coliform Differential Agar Base	Low risk	22/04/2019
DCM	M2048	HiFast™ Listeria Enrichment Broth Base	Low risk	10/11/2020
DCM	M1469	HiFluoro Pseudomonas Agar Base	Low risk	20/12/2012
DCM	MV1469	HiFluoro Pseudomonas HiVeg™ Agar Base	Low risk	20/12/2012
DCM	M1218	High Salt Nutrient Agar	Low risk	20/12/2012
DCM	M1219	High Salt Peptone Yeast Extract Agar	Low risk	20/12/2012
DCM	M1054	Hippurate Hydrolysis Broth	Low risk	20/12/2012
DCM	M485	Hi-Sensitivity Test Agar	Low risk	20/12/2012
DCM	M486	Hi-Sensitivity Test Broth	Low risk	20/12/2012
DCM	MV485	Hi-Sensitivity Test HiVeg™ Agar	Low risk	20/12/2012
DCM	MV486	Hi-Sensitivity Test HiVeg™ Broth	Low risk	20/12/2012
DCM	M485A	HiSitest Agar	Low risk	20/12/2012
DCM	MV806	HiVeg™ Extract Agar	Low risk	20/12/2012
DCM	MV807	HiVeg™ Extract Broth	Low risk	20/12/2012
DCM	MV028	HiVeg™ Peptone Water	Low risk	20/12/2012
DCM	M806	HM Peptone B Agar	Low risk	20/12/2012
DCM	M807	HM Peptone B Broth	Low risk	20/12/2012
DCM	M924	Horie Arabinose Ethyl Violet Broth	Low risk	20/12/2012
DCM	M5385	Horse Blood agar	Low risk	30/10/2018
DCM	M1425	Hottinger Broth	Low risk	20/12/2012
DCM	MV015	Hoyle HiVeg™ Medium Base	Low risk	20/12/2012
DCM	M015	Hoyle Medium Base	Low risk	20/12/2012
DCM	MV871	Hugh Leifson Glucose HiVeg™ Medium	Low risk	20/12/2012
DCM	M871	Hugh Leifson Glucose Medium	Low risk	20/12/2012
DCM	MV826	Hugh Leifson HiVeg™ Medium	Low risk	20/12/2012
DCM	M826	Hugh Leifson Medium	Low risk	20/12/2012
DCM	M826S	Hugh Leifson Medium	Low risk	20/12/2012
DCM	MV364	Indole Nitrate HiVeg™ Medium (Tryptone Nitrate HiVeg™ Medium)	Low risk	20/12/2012
DCM	M364	Indole Nitrate Medium (Tryptone Nitrate Medium)	Low risk	20/12/2012
DCM	M574	Inositol Brilliant Green Bile Agar (Plesiomonas Differential Agar)	Low risk	20/12/2012
DCM	MV574	Inositol Brilliant Green HiVeg™ Agar (Plesiomonas Differential HiVeg™ Agar)	Low risk	20/12/2012
DCM	M1222	Karmali Campylobacter Agar Base	Low risk	10/11/2020
DCM	M248	KF Streptococcal Agar Base	Low risk	22/04/2019
DCM	M249	KF Streptococcal Broth Base	Low risk	20/12/2012
DCM	MV248	KF Streptococcal HiVeg™ Agar Base	Low risk	22/04/2019
DCM	MV248	KF Streptococcal HiVeg™ Agar Base	Low risk	22/04/2019
DCM	MV249	KF Streptococcal HiVeg™ Broth Base	Low risk	20/12/2012
DCM	M1007	KF Streptococcus Agar Base w/ BCP	Low risk	20/12/2012
DCM	M1021	KF Streptococcus Broth Base w/ BCP	Low risk	20/12/2012
DCM	MV1021	KF Streptococcus HiVeg™ Broth Base w/ BCP	Low risk	20/12/2012

DCM	M1232	Kimmig Fungi Agar Base	Low risk	20/12/2012
DCM	MV1232	Kimmig Fungi HiVeg™ Agar Base	Low risk	20/12/2012
DCM	M1543	King's Medium A Base	Low risk	20/12/2012
DCM	M1235	King's OF Medium Base	Low risk	20/12/2012
DCM	MV1235	Kings OF Medium Base, HiVeg™	Low risk	20/12/2012
DCM	M2040	Kirchner Medium Base	Low risk	28/04/2017
DCM	M161	Kirchner Medium Base, Modified	Low risk	20/12/2012
DCM	M078	Kligler Iron Agar	Low risk	20/12/2012
DCM	M078I	Kligler Iron Agar	Low risk	20/12/2012
DCM	M078A	Kligler Iron Agar, Modified	Low risk	20/12/2012
DCM	MCD078	Kligler Iron HiCynth™ Agar	Low risk	12/08/2015
DCM	MV078	Kligler Iron HiVeg™ Agar	Low risk	20/12/2012
DCM	MV142	Kohn Two Tube HiVeg™ Medium No.1 Base	Low risk	20/12/2012
DCM	MV802	Kohn Two Tube HiVeg™ Medium No.2	Low risk	20/12/2012
DCM	M142	Kohn Two Tube Medium No.1 Base	Low risk	20/12/2012
DCM	M802	Kohn Two Tube Medium No.2	Low risk	20/12/2012
DCM	M069	Koser Citrate Medium	Low risk	20/12/2012
DCM	MV171	Kracke Blood Culture HiVeg™ Medium	Low risk	20/12/2012
DCM	M171	Kracke Blood Culture Medium	Low risk	20/12/2012
DCM	M305	Kupferberg Trichomonas Broth Base (Trichomonas Broth Base, Kupferberg)	Low risk	20/12/2012
DCM	MV305	Kupferberg Trichomonas HiVeg™ Broth Base	Low risk	20/12/2012
DCM	M928	L Broth	Low risk	20/12/2012
DCM	M1312	L Broth, Modified	Low risk	20/12/2012
DCM	M162R	L J Medium Base, Modified	Low risk	25/08/2016
DCM	M1552	L. mono Confirmatory Agar Base	Low risk	20/12/2012
DCM	MV1552	L. mono Confirmatory HiVeg™ Agar Base	Low risk	20/12/2012
DCM	M742	L.D. Agar	Low risk	20/12/2012
DCM	M744	L.D. Egg Yolk Agar Base	Low risk	20/12/2012
DCM	M743	L.D. Esculin Agar	Low risk	20/12/2012
DCM	MV743	L.D. Esculin HiVeg™ Agar	Low risk	20/12/2012
DCM	MV742	L.D. HiVeg™ Agar	Low risk	20/12/2012
DCM	M1540	L.mono Differential Agar Base	Low risk	22/04/2019
DCM	M1540I	HiCrome™ Listeria Ottaviani-Agosti Agar Base	Low risk	10/11/2020
DCM	M1540IR	L.mono Differential Agar Base	Low risk	10/11/2020
DCM	MCD1540	L.mono Differential HiCynth™ Agar Base	Low risk	22/04/2019
DCM	MV1540	L.mono Differential HiVeg™ Agar Base	Low risk	22/04/2019
DCM	M926	Lactic Streak Agar (Reddy's Differential Agar, Modified)	Low risk	20/12/2012
DCM	MV926	Lactic Streak HiVeg™ Agar	Low risk	20/12/2012
DCM	MV368	Lactobacilli HiVeg™ Broth	Low risk	20/12/2012
DCM	M927	Lactobacillus Bulgaricus Agar Base	Low risk	20/12/2012
DCM	MV927	Lactobacillus Bulgaricus HiVeg™ Agar Base	Low risk	20/12/2012
DCM	M641	Lactobacillus MRS Agar (MRS Agar)	Low risk	20/12/2012
DCM	M641I	Lactobacillus MRS Agar (MRS Agar)	Low risk	20/12/2012
DCM	M369	Lactobacillus MRS Broth (MRS Broth)	Low risk	20/12/2012
DCM	MV641	Lactobacillus MRS HiVeg™ Agar (MRS HiVeg™ Agar)	Low risk	20/12/2012

DCM	MV369	Lactobacillus MRS HiVeg™ Broth (MRS HiVeg™ Broth)	Low risk	20/12/2012
DCM	M1165	Lactobacillus Selection Bile Agar Base (LBS Bile Agar)	Low risk	20/12/2012
DCM	M1081	Lactose Blue Agar (B.T.B. Lactose Agar, Modified)	Low risk	20/12/2012
DCM	MV1081	Lactose Blue HiVeg™ Agar (B.T.B. Lactose HiVeg™ Agar, Modified)	Low risk	20/12/2012
DCM	M1003	Lactose Broth	Low risk	22/04/2019
DCM	MV1003	Lactose HiVeg™ Broth	Low risk	22/04/2019
DCM	M1047	Lactose Lecithin Agar	Low risk	04/07/2018
DCM	M080	Lauryl Sulphate Broth (Lauryl Tryptose Broth)	Low risk	22/04/2019
DCM	MV080	Lauryl SulphateHiVeg™ Broth (Lauryl Tryptose HiVeg™ Broth)	Low risk	22/04/2019
DCM	M180	Lead Acetate Agar	Low risk	10/11/2020
DCM	M1839	Leeds Acinetobacter Agar Base	Low risk	20/12/2012
DCM	M1938R	Leeds Acinetobacter Agar Base (HiCrome™ Acinetobacter Agar Base)	Low risk	25/08/2016
DCM	M1845	Legionella Agar Base w/o Charcoal	Low risk	10/11/2020
DCM	M1380	Leifson Agar	Low risk	20/12/2012
DCM	MV1380	Leifson HiVeg™ Agar	Low risk	20/12/2012
DCM	M1138	Leifson's Deoxycholate Agar, Modified	Low risk	20/12/2012
DCM	MV1138	Leifson's Deoxycholate HiVeg™ Agar, Modified	Low risk	20/12/2012
DCM	MV239	Leptospira HiVeg™ Medium Base, Fletcher	Low risk	20/12/2012
DCM	MV457	Leptospira HiVeg™ Medium Base, Korthof, Modified	Low risk	20/12/2012
DCM	M1009	Leptospira Medium Base	Low risk	20/12/2012
DCM	M239	Leptospira Medium Base, Fletcher	Low risk	20/12/2012
DCM	M457	Leptospira Medium Base, Korthof, Modified	Low risk	20/12/2012
DCM	MV472	Levinthal's HiVeg™ Medium Base	Low risk	20/12/2012
DCM	M472	Levinthal's Medium Base	Low risk	20/12/2012
DCM	M374	LI Agar	Low risk	20/12/2012
DCM	MV374	LI Agar, HiVeg™	Low risk	20/12/2012
DCM	M153	LI Broth	Low risk	20/12/2012
DCM	MV153	LI Broth, HiVeg™	Low risk	20/12/2012
DCM	M627	Lipovitellin Salt Mannitol Agar Base	Low risk	20/12/2012
DCM	M817	Liquoid Broth	Low risk	20/12/2012
DCM	MV817	Liquoid HiVeg™ Broth	Low risk	20/12/2012
DCM	M569	Listeria Enrichment Broth (Twin Pack)	Low risk	20/12/2012
DCM	MV569	Listeria Enrichment HiVeg™ Broth (Twin Pack)	Low risk	20/12/2012
DCM	MV890A	Listeria Enrichment HiVeg™ Medium Base (UVM)	Low risk	20/12/2012
DCM	M890A	Listeria Enrichment Medium Base (UVM)	Low risk	20/12/2012
DCM	M1064	Listeria Identification Agar Base (PALCAM)	Low risk	22/04/2019
DCM	M1090	Listeria Identification Broth Base (PALCAM)	Low risk	22/04/2019
DCM	MV1064	Listeria Identification HiVeg Agar Base (PALCAM)	Low risk	22/04/2019
DCM	MV1090	Listeria Identification HiVeg Broth Base (PALCAM)	Low risk	22/04/2019
DCM	MCD1145	Listeria Oxford HiCynth™ Medium Base	Low risk	25/08/2016
DCM	MV1145	Listeria Oxford HiVeg™ Medium Base	Low risk	20/12/2012
DCM	M1145R	Listeria Oxford Medium Base	Low risk	25/08/2016
DCM	M1145	Listeria Oxford Medium Base	Low risk	20/12/2012
DCM	M1781	Listeria Oxford Medium Base, Modified	Low risk	20/12/2012

DCM	M567	Listeria Selective Agar (Twin Pack)	Low risk	20/12/2012
DCM	M1474	Listeria Selective Agar Base	Low risk	20/12/2012
DCM	M889	Listeria Selective Broth Base	Low risk	20/12/2012
DCM	M1865	Listeria Selective Enrichment Broth	Low risk	22/04/2019
DCM	MV567	Listeria Selective HiVeg™ Agar (Twin Pack)	Low risk	20/12/2012
DCM	MV889	Listeria Selective HiVeg™ Broth Base	Low risk	20/12/2012
DCM	M507	Litmus Lactose Bile Salt Agar (LLBSA)	Low risk	10/11/2020
DCM	MV507	Litmus Lactose HiVeg™ Agar	Low risk	10/11/2020
DCM	M373	Littman Bile Agar Base	Low risk	20/12/2012
DCM	M663	Littman Bile Broth Base	Low risk	20/12/2012
DCM	MV373	Littman HiVeg™ Agar Base	Low risk	20/12/2012
DCM	MV663	Littman HiVeg™ Broth Base	Low risk	20/12/2012
DCM	M1001	LM Agar	Low risk	20/12/2012
DCM	M1934	LM Agar, Modified	Low risk	20/12/2012
DCM	MV537	Loeffler HiVeg™ Medium Base	Low risk	20/12/2012
DCM	M537	Loeffler Medium Base	Low risk	20/12/2012
DCM	M1189	Loeffler Serum Medium Base	Low risk	20/12/2012
DCM	MM162	Lowenstein - Jensen Medium (L.J. Medium) (Twin Pack)	Low risk	20/12/2012
DCM	M162R	Lowenstein Jensen Medium Base Modified	Low risk	25/08/2016
DCM	M162	Lowenstein Jensen Medium Base (L.J. Medium)	Low risk	20/12/2012
DCM	M1542	Lowenstein Jensen Medium Base w/o Starch	Low risk	20/12/2012
DCM	M2032	Lowenstein Jensen Medium Base, Modified	Low risk	25/08/2016
DCM	M176	LV Agar (Liver Veal Agar)	Low risk	10/11/2020
DCM	M1977	Lysine Indole Motility Medium, Modified	Low risk	10/11/2020
DCM	MH081	MacConkey Agar	Low risk	22/04/2019
DCM	M1024	MacConkey Agar Base	Low risk	20/12/2012
DCM	M1819	MacConkey Agar II w/o CV	Low risk	20/12/2012
DCM	M008E	MacConkey Agar Medium	Low risk	20/12/2012
DCM	M081	MacConkey Agar w/ 0.15% Bile Salts, CV and NaCl	Low risk	20/12/2012
DCM	M061	MacConkey Agar w/ Bromo Thymol Blue	Low risk	20/12/2012
DCM	M1582	MacConkey Agar w/ CV and w/o NaCl	Low risk	20/12/2012
DCM	M081A	MacConkey Agar w/ CV, NaCl, and 0.15% Bile Salts	Low risk	20/12/2012
DCM	M008	MacConkey Agar w/o CV w/ 0.15% Bile Salts	Low risk	20/12/2012
DCM	M082A	MacConkey Agar w/o CV, NaCl w/ 0.5% Bile Salts	Low risk	20/12/2012
DCM	M082	MacConkey Agar w/o CV, NaCl w/ 0.5% Sodium Taurocholate	Low risk	20/12/2012
DCM	M008A	MacConkey Agar w/o CV, w/ 0.5% Bile Salts	Low risk	20/12/2012
DCM	M008B	MacConkey Agar w/o CV, w/ 1.2% Agar	Low risk	20/12/2012
DCM	M1785	MacConkey Agar w/o CV, w/0.5% Sodium Taurocholate	Low risk	20/12/2012
DCM	M1702	MacConkey Agar, RS	Low risk	20/12/2012
DCM	MH083	MacConkey Broth	Low risk	22/04/2019
DCM	M083	MacConkey Broth Purple w/BCP	Low risk	22/04/2019
DCM	MCD081	MacConkey HiCynth™ Agar w/ 0.15% Bile Salts	Low risk	25/08/2016
DCM	MCD082	MacConkey HiCynth™ Agar w/o CV, NaCl	Low risk	25/08/2016
DCM	MV1024	MacConkey HiVeg™ Agar Base	Low risk	20/12/2012
DCM	MV061	MacConkey HiVeg™ Agar w/ Bromo Thymol Blue	Low risk	20/12/2012

DCM	MV081	MacConkey HiVeg™ Agar w/ CV, NaCl, 0.003% NR and 1.5% Agar	Low risk	20/12/2012
DCM	MV081A	MacConkey HiVeg™ Agar w/ CV, NaCl, 0.005% NR and 1.5% Agar	Low risk	20/12/2012
DCM	MV082	MacConkey HiVeg™ Agar w/o CV and NaCl, w/ 0.004% NR and 2.0% Agar	Low risk	20/12/2012
DCM	MV082A	MacConkey HiVeg™ Agar w/o CV and NaCl, w/ 0.0075% NR and 1.2% Agar	Low risk	20/12/2012
DCM	MV008B	MacConkey HiVeg™ Agar w/o CV, w/ 0.003% NR and 1.2% Agar	Low risk	20/12/2012
DCM	MV008	MacConkey HiVeg™ Agar w/o CV, w/ 0.003% NR and 1.5% Agar	Low risk	20/12/2012
DCM	MV008A	MacConkey HiVeg™ Agar w/o CV, w/ 0.0075% NR and 1.2% Agar	Low risk	20/12/2012
DCM	MV083	MacConkey HiVeg™ Broth Purple w/ BCP	Low risk	22/04/2019
DCM	M298	MacConkey Sorbitol Agar	Low risk	20/12/2012
DCM	M298I	MacConkey Sorbitol Agar Base	Low risk	20/12/2012
DCM	M1727R	MacConkey Sorbitol Agar Base (w/ Rhamnose)	Low risk	25/08/2016
DCM	M1727	MacConkey Sorbitol Agar Base w/ Rhamnose	Low risk	20/12/2012
DCM	MCD298	MacConkey Sorbitol HiCynth™ Agar (Sorbitol HiCynth™ Agar)	Low risk	28/04/2017
DCM	MV298	MacConkey Sorbitol HiVeg™ Agar	Low risk	20/12/2012
DCM	M2074	MacConkey Sorbitol Rhamnose Selective Agar Base	Low risk	16/12/2017
DCM	M382	Malonate Broth	Low risk	25/08/2016
DCM	M137	Malt Extract Agar Base (w/ Mycological Peptone)	Low risk	20/12/2012
DCM	M995	Malt Extract Agar Base, Modified as per Thom and Church	Low risk	20/12/2012
DCM	M255	Malt Extract Broth Base	Low risk	20/12/2012
DCM	M1128	Malt Extract Broth, Modified as per Thom and Church	Low risk	20/12/2012
DCM	MV137	Malt Extract HiVeg™ Agar Base	Low risk	20/12/2012
DCM	MV995	Malt Extract HiVeg™ Agar Base, Modified	Low risk	20/12/2012
DCM	MV255	Malt Extract HiVeg™ Broth Base	Low risk	20/12/2012
DCM	M1967	Malt Yeast Agar	Low risk	20/12/2012
DCM	M1624	Mannitol Agar w/Prilion	Low risk	20/12/2012
DCM	M1071	Mannitol Lysine Agar	Low risk	20/12/2012
DCM	MCD1071	Mannitol Lysine HiCynth™ Agar	Low risk	25/08/2016
DCM	M1320	Mannitol Motility Nitrate Medium	Low risk	20/12/2012
DCM	MV770	Mannitol Motility Test HiVeg™ Medium	Low risk	20/12/2012
DCM	M770	Mannitol Motility Test Medium	Low risk	20/12/2012
DCM	MH118	Mannitol Salt Agar	Low risk	22/04/2019
DCM	M118	Mannitol Salt Agar Base	Low risk	20/12/2012
DCM	M383	Mannitol Salt Broth	Low risk	20/12/2012
DCM	MCD118	Mannitol Salt HiCynth™ Agar Base	Low risk	12/08/2015
DCM	MV118	Mannitol Salt HiVeg™ Agar Base	Low risk	20/12/2012
DCM	MV383	Mannitol Salt HiVeg™ Broth	Low risk	20/12/2012
DCM	M1534	Mannitol Selenite Broth (Selenite Mannitol Broth) (Twin Pack)	Low risk	20/12/2012
DCM	M1537	Mannitol Selenite Broth w/Brilliant Green (Twin Pack)	Low risk	04/07/2018
DCM	MV379	Marine Oxidation Fermentation HiVeg™ Medium	Low risk	20/12/2012
DCM	M379	Marine Oxidation Fermentation Medium	Low risk	20/12/2012
DCM	M2085	Martin Lewis Agar Base	Low risk	22/04/2019
DCM	M1030	Maximum Recovery Diluent	Low risk	22/04/2019
DCM	MV1030	Maximum Recovery Diluent HiVeg™	Low risk	22/04/2019

DCM	M386	McBride Listeria Agar Base	Low risk	20/12/2012
DCM	MV386	McBride Listeria HiVeg™ Agar Base	Low risk	20/12/2012
DCM	M1354	M-CP Agar Base	Low risk	10/11/2020
DCM	MV1354	M-CP HiVeg™ Agar Base	Low risk	10/11/2020
DCM	M1426	M-E.coli Broth	Low risk	22/04/2019
DCM	M1594	MeReSa Agar Base	Low risk	20/12/2012
DCM	M1974R	MeReSa Agar Base (HiCrome™ Rapid MRSA Agar)	Low risk	25/08/2016
DCM	M1812	M-FC Basal Medium	Low risk	10/11/2020
DCM	M199	Middlebrook 7H10 Agar Base	Low risk	20/12/2012
DCM	M196	Middlebrook 7H10 Agar Base, Special	Low risk	20/12/2012
DCM	M511	Middlebrook 7H11 Agar Base	Low risk	20/12/2012
DCM	M511A	Middlebrook 7H11 Agar Base w/o Malachite Green	Low risk	20/12/2012
DCM	MV511	Middlebrook 7H11 HiVeg™ Agar Base	Low risk	20/12/2012
DCM	M197	Middlebrook 7H9 Agar Base	Low risk	20/12/2012
DCM	M198	Middlebrook 7H9 Broth Base	Low risk	20/12/2012
DCM	M259	Mitis Salivarius Agar Base	Low risk	20/12/2012
DCM	MV259	Mitis Salivarius HiVeg™ Agar Base	Low risk	20/12/2012
DCM	M5319	Modified B.Q. Vaccine Medium	Low risk	28/04/2017
DCM	M1150	Modified Bile Esculin Azide Agar	Low risk	20/12/2012
DCM	M892	Modified Buffered Charcoal Agar Base	Low risk	20/12/2012
DCM	MV892	Modified Buffered Charcoal HiVeg™ Agar Base	Low risk	20/12/2012
DCM	M1660	Modified Cary-Blair Medium	Low risk	20/12/2012
DCM	MV460	Modified CPLM HiVeg™ Medium Base (Trichomonas Modified CPLM HiVeg™ Medium Base)	Low risk	20/12/2012
DCM	M460	Modified CPLM Medium Base (Trichomonas Modified CPLM Medium Base)	Low risk	20/12/2012
DCM	M1170	Modified Czapek Dox Agar	Low risk	20/12/2012
DCM	M1285	Modified EC Broth Base	Low risk	20/12/2012
DCM	M1445	Modified Lactobacillus Agar	Low risk	20/12/2012
DCM	M1643	Modified Lauryl Sulphate Tryptose Broth Base	Low risk	20/12/2012
DCM	M1457R	Modified Listeria Lecithinase Agar Base	Low risk	25/08/2016
DCM	M1897	Modified Listeria Oxford Agar Base	Low risk	25/11/2017
DCM	M891	Modified McBride Listeria Agar Base	Low risk	20/12/2012
DCM	MV891	Modified McBride Listeria HiVeg™™ Agar Base	Low risk	20/12/2012
DCM	M1139	Modified MYP Agar Base	Low risk	20/12/2012
DCM	MV1139	Modified MYP HiVeg™ Agar Base	Low risk	20/12/2012
DCM	M1606	Modified Protease Agar	Low risk	20/12/2012
DCM	M1681	Modified Sabourauds Chloramphenicol Agar	Low risk	20/12/2012
DCM	M1068	Modified Salt Broth	Low risk	20/12/2012
DCM	M2049	Modified Shieh Agar (LMG Medium 215)	Low risk	28/04/2017
DCM	M1286I	Modified Soyabean Bile Broth Base	Low risk	22/04/2019
DCM	M795	Modified Thayer Martin Medium Base (w/o Supplement)	Low risk	20/12/2012
DCM	M393	Moeller Decarboxylase Broth Base	Low risk	25/08/2016
DCM	MCD393	Moeller Decarboxylase HiCynth™ Broth Bas	Low risk	25/08/2016
DCM	M246	Mold Inhibitory Agar, Ulrich	Low risk	20/12/2012
DCM	M474	Monsur Medium Base	Low risk	20/12/2012

DCM	M1927	MRS Agar w/ Low pH	Low risk	10/11/2020
DCM	M1864	MSM Broth Base	Low risk	20/12/2012
DCM	M173	Mueller Hinton Agar	Low risk	20/12/2012
DCM	M1825	Mueller Hinton Agar 2% Glucose w/ Methylene blue	Low risk	20/12/2012
DCM	M1825R	Mueller Hinton Agar Modified (As per CLSI)	Low risk	25/08/2016
DCM	M1084	Mueller Hinton Agar No. 2	Low risk	20/12/2012
DCM	M5389	Mueller Hinton Agar w/ 2% NaCL	Low risk	30/10/2018
DCM	M391	Mueller Hinton Broth	Low risk	20/12/2012
DCM	M1657	Mueller Hinton Broth No. 2 Control Cations	Low risk	20/12/2012
DCM	MV173	Mueller Hinton HiVeg™ Agar	Low risk	20/12/2012
DCM	MV1084	Mueller Hinton HiVeg™ Agar No. 2	Low risk	20/12/2012
DCM	MV391	Mueller Hinton HiVeg™ Broth	Low risk	20/12/2012
DCM	M1202	Mueller Tellurite Agar Base	Low risk	20/12/2012
DCM	M1373	MUG EC O157 Agar	Low risk	16/12/2017
DCM	M1429	MUG EC O157 Agar, Modified	Low risk	20/12/2012
DCM	M1080	MUG MacConkey Agar	Low risk	20/12/2012
DCM	MV1080	MUG MacConkey HiVeg™ Agar	Low risk	20/12/2012
DCM	M1205	MUG Sorbitol Agar	Low risk	20/12/2012
DCM	M977	Mutans-Sanguis Agar	Low risk	20/12/2012
DCM	M094	Mycological Agar	Low risk	20/12/2012
DCM	M095	Mycological Agar w/ Low pH	Low risk	20/12/2012
DCM	M1422	Mycological Agar, Modified	Low risk	20/12/2012
DCM	M264	Mycological Broth	Low risk	20/12/2012
DCM	M265	Mycological Broth w/ Low pH	Low risk	20/12/2012
DCM	M266	Mycoplasma Agar Base (PPLO Agar Base)	Low risk	20/12/2012
DCM	M268	Mycoplasma Broth Base w/ CV (PPLO Broth Base w/ CV)	Low risk	20/12/2012
DCM	M267	Mycoplasma Broth Base w/o CV (PPLO Broth Base w/o CV)	Low risk	20/12/2012
DCM	M1498	Mycoplasma Cultivation Broth Base	Low risk	20/12/2012
DCM	MV266	Mycoplasma HiVeg™ Agar Base (PPLO HiVeg™ Agar Base)	Low risk	20/12/2012
DCM	MV268	Mycoplasma HiVeg™ Broth Base w/ CV (PPLO HiVeg™ Broth Base w/ CV)	Low risk	20/12/2012
DCM	MV267	Mycoplasma HiVeg™ Broth Base w/o CV (PPLO HiVeg™ Broth Base w/o CV)	Low risk	20/12/2012
DCM	MV624	Mycoplasma Synoviae HiVeg™ Medium Base	Low risk	20/12/2012
DCM	M624	Mycoplasma Synoviae Medium Base	Low risk	20/12/2012
DCM	M1374	Mycoplasma Urogenital Broth Base (Urogenital Mycoplasma Broth Base)	Low risk	20/12/2012
DCM	M636	MYP Agar Base (Phenol Red Egg Yolk Polymyxin Agar Base)	Low risk	20/12/2012
DCM	MCD636	MYP HiCynth™ Agar Base (Phenol Red Egg Yolk Polymyxin HiCynth™ Agar Base)	Low risk	28/04/2017
DCM	MV636	MYP HiVeg™ Agar Base (Phenol Red Polymyxin HiVeg™ Agar Base)	Low risk	20/12/2012
DCM	MV217	Nickerson HiVeg™ Medium (Bi.G.G.Y. HiVeg™ Agar)	Low risk	20/12/2012
DCM	M217	Nickerson Medium	Low risk	20/12/2012
DCM	M072	Nitrate Agar	Low risk	10/11/2020
DCM	MV072	Nitrate HiVeg™ Agar	Low risk	10/11/2020
DCM	M681	NNN Modified Medium (Twin Pack)	Low risk	10/11/2020
DCM	M001	Nutrient Agar	Low risk	20/12/2012

DCM	M001A	Nutrient Agar	Low risk	20/12/2012
DCM	M087	Nutrient Agar 1.5%	Low risk	20/12/2012
DCM	M1269	Nutrient Agar No.2	Low risk	20/12/2012
DCM	M012	Nutrient Agar w/ 1% Peptone	Low risk	20/12/2012
DCM	M561	Nutrient Agar, pH 6.8	Low risk	20/12/2012
DCM	M002	Nutrient Broth	Low risk	20/12/2012
DCM	M1362	Nutrient Broth No. 2	Low risk	20/12/2012
DCM	M1902	Nutrient Broth No.3	Low risk	20/12/2012
DCM	M060	Nutrient Gelatin	Low risk	20/12/2012
DCM	MCD001	Nutrient HiCynth™ Agar	Low risk	12/08/2015
DCM	MCD002	Nutrient HiCynth™ Broth	Low risk	12/08/2015
DCM	MV001	Nutrient HiVeg™ Agar	Low risk	20/12/2012
DCM	MV087	Nutrient HiVeg™ Agar 1.5%	Low risk	20/12/2012
DCM	MV1269	Nutrient HiVeg™ Agar No.2	Low risk	20/12/2012
DCM	MV012	Nutrient HiVeg™ Agar w/ 1% HiVeg™ Peptone	Low risk	20/12/2012
DCM	MV561	Nutrient HiVeg™ Agar, pH 6.8	Low risk	20/12/2012
DCM	MV002	Nutrient HiVeg™ Broth	Low risk	20/12/2012
DCM	M1348	NYC Agar Base	Low risk	20/12/2012
DCM	MCD395	OF Basal HiCynth™ Medium	Low risk	25/08/2016
DCM	MV395	OF Basal HiVeg™ Medium	Low risk	20/12/2012
DCM	M395	OF Basal Medium	Low risk	20/12/2012
DCM	M1811	OFBBL Agar Base (Oxidation Fermentation Polymyxin Bacitracin Lactose Agar Base)	Low risk	20/12/2012
DCM	M1930	ONPG BROTH	Low risk	20/12/2012
DCM	M933	Orange Serum Agar	Low risk	22/04/2019
DCM	MV933	Orange SerumHiVeg™ Agar	Low risk	22/04/2019
DCM	M1454	Oxacillin Resistance Screening Agar Base	Low risk	20/12/2012
DCM	M1390	Pagano Levin Base	Low risk	20/12/2012
DCM	M867	Peizer TB Medium Base	Low risk	20/12/2012
DCM	M1207	Pepted M Broth	Low risk	20/12/2012
DCM	M028	Peptone Water	Low risk	20/12/2012
DCM	MCD837	Perfringens HiCynth™ Agar Base (T.S.C/S.F.P HiCynth™ Agar Base)	Low risk	28/04/2017
DCM	MV837	Perfringens HiVeg™ Agar Base (T.S.C/S.F.P HiCynth™ Agar Base)	Low risk	28/04/2017
DCM	M269A	Phenylethanol Agar Base	Low risk	20/12/2012
DCM	M269	Phenylethyl Alcohol Agar Base	Low risk	20/12/2012
DCM	MV269	Phenylethyl Alcohol HiVeg™ Agar Base	Low risk	20/12/2012
DCM	M540	Phenylethyl Blood Agar Base (Anaerobic)	Low risk	20/12/2012
DCM	M1866	Phosphate Buffered Saline (PBS) pH 7.4	Low risk	22/04/2019
DCM	M519	Pike Streptococcal Broth Base	Low risk	20/12/2012
DCM	MV519	Pike Streptococcal HiVeg™ Broth Base	Low risk	20/12/2012
DCM	M282	PKU Test Agar Base	Low risk	20/12/2012
DCM	M398	PKU Test Agar w/ Thienylalanine	Low risk	20/12/2012
DCM	M091	Plate Count Agar (Standard Methods Agar)	Low risk	28/04/2017
DCM	MCD091	Plate Count HiCynth™ Agar (Standard Methods HiCynth™ Agar)	Low risk	28/04/2017

DCM	MV091	Plate Count HiVeg™ Agar (Standard Methods HiVeg™ Agar)	Low risk	28/04/2017
DCM	M574	Plesiomonas Differential Agar	Low risk	20/12/2012
DCM	MV574	Plesiomonas Differential HiVeg™ Agar	Low risk	20/12/2012
DCM	M1446	PLET Agar Base	Low risk	20/12/2012
DCM	M1451	PLET Agar Base, Modified	Low risk	20/12/2012
DCM	M835	PNY Medium	Low risk	20/12/2012
DCM	MH096	Potato Dextrose Agar	Low risk	22/04/2019
DCM	M096	Potato Dextrose Agar	Low risk	22/04/2019
DCM	M5391	PPLO Agar Base	Low risk	30/10/2018
DCM	M1586	PPLO Modified Broth Base w/o CV	Low risk	20/12/2012
DCM	M899	Preston Enrichment Broth Base	Low risk	20/12/2012
DCM	MV899	Preston Enrichment HiVeg™ Broth Base	Low risk	20/12/2012
DCM	M956	Propionibacter Isolation Agar Base	Low risk	20/12/2012
DCM	M1697	Proskauer Beck medium	Low risk	20/12/2012
DCM	M085	Pseudomonas Agar Base	Low risk	22/04/2019
DCM	M085	Pseudomonas Agar Base	Low risk	22/04/2019
DCM	MV085	Pseudomonas HiVeg Agar Base	Low risk	22/04/2019
DCM	M406	Pseudomonas Isolation Agar Base	Low risk	20/12/2012
DCM	MCD406	Pseudomonas Isolation HiCynth™ Agar	Low risk	25/08/2016
DCM	MV406	Pseudomonas Isolation HiVeg™ Agar Base	Low risk	20/12/2012
DCM	M1489	PYR Agar	Low risk	10/11/2020
DCM	M1743	R2A Agar, Modified	Low risk	22/04/2019
DCM	MV1078	RajHans HiVeg™ Medium (Twin Pack)	Low risk	20/12/2012
DCM	M1078	RajHans Medium (Twin Pack)	Low risk	20/12/2012
DCM	M1453A	Rapid HiColiform Broth w/Tryptophan	Low risk	22/04/2019
DCM	MCD1465	Rapid HiColiform HiCynth™ Agar	Low risk	10/11/2020
DCM	M1465	Rapid HiColiform™ Agar	Low risk	10/11/2020
DCM	MV1465	Rapid HiColiform™ HiVeg™ Agar	Low risk	10/11/2020
DCM	MCD1491	Rappaport Vassiliadis HiCynth™ Broth	Low risk	12/08/2015
DCM	M1530	Rappaport Vassiliadis R10 Medium	Low risk	20/12/2012
DCM	MH1491	Rappaport Vassiliadis Salmonella Enrichment Broth	Low risk	22/04/2019
DCM	M1491	Rappaport Vassiliadis Soya Broth (RVS Broth)	Low risk	20/12/2012
DCM	MCD1491	Rappaport Vassiliadis Soya HiCynth™ Broth	Low risk	25/08/2016
DCM	M1448	Rappaport Vassiliadis Soyabean Meal Broth (RVSM)	Low risk	20/12/2012
DCM	MH443	Reinforced Medium for Clostridia	Low risk	22/04/2019
DCM	M1626	Reuter's Sorbic Acid Agar Base	Low risk	20/12/2012
DCM	M459	Robinson Medium for Entamoeba (Twin Pack)	Low risk	20/12/2012
DCM	M149	Robinson's Cooked M Medium (R.C. Medium)	Low risk	16/12/2017
DCM	M1899	Rogosa Agar, Modified	Low risk	20/12/2012
DCM	M130	Rogosa SL Agar	Low risk	20/12/2012
DCM	M958	Rogosa SL Agar w/ 0.15% Bile	Low risk	20/12/2012
DCM	M407	Rogosa SL Broth	Low risk	20/12/2012
DCM	MCD130	Rogosa SL HiCynth™ Agar	Low risk	28/04/2017
DCM	MV130	Rogosa SL HiVeg™ Agar	Low risk	20/12/2012
DCM	MV407	Rogosa SL HiVeg™ Broth	Low risk	20/12/2012

DCM	M842	Rose Bengal Agar Base	Low risk	20/12/2012
DCM	M640	Rose Bengal Chloramphenicol Agar	Low risk	22/04/2019
DCM	MV640	Rose Bengal Chloramphenicol HiVeg™ Agar	Low risk	22/04/2019
DCM	M1972	RPMI 1640 Agar w/ MOPS & 2% Glucose w/o Sodium Bicarbonate (Twin Pack)	Low risk	20/12/2012
DCM	MV576	RS HiVeg Medium Base	Low risk	22/04/2019
DCM	M576	RS Medium Base	Low risk	22/04/2019
DCM	M409	SABHI Agar Base	Low risk	20/12/2012
DCM	MV409	SABHI HiVeg™ Agar Base	Low risk	20/12/2012
DCM	M1744	Sabouraud Agar Glucose 4%	Low risk	20/12/2012
DCM	M1067	Sabouraud Chloramphenicol Agar	Low risk	20/12/2012
DCM	MV1067	Sabouraud Chloramphenicol HiVeg™ Agar	Low risk	20/12/2012
DCM	M664	Sabouraud Cycloheximide Chloramphenicol Agar	Low risk	20/12/2012
DCM	MV664	Sabouraud Cycloheximide Chloramphenicol HiVeg™ Agar	Low risk	20/12/2012
DCM	MH063	Sabouraud Dextrose Agar	Low risk	22/04/2019
DCM	M063	Sabouraud Dextrose Agar	Low risk	20/12/2012
DCM	M286	Sabouraud Dextrose Agar Base, Modified	Low risk	20/12/2012
DCM	MH033	Sabouraud Dextrose Broth	Low risk	22/04/2019
DCM	M033	Sabouraud Dextrose Broth (Sabouraud Liquid Medium)	Low risk	20/12/2012
DCM	MCD063	Sabouraud Dextrose HiCynth™ Agar	Low risk	12/08/2015
DCM	MCD033	Sabouraud Dextrose HiCynth™ Broth	Low risk	12/08/2015
DCM	MV063	Sabouraud Dextrose HiVeg™ Agar	Low risk	20/12/2012
DCM	MV286	Sabouraud Dextrose HiVeg™ Agar Base, Modified	Low risk	20/12/2012
DCM	MV033	Sabouraud Dextrose HiVeg™ Broth (Sabouraud Liquid HiVeg™ Medium)	Low risk	20/12/2012
DCM	M1313	Sabouraud Dextrose Maltose Agar	Low risk	20/12/2012
DCM	M1460	Sabouraud Dextrose Maltose Broth	Low risk	20/12/2012
DCM	MV1313	Sabouraud Dextrose Maltose HiVeg™ Agar	Low risk	20/12/2012
DCM	MCD013	Sabouraud Fluid HiCynth™ Medium	Low risk	12/08/2015
DCM	M1472	Sabouraud Glucose Agar Base w/ Antibiotics	Low risk	20/12/2012
DCM	M062	Sabouraud Maltose Agar	Low risk	20/12/2012
DCM	M064	Sabouraud Maltose Broth	Low risk	20/12/2012
DCM	MV062	Sabouraud Maltose HiVeg™ Agar	Low risk	20/12/2012
DCM	MV064	Sabouraud Maltose HiVeg™ Broth	Low risk	20/12/2012
DCM	M844	Saccharose Broth	Low risk	20/12/2012
DCM	M1619	Sakazakii DHL Agar	Low risk	20/12/2012
DCM	M942	Saline Agar	Low risk	20/12/2012
DCM	M1778	Saline Lysine Decarboxylase Medium	Low risk	20/12/2012
DCM	M1633	Salmonella Agar (HiCrome™ RajHans Medium)	Low risk	20/12/2012
DCM	M1634	Salmonella Agar, Modified (HiCrome™ RajHans Medium, Modified)	Low risk	20/12/2012
DCM	M573	Salmonella Agar, ONOZ	Low risk	20/12/2012
DCM	M1078	Salmonella Differential Agar (Twin Pack) (RajHans Medium)	Low risk	20/12/2012
DCM	M1082	Salmonella Differential Agar, Modified (Twin Pack)	Low risk	20/12/2012
DCM	MCD1078	Salmonella Differential HiCynth™ Agar (Twin Pack)	Low risk	25/08/2016
DCM	MV1078	Salmonella Differential HiVeg™ Agar (RajHans HiVeg™ Medium)	Low risk	20/12/2012

		(Twin Pack)		
DCM	MV1082	Salmonella Differential HiVeg™ Agar, Modified (Twin Pack)	Low risk	20/12/2012
DCM	MV573	Salmonella HiVeg™ Agar, ONOZ	Low risk	20/12/2012
DCM	M1767	Salt Agar, Modified	Low risk	20/12/2012
DCM	M1290	Salt Broth, Modified	Low risk	20/12/2012
DCM	M155	Salt M Broth	Low risk	20/12/2012
DCM	M821	Salt Polymyxin Broth Base	Low risk	20/12/2012
DCM	MV821	Salt Polymyxin HiVeg™ Broth Base	Low risk	20/12/2012
DCM	M1276	Sauton's Fluid Medium Base	Low risk	20/12/2012
DCM	M1535	SBG Enrichment Broth (Twin Pack)	Low risk	20/12/2012
DCM	M291	Schaedler Agar	Low risk	20/12/2012
DCM	M292	Schaedler Broth	Low risk	20/12/2012
DCM	MV291	Schaedler HiVeg™ Agar	Low risk	20/12/2012
DCM	MV292	Schaedler HiVeg™ Broth	Low risk	20/12/2012
DCM	M1882	Selective Broth for MRSA	Low risk	20/12/2012
DCM	M052	Selenite Broth (Selenite F Broth) (Twin Pack)	Low risk	20/12/2012
DCM	M970	Selenite Broth Base w/o Biselenite	Low risk	20/12/2012
DCM	M1079	Selenite Cystine Broth Base w/o Biselenite	Low risk	20/12/2012
DCM	M1536	Selenite F Broth w/ Dulcitol (Twin Pack)	Low risk	20/12/2012
DCM	M1534	Selenite Mannitol Broth (Twin Pack)	Low risk	20/12/2012
DCM	M1321	Semisolid LM Medium	Low risk	20/12/2012
DCM	M1282	Semisolid Rappaport Vassiliadis Medium, Modified	Low risk	22/04/2019
DCM	M1998	Semisolid RV Medium w/ 0.9% Agar	Low risk	25/08/2016
DCM	MV296	Sensitivity Test HiVeg™ Medium	Low risk	20/12/2012
DCM	M296	Sensitivity Test Medium	Low risk	20/12/2012
DCM	M1301	Sheep Blood Agar Base	Low risk	20/12/2012
DCM	M1739	Shepard's Differential Agar Base	Low risk	20/12/2012
DCM	M411	Simmons Agar Base	Low risk	20/12/2012
DCM	M099	Simmons Citrate Agar	Low risk	20/12/2012
DCM	M099S	Simmons Citrate Agar	Low risk	20/12/2012
DCM	M612A	Slanetz and Bartley Medium w/o TTC	Low risk	10/11/2020
DCM	M5296	SM Tryptone Glucose Glycerin Medium	Low risk	25/11/2017
DCM	M960	Smibert's Semisolid Brucella Medium	Low risk	20/12/2012
DCM	M106	Snyder Test Agar	Low risk	20/12/2012
DCM	MV106	Snyder Test HiVeg™ Agar	Low risk	20/12/2012
DCM	M767	Sodium Azide Crystal Violet Blood Agar Base	Low risk	20/12/2012
DCM	M1079B	Sodium Biselenite	Low risk	22/04/2019
DCM	M298	Sorbitol Agar (MacConkey Sorbitol Agar)	Low risk	20/12/2012
DCM	MV298	Sorbitol HiVeg™ Agar (MacConkey Sorbitol HiVeg™ Agar)	Low risk	20/12/2012
DCM	M299	Sorbitol Iron Agar	Low risk	20/12/2012
DCM	MV299	Sorbitol Iron HiVeg™ Agar	Low risk	20/12/2012
DCM	M935	Soya Peptone Yeast Extract Agar	Low risk	20/12/2012
DCM	M1286	Soyabean Bile Broth Base	Low risk	20/12/2012
DCM	M290	Soyabean Casein Digest Agar (Tryptone Soya Agar)	Low risk	22/04/2019
DCM	M109	Soyabean Casein Digest Agar w/ Yeast Extract and Hemin (Tryptone Soya Agar w/ Yeast Extract and Hemin)	Low risk	20/12/2012

DCM	M011	Soyabean Casein Digest Medium (Tryptone Soya Broth)	Low risk	22/04/2019
DCM	M323	Soyabean Casein Digest Medium w/ 0.1% Agar (Tryptone Soya Broth w/ 0.1% Agar)	Low risk	20/12/2012
DCM	M207	Soyabean Casein Digest Medium w/ Yeast Extract and Ferric pyrophosphate	Low risk	20/12/2012
DCM	M322	Soyabean Casein Digest Medium w/o Dextrose (Tryptone SoyaBroth w/o Dextrose)	Low risk	28/04/2017
DCM	MV1286	Soyabean HiVeg™ Broth Base	Low risk	20/12/2012
DCM	MV011	Soyabean HiVeg™ Medium	Low risk	22/04/2019
DCM	MV323	Soyabean HiVeg™ Medium w/ 0.1% Agar (Tryptone Soya HiVeg™ Broth w/ 0.1% Agar)	Low risk	20/12/2012
DCM	MV207	Soyabean HiVeg™ Medium w/ Yeast Extract and Ferric pyrophosphate	Low risk	20/12/2012
DCM	MV290	SoyabeanHiVeg™ Agar	Low risk	22/04/2019
DCM	MH011	Soybean Casein Digest Medium (Casein Soybean Digest Broth)	Low risk	22/04/2019
DCM	MH290	Soybean-Casein Digest Agar (Casein Soyabean Digest Agar)	Low risk	22/04/2019
DCM	M211	Special Infusion Agar	Low risk	20/12/2012
DCM	MV211	Special Infusion Agar, HiVeg™	Low risk	20/12/2012
DCM	M1613	Special YM Medium	Low risk	20/12/2012
DCM	M300	Specimen Preservative Medium Base (SP Hajna)	Low risk	20/12/2012
DCM	M445	Spirit Blue Agar	Low risk	20/12/2012
DCM	MV445	Spirit Blue HiVeg™ Agar	Low risk	20/12/2012
DCM	M412	Spirolate Broth, OMATA	Low risk	20/12/2012
DCM	MV412	Spirolate HiVeg™ Broth, OMATA	Low risk	20/12/2012
DCM	MCD108	SS HiCynth™ Agar (Salmonella Shigella HiCynth™ Agar)	Low risk	12/08/2015
DCM	M108	SS Agar (Salmonella Shigella Agar)	Low risk	20/12/2012
DCM	M108D	SS Agar (Salmonella Shigella Agar)	Low risk	16/12/2017
DCM	M1979R	SS Agar Modified (w/sucrose)	Low risk	25/08/2016
DCM	M1979	SS Agar w/sucrose	Low risk	20/12/2012
DCM	M1032	SS Agar, Modified	Low risk	20/12/2012
DCM	MV108	SS HiVeg™ Agar (Salmonella Shigella HiVeg™ Agar)	Low risk	20/12/2012
DCM	M1959	SS Selective Agar, Improved	Low risk	20/12/2012
DCM	M1703	SSDC agar	Low risk	20/12/2012
DCM	M1608	β-Streptococcus Selective Agar Base	Low risk	20/12/2012
DCM	M675	Staib's Medium (Bird Seed Agar)	Low risk	20/12/2012
DCM	M883	Standard Infusion Agar	Low risk	20/12/2012
DCM	M883	Standard Infusion Agar	Low risk	20/12/2012
DCM	MV883	Standard Infusion Agar, HiVeg™	Low risk	20/12/2012
DCM	MV883	Standard Infusion Agar, HiVeg™	Low risk	20/12/2012
DCM	M116	Standard Nutrient Broth	Low risk	20/12/2012
DCM	MV116	Standard Nutrient HiVeg™ Broth	Low risk	20/12/2012
DCM	M578	Standard Staphylococcus Broth	Low risk	20/12/2012
DCM	MV578	Standard Staphylococcus HiVeg™ Broth	Low risk	20/12/2012
DCM	M156	Staphylococcus Agar No. 110 w/ Azide	Low risk	20/12/2012
DCM	M521	Staphylococcus Agar No.110	Low risk	20/12/2012
DCM	MV521	Staphylococcus HiVeg™ Agar No. 110	Low risk	20/12/2012
DCM	M1965	Stenotrophomonas Selective Agar Base	Low risk	20/12/2012

DCM	M1840R	Streptococcus Agalactiae Selective Agar Base (HiCrome™ Strep B Selective Agar Base)	Low risk	30/10/2018
DCM	M465	Streptococcus Enrichment Broth (SE Broth)	Low risk	20/12/2012
DCM	MV465	Streptococcus Enrichment HiVeg™ Broth (SE HiVeg™ Broth)	Low risk	20/12/2012
DCM	M304	Streptococcus Selection Agar	Low risk	20/12/2012
DCM	M303	Streptococcus Selection Broth	Low risk	20/12/2012
DCM	MV304	Streptococcus Selection HiVeg™ Agar	Low risk	20/12/2012
DCM	MV303	Streptococcus Selection HiVeg™ Broth	Low risk	20/12/2012
DCM	M1735	Stuart Medium w/o Methylene Blue with Charcoal	Low risk	20/12/2012
DCM	M306	Stuart Transport Medium (Transport Medium, Stuart)	Low risk	20/12/2012
DCM	M1131	Stuart Transport Medium w/o Methylene Blue	Low risk	20/12/2012
DCM	M1203	Stuart Transport Medium w/o Sodium Glycerophosphate	Low risk	20/12/2012
DCM	M308	Sulpha Sensitivity Test Agar	Low risk	20/12/2012
DCM	MV837	T.S.C./S.F.P. HiVeg™ Agar Base	Low risk	20/12/2012
DCM	M100	TB Broth Base	Low risk	20/12/2012
DCM	M034	TB Broth Base w/o Tween 80	Low risk	20/12/2012
DCM	MV100	TB HiVeg™ Broth Base	Low risk	20/12/2012
DCM	MV034	TB HiVeg™ Broth Base w/o Tween 80	Low risk	20/12/2012
DCM	M189	TCBS Agar	Low risk	20/12/2012
DCM	M870	TCBS Agar (Selective)	Low risk	20/12/2012
DCM	M870A	TCBS Agar, Modified	Low risk	20/12/2012
DCM	MCD870	TCBS HiCynth™ Agar (Selective)	Low risk	25/08/2016
DCM	MV189	TCBS HiVeg™ Agar	Low risk	20/12/2012
DCM	MV870	TCBS HiVeg™ Agar (Selective)	Low risk	20/12/2012
DCM	M529	Teepol Broth (Twin Pack)	Low risk	10/11/2020
DCM	MV529	Teepol HiVeg™ Broth (Twin Pack)	Low risk	10/11/2020
DCM	M1260	Tellurite Blood Agar Base	Low risk	20/12/2012
DCM	M448	Tellurite Glycine Agar Base	Low risk	20/12/2012
DCM	M616	Tergitol-7 Agar Base	Low risk	20/12/2012
DCM	M850	Tergitol-7 Agar H	Low risk	20/12/2012
DCM	M851	Tergitol-7 Broth	Low risk	20/12/2012
DCM	MV616	Tergitol-7 HiVeg™ Agar Base	Low risk	20/12/2012
DCM	MV850	Tergitol-7 HiVeg™ Agar H	Low risk	20/12/2012
DCM	MV851	Tergitol-7 HiVeg™ Broth	Low risk	20/12/2012
DCM	M032	Tetrathionate Broth Base (w/o Iodine and BG)	Low risk	20/12/2012
DCM	MV032	Tetrathionate HiVeg™ Broth Base (w/o Iodine and BG)	Low risk	20/12/2012
DCM	MV413	Thayer Martin HiVeg™ Medium Base	Low risk	20/12/2012
DCM	M413	Thayer Martin Medium Base	Low risk	20/12/2012
DCM	M610	Thiogel Medium	Low risk	20/12/2012
DCM	M608	Thioglycollate Agar	Low risk	20/12/2012
DCM	M010	Thioglycollate Broth, Alternative (Alternative Thioglycollate Medium)(NIH Thioglycollate Broth)	Low risk	20/12/2012
DCM	MCD010	Thioglycollate HiCynth™ Broth, Alternative (Alternative Thioglycollate HiCynth™ Medium)(NIH Thioglycollate HiCynth™ Broth)	Low risk	12/08/2015
DCM	MV608	Thioglycollate HiVeg™ Agar	Low risk	20/12/2012
DCM	MV010	Thioglycollate HiVeg™ Broth, Alternative (Alternative	Low risk	20/12/2012

		Thioglycollate HiVeg™ Medium)(NIH HiVeg™ Thioglycollate Broth)		
DCM	MV195	Thioglycollate HiVeg™ Medium, Linden (Brewer Thioglycollate HiVeg™ Medium, Modified)	Low risk	20/12/2012
DCM	M979	Thioglycollate Medium w/ Hemin and Vitamin K	Low risk	20/12/2012
DCM	M195	Thioglycollate Medium, Linden (Brewer Thioglycollate Medium, Modified)	Low risk	20/12/2012
DCM	M853	Thiol Broth	Low risk	20/12/2012
DCM	MV853	Thiol HiVeg™ Broth	Low risk	20/12/2012
DCM	MV852	Thiol HiVeg™ Medium	Low risk	20/12/2012
DCM	M852	Thiol Medium	Low risk	20/12/2012
DCM	M314	Tinsdale Agar Base	Low risk	20/12/2012
DCM	MV314	Tinsdale HiVeg™ Agar Base	Low risk	20/12/2012
DCM	M313	Todd Hewitt Broth	Low risk	20/12/2012
DCM	MV313	Todd Hewitt HiVeg™ Broth	Low risk	20/12/2012
DCM	M879	Tomato Juice Agar, Special	Low risk	20/12/2012
DCM	MV879	Tomato Juice HiVeg™ Agar, Special	Low risk	20/12/2012
DCM	M1149	Transgrow Medium Base	Low risk	20/12/2012
DCM	M315	Transport Charcoal Medium	Low risk	20/12/2012
DCM	M1487	Transport Liquid Medium	Low risk	20/12/2012
DCM	M306	Transport Medium Stuart	Low risk	20/12/2012
DCM	M202	Transport Medium w/o Charcoal	Low risk	20/12/2012
DCM	M684	Transport Medium, Amies w/o Charcoal	Low risk	20/12/2012
DCM	M665	Trichomonas Agar Base	Low risk	20/12/2012
DCM	M1204	Trichomonas Broth Base No. 2	Low risk	20/12/2012
DCM	M305	Trichomonas Broth Base, Kupferberg	Low risk	20/12/2012
DCM	MV665	Trichomonas HiVeg™ Agar Base	Low risk	20/12/2012
DCM	MV305	Trichomonas HiVeg™ Broth Base, Kupferberg (Kupferberg Trichomonas HiVeg™ Broth Base)	Low risk	20/12/2012
DCM	MV460	Trichomonas Modified CPLM HiVeg™ Medium Base	Low risk	20/12/2012
DCM	M460	Trichomonas Modified CPLM Medium Base	Low risk	20/12/2012
DCM	M531	Trichophyton Agar-1	Low risk	20/12/2012
DCM	M532	Trichophyton Agar-2	Low risk	20/12/2012
DCM	M533	Trichophyton Agar-3	Low risk	20/12/2012
DCM	M534	Trichophyton Agar-4	Low risk	20/12/2012
DCM	M535	Trichophyton Agar-5	Low risk	20/12/2012
DCM	M536	Trichophyton Agar-6	Low risk	20/12/2012
DCM	M152	Trichophyton Agar-7	Low risk	20/12/2012
DCM	MV531	Trichophyton HiVeg™ Agar-1	Low risk	20/12/2012
DCM	MV532	Trichophyton HiVeg™ Agar-2	Low risk	20/12/2012
DCM	MV533	Trichophyton HiVeg™ Agar-3	Low risk	20/12/2012
DCM	MV534	Trichophyton HiVeg™ Agar-4	Low risk	20/12/2012
DCM	MV535	Trichophyton HiVeg™ Agar-5	Low risk	20/12/2012
DCM	M021	Triple Sugar Iron Agar	Low risk	22/04/2019
DCM	MV021	Triple Sugar Iron HiVeg™ Agar	Low risk	22/04/2019
DCM	M1028	Tryptic Digest Broth(Field's Tryptic Digest Broth)	Low risk	20/12/2012
DCM	MV1028	Tryptic Digest Broth, HiVeg™ (Field's Tryptic Digest Broth, HiVeg™)	Low risk	20/12/2012

DCM	M1591	Tryptone Bile Glucuronic Agar (TBX Agar)	Low risk	22/04/2019
DCM	M463	Tryptone Broth (Tryptone Water)	Low risk	22/04/2019
DCM	MV364	Tryptone Nitrate HiVeg™ Medium	Low risk	20/12/2012
DCM	M364	Tryptone Nitrate Medium	Low risk	20/12/2012
DCM	M969	Tryptone Peptone Glucose Yeast Extract Broth Base w/o Trypsin	Low risk	20/12/2012
DCM	MV969	Tryptone Peptone Glucose Yeast Extract HiVeg™ Broth Base w/o Trypsin	Low risk	20/12/2012
DCM	M323	Tryptone Soya Broth w/ 0.1% Agar	Low risk	20/12/2012
DCM	MV323	Tryptone Soya HiVeg™ Broth w/ 0.1% Agar	Low risk	20/12/2012
DCM	M1948	Tryptone Soya Serum Bacitracin Vancomycin Agar (TSBV)	Low risk	08/12/2017
DCM	M1217	Tryptone Sucrose Tetrazolium Agar Base (TSTA)	Low risk	20/12/2012
DCM	M1056	Tryptone Tellurite Agar Base	Low risk	20/12/2012
DCM	MV463	Tryptone Water, HiVeg™ (Tryptone Broth, HiVeg™)	Low risk	22/04/2019
DCM	M1975	Tryptone yeast extract cystine w/sucrose and w/O bacitracin agar (TYCSB)	Low risk	20/12/2012
DCM	M2046I	Tryptone Yeast Sodium Sulphite Agar Base	Low risk	10/11/2020
DCM	M538	Tryptose Agar	Low risk	20/12/2012
DCM	M996	Tryptose Agar w/ Thiamine HCl	Low risk	20/12/2012
DCM	MV996	Tryptose Agar w/ Thiamine HCl, HiVeg™	Low risk	20/12/2012
DCM	MV538	Tryptose Agar, HiVeg™	Low risk	20/12/2012
DCM	M097	Tryptose Blood Agar Base	Low risk	20/12/2012
DCM	M450	Tryptose Blood Agar Base w/ Yeast Extract	Low risk	20/12/2012
DCM	MV450	Tryptose Blood Agar Base w/ Yeast Extract, HiVeg™	Low risk	20/12/2012
DCM	MV097	Tryptose Blood Agar Base, HiVeg™	Low risk	20/12/2012
DCM	M177	Tryptose Broth	Low risk	20/12/2012
DCM	M997	Tryptose Broth w/ Thiamine HCl	Low risk	20/12/2012
DCM	MV177	Tryptose Broth, HiVeg™	Low risk	20/12/2012
DCM	M5393	Tryptose Phosphate Broth	Low risk	30/10/2018
DCM	M093	Tryptose Phosphate Broth	Low risk	20/12/2012
DCM	MV093	Tryptose Phosphate Broth, HiVeg™	Low risk	20/12/2012
DCM	M1532	Tryptose Phosphate Broth, Modified	Low risk	20/12/2012
DCM	M093G	Tryptose Phosphate Broth, Sterile	Low risk	22/04/2019
DCM	M2060	Tryptose Serum Agar Base	Low risk	10/11/2020
DCM	M2019	Tryptose Serum Broth Base (Modified Newin	Low risk	25/08/2016
DCM	M837	Tryptose Sulphite Cycloserine (T.S.C. / S.F.P.) Agar Base (Perfringens Agar Base)	Low risk	20/12/2012
DCM	M1780	TS Saline Agar (Triple Sugar Saline Iron Agar)	Low risk	20/12/2012
DCM	M2016	TSB w/6.5% NaCl	Low risk	25/08/2016
DCM	M1220	TTC Broth Base (Triclosan Ticarcillin Chlorate Broth)	Low risk	20/12/2012
DCM	MV1220	TTC HiVeg™ Broth Base	Low risk	20/12/2012
DCM	M1912	Tween Esterase Test Agar Base	Low risk	20/12/2012
DCM	M1817	Universal Fastidious Culture Agar	Low risk	20/12/2012
DCM	M1818	Universal Fastidious Culture Broth	Low risk	10/11/2020
DCM	M112S	Urea Agar Base (Christensen)	Low risk	20/12/2012
DCM	M112	Urea Agar Base (Christensen) (Autoclavable)	Low risk	20/12/2012
DCM	M112A	Urea Agar Base (Filter Sterilizable) (w/o Agar)	Low risk	20/12/2012

DCM	M112I	Urea Agar Base, Christensen	Low risk	20/12/2012
DCM	M111A	Urea Broth (Filter Sterilizable)	Low risk	20/12/2012
DCM	M111	Urea Broth Base	Low risk	20/12/2012
DCM	MV112	Urea HiVeg™ Agar Base (Christensen) (Autoclavable)	Low risk	20/12/2012
DCM	M1784I	Urea Indole Broth, Modified	Low risk	20/12/2012
DCM	M1784	Urea Indole Medium	Low risk	20/12/2012
DCM	M328	V Infusion Agar	Low risk	20/12/2012
DCM	M329	V Infusion Broth	Low risk	20/12/2012
DCM	M1057	Vaginalis Agar Base	Low risk	20/12/2012
DCM	M1763	Vancomycin Resistant Enterococci (VRE) Agar Base	Low risk	20/12/2012
DCM	M1762	Vancomycin Resistant Enterococci (VRE) Broth Base	Low risk	20/12/2012
DCM	M416	Veillonella Agar Base	Low risk	20/12/2012
DCM	MV416	Veillonella HiVeg™ Agar Base	Low risk	20/12/2012
DCM	M820	Vibrio Agar	Low risk	20/12/2012
DCM	MV820	Vibrio HiVeg™ Agar	Low risk	20/12/2012
DCM	M049	Violet Red Bile Agar	Low risk	28/04/2017
DCM	M049A	Violet Red Bile Agar	Low risk	16/12/2017
DCM	M1684	Violet Red Bile Agar w/ Glucose and Lactose	Low risk	22/04/2019
DCM	MH581	Violet Red Bile Glucose Agar	Low risk	22/04/2019
DCM	M581	Violet Red Bile Glucose Agar w/o Lactose	Low risk	25/11/2017
DCM	MCD581	Violet Red Bile Glucose HiCynth™ Agar w/o Lactose	Low risk	04/07/2018
DCM	MV581	Violet Red Bile Glucose HiVeg™ Agar w/o Lactose	Low risk	04/07/2018
DCM	MCD049	Violet Red Bile HiCynth™ Agar	Low risk	28/04/2017
DCM	MV049	Violet Red HiVeg™ Agar	Low risk	28/04/2017
DCM	MCD023	Vogel Johnson HiCynth™ Agar Base w/o Tellurite (V.J. HiCynth™ Agar)	Low risk	12/08/2015
DCM	M023	Vogel-Johnson Agar Base w/o Tellurite (V.J. Agar)	Low risk	20/12/2012
DCM	MU023	Vogel-Johnson Agar Medium	Low risk	20/12/2012
DCM	MV023	Vogel-Johnson HiVeg™ Agar Base w/o Tellurite (V. J. HiVeg™ Agar)	Low risk	20/12/2012
DCM	MV662	VP HiVeg™ Medium	Low risk	20/12/2012
DCM	M662	VP Medium	Low risk	20/12/2012
DCM	M626	Wagatsuma Agar Base	Low risk	20/12/2012
DCM	MV626	Wagatsuma HiVeg™ Agar Base	Low risk	20/12/2012
DCM	M1059	Wayne Sulphatase Agar Base	Low risk	20/12/2012
DCM	M832	Wilkins Chalgren Anaerobic Agar Base	Low risk	20/12/2012
DCM	M863	Wilkins Chalgren Anaerobic Broth Base	Low risk	20/12/2012
DCM	MV832	Wilkins Chalgren Anaerobic HiVeg™ Agar Base	Low risk	20/12/2012
DCM	MV863	Wilkins Chalgren Anaerobic HiVeg™ Broth Base	Low risk	25/08/2016
DCM	M331	Wilson Blair Agar Base	Low risk	20/12/2012
DCM	M332	Wilson Blair Agar w/ BG	Low risk	20/12/2012
DCM	MV331	Wilson Blair HiVeg™ Agar Base	Low risk	20/12/2012
DCM	MV332	Wilson Blair HiVeg™ Agar w/ BG	Low risk	20/12/2012
DCM	MV031	XLD HiVeg™ Agar	Low risk	20/12/2012
DCM	M1147	XLT4 Agar Base	Low risk	20/12/2012
DCM	MV1147	XLT4 HiVeg™ Agar Base	Low risk	20/12/2012

DCM	M336	Xylose Lysine Agar Base	Low risk	20/12/2012
DCM	M031	Xylose Lysine Deoxycholate Agar (XLD Agar)	Low risk	20/12/2012
DCM	MCD031	Xylose Lysine Deoxycholate HiCynth™ Agar (XLD HiCynth™ Agar)	Low risk	12/08/2015
DCM	MH031	Xylose-Lysine-Deoxycholate Agar	Low risk	22/04/2019
DCM	M424	Yeast Malt Agar (YM Agar) (ISP Medium No. 2)	Low risk	22/04/2019
DCM	M425	Yeast Malt Broth (YM Broth)	Low risk	20/12/2012
DCM	MV424	Yeast Malt HiVeg™ Agar (YM HiVeg™ Agar)	Low risk	22/04/2019
DCM	MV425	Yeast Malt HiVeg™ Broth (YM HiVeg™ Broth)	Low risk	20/12/2012
DCM	M1421	YEP Agar	Low risk	30/10/2018
DCM	M1823	YEP Agar, Modified	Low risk	10/11/2020
DCM	M1367	Yersinia Enrichment Broth Base	Low risk	20/12/2012
DCM	M843	Yersinia Selective Agar Base	Low risk	20/12/2012
DCM	M1861	Yersinia Selective Broth Base	Low risk	20/12/2012
DCM	MV843	Yersinia Selective HiVeg™ Agar Base	Low risk	20/12/2012

DCM	EC211CR	BHI Agar (HiEncap™ water-soluble capsule)	Low risk	25/08/2016
DCM	EC211CR	BHI Agar (HiEncap™ water-soluble capsule)	Low risk	25/08/2016
DCM	EC210CR	BHI Broth (HiEncap™ water-soluble capsule)	Low risk	25/08/2016
DCM	EC210CR	BHI Broth (HiEncap™ water-soluble capsule)	Low risk	25/08/2016
DCM	EC073DR	Blood Agar Base (HiEncap™ water-soluble capsule)	Low risk	25/08/2016
DCM	EC073DR	Blood Agar Base (HiEncap™ water-soluble capsule)	Low risk	25/08/2016
DCM	EC1297ACR	HiCrome™ Candida Differential Agar (HiEncap™ water-soluble capsule)	Low risk	25/08/2016
DCM	EC1297ARDR	HiCrome™ Candida Differential Agar (HiEncap™ water-soluble capsule)	Low risk	25/08/2016
DCM	EC1297ACR	HiCrome™ Candida Differential Agar (HiEncap™ water-soluble capsule)	Low risk	25/08/2016
DCM	EC1297ADR	HiCrome™ Candida Differential Agar (HiEncap™ water-soluble capsule)	Low risk	25/08/2016
DCM	EC1297ARDR	HiCrome™ Candida Differential Agar (HiEncap™ water-soluble capsule)	Low risk	25/08/2016
DCM	EC1674CCLR	HiCrome™ MeReSa Agar Base (HiEncap™ water-soluble capsule)	Low risk	25/08/2016
DCM	EC1674CCLR	HiCrome™ MeReSa Agar Base (HiEncap™ water-soluble capsule)	Low risk	25/08/2016
DCM	EC1353CCLR	HiCrome™ UTI Agar (HiEncap™ water-soluble capsule)	Low risk	25/08/2016
DCM	EC1353CR	HiCrome™ UTI Agar (HiEncap™ water-soluble capsule)	Low risk	25/08/2016
DCM	EC1353DR	HiCrome™ UTI Agar (HiEncap™ water-soluble capsule)	Low risk	25/08/2016
DCM	EC1353CCLR	HiCrome™ UTI Agar (HiEncap™ water-soluble capsule)	Low risk	25/08/2016
DCM	EC1353CR	HiCrome™ UTI Agar (HiEncap™ water-soluble capsule)	Low risk	25/08/2016
DCM	EC1353DR	HiCrome™ UTI Agar (HiEncap™ water-soluble capsule)	Low risk	25/08/2016
DCM	EC1297ADR	HiCrome™ Candida Differential Agar (HiEncap™ water-soluble capsule)	Low risk	25/08/2016
DCM	EC211CCL	HiEncap™ BHI Agar (HiEncap™ Special Infusion Agar)	Low risk	12/08/2015
DCM	EC210D	HiEncap™ BHI Broth	Low risk	12/08/2015
DCM	EC210CCL	HiEncap™ BHI Broth	Low risk	12/08/2015
DCM	EC073D	HiEncap™ Blood Agar Base	Low risk	12/08/2015

DCM	EC073CCL	HiEncap™ Blood Agar Base	Low risk	12/08/2015
DCM	EC081CCL	HiEncap™ MacConkey Agar w/0.15% Bile Salt	Low risk	12/08/2015
DCM	EC082ACCL	HiEncap™ MacConkey Agar w/o CV, NaCl w/Bile Salts	Low risk	12/08/2015
DCM	EC173CCL	HiEncap™ Mueller Hinton Agar	Low risk	12/08/2015
DCM	EC173D	HiEncap™ Mueller Hinton Agar	Low risk	12/08/2015
DCM	EC1084CCL	HiEncap™ Mueller Hinton Agar No.2	Low risk	12/08/2015
DCM	EC1084D	HiEncap™ Mueller Hinton Agar No.2	Low risk	12/08/2015
DCM	EC391CCL	HiEncap™ Mueller Hinton Broth	Low risk	12/08/2015
DCM	EC391D	HiEncap™ Mueller Hinton Broth	Low risk	12/08/2015
DCM	EC001DR	HiEncap™ Nutrient Agar	Low risk	25/08/2016
DCM	EC001CCL	HiEncap™ Nutrient Agar	Low risk	12/08/2015
DCM	EC001D	HiEncap™ Nutrient Agar	Low risk	12/08/2015
DCM	EC001DR	HiEncap™ Nutrient Agar	Low risk	25/08/2016
DCM	EC002CCL	HiEncap™ Nutrient Broth	Low risk	12/08/2015
DCM	EC002D	HiEncap™ Nutrient Broth	Low risk	12/08/2015
DCM	EC002M	HiEncap™ Nutrient Broth	Low risk	12/08/2015
DCM	EC091D	HiEncap™ Plate Count Agar	Low risk	16/12/2017
DCM	EC091CCL	HiEncap™ Plate Count Agar	Low risk	16/12/2017
DCM	EC063CCL	HiEncap™ Sabouraud Dextrose Agar	Low risk	12/08/2015
DCM	EC033CCL	HiEncap™ Sabouraud Dextrose Broth	Low risk	12/08/2015
DCM	EC033D	HiEncap™ Sabouraud Dextrose Broth	Low risk	12/08/2015
DCM	EC173DR	Mueller Hinton Agar (HiEncap™ water-soluble capsule)	Low risk	25/08/2016
DCM	EC173DR	Mueller Hinton Agar (HiEncap™ water-soluble capsule)	Low risk	25/08/2016
DCM	EC1084DR	Mueller Hinton Agar No.2 (HiEncap™ water-soluble capsule)	Low risk	25/08/2016
DCM	EC1084DR	Mueller Hinton Agar No.2 (HiEncap™ water-soluble capsule)	Low risk	25/08/2016
DCM	EC391CR	Mueller Hinton Broth (HiEncap™ water-soluble capsule)	Low risk	25/08/2016
DCM	EC391CR	Mueller Hinton Broth (HiEncap™ water-soluble capsule)	Low risk	25/08/2016
DCM	EC001DR	Nutrient Agar (HiEncap™ water-soluble capsule)	Low risk	25/08/2016
DCM	EC001DR	Nutrient Agar (HiEncap™ water-soluble capsule)	Low risk	25/08/2016
DCM	EC002CR	Nutrient Broth (HiEncap™ water-soluble capsule)	Low risk	25/08/2016
DCM	EC002CR	Nutrient Broth (HiEncap™ water-soluble capsule)	Low risk	25/08/2016
DCM	EC063CCLR	Sabouraud Dextrose Agar (HiEncap™ water-soluble capsule)	Low risk	25/08/2016
DCM	EC063CCLR	Sabouraud Dextrose Agar (HiEncap™ water-soluble capsule)	Low risk	25/08/2016
DCM	EC033CR	Sabouraud Dextrose Broth (HiEncap™ water-soluble capsule)	Low risk	25/08/2016
DCM	EC033CR	Sabouraud Dextrose Broth (HiEncap™ water-soluble capsule)	Low risk	25/08/2016
DCM	EC031CCLR	Xylose Deoxycholate Agar (XLD Agar) (HiEncap™ water-soluble capsule)	Low risk	25/08/2016
DCM	EC031CCLR	Xylose Deoxycholate Agar (XLD Agar) (HiEncap™ water-soluble capsule)	Low risk	25/08/2016

DCM	GM618	Alkaline Peptone Water, Granulated	Low Risk	12/08/2015
DCM	GM491	Anaerobic Agar (Brewer) , Granulated	Low Risk	12/08/2015
DCM	GM672	Asparagine Broth (Coccidioidin and Histoplasmin Broth) , Granulated	Low Risk	12/08/2015
DCM	GM043	Baird Parker Agar Base,Granulated	Low Risk	12/08/2015
DCM	GM1091	Baird Staphylococcus Enrichment Broth Base, Granulated	Low risk	10/11/2020
DCM	GM211	BHI Agar (Special Infusion Agar) , Granulated	Low Risk	12/08/2015
DCM	GM210	BHI Broth, Granulated	Low Risk	12/08/2015
DCM	GM217	Bi.G.G.Y. Agar (Nickerson Medium) , Granulated	Low Risk	12/08/2015
DCM	GM027	Bismuth Sulphite Agar, Granulated	Low Risk	12/08/2015
DCM	GM073	Blood Agar Base (Infusion Agar) , Granulated	Low Risk	12/08/2015
DCM	GM073R	Blood Agar Base (Infusion Agar) w/o Blood, Granulated	Low risk	25/08/2016
DCM	GM834A	Blood Agar Base No. 2 w/ 1.2% Agar, Granulated	Low Risk	12/08/2015
DCM	GM016A	Brilliant Green Agar Base w/ 1.2% Agar, Granulated	Low Risk	12/08/2015
DCM	GM971	Brilliant Green Agar Base w/ Phosphates, Granulated	Low risk	20/12/2012
DCM	GM074	Brucella Agar Base, Granulated	Low Risk	12/08/2015
DCM	GM614	Buffered Peptone Water , Granulated	Low risk	22/04/2019
DCM	GM1275	Buffered Peptone Water w/ NaCl, Granulated	Low Risk	12/08/2015
DCM	GMH1275	Buffered Sodium Chloride-Peptone Solution pH 7.0 , Granulated	Low risk	22/04/2019
DCM	GM792	C.L.E.D. Agar w/ Bromo Thymol Blue, Granulated	Low Risk	12/08/2015
DCM	GMH024	Cetrimide Agar , Granulated	Low risk	22/04/2019
DCM	GM024	Cetrimide Agar Base, Granulated	Low Risk	12/08/2015
DCM	GM497	Clostridial Agar, Granulated	Low risk	25/08/2016
DCM	GMH144	Columbia Agar , Granulated	Low risk	22/04/2019
DCM	GM144	Columbia Blood Agar Base, Granulated	Low Risk	12/08/2015
DCM	GM188	D.T.M. Agar Base (Dermatophyte Test Agar Base) , Granulated	Low Risk	12/08/2015
DCM	GM030	Deoxycholate Agar, Granulated	Low Risk	12/08/2015
DCM	GM065	Deoxycholate Citrate Agar, Granulated	Low Risk	12/08/2015
DCM	GM286	Dextrose Agar Base, Emmons (Sabouraud Dextrose Agar Base, Modified) , Granulated	Low Risk	12/08/2015
DCM	GM1129	Dichloran Glycerol Medium Base , Granulated	Low risk	22/04/2019
DCM	GM1603	Differential Reinforced Clostridial Agar,Granulated	Low risk	10/11/2020
DCM	GM127	EC Broth, Granulated	Low Risk	12/08/2015
DCM	GM317	EMB Agar, Granulated	Low Risk	12/08/2015
DCM	GM022	EMB Agar, Levine, Granulated	Low Risk	12/08/2015
DCM	GM029	Endo Agar, Granulated	Low Risk	12/08/2015
DCM	GM029R	Endo Agar, Special	Low risk	25/08/2016
DCM	GM1075	Endo Agar,Modified, Granulated	Low Risk	12/08/2015
DCM	GMH287	Enterobacteria Enrichment Broth, Mossel , Granulated	Low risk	22/04/2019
DCM	GM013	Fluid Sabouraud Medium (Sabouraud Medium,Fluid) , Granulated	Low Risk	12/08/2015
DCM	GM025	Fluid Selenite Cystine Medium (Selenite Cystine Broth) (Twin Pack) , Granulated	Low Risk	12/08/2015
DCM	GM032	Fluid Tetrathionate Medium w/o Iodine and BG (Tetrathionate Broth Base w/o Iodine and BG) , Granulated	Low Risk	12/08/2015

DCM	GM009	Fluid Thioglycollate medium (Thioglycollate medium Fluid) , Granulated	Low risk	22/04/2019
DCM	GM434	GC Agar Base,Granulated	Low Risk	04/07/2018
DCM	GM070	Glucose Phosphate Broth (Buffered Glucose Broth) , Granulated	Low risk	12/08/2015
DCM	GM070R	Glucose Phosphate Broth (Buffered Glucose Broth) , Granulated	Low risk	04/07/2018
DCM	GMV070	Glucose Phosphate HiVeg™ Broth (Buffered Glucose HiVeg™ Broth) , Granulated	Low risk	20/12/2012
DCM	GM242	GN Broth, Hajna, Granulated	Low Risk	12/08/2015
DCM	GM467	Hektoen Enteric Agar, Granulated	Low Risk	12/08/2015
DCM	GM1297A	HiCrome™ Candida Differential Agar, Granulated	Low Risk	12/08/2015
DCM	GM1353	HiCrome™ UTI Agar, Granulated	Low Risk	12/08/2015
DCM	GM1007	KF Streptococcus Agar Base w/ BCP, Granulated	Low Risk	12/08/2015
DCM	GM1232	Kimmig Fungi Agar Base, Granulated	Low Risk	12/08/2015
DCM	GM1543	King's Medium A Base, Granulated	Low Risk	12/08/2015
DCM	GM078	Kligler Iron Agar, Granulated	Low Risk	12/08/2015
DCM	GM641	Lactobacillus MRS Agar (MRS Agar) , Granulated	Low Risk	12/08/2015
DCM	GM369	Lactobacillus MRS Broth (MRS Broth) , Granulated	Low Risk	12/08/2015
DCM	GM1003	Lactose Broth , Granulated	Low risk	22/04/2019
DCM	GM080	Lauryl Sulphate Broth (Lauryl Tryptose Broth) , Granulated	Low risk	22/04/2019
DCM	GM1380	Leifson Agar, Granulated	Low Risk	12/08/2015
DCM	GM890A	Listeria Enrichment Medium Base (UVM) , Granulated	Low Risk	12/08/2015
DCM	GM1064	Listeria Identification Agar Base (PALCAM) , Granulated	Low risk	22/04/2019
DCM	GM1064	Listeria Identification Agar Base (PALCAM), Granulated	Low Risk	22/04/2019
DCM	GM1090	Listeria Identification Broth Base (PALCAM) , Granulated	Low risk	22/04/2019
DCM	GM1090	Listeria Identification Broth Base (PALCAM), Granulated	Low Risk	22/04/2019
DCM	GM1145	Listeria Oxford Medium Base, Granulated	Low Risk	12/08/2015
DCM	GM889	Listeria Selective Broth Base, Granulated	Low Risk	12/08/2015
DCM	GM1865	Listeria Selective Enrichment Broth , Granulated	Low risk	22/04/2019
DCM	GM1001	LM Agar, Granulated	Low Risk	12/08/2015
DCM	GM162	Lowenstein Jensen Medium Base (L.J. Medium) , Granulated	Low Risk	12/08/2015
DCM	GMH081	MacConkey Agar , Granulated	Low risk	22/04/2019
DCM	GM081	MacConkey Agar w/0.15% Bile Salts,CV and NaCL, Granulated	Low Risk	12/08/2015
DCM	GM082A	MacConkey Agar w/o CV,NaCL w/0.5% Bile Salts, Granulated	Low Risk	12/08/2015
DCM	GM082	MacConkey Agar w/o CV,NaCLw/0.5% Sodium Taurocholate, Granulated	Low Risk	12/08/2015
DCM	GMH083	MacConkey Broth , Granulated	Low risk	22/04/2019
DCM	GM083	MacConkey Broth Purple w/BCP , Granulated	Low risk	22/04/2019
DCM	GM137	Malt Extract Agar Base (w/ Mycological Peptone) , Granulated	Low Risk	12/08/2015
DCM	GM255	Malt Extract Broth Base, Granulated	Low Risk	12/08/2015
DCM	GMH118	Mannitol Salt Agar , Granulated	Low risk	22/04/2019
DCM	GM118	Mannitol Salt Agar Base , Granulated	Low risk	12/08/2015
DCM	GM1030	Maximum Recovery Diluent , Granulated	Low risk	22/04/2019
DCM	GM1170	Modified Czapek Dox Agar, Granulated	Low risk	25/08/2016
DCM	GM1285	Modified EC Broth Base, Granulated	Low Risk	12/08/2015
DCM	GM1286I	Modified Soyabean Bile Broth Base , Granulated	Low risk	22/04/2019

DCM	GM1084	Mueller Hinton Agar No. 2, Granulated	Low Risk	12/08/2015
DCM	GM173	Mueller Hinton Agar, Granulated	Low Risk	12/08/2015
DCM	GM391	Mueller Hinton Broth, Granulated	Low Risk	12/08/2015
DCM	GM636	MYP Agar Base (Phenol Red Egg Yolk Polymyxin Agar Base) , Granulated	Low Risk	12/08/2015
DCM	GM1269	Nutrient Agar No.2 , Granulated	Low risk	12/08/2015
DCM	GM001	Nutrient Agar, Granulated	Low Risk	12/08/2015
DCM	GM002	Nutrient Broth, Granulated	Low Risk	12/08/2015
DCM	GM395	OF Basal Medium, Granulated	Low Risk	12/08/2015
DCM	GM933	Orange Serum Agar , Granulated	Low risk	22/04/2019
DCM	GM028	Peptone Water, Granulated	Low Risk	04/07/2018
DCM	GM837	Perfringens Agar Base (Tryptose Sulphite Cycloserine Agar Base) (T.S.C./S.F.P. Agar Base) , Granulated	Low Risk	12/08/2015
DCM	GM091	Plate Count Agar (Standard Methods Agar),Granulated	Low Risk	28/04/2017
DCM	GMH096	Potato Dextrose Agar , Granulated	Low risk	22/04/2019
DCM	GM096	Potato Dextrose Agar , Granulated	Low risk	22/04/2019
DCM	GM085	Pseudomonas Agar Base , Granulated	Low risk	22/04/2019
DCM	GM085	Pseudomonas Agar Base, Granulated	Low Risk	22/04/2019
DCM	GMH1491	Rappaport Vassiliadis Salmonella Enrichment Broth , Granulated	Low risk	22/04/2019
DCM	GM1491	Rappaport Vassiliadis Soya Broth (RVS Broth) , Granulated	Low Risk	12/08/2015
DCM	GMH443	Reinforced Medium for Clostridia , Granulated	Low risk	22/04/2019
DCM	GM149	Robinson's Cooked M Medium (R.C. Medium), Granulated	Low Risk	16/12/2017
DCM	GM130	Rogosa SL Agar, Granulated	Low Risk	12/08/2015
DCM	GM842	Rose Bengal Agar Base, Granulated	Low risk	12/08/2015
DCM	GM1067	Sabouraud Chloramphenicol Agar, Granulated	Low risk	25/08/2016
DCM	GM063	Sabouraud Dextrose Agar , Granulated	Low Risk	12/08/2015
DCM	GMH063	Sabouraud Dextrose Agar , Granulated	Low risk	22/04/2019
DCM	GM033	Sabouraud Dextrose Broth (Sabouraud Liquid Medium) , Granulated	Low Risk	12/08/2015
DCM	GMH033	Sabouraud Dextrose Broth , Granulated	Low risk	22/04/2019
DCM	GMV033	Sabouraud Dextrose HiVeg™ Broth (Sabouraud Liquid HiVeg™ Medium) , Granulated	Low Risk	12/08/2015
DCM	GM1313	Sabouraud Dextrose Maltose Agar, Granulated	Low Risk	12/08/2015
DCM	GM062	Sabouraud Maltose Agar, Granulated	Low Risk	12/08/2015
DCM	GM1619	Sakazakii DHL Agar, Granulated	Low Risk	12/08/2015
DCM	GM1078	Salmonella Differential Agar (Twin Pack), Raj Hans Medium (Twin Pack) , Granulated	Low Risk	12/08/2015
DCM	GM052	Selenite Broth (Selenite F Broth) (Twin Pack) , Granulated	Low Risk	12/08/2015
DCM	GM612A	Slanetz and Bartley Medium w/o TTC, Granulated	Low risk	10/11/2020
DCM	GM298R	Sorbitol Agar (Sorbitol MacConkey Agar)	Low risk	25/08/2016
DCM	GM290	Soyabean Casein Digest Agar (Tryptone Soya Agar) , Granulated	Low risk	22/04/2019
DCM	GM011	Soyabean Casein Digest Medium (Tryptone Soya Broth) , Granulated	Low risk	22/04/2019
DCM	GMH011	Soybean Casein Digest Medium (Casein Soybean Digest Broth) , Granulated	Low risk	22/04/2019
DCM	GMH290	Soybean-Casein Digest Agar (Casein Soyabean Digest Agar) , Granulated	Low risk	22/04/2019
DCM	GM108	SS Agar (Salmonella Shigella Agar) , Granulated	Low Risk	12/08/2015

DCM	GM189	TCBS Agar, Granulated	Low Risk	12/08/2015
DCM	GM010	Thioglycollate Broth, Alternative (Alternative Thioglycollate Medium)(NIH Thioglycollate Broth) , Granulated	Low risk	12/08/2015
DCM	GM021	Triple Sugar Iron Agar , Granulated	Low risk	22/04/2019
DCM	GM463	Tryptone Broth (Tryptone Water) , Granulated	Low risk	22/04/2019
DCM	GM177	Tryptose Broth, Granulated	Low Risk	12/08/2015
DCM	GM112	Urea Agar Base (Christensen) (Autoclavable)	Low Risk	30/10/2018
DCM	GM112A	Urea Agar Base (Filter sterilizable), Granulated	Low risk	25/08/2016
DCM	GM111A	Urea Broth (Filter sterilizable), Granulated	Low risk	25/08/2016
DCM	GM049	Violet Red Bile Agar, Granulated	Low risk	28/04/2017
DCM	GMH581	Violet Red Bile Glucose Agar , Granulated	Low risk	22/04/2019
DCM	GM581	Violet Red Bile Glucose Agar w/o Lactose, Granulated	Low risk	04/07/2018
DCM	GM031	Xylose Lysine Deoxycholate Agar (XLD Agar) , Granulated	Low Risk	12/08/2015
DCM	GMH031	Xylose-Lysine-Deoxycholate Agar , Granulated	Low risk	22/04/2019

Product group	Type/ Model / Ref number	Device Name	Risk Class	Date of CE compliance
Dehydrated Culture Media - Supplements				
DCM-S	FD001	Non Spore Anaerobic Supplement	Low risk	20/12/2012
DCM-S	FD002	G.N. Spore Anaerobic Supplement	Low risk	20/12/2012
DCM-S	FD003	Polymyxin B Selective Supplement	Low risk	20/12/2012
DCM-S	FD003B	Polymyxin B Selective Supplement	Low risk	04/07/2018
DCM-S	FD004	Bordetella Selective Supplement	Low risk	20/12/2012
DCM-S	FD005	Brucella Selective Supplement	Low risk	20/12/2012
DCM-S	FD006	Campylobacter Supplement-I (Blaser-Wang)	Low risk	20/12/2012
DCM-S	FD007	Campylobacter Supplement - II (Butzler)	Low risk	20/12/2012
DCM-S	FD008	Campylobacter Supplement- III (Skirrow)	Low risk	20/12/2012
DCM-S	FD009	Campylobacter Growth Supplement	Low risk	20/12/2012
DCM-S	FD010	Clostridium Difficile Supplement	Low risk	20/12/2012
DCM-S	FD013	S.F.P. Supplement (Perfringens S.F.P. Supplement)	Low risk	20/12/2012
DCM-S	FD014	T.S.C. Supplement (Perfringens T.S.C. Supplement)	Low risk	20/12/2012
DCM-S	FD015	Dermato Supplement	Low risk	20/12/2012
DCM-S	FD017	Legionella Selective Supplement	Low risk	20/12/2012
DCM-S	FD018	Middlebrook OADC Growth Supplement	Low risk	20/12/2012
DCM-S	FD019	Middlebrook ADC Growth Supplement	Low risk	20/12/2012
DCM-S	FD019R	Middlebrook ADC Growth Supplement	Low risk	10/11/2020
DCM-S	FD020	Oleic Albumin Supplement	Low risk	20/12/2012
DCM-S	FD021	GC Supplement w/ Antibiotics	Low risk	20/12/2012
DCM-S	FD022	Haemoglobin Powder	Low risk	20/12/2012
DCM-S	FD023	V.C.N. Supplement	Low risk	20/12/2012
DCM-S	FD024	V.C.N.T. Supplement	Low risk	20/12/2012
DCM-S	FD025	Vitamino Growth Supplement (Twin Pack)	Low risk	20/12/2012
DCM-S	FD025R	Vitamino Growth Supplement (Twin Pack)	Low risk	10/11/2020
DCM-S	FD026	Linco T Supplement	Low risk	20/12/2012
DCM-S	FD026R	Linco T Supplement	Low risk	10/11/2020
DCM-S	FD027	Yeast Autolysate Supplement	Low risk	20/12/2012
DCM-S	FD028	Vancko T Supplement	Low risk	20/12/2012
DCM-S	FD029	Cetrinix Supplement	Low risk	22/04/2019
DCM-S	FD030	Staph-Strepto Supplement	Low risk	20/12/2012
DCM-S	FD031	Strepto supplement	Low risk	25/08/2016
DCM-S	FD033	Chloramphenicol Selective Supplement	Low risk	20/12/2012
DCM-S	FD034	Yersinia Selective Supplement	Low risk	20/12/2012
DCM-S	FD035	CC Supplement	Low risk	20/12/2012
DCM-S	FD036	CFC Supplement	Low risk	22/04/2019
DCM-S	FD037	Legionella Selective Supplement II	Low risk	20/12/2012
DCM-S	FD038	Legionella Selective Supplement III	Low risk	20/12/2012
DCM-S	FD039	Aeromonas Selective Supplement	Low risk	20/12/2012
DCM-S	FD040	Legionella Selective Supplement IV (MWY)	Low risk	20/12/2012

DCM-S	FD041A	Legionella Supplement (Twin Pack)	Low risk	20/12/2012
DCM-S	FD041AR	Legionella Growth Supplement (Legionella Supplement) (Twin Pack)	Low risk	25/08/2016
DCM-S	FD042	Campylobacter Selective Supplement IV (Preston Selective Supplement)	Low risk	20/12/2012
DCM-S	FD043	Doyle's Antibiotic Supplement	Low risk	20/12/2012
DCM-S	FD045	Egg Yolk Emulsion (100 ml per vial)	Low risk	20/12/2012
DCM-S	FD045B	Egg Yolk Emulsion	Low risk	04/07/2018
DCM-S	FD045L	Egg Yolk Emulsion (50ml per vial)	Low risk	04/07/2018
DCM-S	FD045R	Egg Yolk Emulsion (100 ml per vial)	Low risk	25/08/2016
DCM-S	FD045RC	Egg Yolk Emulsion (100 ml per vial)	Low risk	10/11/2020
DCM-S	FD046	Egg Yolk Tellurite Emulsion (100 ml per vial)	Low risk	20/12/2012
DCM-S	FD046B	Egg Yolk Tellurite Emulsion	Low risk	04/07/2018
DCM-S	FD046L	Egg Yolk Tellurite Emulsion (50ml per vial)	Low risk	04/07/2018
DCM-S	FD046N	Egg Yolk Tellurite Emulsion, Modified	Low risk	04/07/2018
DCM-S	FD046NL	Egg Yolk Tellurite Emulsion, Modified	Low risk	04/07/2018
DCM-S	FD046R	Egg Yolk Tellurite Emulsion	Low risk	10/11/2020
DCM-S	FD047	Potassium Tellurite 3.5% (1 ml per vial)	Low risk	20/12/2012
DCM-S	FD048	Urea 40% (5 ml per vial)	Low risk	20/12/2012
DCM-S	FD049	C.B.I. Supplement	Low risk	20/12/2012
DCM-S	FD052	Potassium Tellurite 1% (1 ml per vial)	Low risk	20/12/2012
DCM-S	FD053	Gruft Mycobacterial Supplement	Low risk	20/12/2012
DCM-S	FD054	GBS Supplement	Low risk	20/12/2012
DCM-S	FD056	G. Vaginalis Selective Supplement	Low risk	20/12/2012
DCM-S	FD057	TTC Solution 1% (10 ml per vial)	Low risk	20/12/2012
DCM-S	FD059	Basic Fuchsin (6.0 gm per vial)	Low risk	20/12/2012
DCM-S	FD061	Listeria Selective Supplement (PALCAM)	Low risk	22/04/2019
DCM-S	FD061R	Listeria Selective Supplement (PALCAM)	Low risk	04/07/2018
DCM-S	FD062	Bacteroides Selective Supplement	Low risk	20/12/2012
DCM-S	FD063	Listeria Selective Supplement II	Low risk	20/12/2012
DCM-S	FD063I	Listeria Selective Supplement II	Low risk	20/12/2012
DCM-S	FD066	Leptospira Enrichment	Low risk	20/12/2012
DCM-S	FD068	Sulpha Supplement	Low risk	20/12/2012
DCM-S	FD069	B P Sulpha Supplement	Low risk	20/12/2012
DCM-S	FD070	McBride Listeria Supplement	Low risk	20/12/2012
DCM-S	FD071	Oxford Listeria Supplement	Low risk	20/12/2012
DCM-S	FD072	KL Virulence Enrichment (20 ml per vial)	Low risk	20/12/2012
DCM-S	FD072D	KL Virulence Enrichment (500 ml)	Low risk	10/11/2020
DCM-S	FD072M	KL Virulence Enrichment (1000 ml)	Low risk	10/11/2020
DCM-S	FD073	Diphtheria Virulence Supplement (Part A & B)	Low risk	20/12/2012
DCM-S	FD075	Mycoplasma Enrichment Supplement	Low risk	20/12/2012
DCM-S	FD075R	Mycoplasma Enrichment Supplement	Low risk	10/11/2020
DCM-S	FD078	Campylobacter Selective Supplement (Karmali)	Low risk	10/11/2020
DCM-S	FD082	Ampicillin Supplement	Low risk	20/12/2012
DCM-S	FD090	Campylobacter Selective Supplement	Low risk	20/12/2012

DCM-S	FD091	Bromo Thymol Blue Supplement (20 mg per vial)	Low risk	20/12/2012
DCM-S	FD092	MUG Supplement (50 mg per vial)	Low risk	10/11/2020
DCM-S	FD093	Bromo Cresol Purple	Low risk	22/04/2019
DCM-S	FD094	Trichomonas Selective Supplement II	Low risk	20/12/2012
DCM-S	FD095	10% Lactic Acid Solution (10 ml per vial)	Low risk	20/12/2012
DCM-S	FD096	Novobiocin Supplement	Low risk	22/04/2019
DCM-S	FD099	Trichomonas Selective Supplement I	Low risk	20/12/2012
DCM-S	FD100	Mueller Tellurite Serum (25 ml per vial)	Low risk	20/12/2012
DCM-S	FD102	Ticarcillin Supplement	Low risk	20/12/2012
DCM-S	FD103	Potassium Chlorate Supplement	Low risk	20/12/2012
DCM-S	FD105	Park and Sanders Selective Supplement II	Low risk	20/12/2012
DCM-S	FD106	Campylobacter Supplement VI (Butzler)	Low risk	20/12/2012
DCM-S	FD111	Kimmig Selective Supplement (Twin Pack)	Low risk	20/12/2012
DCM-S	FD112	George Kimmig Selective Supplement	Low risk	20/12/2012
DCM-S	FD114	Vitamin K1 Supplement	Low risk	20/12/2012
DCM-S	FD117	Haemophilus Growth Supplement	Low risk	20/12/2012
DCM-S	FD118	Mucosal	Low risk	20/12/2012
DCM-S	FD119	Streptococcus Selective Supplement	Low risk	20/12/2012
DCM-S	FD120	Chlortetracycline Selective Supplement	Low risk	20/12/2012
DCM-S	FD126	Listeria Moxalactam Supplement	Low risk	20/12/2012
DCM-S	FD130	Nalidixic Selective Supplement	Low risk	20/12/2012
DCM-S	FD132	Campylobacter Selective Supplement w/ Hemin (Karmali)	Low risk	10/11/2020
DCM-S	FD135	CCDA Selective Supplement	Low risk	20/12/2012
DCM-S	FD136	Listeria UVM Supplement I	Low risk	20/12/2012
DCM-S	FD137	Listeria UVM Supplement II	Low risk	20/12/2012
DCM-S	FD142	Legionella Growth Supplement (BCYE)	Low risk	10/11/2020
DCM-S	FD142X	Legionella Growth Supplement	Low risk	10/11/2020
DCM-S	FD143	Legionella (GVPC) Selective Supplement	Low risk	20/12/2012
DCM-S	FD144	Legionella BMPA Selective Supplement	Low risk	10/11/2020
DCM-S	FD147	Tellurite - Cefixime Supplement	Low risk	20/12/2012
DCM-S	FD149	Neomycin Supplement	Low risk	20/12/2012
DCM-S	FD150	NYC Supplement	Low risk	20/12/2012
DCM-S	FD152	XLT4 Supplement	Low risk	20/12/2012
DCM-S	FD153	M-CP Selective Supplement - I	Low risk	10/11/2020
DCM-S	FD154	M-CP Selective Supplement - II	Low risk	10/11/2020
DCM-S	FD154A	M-CP Selective Supplement, Modified	Low risk	10/11/2020
DCM-S	FD157	Urea 5% (5 ml per vial)	Low risk	20/12/2012
DCM-S	FD158	Campylobacter Selective Supplement IV (Preston), Modified	Low risk	20/12/2012
DCM-S	FD159	Doyle'S Antibiotic Supplement, Modified	Low risk	04/07/2018
DCM-S	FD160	Legionella (GVPA) Selective Supplement, Modified	Low risk	04/07/2018
DCM-S	FD161	Brucella Selective Supplement, Modified	Low risk	04/07/2018
DCM-S	FD163	Listeria Selective Supplement II, Modified	Low risk	04/07/2018
DCM-S	FD163-I	Listeria Selective Supplement II, Modified	Low risk	04/07/2018
DCM-S	FD164	Park and Sanders Selective Supplement II, Modified	Low risk	04/07/2018

DCM-S	FD165	Campylobacter Supplement -II (Butzler), Modified	Low risk	04/07/2018
DCM-S	FD169	CC Supplement, Modified	Low risk	04/07/2018
DCM-S	FD171	McBride Listeria Supplement, Modified	Low risk	04/07/2018
DCM-S	FD172	Oxford Listeria Supplement, Modified	Low risk	28/04/2017
DCM-S	FD172R	Oxford Listeria Supplement, Modified	Low risk	04/07/2018
DCM-S	FD173	Mycoprep (for 2 tests)	Low risk	16/12/2017
DCM-S	FD173B	Mycoprep (for 10 tests)	Low risk	16/12/2017
DCM-S	FD175	Mycoplasma Urogenital Selective Supplement	Low risk	20/12/2012
DCM-S	FD176	Dermato Supplement, Modified	Low risk	04/07/2018
DCM-S	FD179	Antibiotic Mixture for Borrelia (100 X) (5 ml per vial)	Low risk	20/12/2012
DCM-S	FD180	Rabbit serum	Low risk	25/08/2016
DCM-S	FD181	HiCrome™ Listeria Selective Supplement	Low risk	10/11/2020
DCM-S	FD183	Legionella Selective Supplement II, Modified	Low risk	04/07/2018
DCM-S	FD185	Anthraxis Selective Supplement	Low risk	20/12/2012
DCM-S	FD187	HiCrome™ EC O157 : H7 Selective Supplement	Low risk	05/11/2020
DCM-S	FD190	HiCrome®Hicrome ECC Selective Supplement	Low risk	22/04/2019
DCM-S	FD191	Oxacillin Resistance Selective Supplement	Low risk	20/12/2012
DCM-S	FD192	HiCrome™ Candida Selective Supplement	Low risk	20/12/2012
DCM-S	FD195	Fibrinogen Plasma Trypsin Inhibitor Supplement	Low risk	20/12/2012
DCM-S	FD196	Tetracycline Selective Supplement	Low risk	20/12/2012
DCM-S	FD198	Mycoplasma Cultivation Supplement	Low risk	20/12/2012
DCM-S	FD201	Albumin Glucose Supplement	Low risk	20/12/2012
DCM-S	FD206	Legionella Growth Supplement w/o L-Cysteine	Low risk	05/11/2020
DCM-S	FD206R	Legionella Growth Supplement w/o L-Cysteine	Low risk	10/11/2020
DCM-S	FD212	L. mono Selective Supplement I	Low risk	20/12/2012
DCM-S	FD212A	OA Listeria Selective Supplement	Low risk	10/11/2020
DCM-S	FD212B	L. mono Selective Supplement I	Low risk	04/07/2018
DCM-S	FD213	L. mono Selective Supplement II	Low risk	20/12/2012
DCM-S	FD214	L. mono Enrichment Supplement I	Low risk	20/12/2012
DCM-S	FD215	Vitamino Growth Supplement, Modified (Twin Pack)	Low risk	20/12/2012
DCM-S	FD215B	Vitamino Growth Supplement, Modified	Low risk	22/04/2019
DCM-S	FD225	Klebsiella Selective Supplement	Low risk	10/11/2020
DCM-S	FD226	Enterococcus faecium Selective Supplement	Low risk	10/11/2020
DCM-S	FD227	L. mono Enrichment Supplement II	Low risk	20/12/2012
DCM-S	FD229	MeReSa Selective Supplement	Low risk	20/12/2012
DCM-S	FD230	HiCrome EC O157: H7 Selective Supplement	Low risk	22/04/2019
DCM-S	FD232	Burkholderia Cepacia Selective Supplement	Low risk	20/12/2012
DCM-S	FD233	Vancomycin Supplement	Low risk	20/12/2012
DCM-S	FD236	Sorbic Acid Supplement	Low risk	20/12/2012
DCM-S	FD241	Poctri supplement	Low risk	25/08/2016
DCM-S	FD242	Legionella Selective Supplement(GVPN)	Low risk	20/12/2012
DCM-S	FD243	Clostridium Difficile Supplement	Low risk	20/12/2012
DCM-S	FD245	HiCrome™ Nickels & Leesment Selective Supplement	Low risk	10/11/2020
DCM-S	FD246	Cefixime Supplement	Low risk	20/12/2012
DCM-S	FD247	ECO157:H7 Selective Supplement	Low risk	22/04/2019

DCM-S	FD248	Coagulase Plasma	Low risk	04/07/2018
DCM-S	FD248A	Coagulase Plasma w/ EDTA (From Rabbit)	Low risk	22/04/2019
DCM-S	FD248B	Rabbit plasma with EDTA and 15% NaCl	Low risk	22/04/2019
DCM-S	FD248R	Coagulase Supplement for Staphilococci >>>>	Low risk	22/04/2019
DCM-S	FD252	Gentamycin Selective Supplement	Low risk	22/04/2019
DCM-S	FD253	Urea Solution	Low risk	20/12/2012
DCM-S	FD254	Ureaplasma Selective Supplement	Low risk	04/07/2018
DCM-S	FD255	Ureaplasma Growth Supplement	Low risk	20/12/2012
DCM-S	FD259	Cefoxitin Supplement	Low risk	20/12/2012
DCM-S	FD261	Vancomycin Supplement	Low risk	20/12/2012
DCM-S	FD266	Listeria Moxalactam Supplement Modified	Low risk	20/12/2012
DCM-S	FD269	OFPL Selective Supplement	Low risk	25/11/2017
DCM-S	FD270	Chromogenic Supplement	Low risk	10/11/2020
DCM-S	FD271	MDR Acinetobacter Selective Supplement	Low risk	25/08/2016
DCM-S	FD274	HiCrome Selective Salmonella Agar Supplement	Low risk	22/04/2019
DCM-S	FD277	HiCrome™ VRE Agar supplement	Low risk	20/12/2012
DCM-S	FD278	HiCrome™ ESBL Agar Supplement	Low risk	20/12/2012
DCM-S	FD279	HiCrome™ KPC Agar Supplement	Low risk	20/12/2012
DCM-S	FD280	Sterile Charcoal Supplement for Legionella Agar	Low risk	10/11/2020
DCM-S	FD283R	HiCrome™ Candida Differential Selective Supplement	Low risk	20/12/2012
DCM-S	FD284	Acriflavin-Cefsulodin-Vancomycin Supplement (ACV Supplement)	Low risk	20/12/2012
DCM-S	FD285	Bifidobacterium Selective Supplement	Low risk	20/12/2012
DCM-S	FD286	Yersinia Selective Supplement	Low risk	20/12/2012
DCM-S	FD287	Growth Supplement I for MSM	Low risk	20/12/2012
DCM-S	FD288	Growth Supplement II for MSM	Low risk	20/12/2012
DCM-S	FD290	Novobiocin Selective Supplement	Low risk	20/12/2012
DCM-S	FD295	HiCrome ECO157:H7 Selective Supplement Modified	Low risk	22/04/2019
DCM-S	FD299	Selective Supplement for MRSA	Low risk	20/12/2012
DCM-S	FD300	Hayflick Supplement	Low risk	20/12/2012
DCM-S	FD302	Group A Selective Supplement	Low risk	20/12/2012
DCM-S	FD304	Arcobacter Selective Supplement	Low risk	05/11/2020
DCM-S	FD306	Modified Listeria Oxford Selective Supplement	Low risk	22/04/2019
DCM-S	FD309	Monensin Selective Supplement	Low risk	22/04/2019
DCM-S	FD312	VIA Supplement	Low risk	20/12/2012
DCM-S	FD319	MRSA Supplement	Low risk	25/08/2016
DCM-S	FD319R	MeReSa Selective Supplement (MRSA Selective Supplement)	Low risk	25/08/2016
DCM-S	FD320	Clostridium difficile Selective Supplement	Low risk	25/08/2016
DCM-S	FD321	TVCSB Supplement	Low risk	25/08/2016
DCM-S	FD322	Middlebrook ADC Growth Supplement, Modified	Low risk	25/08/2016
DCM-S	FD323	TSBV Supplement	Low risk	25/08/2016
DCM-S	FD324	Bacillus Selective Supplement	Low risk	25/08/2016
DCM-S	FD327	NAD Supplement	Low risk	25/08/2016
DCM-S	FD329	Middlebrook OADC Enrichment Supplement	Low risk	25/08/2016
DCM-S	FD332	Lecithin solution	Low risk	10/11/2020

DCM-S	FD333	Modified L.mono Selective supplement	Low risk	10/11/2020
DCM-S	FD334	Mycoplasma selective supplement	Low risk	25/08/2016
DCM-S	FD335	Leeds Acinetobacter selective supplement	Low risk	25/08/2016
DCM-S	FD335R	MDR Acinetobacter Selective Supplement	Low risk	25/08/2016
DCM-S	FD338	LCN Supplement	Low risk	25/08/2016
DCM-S	FD340	PACT Supplement	Low risk	28/04/2017
DCM-S	FD342	Rapid Listeria Selective Supplement	Low risk	10/11/2020
DCM-S	FD343	Growth Supplement for Fastidious Organism	Low risk	16/12/2017
DCM-S	FD344	ECC Selective Supplement Modified	Low risk	22/04/2019
DCM-S	FD345	Ciprofloxacin Supplement	Low risk	10/11/2020
DCM-S	FD347	PCP Supplement	Low risk	04/07/2018
DCM-S	FD347B	PCP Supplement	Low risk	10/11/2020
DCM-S	FD348	OADS Supplement	Low risk	16/12/2017
DCM-S	FD349	Vancomycin Polymyxin B Supplement	Low risk	04/07/2018
DCM-S	FD352	Acinetobacter Selective Supplement	Low risk	30/10/2018
DCM-S	FD353	VCAT Supplement	Low risk	30/10/2018
DCM-S	FD354	STEC Selective Supplement	Low risk	30/10/2018
DCM-S	FD355	HiCrome™ Colistin Resistant Selective Supplement	Low risk	30/10/2018
DCM-S	FD356	Diphenyl supplement	Low risk	22/04/2019
DCM-S	FD357	Carba Selective Supplement	Low risk	10/11/2020
DCM-S	FD360	C.auris Selective Supplement	Low risk	05/11/2019
DCM-S	FD361	BCSA Selective Supplement	Low risk	05/11/2019
DCM-S	FD362	Coagulase Supplement (for M2126)	Low risk	10/11/2020
DCM-S	FD725R	Mycoprep (Modified,Bulk powder)	Low risk	25/08/2016
DCM-S	FD726	Mycoprep (Modified, powder for 1000ml)	Low risk	25/08/2016
DCM-S	FD743R	Bifido Selective Supplement C	Low risk	25/08/2016
DCM-S	FD744R	Bifido Selective Supplement D	Low risk	25/08/2016
DCM-S	FD745R	Bifido Selective Supplement E	Low risk	25/08/2016
DCM-S	FD749	Supplement for HiCrome™ Candida Agar	Low risk	04/07/2018
DCM-S	FD750	L. J. Media Supplement w/ Capreomycin	Low risk	25/08/2016
DCM-S	FD751	L. J. Medium Supplement w/ Clarithromycin	Low risk	25/08/2016
DCM-S	FD752	L. J. Media Supplement w/ D-Cycloserine	Low risk	25/08/2016
DCM-S	FD753	L. J. Media Supplement w/ Ethambutol	Low risk	25/08/2016
DCM-S	FD754	L. J. Media Supplement w/ Ethionamide	Low risk	25/08/2016
DCM-S	FD755	L. J. Medium Supplement w/ Gatifloxacin	Low risk	25/08/2016
DCM-S	FD756	L. J. Media Supplement w/ Isoniazide	Low risk	25/08/2016
DCM-S	FD757	L. J. Media Supplement w/ Kanamycin	Low risk	25/08/2016
DCM-S	FD758	L. J. Medium Supplement w/ Levofloxacin	Low risk	25/08/2016
DCM-S	FD759	L. J. Medium Supplement w/ Lomefloxacin	Low risk	04/07/2018
DCM-S	FD760	L. J. Medium Supplement w/ Ofloxacin	Low risk	04/07/2018
DCM-S	FD761	L. J. Medium Supplement w/ p-Aminosalicylic acid	Low risk	04/07/2018
DCM-S	FD762	L. J. Medium Supplement w/ Pyrazinamide	Low risk	04/07/2018
DCM-S	FD763	L.J.Medium Supplementw/Rifabutin	Low risk	04/07/2018
DCM-S	FD764	L.J.Medium Supplementw/Rifampicin	Low risk	04/07/2018
DCM-S	FD765	L.J.Medium Supplementw/Sodium Salicylate	Low risk	04/07/2018

DCM-S	FD766	L.J. Medium Supplement w/ Streptomycin	Low risk	04/07/2018
DCM-S	FD767	L.J. Medium Supplement w/ TCH	Low risk	04/07/2018
DCM-S	FD768	Chloramphenicol Supplement	Low risk	04/07/2018
DCM-S	FD772	L.J. Media Supplement w/ Amikacin	Low risk	04/07/2018
DCM-S	FD775	L.J. Media Supplement w/ p-Nitrobenzoic acid	Low risk	04/07/2018
DCM-S	FD780	L.J. Media Supplement w/ Moxifloxacin	Low risk	04/07/2018
DCM-S	FD804	Enriched growth Supplement for Mycobacteria	Low risk	04/07/2018
DCM-S	FD805	Growth Supplement for Anaerobic cultures	Low risk	10/11/2020
DCM-S	FD808	Supplement for GC Agar Base	Low risk	10/11/2020
DCM-S	FD812	Selective Supplement for Gram positive bacteria (Clostridium, Staphylococcus spp. etc.)	Low risk	10/11/2020
DCM-S	FD814	PANTA Supplement	Low risk	10/11/2020
DCM-S	FD815B	Selective Supplement for SS Agar	Low risk	10/11/2020
DCM-S	FD816	Selective supplement for Enterobacteriaceae	Low risk	10/11/2020
DCM-S	FD817	Selective Supplement for Staphylococcus	Low risk	10/11/2020
DCM-S	FD075R	Mycoplasma Enrichment Supplement	Low risk	10/11/2020
DCM-S	FD820	Selective Supplement for SS Agar	Low risk	10/11/2020

Product group	Type/ Model / Ref number	Device Name	Risk Class	Date of CE compliance
Ready Prepared Media				
RPM - Ready Prepared Plates	HB001	HiCombi™ Nutrient - MacConkey Agar Plate	Low risk	20/12/2012
RPM - Ready Prepared Plates	HB003	HiCombi™ CLED - MacConkey Agar Plate	Low risk	20/12/2012
RPM - Ready Prepared Plates	HB004	HiCombi™ XLD - MacConkey Agar Plate	Low risk	20/12/2012
RPM - Ready Prepared Plates	HB005	HiCombi™ Cetrimide - MacConkey Agar Plate	Low risk	20/12/2012
RPM - Ready Prepared Plates	HB006	HiCombi™ Blood- MacConkey Agar Plate	Low risk	20/12/2012
RPM - Ready Prepared Plates	HB007	HiCombi™ MacConkey-Mannitol Salt Agar	Low risk	20/12/2012
RPM - Ready Prepared Plates	HB008	HiCombi™ Blood -Chocolate Agar	Low risk	20/12/2012
RPM - Ready Prepared Plates	HB009	HiCombi™ Blood -Mannitol Salt Agar	Low risk	20/12/2012
RPM - Ready Prepared Plates	HB010	HiCombi™ Chocolate - MacConkey Agar Plate	Low risk	20/12/2012
RPM- HiDip Slides	HD001	HiDip™ Cled-Cetri-Mac Medium	Low risk	20/12/2012
RPM- HiDip Slides	HD002	HiDip™ Mac-Cled-Sab Medium	Low risk	20/12/2012
RPM- HiDip Slides	HD003	HiDip™ Mac-Cled-Bile Esculin Medium	Low risk	20/12/2012
RPM- HiDip Slides	HD004	HiDip™ Cled-Mac Medium	Low risk	20/12/2012
RPM- HiDip Slides	HD005	HiDip™ Cled-MUG Mac Medium	Low risk	20/12/2012
RPM- HiDip Slides	HD006	HiDip™ Cled-HiCrome™ UTI Medium	Low risk	20/12/2012
RPM- HiDip Slides	HD007	HiDip™ Mac-HiCrome™ UTI Medium	Low risk	20/12/2012
RPM- HiDip Slides	HD007R	HiDip™ Mac-HiCrome™ UTI Medium	Low risk	10/11/2020
RPM- HiDip Slides	HD018	HiDip™ TSA-CLED Agar w/ B.T.B Indicator Medium	Low Risk	20/12/2012
RPM- HiDip Slides	HD020	HiDip™ Pseudomonas Agar - MacConkey Agar Medium	Low risk	20/12/2012
RPM- HiDip Slides	HD021	HiDip™ PCA - MacConkey Agar Medium	Low risk	20/12/2012
RPM- HiDip Slides	HD024	HiDip™ Modified Rogosa Medium-Modified Rogosa Medium	Low risk	20/12/2012
RPM- HiDip Slides	HD025	HiDip™ Modified Nickerson Medium-Modified Nickerson Medium	Low risk	20/12/2012
RPM- HiDip Slides	HD041	HiDip HiCrome™ Universal Agar-PCA	Low risk	28/04/2017
RPM- HiDip Slides	HD042	HiDip HiCrome™ UTI Agar - Dey Engley Neutralizing agar	Low risk	28/04/2017
RPM- HiDip Slides	HD046	HiDip TSA-TCBS	Low risk	30/10/2018
RPM- HiDip Slides	HD047	HiDip TSA-MRS	Low risk	30/10/2018
RPM- HiSafe Blood Culturing System	LQ003	BHI	Low risk	20/12/2012
RPM- HiSafe Blood Culturing System	LQ003A	BHI	Low risk	20/12/2012
RPM- HiSafe Blood Culturing System	LQ004	BHI - Supplemented w/ 0.05% SPS	Low risk	20/12/2012
RPM- HiSafe Blood Culturing System	LQ004R	BHI - Supplemented w/ 0.05% SPS	Low risk	10/11/2020
RPM- HiSafe Blood Culturing System	LQ004A	BHI - Supplemented w/ 0.05% SPS	Low risk	20/12/2012
RPM- HiSafe Blood Culturing System	LQ004AR	BHI - Supplemented w/ 0.05% SPS	Low risk	10/11/2020
RPM- HiSafe Blood Culturing System	LQ005	TSB - Tryptone Soya Broth w/ 10% Sucrose	Low risk	20/12/2012
RPM- HiSafe Blood Culturing System	LQ005A	TSB - Tryptone Soya Broth w/ 10% Sucrose	Low risk	20/12/2012
RPM- HiSafe Blood Culturing System	LQ006	Columbia Broth	Low risk	20/12/2012
RPM- HiSafe Blood Culturing System	LQ006A	Columbia Broth	Low risk	20/12/2012
RPM- HiSafe Blood Culturing System	LQ007	Thioglycollate Broth	Low Risk	20/12/2012
RPM- HiSafe Blood Culturing System	LQ007R	Thioglycollate Broth	Low Risk	10/11/2020
RPM- HiSafe Blood Culturing System	LQ007A	Thioglycollate Broth	Low Risk	20/12/2012
RPM- HiSafe Blood Culturing System	LQ007AR	Thioglycollate Broth	Low Risk	10/11/2020

RPM- HiSafe Blood Culturing System	LQ008	Schaedler Broth	Low Risk	20/12/2012
RPM- HiSafe Blood Culturing System	LQ008A	Schaedler Broth	Low Risk	20/12/2012
RPM- HiSafe Blood Culturing System	LQ009	TSB - Tryptone Soya Broth	Low risk	20/12/2012
RPM- HiSafe Blood Culturing System	LQ009A	TSB - Tryptone Soya Broth	Low risk	20/12/2012
RPM- HiSafe Blood Culturing System	LQ010	Glucose Broth Supplemented w/ 0.05% SPS	Low risk	20/12/2012
RPM- HiSafe Blood Culturing System	LQ010A	Glucose Broth Supplemented w/ 0.05% SPS	Low risk	20/12/2012
RPM- HiSafe Blood Culturing System	LQ010AR	Glucose Broth Supplemented w/ 0.05% SPS	Low risk	10/11/2020
RPM- HiSafe Blood Culturing System	LQ010V	Glucose Broth supplemented w/0.05% SPS	Low risk	22/04/2019
RPM- HiSafe Blood Culturing System	LQ011	TSB - Tryptone Soya Broth Supplemented w/ 0.05% SPS	Low risk	20/12/2012
RPM- HiSafe Blood Culturing System	LQ011A	TSB - Tryptone Soya Broth Supplemented w/ 0.05% SPS	Low risk	20/12/2012
RPM- HiSafe Blood Culturing System	LQ011AR	TSB - Tryptone Soya Broth Supplemented w/ 0.05% SPS	Low risk	10/11/2020
RPM- HiSafe Blood Culturing System	LQ013V	Hartley Broth	Low risk	22/04/2019
RPM- HiSafe Blood Culturing System	LQ014	Modified Wilkins Chalgren Broth	Low risk	20/12/2012
RPM- HiSafe Blood Culturing System	LQ014A	Modified Wilkins Chalgren Broth	Low risk	20/12/2012
RPM- HiSafe Blood Culturing System	LQ012	HiCombi™ Dual Performance Medium	Low Risk	20/12/2012
RPM- HiSafe Blood Culturing System	LQ012R	HiCombi™ Dual Performance Medium	Low Risk	10/11/2020
RPM- HiSafe Blood Culturing System	LQ013	Hartley Broth	Low Risk	20/12/2012
RPM- HiSafe Blood Culturing System	LQ013A	Hartley Broth	Low Risk	20/12/2012
RPM- HiSafe Blood Culturing System	LQ023	Fluid thioglycollate Medium w/0.05% SPS	Low Risk	20/12/2012
RPM- HiSafe Blood Culturing System	LQ023A	Fluid thioglycollate Medium w/0.05% SPS	Low Risk	20/12/2012
RPM- Ready Prepared Dual Media	LQ029	HiCombi™ Dual Performance Salmonella Medium - SS	Low Risk	20/12/2012
RPM- Ready Prepared Dual Media	LQ029A	HiCombi™ Dual Performance Salmonella Medium - SS	Low Risk	20/12/2012
RPM- Ready Prepared Dual Media	LQ029AR	HiCombi™ Dual Performance Salmonella Medium - SS	Low Risk	10/11/2020
RPM- Ready Prepared Dual Media	LQ030	HiCombi™ Dual Performance Salmonella Medium - XLD	Low risk	20/12/2012
RPM- Ready Prepared Dual Media	LQ030A	HiCombi™ Dual Performance Salmonella Medium - XLD	Low risk	20/12/2012
RPM- Ready Prepared Dual Media	LQ031	HiCombi™ Dual Performance Salmonella Medium - DCA	Low risk	20/12/2012
RPM- Ready Prepared Dual Media	LQ031A	HiCombi™ Dual Performance Salmonella Medium - DCA	Low risk	20/12/2012
RPM- Ready Prepared Dual Media	LQ031AR	HiCombi™ Dual Performance Salmonella Medium - DCA	Low risk	10/11/2020
RPM- Ready Prepared Dual Media	LQ032	HiCombi™ Dual Performance Salmonella Medium - HEA	Low risk	20/12/2012
RPM- Ready Prepared Dual Media	LQ032A	HiCombi™ Dual Performance Salmonella Medium - HEA	Low risk	20/12/2012
RPM- Ready Prepared Dual Media	LQ033	HiCombi™ Dual Performance Medium	Low risk	20/12/2012
RPM- Ready Prepared Dual Media	LQ033R	HiCombi™ Dual Performance Medium	Low risk	10/11/2020
RPM- Ready Prepared Dual Media	LQ034	HiCombi™ Dual Performance Fungal Medium Kit	Low risk	20/12/2012
RPM- Ready Prepared Dual Media	LQ034R	HiCombi™ Dual Performance Fungal Medium Kit	Low Risk	10/11/2020
RPM- Ready Prepared Dual Media	LQ034A	HiCombi™ Dual Performance Fungal Medium Kit	Low Risk	20/12/2012
RPM- Ready Prepared Dual Media	LQ034AR	HiCombi™ Dual Performance Fungal Medium Kit	Low Risk	10/11/2020
RPM- Ready Prepared Dual Media	LQ035	HiCombi™ Dual Performance Selective Medium - HEA	Low risk	20/12/2012
RPM- Ready Prepared Dual Media	LQ035A	HiCombi™ Dual Performance Selective Medium - HEA	Low risk	20/12/2012
RPM- Ready Prepared Dual Media	LQ035AR	HiCombi™ Dual Performance Selective Medium - HEA	Low risk	10/11/2020
RPM- Ready Prepared Dual Media	LQ036	HiCombi™ Dual Performance Selective Medium - SS	Low risk	20/12/2012
RPM- Ready Prepared Dual Media	LQ036R	HiCombi™ Dual Performance Selective Medium - SS	Low risk	10/11/2020
RPM- Ready Prepared Dual Media	LQ036A	HiCombi™ Dual Performance Selective Medium - SS	Low risk	20/12/2012
RPM- Ready Prepared Dual Media	LQ036AR	HiCombi™ Dual Performance Selective Medium - SS	Low risk	10/11/2020
RPM- Ready Prepared Dual Media	LQ037	HiCombi™ Dual Performance Selective Medium - HEA	Low risk	20/12/2012
RPM- Ready Prepared Dual Media	LQ038	HiCombi™ Dual Performance Selective Medium - SS	Low risk	20/12/2012

RPM- Ready Prepared Dual Media	LQ038A	HiCombi™ Dual Performance Selective Medium - SS	Low risk	25/08/2016
RPM- Ready Prepared Liquid Medium	LQ004AI	BHI-Supplemented w/0.05% SPS	Low risk	25/08/2016
RPM- Ready Prepared Liquid Medium	LQ004AL	BHI-Supplemented w/0.05% SPS	Low risk	25/08/2016
RPM- Ready Prepared Liquid Medium	LQ004V	BHI - Supplemented w/ 0.05% SPS	Low risk	25/08/2016
RPM- Ready Prepared Liquid Medium	LQ0151	Medium 11. GN Broth	Low risk	04/07/2018
RPM- Ready Prepared Liquid Medium	LQ069	Alkaline Peptone Water	Low Risk	20/12/2012
RPM- Ready Prepared Liquid Medium	LQ069R	Enrichment Medium For Vibrio	Low Risk	25/08/2016
RPM- Ready Prepared Liquid Medium	LQ070	Selenite Broth	Low risk	20/12/2012
RPM- Ready Prepared Liquid Medium	LQ070V	Selenite Broth	Low Risk	25/08/2016
RPM- Ready Prepared Liquid Medium	LQ077	BHI Broth	Low risk	20/12/2012
RPM- Ready Prepared Liquid Medium	LQ077V	BHI Broth	Low risk	20/12/2012
RPM- Ready Prepared Liquid Medium	LQ077R	Enrichment Medium	Low risk	25/08/2016
RPM- Ready Prepared Liquid Medium	LQ079	Bile Broth	Low Risk	20/12/2012
RPM- Ready Prepared Liquid Medium	LQ079V	Bile Broth	Low Risk	22/04/2019
RPM- Ready Prepared Liquid Medium	LQ080	Cooked M Medium	Low Risk	20/12/2012
RPM- Ready Prepared Liquid Medium	LQ080C	Cooked M Medium	Low Risk	04/07/2018
RPM- Ready Prepared Liquid Medium	LQ080V	Cooked M Medium	Low Risk	20/12/2012
RPM- Ready Prepared Liquid Medium	LQ088	Tetrathionate Broth	Low risk	20/12/2012
RPM- Ready Prepared Liquid Medium	LQ089	Peptone Water	Low risk	04/07/2018
RPM- Ready Prepared Liquid Medium	LQ089X	Peptone Water	Low risk	04/07/2018
RPM- Ready Prepared Liquid Medium	LQ093	Cooked M Medium w/ Glucose, Hemin & Vitamin K	Low Risk	20/12/2012
RPM- HiSafe Blood Culturing System	LQ095	Hartley Broth w/ 0.05% SPS	Low Risk	20/12/2012
RPM- HiSafe Blood Culturing System	LQ095A	Hartley Broth w/ 0.05% SPS	Low Risk	20/12/2012
RPM- Ready Prepared Liquid Medium	LQ104	Rappaport Vassiliadis Salmonella Enrichment Broth	Low Risk	20/12/2012
RPM- Ready Prepared Liquid Medium	LQ104C	Rappaport Vassiliadis Salmonella Enrichment Broth	Low Risk	04/07/2018
RPM- Ready Prepared Liquid Medium	LQ104V	Rappaport Vassiliadis Salmonella Enrichment Broth	Low Risk	20/12/2012
RPM- Ready Prepared Liquid Medium	LQ104XX	Rappaport Vassiliadis Salmonella Enrichment Broth	Low Risk	28/04/2017
RPM- Ready Prepared Liquid Medium	LQ105	Kirchner Medium Base	Low Risk	20/12/2012

RPM- Ready Prepared Dual Media	LQ109	HiCombi™ Dual Performance Trans Isolate Medium	Low risk	20/12/2012
RPM- Ready Prepared Dual Media	LQ109R	HiCombi™ Dual Performance Trans Isolate Medium	Low risk	10/11/2020
RPM- Ready Prepared Liquid Medium	LQ126	Urea Indole Medium	Low risk	04/07/2018
RPM- Ready Prepared Liquid Medium	LQ129	Sabouraud's Dextrose Broth	Low risk	04/07/2018
RPM- Ready Prepared Liquid Medium	LQ129V	Sabouraud's Dextrose Broth	Low risk	25/08/2016
RPM- Ready Prepared Liquid Medium	LQ132	Campylo Thioglycollate Broth w/Selective Supplement	Low Risk	20/12/2012
RPM- Ready Prepared Liquid Medium	LQ134	L Broth	Low Risk	20/12/2012
RPM- Ready Prepared Liquid Medium	LQ146	Mannitol Selenite Broth	Low risk	20/12/2012
RPM- Ready Prepared Liquid Medium	LQ157	GN Broth, Hajna	Low risk	20/12/2012
RPM- Ready Prepared Liquid Medium	LQ159	Hayflick Medium	Low risk	20/12/2012
RPM- Ready Prepared Liquid Medium	LQ170	Selective Enrichment Medium For Group B	Low risk	25/08/2016
RPM- Ready Prepared Liquid Medium	LQ180V	Brucella Broth	Low risk	20/12/2012
RPM- Ready Prepared Liquid Medium	LQ181V	Mannitol Salt Broth	Low risk	20/12/2012
RPM- Ready Prepared Liquid Medium	LQ182V	Mueller Hinton Broth	Low risk	20/12/2012
RPM- Ready Prepared Liquid Medium	LQ296X	Hugh Leifson Medium	Low risk	10/11/2020
RPM- HiSafe Blood Culturing System	LQ188	HiCombi™ Dual Performance Fungal Medium, Modified	Low risk	20/12/2012
RPM- HiSafe Blood Culturing System	LQ208	Eugonic LT100 Broth	Low Risk	22/04/2019
RPM- Ready Prepared Liquid Medium	LQ208L	Eugonic LT100 Broth	Low risk	28/04/2017
RPM- Ready Prepared Liquid Medium	LQ208CCL	Eugonic LT100 Broth	Low risk	28/04/2017
RPM- Ready Prepared Liquid Medium	LQ210C	BHI Broth	Low risk	20/12/2012
RPM- Ready Prepared Liquid Medium	LQ210D	BHI Broth	Low risk	20/12/2012
RPM- Ready Prepared Dual Media	LQ241	HiCombi Trans Isolate Medium	Low risk	28/04/2017
RPM- Ready Prepared Liquid Medium	LQ246CCL	Sauton's Fluid Medium Base	Low risk	16/12/2017
RPM- Ready Prepared Liquid Medium	LQ314II	HiMiC™ Diluent	Low risk	10/11/2020
RPM -Ready Prepared Plates	MP001	Nutrient Agar Plate	Low Risk	20/12/2012
RPM -Ready Prepared Plates	MP001L	Nutrient Agar Plate (150mm plate)	Low Risk	20/12/2012
RPM -Ready Prepared Plates	MP015	Hoyles Media Plate with supplements.	Low Risk	20/12/2012
RPM -Ready Prepared Plates	MP016	Brilliant Green Agar, Modified Plate	Low Risk	30/10/2018
RPM -Ready Prepared Plates	MP022	EMB Agar, Levine Plate	Low Risk	20/12/2012
RPM -Ready Prepared Plates	MP023	Vogel Johnson Agar Plate (V.J. Agar Plate)	Low Risk	22/04/2019
RPM -Ready Prepared Plates	MP024	Cetrimide Agar Plate	Low Risk	20/12/2012

RPM -Ready Prepared Plates	MP029	Endo Agar Plate	Low Risk	20/12/2012
RPM -Ready Prepared Plates	MP031	Xylose Lysine Deoxycholate Agar (XLD Agar) Plate	Low risk	20/12/2012
RPM -Ready Prepared Plates	MP043	Baird Parker Agar Plate	Low risk	25/08/2016
RPM -Ready Prepared Plates	MP043L	Baird Parker Agar Plate	Low risk	04/07/2018
RPM -Ready Prepared Plates	MP043M	Baird Parker Agar Plate (150mm)	Low risk	16/12/2017
RPM -Ready Prepared Plates	MP049	Violet Red Bile Agar Plate	Low risk	16/12/2017
RPM -Ready Prepared Plates	MP063	Sabouraud Dextrose Agar Plate	Low Risk	20/12/2012
RPM -Ready Prepared Plates	MP063L	Sabouraud Dextrose Agar Plate (150 mm plate)	Low Risk	20/12/2012
RPM -Ready Prepared Plates	MP063M	Sabouraud Dextrose Agar Plate (120 mm plate)	Low Risk	20/12/2012
RPM -Ready Prepared Plates	MP065	Deoxycholate Citrate Agar Plate	Low Risk	30/10/2018
RPM -Ready Prepared Plates	MP073	Blood Agar Plate	Low risk	10/11/2020
RPM -Ready Prepared Plates	MP074	Brucella Agar Plate	Low Risk	22/04/2019
RPM -Ready Prepared Plates	MP081	MacConkey Agar w/ 0.15% Bile Salts, CV and NaCl Plate	Low risk	20/12/2012
RPM -Ready Prepared Plates	MP081XL	MacConkey Agar w/ 0.15% Bile Salts, CV and NaCl Plate (200mm plate)	Low risk	20/12/2012
RPM -Ready Prepared Plates	MP082	MacConkey Agar w/o CV, NaCl w/ 0.5% Sodium Taurocholate Plate	Low risk	20/12/2012
RPM -Ready Prepared Plates	MP091	Plate Count Agar Plate	Low risk	16/12/2017
RPM -Ready Prepared Plates	MP103	Chocolate Agar Plate	Low Risk	20/12/2012
RPM -Ready Prepared Plates	MP108	SS Agar (Salmonella Shigella Agar) Plate	Low risk	20/12/2012
RPM -Ready Prepared Plates	MP1032	SS Agar Plate, Modified (Salmonella Shigella Agar Plate, Modified)	Low risk	10/11/2020
RPM -Ready Prepared Plates	MP1039	Brucella Agar Plate with Hemin & Vitamin K1	Low Risk	20/12/2012
RPM -Ready Prepared Plates	MP1057	G. vaginalis Selective Agar Plate	Low Risk	30/10/2018
RPM -Ready Prepared Plates	MP1067	Sabouraud Chloramphenicol Agar Plate	Low Risk	20/12/2012
RPM -Ready Prepared Plates	MP1084	Mueller Hinton Agar No. 2 Plate	Low Risk	20/12/2012
RPM -Ready Prepared Plates	MP1084HB	Mueller Hinton Agar No.2 Plate w/ Horse Blood	Low risk	10/11/2020
RPM -Ready Prepared Plates	MP1084SB	Mueller Hinton Agar No.2 Plate w/ Sheep Blood	Low risk	10/11/2020
RPM -Ready Prepared Plates	MP1139	Modified MYP Agar Plate	Low risk	10/11/2020
RPM -Ready Prepared Plates	MP118	Mannitol Salt Agar Plate	Low Risk	20/12/2012
RPM -Ready Prepared Plates	MP1259	Haemophilus Test Agar Plate	Low Risk	30/10/2018
RPM -Ready Prepared Plates	MP1260	Tellurite Blood Agar Plate	Low Risk	20/12/2012
RPM -Ready Prepared Plates	MP1295	HiCrome™ E.coli Agar Plate	Low risk	10/11/2020
RPM -Ready Prepared Plates	MP1297A	HiCrome™TM Candida Differential Agar Plate	Low Risk	20/12/2012
RPM -Ready Prepared Plates	MP1301	Sheep Blood Agar Plate	Low risk	20/12/2012
RPM -Ready Prepared Plates	MP1301C	Sheep Blood Agar Plate (Individually Packed)	Low risk	28/04/2017
RPM -Ready Prepared Plates	MP1301M	Sheep Blood Agar Plate	Low risk	04/07/2018
RPM -Ready Prepared Plates	MP1259	Haemophilus Test Agar Plate	Low risk	30/10/2018
RPM -Ready Prepared Plates	MP1345	Anaerobic Blood Agar Plate w/Neomycin	Low risk	30/10/2018
RPM -Ready Prepared Plates	MP1353	HiCrome™ UTI Agar Plate	Low risk	20/12/2012
RPM -Ready Prepared Plates	MP137	Malt Extract Agar Plate	Low risk	30/10/2018
RPM -Ready Prepared Plates	MP144	Columbia 5% Sheep Blood Agar Plate	Low risk	20/12/2012
RPM -Ready Prepared Plates	MP1418	HiCrome™ UTI Agar Plate, Modified	Low risk	10/11/2020
RPM -Ready Prepared Plates	MP1454	Oxacillin Resistant Screening Agar Plate	Low Risk	20/12/2012
RPM -Ready Prepared Plates	MP1548	Chocolate No. 2 Agar Plate	Low risk	10/11/2020
RPM -Ready Prepared Plates	MP1594	MeReSa Agar Plate	Low Risk	30/10/2018
RPM -Ready Prepared Plates	MP160	DCLS Agar Plate	Low Risk	30/10/2018

RPM -Ready Prepared Plates	MP1600	HiCrome™ Universal Agar Plate	Low Risk	20/12/2012
RPM -Ready Prepared Plates	MP1640	Burkholderia Cepacia Agar Plate	Low Risk	04/07/2018
RPM -Ready Prepared Plates	MP1674	HiCrome™ MeReSa Agar Plate	Low Risk	20/12/2012
RPM -Ready Prepared Plates	MP1702	MacConkey Agar RS Plate	Low Risk	30/10/2018
RPM -Ready Prepared Plates	MP173	Mueller Hinton Agar Plate	Low Risk	20/12/2012
RPM -Ready Prepared Plates	MP173C	Mueller Hinton Agar Plate (100 mm Plate)	Low Risk	20/12/2012
RPM -Ready Prepared Plates	MP173L	Mueller Hinton Agar Plate (150mm plate)	Low Risk	20/12/2012
RPM -Ready Prepared Plates	MP173M	Mueller Hinton Agar Plate (120mm plate)	Low Risk	20/12/2012
RPM -Ready Prepared Plates	MP173XL	Mueller Hinton Agar Plate (200mm plate)	Low Risk	20/12/2012
RPM -Ready Prepared Plates	MP173SP	Mueller Hinton Agar Plate (150 mm scored plate)	Low Risk	20/12/2012
RPM -Ready Prepared Plates	MP175	Bordet Gengou Agar Plate w/15% Sheep blood	Low Risk	25/08/2016
RPM -Ready Prepared Plates	MP175SB	Bordet Gengou Agar Plate with 25% Sheep Blood	Low Risk	20/12/2012
RPM -Ready Prepared Plates	MP1763	VRE Agar Plate	Low Risk	30/10/2018
RPM -Ready Prepared Plates	MP180	Lead Acetate Agar Plate	Low risk	20/12/2012
RPM -Ready Prepared Plates	MP1806	Mueller Hinton Agar plate w/ 5% Sheep Blood	Low Risk	20/12/2012
RPM -Ready Prepared Plates	MP1806M	Mueller Hinton Agar plate w/ 5% Sheep Blood	Low Risk	04/07/2018
RPM -Ready Prepared Plates	MP1811	OFBL Agar Plate (Oxidation Fermentation Polymyxin Bacitracin Lactose Agar Plate)	Low risk	10/11/2020
RPM -Ready Prepared Plates	MP1825	Mueller Hinton Agar Plate with 2% Glucose w/Methylene Blue	Low Risk	20/12/2012
RPM -Ready Prepared Plates	MP1829	HiCrome™ ESBL Agar Plate	Low Risk	30/10/2018
RPM -Ready Prepared Plates	MP1831	HiCrome™ KPC Agar Plate	Low Risk	28/04/2017
RPM -Ready Prepared Plates	MP1837	HiCrome™ Staph Agar Plate, Modified	Low Risk	28/04/2017
RPM -Ready Prepared Plates	MP1858	Bifidobacterium Agar Modified Plate	Low Risk	20/12/2012
RPM -Ready Prepared Plates	MP188	D.T.M Agar Plate	Low Risk	30/10/2018
RPM -Ready Prepared Plates	MP1832	HiCrome™ Coliform Agar Plate, Modified	Low risk	10/11/2020
RPM -Ready Prepared Plates	MP1925	HiCrome™ VRE Agar Plate	Low Risk	30/10/2018
RPM -Ready Prepared Plates	MP1938	HiCrome™ Acinetobacter Agar Plate	Low Risk	16/12/2017
RPM -Ready Prepared Plates	MP1947	Enriched Tryptone Soya Agar Plate (ETSA)	Low risk	20/12/2012
RPM -Ready Prepared Plates	MP1948	Tryptone Soya Serum Bacitracin Vancomycin Agar (TSBV)	Low risk	20/12/2012
RPM -Ready Prepared Plates	MP1949	Tryptone Soya Agar w/ Hemin & Menadione	Low risk	20/12/2012
RPM -Ready Prepared Plates	MP1966	HiCrome™ Strep B Selective Agar Plate	Low risk	30/10/2018
RPM -Ready Prepared Plates	MP1974	HiCrome™ Rapid MRSA Agar Plate	Low risk	25/08/2016
RPM -Ready Prepared Plates	MP2085	Martin Lewin Agar	Low risk	30/10/2018
RPM -Ready Prepared Plates	MP2089	Burkholderia cepacia Selective Agar Plate	Low risk	10/11/2020
RPM -Ready Prepared Plates	MP211	BHI Agar Plate	Low risk	20/12/2012
RPM -Ready Prepared Plates	MP217	Bi.G.G.Y. Agar Plate (Nickerson Agar Plate)	Low risk	20/12/2012
RPM -Ready Prepared Plates	MP291	Schaedler Agar Plate	Low risk	16/12/2017
RPM -Ready Prepared Plates	MP1296	HiCrome™ Salmonella Agar Plate	Low risk	30/10/2018
RPM -Ready Prepared Plates	MP298	MacConkey Sorbitol Agar Plate	Low risk	16/12/2017
RPM -Ready Prepared Plates	MP317	EMB Agar Plate	Low risk	20/12/2012
RPM -Ready Prepared Plates	MP406	Pseudomonas Isolation Agar Plate	Low risk	30/10/2018
RPM -Ready Prepared Plates	MP413	Thayer Martin Agar Plate w/VCNT	Low risk	16/12/2017
RPM -Ready Prepared Plates	MP467	Hektoen Enteric Agar Plate	Low risk	04/07/2018
RPM -Ready Prepared Plates	MP491	Anaerobic Agar (Brewer) Plate	Low risk	04/07/2018
RPM -Ready Prepared Plates	MP540	Phenylethyl Blood Agar Plate w/ 5% Sheep Blood	Low risk	25/08/2016

RPM -Ready Prepared Plates	MP5269	Modified Nickerson Medium	Low risk	30/10/2018
RPM -Ready Prepared Plates	MP5208	CNA Agar Plate with 5% Sheep Blood	Low Risk	20/12/2012
RPM -Ready Prepared Plates	MP5304	Blood agar Plate w/5mg/l Gentamicin	Low risk	25/08/2016
RPM -Ready Prepared Plates	MP5316	Chocolate Agar Plate w/ 5% Sheep Blood	Low risk	28/04/2017
RPM -Ready Prepared Plates	MP5332	Sabouraud Dextrose Agar Plate w/Chloramphenicol & gentamicin	Low risk	04/07/2018
RPM -Ready Prepared Plates	MP5333	Chocolate Agar Plate w/ Bacitracin	Low risk	04/07/2018
RPM -Ready Prepared Plates	MP5334	Sabouraud Dextrose Agar plate w/Penicillin & Streptomycin	Low risk	04/07/2018
RPM -Ready Prepared Plates	MP5339	Regan Lowe Agar Plate (Charcoal Blood Plate w/Cephalexin)	Low risk	16/12/2017
RPM -Ready Prepared Plates	MP5340	Bordet Gengou Blood Agar Plate w/Cephalexin	Low risk	16/12/2017
RPM -Ready Prepared Plates	MP5380	BHI Agar Plate w/ Blood	Low risk	30/10/2018
RPM -Ready Prepared Plates	MP5381	BHI Agar Plate w/ Vancomycin	Low risk	30/10/2018
RPM -Ready Prepared Plates	MP5382	BHI Blood agar plate w/ Vancomycin	Low risk	30/10/2018
RPM -Ready Prepared Plates	MP5383	BCYE Selective Agar Plate	Low risk	30/10/2018
RPM -Ready Prepared Plates	MP5384	GBS Agar	Low risk	30/10/2018
RPM -Ready Prepared Plates	MP5386	Sabouraud Dextrose Agar Plate w/Gentamicin	Low risk	30/10/2018
RPM -Ready Prepared Plates	MP5387	Sabouraud Dextrose Agar Plate w/ Cycloheximide	Low risk	30/10/2018
RPM -Ready Prepared Plates	MP5389	Mueller Hinton Agar Plate w/ 2% NaCl	Low risk	30/10/2018
RPM -Ready Prepared Plates	MP5390	Helicobacter Pylori Selective Agar	Low risk	30/10/2018
RPM -Ready Prepared Plates	MP511	Middlebrook 7H11 Agar w/TCH	Low risk	04/07/2018
RPM -Ready Prepared Plates	MP5426	Middlebrook 7H11 Agar w/ PANTA supplement	Low risk	10/11/2020
RPM -Ready Prepared Plates	MP616	Tergitol-7 Agar Plate	Low risk	25/08/2016
RPM -Ready Prepared Plates	MP641	MRS Agar Plate	Low risk	28/04/2017
RPM -Ready Prepared Plates	MP636C	MYP Agar Plate (100mm plate)	Low risk	10/11/2020
RPM -Ready Prepared Plates	MP641-I	MRS Agar w/ 10 ppm cycloheximide	Low risk	28/04/2017
RPM -Ready Prepared Plates	MP664	Sabouraud Dextrose Agar Plate w/Chloramphenicol (50mg/L) and Cycloheximide 500mg/L	Low Risk	20/12/2012
RPM -Ready Prepared Plates	MP792	CLED Agar w/ Bromothymol Blue Plate	Low risk	20/12/2012
RPM -Ready Prepared Plates	MP805	Bacteroides Bile Esculin Agar Plate	Low risk	25/08/2016
RPM -Ready Prepared Plates	MP813I	BCYE Agar Plate	Low risk	30/10/2018
RPM -Ready Prepared Plates	MP843	Yersinia Selective Agar Plate	Low risk	30/10/2018
RPM -Ready Prepared Plates	MP870	TCBS Agar Plate	Low risk	25/08/2016
RPM -Ready Prepared Plates	MP975A	Anaerobic Blood Agar Plate	Low risk	25/08/2016
RPM -Ready Prepared Plates	MP994	Campylobacter Agar Plate	Low risk	20/12/2012
RPM -Ready Prepared Plates	MPV081	MacConkey HiVeg™ Agar Plate w/ CV, Nacl, 0.003% NR and 1.5% Agar Plate	Low risk	10/11/2020
RPM -Ready Prepared Plates	MPV173	Mueller Hinton HiVeg™ Agar Plate	Low risk	10/11/2020
RPM -Ready Prepared Plates	QP001	Middlebrooke 7H11 Agar Plate	Low risk	04/07/2018
RPM- Transport Medium w/ swabs	MQ651P	HiCulture™ Transport Swabs w/ Amies Medium w/ Charcoal	Low risk	20/12/2012
RPM- Transport Medium w/ swabs	MQ5203P	HiCulture™ Transport Swab w/ Enteric Pathogen Transport Medium	Low risk	20/12/2012
RPM- Transport Medium w/ swabs	MQ306P	HiCulture™ Transport Swabs w/ Stuart Transport Medium	Low risk	20/12/2012
RPM- Viral Transport Medium w/ swabs	AL167	HiViral Transport Medium	Low risk	20/12/2012
RPM- Viral Transport Medium w/ swabs	MS052A	HiCulture™ Transport Swabs w/Selenite Medium (A)	Low risk	25/08/2016

RPM- Viral Transport Medium w/ swabs	MS316	HiCulture™ Transport Swabs w/CVTR Medium	Low risk	20/12/2012
RPM- Viral Transport Medium w/ swabs	MS316S	HiCulture™ Transport Swabs w/CVTR Medium	Low risk	10/11/2020
RPM- Viral Transport Medium w/ swabs	MS316SR	HiCulture™ Transport Swabs w/CVTR Medium w/metal stick	Low risk	10/11/2020
RPM- Viral Transport Medium w/ swabs	MS316A	HiCulture™ Transport Swabs w/CVTR Medium,Modified	Low risk	25/08/2016
RPM- Viral Transport Medium w/ swabs	MS1145	HiCulture™ Listeria Isolation and Transport Swabs	Low risk	20/12/2012
RPM- Viral Transport Medium w/ swabs	MS1145R	HiCulture™ Listeria Isolation and Transport Swabs	Low risk	10/11/2020
RPM- Viral Transport Medium w/ swabs	MS1145S	HiCulture™ Listeria Isolation and Transport Swabs with metal stick	Low risk	20/12/2012
RPM- Transport Medium w/ swabs	MS1514	HiCulture™ Transport swabs w/Modified Campylobacter Thioglycollate Medium	Low risk	25/08/2016
RPM- Transport Medium w/ swabs	MS1514R	HiCulture™ Transport swabs w/Modified Campylobacter Thioglycollate Medium in polystyrene tube	Low risk	10/11/2020
RPM- Transport Medium w/ swabs	MS1557	HiCulture™ Transport swabs w/BHI broth for H.pylori	Low risk	25/08/2016
RPM- Transport Medium w/ swabs	MS1759	HiCulture™ Transport swabs	Low risk	25/08/2016
RPM- Transport Medium w/ swabs	MS2016A	HiCulture™ Transport Swabs w/ Soyabean Casein Digest Medium w/6.5% NaCl	Low risk	25/08/2016
RPM- Transport Medium w/ swabs	MS2016B	HiCulture™ Transport Swabs w/ Soyabean Casein Digest Medium w/6.5% NaCl	Low risk	25/08/2016
RPM- Transport Medium w/ swabs	MS202	HiCulture™ Transport Swabs w/ Cary Blair Medium	Low risk	20/12/2012
RPM- Transport Medium w/ swabs	MS202A	HiCulture™ Transport Swabs w/ Cary Blair Medium (A)	Low risk	20/12/2012
RPM- Transport Medium w/ swabs	MS202R	HiCulture™ Transport Swabs w/ Cary Blair Medium in polystyrene tube	Low risk	10/11/2020
RPM- Transport Medium w/ swabs	MS202S	HiCulture™ Transport Swabs w/ Cary Blair Medium with metal stick	Low risk	20/12/2012
RPM- Transport Medium w/ swabs	MS2055	HiCulture™ Transport Medium for Helicobacter pylori	Low risk	28/04/2017
RPM- Transport Medium w/ swabs	MS2127	HiCulture™ Transport Swab w/ Todd Hewitt Broth w/Colistin & Nalidixic Acid	Low risk	10/11/2020
RPM- Transport Medium w/ swabs	MS306	HiCulture™ Transport Swabs w/ Stuart Transport Medium	Low risk	20/12/2012
RPM- Transport Medium w/ swabs	MS306R	HiCulture™ Transport Swabs w/ Stuart Transport Medium	Low risk	10/11/2020
RPM- Transport Medium w/ swabs	MS306S	HiCulture™ Transport Swabs w/ Stuart Transport Medium with metal stick	Low risk	20/12/2012
RPM- Transport Medium w/ swabs	MS5002	HiCulture™ Transport Swabs w/ 0.85% Sodium chloride and 0.1% Buffered Ppetone Water in polystyrene tube	Low risk	04/07/2018
RPM- Transport Medium w/ swabs	MS5215	HiViral™ Transport Medium for Cloacal Samples	Low risk	25/08/2016
RPM- Transport Medium w/ swabs	MS5296	HiCulture™ Skim Milk Tryptone Glucose Glycerin Medium swabs	Low risk	25/08/2016
RPM- Transport Medium w/ swabs	MS5321	HiCulture Sterile swabs w/ 0.9% Saline	Low risk	22/04/2019
RPM- Transport Medium w/ swabs	MS651	HiCulture™ Transport Swabs w/ Amies Medium w/ Charcoal	Low risk	20/12/2012
RPM- Transport Medium w/ swabs	MS651R	HiCulture™ Transport Swabs w/ Amies Medium w/ Charcoal in polystyrene tube	Low risk	10/11/2020
RPM- Transport Medium w/ swabs	MS651S	HiCulture™ Transport Swabs w/ Amies Medium w/ Charcoal with metal stick	Low risk	20/12/2012
RPM- Transport Medium w/ swabs	MS651SR	HiCulture™ Transport Swabs w/ Amies Medium w/ Charcoal with metal stick	Low risk	10/11/2020
RPM- Transport Medium w/ swabs	MS684	HiCulture™ Transport Swabs w/ Amies Medium w/o Charcoal	Low risk	20/12/2012
RPM- Transport Medium w/ swabs	MS684R	HiCulture™ Transport Swabs w/ Amies Medium w/o	Low risk	10/11/2020

		Charcoal in polystyrene tube		
RPM- Transport Medium w/ swabs	MS684A	HiCulture™ Transport Swabs w/ Amies Medium (A)	Low risk	25/08/2016
RPM- Transport Medium w/ swabs	MS684B	HiCulture™ Transport Swabs w/ Amies Medium (B)	Low risk	25/08/2016
RPM- Transport Medium w/ swabs	MS684C	HiCulture™ Transport Swabs w/ Amies Medium (C)	Low risk	25/08/2016
RPM- Transport Medium w/ swabs	MS684D	HiCulture™ Transport Swabs w/ Amies Medium (D)	Low risk	25/08/2016
RPM- Transport Medium w/ swabs	MS684S	HiCulture™ Transport Swabs w/ Amies Medium w/o Charcoal with metal stick	Low risk	20/12/2012
RPM- Transport Medium w/ swabs	MS010	HiCulture™ Transport Swabs w/ Alternative Thioglycollate Medium	Low risk	20/12/2012
RPM- Transport Medium w/ swabs	MS010R	HiCulture™ Transport Swabs w/ Alternative Thioglycollate Medium in polystyrene tube	Low risk	10/11/2020
RPM- Transport Medium w/ swabs	MS010S	HiCulture™ Transport Swabs w/ Alternative Thioglycollate Medium with metal stick	Low risk	20/12/2012
RPM- Transport Medium w/ swabs	MS113	HiCulture™ Transport Swabs w/ Chlamyospore Medium	Low risk	20/12/2012
RPM- Transport Medium w/ swabs	MS113R	HiCulture™ Transport Swabs w/ Chlamyospore Medium in polystyrene tube	Low risk	10/11/2020
RPM- Transport Medium w/ swabs	MS113S	HiCulture™ Transport Swabs w/ Chlamyospore Medium with metal stick	Low risk	20/12/2012
RPM- Transport Medium w/ swabs	MS198S	HiCulture™ Transport Swab w/ Middlebrook 7H9 Broth w/metal stick	Low risk	20/12/2012
RPM- Transport Medium w/ swabs	MS2055	HiCulture™ Transport Medium for w/Helicobacter pylori	Low risk	16/12/2017
RPM- Ready Prepared Medium	MT001	Modified Middlebrook 7H9 Broth with Indicator	Low risk	20/12/2012
RPM- L.J.Medium Slants	SL001	L.J. Medium Slant	Low risk	20/12/2012
RPM- L.J.Medium Slants	SL001H	L.J. Medium in glass bottle	Low risk	04/07/2018
RPM- L.J.Medium Slants	SL001B	L.J. Medium Slant	Low risk	20/12/2012
RPM- L.J.Medium Slants	SL001L	L.J. Medium Slant in long tube	Low risk	20/12/2012
RPM- L.J.Medium Slants	SL001LD	L.J. Medium Slant (in long tube)	Low risk	20/12/2012
RPM- L.J.Medium Slants	SL001M	L.J.Medium Slant (In Medium Length tube)	Low risk	20/12/2012
RPM- L.J.Medium Slants	SL001T	L.J. Medium Slant in thick glass bottles	Low risk	20/12/2012
RPM- L.J.Medium Slants	SL002	L.J.Medium Kit	Low risk	20/12/2012
RPM- L.J.Medium Slants	SL003	L.J.Medium Plus Kit	Low risk	20/12/2012
RPM- L.J.Medium Slants	SL004	L.J.Medium w/ Pyruvate	Low risk	20/12/2012
RPM- L.J.Medium Slants	SL004L	L.J.Medium w/ Pyruvate (0.2%)	Low risk	20/12/2012
RPM- L.J.Medium Slants	SL005	L.J.Medium w/ Streptomycin (4 mcg/ml)	Low risk	20/12/2012
RPM- L.J.Medium Slants	SL005L	L.J.Medium w/Streptomycin (4 mcg / ml)	Low risk	20/12/2012
RPM- L.J.Medium Slants	SL006	L.J.Medium w/ INH	Low risk	20/12/2012
RPM- L.J.Medium Slants	SL007	L.J.Medium Slant w/ Rifampicin (40µg/ml)	Low risk	20/12/2012
RPM- L.J.Medium Slants	SL008	Acid Egg Medium Slant	Low risk	20/12/2012
RPM- L.J.Medium Slants	SL009	Acid Egg Medium Slant w/ pyruvate	Low risk	20/12/2012
RPM- L.J.Medium Slants	SL010	Modified L. J. Medium Plus Kit	Low risk	20/12/2012
RPM- L.J.Medium Slants	SL011	L.J. Medium Slant w/ Ciprofloxacin	Low risk	20/12/2012
RPM- L.J.Medium Slants	SL011L	L.J. Medium Slant w/ Ciprofloxacin (12.5 mcg/ml)	Low risk	20/12/2012
RPM- L.J.Medium Slants	SL012	L.J. Medium Slant w/ Amikacin	Low risk	20/12/2012
RPM- L.J.Medium Slants	SL013	L.J. Medium Slant w/ Clarithromycin	Low risk	20/12/2012
RPM- L.J.Medium Slants	SL014	L.J. Medium Slant w/Ethionamide (20µg/ml)	Low risk	20/12/2012
RPM- L.J.Medium Slants	SL015	L.J. Medium Slant w/Rifabutin (0.5 µg/ml)	Low risk	20/12/2012
RPM- L.J.Medium Slants	SL016	L. J. Medium Plus Kit w/ kanamycin µg/ml)	Low risk	20/12/2012

RPM- L.J.Medium Slants	SL017	L.J. Medium Slant w/ D-Cycloserine (30 µg/ml)	Low risk	20/12/2012
RPM- L.J.Medium Slants	SL017L	L.J. Medium Slant w/ D-Cycloserine (30 µg/ml)	Low risk	20/12/2012
RPM- L.J.Medium Slants	SL018	L.J.Medium w/Pyrazinamide of pH 5.5	Low risk	20/12/2012
RPM- L.J.Medium Slants	SL018L	L.J. Medium Slant w/ Pyrazinamide pH 5.5	Low risk	20/12/2012
RPM- L.J.Medium Slants	SL019	L.M. Slant (Loeffler Medium)	Low risk	20/12/2012
RPM- L.J.Medium Slants	SL020	L.J. Medium w/TCH	Low risk	20/12/2012
RPM- L.J.Medium Slants	SL021	L.J. Medium Slant w/ p-Nitrobenzoic acid (500 µg/ml)	Low risk	20/12/2012
RPM- L.J.Medium Slants	SL021L	L.J. Medium Slant w/ p-Nitrobenzoic acid	Low risk	20/12/2012
RPM- L.J.Medium Slants	SL022	L.J. Medium Slant w/o Glycerol	Low risk	20/12/2012
RPM- L.J.Medium Slants	SL023	Tuberculosis First Line Kit (Total 7 slants)	Low risk	20/12/2012
RPM- L.J.Medium Slants	SL023L	Tuberculosis First Line Kit (Total 7 slants)	Low risk	20/12/2012
RPM- L.J.Medium Slants	SL023LD	Tuberculosis First Line Kit (Total 7slants)	Low risk	20/12/2012
RPM- L.J.Medium Slants	SL023R	Tuberculosis First Line Kit (Total 7 slants)	Low risk	20/12/2012
RPM- L.J.Medium Slants	SL024	Tuberculosis Second Line Kit (Total 10 slants)	Low risk	20/12/2012
RPM- L.J.Medium Slants	SL024L	Tuberculosis Second Line Kit (Total 10 slants)	Low risk	20/12/2012
RPM- L.J.Medium Slants	SL024LD	Tuberculosis Second Line Kit (Total 10 slants)	Low risk	20/12/2012
RPM- L.J.Medium Slants	SL024R	Tuberculosis Second Line Kit (Total 8 slants)	Low risk	20/12/2012
RPM- L.J.Medium Slants	SL025	Dorset Egg Medium Slant	Low risk	20/12/2012
RPM- L.J.Medium Slants	SL026	L.J. Medium Slant w/Streptomycin (5mcg)	Low risk	20/12/2012
RPM- L.J.Medium Slants	SL027	L.J. Medium Slant w/Ethambutol (2mcg)	Low risk	20/12/2012
RPM- L.J.Medium Slants	SL029	L.J. Medium Slant w/P-Amino Salicylic acid	Low risk	20/12/2012
RPM- L.J.Medium Slants	SL029L	L.J. Medium Slant w/ p-Aminosalicylic acid	Low risk	20/12/2012
RPM- Ready Prepared Slants	SL031	Dermatophyte Test Medium Slant	Low risk	20/12/2012
RPM- Ready Prepared Slants	SL032	Kligler Iron Agar Slant	Low risk	20/12/2012
RPM- Ready Prepared Slants	SL033	Motility Indole Lysine Agar Slant	Low risk	20/12/2012
RPM- Ready Prepared Slants	SL034	Simmons Citrate Agar Slant	Low risk	20/12/2012
RPM- Ready Prepared Slants	SL034T	Simmon Citrate Agar Slant in long tubes	Low risk	20/12/2012
RPM- Ready Prepared Slants	SL035	Urea Agar Slant	Low risk	20/12/2012
RPM- Ready Prepared Slants	SL035T	Urea Agar Slant in Tube	Low risk	20/12/2012
RPM- Ready Prepared Slants	SL036	Sabouraud Dextrose Agar Slant	Low risk	20/12/2012
RPM- Ready Prepared Slants	SL036L	Sabouraud Dextrose Agar Slant	Low risk	08/12/2017
RPM- L.J.Medium Slants	SL037	Tuberculosis First Line Plus Kit (Total 9 slants)	Low risk	20/12/2012
RPM- L.J.Medium Slants	SL037R	Tuberculosis First Line Plus Kit (9 slants)	Low risk	20/12/2012
RPM- L.J.Medium Slants	SL038	Tuberculosis Second Line Plus Kit (Total 11 slants)	Low risk	20/12/2012
RPM- L.J.Medium Slants	SL038R	Tuberculosis Second Line Plus Kit (11 slants)	Low risk	20/12/2012
RPM- L.J.Medium Slants	SL038U	Lowenstein - Jensen Medium Slant with tu	Low risk	20/12/2012
RPM- L.J.Medium Slants	SL040	L.J. Medium Slant w/ Moxifloxacin	Low risk	20/12/2012
RPM- Ready Prepared Slants	SL041	Gelatin Agar Slant	Low risk	20/12/2012
RPM- Ready Prepared Slants	SL042	MIU Medium Slant	Low risk	20/12/2012
RPM- Ready Prepared Slants	SL043	Nitrate Agar Slant	Low risk	20/12/2012
RPM- Ready Prepared Slants	SL044	Phenyl Alanine Agar Slant	Low risk	20/12/2012
RPM- Ready Prepared Slants	SL045	Triple Sugar Iron Agar Slant	Low risk	20/12/2012
RPM- Ready Prepared Slants	SL045T	Triple Sugar Iron Agar Slant in Tube	Low risk	20/12/2012
RPM- L.J.Medium Slants	SL047	L.J.Medium Slant w/ Ethambutol (2µg/ml)	Low risk	20/12/2012
RPM- L.J.Medium Slants	SL049	L.J. Medium Slant w/ Ofloxacin (2 µg/ml)	Low risk	20/12/2012

RPM- L.J.Medium Slants	SL049L	L.J Medium Slant w/ Ofloxacin (2µg/ml) (long tube)	Low risk	20/12/2012
RPM- L.J.Medium Slants	SL055L	L.J.Medium Slant w/ Isoniazide (0.2 mcg/ml)	Low risk	20/12/2012
RPM- L.J.Medium Slants	SL061	L.J. Medium Slant w/ Pyrazinamide (50 µg/ml)	Low risk	20/12/2012
RPM- L.J.Medium Slants	SL066	L.J. Medium Slant w/ Capreomycin (20 µg/ml)	Low risk	20/12/2012
RPM- L.J.Medium Slants	SL067	L.J. Medium Slant w/ Capreomycin (40 µg/ml)	Low risk	20/12/2012
RPM- L.J.Medium Slants	SL067L	L.J Medium Slant w/ Capreomycin (40 µg/ml) (long tube)	Low risk	20/12/2012
RPM- L.J.Medium Slants	SL070	L.J. Medium Slant w/ D-Cycloserine (40 µg/ml)	Low risk	20/12/2012
RPM- L.J.Medium Slants	SL071	L.J. Medium Slant w/ Ethambutol (4 µg/ml)	Low risk	20/12/2012
RPM- L.J.Medium Slants	SL072	L.J. Medium Slant w/ Ethambutol (5 µg/ml)	Low risk	20/12/2012
RPM- L.J.Medium Slants	SL076	L.J. Medium Slant w/Ethionamide (40µg/ml)	Low risk	20/12/2012
RPM- L.J.Medium Slants	SL078	L.J. Medium Slant w/ Isoniazide (0.2 µg/ml)	Low risk	20/12/2012
RPM- L.J.Medium Slants	SL079	L.J. Medium Slant w/ Isoniazide (5 µg/ml)	Low risk	20/12/2012
RPM- L.J.Medium Slants	SL081	L.J. Medium Slant w/ Kanamycin (20 µg/ml)	Low risk	20/12/2012
RPM- L.J.Medium Slants	SL081L	L.J. Medium Slant w/ Kanamycin (20µg/ml)	Low risk	20/12/2012
RPM- L.J.Medium Slants	SL082	L.J. Medium Slant w/ Kanamycin (30 µg/ml)	Low risk	20/12/2012
RPM- L.J.Medium Slants	SL091	L.J. Medium Slant w/ p-Aminosalicyclic acid (0.25 µg/ml)	Low risk	20/12/2012
RPM- L.J.Medium Slants	SL092	L.J. Medium Slant w/ p-Aminosalicyclic acid (0.5 µg/ml)	Low risk	20/12/2012
RPM- L.J.Medium Slants	SL092L	L.J. Medium Slant w/ p-Aminosalicyclic acid	Low risk	20/12/2012
RPM- L.J.Medium Slants	SL094	L.J. Medium Slant w/ Ciprofloxacin 2µg/ml	Low risk	20/12/2012
RPM- L.J.Medium Slants	SL098	L.J. Medium Slant w/ Pyruvate (0.2%)	Low risk	20/12/2012
RPM- L.J.Medium Slants	SL099	L.J.Medium Slants w/ Isoniazid (0.2 µg/ml)	Low risk	20/12/2012
RPM- L.J.Medium Slants	SL105L	L.J.Medium Slant w/ Rifampicin (20mcg/ml)	Low risk	20/12/2012
RPM- L.J.Medium Slants	SL107	L.J. Medium Slant w/ Rifampicin (50 µg/ml)	Low risk	20/12/2012
RPM- L.J.Medium Slants	SL109	L.J. Medium Slant w/ Streptomycin (8 µg/ml)	Low risk	20/12/2012
RPM- L.J.Medium Slants	SL110	L.J. Medium Slant w/ Streptomycin (25 µg/ml)	Low risk	20/12/2012
RPM- L.J.Medium Slants	SL115	L.J. Medium Slant w/ Pyrazinamide of pH 5.5	Low risk	20/12/2012
RPM- L.J.Medium Slants	SL115L	L.J. Medium Slant w/ Pyrazinamide pH 5.5	Low risk	20/12/2012
RPM- Ready Prepared Slants	SL116	Rapid UTI Diagnostic Slants	Low risk	20/12/2012
RPM- L.J.Medium Slants	SL120L	L.J. Medium Slant pH 5.5	Low risk	20/12/2012
RPM- L.J.Medium Slants	SL121	HiPyrazide glass tube w/ PYZ agar	Low risk	20/12/2012
RPM- L.J.Medium Slants	SL121R	HiPyrazide glass tube w/ PYZ agar	Low risk	10/11/2020
RPM- L.J.Medium Slants	SL122	HiCatalase glass tubes w/ 5ml of L.J. medium	Low risk	20/12/2012
RPM- L.J.Medium Slants	SL122R	HiCatalase glass tubes w/ 5ml of L.J. medium	Low risk	10/11/2020
RPM- L.J.Medium Slants	SL123	Tuberculosis first line plus kit (Modified)	Low risk	20/12/2012
RPM- L.J.Medium Slants	SL124	L.J. Medium slant (Tubes with Aluminium caps)	Low risk	20/12/2012
RPM- L.J.Medium Slants	SL125	L.J. Medium w/Isoniazid (1.0µg/ml) (Tube	Low risk	20/12/2012
RPM- L.J.Medium Slants	SL125L	L.J.Medium Slant w/ Isoniazide (1mcg/ml)	Low risk	20/12/2012
RPM- L.J.Medium Slants	SL125M	L.J.Medium Slant w/ Isoniazid in Maccart	Low risk	20/12/2012
RPM- L.J.Medium Slants	SL126	L.J. Medium w/Rifampicin (40.0µg/ml)	Low risk	20/12/2012
RPM- L.J.Medium Slants	SL126L	L.J.Medium Slant w/ Rifampicin (40mcg/ml)	Low risk	20/12/2012
RPM- L.J.Medium Slants	SL126M	L.J.Medium Slant w/ Rifampicin in Maccar	Low risk	20/12/2012
RPM- L.J.Medium Slants	SL127	L.J. Medium w/Ethambutol (2.0µg/ml)	Low risk	20/12/2012
RPM- L.J.Medium Slants	SL127L	L.J. Medium Slant w/Ethambutol (2µg/ml)	Low risk	20/12/2012
RPM- L.J.Medium Slants	SL128	L.J. Medium w/Streptomycin (10.0µg/ml)	Low risk	20/12/2012
RPM- L.J.Medium Slants	SL128L	L.J.Medium w/Streptomycin - 10mcg / Ml	Low risk	20/12/2012

RPM- L.J.Medium Slants	SL129	L.J. Medium w/Ethionamide (30.0µg/ml)	Low risk	20/12/2012
RPM- L.J.Medium Slants	SL130	L.J. Medium w/Kanamycin (30.0µg/ml)	Low risk	20/12/2012
RPM- L.J.Medium Slants	SL130L	L.J. Medium Slant w/ Kanamycin (30µg/ml)	Low risk	20/12/2012
RPM- L.J.Medium Slants	SL131	L.J. Medium w/Ofloxacin (2.0µg/ml)	Low risk	20/12/2012
RPM- L.J.Medium Slants	SL132	L.J. Medium w/Capreomycin (30.0µg/ml)	Low risk	20/12/2012
RPM- L.J.Medium Slants	SL133	L.J. Medium w/P-aminosalicylic acid (1.0	Low risk	20/12/2012
RPM- L.J.Medium Slants	SL136L	Tuberculosis Second Line Kit, Modified	Low risk	20/12/2012
RPM- L.J.Medium Slants	SL141	Modified L. J. Medium Plus Kit	Low risk	20/12/2012
RPM- Ready Prepared Slants	SL142	Cystine Tryptone Agar with 1% Sugars	Low risk	20/12/2012
RPM- Ready Prepared Slants	SL143	Tuberculosis First Line Kit, Modified	Low risk	20/12/2012
RPM- L.J.Medium Slants	SL144	L.J Medium slant w/ Amikacin (1.0 µg/ml)	Low risk	20/12/2012
RPM- L.J.Medium Slants	SL147	L.J. Medium Slant w/Rifampicin (64µg/ml)	Low risk	20/12/2012
RPM- L.J.Medium Slants	SL147	L.J Medium slant w/ Rifampicin (64 µg/ml)	Low risk	20/12/2012
RPM- L.J.Medium Slants	SL148	L.J. Medium Slant w/Ethambutol (6µg/ml)	Low risk	20/12/2012
RPM- L.J.Medium Slants	SL148	L.J Medium slant w/ Ethambutol (6 µg/ml)	Low risk	20/12/2012
RPM- L.J.Medium Slants	SL149	L.J. Medium Slant w/Streptomycin (16µg/ml)	Low risk	20/12/2012
RPM- L.J.Medium Slants	SL149	L.J Medium slant w/ Streptomycin (16 µg/ml)	Low risk	20/12/2012
RPM- L.J.Medium Slants	SL150	L.J Medium slant w/ Streptomycin (32 µg/ml)	Low risk	20/12/2012
RPM- L.J.Medium Slants	SL151	TB Five Antitubercular Kit w/o Control	Low risk	20/12/2012
RPM- L.J.Medium Slants	SL152	Kit for Mycobiograve in Lowenstein Jensen	Low risk	20/12/2012
RPM- L.J.Medium Slants	SL153	Tuberculosis First Line Plus Kit (Modified)	Low risk	20/12/2012
RPM- L.J.Medium Slants	SL154	L.J. Medium Plus Kit (total 9 slants)	Low risk	20/12/2012
RPM- L.J.Medium Slants	SL155L	L.J. Medium Slant w/ TCH	Low risk	20/12/2012
RPM- L.J.Medium Slants	SL156	L.J.Medium Slant w/Rifampicin (128 µg /ml)	Low risk	20/12/2012
RPM- L.J.Medium Slants	SL157	L.J.Medium Slant w/Pyrazinamide pH 5.5	Low risk	20/12/2012
RPM- L.J.Medium Slants	SL158	L.J.Medium Slant w/Ethambutol (8 µg/ml)	Low risk	20/12/2012
RPM- L.J.Medium Slants	SL159	L.J. Medium Slant w/Ethambutol (16 µg/ml)	Low risk	20/12/2012
RPM- L.J.Medium Slants	SL160L	Tuberculosis kit with antitubercular Age	Low risk	20/12/2012
RPM- L.J.Medium Slants	SL161	L.J. Medium Slant w/ Ciprofloxacin (16 µg/ml)	Low risk	20/12/2012
RPM- L.J.Medium Slants	SL162	L.J. Medium Slant w/ Ciprofloxacin	Low risk	20/12/2012
RPM- L.J.Medium Slants	SL163	L.J. Medium Slant w/Amikacin (20 µg/ml)	Low risk	20/12/2012
RPM- L.J.Medium Slants	SL164	L.J. Medium Slant w/Amikacin (700 µg/ml)	Low risk	20/12/2012
RPM- L.J.Medium Slants	SL165L	L.J.Medium w/ Pyruvate (0.48%)	Low risk	20/12/2012
RPM- L.J.Medium Slants	SL166L	Tuberculosis kit with antitubercular Agent	Low risk	20/12/2012
RPM- L.J.Medium Slants	SL167	L.J. Medium slants w/ Augmentin(20µg/ml)	Low risk	20/12/2012
RPM- L.J.Medium Slants	SL168	L.J.Medium Slant w/ Ofloxacin (40µg/ml)	Low risk	25/08/2016
RPM- L.J.Medium Slants	SL168L	L.J.Medium Slant w/ Ofloxacin (40µg/ml) (long tube)	Low risk	20/12/2012
RPM- L.J.Medium Slants	SL169	L.J.Medium Slant w/ Ethionamide (20µg/ml)	Low risk	25/08/2016
RPM- L.J.Medium Slants	SL169L	L.J.Medium Slant w/ Ethionamide (20µg/ml) (long tube)	Low risk	20/12/2012
RPM- L.J.Medium Slants	SL170L	L.J Medium Slant w/ Ethionamide (40µg/ml) (long tube)	Low risk	20/12/2012
RPM- L.J.Medium Slants	SL171L	L.J Medium Slant w/ p-Amino salicylic acid (1µg/ml) (long tube)	Low risk	20/12/2012
RPM- Ready Prepared Slants	SL172	Chocolate Agar Slant	Low risk	20/12/2012
RPM- Ready Prepared Slants	SL173	Nutrient Agar Slant	Low risk	20/12/2012
RPM- Ready Prepared Slants	SL174	B.C.G.-Dextrose Agar Butt (Synder Test Agar)	Low risk	20/12/2012

RPM- L.J.Medium Slants	SL175L	L.J.Medium Slant w/ Amikacin (30mcg/ml)	Low risk	20/12/2012
RPM- L.J.Medium Slants	SL176L	L.J.Medium Slant w/ Ofloxacin (4mcg/ml)	Low risk	20/12/2012
RPM- L.J.Medium Slants	SL177	Tuberculosis First Line Kit, Modified (Total 5 slants)	Low risk	20/12/2012
RPM- L.J.Medium Slants	SL179	L.J.Slopes for BCG Vaccines	Low risk	20/12/2012
RPM- Ready Prepared Slants	SL180	BHI Agar Slant w/5% Sheep Blood	Low risk	20/12/2012
RPM- Ready Prepared Slants	SL181	BHI Agar Slant w/10 % Sheep Blood,Chloramphenicol and Gentamicin	Low risk	20/12/2012
RPM- Ready Prepared Slants	SL182	BHI CC Agar Slant w/10 % Sheep Blood and Gentamicin	Low risk	20/12/2012
RPM- L.J.Medium Slants	SL187	L.J.Medium slants w/ LCN Supplement	Low risk	25/08/2016
RPM- L.J.Medium Slants	SL188L	L.J.Medium Slant w/ Levofloxacin (2 mg/ml)	Low risk	16/12/2017
RPM- L.J.Medium Slants	SL189L	L.J.Medium Slant w/ Levofloxacin (2.5 mg/ml)	Low risk	16/12/2017
RPM- L.J.Medium Slants	SL190	L.J.Medium Slant w/ Rifampicin (20mcg/ml)	Low risk	04/07/2018
RPM- L.J.Medium Slants	SL191	L.J.Medium Slant w/ Amikacin (8mcg/ml)	Low risk	04/07/2018
RPM- L.J.Medium Slants	SL192	L.J.Medium Slant w/ Ofloxacin (5mcg/ml)	Low risk	04/07/2018
RPM- L.J.Medium Slants	SL193	L.J.Medium Slant w/ Levofloxacin (5 mcg/ml)	Low risk	04/07/2018
RPM- L.J.Medium Slants	SL194	L.J.Medium Slant w/ Ethionamide (5 mcg/ml)	Low risk	04/07/2018
RPM- L.J.Medium Slants	SL195	L.J.Medium Slant w/ Ethionamide (25 mcg/ml)	Low risk	04/07/2018
RPM- L.J.Medium Slants	SL196	L.J.Medium Slant w/ Prothionamide (5 mcg/ml)	Low risk	04/07/2018
RPM- L.J.Medium Slants	SL197	L.J.Medium Slant w/ Prothionamide (25 mcg/ml)	Low risk	04/07/2018
RPM- L.J.Medium Slants	SL198	L.J.Medium Slant w/ Linezolid (30 mcg/ml)	Low risk	04/07/2018
RPM- L.J.Medium Slants	SL199	L.J.Medium Slant w/ Clofazimine (1 mcg/ml)	Low risk	04/07/2018
RPM- L.J.Medium Slants	SL202	Middlebrook 7H10 Agar Slant	Low risk	30/10/2018
RPM- L.J.Medium Slants	SL204	L.J. Medium Slant w/ Prothionamide (40 mcg/ml)	Low risk	22/04/2019
RPM- L.J.Medium Slants	SL205	L.J. Medium Slant w/ Amikacin (40 mcg/ml)	Low risk	22/04/2019
RPM- L.J.Medium Slants	SL211	BHI Agar Slant	Low risk	30/10/2018
RPM- L.J.Medium Slants	SL1067L	Sabouraus Chloramphenicol Agar Slant	Low risk	16/12/2017
RPM- Ready Prepared Solid Medium	SM001	Nutrient Agar	Low risk	20/12/2012
RPM- Ready Prepared Solid Medium	SM001CCL	Nutrient Agar	Low risk	22/04/2019
RPM- Ready Prepared Solid Medium	SM001D	Nutrient Agar	Low risk	20/12/2012
RPM- Ready Prepared Solid Medium	SM016C	Brilliant Green Agar, Modified	Low risk	22/04/2019
RPM- Ready Prepared Solid Medium	SM027C	Bismuth Sulphite Agar	Low risk	22/04/2019
RPM- Ready Prepared Solid Medium	SM049D	Violet Red Bile Agar	Low risk	22/04/2019
RPM- Ready Prepared Solid Medium	SM063	Sabouraud Dextrose Agar	Low risk	04/07/2018
RPM- Ready Prepared Solid Medium	SM063D	Sabouraud Dextrose Agar	Low risk	25/08/2016
RPM- Ready Prepared Solid Medium	SM078	Kligler Iron Agar	Low risk	25/08/2016
RPM- Ready Prepared Solid Medium	SM081	MacConkey Agar	Low risk	20/12/2012
RPM- Ready Prepared Solid Medium	SM081D	MacConkey Agar	Low risk	20/12/2012
RPM- Ready Prepared Solid Medium	SM082	MacConkey Agar	Low risk	20/12/2012
RPM- Ready Prepared Solid Medium	SM082D	MacConkey Agar	Low risk	20/12/2012
RPM- Ready Prepared Solid Medium	SM091	Plate Count Agar	Low risk	04/07/2018
RPM- Ready Prepared Solid Medium	SM091D	Plate Count Agar	Low risk	22/04/2019
RPM- Ready Prepared Solid Medium	SM091DCC	Plate Count Agar	Low risk	04/07/2018
RPM- Ready Prepared Solid Medium	SM091M	Plate Count Agar	Low risk	04/07/2018
RPM- Ready Prepared Solid Medium	SM103A	Modified Chocolate Agar Kit w/o Selective	Low risk	25/08/2016
RPM- Ready Prepared Solid Medium	SM103AR	Modified Chocolate Agar kit w/osupplement	Low risk	10/11/2020

RPM- Ready Prepared Solid Medium	SM103H	Modified Chocolate Agar kit	Low risk	25/08/2016
RPM- Ready Prepared Solid Medium	SM103HR	Modified Chocolate Agar kit w/supplement	Low risk	10/11/2020
RPM- Ready Prepared Solid Medium	SM1067	Sabouraud Chloramphenicol Agar Plate	Low risk	04/07/2018
RPM- Ready Prepared Solid Medium	SM1067C	Sabouraud Chloramphenicol Agar Plate	Low risk	04/07/2018
RPM- Ready Prepared Solid Medium	SM1067DC C	Sabouraud Chloramphenicol Agar Plate	Low risk	
RPM- Ready Prepared Solid Medium	SM1067CC L	Sabouraud Chloramphenicol Agar Plate	Low risk	04/07/2018
RPM- Ready Prepared Solid Medium	SM1296D	HiCrome™ Salmonella Agar	Low risk	04/07/2018
RPM- Ready Prepared Solid Medium	SM1297A	HiCrome™ Candida Differential Agar	Low risk	25/08/2016
RPM- Ready Prepared Solid Medium	SM1353	HiCrome™ UTI Agar	Low risk	20/12/2012
RPM- Ready Prepared Solid Medium	SM1353CC	HiCrome™ UTI Agar	Low risk	04/07/2018
RPM- Ready Prepared Solid Medium	SM154D	Reinforced Clostridial Agar	Low risk	10/11/2020
RPM- Ready Prepared Solid Medium	SM173	Mueller Hinton Agar	Low risk	20/12/2012
RPM- Ready Prepared Solid Medium	SM173CCL	Mueller Hinton Agar	Low risk	22/04/2019
RPM- Ready Prepared Solid Medium	SM173D	Mueller Hinton Agar	Low risk	20/12/2012
RPM- Ready Prepared Solid Medium	SM211	BHI Agar	Low risk	20/12/2012
RPM- Ready Prepared Solid Medium	SM211D	BHI Agar	Low risk	20/12/2012
RPM- Ready Prepared Solid Medium	SM331C	Wilson Blair Agar	Low risk	22/04/2019
RPM- Ready Prepared Solid Medium	SM434	GC Agar	Low risk	25/08/2016
RPM- Ready Prepared Solid Medium	SM434R	Modified GC Agar Kit	Low risk	10/11/2020
RPM- Ready Prepared Solid Medium	SM434H	GC Agar, Modified	Low risk	25/08/2016
RPM- Ready Prepared Solid Medium	SM467	Hektoen Enteric Agar	Low risk	20/12/2012
RPM- Ready Prepared Solid Medium	SM467D	Hektoen Enteric Agar	Low risk	20/12/2012
RPM- Ready Prepared Solid Medium	SM792	C.L.E.D. Agar w/ Bromothymol Blue	Low risk	30/10/2018
RPM- Ready Prepared Solid Medium	SM933D	Orange Serum Agar	Low risk	22/04/2019
RPM- Ready Prepared UTI Diagnostic Kits	K041	Rapid UTI ABST Kit	Low Risk	20/12/2012
RPM- Ready Prepared UTI Diagnostic Kits	K084A	Ecopathology Uro Kit-1	Low risk	20/12/2012
RPM- Ready Prepared UTI Diagnostic Kits	K084B	Ecopathology Uro Kit-1, Modified	Low risk	30/10/2018
RPM- Ready Prepared UTI Diagnostic Kits	K085A	Ecopathology Uro Kit-2	Low risk	20/12/2012
RPM- Ready Prepared UTI Diagnostic Kits	K089	Ecopathology Uro Kit-3	Low risk	20/12/2012
RPM- Ready Prepared UTI Diagnostic Kits	K090	Ecopathology Uro Kit-4	Low risk	20/12/2012
RPM- Biochemical Kits for Mycobacteria	K043	Nitrate Reduction Test Kit for Mycobacteria	Low risk	20/12/2012
RPM- Biochemical Kits for Mycobacteria	K044	Catalase Test Kit for Mycobacteria	Low risk	20/12/2012
RPM- Biochemical Kits for Mycobacteria	K044R	Catalase Test Kit for Mycobacteria	Low risk	10/11/2020
RPM- Biochemical Kits for Mycobacteria	K045	Pyrazinimide Test Kit for Mycobacteria	Low risk	20/12/2012
RPM- Biochemical Kits for Mycobacteria	K045R	Pyrazinimide Test Kit for Mycobacteria (Low risk	10/11/2020
RPM- Biochemical Kits for Mycobacteria	K046	Thiopene Carboxylic Hydrazide Test Kit for Mycobacteria	Low risk	20/12/2012

RPM- Biochemical Kits for Mycobacteria	K047	Niacin Detection Kit w/ syringe	Low risk	20/12/2012
RPM- Biochemical Kits for Mycobacteria	K048	Niacin Detection Kit Modified w/o syringe	Low risk	20/12/2012
RPM- Biochemical Kits for Mycobacteria	K050	Kit for Selective Isolation of M.tuberculosis	Low risk	20/12/2012
RPM-MRSA Kits	K058S	MRSA Alert kit (w/swabs)	Low risk	25/08/2016
RPM-MRSA Kits	K058SR	MeReSa Agar Base,MRSA Alert Kit (w/swabs)	Low risk	25/08/2016
RPM-MRSA Kits	K086R	Enterococcus Presumptive Broth (VRE Alert)	Low risk	25/08/2016
RPM- Biochemical Identification Kits	KB001	HiIMViC™ Biochemical Test Kit	Low risk	20/12/2012
RPM- Biochemical Identification Kits	KB001R	HiIMViC Biochemical Test Kit	Low risk	25/08/2016
RPM- Biochemical Identification Kits	KB002	HiAssorted™ Biochemical Test Kit	Low risk	20/12/2012
RPM- Biochemical Identification Kits	KB002R	HiAssorted Biochemical Test Kit	Low risk	25/08/2016
RPM- Biochemical Identification Kits	KB003	Hi25™ Enterobacteriaceae Identification Kit	Low risk	20/12/2012
RPM- Biochemical Identification Kits	KB003R	Hi25 Enterobacteriaceae Identification Kit	Low risk	25/08/2016
RPM- Biochemical Identification Kits	KB004	HiStaph™ Identification Kit	Low risk	20/12/2012
RPM- Biochemical Identification Kits	KB004R	HiStaph Identification Kit	Low risk	25/08/2016
RPM- Biochemical Identification Kits	KB005A	HiStrep™ Identification Kit	Low risk	20/12/2012
RPM- Biochemical Identification Kits	KB005AR	HiStrep Identification Kit	Low risk	25/08/2016
RPM- Biochemical Identification Kits	KB006	HiCandida™ Identification Kit	Low risk	20/12/2012
RPM- Biochemical Identification Kits	KB006R	HiCandida Identification Kit	Low risk	25/08/2016
RPM- Biochemical Identification Kits	KB007	HiVibrio™ Identification Kit	Low risk	20/12/2012
RPM- Biochemical Identification Kits	KB007R	HiVibrio Identification Kit	Low risk	25/08/2016
RPM- Biochemical Identification Kits	KB008	HiNeisseria™ Identification Kit	Low risk	20/12/2012
RPM- Biochemical Identification Kits	KB008R	HiNeisseria Identification Kit	Low risk	25/08/2016
RPM- Biochemical Identification Kits	KB009	HiCarbo™ Kit	Low risk	20/12/2012
RPM- Biochemical Identification Kits	KB009R	HiCarbo Kit	Low risk	25/08/2016
RPM- Biochemical Identification Kits	KB009A	HiCarbo™ Kit- Part A	Low risk	20/12/2012
RPM- Biochemical Identification Kits	KB009AR	HiCarbo Kit- Part A	Low risk	25/08/2016
RPM- Biochemical Identification Kits	KB009B1	HiCarbo™ Kit- Part B	Low risk	20/12/2012

RPM- Biochemical Identification Kits	KB009C	HiCarbo™ Kit- Part C	Low risk	20/12/2012
RPM- Biochemical Identification Kits	KB010	HiE. coli™ Identification Kit	Low risk	20/12/2012
RPM- Biochemical Identification Kits	KB010R	HiE.coli™ Identification Kit	Low risk	25/08/2016
RPM- Biochemical Identification Kits	KB011	HiSalmonella™ Identification Kit	Low risk	20/12/2012
RPM- Biochemical Identification Kits	KB011R	HiSalmonella Identification Kit	Low risk	25/08/2016
RPM- Biochemical Identification Kits	KB012A	HiListeria™ Identification Kit	Low risk	20/12/2012
RPM- Biochemical Identification Kits	KB012AR	HiListeria Identification Kit	Low risk	25/08/2016
RPM- Biochemical Identification Kits	KB013	HiBacillus™ Identification Kit	Low risk	20/12/2012
RPM- Biochemical Identification Kits	KB013R	HiCarbo Kit (HiBacillus Identification Kit)	Low risk	25/08/2016
RPM- Biochemical Identification Kits	KB014	HiAcinetobacter™ Identification Kit	Low risk	20/12/2012
RPM- Biochemical Identification Kits	KB014R	HiCarbo Kit (HiAcinetobacter Identification Kit)	Low risk	25/08/2016
RPM- Biochemical Identification Kits	KB015	HiCorynebacteria Identification Kit	Low risk	12/08/2015
RPM- Biochemical Identification Kits	KB016	Hi24™ Enterobacteriaceae Identification Kit,Modified	Low risk	12/08/2015
RPM- Biochemical Identification Kits	KB019	Hi24™ Nonfermenters Identification Kit	Low risk	28/04/2017
RPM- Biochemical Identification Kits	KB020	HiLacto Identification Kit	Low risk	28/04/2017
RPM- Biochemical Identification Kits	KB021	HiBifido Identification Kit	Low risk	28/04/2017
RPM- Biochemical Identification Kits	KBM001	HiMotility™ Biochemical Kit for E.coli	Low risk	20/12/2012
RPM- Biochemical Identification Kits	KBM001R	HiMotility Biochemical Kit for E.coli	Low risk	25/08/2016
RPM- Biochemical Identification Kits	KBM002	HiMotility™ Biochemical Kit for Salmonella	Low risk	20/12/2012
RPM- Biochemical Identification Kits	KBM002R	HiMotility™ Biochemical Kit for Salmonella	Low risk	25/08/2016
RPM- Biochemical Identification Kits	KBM003A	HiMotility™ Biochemical Kit for Listeria	Low risk	20/12/2012
RPM- Biochemical Identification Kits	KBM003AR	HiMotility™ Biochemical Kit for Listeria	Low risk	25/08/2016

Product group	Type/ Model / Ref number	Device Name	Risk Class	Date of CE compliance
Epidemeology Screening Kit				
ESK- Hi Aureus Confirmation Kits	K053AD	Hiaureus Coagulase Confrimation Kit (w/o swabs)	Low risk	07/02/2012
ESK- Hi Aureus Confirmation Kits	K053ADS	Hiaureus Coagulase Confrimation Kit (w/ swabs)	Low risk	07/02/2012

Product group	Type/ Model / Ref number	Device Name	Risk Class	Date of CE compliance
Bacteriological Differentiation Aids				
BDA- HiDtect Rapid Identification Discs	DT001	HiDtect™ UTI Identification Disc	Low risk	20/12/2012
BDA- HiDtect Rapid Identification Discs	DT003	HiDtect™ Pseudomonas Identification Disc	Low risk	20/12/2012
BDA- HiDtect Rapid Identification Discs	DT015	HiDtect™ Universal Enviro Identification Disc	Low risk	20/12/2012
BDA- Readymade Indicators in Liquid	I001	Andrade's Indicator	Low risk	20/12/2012
BDA- Readymade Indicators in Liquid	I002	Bromocresol Green Indicator	Low risk	20/12/2012
BDA- Readymade Indicators in Liquid	I003	Bromocresol Purple Indicator	Low risk	20/12/2012
BDA- Readymade Indicators in Liquid	I004	Bromophenol Blue Indicator	Low risk	20/12/2012
BDA- Readymade Indicators in Liquid	I005	Bromothymol Blue Indicator	Low risk	20/12/2012
BDA- Readymade Indicators in Liquid	I006	Methyl Orange Indicator	Low risk	20/12/2012
BDA- Readymade Indicators in Liquid	I007	Methyl Red Indicator	Low risk	20/12/2012
BDA- Readymade Indicators in Liquid	I008	Neutral Red Indicator	Low risk	20/12/2012
BDA- Readymade Indicators in Liquid	I009	Phenolphthalein, 0.1% w/v	Low risk	20/12/2012
BDA- Readymade Indicators in Liquid	I010	Phenol Red Indicator	Low risk	20/12/2012
BDA- Readymade Indicators in Liquid	I011	Thymol Blue Indicator	Low risk	20/12/2012
BDA- Readymade Indicators in Liquid	I012	Thymolphthalein Indicator	Low risk	20/12/2012
BDA- Readymade Indicators in Liquid	I013	Universal Indicator	Low risk	20/12/2012
BDA- Readymade Indicators in Liquid	I014	Mixed Indicator Solution (25X)	Low risk	20/12/2012
BDA- Readymade Stains in Liquid	K001	Gram Stains - Kit (contains S012, S032, S013 and S027 or S038)	Low risk	20/12/2012
BDA- Readymade Stains in Liquid	K001CCL	Gram Stains - Kit (contains S012, S032, S013 and S027 or S038)	Low risk	04/07/2018
BDA- Readymade Stains in Liquid	K001D	Gram Staining Kit	Low risk	04/07/2018
BDA- Readymade Stains in Liquid	K001L	Gram Stains - Kit (contains S012, S032, S013 and S027 or S038)	Low risk	20/12/2012
BDA- Readymade Stains in Liquid	K001M	Gram Stains - Kit	Low risk	22/04/2019
BDA- Readymade Stains in Liquid	K002	Albert's Metachromatic Stains - Kit	Low risk	20/12/2012
BDA- Readymade Stains in Liquid	K002L	Albert's Metachromatic Stains - Kit	Low risk	20/12/2012
BDA- Readymade Stains in Liquid	K003	Neisser's Metachromatic Stains - Kit (contains S013, S023 and S037)	Low risk	20/12/2012

BDA- Readymade Stains in Liquid	K003L	Neisser's Metachromatic Stains - Kit (contains S013, S023 and S037)	Low risk	20/12/2012
BDA- Readymade Stains in Liquid	K004	Capsule Stains - Kit (contains S021, S025 and S047)	Low risk	20/12/2012
BDA- Readymade Stains in Liquid	K004L	Capsule Stains - Kit (contains S021, S025 and S047)	Low risk	20/12/2012
BDA- Readymade Stains in Liquid	K005	ZN Acid Fast Stains - Kit (contains S033,S005 and S022)	Low risk	20/12/2012
BDA- Readymade Stains in Liquid	K005CCL	ZN Acid Fast Stains - Kit (contains S033,S005 and S022)	Low risk	04/07/2018
BDA- Readymade Stains in Liquid	K005D	ZN Acid Fast Stains - Kit	Low risk	04/07/2018
BDA- Readymade Stains in Liquid	K005L	ZN Acid Fast Stains - Kit (contains S033, S005 & S022)	Low risk	20/12/2012
BDA- Readymade Stains in Liquid	K005M	ZN Acid Fast Stains - Kit (contains S033, S005 & S022)	Low risk	22/04/2019
BDA- Readymade Stains in Liquid	K006	Schaeffer & Fulton's Spore Stains - Kit (contains S028 and S029)	Low risk	20/12/2012
BDA- Readymade Stains in Liquid	K006L	Schaeffer & Fulton's Spore Stains - Kit (contains S028 and S029)	Low risk	20/12/2012
BDA- Readymade Stains in Liquid	K011	Malarial Parasite - Kit (contains S008 and S009)	Low risk	20/12/2012
BDA- Readymade Stains in Liquid	K011L	Malarial Parasite - Kit (contains S008 and S009)	Low risk	20/12/2012
BDA- Readymade Stains in Liquid	K021	Fluorescent Stains - Kit for Mycobacteria (contains S042, S043 and S044)	Low risk	20/12/2012
BDA- Readymade Stains in Liquid	K021L	Fluorescent Stains - Kit for Mycobacteria (contains S042, S043 and S044)	Low risk	20/12/2012
BDA- Readymade Stains in Liquid	K021R	Fluorescent Stains Kit for Mycobacteria (contains S054,S055,S056)	Low risk	20/12/2012
BDA- Readymade Stains in Liquid	K021Y	Fluorescent Stains Kit for Mycobacteria (contains S042Y,S043Y,S044Y)	Low risk	04/07/2018
BDA- Readymade Stains in Liquid	K049	Malarial Parasite - Kit (contains S008 and S009)	Low risk	20/12/2012
BDA- Readymade Stains in Liquid	K061	HiFluo-Phenol Free Stain - kit for Mycobacteria [Kit contains 200ml each of Auramine – Rhodamine solution (Phenol free)-S082, Decolourizer-S099 (2 x200), Potassium Permanganate Solution-S083]	Low risk	20/12/2012
BDA- Readymade Stains in Liquid	K062	HiCold Stain TB - Kit for Mycobacteria [Kit contains 500ml each of Carbol Fuchsin Solution-S080, Decolourizer-S099, Counter Stain (Loeffler's Methylene Blue)-S081]	Low risk	20/12/2012
BDA- Readymade Stains in Liquid	K062S	HiCold Stain TB - Kit for Mycobacteria [Kit contains 100ml each of Carbol Fuchsin Solution-S080, Decolourizer-S099, Counter Stain (Loeffler's Methylene Blue) S081]	Low risk	20/12/2012
BDA- Readymade Stains in Liquid	K063	Modified Neisser's Metachromatic Stains - Kit (1 minute staining)	Low risk	20/12/2012
BDA - Readymade Reagents in Liquid	R001	Barium Chloride Solution, 10% w/v	Low risk	20/12/2012
BDA - Readymade Reagents in Liquid	R002	Benedict's Qualitative Reagent	Low risk	20/12/2012
BDA - Readymade Reagents in Liquid	R002	Benedict's Qualitative Reagent	Low risk	20/12/2012
BDA - Readymade Reagents in Liquid	R003	Benedict's Quantitative Reagent	Low risk	20/12/2012
BDA - Readymade Reagents in Liquid	R003	Benedict's Quantitative Reagent	Low risk	20/12/2012
BDA - Readymade Reagents in Liquid	R004	C.S.F. Diluting Fluid	Low risk	20/12/2012
BDA - Readymade Reagents in Liquid	R005	Ehrlich's Aldehyde Reagent	Low risk	20/12/2012
BDA - Readymade Reagents in Liquid	R005	Ehrlich's Aldehyde Reagent	Low risk	20/12/2012

BDA - Readymade Reagents in Liquid	R006	Folin & Wu's Alkaline Copper Solution	Low risk	20/12/2012
BDA - Readymade Reagents in Liquid	R007	Folin & Wu's Phosphate, Molybdate Solution	Low risk	20/12/2012
BDA - Readymade Reagents in Liquid	R008	Kovacs' Indole Reagent	Low risk	20/12/2012
BDA - Readymade Reagents in Liquid	R009	a-Naphthylamine solution	Low risk	20/12/2012
BDA - Readymade Reagents in Liquid	R010	Nessler's Reagent	Low risk	20/12/2012
BDA - Readymade Reagents in Liquid	R011	Potassium Chromate, 5% w/v	Low risk	20/12/2012
BDA - Readymade Reagents in Liquid	R012	Potassium Oxalate, 5% w/v	Low risk	20/12/2012
BDA - Readymade Reagents in Liquid	R013	R.B.C. Diluting Fluid (Hayemis)	Low risk	20/12/2012
BDA - Readymade Reagents in Liquid	R014	Sodium Citrate, 3.8% w/v	Low risk	20/12/2012
BDA - Readymade Reagents in Liquid	R015	Sulphanilic acid, 0.8%	Low risk	20/12/2012
BDA - Readymade Reagents in Liquid	R016	W.B.C. Diluting Fluid	Low risk	20/12/2012
BDA - Readymade Reagents in Liquid	R017	Nessler's Reagent	Low risk	20/12/2012
BDA - Readymade Reagents in Liquid	R018	Fouchet's Reagent	Low risk	20/12/2012
BDA - Readymade Reagents in Liquid	R019	E.D.T.A. (di-sodium) 5%	Low risk	20/12/2012
BDA - Readymade Reagents in Liquid	R020	Sulphosalicylic Acid 3%	Low risk	20/12/2012
BDA - Readymade Reagents in Liquid	R021	Topfer Reagent	Low risk	20/12/2012
BDA - Readymade Reagents in Liquid	R022	o-Toluidine reagent	Low risk	20/12/2012
BDA - Readymade Reagents in Liquid	R023	R.B.C. Diluting Fluid (Grower's)	Low risk	20/12/2012
BDA - Readymade Reagents in Liquid	R024	o-Toluidine Reagent	Low risk	20/12/2012
BDA - Readymade Reagents in Liquid	R026	Gordon-McLeod Reagent (Oxidase reagent)	Low risk	20/12/2012
BDA - Readymade Reagents in Liquid	R027	Gaby-Hadley Reagent A	Low risk	20/12/2012
BDA - Readymade Reagents in Liquid	R028	Gaby-Hadley Reagent B	Low risk	20/12/2012
BDA - Readymade Reagents in Liquid	R029	Barritt Reagent A (for VP test)	Low risk	20/12/2012
BDA - Readymade Reagents in Liquid	R030	Barritt Reagent B (for VP test)	Low risk	20/12/2012
BDA - Readymade Reagents in Liquid	R031	O'Meara Reagent	Low risk	20/12/2012
BDA - Readymade Reagents in Liquid	R035	DMACA Reagent	Low risk	20/12/2012

BDA - Readymade Reagents in Liquid	R036	TDA Reagent	Low risk	20/12/2012
BDA - Readymade Reagents in Liquid	R037	Fehling Solution No. 1	Low risk	20/12/2012
BDA - Readymade Reagents in Liquid	R038	Fehling Solution No. 2	Low risk	20/12/2012
BDA - Readymade Reagents in Liquid	R043	PYR Reagent	Low risk	20/12/2012
BDA - Readymade Reagents in Liquid	R044	Iodine Solution	Low risk	20/12/2012
BDA - Readymade Reagents in Liquid	R075	10X RBC Lysis Buffer Solution	Low risk	20/12/2012
BDA - Readymade Reagents in Liquid	R083	Thrombocount reagent	Low risk	20/12/2012
BDA - Readymade Reagents in Liquid	R084	HiDecal (mild decalcifying solution)	Low risk	20/12/2012
BDA - Readymade Reagents in Liquid	R085	HiDecal (strong decalcifying solution)	Low risk	20/12/2012
BDA - Readymade Reagents in Liquid	R092	McFarland Standard Tube	Low risk	20/12/2012
BDA - Readymade Reagents in Liquid	R092A	Mcfarland standard 0.5	Low risk	22/04/2019
BDA - Readymade Reagents in Liquid	R092B	Mcfarland standard 1	Low risk	22/04/2019
BDA - Readymade Reagents in Liquid	R092C	Mcfarland standard 2	Low risk	22/04/2019
BDA - Readymade Reagents in Liquid	R092D	Mcfarland standard 3	Low risk	22/04/2019
BDA - Readymade Reagents in Liquid	R092E	Mcfarland standard 4	Low risk	22/04/2019
BDA - Readymade Reagents in Liquid	R092R	Test Tubes (McFarland Standard Tube)	Low risk	25/08/2016
BDA - Readymade Reagents in Liquid	R092S	McFarland Standard Set (0.5,1,2)	Low risk	04/07/2018
BDA - Readymade Reagents in Liquid	R097	Millons reagent	Low risk	28/04/2017
BDA- Readymade Stains in Liquid	S001	Albert's Stain A	Low risk	20/12/2012
BDA- Readymade Stains in Liquid	S002	Albert's Stain B	Low risk	20/12/2012
BDA- Readymade Stains in Liquid	S003	Borax Carmine (Grenacher's), Alcoholic Stain	Low risk	20/12/2012
BDA- Readymade Stains in Liquid	S004	Borax Carmine (Grenacher's), Aqueous Stain	Low risk	20/12/2012
BDA- Readymade Stains in Liquid	S005	Carbol Fuchsin (ZN,Strong)	Low risk	20/12/2012
BDA- Readymade Stains in Liquid	S005D	Carbol Fuchsin (ZN,Strong)	Low risk	04/07/2018
BDA- Readymade Stains in Liquid	S005M	Carbol Fuchsin (ZN,Strong)	Low risk	22/04/2019
BDA- Readymade Stains in Liquid	S006	Carbol Fuchsin (ZN, Dilute)	Low risk	20/12/2012
BDA- Readymade Stains in Liquid	S007	Eosin, 2% w/v	Low risk	20/12/2012
BDA- Readymade Stains in Liquid	S008	Field's Stain A	Low risk	20/12/2012
BDA- Readymade Stains in Liquid	S009	Field's Stain B	Low risk	20/12/2012
BDA- Readymade Stains in Liquid	S010	Gentian Violet	Low risk	20/12/2012
BDA- Readymade Stains in Liquid	S011	Giemsa's Stain	Low risk	20/12/2012
BDA- Readymade Stains in Liquid	S012	Gram's Crystal Violet	Low risk	20/12/2012

BDA- Readymade Stains in Liquid	S012D	Gram's Crystal Violet	Low risk	04/07/2018
BDA- Readymade Stains in Liquid	S012M	Gram's Crystal Violet	Low risk	22/04/2019
BDA- Readymade Stains in Liquid	S013	Gram's Iodine	Low risk	20/12/2012
BDA- Readymade Stains in Liquid	S013D	Gram's Iodine	Low risk	04/07/2018
BDA- Readymade Stains in Liquid	S013M	Gram's Iodine	Low risk	22/04/2019
BDA- Readymade Stains in Liquid	S014	Haematoxylin (DeLafield's)	Low risk	20/12/2012
BDA- Readymade Stains in Liquid	S015	Lactophenol	Low risk	20/12/2012
BDA- Readymade Stains in Liquid	S016	Lactophenol Cotton Blue	Low risk	20/12/2012
BDA- Readymade Stains in Liquid	S017	Lactophenol Picric Acid	Low risk	20/12/2012
BDA- Readymade Stains in Liquid	S018	Leishman's Stain (Twin Pack)	Low risk	20/12/2012
BDA- Readymade Stains in Liquid	S018S	Leishman's Stain Solution	Low risk	25/11/2017
BDA- Readymade Stains in Liquid	S019	Lugol's Iodine	Low risk	20/12/2012
BDA- Readymade Stains in Liquid	S020	Malachite Green, 1% w/v	Low risk	20/12/2012
BDA- Readymade Stains in Liquid	S021	Methylene Blue (Aqueous)	Low risk	20/12/2012
BDA- Readymade Stains in Liquid	S022	Methylene Blue (Loeffler's)	Low risk	20/12/2012
BDA- Readymade Stains in Liquid	S022D	Methylene Blue (Loeffler's)	Low risk	04/07/2018
BDA- Readymade Stains in Liquid	S022M	Methylene Blue (Loeffler's)	Low risk	22/04/2019
BDA- Readymade Stains in Liquid	S023	Neisser's Methylene Blue	Low risk	20/12/2012
BDA- Readymade Stains in Liquid	S024	Newman's Stain, Modified	Low risk	20/12/2012
BDA- Readymade Stains in Liquid	S025	Nigrosin Stain, 10% w/v	Low risk	20/12/2012
BDA- Readymade Stains in Liquid	S026	Picric Acid (Saturated, Aqueous)	Low risk	20/12/2012
BDA- Readymade Stains in Liquid	S027	Safranin, 0.5% w/v	Low risk	20/12/2012
BDA- Readymade Stains in Liquid	S027D	Safranin, 0.5% w/v	Low risk	04/07/2018
BDA- Readymade Stains in Liquid	S027M	Safranin, 0.5% w/v	Low risk	22/04/2019
BDA- Readymade Stains in Liquid	S028	Schaeffer & Fulton's Spore Stain A	Low risk	20/12/2012
BDA- Readymade Stains in Liquid	S029	Schaeffer & Fulton's Spore Stain B	Low risk	20/12/2012
BDA- Readymade Stains in Liquid	S030	Wright's Stain	Low risk	20/12/2012
BDA- Readymade Stains in Liquid	S031	Mayer's Mucicarmine Stain	Low risk	20/12/2012
BDA- Readymade Stains in Liquid	S032	Gram's Decolourizer	Low risk	20/12/2012
BDA- Readymade Stains in Liquid	S032D	Gram's Decolourizer	Low risk	04/07/2018
BDA- Readymade Stains in Liquid	S032M	Gram's Decolourizer	Low risk	22/04/2019
BDA- Readymade Stains in Liquid	S033	Acid Fast Decolourizer	Low risk	20/12/2012
BDA- Readymade Stains in Liquid	S033D	Acid Fast Decolourizer	Low risk	04/07/2018
BDA- Readymade Stains in Liquid	S033M	Acid Fast Decolourizer	Low risk	22/04/2019
BDA- Readymade Stains in Liquid	S034	Haematoxylin (Harris)	Low risk	20/12/2012
BDA- Readymade Stains in Liquid	S035	Papanicolaou-OG-6	Low risk	20/12/2012
BDA- Readymade Stains in Liquid	S036	Papanicolaou-EA-36	Low risk	20/12/2012
BDA- Readymade Stains in Liquid	S037	Neutral Red Solution	Low risk	20/12/2012
BDA- Readymade Stains in Liquid	S038	Basic Fuchsin 0.1% w/v	Low risk	20/12/2012
BDA- Readymade Stains in Liquid	S038D	Basic Fuchsin 0.1% w/v	Low risk	04/07/2018
BDA- Readymade Stains in Liquid	S038M	Basic Fuchsin 0.1% w/v	Low risk	22/04/2019
BDA- Readymade Stains in Liquid	S039	May-Grunwald's Stain	Low risk	20/12/2012
BDA- Readymade Stains in Liquid	S041	FA Rhodamine Counterstain	Low risk	20/12/2012
BDA- Readymade Stains in Liquid	S042	Phenolic auramine	Low risk	20/12/2012
BDA- Readymade Stains in Liquid	S042Y	Phenolic auramine O	Low risk	08/12/2017

BDA- Readymade Stains in Liquid	S043	Mycobacteria decolourizer	Low risk	20/12/2012
BDA- Readymade Stains in Liquid	S043Y	Mycobacteria decolourizer	Low risk	16/12/2017
BDA- Readymade Stains in Liquid	S044	Potassium permanganate	Low risk	20/12/2012
BDA- Readymade Stains in Liquid	S044Y	Potassium permanganate	Low risk	08/12/2017
BDA- Readymade Stains in Liquid	S047	M' Fadyean Stain (Polychrome Methylene Blue)	Low risk	20/12/2012
BDA- Readymade Stains in Liquid	S054	Fluorochrome Solution	Low risk	20/12/2012
BDA- Readymade Stains in Liquid	S055	Decolourising Solution	Low risk	20/12/2012
BDA- Readymade Stains in Liquid	S056	Background Solution	Low risk	20/12/2012
BDA- Readymade Stains in Liquid	S057	Grams Iodine, Stabilized	Low risk	20/12/2012
BDA- Readymade Stains in Liquid	S058	Haematoxylin (Mayer)	Low risk	20/12/2012
BDA- Readymade Stains in Liquid	S059	Haematoxylin (Ehrlich)	Low risk	20/12/2012
BDA- Readymade Stains in Liquid	S062	Fixing solution, for fixing Haematological samples	Low risk	20/12/2012
BDA- Readymade Stains in Liquid	S066	Brilliant Cresyl Blue Solution	Low risk	20/12/2012
BDA- Readymade Stains in Liquid	S067	Congo red (1% aqueous)Solution	Low risk	20/12/2012
BDA- Readymade Stains in Liquid	S068	Papanicolaou-EA-50	Low risk	20/12/2012
BDA- Readymade Stains in Liquid	S070	Schiff's fuchsin-sulphite reagent	Low risk	20/12/2012
BDA- Readymade Stains in Liquid	S073	Periodic Acid Solution (PAS)	Low risk	20/12/2012
BDA- Readymade Stains in Liquid	S074	Schiff's Reagent	Low risk	20/12/2012
BDA- Readymade Stains in Liquid	S076	Haematoxylin (Gill No.3)	Low risk	20/12/2012
BDA- Readymade Stains in Liquid	S102	Fixative, for fixing cytological or histological samples	Low risk	20/12/2012
BDA- Readymade Stains in Liquid	S109	Fixative (Buffered Formalin fixative) for fixing cytological or histological samples	Low risk	20/12/2012
BDA- Readymade Stains in Liquid	S118	Fixative, for rapid fixing of haematological samples	Low risk	20/12/2012
BDA- Readymade Stains in Liquid	S119	Fixative (BFA), for Rapid fixing of haematological samples	Low risk	20/12/2012
BDA- Readymade Stains in Liquid	S125	Romanowsky-Giemsa (RG) stain	Low risk	20/12/2012
BDA- Readymade Stains in Liquid	S126	Shorr's Stain solution	Low risk	20/12/2012
BDA- Readymade Stains in Liquid	S127	Gabbett Counterstaining Solution	Low risk	16/12/2017
BDA- Readymade Stains in Liquid	S128	HiGrams Stain Crystal Violet	Low risk	16/12/2017
BDA- Readymade Stains in Liquid	S129	HiGrams Iodine	Low risk	16/12/2017
BDA- Readymade Stains in Liquid	S130	HiGrams Decolouriser	Low risk	16/12/2017
BDA- Readymade Stains in Liquid	S131	HiGrams Counter Stain	Low risk	16/12/2017
BDA- Readymade Stains in Liquid	S132	HiCarbol Fuchsin	Low risk	16/12/2017
BDA- Readymade Stains in Liquid	S133	HiAcid Fast Decolouriser	Low risk	16/12/2017
BDA- Readymade Stains in Liquid	S134	HiAcid Fast Counter Stain	Low risk	16/12/2017
BDA- Readymade Stains in Liquid	S135	Solution for Leishman's Stain L (Twin Pack)	Low risk	16/12/2017
BDA- Readymade Stains in Liquid	S136	Solution for Leishman's Stain R (Twin Pack)	Low risk	16/12/2017
BDA- Readymade Stains in Liquid	S137	Solution for Leishman's Stain HP (Twin Pack)	Low risk	16/12/2017
BDA- Readymade Stains in Liquid	S138	Gentian Violet 1 % Solution	Low risk	22/04/2019
BDA- Differentiation Discs	DD015	Bacitracin	Low risk	20/12/2012
BDA- Differentiation Discs	DD024	Bile Esculin	Low risk	20/12/2012
BDA- Differentiation Discs	DD040	DMACA Indole	Low risk	20/12/2012
BDA- Differentiation Discs	DD035	Hippurate hydrolysis	Low risk	20/12/2012
BDA- Differentiation Strips	DD034	Lead Acetate Paper strips	Low risk	20/12/2012
BDA- Differentiation Discs	DD041	Nitrate Discs	Low risk	20/12/2012
BDA- Differentiation Discs	DD042	Nitrate Reagent Discs	Low risk	20/12/2012

BDA- Differentiation Discs	DD008	ONPG	Low risk	20/12/2012
BDA- Differentiation Discs	DD009	Optochin	Low risk	20/12/2012
BDA- Differentiation Discs	DD009R	Optochin (5mcg)	Low risk	25/08/2016
BDA- Differentiation Discs	DD018	Oxidase	Low risk	20/12/2012
BDA- Differentiation Discs	DD020	X factor	Low risk	20/12/2012
BDA- Differentiation Discs	DD022	X+V Factor	Low risk	20/12/2012
BDA- Differentiation Discs	DD021	V Factor	Low risk	20/12/2012
BDA- Differentiation Discs	DD047	Vibrio 0129 Differential Disc	Low risk	20/12/2012
BDA- Differentiation Discs	DD048	Vibrio 0129 Differential Disc	Low risk	20/12/2012
BDA- Differentiation Discs	DD055	Bacitracin B	Low risk	25/08/2016
BDA- Differentiation Discs	DD056	Sodium Biselenite Disc	Low risk	04/07/2018
BDA- Differentiation Discs	DB001	Sodium Biselenite Bud	Low risk	04/07/2018

Product group	Type/ Model / Ref number	Device Name	Risk Class	Date of CE compliance
Antimicrobial Susceptibility Systems				
ASS- Sensitivity Discs (Multi Discs)	DE001	Dodeca Universal-I	Low risk	20/12/2012
ASS- Sensitivity Discs (Multi Discs)	DE002	Dodeca G-I-Plus	Low risk	20/12/2012
ASS- Sensitivity Discs (Multi Discs)	DE003	Dodeca G-I-Minus	Low risk	20/12/2012
ASS- Sensitivity Discs (Multi Discs)	DE004	Dodeca UTI-I	Low risk	20/12/2012
ASS- Sensitivity Discs (Multi Discs)	DE005	Dodeca UTI-II	Low risk	20/12/2012
ASS- Sensitivity Discs (Multi Discs)	DE006	Dodeca UTI-III	Low risk	25/08/2016
ASS- Sensitivity Discs (Multi Discs)	DE007	Dodeca Universal-II	Low risk	20/12/2012
ASS- Sensitivity Discs (Multi Discs)	DE008	Dodeca Universal-III	Low risk	20/12/2012
ASS- Sensitivity Discs (Multi Discs)	DE009	Dodeca G-II-Plus	Low risk	20/12/2012
ASS- Sensitivity Discs (Multi Discs)	DE010	Dodeca G-II-Minus	Low risk	20/12/2012
ASS- Sensitivity Discs (Multi Discs)	DE011	Dodeca UTI-IV	Low risk	20/12/2012
ASS- Sensitivity Discs (Multi Discs)	DE012	Dodeca Universal-IV	Low risk	20/12/2012
ASS- Sensitivity Discs (Multi Discs)	DE013	Dodeca Universal-V	Low risk	20/12/2012
ASS- Sensitivity Discs (Multi Discs)	DE014	Dodeca Universal-VI	Low risk	20/12/2012
ASS- Sensitivity Discs (Multi Discs)	DE015	Dodeca Universal-VII	Low risk	20/12/2012
ASS- Sensitivity Discs (Multi Discs)	DE016	Dodeca Universal III	Low risk	25/08/2016
ASS- Sensitivity Discs (Multi Discs)	DE017	Dodeca Universal-IX	Low risk	20/12/2012
ASS- Sensitivity Discs (Multi Discs)	DE018	Dodeca G-III-Plus	Low risk	20/12/2012
ASS- Sensitivity Discs (Multi Discs)	DE019	Dodeca G-III-Minus	Low risk	20/12/2012
ASS- Sensitivity Discs (Multi Discs)	DE020	Dodeca Pseudo-I	Low risk	20/12/2012
ASS- Sensitivity Discs (Multi Discs)	DE021	Dodeca UTI-V	Low risk	20/12/2012
ASS- Sensitivity Discs (Multi Discs)	DE022	Dodeca Universal X	Low risk	25/08/2016
ASS- Sensitivity Discs (Multi Discs)	DE023	Dodeca G-IV Plus	Low risk	20/12/2012
ASS- Sensitivity Discs (Multi Discs)	DE024	Dodeca G-IV minus	Low risk	25/08/2016
ASS- Sensitivity Discs (Multi Discs)	DE025	Dodeca UTI-VI	Low risk	20/12/2012
ASS- Sensitivity Discs (Multi Discs)	DE026	Dodeca Universal -XI	Low risk	20/12/2012
ASS- Sensitivity Discs (Multi Discs)	DE027	Dodeca Universal -XII	Low risk	20/12/2012
ASS- Sensitivity Discs (Multi Discs)	DE028	Dodeca Universal -XIII	Low risk	20/12/2012
ASS- Sensitivity Discs (Multi Discs)	DE029	Dodeca G-V minus	Low risk	20/12/2012
ASS- Sensitivity Discs (Multi Discs)	DE030	Dodeca UTI-VII	Low risk	20/12/2012
ASS- Sensitivity Discs (Multi Discs)	DE031	Dodeca G-VI minus	Low risk	20/12/2012
ASS- Sensitivity Discs (Multi Discs)	DE032	Dodeca G-V Plus	Low risk	20/12/2012
ASS- Sensitivity Discs (Multi Discs)	DE033	Dodeca G-VII Minus	Low risk	20/12/2012
ASS- Sensitivity Discs (Multi Discs)	DE034	Dodeca UTI-VIII	Low risk	20/12/2012
ASS- Sensitivity Discs (Multi Discs)	DE035	Dodeca Universal XIV	Low risk	20/12/2012
ASS- Sensitivity Discs (Multi Discs)	DE036	Dodeca G-VI Plus	Low risk	20/12/2012
ASS- Sensitivity Discs (Multi Discs)	DE037	Dodeca G-VIII Minus	Low risk	20/12/2012
ASS- Sensitivity Discs (Multi Discs)	DE038	Dodeca G-VII Plus	Low risk	20/12/2012
ASS- Sensitivity Discs (Multi Discs)	DE039	Dodeca G-IX Minus	Low risk	20/12/2012
ASS- Sensitivity Discs (Multi Discs)	DE040	Dodeca UTI-IX	Low risk	20/12/2012

ASS- Sensitivity Discs (Multi Discs)	DE041	Dodeca Pseudo-II	Low risk	20/12/2012
ASS- Sensitivity Discs (Multi Discs)	DE042	Dodeca Universal XV	Low risk	20/12/2012
ASS- Sensitivity Discs (Multi Discs)	DE043	Dodeca G-X Minus	Low risk	25/08/2016
ASS- Sensitivity Discs (Multi Discs)	DE044	Dodeca - G-VIII Plus	Low risk	25/08/2016
ASS- Sensitivity Discs (Multi Discs)	DE045	Dodeca G-XI Minus	Low risk	20/12/2012
ASS- Sensitivity Discs (Multi Discs)	DE046	Dodeca G-XII Minus	Low risk	20/12/2012
ASS- Sensitivity Discs (Multi Discs)	DE047	Dodeca G-IX Plus	Low risk	20/12/2012
ASS- Sensitivity Discs (Multi Discs)	DE048	Dodeca Staphylococci - 1	Low risk	20/12/2012
ASS- Sensitivity Discs (Multi Discs)	DE049	Dodeca Staphylococci - 2	Low risk	20/12/2012
ASS- Sensitivity Discs (Multi Discs)	DE050	Dodeca Enterococcus -1	Low risk	20/12/2012
ASS- Sensitivity Discs (Multi Discs)	DE051	Dodeca Pseudomonas -1	Low risk	20/12/2012
ASS- Sensitivity Discs (Multi Discs)	DE052	Dodeca Pseudomonas 2	Low risk	25/08/2016
ASS- Sensitivity Discs (Multi Discs)	DE053	Dodeca Enterobacteriaceae - 1	Low risk	20/12/2012
ASS- Sensitivity Discs (Multi Discs)	DE054	Dodeca Enterobacteriaceae - 2	Low risk	20/12/2012
ASS- Sensitivity Discs (Multi Discs)	DE700	Dodeca Staphylococci - 1	Low risk	25/08/2016
ASS- Sensitivity Discs (Multi Discs)	DE701	Dodeca Staphylococci - 2	Low risk	25/08/2016
ASS- Sensitivity Discs (Multi Discs)	DE702	Dodeca Enterococcus - 1	Low risk	25/08/2016
ASS- Sensitivity Discs (Multi Discs)	DE703	Dodeca Pseudomonas - 1	Low risk	25/08/2016
ASS- Sensitivity Discs (Multi Discs)	DE704	Dodeca Pseudomonas - 2	Low risk	25/08/2016
ASS- Sensitivity Discs (Multi Discs)	DE705	Dodeca Enterobacteriaceae - 1	Low risk	25/08/2016
ASS- Sensitivity Discs (Multi Discs)	DE706	Dodeca Enterobacteriaceae - 2	Low risk	25/08/2016
ASS- Sensitivity Discs (Multi Discs)	DE707	Dodeca Universal - 16	Low risk	25/08/2016
ASS- Sensitivity Discs (Multi Discs)	DE708	Dodeca UTI - 10	Low risk	25/08/2016
ASS- Sensitivity Discs (Multi Discs)	DE709	Dodeca G-Minus 13	Low risk	25/08/2016
ASS- Sensitivity Discs (Multi Discs)	DE710	Dodeca G-Plus 10	Low risk	25/08/2016
ASS- Sensitivity Discs (Multi Discs)	DE711	Dodeca G minus XIV	Low risk	25/08/2016
ASS- Sensitivity Discs (Multi Discs)	DE712	Dodeca G minus XV	Low risk	25/08/2016
ASS- Sensitivity Discs (Multi Discs)	DE713	Dodeca G minus 16	Low risk	25/08/2016
ASS- Sensitivity Discs (Multi Discs)	DE714	Dodeca G minus 17	Low risk	25/08/2016
ASS- Sensitivity Discs (Multi Discs)	DE715	Dodeca G minus 18	Low risk	25/08/2016
ASS- Sensitivity Discs (Multi Discs)	DE716	Dodeca G plus 11	Low risk	25/08/2016
ASS- Sensitivity Discs (Multi Discs)	DE717	Dodeca G plus 12	Low risk	25/08/2016
ASS- Sensitivity Discs (Multi Discs)	DE718	Dodeca G minus 19	Low risk	25/08/2016
ASS- Sensitivity Discs (Multi Discs)	DE719	Dodeca UTI 10	Low risk	25/08/2016
ASS- Sensitivity Discs (Multi Discs)	DE720	Dodeca UTI 11	Low risk	25/08/2016
ASS- Sensitivity Discs (Multi Discs)	DE721	Dodeca Universal 16	Low risk	25/08/2016
ASS- Sensitivity Discs (Multi Discs)	DE722	Dodeca Universal 17	Low risk	25/08/2016
ASS- Sensitivity Discs (Multi Discs)	DE723	Dodeca G Plus 13	Low risk	25/08/2016
ASS- Sensitivity Discs (Multi Discs)	DE724	Dodeca UTI-12	Low risk	25/08/2016
ASS- Sensitivity Discs (Multi Discs)	DE725	Dodeca Universal-18	Low risk	25/08/2016
ASS- Sensitivity Discs (Multi Discs)	DE726	Dodeca UTI - 13	Low risk	25/08/2016
ASS- Sensitivity Discs (Multi Discs)	DE727	Dodeca G-minus 20	Low risk	25/08/2016
ASS- Sensitivity Discs (Multi Discs)	DE728	Dodeca UTI 14	Low risk	25/08/2016
ASS- Sensitivity Discs (Multi Discs)	DE729	Dodeca G-Plus 14	Low risk	25/08/2016
ASS- Sensitivity Discs (Multi Discs)	DE730	Dodeca G-Minus 21	Low risk	25/08/2016

ASS- Sensitivity Discs (Multi Discs)	DE731	Dodeca G-Minus 22	Low risk	25/08/2016
ASS- Sensitivity Discs (Multi Discs)	DE732	Dodeca Universal 19	Low risk	25/08/2016
ASS- Sensitivity Discs (Multi Discs)	DE733	Dodeca Universal 20	Low risk	25/08/2016
ASS- Sensitivity Discs (Multi Discs)	DE734	Dodeca Universal 21	Low risk	25/08/2016
ASS- Sensitivity Discs (Multi Discs)	DE735	Dodeca Universal 22	Low risk	25/08/2016
ASS- Sensitivity Discs (Multi Discs)	DE736	Dodeca G-Plus 15	Low risk	25/08/2016
ASS- Sensitivity Discs (Multi Discs)	DE737	Dodeca G-Minus 23	Low risk	25/08/2016
ASS- Sensitivity Discs (Multi Discs)	DE738	Dodeca G-Minus 24	Low risk	25/08/2016
ASS- Sensitivity Discs (Multi Discs)	DE739	Dodeca UTI 13	Low risk	25/08/2016
ASS- Sensitivity Discs (Multi Discs)	DE740	Dodeca G-Plus 16	Low risk	25/08/2016
ASS- Sensitivity Discs (Multi Discs)	DE741	Dodeca G-Minus 25	Low risk	25/08/2016
ASS- Sensitivity Discs (Multi Discs)	DE742	Dodeca Pseudomonas -3	Low risk	25/08/2016
ASS- Sensitivity Discs (Multi Discs)	DE743	Dodeca G-Minus 26	Low risk	04/07/2018
ASS- Sensitivity Discs (Multi Discs)	DE744	Dodeca UTI 15	Low risk	04/07/2018
ASS- Sensitivity Discs (Multi Discs)	DE745	Dodeca Pseudomonas -4	Low risk	04/07/2018
ASS- Sensitivity Discs (Multi Discs)	DE746	Dodeca G-Plus 17	Low risk	04/07/2018
ASS- Sensitivity Discs (Multi Discs)	DE747	Dodeca G-Minus 27	Low risk	04/07/2018
ASS- Sensitivity Discs (Multi Discs)	DE748	Dodeca UTI 16	Low risk	04/07/2018
ASS- Sensitivity Discs (Multi Discs)	DE749	Dodeca G-Plus 18	Low risk	10/11/2020
ASS- Sensitivity Discs (Multi Discs)	DE750	Dodeca G-Plus 19	Low risk	10/11/2020
ASS- Sensitivity Discs (Multi Discs)	DE751	Dodeca G-Minus 28	Low risk	10/11/2020
ASS- Sensitivity Discs (Multi Discs)	DE752	Dodeca G-Minus 29	Low risk	10/11/2020
ASS- Sensitivity Discs (Multi Discs)	DE753	Dodeca G-Plus 20	Low risk	10/11/2020
ASS- Sensitivity Discs (Multi Discs)	DE754	Dodeca G-Minus 30	Low risk	10/11/2020
ASS- Sensitivity Discs (Multi Discs)	DE755	Dodeca Pseudomonas -5	Low risk	10/11/2020
ASS- Sensitivity Discs (Multi Discs)	DE756	Dodeca G-Minus 31	Low risk	10/11/2020
ASS- Sensitivity Discs (Multi Discs)	DE757	Dodeca G-Plus 21	Low risk	10/11/2020
ASS- Ezy MIC Strips	EM001	Amikacin	Low risk	20/12/2012
ASS- Ezy MIC Strips	EM002	Amoxicillin	Low risk	20/12/2012
ASS- Ezy MIC Strips	EM003	Amoxyclav (2:1)	Low risk	20/12/2012
ASS- Ezy MIC Strips	EM004	Azithromycin	Low risk	20/12/2012
ASS- Ezy MIC Strips	EM006	Aztreonam	Low risk	20/12/2012
ASS- Ezy MIC Strips	EM008	Cefazolin	Low risk	20/12/2012
ASS- Ezy MIC Strips	EM009	Cefdinir	Low risk	20/12/2012
ASS- Ezy MIC Strips	EM011	Cefpirome	Low risk	20/12/2012
ASS- Ezy MIC Strips	EM012	Ceftazidime	Low risk	20/12/2012
ASS- Ezy MIC Strips	EM013	Ceftriaxone	Low risk	20/12/2012
ASS- Ezy MIC Strips	EM016	Chloramphenicol	Low risk	20/12/2012
ASS- Ezy MIC Strips	EM017	Ciprofloxacin	Low risk	20/12/2012
ASS- Ezy MIC Strips	EM018	Clarithromycin	Low risk	20/12/2012
ASS- Ezy MIC Strips	EM019	Clindamycin	Low risk	20/12/2012
ASS- Ezy MIC Strips	EM020	Colistin	Low risk	20/12/2012
ASS- Ezy MIC Strips	EM020S	Colistin	Low risk	04/07/2018
ASS- Ezy MIC Strips	EM021	Co-Trimoxazole (1:19)	Low risk	20/12/2012
ASS- Ezy MIC Strips	EM021S	Co-Trimoxazole (1:19)	Low risk	04/07/2018

ASS- Ezy MIC Strips	EM022	Erythromycin	Low risk	20/12/2012
ASS- Ezy MIC Strips	EM023	Fusidic Acid	Low risk	20/12/2012
ASS- Ezy MIC Strips	EM024	Gatifloxacin	Low risk	20/12/2012
ASS- Ezy MIC Strips	EM025	Gentamicin	Low risk	20/12/2012
ASS- Ezy MIC Strips	EM026	Kanamycin	Low risk	20/12/2012
ASS- Ezy MIC Strips	EM027	Levofloxacin	Low risk	20/12/2012
ASS- Ezy MIC Strips	EM029	Linezolid	Low risk	20/12/2012
ASS- Ezy MIC Strips	EM032	Minocycline	Low risk	20/12/2012
ASS- Ezy MIC Strips	EM033	Moxifloxacin	Low risk	20/12/2012
ASS- Ezy MIC Strips	EM035	Nalidixic acid	Low risk	20/12/2012
ASS- Ezy MIC Strips	EM037	Nitrofurantoin	Low risk	20/12/2012
ASS- Ezy MIC Strips	EM038	Norfloxacin	Low risk	20/12/2012
ASS- Ezy MIC Strips	EM039	Ofloxacin	Low risk	20/12/2012
ASS- Ezy MIC Strips	EM041	Piperacillin	Low risk	20/12/2012
ASS- Ezy MIC Strips	EM042	Piperacillin/Tazobactam	Low risk	20/12/2012
ASS- Ezy MIC Strips	EM043	Polymixin B	Low risk	20/12/2012
ASS- Ezy MIC Strips	EM044	Pristinomycin (Quinupristin/Dalfopristin)	Low risk	20/12/2012
ASS- Ezy MIC Strips	EM045	Rifampicin	Low risk	20/12/2012
ASS- Ezy MIC Strips	EM046	Roxithromycin	Low risk	20/12/2012
ASS- Ezy MIC Strips	EM047	Sparfloxacin	Low risk	20/12/2012
ASS- Ezy MIC Strips	EM048	Streptomycin	Low risk	20/12/2012
ASS- Ezy MIC Strips	EM055	Teicoplanin	Low risk	20/12/2012
ASS- Ezy MIC Strips	EM055S	Teicoplanin	Low risk	04/07/2018
ASS- Ezy MIC Strips	EM056	Tetracycline	Low risk	20/12/2012
ASS- Ezy MIC Strips	EM057	Ticaracillin	Low risk	20/12/2012
ASS- Ezy MIC Strips	EM058	Tobramycin	Low risk	20/12/2012
ASS- Ezy MIC Strips	EM059	Trimethoprim	Low risk	20/12/2012
ASS- Ezy MIC Strips	EM060	Vancomycin	Low risk	20/12/2012
ASS- Ezy MIC Strips	EM060S	Vancomycin	Low risk	04/07/2018
ASS- Ezy MIC Strips	EM061	Gentamicin	Low risk	20/12/2012
ASS- Ezy MIC Strips	EM062	Penicillin	Low risk	20/12/2012
ASS- Ezy MIC Strips	EM063	Oxacillin - Vancomycin	Low risk	20/12/2012
ASS- Ezy MIC Strips	EM064	Cefotaxime	Low risk	20/12/2012
ASS- Ezy MIC Strips	EM065	Oxacillin	Low risk	20/12/2012
ASS- Ezy MIC Strips	EM066	Ceftriaxone	Low risk	20/12/2012
ASS- Ezy MIC Strips	EM066S	Ceftriaxone	Low risk	04/07/2018
ASS- Ezy MIC Strips	EM068	Ampicillin	Low risk	20/12/2012
ASS- Ezy MIC Strips	EM070	Cefepime	Low risk	20/12/2012
ASS- Ezy MIC Strips	EM071	Amphotericin-B	Low risk	20/12/2012
ASS- Ezy MIC Strips	EM072	Fluconazole	Low risk	20/12/2012
ASS- Ezy MIC Strips	EM073	Itraconazole	Low risk	20/12/2012
ASS- Ezy MIC Strips	EM074	Ketoconazole	Low risk	20/12/2012
ASS- Ezy MIC Strips	EM076	Gemifloxacin	Low risk	20/12/2012
ASS- Ezy MIC Strips	EM077	Vancomycin -Cefoxitin	Low risk	20/12/2012
ASS- Ezy MIC Strips	EM078	Imipenem w&w/o EDTA	Low risk	20/12/2012

ASS- Ezy MIC Strips	EM079A	Triple ESBL detection Strip	Low risk	20/12/2012
ASS- Ezy MIC Strips	EM080	Meropenem	Low risk	20/12/2012
ASS- Ezy MIC Strips	EM081A	ESBL & AmpC Detection Strip	Low risk	20/12/2012
ASS- Ezy MIC Strips	EM082	Ciprofloxacin	Low risk	20/12/2012
ASS- Ezy MIC Strips	EM083	Co-Trimoxazole (1:19)	Low risk	20/12/2012
ASS- Ezy MIC Strips	EM084	Penicillin	Low risk	20/12/2012
ASS- Ezy MIC Strips	EM085	Ertapenem	Low risk	20/12/2012
ASS- Ezy MIC Strips	EM086	Voriconazole	Low risk	20/12/2012
ASS- Ezy MIC Strips	EM087	Mupirocin	Low risk	20/12/2012
ASS- Ezy MIC Strips	EM088	Daptomycin (Supplemented with Calcium ions)	Low risk	20/12/2012
ASS- Ezy MIC Strips	EM089	Tigecycline	Low risk	20/12/2012
ASS- Ezy MIC Strips	EM090	Doripenem	Low risk	20/12/2012
ASS- Ezy MIC Strips	EM091	Faropenem	Low risk	20/12/2012
ASS- Ezy MIC Strips	EM092	Meropenem with & without EDTA	Low risk	20/12/2012
ASS- Ezy MIC Strips	EM093	Cefepime/Tazobactam (2:1)	Low risk	20/12/2012
ASS- Ezy MIC Strips	EM094	Cefoperazone/Sulbactam (2:1)	Low risk	20/12/2012
ASS- Ezy MIC Strips	EM095	Netilmicin	Low risk	20/12/2012
ASS- Ezy MIC Strips	EM097	Ceftriaxone/Sulbactam (2:1)	Low risk	20/12/2012
ASS- Ezy MIC Strips	EM098	Ceftazidime / Ceftazidime+ Clavulanic acid	Low risk	20/12/2012
ASS- Ezy MIC Strips	EM099	Cefotaxime / Cefotaxime + Clavulanic acid	Low risk	20/12/2012
ASS- Ezy MIC Strips	EM100	Cefotaxime	Low risk	20/12/2012
ASS- Ezy MIC Strips	EM101	Cefoxitin	Low risk	20/12/2012
ASS- Ezy MIC Strips	EM102	Cefuroxime	Low risk	20/12/2012
ASS- Ezy MIC Strips	EM103	Doxycycline	Low risk	20/12/2012
ASS- Ezy MIC Strips	EM104	Imipenem	Low risk	20/12/2012
ASS- Ezy MIC Strips	EM105	Cefotetan	Low risk	20/12/2012
ASS- Ezy MIC Strips	EM106	Cephalothin	Low risk	20/12/2012
ASS- Ezy MIC Strips	EM107	Cefaclor	Low risk	20/12/2012
ASS- Ezy MIC Strips	EM108	Fosfomycin	Low risk	20/12/2012
ASS- Ezy MIC Strips	EM109	Ampicillin/Sulbactam	Low risk	20/12/2012
ASS- Ezy MIC Strips	EM110	Cefixime	Low risk	20/12/2012
ASS- Ezy MIC Strips	EM111	Vancomycin - Teicoplanin	Low risk	20/12/2012
ASS- Ezy MIC Strips	EM112	Cefoperazone	Low risk	20/12/2012
ASS- Ezy MIC Strips	EM113	Cefonicid	Low risk	20/12/2012
ASS- Ezy MIC Strips	EM114	Cefmetazole	Low risk	20/12/2012
ASS- Ezy MIC Strips	EM115	Enrofloxacin	Low risk	20/12/2012
ASS- Ezy MIC Strips	EM116	Cefepime / cefepime + Clavulanic acid	Low risk	20/12/2012
ASS- Ezy MIC Strips	EM117	Ceftriaxone / Ceftriaxone + Clavulanic acid	Low risk	20/12/2012
ASS- Ezy MIC Strips	EM118	Flucytosine	Low risk	20/12/2012
ASS- Ezy MIC Strips	EM119	Caspofungin	Low risk	20/12/2012
ASS- Ezy MIC Strips	EM120	Posaconazole	Low risk	20/12/2012
ASS- Ezy MIC Strips	EM121	Micafungin	Low risk	20/12/2012
ASS- Ezy MIC Strips	EM122	Anidulafungin	Low risk	20/12/2012
ASS- Ezy MIC Strips	EM123	Ceftizoxime	Low risk	20/12/2012
ASS- Ezy MIC Strips	EM124	Mecillinam	Low risk	20/12/2012

ASS- Ezy MIC Strips	EM125	Ticarcillin/Clavulanic Acid	Low risk	20/12/2012
ASS- Ezy MIC Strips	EM126	Bacitracin	Low risk	20/12/2012
ASS- Ezy MIC Strips	EM127	Cefotetan / Cefotetan + Cloxacillin	Low risk	20/12/2012
ASS- Ezy MIC Strips	EM128	Metronidazole	Low risk	20/12/2012
ASS- Ezy MIC Strips	EM129	Cefpodoxime	Low risk	20/12/2012
ASS- Ezy MIC Strips	EM130	Cefprozil	Low risk	20/12/2012
ASS- Ezy MIC Strips	EM131	Sulbactam	Low risk	20/12/2012
ASS- Ezy MIC Strips	EM132	Improved ESBL Detection Ezy MIC Strip (Mix+/Mix)	Low risk	25/08/2016
ASS- Ezy MIC Strips	EM133	Improved AmpC Detection Ezy MIC Strip (Mix+/Mix)	Low risk	25/08/2016
ASS- Ezy MIC Strips	EM134	MBL Plus ESBL Detection Ezy MIC Strip (ESBL+/ESBL)	Low risk	25/08/2016
ASS- Ezy MIC Strips	EM135	MBL Plus AmpC Detection Ezy MIC Strip (AmpC+/Amp)	Low risk	25/08/2016
ASS- Ezy MIC Strips	EM136	ESBL-AmpC Coexistence Detection Ezy MIC Kit	Low risk	25/08/2016
ASS- Ezy MIC Strips	EM137	MBL-ESBL-AmpC Co-existence Detection Ezy MIC Kit	Low risk	25/08/2016
ASS- Ezy MIC Strips	EM138	Cefpodoxime/Clavulanic Acid Ezy MIC Strip	Low risk	25/08/2016
ASS- Ezy MIC Strips	EM139	Amoxyclav Ezy MIC Strip (AUG) (0.016-256 mcg/ml)	Low risk	25/08/2016
ASS- Ezy MIC Strips	EM140	Ampicillin/Sulbactam Ezy MIC Strip (SAM) (4 mcg/ml)	Low risk	25/08/2016
ASS- Ezy MIC Strips	EM141	Ertapenem/Ertapenem + Boronic acid Ezy MIC Strip (ETP+/ETP)	Low risk	25/08/2016
ASS- Ezy MIC Strips	EM142	Terbinafine Ezy MIC Strip(TRB) (0.002-32 mcg/ml)	Low risk	25/08/2016
ASS- Ezy MIC Strips	EM143	Griseofulvin Ezy MIC Strip (GRI) (0.002-32 mcg/ml)	Low risk	25/08/2016
ASS- Ezy MIC Strips	EM144	Clotrimazole Ezy MIC Strip (CLO) (0.002-32 mcg/ml)	Low risk	25/08/2016
ASS- Ezy MIC Strips	EM145	Terbinafine Ezy MIC Strip(TRB) (0.002-32 mcg/ml)	Low risk	25/08/2016
ASS- Ezy MIC Strips	EM146	Miconazole Ezy MIC Strip (MIC) (0.002-32 mcg/ml)	Low risk	25/08/2016
ASS- Ezy MIC Strips	EM147	Flucloxacillin Ezy MIC Strip (FLC) (0.016-256 mcg/ml)	Low risk	04/07/2018
ASS- Ezy MIC Strips	EM148	Cefepime/Clavulanic acid Ezy MIC Strip (FIC) (0.016-256 mcg/ml)	Low risk	04/07/2018
ASS- Ezy MIC Strips	EM149	Ceftazidime /Tazobactam Ezy MIC Strip (CAT) (0.016-256 mcg/ml)	Low risk	04/07/2018
ASS- Ezy MIC Strips	EM150	Natamycin Ezy MIC Strip (NAT) (0.016-256 mcg/ml)	Low risk	22/04/2019
ASS- Ezy MIC Strips	EM151	Cefpirome/Sulbactam Ezy MIC™ Strip	Low risk	22/04/2019
ASS- Ezy MIC Strips	EM152	Ceftizoxime/Sulbactam Ezy MIC™ Strip	Low risk	10/11/2020
ASS- Ezy MIC Strips	EM153	Ceftazidime/Avibactam Ezy MIC™ Strip	Low risk	10/11/2020
ASS- Ezy MIC Strips	EM154	Faropenem/Clavulanic acid Ezy MIC™ strip (FAC)	Low risk	01/11/2020
ASS- Ezy MIC Strips	EM155	Cefuroxime/Clavulanic acid Ezy MIC™ strip (CXC)	Low risk	01/11/2020
ASS- Ezy MIC Strips	EM701	Xylomonas Ezy MIC Strip (0.016-256mcg/ml)	Low risk	25/08/2016
ASS- Ezy MIC Strips	EM702	Arbekacin Ezy MIC Strip (ABK) (0.016-256 mcg/ml)	Low risk	25/08/2016
ASS- Ezy MIC Strips	EM703	Garenoxacin Ezy MIC Strip (0.002-32 mcg/ml)	Low risk	25/08/2016
ASS- Ezy MIC Strips	EM705	Biapenem Ezy MIC Strip (BPM) (0.002-32 mcg/ml)	Low risk	25/08/2016
ASS- Ezy MIC Strips	EM706	Reinvexin Ezy MIC Strip (PB) (0.016-256 mcg/ml)	Low risk	16/12/2017
ASS- Sensitivity Discs (Multi Discs)	HX001	Hexa G-plus 1	Low risk	20/12/2012
ASS- Sensitivity Discs (Multi Discs)	HX002	Hexa G-plus 2	Low risk	20/12/2012
ASS- Sensitivity Discs (Multi Discs)	HX003	Hexa G-plus 3	Low risk	20/12/2012
ASS- Sensitivity Discs (Multi Discs)	HX004	Hexa G-plus 4	Low risk	20/12/2012
ASS- Sensitivity Discs (Multi Discs)	HX005	Hexa G-plus 5	Low risk	20/12/2012
ASS- Sensitivity Discs (Multi Discs)	HX006	Hexa G-minus 1	Low risk	20/12/2012
ASS- Sensitivity Discs (Multi Discs)	HX007	Hexa G-minus 2	Low risk	20/12/2012

ASS- Sensitivity Discs (Multi Discs)	HX008	Hexa G-minus 3	Low risk	20/12/2012
ASS- Sensitivity Discs (Multi Discs)	HX009	Hexa G-minus 4	Low risk	25/08/2016
ASS- Sensitivity Discs (Multi Discs)	HX010	Hexa G-minus 5	Low risk	20/12/2012
ASS- Sensitivity Discs (Multi Discs)	HX011	Hexa Pseudo 1	Low risk	20/12/2012
ASS- Sensitivity Discs (Multi Discs)	HX012	Hexa Pseudo 2	Low risk	20/12/2012
ASS- Sensitivity Discs (Multi Discs)	HX013	Hexa Pseudo 3	Low risk	20/12/2012
ASS- Sensitivity Discs (Multi Discs)	HX014	Hexa UTI-1	Low risk	20/12/2012
ASS- Sensitivity Discs (Multi Discs)	HX015	Hexa UTI-2	Low risk	20/12/2012
ASS- Sensitivity Discs (Multi Discs)	HX016	Hexa Haemophilus 1	Low risk	25/08/2016
ASS- Sensitivity Discs (Multi Discs)	HX017	Hexa Haemophilus 2	Low risk	20/12/2012
ASS- Sensitivity Discs (Multi Discs)	HX018	Hexa Haemophilus 3	Low risk	25/08/2016
ASS- Sensitivity Discs (Multi Discs)	HX019	Hexa Pneumococci 1	Low risk	25/08/2016
ASS- Sensitivity Discs (Multi Discs)	HX020	Hexa Pneumococci 2	Low risk	20/12/2012
ASS- Sensitivity Discs (Multi Discs)	HX021	Hexa Anaerobic 1	Low risk	20/12/2012
ASS- Sensitivity Discs (Multi Discs)	HX022	Hexa G-plus 6	Low risk	20/12/2012
ASS- Sensitivity Discs (Multi Discs)	HX023	Hexa G-plus 7	Low risk	20/12/2012
ASS- Sensitivity Discs (Multi Discs)	HX024	Hexa G-plus 8	Low risk	20/12/2012
ASS- Sensitivity Discs (Multi Discs)	HX025	Hexa G-Minus 6	Low risk	25/08/2016
ASS- Sensitivity Discs (Multi Discs)	HX026	Hexa Pseudo 4	Low risk	20/12/2012
ASS- Sensitivity Discs (Multi Discs)	HX027	Hexa G-Plus 9	Low risk	20/12/2012
ASS- Sensitivity Discs (Multi Discs)	HX028	Hexa G-minus 7	Low risk	20/12/2012
ASS- Sensitivity Discs (Multi Discs)	HX029	Hexa Pseudo 5	Low risk	20/12/2012
ASS- Sensitivity Discs (Multi Discs)	HX030	Hexa G-Minus 8	Low risk	20/12/2012
ASS- Sensitivity Discs (Multi Discs)	HX031	Hexa G-Plus 10	Low risk	20/12/2012
ASS- Sensitivity Discs (Multi Discs)	HX032	Hexa Universal - 1	Low risk	20/12/2012
ASS- Sensitivity Discs (Multi Discs)	HX033	Hexa UTI 3	Low risk	20/12/2012
ASS- Sensitivity Discs (Multi Discs)	HX034	Hexa G-plus11	Low risk	20/12/2012
ASS- Sensitivity Discs (Multi Discs)	HX035	Hexa G-minus 9	Low risk	20/12/2012
ASS- Sensitivity Discs (Multi Discs)	HX036	Hexa G-minus 29	Low risk	20/12/2012
ASS- Sensitivity Discs (Multi Discs)	HX037	Hexa UTI 4	Low risk	20/12/2012
ASS- Sensitivity Discs (Multi Discs)	HX038	Hexa Universal-2	Low risk	20/12/2012
ASS- Sensitivity Discs (Multi Discs)	HX039	Hexa G-plus 12	Low risk	20/12/2012
ASS- Sensitivity Discs (Multi Discs)	HX040	Hexa G-plus 13	Low risk	20/12/2012
ASS- Sensitivity Discs (Multi Discs)	HX041	Hexa Pneumococci - 3	Low risk	25/08/2016
ASS- Sensitivity Discs (Multi Discs)	HX042	Hexa Pneumococci-4	Low risk	20/12/2012
ASS- Sensitivity Discs (Multi Discs)	HX043	Hexa Pneumococci - 5	Low risk	25/08/2016
ASS- Sensitivity Discs (Multi Discs)	HX044	Hexa Pneumococci - 6	Low risk	25/08/2016
ASS- Sensitivity Discs (Multi Discs)	HX045	Hexa Pneumococci-7	Low risk	20/12/2012
ASS- Sensitivity Discs (Multi Discs)	HX046	Hexa Pneumococci-8	Low risk	20/12/2012
ASS- Sensitivity Discs (Multi Discs)	HX047	Hexa G-plus 25	Low risk	20/12/2012
ASS- Sensitivity Discs (Multi Discs)	HX048	Hexa G-plus 26	Low risk	20/12/2012
ASS- Sensitivity Discs (Multi Discs)	HX049	Hexa G-plus 27	Low risk	20/12/2012
ASS- Sensitivity Discs (Multi Discs)	HX050	Hexa Pseudo 6	Low risk	25/08/2016
ASS- Sensitivity Discs (Multi Discs)	HX051	Hexa Pseudo 7	Low risk	20/12/2012
ASS- Sensitivity Discs (Multi Discs)	HX052	Hexa Pseudo 8	Low risk	25/08/2016

ASS- Sensitivity Discs (Multi Discs)	HX053	Hexa Pseudo 9	Low risk	20/12/2012
ASS- Sensitivity Discs (Multi Discs)	HX054	Hexa Pseudo 10	Low risk	20/12/2012
ASS- Sensitivity Discs (Multi Discs)	HX055	Hexa Pseudo 11	Low risk	20/12/2012
ASS- Sensitivity Discs (Multi Discs)	HX056	Hexa G-minus 26	Low risk	20/12/2012
ASS- Sensitivity Discs (Multi Discs)	HX057	Hexa G-minus 27	Low risk	20/12/2012
ASS- Sensitivity Discs (Multi Discs)	HX058	Hexa G-minus 28	Low risk	20/12/2012
ASS- Sensitivity Discs (Multi Discs)	HX059	Hexa G-minus 10	Low risk	20/12/2012
ASS- Sensitivity Discs (Multi Discs)	HX060	Hexa G-minus 11	Low risk	20/12/2012
ASS- Sensitivity Discs (Multi Discs)	HX061	Hexa G-Minus 12	Low risk	25/08/2016
ASS- Sensitivity Discs (Multi Discs)	HX062	Hexa G-minus 13	Low risk	20/12/2012
ASS- Sensitivity Discs (Multi Discs)	HX063	Hexa G-minus 14	Low risk	20/12/2012
ASS- Sensitivity Discs (Multi Discs)	HX064	Hexa G-minus 15	Low risk	20/12/2012
ASS- Sensitivity Discs (Multi Discs)	HX065	Hexa G-Minus 16	Low risk	25/08/2016
ASS- Sensitivity Discs (Multi Discs)	HX066	Hexa G-minus 17	Low risk	20/12/2012
ASS- Sensitivity Discs (Multi Discs)	HX067	Hexa G-minus 18	Low risk	20/12/2012
ASS- Sensitivity Discs (Multi Discs)	HX068	Hexa G-minus 19	Low risk	20/12/2012
ASS- Sensitivity Discs (Multi Discs)	HX069	Hexa G-minus 20	Low risk	20/12/2012
ASS- Sensitivity Discs (Multi Discs)	HX070	Hexa G-minus 21	Low risk	20/12/2012
ASS- Sensitivity Discs (Multi Discs)	HX071	Hexa G-Minus 22	Low risk	25/08/2016
ASS- Sensitivity Discs (Multi Discs)	HX072	Hexa UTI 4 (Modified)	Low risk	20/12/2012
ASS- Sensitivity Discs (Multi Discs)	HX073	Hexa UTI 5	Low risk	20/12/2012
ASS- Sensitivity Discs (Multi Discs)	HX074	Hexa UTI 6	Low risk	20/12/2012
ASS- Sensitivity Discs (Multi Discs)	HX075	Hexa UTI 7	Low risk	20/12/2012
ASS- Sensitivity Discs (Multi Discs)	HX076	Hexa UTI 8	Low risk	20/12/2012
ASS- Sensitivity Discs (Multi Discs)	HX077	Hexa UTI 9	Low risk	20/12/2012
ASS- Sensitivity Discs (Multi Discs)	HX078	Hexa UTI 10	Low risk	25/08/2016
ASS- Sensitivity Discs (Multi Discs)	HX079	Hexa UTI 11	Low risk	20/12/2012
ASS- Sensitivity Discs (Multi Discs)	HX080	Hexa G-plus 14	Low risk	20/12/2012
ASS- Sensitivity Discs (Multi Discs)	HX081	Hexa G-plus 15	Low risk	20/12/2012
ASS- Sensitivity Discs (Multi Discs)	HX082	Hexa G-Plus 16	Low risk	25/08/2016
ASS- Sensitivity Discs (Multi Discs)	HX083	Hexa G-plus 17	Low risk	20/12/2012
ASS- Sensitivity Discs (Multi Discs)	HX084	Hexa Haemophilus 4	Low risk	20/12/2012
ASS- Sensitivity Discs (Multi Discs)	HX085	Hexa Haemophilus 5	Low risk	25/08/2016
ASS- Sensitivity Discs (Multi Discs)	HX086	Hexa Haemophilus 6	Low risk	20/12/2012
ASS- Sensitivity Discs (Multi Discs)	HX087	Hexa Haemophilus 7	Low risk	20/12/2012
ASS- Sensitivity Discs (Multi Discs)	HX088	Hexa Haemophilus 8	Low risk	20/12/2012
ASS- Sensitivity Discs (Multi Discs)	HX089	Hexa Haemophilus 9	Low risk	20/12/2012
ASS- Sensitivity Discs (Multi Discs)	HX090	Hexa G-plus 18	Low risk	20/12/2012
ASS- Sensitivity Discs (Multi Discs)	HX091	Hexa G-plus 19	Low risk	20/12/2012
ASS- Sensitivity Discs (Multi Discs)	HX092	Hexa G-plus 20	Low risk	20/12/2012
ASS- Sensitivity Discs (Multi Discs)	HX093	Hexa G-plus 21	Low risk	20/12/2012
ASS- Sensitivity Discs (Multi Discs)	HX094	Hexa G-Plus 22	Low risk	25/08/2016
ASS- Sensitivity Discs (Multi Discs)	HX095	Hexa G-minus 23	Low risk	20/12/2012
ASS- Sensitivity Discs (Multi Discs)	HX096	Hexa G-minus 24	Low risk	20/12/2012
ASS- Sensitivity Discs (Multi Discs)	HX097	Hexa Universal-2	Low risk	25/08/2016

ASS- Sensitivity Discs (Multi Discs)	HX098	Hexa Universal-3	Low risk	25/08/2016
ASS- Sensitivity Discs (Multi Discs)	HX099	Hexa UTI 12	Low risk	25/08/2016
ASS- Sensitivity Discs (Multi Discs)	HX100	Hexa G-Plus 23	Low risk	25/08/2016
ASS- Sensitivity Discs (Multi Discs)	HX101	Hexa G-plus 24	Low risk	20/12/2012
ASS- Sensitivity Discs (Multi Discs)	HX102	Hexa G-minus 25	Low risk	20/12/2012
ASS- Sensitivity Discs (Multi Discs)	HX103	Hexa Pseudo 12	Low risk	20/12/2012
ASS- Sensitivity Discs (Multi Discs)	HX104	Hexa Antimyc0-01	Low risk	20/12/2012
ASS- Sensitivity Discs (Multi Discs)	HX700	Hexa G-Plus 25	Low risk	25/08/2016
ASS- Sensitivity Discs (Multi Discs)	HX701	Hexa G-Minus 26	Low risk	25/08/2016
ASS- Sensitivity Discs (Multi Discs)	HX703	Hexa Pseudo-13	Low risk	25/08/2016
ASS- Sensitivity Discs (Multi Discs)	HX704	Hexa G-Minus 27	Low risk	25/08/2016
ASS- Sensitivity Discs (Multi Discs)	HX705	Hexa Anaerobic 2	Low risk	25/08/2016
ASS- Sensitivity Discs (Multi Discs)	HX706	Hexa UTI 14	Low risk	25/08/2016
ASS- Sensitivity Discs (Multi Discs)	HX707	Hexa G-Plus 26	Low risk	25/08/2016
ASS- Sensitivity Discs (Multi Discs)	HX708	Hexa G-Minus 28	Low risk	25/08/2016
ASS- Sensitivity Discs (Multi Discs)	HX709	Hexa Pseudo 14	Low risk	25/08/2016
ASS- Sensitivity Discs (Multi Discs)	HX710	Hexa UTI-15	Low risk	25/08/2016
ASS- Sensitivity Discs (Multi Discs)	HX711	Hexa G-Plus 27	Low risk	25/08/2016
ASS- Sensitivity Discs (Multi Discs)	HX712	Hexa Pseudo 15	Low risk	25/08/2016
ASS- Sensitivity Discs (Multi Discs)	HX713	Hexa Anaerobic-3	Low risk	25/08/2016
ASS- Sensitivity Discs (Multi Discs)	HX714	Hexa Combi 1	Low risk	25/08/2016
ASS- Sensitivity Discs (Multi Discs)	HX715	Hexa Universal 4	Low risk	25/08/2016
ASS- Sensitivity Discs (Multi Discs)	HX716	Hexa Universal 5	Low risk	25/08/2016
ASS- Sensitivity Discs (Multi Discs)	HX717	Hexa Combi 2	Low risk	25/08/2016
ASS- Sensitivity Discs (Multi Discs)	HX718	Hexa Combi 3	Low risk	25/08/2016
ASS- Sensitivity Discs (Multi Discs)	HX719	Hexa Combi 4	Low risk	25/08/2016
ASS- Sensitivity Discs (Multi Discs)	HX720	Hexa Combi 5	Low risk	25/08/2016
ASS- Sensitivity Discs (Multi Discs)	HX721	Hexa Combi 6	Low risk	25/08/2016
ASS- Sensitivity Discs (Multi Discs)	HX722	Hexa Combi 7	Low risk	25/08/2016
ASS- Sensitivity Discs (Multi Discs)	HX723	Hexa Combi 8	Low risk	25/08/2016
ASS- Sensitivity Discs (Multi Discs)	HX724	Hexa Combi 9	Low risk	28/04/2017
ASS- Sensitivity Discs (Multi Discs)	HX725	Hexa Combi 10	Low risk	28/04/2017
ASS- Sensitivity Discs (Multi Discs)	HX726	Hexa Combi 11	Low risk	28/04/2017
ASS- Sensitivity Discs (Multi Discs)	IC001	Icosa Universal - 1	Low risk	20/12/2012
ASS- Sensitivity Discs (Multi Discs)	IC002	Icosa G-I-Plus	Low risk	20/12/2012
ASS- Sensitivity Discs (Multi Discs)	IC003	Icosa G-I-Minus	Low risk	20/12/2012
ASS- Sensitivity Discs (Multi Discs)	IC004	Icosa UTI - 1	Low risk	20/12/2012
ASS- Sensitivity Discs (Multi Discs)	IC005	Icosa Pseudo - 1	Low risk	20/12/2012
ASS- Sensitivity Discs (Multi Discs)	IC006	Icosa Universal - 2	Low risk	20/12/2012
ASS- Sensitivity Discs (Multi Discs)	IC007	Icosa Pseudo - 2	Low risk	20/12/2012
ASS- Sensitivity Discs (Multi Discs)	IC008	Icosa G-II-Minus	Low risk	20/12/2012
ASS- Sensitivity Discs (Multi Discs)	IC701	Icosa Universal - 3	Low risk	25/08/2016
ASS- Sensitivity Discs (Multi Discs)	IC702	Icosa Universal - 4	Low risk	25/08/2016
ASS- Sensitivity Discs (Multi Discs)	IC703	Icosa Universal 5	Low risk	25/08/2016
ASS-HiComb MIC Strips	MD001	Amikacin	Low risk	20/12/2012

ASS-HiComb MIC Strips	MD002	Amoxicillin	Low risk	20/12/2012
ASS-HiComb MIC Strips	MD003	Amoxycrav (Amoxicillin/ Clavulanic acid)	Low risk	20/12/2012
ASS-HiComb MIC Strips	MD004	Azithromycin	Low risk	20/12/2012
ASS-HiComb MIC Strips	MD005	Azlocillin	Low risk	20/12/2012
ASS-HiComb MIC Strips	MD006	Aztreonam	Low risk	20/12/2012
ASS-HiComb MIC Strips	MD007	Carbencillin	Low risk	20/12/2012
ASS-HiComb MIC Strips	MD008	Cefazolin	Low risk	20/12/2012
ASS-HiComb MIC Strips	MD009	Cefdinir	Low risk	20/12/2012
ASS-HiComb MIC Strips	MD010	Cefepime	Low risk	20/12/2012
ASS-HiComb MIC Strips	MD011	Cefpirome	Low risk	20/12/2012
ASS-HiComb MIC Strips	MD012	Ceftazidime	Low risk	20/12/2012
ASS-HiComb MIC Strips	MD013	Ceftriaxone	Low risk	20/12/2012
ASS-HiComb MIC Strips	MD014	Cefalexin (Cephalexin)	Low risk	20/12/2012
ASS-HiComb MIC Strips	MD015	Cefotaxime (Cephotaxime)	Low risk	20/12/2012
ASS-HiComb MIC Strips	MD016	Chloramphenicol	Low risk	20/12/2012
ASS-HiComb MIC Strips	MD017	Ciprofloxacin	Low risk	20/12/2012
ASS-HiComb MIC Strips	MD018	Clarithromycin	Low risk	20/12/2012
ASS-HiComb MIC Strips	MD019	Clindamycin	Low risk	20/12/2012
ASS-HiComb MIC Strips	MD020	Colistin (Methane Sulphonate)	Low risk	20/12/2012
ASS-HiComb MIC Strips	MD021	Co-Trimoxazole (Sulpha/Trimethoprim)	Low risk	20/12/2012
ASS-HiComb MIC Strips	MD022	Erythromycin	Low risk	20/12/2012
ASS-HiComb MIC Strips	MD023	Fusidic Acid	Low risk	20/12/2012
ASS-HiComb MIC Strips	MD024	Gatifloxacin	Low risk	20/12/2012
ASS-HiComb MIC Strips	MD025	Gentamicin	Low risk	20/12/2012
ASS-HiComb MIC Strips	MD026	Kanamycin	Low risk	20/12/2012
ASS-HiComb MIC Strips	MD027	Levofloxacin	Low risk	20/12/2012
ASS-HiComb MIC Strips	MD028	Lincomycin	Low risk	20/12/2012
ASS-HiComb MIC Strips	MD029	Linezolid	Low risk	20/12/2012
ASS-HiComb MIC Strips	MD030	Lomefloxacin	Low risk	20/12/2012
ASS-HiComb MIC Strips	MD031	Methicillin	Low risk	20/12/2012
ASS-HiComb MIC Strips	MD032	Minocycline	Low risk	20/12/2012
ASS-HiComb MIC Strips	MD033	Moxifloxacin	Low risk	20/12/2012
ASS-HiComb MIC Strips	MD034	Mupirocin	Low risk	20/12/2012
ASS-HiComb MIC Strips	MD035	Nalidixic Acid	Low risk	20/12/2012
ASS-HiComb MIC Strips	MD036	Neomycin	Low risk	20/12/2012
ASS-HiComb MIC Strips	MD037	Nitrofurantoin	Low risk	20/12/2012
ASS-HiComb MIC Strips	MD038	Norfloxacin	Low risk	20/12/2012
ASS-HiComb MIC Strips	MD039	Ofloxacin	Low risk	20/12/2012
ASS-HiComb MIC Strips	MD040	Pefloxacin	Low risk	20/12/2012
ASS-HiComb MIC Strips	MD041	Piperacillin	Low risk	20/12/2012
ASS-HiComb MIC Strips	MD042	Piperacillin/Tazobactam	Low risk	20/12/2012
ASS-HiComb MIC Strips	MD043	Polymyxin-B	Low risk	20/12/2012
ASS-HiComb MIC Strips	MD044	Pristinomycin (Quinupristin/Dalfopristin)	Low risk	20/12/2012
ASS-HiComb MIC Strips	MD045	Rifampicin	Low risk	20/12/2012
ASS-HiComb MIC Strips	MD046	Roxithromycin	Low risk	20/12/2012

ASS-HiComb MIC Strips	MD047	Sparfloxacin	Low risk	20/12/2012
ASS-HiComb MIC Strips	MD048	Streptomycin	Low risk	20/12/2012
ASS-HiComb MIC Strips	MD049	Sulfasomidine	Low risk	20/12/2012
ASS-HiComb MIC Strips	MD050	Sulphadiazine	Low risk	20/12/2012
ASS-HiComb MIC Strips	MD051	Sulphafurazole (Sulfisoxazole)	Low risk	20/12/2012
ASS-HiComb MIC Strips	MD052	Sulphamethizole	Low risk	20/12/2012
ASS-HiComb MIC Strips	MD053	Sulphamethoxypyridazine	Low risk	20/12/2012
ASS-HiComb MIC Strips	MD054	Sulphaphenazole	Low risk	20/12/2012
ASS-HiComb MIC Strips	MD055	Teicoplanin	Low risk	20/12/2012
ASS-HiComb MIC Strips	MD056	Tetracycline	Low risk	20/12/2012
ASS-HiComb MIC Strips	MD057	Ticarcillin	Low risk	20/12/2012
ASS-HiComb MIC Strips	MD058	Tobramycin	Low risk	20/12/2012
ASS-HiComb MIC Strips	MD059	Trimethoprim	Low risk	20/12/2012
ASS-HiComb MIC Strips	MD060	Vancomycin	Low risk	20/12/2012
ASS-HiComb MIC Strips	MD061	Gentamicin	Low risk	20/12/2012
ASS-HiComb MIC Strips	MD062	Benzyl Penicillin	Low risk	20/12/2012
ASS-HiComb MIC Strips	MD063	Vancomycin	Low risk	20/12/2012
ASS-HiComb MIC Strips	MD064	Cefotaxime (Cephotaxime)	Low risk	20/12/2012
ASS-HiComb MIC Strips	MD065	Oxacillin	Low risk	20/12/2012
ASS-HiComb MIC Strips	MD066	Ceftriaxone	Low risk	20/12/2012
ASS-HiComb MIC Strips	MD067	Amikacin	Low risk	20/12/2012
ASS-HiComb MIC Strips	MD068	Ampicillin	Low risk	20/12/2012
ASS-HiComb MIC Strips	MD069	Ceftazidime	Low risk	20/12/2012
ASS-HiComb MIC Strips	MD070	Cefepime	Low risk	20/12/2012
ASS-HiComb MIC Strips	MD071	Amphotericin B	Low risk	20/12/2012
ASS-HiComb MIC Strips	MD072	Fluconazole	Low risk	20/12/2012
ASS-HiComb MIC Strips	MD073	Itraconazole	Low risk	20/12/2012
ASS-HiComb MIC Strips	MD074	Ketoconazole	Low risk	20/12/2012
ASS-HiComb MIC Strips	MD076	Gemifloxacin	Low risk	20/12/2012
ASS-HiComb MIC Strips	MD701	Cefepime/Tazobactam	Low risk	25/08/2016
ASS-HiComb MIC Strips	MD702	Ceftazidime/Tazobactam	Low risk	25/08/2016
ASS-HiComb MIC Strips	MD704	Nadifloxacin	Low risk	25/08/2016
ASS-HiComb MIC Strips	MD706	Cefoperazone/Tazobactam CST	Low risk	25/08/2016
ASS-HiComb MIC Strips	MD707	Balofloxacin	Low risk	25/08/2016
ASS-HiComb MIC Strips	MD708	Cefuroxime CXM	Low risk	25/08/2016
ASS-HiComb MIC Strips	MD709	Cefpodaxime CPD	Low risk	25/08/2016
ASS-HiComb MIC Strips	MD710	Cefpodaxime / Clavulanic acid (2:1)	Low risk	25/08/2016
ASS-HiComb MIC Strips	MD711	Netilmicin NET	Low risk	25/08/2016
ASS-HiComb MIC Strips	MD712	Cefixime CFM	Low risk	25/08/2016
ASS-HiComb MIC Strips	MD713	Pazufloxacin	Low risk	25/08/2016
ASS- Sensitivity Discs (Multi Discs)	OD001	G-I-plus	Low risk	20/12/2012
ASS- Sensitivity Discs (Multi Discs)	OD001R	G-I-plus	Low risk	20/12/2012
ASS- Sensitivity Discs (Multi Discs)	OD002	G-II-plus	Low risk	20/12/2012
ASS- Sensitivity Discs (Multi Discs)	OD002R	G-II-plus	Low risk	20/12/2012
ASS- Sensitivity Discs (Multi Discs)	OD003	G-III-plus	Low risk	20/12/2012

ASS- Sensitivity Discs (Multi Discs)	OD0032R	Combi I	Low risk	25/08/2016
ASS- Sensitivity Discs (Multi Discs)	OD003R	G-III-plus	Low risk	20/12/2012
ASS- Sensitivity Discs (Multi Discs)	OD004	G-IV-plus	Low risk	20/12/2012
ASS- Sensitivity Discs (Multi Discs)	OD004R	G-IV-plus	Low risk	20/12/2012
ASS- Sensitivity Discs (Multi Discs)	OD005	G-I-minus	Low risk	20/12/2012
ASS- Sensitivity Discs (Multi Discs)	OD005R	G-I-minus	Low risk	20/12/2012
ASS- Sensitivity Discs (Multi Discs)	OD006	G-II-minus	Low risk	20/12/2012
ASS- Sensitivity Discs (Multi Discs)	OD006R	G-II-minus	Low risk	20/12/2012
ASS- Sensitivity Discs (Multi Discs)	OD007	G-III-minus	Low risk	20/12/2012
ASS- Sensitivity Discs (Multi Discs)	OD007R	G-III-minus	Low risk	20/12/2012
ASS- Sensitivity Discs (Multi Discs)	OD008	Pseudo	Low risk	20/12/2012
ASS- Sensitivity Discs (Multi Discs)	OD008R	Pseudo	Low risk	20/12/2012
ASS- Sensitivity Discs (Multi Discs)	OD009	UTI-I	Low risk	20/12/2012
ASS- Sensitivity Discs (Multi Discs)	OD009R	UTI-I	Low risk	20/12/2012
ASS- Sensitivity Discs (Multi Discs)	OD010	UTI-II	Low risk	20/12/2012
ASS- Sensitivity Discs (Multi Discs)	OD010R	UTI-II	Low risk	20/12/2012
ASS- Sensitivity Discs (Multi Discs)	OD011	G-X-plus	Low risk	20/12/2012
ASS- Sensitivity Discs (Multi Discs)	OD011R	G-X-plus	Low risk	20/12/2012
ASS- Sensitivity Discs (Multi Discs)	OD012	G-IX-plus	Low risk	25/08/2016
ASS- Sensitivity Discs (Multi Discs)	OD012R	G-IX-plus	Low risk	25/08/2016
ASS- Sensitivity Discs (Multi Discs)	OD014	G-IV-minus	Low risk	20/12/2012
ASS- Sensitivity Discs (Multi Discs)	OD014R	G-IV-minus	Low risk	20/12/2012
ASS- Sensitivity Discs (Multi Discs)	OD015	G-V-minus	Low risk	20/12/2012
ASS- Sensitivity Discs (Multi Discs)	OD015R	G-V-minus	Low risk	20/12/2012
ASS- Sensitivity Discs (Multi Discs)	OD016	UTI-IV	Low risk	25/08/2016
ASS- Sensitivity Discs (Multi Discs)	OD016R	UTI-IV	Low risk	25/08/2016
ASS- Sensitivity Discs (Multi Discs)	OD017	UTI-VI	Low risk	20/12/2012
ASS- Sensitivity Discs (Multi Discs)	OD017R	UTI-VI	Low risk	20/12/2012
ASS- Sensitivity Discs (Multi Discs)	OD018	UTI-VII	Low risk	20/12/2012
ASS- Sensitivity Discs (Multi Discs)	OD018R	UTI-VII	Low risk	20/12/2012
ASS- Sensitivity Discs (Multi Discs)	OD019	UTI-V	Low risk	20/12/2012
ASS- Sensitivity Discs (Multi Discs)	OD019R	UTI-V	Low risk	20/12/2012
ASS- Sensitivity Discs (Multi Discs)	OD020	Combi I	Low risk	20/12/2012
ASS- Sensitivity Discs (Multi Discs)	OD020R	Combi I	Low risk	20/12/2012
ASS- Sensitivity Discs (Multi Discs)	OD021	Combi II	Low risk	20/12/2012
ASS- Sensitivity Discs (Multi Discs)	OD021R	Combi II	Low risk	20/12/2012
ASS- Sensitivity Discs (Multi Discs)	OD022	Combi III	Low risk	20/12/2012
ASS- Sensitivity Discs (Multi Discs)	OD022R	Combi III	Low risk	20/12/2012
ASS- Sensitivity Discs (Multi Discs)	OD023	Combi IV	Low risk	20/12/2012
ASS- Sensitivity Discs (Multi Discs)	OD023R	Combi IV	Low risk	20/12/2012
ASS- Sensitivity Discs (Multi Discs)	OD024	Combi V	Low risk	25/08/2016
ASS- Sensitivity Discs (Multi Discs)	OD024R	Combi V	Low risk	25/08/2016
ASS- Sensitivity Discs (Multi Discs)	OD025	Combi VI	Low risk	20/12/2012
ASS- Sensitivity Discs (Multi Discs)	OD025R	Combi VI	Low risk	20/12/2012
ASS- Sensitivity Discs (Multi Discs)	OD026	Combi VII	Low risk	20/12/2012

ASS- Sensitivity Discs (Multi Discs)	OD026R	Combi VII	Low risk	20/12/2012
ASS- Sensitivity Discs (Multi Discs)	OD027	Combi VIII	Low risk	25/08/2016
ASS- Sensitivity Discs (Multi Discs)	OD027R	Combi VIII	Low risk	25/08/2016
ASS- Sensitivity Discs (Multi Discs)	OD028	Combi IX	Low risk	25/08/2016
ASS- Sensitivity Discs (Multi Discs)	OD028R	Combi IX	Low risk	25/08/2016
ASS- Sensitivity Discs (Multi Discs)	OD029	Combi X	Low risk	25/08/2016
ASS- Sensitivity Discs (Multi Discs)	OD029R	Combi X	Low risk	25/08/2016
ASS- Sensitivity Discs (Multi Discs)	OD030	Combi XI	Low risk	20/12/2012
ASS- Sensitivity Discs (Multi Discs)	OD030R	Combi XI	Low risk	20/12/2012
ASS- Sensitivity Discs (Multi Discs)	OD031	Combi XII	Low risk	20/12/2012
ASS- Sensitivity Discs (Multi Discs)	OD031R	Combi XII	Low risk	20/12/2012
ASS- Sensitivity Discs (Multi Discs)	OD032	Combi XIII	Low risk	20/12/2012
ASS- Sensitivity Discs (Multi Discs)	OD032R	Combi XIII	Low risk	20/12/2012
ASS- Sensitivity Discs (Multi Discs)	OD033	G-V-plus	Low risk	20/12/2012
ASS- Sensitivity Discs (Multi Discs)	OD033R	G-V-plus	Low risk	20/12/2012
ASS- Sensitivity Discs (Multi Discs)	OD034	G-VI-plus	Low risk	20/12/2012
ASS- Sensitivity Discs (Multi Discs)	OD034R	G-VI-plus	Low risk	20/12/2012
ASS- Sensitivity Discs (Multi Discs)	OD035	UTI III	Low risk	20/12/2012
ASS- Sensitivity Discs (Multi Discs)	OD035R	UTI III	Low risk	20/12/2012
ASS- Sensitivity Discs (Multi Discs)	OD036	Pseudo I	Low risk	20/12/2012
ASS- Sensitivity Discs (Multi Discs)	OD036R	Pseudo I	Low risk	20/12/2012
ASS- Sensitivity Discs (Multi Discs)	OD037	G-VII-plus	Low risk	25/08/2016
ASS- Sensitivity Discs (Multi Discs)	OD037R	G-VII-plus	Low risk	25/08/2016
ASS- Sensitivity Discs (Multi Discs)	OD038	G-VIII-plus	Low risk	20/12/2012
ASS- Sensitivity Discs (Multi Discs)	OD038R	G-VIII-plus	Low risk	20/12/2012
ASS- Sensitivity Discs (Multi Discs)	OD039	G-XI-plus	Low risk	25/08/2016
ASS- Sensitivity Discs (Multi Discs)	OD039R	G-XI-plus	Low risk	25/08/2016
ASS- Sensitivity Discs (Multi Discs)	OD040	UTI-VIII	Low risk	25/08/2016
ASS- Sensitivity Discs (Multi Discs)	OD040R	UTI-VIII	Low risk	25/08/2016
ASS- Sensitivity Discs (Multi Discs)	OD041	G-XII-plus	Low risk	20/12/2012
ASS- Sensitivity Discs (Multi Discs)	OD041R	G-XII-plus	Low risk	20/12/2012
ASS- Sensitivity Discs (Multi Discs)	OD042	G-VI-minus	Low risk	20/12/2012
ASS- Sensitivity Discs (Multi Discs)	OD042R	G-VI-minus	Low risk	20/12/2012
ASS- Sensitivity Discs (Multi Discs)	OD043	G-VII-minus	Low risk	20/12/2012
ASS- Sensitivity Discs (Multi Discs)	OD043R	G-VII-minus	Low risk	20/12/2012
ASS- Sensitivity Discs (Multi Discs)	OD044	G-VIII-minus	Low risk	20/12/2012
ASS- Sensitivity Discs (Multi Discs)	OD044R	G-VIII-minus	Low risk	20/12/2012
ASS- Sensitivity Discs (Multi Discs)	OD045	G-IX-minus	Low risk	20/12/2012
ASS- Sensitivity Discs (Multi Discs)	OD045R	G-IX-minus	Low risk	20/12/2012
ASS- Sensitivity Discs (Multi Discs)	OD046	G-X-minus	Low risk	25/08/2016
ASS- Sensitivity Discs (Multi Discs)	OD046R	G-X-minus	Low risk	25/08/2016
ASS- Sensitivity Discs (Multi Discs)	OD047	G-XI-minus	Low risk	20/12/2012
ASS- Sensitivity Discs (Multi Discs)	OD047R	G-XI-minus	Low risk	20/12/2012
ASS- Sensitivity Discs (Multi Discs)	OD048	UTI-IX	Low risk	25/08/2016
ASS- Sensitivity Discs (Multi Discs)	OD048R	UTI-IX	Low risk	25/08/2016

ASS- Sensitivity Discs (Multi Discs)	OD049	G-XIII- plus	Low risk	25/08/2016
ASS- Sensitivity Discs (Multi Discs)	OD049R	G-XIII- plus	Low risk	25/08/2016
ASS- Sensitivity Discs (Multi Discs)	OD050	G-XIV- plus	Low risk	20/12/2012
ASS- Sensitivity Discs (Multi Discs)	OD050R	G-XIV- plus	Low risk	20/12/2012
ASS- Sensitivity Discs (Multi Discs)	OD051	UTI-X	Low risk	20/12/2012
ASS- Sensitivity Discs (Multi Discs)	OD051R	UTI-X	Low risk	20/12/2012
ASS- Sensitivity Discs (Multi Discs)	OD052	UTI-XI	Low risk	25/08/2016
ASS- Sensitivity Discs (Multi Discs)	OD052R	UTI-XI	Low risk	25/08/2016
ASS- Sensitivity Discs (Multi Discs)	OD053	G-XII-minus	Low risk	20/12/2012
ASS- Sensitivity Discs (Multi Discs)	OD053R	G-XII-minus	Low risk	20/12/2012
ASS- Sensitivity Discs (Multi Discs)	OD054	UTI-XII	Low risk	20/12/2012
ASS- Sensitivity Discs (Multi Discs)	OD054R	UTI-XII	Low risk	20/12/2012
ASS- Sensitivity Discs (Multi Discs)	OD055	G-XIII-minus	Low risk	20/12/2012
ASS- Sensitivity Discs (Multi Discs)	OD055R	G-XIII-minus	Low risk	20/12/2012
ASS- Sensitivity Discs (Multi Discs)	OD056	Combi 59	Low risk	25/08/2016
ASS- Sensitivity Discs (Multi Discs)	OD056R	Combi 59	Low risk	25/08/2016
ASS- Sensitivity Discs (Multi Discs)	OD057	G-XVIII-minus	Low risk	20/12/2012
ASS- Sensitivity Discs (Multi Discs)	OD057R	G-XVIII-minus	Low risk	20/12/2012
ASS- Sensitivity Discs (Multi Discs)	OD058	G-XIX-minus	Low risk	25/08/2016
ASS- Sensitivity Discs (Multi Discs)	OD058R	G-XIX-minus	Low risk	25/08/2016
ASS- Sensitivity Discs (Multi Discs)	OD059	G-XX-minus	Low risk	25/08/2016
ASS- Sensitivity Discs (Multi Discs)	OD059R	G-XX-minus	Low risk	25/08/2016
ASS- Sensitivity Discs (Multi Discs)	OD060	G-XXI-minus	Low risk	20/12/2012
ASS- Sensitivity Discs (Multi Discs)	OD060R	G-XXI-minus	Low risk	20/12/2012
ASS- Sensitivity Discs (Multi Discs)	OD061	G-XXII-minus	Low risk	20/12/2012
ASS- Sensitivity Discs (Multi Discs)	OD061R	G-XXII-minus	Low risk	20/12/2012
ASS- Sensitivity Discs (Multi Discs)	OD062	G-XXIII-minus	Low risk	25/08/2016
ASS- Sensitivity Discs (Multi Discs)	OD062R	G-XXIII-minus	Low risk	25/08/2016
ASS- Sensitivity Discs (Multi Discs)	OD063	Pseudo V	Low risk	20/12/2012
ASS- Sensitivity Discs (Multi Discs)	OD063R	Pseudo V	Low risk	20/12/2012
ASS- Sensitivity Discs (Multi Discs)	OD064	Combi-XIV	Low risk	25/08/2016
ASS- Sensitivity Discs (Multi Discs)	OD064R	Combi XIV	Low risk	25/08/2016
ASS- Sensitivity Discs (Multi Discs)	OD064R	Combi XIV	Low risk	25/08/2016
ASS- Sensitivity Discs (Multi Discs)	OD065	UTI-XVII	Low risk	25/08/2016
ASS- Sensitivity Discs (Multi Discs)	OD065R	UTI-XVII	Low risk	25/08/2016
ASS- Sensitivity Discs (Multi Discs)	OD066	Combi 82	Low risk	20/12/2012
ASS- Sensitivity Discs (Multi Discs)	OD066R	Combi 82	Low risk	20/12/2012
ASS- Sensitivity Discs (Multi Discs)	OD067	Combi 83	Low risk	20/12/2012
ASS- Sensitivity Discs (Multi Discs)	OD067R	Combi 83	Low risk	20/12/2012
ASS- Sensitivity Discs (Multi Discs)	OD202	Comb XXI	Low risk	25/08/2016
ASS- Sensitivity Discs (Multi Discs)	OD209	Combi 28	Low risk	25/08/2016
ASS- Sensitivity Discs (Multi Discs)	OD211	Combi 30	Low risk	25/08/2016
ASS- Sensitivity Discs (Multi Discs)	OD211R	Combi 30	Low risk	25/08/2016
ASS- Sensitivity Discs (Multi Discs)	OD212	Combi 31	Low risk	25/08/2016
ASS- Sensitivity Discs (Multi Discs)	OD215	Combi 34	Low risk	25/08/2016

ASS- Sensitivity Discs (Multi Discs)	OD215R	Combi 34	Low risk	25/08/2016
ASS- Sensitivity Discs (Multi Discs)	OD216	Combi 35	Low risk	25/08/2016
ASS- Sensitivity Discs (Multi Discs)	OD216	Combi 35	Low risk	25/08/2016
ASS- Sensitivity Discs (Multi Discs)	OD216R	Combi 35	Low risk	25/08/2016
ASS- Sensitivity Discs (Multi Discs)	OD220	Combi 39	Low risk	25/08/2016
ASS- Sensitivity Discs (Multi Discs)	OD221	Combi 40	Low risk	25/08/2016
ASS- Sensitivity Discs (Multi Discs)	OD223	G XIV minus	Low risk	25/08/2016
ASS- Sensitivity Discs (Multi Discs)	OD224	G XV plus	Low risk	25/08/2016
ASS- Sensitivity Discs (Multi Discs)	OD225	UTI XIII	Low risk	25/08/2016
ASS- Sensitivity Discs (Multi Discs)	OD226	Combi 41	Low risk	25/08/2016
ASS- Sensitivity Discs (Multi Discs)	OD227	UTI-XIV	Low risk	25/08/2016
ASS- Sensitivity Discs (Multi Discs)	OD228	Pseudo II	Low risk	25/08/2016
ASS- Sensitivity Discs (Multi Discs)	OD229	G-XV-minus	Low risk	25/08/2016
ASS- Sensitivity Discs (Multi Discs)	OD230	G-XVI-plus	Low risk	25/08/2016
ASS- Sensitivity Discs (Multi Discs)	OD231	Combi -42	Low risk	25/08/2016
ASS- Sensitivity Discs (Multi Discs)	OD232	Combi 43	Low risk	25/08/2016
ASS- Sensitivity Discs (Multi Discs)	OD233	Combi 44	Low risk	25/08/2016
ASS- Sensitivity Discs (Multi Discs)	OD233	Combi 44	Low risk	25/08/2016
ASS- Sensitivity Discs (Multi Discs)	OD233R	Combi 44	Low risk	25/08/2016
ASS- Sensitivity Discs (Multi Discs)	OD233R	Combi 44	Low risk	25/08/2016
ASS- Sensitivity Discs (Multi Discs)	OD234	Combi 45	Low risk	25/08/2016
ASS- Sensitivity Discs (Multi Discs)	OD234R	Combi 45	Low risk	25/08/2016
ASS- Sensitivity Discs (Multi Discs)	OD241	Combi 49	Low risk	25/08/2016
ASS- Sensitivity Discs (Multi Discs)	OD241R	Combi 49	Low risk	25/08/2016
ASS- Sensitivity Discs (Multi Discs)	OD243	G XVII minus	Low risk	25/08/2016
ASS- Sensitivity Discs (Multi Discs)	OD244	G XIX plus	Low risk	25/08/2016
ASS- Sensitivity Discs (Multi Discs)	OD248	Combi-53	Low risk	25/08/2016
ASS- Sensitivity Discs (Multi Discs)	OD249	Combi-54	Low risk	25/08/2016
ASS- Sensitivity Discs (Multi Discs)	OD250	Pseudo - III for Pseudomonas	Low risk	25/08/2016
ASS- Sensitivity Discs (Multi Discs)	OD251	GXX plus	Low risk	25/08/2016
ASS- Sensitivity Discs (Multi Discs)	OD253	Combi 56	Low risk	25/08/2016
ASS- Sensitivity Discs (Multi Discs)	OD256	Combi 59	Low risk	20/12/2012
ASS- Sensitivity Discs (Multi Discs)	OD256R	Combi 59	Low risk	20/12/2012
ASS- Sensitivity Discs (Multi Discs)	OD257	Combi 60	Low risk	20/12/2012
ASS- Sensitivity Discs (Multi Discs)	OD257R	Combi 60	Low risk	20/12/2012
ASS- Sensitivity Discs (Multi Discs)	OD258	Combi 61	Low risk	20/12/2012
ASS- Sensitivity Discs (Multi Discs)	OD258R	Combi 61	Low risk	20/12/2012
ASS- Sensitivity Discs (Multi Discs)	OD259	Combi 62	Low risk	25/08/2016
ASS- Sensitivity Discs (Multi Discs)	OD259R	Combi 62	Low risk	25/08/2016
ASS- Sensitivity Discs (Multi Discs)	OD260	UTI-XIII	Low risk	25/08/2016
ASS- Sensitivity Discs (Multi Discs)	OD261	UTI-XIV	Low risk	25/08/2016
ASS- Sensitivity Discs (Multi Discs)	OD262	UTI-E	Low risk	25/08/2016
ASS- Sensitivity Discs (Multi Discs)	OD263	UTI-XV	Low risk	25/08/2016
ASS- Sensitivity Discs (Multi Discs)	OD264	Pseudo II	Low risk	25/08/2016
ASS- Sensitivity Discs (Multi Discs)	OD265	Combi 63	Low risk	25/08/2016

ASS- Sensitivity Discs (Multi Discs)	OD266	Combi 64	Low risk	25/08/2016
ASS- Sensitivity Discs (Multi Discs)	OD267	Combi 65	Low risk	25/08/2016
ASS- Sensitivity Discs (Multi Discs)	OD268	Combi 66	Low risk	25/08/2016
ASS- Sensitivity Discs (Multi Discs)	OD269	Combi 67	Low risk	20/12/2012
ASS- Sensitivity Discs (Multi Discs)	OD269R	Combi 67	Low risk	20/12/2012
ASS- Sensitivity Discs (Multi Discs)	OD270	Combi 68	Low risk	20/12/2012
ASS- Sensitivity Discs (Multi Discs)	OD270R	Combi 68	Low risk	20/12/2012
ASS- Sensitivity Discs (Multi Discs)	OD271	Combi 69	Low risk	20/12/2012
ASS- Sensitivity Discs (Multi Discs)	OD271R	Combi 69	Low risk	20/12/2012
ASS- Sensitivity Discs (Multi Discs)	OD272	Combi 70	Low risk	20/12/2012
ASS- Sensitivity Discs (Multi Discs)	OD272R	Combi 70	Low risk	20/12/2012
ASS- Sensitivity Discs (Multi Discs)	OD273	Combi 71	Low risk	20/12/2012
ASS- Sensitivity Discs (Multi Discs)	OD273R	Combi 71	Low risk	20/12/2012
ASS- Sensitivity Discs (Multi Discs)	OD274	Combi 72	Low risk	25/08/2016
ASS- Sensitivity Discs (Multi Discs)	OD274R	Combi 72	Low risk	25/08/2016
ASS- Sensitivity Discs (Multi Discs)	OD275	Combi 73	Low risk	25/08/2016
ASS- Sensitivity Discs (Multi Discs)	OD275R	Combi 73	Low risk	25/08/2016
ASS- Sensitivity Discs (Multi Discs)	OD275RS	Combi 60	Low risk	25/08/2016
ASS- Sensitivity Discs (Multi Discs)	OD275S	Combi 60	Low risk	25/08/2016
ASS- Sensitivity Discs (Multi Discs)	OD276	Combi 84	Low risk	20/12/2012
ASS- Sensitivity Discs (Multi Discs)	OD276R	Combi 84	Low risk	20/12/2012
ASS- Sensitivity Discs (Multi Discs)	OD277	Combi 77	Low risk	20/12/2012
ASS- Sensitivity Discs (Multi Discs)	OD277R	Combi 77	Low risk	20/12/2012
ASS- Sensitivity Discs (Multi Discs)	OD278	Combi 78	Low risk	20/12/2012
ASS- Sensitivity Discs (Multi Discs)	OD278R	Combi 78	Low risk	20/12/2012
ASS- Sensitivity Discs (Multi Discs)	OD279	Combi 79	Low risk	25/08/2016
ASS- Sensitivity Discs (Multi Discs)	OD279R	Combi 79	Low risk	25/08/2016
ASS- Sensitivity Discs (Multi Discs)	OD280	Combi 80	Low risk	20/12/2012
ASS- Sensitivity Discs (Multi Discs)	OD280R	Combi 80	Low risk	20/12/2012
ASS- Sensitivity Discs (Multi Discs)	OD281	Combi 85	Low risk	20/12/2012
ASS- Sensitivity Discs (Multi Discs)	OD281R	Combi 85	Low risk	20/12/2012
ASS- Sensitivity Discs (Multi Discs)	OD282	Combi 505	Low risk	20/12/2012
ASS- Sensitivity Discs (Multi Discs)	OD282R	Combi 505	Low risk	20/12/2012
ASS- Sensitivity Discs (Multi Discs)	OD283	Combi 506	Low risk	20/12/2012
ASS- Sensitivity Discs (Multi Discs)	OD283R	Combi 506	Low risk	20/12/2012
ASS- Sensitivity Discs (Multi Discs)	OD284	Combi 508	Low risk	20/12/2012
ASS- Sensitivity Discs (Multi Discs)	OD284R	Combi 508	Low risk	20/12/2012
ASS- Sensitivity Discs (Multi Discs)	OD285	Combi 509	Low risk	20/12/2012
ASS- Sensitivity Discs (Multi Discs)	OD285R	Combi 509	Low risk	20/12/2012
ASS- Sensitivity Discs (Multi Discs)	OD286	Combi 510	Low risk	20/12/2012
ASS- Sensitivity Discs (Multi Discs)	OD286R	Combi 510	Low risk	20/12/2012
ASS- Sensitivity Discs (Multi Discs)	OD287	Combi 511	Low risk	20/12/2012
ASS- Sensitivity Discs (Multi Discs)	OD287R	Combi 511	Low risk	20/12/2012
ASS- Sensitivity Discs (Multi Discs)	OD288	Combi 512	Low risk	25/08/2016
ASS- Sensitivity Discs (Multi Discs)	OD288R	Combi 512	Low risk	25/08/2016

ASS- Sensitivity Discs (Multi Discs)	OD289	Combi 513	Low risk	20/12/2012
ASS- Sensitivity Discs (Multi Discs)	OD289R	Combi 513	Low risk	20/12/2012
ASS- Sensitivity Discs (Multi Discs)	OD290	Combi 514	Low risk	20/12/2012
ASS- Sensitivity Discs (Multi Discs)	OD290R	Combi 514	Low risk	20/12/2012
ASS- Sensitivity Discs (Multi Discs)	OD291	Combi 90	Low risk	20/12/2012
ASS- Sensitivity Discs (Multi Discs)	OD291R	Combi 90	Low risk	20/12/2012
ASS- Sensitivity Discs (Multi Discs)	OD292	Combi 91	Low risk	20/12/2012
ASS- Sensitivity Discs (Multi Discs)	OD292R	Combi 91	Low risk	20/12/2012
ASS- Sensitivity Discs (Multi Discs)	OD293	Combi 92	Low risk	20/12/2012
ASS- Sensitivity Discs (Multi Discs)	OD293R	Combi 92	Low risk	20/12/2012
ASS- Sensitivity Discs (Multi Discs)	OD294	Combi 93	Low risk	20/12/2012
ASS- Sensitivity Discs (Multi Discs)	OD294R	Combi 93	Low risk	20/12/2012
ASS- Sensitivity Discs (Multi Discs)	OD295	Combi 516	Low risk	20/12/2012
ASS- Sensitivity Discs (Multi Discs)	OD295R	Combi 516	Low risk	20/12/2012
ASS- Sensitivity Discs (Multi Discs)	OD296	Combi 517	Low risk	20/12/2012
ASS- Sensitivity Discs (Multi Discs)	OD296R	Combi 517	Low risk	20/12/2012
ASS- Sensitivity Discs (Multi Discs)	OD297	Combi 518	Low risk	20/12/2012
ASS- Sensitivity Discs (Multi Discs)	OD297R	Combi 518	Low risk	20/12/2012
ASS- Sensitivity Discs (Multi Discs)	OD298	Combi 94	Low risk	20/12/2012
ASS- Sensitivity Discs (Multi Discs)	OD298R	Combi 94	Low risk	20/12/2012
ASS- Sensitivity Discs (Multi Discs)	OD299	Combi 95	Low risk	20/12/2012
ASS- Sensitivity Discs (Multi Discs)	OD299R	Combi 95	Low risk	20/12/2012
ASS- Sensitivity Discs (Multi Discs)	OD300	Combi 96	Low risk	20/12/2012
ASS- Sensitivity Discs (Multi Discs)	OD300R	Combi 96	Low risk	20/12/2012
ASS- Sensitivity Discs (Multi Discs)	OD301	G minus-24	Low risk	20/12/2012
ASS- Sensitivity Discs (Multi Discs)	OD301R	G minus-24	Low risk	20/12/2012
ASS- Sensitivity Discs (Multi Discs)	OD302	G minus-25	Low risk	20/12/2012
ASS- Sensitivity Discs (Multi Discs)	OD302R	G minus-25	Low risk	20/12/2012
ASS- Sensitivity Discs (Multi Discs)	OD303	G Plus-15	Low risk	20/12/2012
ASS- Sensitivity Discs (Multi Discs)	OD303R	G Plus-15	Low risk	20/12/2012
ASS- Sensitivity Discs (Multi Discs)	OD304	G Plus-16	Low risk	20/12/2012
ASS- Sensitivity Discs (Multi Discs)	OD304R	G Plus-16	Low risk	20/12/2012
ASS- Sensitivity Discs (Multi Discs)	OD305	G Plus-17	Low risk	20/12/2012
ASS- Sensitivity Discs (Multi Discs)	OD305R	G Plus-17	Low risk	20/12/2012
ASS- Sensitivity Discs (Multi Discs)	OD306	UTI-18	Low risk	20/12/2012
ASS- Sensitivity Discs (Multi Discs)	OD306R	UTI-18	Low risk	20/12/2012
ASS- Sensitivity Discs (Multi Discs)	OD307	Pseudo VI	Low risk	20/12/2012
ASS- Sensitivity Discs (Multi Discs)	OD307R	Pseudo VI	Low risk	20/12/2012
ASS- Sensitivity Discs (Multi Discs)	OD308	Universal - 1	Low risk	20/12/2012
ASS- Sensitivity Discs (Multi Discs)	OD308R	Universal - 1	Low risk	20/12/2012
ASS- Sensitivity Discs (Multi Discs)	OD309	G Plus-18	Low risk	20/12/2012
ASS- Sensitivity Discs (Multi Discs)	OD309R	G Plus-18	Low risk	20/12/2012
ASS- Sensitivity Discs (Multi Discs)	OD310	G minus-26	Low risk	20/12/2012
ASS- Sensitivity Discs (Multi Discs)	OD310R	G minus-26	Low risk	20/12/2012
ASS- Sensitivity Discs (Multi Discs)	OD311	G minus-27	Low risk	20/12/2012

ASS- Sensitivity Discs (Multi Discs)	OD311R	G minus-27	Low risk	20/12/2012
ASS- Sensitivity Discs (Multi Discs)	OD312	G Minus - 28	Low risk	20/12/2012
ASS- Sensitivity Discs (Multi Discs)	OD312R	G Minus - 28	Low risk	20/12/2012
ASS- Sensitivity Discs (Multi Discs)	OD313	G Minus - 29	Low risk	20/12/2012
ASS- Sensitivity Discs (Multi Discs)	OD313R	G Minus - 29	Low risk	20/12/2012
ASS- Sensitivity Discs (Multi Discs)	OD704	Combi 77	Low risk	25/08/2016
ASS- Sensitivity Discs (Multi Discs)	OD705	Combi 78	Low risk	25/08/2016
ASS- Sensitivity Discs (Multi Discs)	OD706	Combi 79	Low risk	25/08/2016
ASS- Sensitivity Discs (Multi Discs)	OD707	Combi 80	Low risk	25/08/2016
ASS- Sensitivity Discs (Multi Discs)	OD708	Combi 81	Low risk	25/08/2016
ASS- Sensitivity Discs (Multi Discs)	OD709	Combi 85	Low risk	25/08/2016
ASS- Sensitivity Discs (Multi Discs)	OD710	Combi 86	Low risk	25/08/2016
ASS- Sensitivity Discs (Multi Discs)	OD711	Combi 501	Low risk	25/08/2016
ASS- Sensitivity Discs (Multi Discs)	OD712	Combi 502	Low risk	25/08/2016
ASS- Sensitivity Discs (Multi Discs)	OD713	Combi 503	Low risk	25/08/2016
ASS- Sensitivity Discs (Multi Discs)	OD714	Combi 504	Low risk	25/08/2016
ASS- Sensitivity Discs (Multi Discs)	OD715	Combi 505	Low risk	25/08/2016
ASS- Sensitivity Discs (Multi Discs)	OD716	Combi 506	Low risk	25/08/2016
ASS- Sensitivity Discs (Multi Discs)	OD717	Octodiscs-A	Low risk	25/08/2016
ASS- Sensitivity Discs (Multi Discs)	OD718	Octodiscs-B	Low risk	25/08/2016
ASS- Sensitivity Discs (Multi Discs)	OD719	Octodiscs-C	Low risk	25/08/2016
ASS- Sensitivity Discs (Multi Discs)	OD720	Octodiscs-D	Low risk	25/08/2016
ASS- Sensitivity Discs (Multi Discs)	OD721	Octodiscs-E	Low risk	25/08/2016
ASS- Sensitivity Discs (Multi Discs)	OD722	Octodiscs-F	Low risk	25/08/2016
ASS- Sensitivity Discs (Multi Discs)	OD723	Octodiscs-G	Low risk	25/08/2016
ASS- Sensitivity Discs (Multi Discs)	OD724	Combi 507	Low risk	25/08/2016
ASS- Sensitivity Discs (Multi Discs)	OD725	Combi 508	Low risk	25/08/2016
ASS- Sensitivity Discs (Multi Discs)	OD725	Combi 508	Low risk	25/08/2016
ASS- Sensitivity Discs (Multi Discs)	OD726	Combi 509	Low risk	25/08/2016
ASS- Sensitivity Discs (Multi Discs)	OD726	Combi 509	Low risk	25/08/2016
ASS- Sensitivity Discs (Multi Discs)	OD727	Combi 510	Low risk	25/08/2016
ASS- Sensitivity Discs (Multi Discs)	OD727	Combi 510	Low risk	25/08/2016
ASS- Sensitivity Discs (Multi Discs)	OD728	Combi 511	Low risk	25/08/2016
ASS- Sensitivity Discs (Multi Discs)	OD729	Combi 512	Low risk	25/08/2016
ASS- Sensitivity Discs (Multi Discs)	OD730	Combi 513	Low risk	25/08/2016
ASS- Sensitivity Discs (Multi Discs)	OD731	Combi 514	Low risk	25/08/2016
ASS- Sensitivity Discs (Multi Discs)	OD732	Combi 515	Low risk	25/08/2016
ASS- Sensitivity Discs (Multi Discs)	OD733	Combi 516	Low risk	25/08/2016
ASS- Sensitivity Discs (Multi Discs)	OD734	Combi 517	Low risk	25/08/2016
ASS- Sensitivity Discs (Multi Discs)	OD735	Combi 518	Low risk	25/08/2016
ASS- Sensitivity Discs (Multi Discs)	OD736R	Combi 519	Low risk	25/08/2016
ASS- Sensitivity Discs (Multi Discs)	OD736R	Combi 519	Low risk	25/08/2016
ASS- Sensitivity Discs (Multi Discs)	OD737	Combi 520	Low risk	25/08/2016
ASS- Sensitivity Discs (Multi Discs)	OD737R	Combi 520	Low risk	25/08/2016
ASS- Sensitivity Discs (Multi Discs)	OD738	Combi 521	Low risk	25/08/2016

ASS- Sensitivity Discs (Multi Discs)	OD738R	Combi 521	Low risk	25/08/2016
ASS- Sensitivity Discs (Multi Discs)	OD739	Combi 522	Low risk	25/08/2016
ASS- Sensitivity Discs (Multi Discs)	OD739R	Combi 522	Low risk	25/08/2016
ASS- Sensitivity Discs (Multi Discs)	OD740	Combi 523	Low risk	25/08/2016
ASS- Sensitivity Discs (Multi Discs)	OD740R	Combi 523	Low risk	25/08/2016
ASS- Sensitivity Discs (Multi Discs)	OD741	Combi 524	Low risk	25/08/2016
ASS- Sensitivity Discs (Multi Discs)	OD741R	Combi 524	Low risk	25/08/2016
ASS- Sensitivity Discs (Multi Discs)	OD742	Combi 525	Low risk	25/08/2016
ASS- Sensitivity Discs (Multi Discs)	OD742R	Combi 525	Low risk	25/08/2016
ASS- Sensitivity Discs (Multi Discs)	OD743	Combi 526	Low risk	25/08/2016
ASS- Sensitivity Discs (Multi Discs)	OD743R	Combi 526	Low risk	25/08/2016
ASS- Sensitivity Discs (Multi Discs)	OD744	Combi 527	Low risk	25/08/2016
ASS- Sensitivity Discs (Multi Discs)	OD744R	Combi 527	Low risk	25/08/2016
ASS- Sensitivity Discs (Multi Discs)	OD745	Combi 528	Low risk	25/08/2016
ASS- Sensitivity Discs (Multi Discs)	OD745R	Combi 528	Low risk	25/08/2016
ASS- Sensitivity Discs (Multi Discs)	OD746	Combi 529	Low risk	25/08/2016
ASS- Sensitivity Discs (Multi Discs)	OD746R	Combi 529	Low risk	25/08/2016
ASS- Sensitivity Discs (Multi Discs)	OD747	Combi 530	Low risk	25/08/2016
ASS- Sensitivity Discs (Multi Discs)	OD747R	Combi 530	Low risk	25/08/2016
ASS- Sensitivity Discs (Multi Discs)	OD748	Combi 531	Low risk	25/08/2016
ASS- Sensitivity Discs (Multi Discs)	OD748R	Combi 531	Low risk	25/08/2016
ASS- Sensitivity Discs (Multi Discs)	OD749	Combi 532	Low risk	25/08/2016
ASS- Sensitivity Discs (Multi Discs)	OD749R	Combi 532	Low risk	25/08/2016
ASS- Sensitivity Discs (Multi Discs)	OD750	Combi 533	Low risk	25/08/2016
ASS- Sensitivity Discs (Multi Discs)	OD750R	Combi 533	Low risk	25/08/2016
ASS- Sensitivity Discs (Multi Discs)	OD751	Combi 534	Low risk	25/08/2016
ASS- Sensitivity Discs (Multi Discs)	OD751R	Combi 534	Low risk	25/08/2016
ASS- Sensitivity Discs (Multi Discs)	OD752	Combi 535	Low risk	25/08/2016
ASS- Sensitivity Discs (Multi Discs)	OD752R	Combi 535	Low risk	25/08/2016
ASS- Sensitivity Discs (Multi Discs)	OD753	Combi 536	Low risk	25/08/2016
ASS- Sensitivity Discs (Multi Discs)	OD753R	Combi 536	Low risk	25/08/2016
ASS- Sensitivity Discs (Multi Discs)	OD754	Combi 537	Low risk	25/08/2016
ASS- Sensitivity Discs (Multi Discs)	OD754R	Combi 537	Low risk	25/08/2016
ASS- Sensitivity Discs (Multi Discs)	OD755	Combi 538	Low risk	25/08/2016
ASS- Sensitivity Discs (Multi Discs)	OD755R	Combi 538	Low risk	25/08/2016
ASS- Sensitivity Discs (Multi Discs)	OD756	Combi 539	Low risk	25/08/2016
ASS- Sensitivity Discs (Multi Discs)	OD756R	Combi 539	Low risk	25/08/2016
ASS- Sensitivity Discs (Multi Discs)	OD757	Combi 540	Low risk	25/08/2016
ASS- Sensitivity Discs (Multi Discs)	OD757R	Combi 540	Low risk	25/08/2016
ASS- Sensitivity Discs (Multi Discs)	OD758	Combi 541	Low risk	25/08/2016
ASS- Sensitivity Discs (Multi Discs)	OD758R	Combi 541	Low risk	25/08/2016
ASS- Sensitivity Discs (Multi Discs)	OD759	Combi 542	Low risk	25/08/2016
ASS- Sensitivity Discs (Multi Discs)	OD759R	Combi 542	Low risk	25/08/2016
ASS- Sensitivity Discs (Multi Discs)	OD760	Combi 543	Low risk	25/08/2016
ASS- Sensitivity Discs (Multi Discs)	OD760R	Combi 543	Low risk	25/08/2016

ASS- Sensitivity Discs (Multi Discs)	OD761	Combi 544	Low risk	25/08/2016
ASS- Sensitivity Discs (Multi Discs)	OD761R	Combi 544	Low risk	25/08/2016
ASS- Sensitivity Discs (Multi Discs)	OD762	Combi 545	Low risk	25/08/2016
ASS- Sensitivity Discs (Multi Discs)	OD762R	Combi 545	Low risk	25/08/2016
ASS- Sensitivity Discs (Multi Discs)	OD763	Combi 546	Low risk	25/08/2016
ASS- Sensitivity Discs (Multi Discs)	OD763R	Combi 546	Low risk	25/08/2016
ASS- Sensitivity Discs (Multi Discs)	OD764	Combi 547	Low risk	25/08/2016
ASS- Sensitivity Discs (Multi Discs)	OD764R	Combi 547	Low risk	25/08/2016
ASS- Sensitivity Discs (Multi Discs)	OD765	Combi 548	Low risk	25/08/2016
ASS- Sensitivity Discs (Multi Discs)	OD765R	Combi 548	Low risk	25/08/2016
ASS- Sensitivity Discs (Multi Discs)	OD766	Combi 549	Low risk	25/08/2016
ASS- Sensitivity Discs (Multi Discs)	OD766R	Combi 549	Low risk	25/08/2016
ASS- Sensitivity Discs (Multi Discs)	OD767	Combi 550	Low risk	25/08/2016
ASS- Sensitivity Discs (Multi Discs)	OD767R	Combi 550	Low risk	25/08/2016
ASS- Sensitivity Discs (Multi Discs)	OD768	Combi 551	Low risk	25/08/2016
ASS- Sensitivity Discs (Multi Discs)	OD768R	Combi 551	Low risk	25/08/2016
ASS- Sensitivity Discs (Multi Discs)	OD769	Combi 552	Low risk	25/08/2016
ASS- Sensitivity Discs (Multi Discs)	OD769R	Combi 552	Low risk	25/08/2016
ASS- Sensitivity Discs (Multi Discs)	OD770	Combi 553	Low risk	25/08/2016
ASS- Sensitivity Discs (Multi Discs)	OD770R	Combi 553	Low risk	25/08/2016
ASS- Sensitivity Discs (Multi Discs)	OD771	Combi 554	Low risk	25/08/2016
ASS- Sensitivity Discs (Multi Discs)	OD771R	Combi 554	Low risk	25/08/2016
ASS- Sensitivity Discs (Multi Discs)	OD772	Combi 555	Low risk	16/12/2017
ASS- Sensitivity Discs (Multi Discs)	OD772R	Combi 555	Low risk	16/12/2017
ASS- Sensitivity Discs (Multi Discs)	OD773	Combi 556	Low risk	16/12/2017
ASS- Sensitivity Discs (Multi Discs)	OD773R	Combi 556	Low risk	16/12/2017
ASS- Sensitivity Discs (Multi Discs)	OD774	Combi 557	Low risk	16/12/2017
ASS- Sensitivity Discs (Multi Discs)	OD774R	Combi 557	Low risk	16/12/2017
ASS- Sensitivity Discs (Multi Discs)	OD775	Combi 558	Low risk	16/12/2017
ASS- Sensitivity Discs (Multi Discs)	OD775R	Combi 558	Low risk	16/12/2017
ASS- Sensitivity Discs (Multi Discs)	OD776	Combi 559	Low risk	04/07/2018
ASS- Sensitivity Discs (Multi Discs)	OD776R	Combi 559	Low risk	04/07/2018
ASS- Sensitivity Discs (Multi Discs)	OD777	Combi 560	Low risk	04/07/2018
ASS- Sensitivity Discs (Multi Discs)	OD777R	Combi 560	Low risk	04/07/2018
ASS- Sensitivity Discs (Multi Discs)	OD778	Combi 561	Low risk	04/07/2018
ASS- Sensitivity Discs (Multi Discs)	OD778R	Combi 561	Low risk	04/07/2018
ASS- Sensitivity Discs (Multi Discs)	OD779	Combi 562	Low risk	22/04/2019
ASS- Sensitivity Discs (Multi Discs)	OD779R	Combi 562	Low risk	22/04/2019
ASS- Sensitivity Discs (Multi Discs)	OD780	Combi 563	Low risk	10/11/2020
ASS- Sensitivity Discs (Multi Discs)	OD780R	Combi 563	Low risk	10/11/2020
ASS- Sensitivity Discs (Multi Discs)	OD781	Combi 564	Low risk	10/11/2020
ASS- Sensitivity Discs (Multi Discs)	OD781R	Combi 564	Low risk	10/11/2020
ASS- Sensitivity Discs (Multi Discs)	OD782	Combi 565	Low risk	10/11/2020
ASS- Sensitivity Discs (Multi Discs)	OD782R	Combi 565	Low risk	10/11/2020
ASS- Sensitivity Discs (Multi Discs)	OD783	Combi 566	Low risk	10/11/2020

ASS- Sensitivity Discs (Multi Discs)	OD783R	Combi 566	Low risk	10/11/2020
ASS- Sensitivity Discs (Multi Discs)	OD784	Combi 567	Low risk	10/11/2020
ASS- Sensitivity Discs (Multi Discs)	OD784R	Combi 567	Low risk	10/11/2020
ASS- Sensitivity Discs (Single Discs)	SD001	Amoxycillin	Low risk	20/12/2012
ASS- Sensitivity Discs (Single Discs)	SD002	Ampicillin	Low risk	20/12/2012
ASS- Sensitivity Discs (Single Discs)	SD002A	Ampicillin	Low risk	20/12/2012
ASS- Sensitivity Discs (Single Discs)	SD003	Bacitracin	Low risk	20/12/2012
ASS- Sensitivity Discs (Single Discs)	SD004	Carbenicillin	Low risk	20/12/2012
ASS- Sensitivity Discs (Single Discs)	SD005	Cefaloridine (Cephaloridine)	Low risk	20/12/2012
ASS- Sensitivity Discs (Single Discs)	SD006	Chloramphenicol	Low risk	20/12/2012
ASS- Sensitivity Discs (Single Discs)	SD006B	Chloramphenicol(2 mcg)	Low risk	25/08/2016
ASS- Sensitivity Discs (Single Discs)	SD007	Chlortetracycline	Low risk	20/12/2012
ASS- Sensitivity Discs (Single Discs)	SD008	Cloxacillin	Low risk	20/12/2012
ASS- Sensitivity Discs (Single Discs)	SD009	Colistin (Methane Sulphonate)	Low risk	20/12/2012
ASS- Sensitivity Discs (Single Discs)	SD010	Co-Trimoxazole (Sulpha/Trimethoprim)	Low risk	20/12/2012
ASS- Sensitivity Discs (Single Discs)	SD012	Doxycycline Hydrochloride	Low risk	20/12/2012
ASS- Sensitivity Discs (Single Discs)	SD013	Erythromycin	Low risk	20/12/2012
ASS- Sensitivity Discs (Single Discs)	SD014	Framycetin	Low risk	20/12/2012
ASS- Sensitivity Discs (Single Discs)	SD015	Furazolidone	Low risk	20/12/2012
ASS- Sensitivity Discs (Single Discs)	SD016	Gentamicin	Low risk	20/12/2012
ASS- Sensitivity Discs (Single Discs)	SD017	Kanamycin	Low risk	20/12/2012
ASS- Sensitivity Discs (Single Discs)	SD018	Lincomycin	Low risk	20/12/2012
ASS- Sensitivity Discs (Single Discs)	SD019	Methicillin	Low risk	20/12/2012
ASS- Sensitivity Discs (Single Discs)	SD020	Metronidazole	Low risk	20/12/2012
ASS- Sensitivity Discs (Single Discs)	SD021	Nalidixic Acid	Low risk	20/12/2012
ASS- Sensitivity Discs (Single Discs)	SD022	Neomycin	Low risk	20/12/2012
ASS- Sensitivity Discs (Single Discs)	SD023	Nitrofurantoin	Low risk	20/12/2012
ASS- Sensitivity Discs (Single Discs)	SD023A	Nitrofurantoin	Low risk	25/08/2016
ASS- Sensitivity Discs (Single Discs)	SD024	Nitrofurazone	Low risk	20/12/2012
ASS- Sensitivity Discs (Single Discs)	SD025	Nystatin	Low risk	20/12/2012
ASS- Sensitivity Discs (Single Discs)	SD026	Oleandomycin	Low risk	20/12/2012
ASS- Sensitivity Discs (Single Discs)	SD027	Oxytetracycline	Low risk	20/12/2012
ASS- Sensitivity Discs (Single Discs)	SD028	Penicillin-G	Low risk	20/12/2012
ASS- Sensitivity Discs (Single Discs)	SD029	Polymyxin-B	Low risk	20/12/2012
ASS- Sensitivity Discs (Single Discs)	SD030	Rifampicin	Low risk	20/12/2012
ASS- Sensitivity Discs (Single Discs)	SD031	Streptomycin	Low risk	20/12/2012
ASS- Sensitivity Discs (Single Discs)	SD032	Sulphafurazole (Sulfisoxazole)	Low risk	20/12/2012
ASS- Sensitivity Discs (Single Discs)	SD033	Sulphamethizole	Low risk	20/12/2012
ASS- Sensitivity Discs (Single Discs)	SD034	Sulphadiazine	Low risk	20/12/2012
ASS- Sensitivity Discs (Single Discs)	SD035	Amikacin	Low risk	20/12/2012
ASS- Sensitivity Discs (Single Discs)	SD036	Sulphaphenazole	Low risk	20/12/2012
ASS- Sensitivity Discs (Single Discs)	SD037	Tetracycline	Low risk	20/12/2012
ASS- Sensitivity Discs (Single Discs)	SD038	Triple Sulphas	Low risk	20/12/2012
ASS- Sensitivity Discs (Single Discs)	SD039	Trimethoprim	Low risk	20/12/2012
ASS- Sensitivity Discs (Single Discs)	SD040	Cefotaxime	Low risk	20/12/2012

ASS- Sensitivity Discs (Single Discs)	SD040A	Cefotaxime	Low risk	20/12/2012
ASS- Sensitivity Discs (Single Discs)	SD041	Cefoxitin	Low risk	20/12/2012
ASS- Sensitivity Discs (Single Discs)	SD042	Furoxone	Low risk	20/12/2012
ASS- Sensitivity Discs (Single Discs)	SD043	Oxacillin	Low risk	20/12/2012
ASS- Sensitivity Discs (Single Discs)	SD044	Tobramycin	Low risk	20/12/2012
ASS- Sensitivity Discs (Single Discs)	SD045	Vancomycin	Low risk	20/12/2012
ASS- Sensitivity Discs (Single Discs)	SD046	Netillin	Low risk	20/12/2012
ASS- Sensitivity Discs (Single Discs)	SD047	Cefazolin	Low risk	20/12/2012
ASS- Sensitivity Discs (Single Discs)	SD048	Cefalexin(Cephalexin)	Low risk	20/12/2012
ASS- Sensitivity Discs (Single Discs)	SD049	Cycloserine	Low risk	25/08/2016
ASS- Sensitivity Discs (Single Discs)	SD050	Cephalothin	Low risk	20/12/2012
ASS- Sensitivity Discs (Single Discs)	SD051	Clindamycin	Low risk	20/12/2012
ASS- Sensitivity Discs (Single Discs)	SD052	Dicloxacillin	Low risk	20/12/2012
ASS- Sensitivity Discs (Single Discs)	SD053	Novobiocin	Low risk	20/12/2012
ASS- Sensitivity Discs (Single Discs)	SD054	Spiramycin	Low risk	20/12/2012
ASS- Sensitivity Discs (Single Discs)	SD055	Sulphamethoxypyridazine	Low risk	20/12/2012
ASS- Sensitivity Discs (Single Discs)	SD056	Sulfasomidine	Low risk	20/12/2012
ASS- Sensitivity Discs (Single Discs)	SD056A	Sulphamethoxazole	Low risk	25/08/2016
ASS- Sensitivity Discs (Single Discs)	SD057	Norfloxacin	Low risk	20/12/2012
ASS- Sensitivity Discs (Single Discs)	SD058	Co-Trimazine (Vet.)	Low risk	25/08/2016
ASS- Sensitivity Discs (Single Discs)	SD059	Sisomicin	Low risk	20/12/2012
ASS- Sensitivity Discs (Single Discs)	SD060	Ciprofloxacin	Low risk	20/12/2012
ASS- Sensitivity Discs (Single Discs)	SD060A	Ciprofloxacin	Low risk	20/12/2012
ASS- Sensitivity Discs (Single Discs)	SD061	Cefuroxime	Low risk	20/12/2012
ASS- Sensitivity Discs (Single Discs)	SD062	Ceftazidime	Low risk	20/12/2012
ASS- Sensitivity Discs (Single Discs)	SD062A	Ceftazidime	Low risk	20/12/2012
ASS- Sensitivity Discs (Single Discs)	SD063	Amoxyclav (Amoxicillin/Clavulanic acid)	Low risk	20/12/2012
ASS- Sensitivity Discs (Single Discs)	SD063A	Augmentine	Low risk	25/08/2016
ASS- Sensitivity Discs (Single Discs)	SD064	Azlocillin	Low risk	20/12/2012
ASS- Sensitivity Discs (Single Discs)	SD065	Ceftriaxone	Low risk	20/12/2012
ASS- Sensitivity Discs (Single Discs)	SD066	Piperacillin	Low risk	20/12/2012
ASS- Sensitivity Discs (Single Discs)	SD066A	Piperacillin	Low risk	20/12/2012
ASS- Sensitivity Discs (Single Discs)	SD067	Sterile Discs	Low risk	20/12/2012
ASS- Sensitivity Discs (Single Discs)	SD068	Methanamine Mandalate	Low risk	20/12/2012
ASS- Sensitivity Discs (Single Discs)	SD069	Ofloxacin	Low risk	20/12/2012
ASS- Sensitivity Discs (Single Discs)	SD070	Pefloxacin	Low risk	20/12/2012
ASS- Sensitivity Discs (Single Discs)	SD071	Co-Trimazine (Human)	Low risk	20/12/2012
ASS- Sensitivity Discs (Single Discs)	SD072	Cefoperazone	Low risk	20/12/2012
ASS- Sensitivity Discs (Single Discs)	SD073	Imipenem	Low risk	20/12/2012
ASS- Sensitivity Discs (Single Discs)	SD074	Ticarcillin	Low risk	20/12/2012
ASS- Sensitivity Discs (Single Discs)	SD075	Cloxacillin	Low risk	20/12/2012
ASS- Sensitivity Discs (Single Discs)	SD076	Amoxicillin	Low risk	20/12/2012
ASS- Sensitivity Discs (Single Discs)	SD077	Ampicillin	Low risk	20/12/2012
ASS- Sensitivity Discs (Single Discs)	SD078	Amoxyclav	Low risk	20/12/2012
ASS- Sensitivity Discs (Single Discs)	SD079	Cefaloridine	Low risk	20/12/2012

ASS- Sensitivity Discs (Single Discs)	SD080	Ciprofloxacin	Low risk	20/12/2012
ASS- Sensitivity Discs (Single Discs)	SD081	Chloramphenicol	Low risk	20/12/2012
ASS- Sensitivity Discs (Single Discs)	SD082	Amikacin	Low risk	20/12/2012
ASS- Sensitivity Discs (Single Discs)	SD083	Erythromycin	Low risk	20/12/2012
ASS- Sensitivity Discs (Single Discs)	SD084	Lincomycin	Low risk	20/12/2012
ASS- Sensitivity Discs (Single Discs)	SD085	Netillin	Low risk	20/12/2012
ASS- Sensitivity Discs (Single Discs)	SD086	Nitrofurantoin	Low risk	20/12/2012
ASS- Sensitivity Discs (Single Discs)	SD087	Ofloxacin	Low risk	20/12/2012
ASS- Sensitivity Discs (Single Discs)	SD088	Oxacillin	Low risk	20/12/2012
ASS- Sensitivity Discs (Single Discs)	SD089	Penicillin-G	Low risk	20/12/2012
ASS- Sensitivity Discs (Single Discs)	SD090	Nitrofurantoin	Low risk	20/12/2012
ASS- Sensitivity Discs (Single Discs)	SD091	Streptomycin	Low risk	20/12/2012
ASS- Sensitivity Discs (Single Discs)	SD092	Sulphadiazine	Low risk	20/12/2012
ASS- Sensitivity Discs (Single Discs)	SD093	Trimethoprim	Low risk	20/12/2012
ASS- Sensitivity Discs (Single Discs)	SD094	Azlocillin	Low risk	20/12/2012
ASS- Sensitivity Discs (Single Discs)	SD096	Rifampicin	Low risk	20/12/2012
ASS- Sensitivity Discs (Single Discs)	SD097	Colistin (Methane Sulphonate)	Low risk	20/12/2012
ASS- Sensitivity Discs (Single Discs)	SD098	Lincomycin	Low risk	20/12/2012
ASS- Sensitivity Discs (Single Discs)	SD099	Metronidazole	Low risk	20/12/2012
ASS- Sensitivity Discs (Single Discs)	SD101	Spiramycin	Low risk	20/12/2012
ASS- Sensitivity Discs (Single Discs)	SD102	Penicillin-G (1.5 units)	Low risk	25/08/2016
ASS- Sensitivity Discs (Single Discs)	SD103	Nitrofurantoin NIT	Low risk	25/08/2016
ASS- Sensitivity Discs (Single Discs)	SD104	Neomycin N	Low risk	25/08/2016
ASS- Sensitivity Discs (Single Discs)	SD105	Bacitracin	Low risk	20/12/2012
ASS- Sensitivity Discs (Single Discs)	SD106	Polymyxin-B	Low risk	20/12/2012
ASS- Sensitivity Discs (Single Discs)	SD107	Metronidazole	Low risk	25/08/2016
ASS- Sensitivity Discs (Single Discs)	SD108	Colistin (Methane Sulphonate)	Low risk	20/12/2012
ASS- Sensitivity Discs (Single Discs)	SD109	Ceftriaxone	Low risk	20/12/2012
ASS- Sensitivity Discs (Single Discs)	SD110	Ceftizoxime	Low risk	20/12/2012
ASS- Sensitivity Discs (Single Discs)	SD111	Amphotericin-B	Low risk	20/12/2012
ASS- Sensitivity Discs (Single Discs)	SD112	Ampicillin/Sulbactam	Low risk	20/12/2012
ASS- Sensitivity Discs (Single Discs)	SD113	Ampicillin/Cloxacillin	Low risk	20/12/2012
ASS- Sensitivity Discs (Single Discs)	SD114	Fluconazole	Low risk	20/12/2012
ASS- Sensitivity Discs (Single Discs)	SD115	Clotrimazole	Low risk	20/12/2012
ASS- Sensitivity Discs (Single Discs)	SD116	Cefadroxil (Cephadroxil)	Low risk	20/12/2012
ASS- Sensitivity Discs (Single Discs)	SD117	Bacitracin (0.1 units)	Low risk	25/08/2016
ASS- Sensitivity Discs (Single Discs)	SD118	Bacitracin (2 units)	Low risk	25/08/2016
ASS- Sensitivity Discs (Single Discs)	SD119	Bacitracin (1 unit)	Low risk	25/08/2016
ASS- Sensitivity Discs (Single Discs)	SD120	Doxycycline Hydrochloride	Low risk	20/12/2012
ASS- Sensitivity Discs (Single Discs)	SD121	Novobiocin	Low risk	20/12/2012
ASS- Sensitivity Discs (Single Discs)	SD123	Tetracycline T	Low risk	25/08/2016
ASS- Sensitivity Discs (Single Discs)	SD124	Azithromycin	Low risk	20/12/2012
ASS- Sensitivity Discs (Single Discs)	SD125	Lomefloxacin	Low risk	20/12/2012
ASS- Sensitivity Discs (Single Discs)	SD126	Roxithromycin	Low risk	20/12/2012
ASS- Sensitivity Discs (Single Discs)	SD127	Rifampicin	Low risk	20/12/2012

ASS- Sensitivity Discs (Single Discs)	SD128	Rifampicin	Low risk	20/12/2012
ASS- Sensitivity Discs (Single Discs)	SD129	Amoxicillin	Low risk	20/12/2012
ASS- Sensitivity Discs (Single Discs)	SD130	Cephaloridine	Low risk	25/08/2016
ASS- Sensitivity Discs (Single Discs)	SD131	Chloramphenicol	Low risk	20/12/2012
ASS- Sensitivity Discs (Single Discs)	SD132	Piperacillin	Low risk	20/12/2012
ASS- Sensitivity Discs (Single Discs)	SD133	Tetracycline	Low risk	20/12/2012
ASS- Sensitivity Discs (Single Discs)	SD134	Tobramycin TB	Low risk	25/08/2016
ASS- Sensitivity Discs (Single Discs)	SD135	Trimethoprim	Low risk	25/08/2016
ASS- Sensitivity Discs (Single Discs)	SD136	Methicillin	Low risk	20/12/2012
ASS- Sensitivity Discs (Single Discs)	SD137	Methicillin	Low risk	20/12/2012
ASS- Sensitivity Discs (Single Discs)	SD138	Erythromycin	Low risk	25/08/2016
ASS- Sensitivity Discs (Single Discs)	SD139	Polymyxin-B	Low risk	20/12/2012
ASS- Sensitivity Discs (Single Discs)	SD140	Floxidin	Low risk	20/12/2012
ASS- Sensitivity Discs (Single Discs)	SD141	Floxidin	Low risk	20/12/2012
ASS- Sensitivity Discs (Single Discs)	SD142	Ciprofloxacin	Low risk	20/12/2012
ASS- Sensitivity Discs (Single Discs)	SD143	Cloxacillin	Low risk	20/12/2012
ASS- Sensitivity Discs (Single Discs)	SD144	Penicillin-G	Low risk	20/12/2012
ASS- Sensitivity Discs (Single Discs)	SD145	Penicillin-G	Low risk	25/08/2016
ASS- Sensitivity Discs (Single Discs)	SD147	Tetracycline	Low risk	25/08/2016
ASS- Sensitivity Discs (Single Discs)	SD148	Trimethoprim	Low risk	20/12/2012
ASS- Sensitivity Discs (Single Discs)	SD149	Trimethoprim	Low risk	20/12/2012
ASS- Sensitivity Discs (Single Discs)	SD150	Enrofloxacin	Low risk	20/12/2012
ASS- Sensitivity Discs (Single Discs)	SD152	Penicillin-G	Low risk	25/08/2016
ASS- Sensitivity Discs (Single Discs)	SD153	Chloramphenicol	Low risk	20/12/2012
ASS- Sensitivity Discs (Single Discs)	SD154	Tobramycin	Low risk	20/12/2012
ASS- Sensitivity Discs (Single Discs)	SD156	Enrofloxacin	Low risk	20/12/2012
ASS- Sensitivity Discs (Single Discs)	SD157	Cefaclor	Low risk	20/12/2012
ASS- Sensitivity Discs (Single Discs)	SD158	Minocycline	Low risk	20/12/2012
ASS- Sensitivity Discs (Single Discs)	SD159	Cephadrine	Low risk	25/08/2016
ASS- Sensitivity Discs (Single Discs)	SD160	Cefradine	Low risk	20/12/2012
ASS- Sensitivity Discs (Single Discs)	SD161	Trimethoprim	Low risk	25/08/2016
ASS- Sensitivity Discs (Single Discs)	SD162	Sparfloxacin	Low risk	20/12/2012
ASS- Sensitivity Discs (Single Discs)	SD163	Vancomycin	Low risk	20/12/2012
ASS- Sensitivity Discs (Single Discs)	SD164	Clindamycin	Low risk	20/12/2012
ASS- Sensitivity Discs (Single Discs)	SD165	Cloxacillin	Low risk	20/12/2012
ASS- Sensitivity Discs (Single Discs)	SD166	Gentamicin	Low risk	20/12/2012
ASS- Sensitivity Discs (Single Discs)	SD167	Penicillin-G	Low risk	25/08/2016
ASS- Sensitivity Discs (Single Discs)	SD168	Ceftriaxone Ci	Low risk	25/08/2016
ASS- Sensitivity Discs (Single Discs)	SD169	Fusidic Acid	Low risk	20/12/2012
ASS- Sensitivity Discs (Single Discs)	SD170	Gentamicin	Low risk	20/12/2012
ASS- Sensitivity Discs (Single Discs)	SD171	Fusidic Acid	Low risk	20/12/2012
ASS- Sensitivity Discs (Single Discs)	SD174	Polymyxin-B Pb	Low risk	25/08/2016
ASS- Sensitivity Discs (Single Discs)	SD175	Pipemidic Acid	Low risk	20/12/2012
ASS- Sensitivity Discs (Single Discs)	SD176	Mecillinam	Low risk	20/12/2012
ASS- Sensitivity Discs (Single Discs)	SD177	Mecillinam	Low risk	20/12/2012

ASS- Sensitivity Discs (Single Discs)	SD178	Pristinomycin	Low risk	20/12/2012
ASS- Sensitivity Discs (Single Discs)	SD179	Fosfomycin	Low risk	20/12/2012
ASS- Sensitivity Discs (Single Discs)	SD180	Oxolinic Acid (10 mcg)	Low risk	25/08/2016
ASS- Sensitivity Discs (Single Discs)	SD181	Spectinomycin	Low risk	20/12/2012
ASS- Sensitivity Discs (Single Discs)	SD182	Virginamycin	Low risk	20/12/2012
ASS- Sensitivity Discs (Single Discs)	SD184	Norfloxacin	Low risk	20/12/2012
ASS- Sensitivity Discs (Single Discs)	SD185	Pipemidic Acid	Low risk	20/12/2012
ASS- Sensitivity Discs (Single Discs)	SD186	Oxolinic Acid (2 mcg)	Low risk	25/08/2016
ASS- Sensitivity Discs (Single Discs)	SD187	Flumequine (2 mcg)	Low risk	25/08/2016
ASS- Sensitivity Discs (Single Discs)	SD188	Dibekacine (10 mcg)	Low risk	25/08/2016
ASS- Sensitivity Discs (Single Discs)	SD189	Oxolinic Acid (5 mcg)	Low risk	25/08/2016
ASS- Sensitivity Discs (Single Discs)	SD190	Flumequine (5 mcg)	Low risk	25/08/2016
ASS- Sensitivity Discs (Single Discs)	SD191	Kanamycin (1 mcg) (K1)	Low risk	25/08/2016
ASS- Sensitivity Discs (Single Discs)	SD192	Clarithromycin	Low risk	20/12/2012
ASS- Sensitivity Discs (Single Discs)	SD195	Gentamicin	Low risk	20/12/2012
ASS- Sensitivity Discs (Single Discs)	SD196	Nitroxoline	Low risk	20/12/2012
ASS- Sensitivity Discs (Single Discs)	SD197	Furazolidone	Low risk	20/12/2012
ASS- Sensitivity Discs (Single Discs)	SD198	Flumequine	Low risk	25/08/2016
ASS- Sensitivity Discs (Single Discs)	SD199	Tylosine	Low risk	20/12/2012
ASS- Sensitivity Discs (Single Discs)	SD200	Cefamandole	Low risk	20/12/2012
ASS- Sensitivity Discs (Single Discs)	SD201	Ticarcillin	Low risk	20/12/2012
ASS- Sensitivity Discs (Single Discs)	SD203	Cefoperazone	Low risk	20/12/2012
ASS- Sensitivity Discs (Single Discs)	SD204	Azithromycin	Low risk	20/12/2012
ASS- Sensitivity Discs (Single Discs)	SD205	Fosfomycin	Low risk	20/12/2012
ASS- Sensitivity Discs (Single Discs)	SD206	Lomefloxacin	Low risk	20/12/2012
ASS- Sensitivity Discs (Single Discs)	SD207	Ceftazidime /Clavulanic acid	Low risk	20/12/2012
ASS- Sensitivity Discs (Single Discs)	SD209	Cefprozil	Low risk	20/12/2012
ASS- Sensitivity Discs (Single Discs)	SD210	Piperacillin/Tazobactam	Low risk	20/12/2012
ASS- Sensitivity Discs (Single Discs)	SD211	Cefixime	Low risk	20/12/2012
ASS- Sensitivity Discs (Single Discs)	SD212	Aztreonam	Low risk	20/12/2012
ASS- Sensitivity Discs (Single Discs)	SD213	Teicoplanin	Low risk	20/12/2012
ASS- Sensitivity Discs (Single Discs)	SD214	Isepamicin	Low risk	20/12/2012
ASS- Sensitivity Discs (Single Discs)	SD215	Linezolid	Low risk	20/12/2012
ASS- Sensitivity Discs (Single Discs)	SD216	Levofloxacin	Low risk	20/12/2012
ASS- Sensitivity Discs (Single Discs)	SD217	Moxifloxacin	Low risk	20/12/2012
ASS- Sensitivity Discs (Single Discs)	SD218	Cefdinir	Low risk	20/12/2012
ASS- Sensitivity Discs (Single Discs)	SD219	Cefepime	Low risk	20/12/2012
ASS- Sensitivity Discs (Single Discs)	SD220	Moxalactam	Low risk	20/12/2012
ASS- Sensitivity Discs (Single Discs)	SD221	Itraconazole	Low risk	20/12/2012
ASS- Sensitivity Discs (Single Discs)	SD222	Erythromycin	Low risk	20/12/2012
ASS- Sensitivity Discs (Single Discs)	SD223	Kanamycin	Low risk	20/12/2012
ASS- Sensitivity Discs (Single Discs)	SD224	Ketoconazole	Low risk	20/12/2012
ASS- Sensitivity Discs (Single Discs)	SD225	Mezlocillin	Low risk	20/12/2012
ASS- Sensitivity Discs (Single Discs)	SD231	Cefoperazone :Sulbactam (30mcg:10mcg)	Low risk	25/08/2016
ASS- Sensitivity Discs (Single Discs)	SD232	Fluconazole	Low risk	20/12/2012

ASS- Sensitivity Discs (Single Discs)	SD233	Amphotericin B	Low risk	20/12/2012
ASS- Sensitivity Discs (Single Discs)	SD234	Cefepime	Low risk	20/12/2012
ASS- Sensitivity Discs (Single Discs)	SD235	Cefpirome	Low risk	20/12/2012
ASS- Sensitivity Discs (Single Discs)	SD236	Streptomycin For detection of HLAR Strains.	Low risk	20/12/2012
ASS- Sensitivity Discs (Single Discs)	SD237	Enoxacin	Low risk	20/12/2012
ASS- Sensitivity Discs (Single Discs)	SD238	Kit I for ESBL Identification, Cefotaxime (Cephotaxime) Kit contains 6 cartridges (6CT): 3CT of SD040 Cefotaxime (Cephotaxime) 30 mcg, 3CT of SD724 Cefotaxime (Cephotaxime)/Clavulanic acid 30/10 mcg	Low risk	20/12/2012
ASS- Sensitivity Discs (Single Discs)	SD239	Kit II for ESBL Identification, Cefepime Kit contains 6 cartridges (6CT): 3CT of SD219 Cefepime 30 mcg, 3CT of SD234 Cefepime /Clavulanic acid 30/10 mcg	Low risk	20/12/2012
ASS- Sensitivity Discs (Single Discs)	SD240	Kit III for ESBL Identification, Ceftazidime Kit contains 6 cartridges (6CT): 3CT of SD062 Ceftazidime 30 mcg, 3CT of SD207 Ceftazidime /Clavulanic acid 30/10 mcg	Low risk	20/12/2012
ASS- Sensitivity Discs (Single Discs)	SD241	Kit IV for ESBL Identification, Cefpirome Kit contains 6 cartridges (6CT): 3CT of SD738 Cefpirome 30 mcg, 3CT of SD235 Cefpirome /Clavulanic acid 30/7.5 mcg	Low risk	20/12/2012
ASS- Sensitivity Discs (Single Discs)	SD242	Kit V for ESBL identif	Low risk	25/08/2016
ASS- Sensitivity Discs (Single Discs)	SD243	Amoxyclav (Amoxicillin / Clavulanicacid)	Low risk	25/08/2016
ASS- Sensitivity Discs (Single Discs)	SD244	Cefmetazole	Low risk	20/12/2012
ASS- Sensitivity Discs (Single Discs)	SD245	Cinoxacin	Low risk	20/12/2012
ASS- Sensitivity Discs (Single Discs)	SD246	Nafcillin	Low risk	20/12/2012
ASS- Sensitivity Discs (Single Discs)	SD247	Cefepime/Tazobactam	Low risk	20/12/2012
ASS- Sensitivity Discs (Single Discs)	SD248	Cefonicid	Low risk	20/12/2012
ASS- Sensitivity Discs (Single Discs)	SD249	Cefotetan	Low risk	20/12/2012
ASS- Sensitivity Discs (Single Discs)	SD250	Gemifloxacin	Low risk	20/12/2012
ASS- Sensitivity Discs (Single Discs)	SD251	Ceftriaxone/Tazobactam	Low risk	20/12/2012
ASS- Sensitivity Discs (Single Discs)	SD252	Ceftazidime/Tazobactam	Low risk	20/12/2012
ASS- Sensitivity Discs (Single Discs)	SD253	Cefoperazone/Tazobactam	Low risk	20/12/2012
ASS- Sensitivity Discs (Single Discs)	SD254	Cefoperazone/	Low risk	20/12/2012
ASS- Sensitivity Discs (Single Discs)	SD255	Cefpodoxime/ Clavulanic acid	Low risk	25/08/2016
ASS- Sensitivity Discs (Single Discs)	SD256	Ceftriaxone/Tazobactam	Low risk	20/12/2012
ASS- Sensitivity Discs (Single Discs)	SD257	Cefepime/Tazobactam	Low risk	20/12/2012
ASS- Sensitivity Discs (Single Discs)	SD258	Nadifloxacin	Low risk	20/12/2012
ASS- Sensitivity Discs (Single Discs)	SD259	Cefoperazone/Sulbactam	Low risk	20/12/2012
ASS- Sensitivity Discs (Single Discs)	SD260	Lomefloxacin	Low risk	20/12/2012
ASS- Sensitivity Discs (Single Discs)	SD261	Ceftriaxone/ Sulbactam	Low risk	20/12/2012
ASS- Sensitivity Discs (Single Discs)	SD262	Cefepime	Low risk	20/12/2012
ASS- Sensitivity Discs (Single Discs)	SD263	Aztreonam	Low risk	20/12/2012
ASS- Sensitivity Discs (Single Discs)	SD264	Amoxicillin/	Low risk	20/12/2012
ASS- Sensitivity Discs (Single Discs)	SD265	Imipenem/Cilastin	Low risk	20/12/2012
ASS- Sensitivity Discs (Single Discs)	SD266	Cefixime/	Low risk	20/12/2012
ASS- Sensitivity Discs (Single Discs)	SD267	Prulifloxacin	Low risk	20/12/2012
ASS- Sensitivity Discs (Single Discs)	SD268	Prulifloxacin	Low risk	20/12/2012
ASS- Sensitivity Discs (Single Discs)	SD269	Ceftazidime/Tazobactam	Low risk	20/12/2012
ASS- Sensitivity Discs (Single Discs)	SD270	Amphotericin B	Low risk	20/12/2012
ASS- Sensitivity Discs (Single Discs)	SD271	Nystatin	Low risk	20/12/2012
ASS- Sensitivity Discs (Single Discs)	SD272	Miconazole	Low risk	20/12/2012

ASS- Sensitivity Discs (Single Discs)	SD273	Miconazole	Low risk	20/12/2012
ASS- Sensitivity Discs (Single Discs)	SD274	Ketoconazole	Low risk	20/12/2012
ASS- Sensitivity Discs (Single Discs)	SD275	Ketoconazole	Low risk	20/12/2012
ASS- Sensitivity Discs (Single Discs)	SD276	Itraconazole	Low risk	20/12/2012
ASS- Sensitivity Discs (Single Discs)	SD277	Voriconazole	Low risk	20/12/2012
ASS- Sensitivity Discs (Single Discs)	SD278	Tigecycline	Low risk	20/12/2012
ASS- Sensitivity Discs (Single Discs)	SD279	Faropenem	Low risk	20/12/2012
ASS- Sensitivity Discs (Single Discs)	SD280	Ertapenem	Low risk	20/12/2012
ASS- Sensitivity Discs (Single Discs)	SD281	Amoxyclav	Low risk	20/12/2012
ASS- Sensitivity Discs (Single Discs)	SD282	Imipenem-EDTA	Low risk	20/12/2012
ASS- Sensitivity Discs (Single Discs)	SD283	Doripenem	Low risk	20/12/2012
ASS- Sensitivity Discs (Single Discs)	SD284	Cloxacillin	Low risk	20/12/2012
ASS- Sensitivity Discs (Single Discs)	SD285	Cefoxitin-	Low risk	20/12/2012
ASS- Sensitivity Discs (Single Discs)	SD286	Amoxicillin/Sulbactam	Low risk	25/08/2016
ASS- Sensitivity Discs (Single Discs)	SD287	Ampicillin/Sulbactam	Low risk	25/08/2016
ASS- Sensitivity Discs (Single Discs)	SD288	Cefotaxime CTX	Low risk	25/08/2016
ASS- Sensitivity Discs (Single Discs)	SD288	Cefotaxime CTX	Low risk	25/08/2016
ASS- Sensitivity Discs (Single Discs)	SD289	Ceftriaxone CTR	Low risk	25/08/2016
ASS- Sensitivity Discs (Single Discs)	SD290E	Ceftaroline	Low risk	20/12/2012
ASS- Sensitivity Discs (Single Discs)	SD291E	Telithromycin	Low risk	20/12/2012
ASS- Sensitivity Discs (Single Discs)	SD292E	Piperacillin / Tazobactam	Low risk	20/12/2012
ASS- Sensitivity Discs (Single Discs)	SD293E	Mupirocin	Low risk	20/12/2012
ASS- Sensitivity Discs (Single Discs)	SD294E	Ceftibuten	Low risk	20/12/2012
ASS- Sensitivity Discs (Single Discs)	SD295E	Cefotaxime CTX	Low risk	25/08/2016
ASS- Sensitivity Discs (Single Discs)	SD296E	Linezolid LZ	Low risk	25/08/2016
ASS- Sensitivity Discs (Single Discs)	SD701	Carbenicilline	Low risk	25/08/2016
ASS- Sensitivity Discs (Single Discs)	SD704	Cefradine	Low risk	20/12/2012
ASS- Sensitivity Discs (Single Discs)	SD705	Amoxicillin (2 mcg)	Low risk	25/08/2016
ASS- Sensitivity Discs (Single Discs)	SD709	Novobiocin (5mcg)	Low risk	25/08/2016
ASS- Sensitivity Discs (Single Discs)	SD712	Oleandomycin (5 mcg)	Low risk	25/08/2016
ASS- Sensitivity Discs (Single Discs)	SD715	Fluconazole (25 mcg)	Low risk	25/08/2016
ASS- Sensitivity Discs (Single Discs)	SD722	Penicillin-G (2mcg)	Low risk	25/08/2016
ASS- Sensitivity Discs (Single Discs)	SD723	Ampicillin (20mcg)	Low risk	25/08/2016
ASS- Sensitivity Discs (Single Discs)	SD724	Cefotaxime/Clavulanic acid (30/10 mcg)	Low risk	20/12/2012
ASS- Sensitivity Discs (Single Discs)	SD725	Cefpodoxime	Low risk	20/12/2012
ASS- Sensitivity Discs (Single Discs)	SD726	Ceftazimide/Clavulanic (3/10 mcg)	Low risk	25/08/2016
ASS- Sensitivity Discs (Single Discs)	SD727	Meropenem	Low risk	20/12/2012
ASS- Sensitivity Discs (Single Discs)	SD730	Metronidazole (50 mcg)	Low risk	25/08/2016
ASS- Sensitivity Discs (Single Discs)	SD731	Neomycin	Low risk	20/12/2012
ASS- Sensitivity Discs (Single Discs)	SD732	Novobiocin (5mcg)	Low risk	25/08/2016
ASS- Sensitivity Discs (Single Discs)	SD736	Bacitracin B 0.05 units /disc	Low risk	25/08/2016
ASS- Sensitivity Discs (Single Discs)	SD737	Gatifloxacin	Low risk	20/12/2012
ASS- Sensitivity Discs (Single Discs)	SD738	Cefpirome (Cfp) (30mcg)	Low risk	25/08/2016
ASS- Sensitivity Discs (Single Discs)	SD740	Gatifloxacin	Low risk	20/12/2012
ASS- Sensitivity Discs (Single Discs)	SD741	Cephotaxime/Sulbactam (30/15 mcg)	Low risk	25/08/2016

ASS- Sensitivity Discs (Single Discs)	SD744	Ofloxacin (30mcg)	Low risk	25/08/2016
ASS- Sensitivity Discs (Single Discs)	SD744	Ofloxacin Of 30 mcg	Low risk	25/08/2016
ASS- Sensitivity Discs (Single Discs)	SD745	Norfloxacin (30mcg)	Low risk	25/08/2016
ASS- Sensitivity Discs (Single Discs)	SD746	Gentamicin (200mcg)	Low risk	25/08/2016
ASS- Sensitivity Discs (Single Discs)	SD748	Mupirocin MU 5 mcg	Low risk	25/08/2016
ASS- Sensitivity Discs (Single Discs)	SD751	Cefpodoxime/ Clavulanic acid (10/1 MCG)	Low risk	25/08/2016
ASS- Sensitivity Discs (Single Discs)	SD753	Gatifloxacin	Low risk	20/12/2012
ASS- Sensitivity Discs (Single Discs)	SD755	Ceftiofur (0.2mcg)	Low risk	25/08/2016
ASS- Sensitivity Discs (Single Discs)	SD756	Ceftioxone (30 mcg) / Sulbactam (15 mcg)	Low risk	25/08/2016
ASS- Sensitivity Discs (Single Discs)	SD761	Sparfloxacin Sc (10mcg)	Low risk	25/08/2016
ASS- Sensitivity Discs (Single Discs)	SD764	Ceftriaxone/ Tazobactam (80/10 mcg)	Low risk	25/08/2016
ASS- Sensitivity Discs (Single Discs)	SD765	Gemifloxacin (GEM) 5mcg	Low risk	25/08/2016
ASS- Sensitivity Discs (Single Discs)	SD767	Ceftazidime-Tazobactam (CaT) (30/10 mcg)	Low risk	25/08/2016
ASS- Sensitivity Discs (Single Discs)	SD768	Cefoperazone-tazobactam (75/10mcg)	Low risk	25/08/2016
ASS- Sensitivity Discs (Single Discs)	SD769	Cefoperazone-Sulbactam (Cfs) (75/10 mcg)	Low risk	25/08/2016
ASS- Sensitivity Discs (Single Discs)	SD770	Cefepime/Tazobactam (30/10 mcg)	Low risk	25/08/2016
ASS- Sensitivity Discs (Single Discs)	SD771	Cefpodoxime / Clavulanic acid (10/5 mcg)	Low risk	25/08/2016
ASS- Sensitivity Discs (Single Discs)	SD773	Piperacillin / Sulbactam (100/10 mcg)	Low risk	25/08/2016
ASS- Sensitivity Discs (Single Discs)	SD774	Faropenem (5 mcg)	Low risk	25/08/2016
ASS- Sensitivity Discs (Single Discs)	SD775	Ceftriaxone (30 mcg) / Tazobactam (10 mcg)	Low risk	25/08/2016
ASS- Sensitivity Discs (Single Discs)	SD776	Cefepime (80 mcg) / Tazobactam (10 mcg)	Low risk	25/08/2016
ASS- Sensitivity Discs (Single Discs)	SD777	Nadifloxacin (5 mcg)	Low risk	25/08/2016
ASS- Sensitivity Discs (Single Discs)	SD779	Cefoperazone / Sulbactam (50 / 50 mcg)	Low risk	25/08/2016
ASS- Sensitivity Discs (Single Discs)	SD780	Lomefloxacin Lo (15 mcg)	Low risk	25/08/2016
ASS- Sensitivity Discs (Single Discs)	SD781	Cefixime/Clavulanic acid Cmc (200/125 mcg)	Low risk	25/08/2016
ASS- Sensitivity Discs (Single Discs)	SD782	Cefepime Cpm (50 mcg)	Low risk	25/08/2016
ASS- Sensitivity Discs (Single Discs)	SD783	Aztreonam Ao (50 mcg)	Low risk	25/08/2016
ASS- Sensitivity Discs (Single Discs)	SD784	Amoxicillin/Sulbactam Ams (30/15 mcg)	Low risk	25/08/2016
ASS- Sensitivity Discs (Single Discs)	SD785	Imipenem/Cilastatin Ic (10/10 mcg)	Low risk	25/08/2016
ASS- Sensitivity Discs (Single Discs)	SD786	Cefixime / Clavulanic acid Cmc (5/10 mcg)	Low risk	25/08/2016
ASS- Sensitivity Discs (Single Discs)	SD787	Prulifloxacin Pr (10 mcg)	Low risk	25/08/2016
ASS- Sensitivity Discs (Single Discs)	SD788	Prulifloxacin Pr (5 mcg)	Low risk	25/08/2016
ASS- Sensitivity Discs (Single Discs)	SD789	Ceftriaxone / Sulbactam (500/250 mcg)	Low risk	25/08/2016
ASS- Sensitivity Discs (Single Discs)	SD790	Ceftriaxone / Sulbactam (1000/500 mcg)	Low risk	25/08/2016
ASS- Sensitivity Discs (Single Discs)	SD791	Piperacillin + Tazobactam (80:10 mcg)	Low risk	25/08/2016
ASS- Sensitivity Discs (Single Discs)	SD792	Pazufloxacin (PZ) (25 mcg)	Low risk	25/08/2016
ASS- Sensitivity Discs (Single Discs)	SD793	Cefditoren (10 mcg)	Low risk	25/08/2016
ASS- Sensitivity Discs (Single Discs)	SD794	Cefpodoxime/Clavulanic acid (10/6.25mcg)	Low risk	25/08/2016
ASS- Sensitivity Discs (Single Discs)	SD795	Cefipime / Amikacin (30 / 7.5 mcg)	Low risk	25/08/2016
ASS- Sensitivity Discs (Single Discs)	SD796	Cefepime / Sulbactam (30/15 mcg) CPS	Low risk	25/08/2016
ASS- Sensitivity Discs (Single Discs)	SD797	Ceftazidime / Sulbactam (30/15 mcg) CAS	Low risk	25/08/2016
ASS- Sensitivity Discs (Single Discs)	SD798	Ceftriaxone/Tobramycin (30/5.4 mcg) CTB	Low risk	25/08/2016
ASS- Sensitivity Discs (Single Discs)	SD799	Ceftriaxone/Vancomycin (30/15 mcg) CVA	Low risk	25/08/2016
ASS- Sensitivity Discs (Single Discs)	SD800	Cefpirome / Sulbactam (30/15 mcg) CRS	Low risk	25/08/2016
ASS- Sensitivity Discs (Single Discs)	SD801	Cefaperazone / Sulbactam (70 / 35 mcg) C	Low risk	25/08/2016

ASS- Sensitivity Discs (Single Discs)	SD801	Cefaperazone/Sulbactam (70/35mcg)(CSB)	Low risk	25/08/2016
ASS- Sensitivity Discs (Single Discs)	SD802	Ceftazidime Tobramycin (30+3.6 mcg) CFT	Low risk	25/08/2016
ASS- Sensitivity Discs (Single Discs)	SD803	Amoxicillin/Clavulanic acid AC 50/10 mcg	Low risk	25/08/2016
ASS- Sensitivity Discs (Single Discs)	SD804	Cefpodoxime / Clavulanic acid (24:15mcg)	Low risk	25/08/2016
ASS- Sensitivity Discs (Single Discs)	SD805	Cefixime : Ofloxacin COF 5:5 mcg	Low risk	25/08/2016
ASS- Sensitivity Discs (Single Discs)	SD806	Balofloxacin BF 5 mcg	Low risk	25/08/2016
ASS- Sensitivity Discs (Single Discs)	SD807	Tigecycline TGC 20 mcg	Low risk	25/08/2016
ASS- Sensitivity Discs (Single Discs)	SD808	Ampicillin / Cloxacillin 128/128µg Ax	Low risk	25/08/2016
ASS- Sensitivity Discs (Single Discs)	SD809	Amoxicillin/Cloxacillin 128/128µg ACX	Low risk	25/08/2016
ASS- Sensitivity Discs (Single Discs)	SD810	Gentamicin GEN 128µg	Low risk	25/08/2016
ASS- Sensitivity Discs (Single Discs)	SD811	Enrofloxacin EX 8µg	Low risk	25/08/2016
ASS- Sensitivity Discs (Single Discs)	SD812	Ciprofloxacin CIP 8µg	Low risk	25/08/2016
ASS- Sensitivity Discs (Single Discs)	SD813	Tetracyclin TE 128µg	Low risk	25/08/2016
ASS- Sensitivity Discs (Single Discs)	SD814	Chloramphenicol C 8 mcg	Low risk	25/08/2016
ASS- Sensitivity Discs (Single Discs)	SD815	Streptomycin/Penicillin SPN 128/128mcg	Low risk	25/08/2016
ASS- Sensitivity Discs (Single Discs)	SD816	Ceftazidime/Tobramycin CFT 30/10mcg	Low risk	25/08/2016
ASS- Sensitivity Discs (Single Discs)	SD816V	Ceftazidime/Tobramycin CFT (30:10)	Low risk	25/08/2016
ASS- Sensitivity Discs (Single Discs)	SD816V	Ceftazidime :Tobramycin	Low risk	25/08/2016
ASS- Sensitivity Discs (Single Discs)	SD817	Cefepime / Amikacin CPA 30/10mcg	Low risk	25/08/2016
ASS- Sensitivity Discs (Single Discs)	SD818	Balofloxacin BF 10mcg	Low risk	25/08/2016
ASS- Sensitivity Discs (Single Discs)	SD819	Oxacillin Ox 10mcg	Low risk	25/08/2016
ASS- Sensitivity Discs (Single Discs)	SD820	Cefixime	Low risk	20/12/2012
ASS- Sensitivity Discs (Single Discs)	SD821	Cefpodoxim CPD 30mcg	Low risk	25/08/2016
ASS- Sensitivity Discs (Single Discs)	SD822	Garenoxacin GRN 5 mcg	Low risk	25/08/2016
ASS- Sensitivity Discs (Single Discs)	SD823	Sitafoxacin STX 5 mcg	Low risk	25/08/2016
ASS- Sensitivity Discs (Single Discs)	SD824	Tosufloxacin TOS 5 mcg	Low risk	25/08/2016
ASS- Sensitivity Discs (Single Discs)	SD825	Biapenem BPM 10 mcg	Low risk	25/08/2016
ASS- Sensitivity Discs (Single Discs)	SD826	Cefepime Amikacin 58.8:14.6.mcg CPA	Low risk	25/08/2016
ASS- Sensitivity Discs (Single Discs)	SD827	Florfenicol FLO 30mcg	Low risk	25/08/2016
ASS- Sensitivity Discs (Single Discs)	SD828	Cefpodoxime:Levofloxacin 10:5 mcg	Low risk	25/08/2016
ASS- Sensitivity Discs (Single Discs)	SD829	Meropenem/Sulbactam MRS 10:5 mcg	Low risk	25/08/2016
ASS- Sensitivity Discs (Single Discs)	SD830V	Ceftriazone Vancomycin CVA (30:30)	Low risk	25/08/2016
ASS- Sensitivity Discs (Single Discs)	SD831	Ampicillin/Sulbactam (A/S) 20:10	Low risk	25/08/2016
ASS- Sensitivity Discs (Single Discs)	SD832	Cefixime : Azithromycin CFA 5:15 mcg	Low risk	25/08/2016
ASS- Sensitivity Discs (Single Discs)	SD833	Cefquinome CEQ 30mcg	Low risk	25/08/2016
ASS- Sensitivity Discs (Single Discs)	SD834	Ceftriaxone CTR 128 mcg	Low risk	25/08/2016
ASS- Sensitivity Discs (Single Discs)	SD835	Sulphatrimethoprim STM 128/128 mcg	Low risk	25/08/2016
ASS- Sensitivity Discs (Single Discs)	SD836	Erythromycin E 60 mcg	Low risk	25/08/2016
ASS- Sensitivity Discs (Single Discs)	SD837	Kanmycin K 1000 mcg	Low risk	25/08/2016
ASS- Sensitivity Discs (Single Discs)	SD837	Kanmycin K 1000 mcg	Low risk	20/12/2012
ASS- Sensitivity Discs (Single Discs)	SD838	Quninupristin/Dalfopristin RP 15/15 mcg	Low risk	25/08/2016
ASS- Sensitivity Discs (Single Discs)	SD839	Levofloxacin/Cefpodoxime LEC 250 : 200 mcg	Low risk	25/08/2016
ASS- Sensitivity Discs (Single Discs)	SD840	Ampicillin/Sulbactam A/S 20/12.5 mcg	Low risk	25/08/2016
ASS- Sensitivity Discs (Single Discs)	SD841	Garenoxacin GRN 1mcg	Low risk	25/08/2016
ASS- Sensitivity Discs (Single Discs)	SD842	Garenoxacin GRN 5mcg	Low risk	25/08/2016

ASS- Sensitivity Discs (Single Discs)	SD843	Mipenem (Meropenem) MIP 10 mcg	Low risk	25/08/2016
ASS- Sensitivity Discs (Single Discs)	SD844	Ranicef (Cefdinir) RNF 5 mcg	Low risk	25/08/2016
ASS- Sensitivity Discs (Single Discs)	SD845	Clavamox (Amoxycillin / Clavulanic acid)	Low risk	25/08/2016
ASS- Sensitivity Discs (Single Discs)	SD846	Ciprotab (Ciprofloxacin) CPT 5 mcg	Low risk	25/08/2016
ASS- Sensitivity Discs (Single Discs)	SD847	Ciprotab (Ciprofloxacin) CPT 10mcg	Low risk	25/08/2016
ASS- Sensitivity Discs (Single Discs)	SD848	Meropenem/Sulbactam MRS 2/200mcg	Low risk	25/08/2016
ASS- Sensitivity Discs (Single Discs)	SD849	Flucloxacillin FCO 30mcg	Low risk	25/08/2016
ASS- Sensitivity Discs (Single Discs)	SD850	Cefuroxime/Clavulanic acid CCV 30/7.5mcg	Low risk	28/04/2017
ASS- Sensitivity Discs (Single Discs)	SD851	Cefixime/Dicloxacillin CDC 5/12.5mcg	Low risk	28/04/2017
ASS- Sensitivity Discs (Single Discs)	SD852	Cefpodoxime / Clavulanic acid CCL 10/5mcg	Low risk	16/12/2017
ASS- Sensitivity Discs (Single Discs)	SD853	Nafithromycin NFT 15mcg	Low risk	30/10/2018
ASS- Sensitivity Discs (Single Discs)	SD854	Levonadifloxacin LND 10mcg	Low risk	30/10/2018
ASS- Sensitivity Discs (Single Discs)	SD855	Dicrysticin-S DCR 50mcg	Low risk	22/04/2019
ASS- Sensitivity Discs (Single Discs)	SD856	Garenoxacin GRN 10mcg	Low risk	22/04/2019
ASS- Sensitivity Discs (Single Discs)	SD857	Cefepime / sulbactam	Low risk	10/11/2020
ASS- Sensitivity Discs (Single Discs)	SD858	Cefotaxime / Sulbactam	Low risk	10/11/2020
ASS- Sensitivity Discs (Single Discs)	SD859	Ceftizoxime / Sulbactam	Low risk	10/11/2020
ASS- Sensitivity Discs (Single Discs)	SD860	Meropenem / EDTA	Low risk	10/11/2020
ASS-HiComb™ MIC Strip, Modified	MDM001	Amikacin HiComb™ MIC Strip, Modified	Low risk	10/11/2020
ASS-HiComb™ MIC Strip, Modified	MDM002	Amoxicillin HiComb™ MIC Strip, Modified	Low risk	10/11/2020
ASS-HiComb™ MIC Strip, Modified	MDM003	Amoxyclav HiComb™ MIC Strip, Modified	Low risk	10/11/2020
ASS-HiComb™ MIC Strip, Modified	MDM068	Ampicillin HiComb™ MIC Strip, Modified	Low risk	10/11/2020
ASS-HiComb™ MIC Strip, Modified	MDM109	Ampicillin /Sulbactam HiComb™ MIC Strip, Modified	Low risk	10/11/2020
ASS-HiComb™ MIC Strip, Modified	MDM070	Cefepime HiComb™ MIC Strip, Modified	Low risk	10/11/2020
ASS-HiComb™ MIC Strip, Modified	MDM064	Cefotaxime HiComb™ MIC Strip, Modified	Low risk	10/11/2020
ASS-HiComb™ MIC Strip, Modified	MDM101	Cefoxitin HiComb™ MIC Strip, Modified	Low risk	10/11/2020
ASS-HiComb™ MIC Strip, Modified	MDM012	Ceftazidime HiComb™ MIC Strip, Modified	Low risk	10/11/2020
ASS-HiComb™ MIC Strip, Modified	MDM066	Ceftriaxone HiComb™ MIC Strip, Modified	Low risk	10/11/2020
ASS-HiComb™ MIC Strip, Modified	MDM016	Chloramphenicol HiComb™ MIC Strip, Modified	Low risk	10/11/2020
ASS-HiComb™ MIC Strip, Modified	MDM017	Ciprofloxacin HiComb™ MIC Strip, Modified	Low risk	10/11/2020
ASS-HiComb™ MIC Strip, Modified	MDM020	Colistin HiComb™ MIC Strip, Modified	Low risk	10/11/2020
ASS-HiComb™ MIC Strip, Modified	MDM108	Fosfmycin HiComb™ MIC Strip, Modified	Low risk	10/11/2020
ASS-HiComb™ MIC Strip, Modified	MDM025	Gentamicin HiComb™ MIC Strip, Modified	Low risk	10/11/2020
ASS-HiComb™ MIC Strip, Modified	MDM080	Meropenem HiComb™ MIC Strip, Modified	Low risk	10/11/2020
ASS-HiComb™ MIC Strip, Modified	MDM065	Oxacillin HiComb™ MIC Strip, Modified	Low risk	10/11/2020
ASS-HiComb™ MIC Strip, Modified	MDM084	Penicillin HiComb™ MIC Strip, Modified	Low risk	10/11/2020
ASS-HiComb™ MIC Strip, Modified	MDM043	Polymyxin B HiComb™ MIC Strip, Modified	Low risk	10/11/2020
ASS-HiComb™ MIC Strip, Modified	MDM055	Teicoplanin HiComb™ MIC Strip, Modified	Low risk	10/11/2020

ASS-HiComb™ MIC Strip, Modified	MDM056	Tetracycline HiComb™ MIC Strip, Modified	Low risk	10/11/2020
ASS-HiComb™ MIC Strip, Modified	MDM089	Tigecycline HiComb™ MIC Strip, Modified	Low risk	10/11/2020
ASS-HiComb™ MIC Strip, Modified	MDM059	Trimethoprim HiComb™ MIC Strip, Modified	Low risk	10/11/2020
ASS-HiComb™ MIC Strip, Modified	MDM060	Vancomycin HiComb™ MIC Strip, Modified	Low risk	10/11/2020
ASS-HiComb™ MIC Strip, Modified	MDM071	Amphotericin B HiComb™ MIC Strip, Modified	Low risk	10/11/2020
ASS-HiComb™ MIC Strip, Modified	MDM072	Fluconazole HiComb™ MIC Strip, Modified	Low risk	10/11/2020
ASS-HiComb™ MIC Strip, Modified	MDM086	Voriconazole HiComb™ MIC Strip, Modified	Low risk	10/11/2020
ASS-HiMIC™ Plate Kit	MPK001	Amikacin HiMIC™ Plate Kit (contains HMP001,LQ314II,PW1378,R-MPK001)	Low risk	10/11/2020
ASS-HiMIC™ Plate Kit	MPK068	Ampicillin HiMIC™ Plate Kit (contains HMP068,LQ314II,PW1378,R-MPK068)	Low risk	10/11/2020
ASS-HiMIC™ Plate Kit	MPK109	Ampicillin/Sulbactam HiMIC™ Plate Kit (contains HMP109,LQ314II,PW1378,R-MPK109)	Low risk	10/11/2020
ASS-HiMIC™ Plate Kit	MPK070	Cefepime HiMIC™ Plate Kit (contains HMP070,LQ314I,PW1378,R-MPK070)	Low risk	10/11/2020
ASS-HiMIC™ Plate Kit	MPK101	Cefoxitin HiMIC™ Plate Kit (contains HMP101,LQ314II,PW1378,R-MPK101)	Low risk	10/11/2020
ASS-HiMIC™ Plate Kit	MPK012	Ceftazidime HiMIC™ Plate Kit (contains HMP012,LQ314II,PW1378,R-MPK012)	Low risk	10/11/2020
ASS-HiMIC™ Plate Kit	MPK016	Chloramphenicol HiMIC™ Plate Kit (contains HMP016,LQ314II,PW1378,R-MPK016)	Low risk	10/11/2020
ASS-HiMIC™ Plate Kit	MPK017	Ciprofloxacin HiMIC™ Plate Kit (contains HMP017,LQ314II,PW1378,R-MPK017)	Low risk	10/11/2020
ASS-HiMIC™ Plate Kit	MPK019	Clindamycin HiMIC™ Plate Kit (contains HMP019,LQ314II,PW1378,R-MPK019)	Low risk	10/11/2020
ASS-HiMIC™ Plate Kit	MPK020	Colistin HiMIC™ Plate Kit (contains HMP020,LQ314II,PW1378,R-MPK020)	Low risk	10/11/2020
ASS-HiMIC™ Plate Kit	MPK085	Ertapenem HiMIC™ Plate Kit (contains HMP085,LQ314II,PW1378,R-MPK085)	Low risk	10/11/2020
ASS-HiMIC™ Plate Kit	MPK025	Gentamicin HiMIC™ Plate Kit (contains HMP025,LQ314II,PW1378,R-MPK025)	Low risk	10/11/2020
ASS-HiMIC™ Plate Kit	MPK104	Imipenem HiMIC™ Plate Kit (contains HMP104,LQ314II,PW1378,R-MPK104)	Low risk	10/11/2020
ASS-HiMIC™ Plate Kit	MPK080	Meropenem HiMIC™ Plate Kit (contains HMP080,LQ314I,PW1378,R-MPK080)	Low risk	10/11/2020
ASS-HiMIC™ Plate Kit	MPK084	Penicillin HiMIC™ Plate Kit (contains HMP084,LQ314II,PW1378,R-MPK084)	Low risk	10/11/2020
ASS-HiMIC™ Plate Kit	MPK042	Piperacillin/Tazobactam HiMIC™ Plate Kit (contains HMP042,LQ314I,PW1378,R-MPK042)	Low risk	10/11/2020
ASS-HiMIC™ Plate Kit	MPK043	Polymyxin B HiMIC™ Plate Kit (contains HMP043,LQ314II,PW1378,R-MPK043)	Low risk	10/11/2020



Declaration of Conformity
Microbiology Products

Document ref.: DoC 2020 vs. 13

Page 99 of 99

ASS-HiMIC™ Plate Kit	MPK055	Teicoplanin HiMIC™ Plate Kit (contains HMP055,LQ314II,PW1378,R-MPK055)	Low risk	10/11/2020
ASS-HiMIC™ Plate Kit	MPK089	Tigecycline HiMIC™ Plate Kit (contains HMP089,LQ314II,PW1378,R-MPK089)	Low risk	10/11/2020
ASS-HiMIC™ Plate Kit	MPK060	Vancomycin HiMIC™ Plate Kit (contains HMP060,LQ314II,PW1378,R-MPK060)	Low risk	10/11/2020



THE INTERNATIONAL CERTIFICATION NETWORK

CERTIFICATE

Quality Austria

has issued an IQNet recognized certificate that the organization:

HiMedia Laboratories Pvt. Ltd.

**Plot NO. C40, ROAD - 21Y, WAGLE INDUSTRIAL ESTATE,
THANE (WEST) - 400604 MAHARASHTRA, INDIA**

for the following scope:

**Design, Development & Testing of Microbiology, Animal Cell Culture,
Plant Tissue Culture & Molecular Biology products**

EAC: 34

has implemented and maintains a

QUALITY MANAGEMENT SYSTEM

which fulfils the requirements of the following standard

ISO 9001:2015

This attestation is directly linked to the IQNet Partner's original certificate and shall not be used as a stand-alone document

Issued on:	2022-02-28
Validity date:	2025-02-27
Quality Austria certified since:	2022-02-28

Registration Number: AT-27302/0

Alex Stoichitoiu
President of IQNet

Mag. Friedrich Khuen-Belasi
Authorised Representative
of Quality Austria



IQNet Partners*:

AENOR Spain AFNOR Certification France APCER Portugal CCC Cyprus CISQ Italy
CQC China CQM China CQS Czech Republic Cro Cert Croatia DQS Holding GmbH Germany EAGLE Certification Group USA
FCAV Brazil FONDONORMA Venezuela ICONTEC Colombia Inspecta Sertifointi Oy Finland INTECO Costa Rica
IRAM Argentina JQA Japan KFQ Korea MIRTEC Greece MSZT Hungary Nemko AS Norway NSAI Ireland
NYCE-SIGE México PCBC Poland Quality Austria Austria RR Russia SII Israel SIQ Slovenia
SIRIM QAS International Malaysia SQS Switzerland SRAC Romania TEST St Petersburg Russia TSE Turkey YUQS Serbia

* The list of IQNet partners is valid at the time of issue of this certificate. Updated information is available under www.iqnet-certification.com



THE INTERNATIONAL CERTIFICATION NETWORK

CERTIFICATE

Quality Austria
has issued an IQNet recognized certificate that the organization:

HiMedia Laboratories Pvt. Ltd.
Plot NO. C40, ROAD - 21Y, WAGLE INDUSTRIAL ESTATE,
THANE (WEST) - 400604 MAHARASHTRA, INDIA

for the following scope:

Design, Development & Testing of Biosciences Products for application in Microbiology,
Animal Cell Culture & Molecular Biology products

EAC: 34

has implemented and maintains a

QUALITY MANAGEMENT SYSTEM

which fulfils the requirements of the following standard

ISO 13485:2016

This attestation is directly linked to the IQNet Partner's original certificate and shall not be used as a stand-alone document

Issued on: 2022-02-28
Validity date: 2025-02-27
Quality Austria certified since: 2022-02-28

Registration Number: AT-00391/0

Alex Stoichitoiu
President of IQNet

Mag. Friedrich Khuen-Belasi
Authorised Representative
of Quality Austria



qualityaustria
Succeed with Quality



IQNet Partners*:

AENOR Spain AFNOR Certification France APCER Portugal CCC Cyprus CISQ Italy
CQC China CQM China CQS Czech Republic Cro Cert Croatia DQS Holding GmbH Germany EAGLE Certification Group USA
FCAV Brazil FONDONORMA Venezuela ICONTEC Colombia Inspecta Sertifiointi Oy Finland INTECO Costa Rica
IRAM Argentina JQA Japan KFQ Korea MIRTEC Greece MSZT Hungary Nemko AS Norway NSAI Ireland
NYCE-SIGE México PCBC Poland Quality Austria Austria RR Russia SII Israel SIQ Slovenia
SIRIM QAS International Malaysia SQS Switzerland SRAC Romania TEST St Petersburg Russia TSE Turkey YUQS Serbia

* The list of IQNet partners is valid at the time of issue of this certificate. Updated information is available under www.iqnet-certification.com



CERTIFICATE

Quality Austria Central Asia Private Limited
(A Division of Peacock Global Company)
Awards this Certificate to

This Certificate confirms the application
and further development of an effective

WHO GMP Compliance Verification

Complying with the requirement of

WHO GMP Guidelines



HiMedia Laboratories Private Limited

Unit I : B/4-6, MIDC, Palkhed, Dindori, Nashik-422 202,
Maharashtra, India.
Unit II : W-239(B), MIDC Phase II, Shivaji Udyog Nagar,
Dombivli, District Thane – 421 204, Maharashtra, India.
Unit III : K-45 Addl Ambernath MIDC Anand Nagar East,
District Thane – 421506, Maharashtra, India.

Report No.:2020/QACA/002
Issue Date: 07/01/2020
Expiry Date: 06/01/2023

Unit I : Manufacture & supply of biosciences products for applications in microbiology
(includes dehydrated culture media, culture media bases, antimicrobial susceptibility
systems & bacteriological differentiation aids), animal cell culture, plant tissue culture
and molecular biology.

Unit II : Manufacture and supply of sterile ready prepared media.

Unit III : Manufacture and supply of sterile ready prepared media.

The validity of this Certificate will be maintained via annual surveillance audits
and one renewal audit after three years.



qualityaustria
central asia
Succeed with Quality

India: 07 January 2020

Quality Austria Certification Private Limited (A division of Peacock Global company)

The Product
and Systems
Liability rests
with the
manufacturer
and under no
circumstances
Quality
Austria
Central Asia
Shall be Held
Responsible



The current validity of the certificate is documented exclusively on the Internet under
www.qualityaustriacentralasia.com

Sanjeev Tiwari
(GM- Strategic Business C&T)