



Pressure Vessels Catalogue
Basınçlı Kaplar Katalođu



GBS[®]

Pressure Vessels CO
Basınçlı Kaplar A.Ş.

www.guvenbombe.com.tr



GBS is a manufacturer of dished heads, compressed air tanks, pressure vessels such as small and large propane storage tanks, autogas filling tanks, transportation tanks and refrigeration tanks in Istanbul.

For metal forming and dished head business GBS's start-up dates back to 1945, for pressure vessels production back to 2000.

We manufacture the products in our new production plant equipped with new machines.

Our staff is good trained and highly experienced in steel forming and pressure vessel sector.

Our modern CAD/CAM design and relevant tools have a main role in our production and quality process.

Optimised manufacturing and welding equipment and skills of our qualified staff provide our manufacture of highest standard.

With the confidence of experience, knowledge and customer satisfaction in domestic market; GBS has been exporting its products to several countries.

All GBS products are produced in accordance with approved procedures and regulations.

Our quality management system guarantees constant quality level and safety of our products in later use. We are certified according to EN ISO 9001:2000, AD 2000 HP0 and W0, which documents our high quality standards.

Bemmak is our reputable pressure vessel tanks manufacturing trademark in domestic market of Turkey.

GBS İstanbul'da yerleşik; bombeler, basınçlı hava tankları çeşitli LPG depolama tankları, otopaz depolama tankları ve soğutucu gaz tankları üreten bir firmadır.

Firmanın üretim tecrübesi; bombede 1945'e, basınçlı tank üretiminde ise 2000 yılına kadar gitmektedir.

Yeni fabrikamızda yenilenmiş makine parkımızla, metal şekillendirme ve basınçlı kap konusunda iyi eğitilmiş ve çok deneyimli çalışanlarımızla üretime devam etmekteyiz.

CAD/CAM destekli tasarım ve ekipmanlar üretim ve kalite proseslerimizde önemli role sahiptir.

Optimize edilmiş üretim hattımız ve kaynak ekipmanlarımız; yetenekli personelimizin üretim kalitesini en üst seviyede tutmasını sağlamaktadır.

Yurtiçi pazarlardaki deneyim, bilgi birikimi ve müşteri memnuniyetinin verdiği güvenle GBS çeşitli ülkelere ihracatına devam etmektedir.

Tüm GBS ürünleri onaylanmış prosedür ve regülasyonlara göre üretilmektedir.

Kalite yönetim sistemimiz ürünlerimizin satış sonrası güvenle kullanımını garanti etmektedir. Ayrıca ISO 9001:2000 ve AD 2000 HP0 ve W0 sertifikalarımız yüksek kalite seviyemizi belgelemektedir.

BEMMAK Kazan ve Makine Sanayi, firmamızın yurtiçindeki saygın basınçlı kap imalatı markasıdır.

a) Dished Heads

For detail please see "GBS Dished Heads Catalogue"

b) Compressed Air Tanks

Our product range covers tank sizes with volumes from 100 liters to 20.000 liters with pressure ratings from 8 to 40 bar; in vertical or horizontal.

Tanks are manufactured according to EN13445, AD 2000, EN286 and ASME sec VIII div 1 standards, are certified under Directive 97/23/EC and CE marked.

c) LPG Storage Tanks

We, as GBS, manufacture tanks for safe storage of propane/ butane in aboveground and underground types, with capacities from 500 liters to 250.000 liters.

Tanks are manufactured according to AD-2000 (German Standard), EN 13445 or ASME sec VIII, div 1 are certified Directive 97/23/EC and CE marked.

Capacities : 500-250.000 liters
Outer diameters :
800/1000/1200/1600/1900/2500/3000/3300mm
Operating pressure : 17,16bar
Test pressure : 24,54bar
Operating temperature : -20/+50C
Manufacturing standard :
AD-2000, EN13445 or ASME sec VIII div 1
Regulation : European Pressure Directive 97/23/EC

Head type : Elipsoidal
Material quality : P355GH/NH or S355J2+N
Surface finish : Sand blasted and painted
Valves : REGO/SRG/CAVAGNA

d) Autogas Tanks

We manufacture autogas filling tanks in aboveground and underground versions, with capacities of 5,7,10 and 22m³.

Capacities : 5/7/10/22m³
Outer diameters :
1200 /1600/1900/2350mm
Operating pressure : 17,16bar
Test pressure : 24,54bar
Operating temperature : -20/+50C
Manufacturing standard :
AD-2000, EN13445 or ASME sec VIII div 1
Regulation : European Pressure Directive 97/23/EC

Head type : Elipsoidal
Material quality : P355GH/NH or S355J2+N
Surface finish : Sand blasted and painted
Valves : REGO/SRG/CAVAGNA

e) Other Vessels/Special Vessels

According to customer request we also manufacture special vessels such as nitrogen gas tanks, refrigerant gas tanks and process gas tanks...

GBS reserves the copyrights to change any information included in this document.
GBS is not responsible about printing mistakes.

a) Bombeler

Detay bilgi için lütfen GBS Bombe Kataloğuna bakınız.

b) Basınçlı Hava Tankları

Standart ürün çeşitlerimiz yatay veya dikey olmak üzere 100-20.000 litre hacim ve 8-40 bar basınç aralığındadır.

Üretimimiz EN 13445, AD 2000, EN 286 ve ASME sec VIII div 1 e göre yapılmakta olup ilgili Avrupa Direktifi olan 97/23/EC ye uygun ve CE belgelidir.

c) LPG Depolama Tankları

GBS olarak 500-250.000 litre hacim aralığında yer altı veya yerüstü olmak üzere LPG depolama tankları üretmekteyiz.

Tanklar EN 13445, AD 2000 ve ASME üretim standartlarına göre Avrupa Direktifi 97/23/EC ye uygun ve CE li üretilmektedir.

Hacimler : 500-250.000 litre
Dışçap ölçüleri :
800/1000/1200/1600/1900/2500/3000/3300mm
İşletme basıncı : 17,16bar
Test basıncı : 24,54bar
İşletme sıcaklığı : -20/+50C
Üretim standardı :
AD-2000, EN13445 veya ASME sec VIII div 1
Regülasyon : European Pressure Directive 97/23/EC

Bombe tipi : Eliptik
Malzeme kalitesi : P355GH/NH veya S355J2+N
Yüzey işlemi : Kumlanmış ve boyanmış
Valfler : REGO/SRG/CAVAGNA

d) Otogaz Tankları

Yer altı ve yerüstü olmak üzere ve 5,7,10 ve 22m³ hacimlerinde otogaz depolama tankları üretiyoruz.

Hacimler : 5/7/10/22m³
Dışçap ölçüleri :
1200 /1600/1900/2350mm
İşletme basıncı : 17,16bar
Test basıncı : 24,54bar
İşletme sıcaklığı : -20/+50C
Üretim standardı :
AD-2000, EN13445 veya ASME sec VIII div 1
Regülasyon : European Pressure Directive 97/23/EC

Bombe tipi : Eliptik
Malzeme kalitesi : P355GH/NH veya S355J2+N
Yüzey işlemi : Kumlanmış ve boyanmış
Valfler : REGO/SRG/CAVAGNA

e) Özel Tip Basınçlı Kaplar

Müşteri talepleri doğrultusunda azot, amonyak ve soğutucu gaz depolama tankları da üretilebilmektedir.

GBS bu kataloğun içeriklerinde değişiklik yapma hakkına sahiptir. Her Hakkı Saklıdır.
GBS bu katalogdaki baskı hatalarından sorumlu tutulamaz.





Pressure Air Tank - Horizontal Yatay Hava Tankı



TECHNICAL SPECIFICATIONS TEKNİK ÖZELLİKLER

DESIGN CODES DİZAYN KODLARI	AD 2000
	EN 13445
	ASME SEC. VIII DIV.1
DESIGN PRESSURE DİZAYN BASINCI	10 / 16 / 40 Bar
TEST PRESSURE TEST BASINCI	15 / 24 / 60 Bar

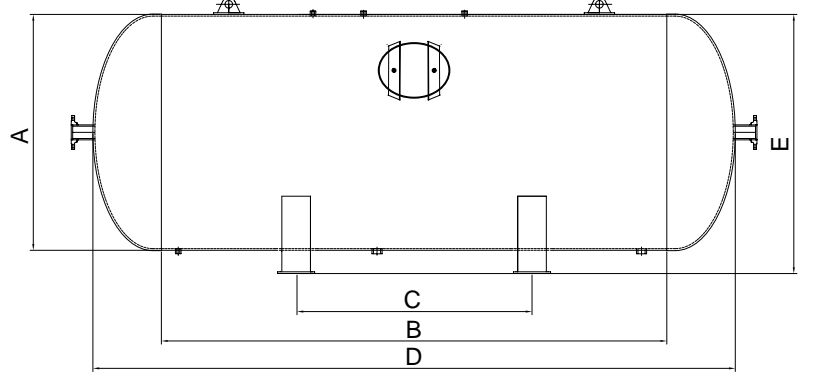

PRODUCT CODE ÜRÜN KODU	VOLUME (LITERS) HACİM (LİTRE)	A (mm)	B (mm)	C (mm)	D (mm)	E max (mm)
AHT 100	100	323	1500	750	1750	480
AHT 200	200	400	1500	750	1750	550
AHT 300	300	550	1200	600	1560	700
AHT 500	500	600	1500	750	1890	750
AHT 750	750	750	1500	750	1930	900
AHT 1000	1000	850	1500	750	2000	1000
AHT 1500	1500	1000	1500	750	2060	1200
AHT 2000	2000	1150	1500	750	2140	1350
AHT 3000	3000	1400	1500	750	2280	1600
AHT 4000	4000	1600	1500	750	2400	1800
AHT 5000	5000	1600	2000	1000	2900	1800
AHT 6000	6000	1600	2500	1250	3400	1800
AHT 8000	8000	1600	3500	1750	4400	1800
AHT 10000	10000	1600	4500	2250	5400	1800
AHT 10000	10000	1900	3000	1500	4040	2100
AHT 15000	15000	2250	3000	1500	4200	2500
AHT 20000	20000	2250	4500	2250	5700	2500

Above mentioned items are our standard products, please contact us for different sizes.

Standart ürünlerimiz dışındaki farklı ölçü talepleriniz için lütfen bizimle iletişime geçin.

Pressure Air Tank - Vertical Dikey Hava Tankı

Oksijen Tankı - Oxygen Tank



TECHNICAL SPECIFICATIONS TEKNİK ÖZELLİKLER

DESIGN CODES DİZAYN KODLARI	AD 2000
	EN 13445
	ASME SEC. VIII DIV.1
DESIGN PRESSURE DİZAYN BASINCI	11 / 16 / 40 Bar
TEST PRESSURE TEST BASINCI	16.5 / 24 / 60 Bar

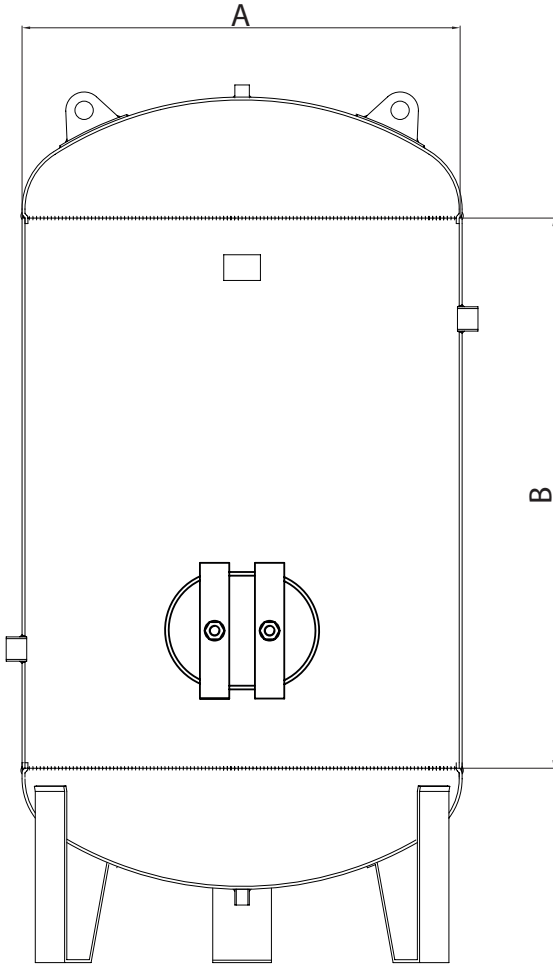

PRODUCT CODE ÜRÜN KODU	VOLUME (LITERS) HACİM (LİTRE)	A (mm)	B (mm)	C (mm)
AVT 100	100	323	1150	1600
AVT 200	200	400	1500	1950
AVT 300	300	550	1200	1760
AVT 500	500	600	1500	2090
AVT 750	750	750	1500	2130
AVT 1000	1000	850	1500	2200
AVT 1500	1500	1000	1500	2260
AVT 2000	2000	1150	1500	2340
AVT 3000	3000	1400	1500	2480
AVT 4000	4000	1600	1500	2600
AVT 5000	5000	1600	2000	3100
AVT 6000	6000	1600	2500	3600
AVT 8000	8000	1600	3500	4600
AVT 10000	10000	1600	4500	5600
AVT 10000	10000	1900	3000	4300
AVT 15000	15000	2250	3000	4500
AVT 20000	20000	2250	4500	6000

Above mentioned items are our standard products, please contact us for different sizes.

Standart ürünlerimiz dışındaki farklı ölçü talepleriniz için lütfen bizimle iletişime geçin.



GBS & Bemmak is a member of **KARTAL GROUP**

LPG Storage Tanks - Horizontal Yatay LPG Depolama Tankı



TECHNICAL SPECIFICATIONS TEKNİK ÖZELLİKLER

DESIGN CODES DİZAYN KODLARI	AD 2000
	EN 13445
	ASME SEC. VIII DIV.1
DESIGN PRESSURE DİZAYN BASINCI	17,16 Bar
TEST PRESSURE TEST BASINCI	25,74 Bar

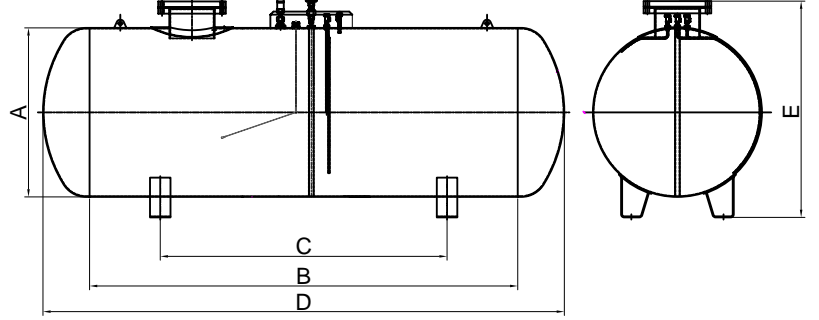

PRODUCT CODE ÜRÜN KODU	VOLUME (LITERS) HACİM (LİTRE)	A (mm)	B (mm)	C (mm)	D (mm)	E max (mm)
LHT 1000	1000	800	1750	850	2200	1300
LHT 1800	1800	1000	1800	900	2380	1500
LHT 3000	3000	1200	2250	1100	2975	1700
LHT 3850	3850	1200	3000	1500	3725	1700
LHT 5000	5000	1200	4000	2000	4725	1700
LHT 7000	7000	1600	3000	1500	3900	2160
LHT 10000	10000	1600	4500	3300	5392	2160
LHT 10000	10000	1900	2850	1850	3974	2420
LHT 22000	22000	2350	4500	3300	5745	2850
LHT 40000	40000	2400	8000	4000	9350	2900
LHT 50000	50000	2400	10500	5250	11850	2900
LHT 100000	100000	2950	13500	6750	15170	3500
LHT 115000	115000	3000	15500	7750	17150	3500
LHT 150000	150000	3150	18250	9600	19930	3500
LHT 200000	200000	3500	20000	11000	21950	3600
LHT 250000	250000	3500	24800	12375	26700	3600

Above mentioned items are our standard products, please contact us for different sizes.
Standart ürünlerimiz dışındaki farklı ölçü talepleriniz için lütfen bizimle iletişime geçin.

LPG Storage Tanks - Vertical

Dikey LPG Depolama Tankı



TECHNICAL SPECIFICATIONS

TEKNİK ÖZELLİKLER

DESIGN CODES DİZAYN KODLARI	AD 2000
	EN 13445
	ASME SEC. VIII DIV.1
DESIGN PRESSURE DİZAYN BASINCI	17,16 Bar
TEST PRESSURE TEST BASINCI	25,74 Bar

PRODUCT CODE ÜRÜN KODU	VOLUME (LITERS) HACİM (LİTRE)	A (mm)	B (mm)	C (mm)
LVT 500	500	800	750	1400
LVT 1000	1000	1000	950	1740
LVT 2150	2150	1200	1500	2430

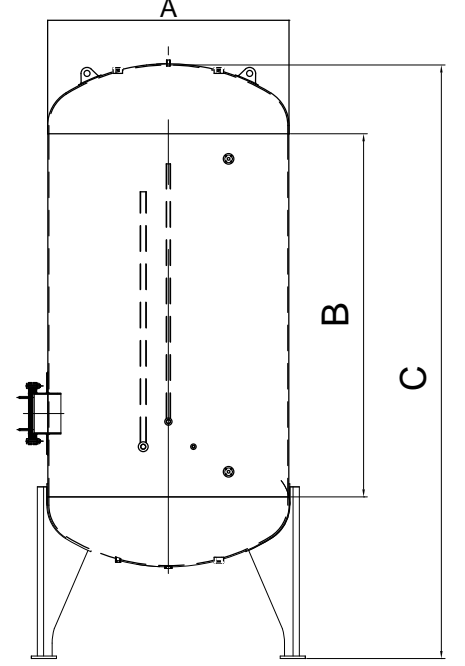

Above mentioned items are our standard products, please contact us for different sizes.
Standart ürünlerimiz dışındaki farklı ölçü talepleriniz için lütfen bizimle iletişime geçin.

LPG Autogas Storage Tanks

LPG Otogaz Depolama Tankı

DESIGN CODES DİZAYN KODLARI	AD 2000
	EN 13445
	ASME SEC. VIII DIV.1
DESIGN PRESSURE DİZAYN BASINCI	17,16 Bar
TEST PRESSURE TEST BASINCI	25,74 Bar

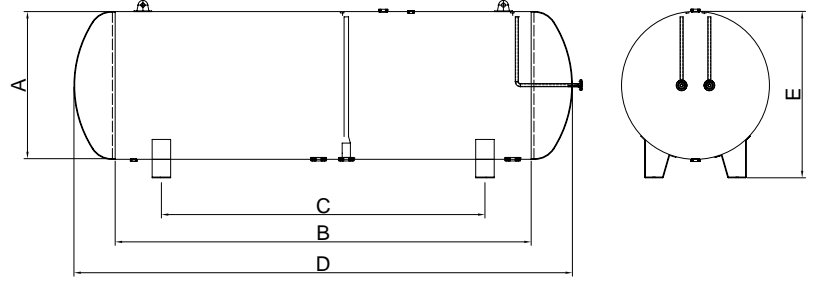

PRODUCT CODE ÜRÜN KODU	VOLUME (LITERS) HACİM (LİTRE)	A (mm)	B (mm)	C (mm)	D (mm)	E max (mm)
LAT 5000	5000	1200	4000	2000	4725	1400
LAT 7000	7000	1600	3000	1500	3900	1600
LAT 10000	10000	1600	4500	3300	5392	1800
LAT 10000	10000	1900	2850	1850	3974	2050
LAT 15000	15000	1900	3300	1850	4424	2050
LAT 22000	22000	2350	4500	3300	5745	2550

Above mentioned items are our standard products, please contact us for different sizes.
Standart ürünlerimiz dışındaki farklı ölçü talepleriniz için lütfen bizimle iletişime geçin.







GBS Basınçlı Kaplar A.Ş.

Akçaburgaz Mah. 137. Sok. No:11 Esenyurt / İSTANBUL / TÜRKİYE

Tel : +90 212 407 08 08 Fax : +90 (212) 486 36 49

E-mail : info@guvenbombe.com.tr



www.guvenbombe.com.tr



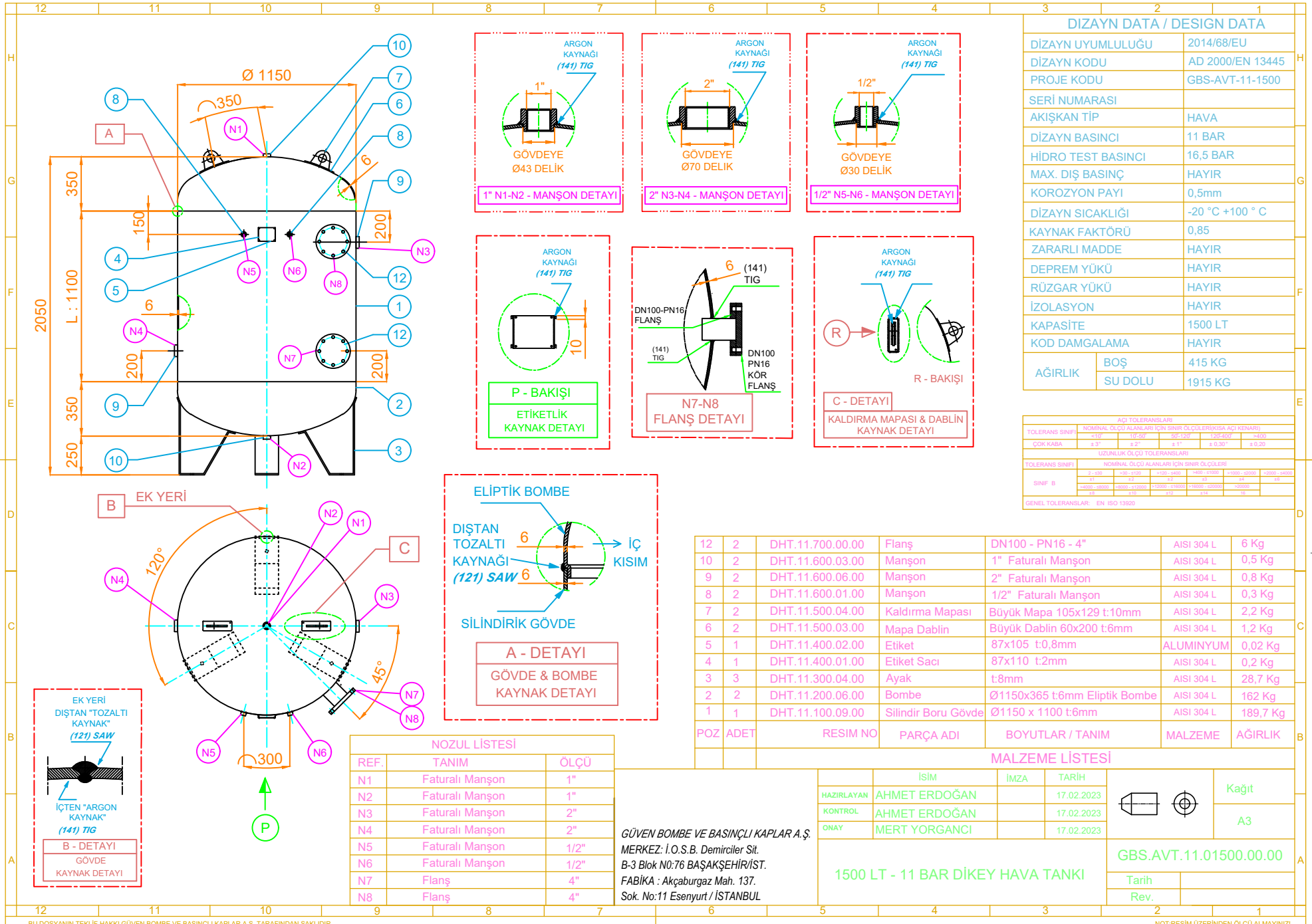

DİZAYN DATA / DESIGN DATA		
DİZAYN UYUMLULUĞU	2014/68/EU	
DİZAYN KODU	AD 2000/EN 13445	
PROJE KODU	GBS-AVT-11-1500	
SERİ NUMARASI		
AKIŞKAN TİPİ	HAVA	
DİZAYN BASINCI	11 BAR	
HİDRO TEST BASINCI	16,5 BAR	
MAX. DIŞ BASINÇ	HAYIR	
KOROZYON PAYI	0,5mm	
DİZAYN SICAKLIĞI	-20 °C +100 °C	
KAYNAK FAKTÖRÜ	0,85	
ZARARLI MADDE	HAYIR	
DEPREM YÜKÜ	HAYIR	
RÜZGAR YÜKÜ	HAYIR	
İZOLASYON	HAYIR	
KAPASİTE	1500 LT	
KOD DAMGALAMA	HAYIR	
AĞIRLIK	BOŞ	415 KG
	SU DOLU	1915 KG

AĞI TOLERANSLARI	
TOLERANS SINIFI	NOMİNAL ÖLÇÜ ALANLARI İÇİN SINIR DEĞERLERİ (AĞI KENARI)
	<10 10-50 50-120 125-400 >400
ÇOK KABA	±3' ±1' ±1' ±1' ±0,20
UZUNLUK ÖLÇÜ TOLERANSLARI	
TOLERANS SINIFI	NOMİNAL ÖLÇÜ ALANLARI İÇİN SINIR ÖLÇÜLERİ
	0-150 150-315 315-630 630-1260 1260-2520 2520-5040
SINIF B	±0,1 ±0,15 ±0,2 ±0,3 ±0,4 ±0,5 ±0,6 ±0,8 ±1,0 ±1,2 ±1,6 ±2,0
GENEL TOLERANSLAR: EN ISO 13020	

POZ	ADET	RESİM NO	PARÇA ADI	BOYUTLAR / TANIM	MALZEME	AĞIRLIK
12	2	DHT.11.700.00.00	Flanş	DN100 - PN16 - 4"	AIŞI 304 L	6 Kg
10	2	DHT.11.600.03.00	Manşon	1" Faturalı Manşon	AIŞI 304 L	0,5 Kg
9	2	DHT.11.600.06.00	Manşon	2" Faturalı Manşon	AIŞI 304 L	0,8 Kg
8	2	DHT.11.600.01.00	Manşon	1/2" Faturalı Manşon	AIŞI 304 L	0,3 Kg
7	2	DHT.11.500.04.00	Kaldırma Mapası	Büyük Mapa 105x129 t:10mm	AIŞI 304 L	2,2 Kg
6	2	DHT.11.500.03.00	Mapa Dablin	Büyük Dablin 60x200 t:6mm	AIŞI 304 L	1,2 Kg
5	1	DHT.11.400.02.00	Etiket	87x105 t:0,8mm	ALUMİNYUM	0,02 Kg
4	1	DHT.11.400.01.00	Etiket Sacı	87x110 t:2mm	AIŞI 304 L	0,2 Kg
3	3	DHT.11.300.04.00	Ayak	t:8mm	AIŞI 304 L	28,7 Kg
2	2	DHT.11.200.06.00	Bombe	Ø1150x365 t:6mm Eliptik Bombe	AIŞI 304 L	162 Kg
1	1	DHT.11.100.09.00	Silindir Boru Gövde	Ø1150 x 1100 t:6mm	AIŞI 304 L	189,7 Kg

MALZEME LİSTESİ			
HAZIRLAYAN	İSİM	İMZA	TARİH
AHMET ERDOĞAN	AHMET ERDOĞAN		17.02.2023
KONTROL	AHMET ERDOĞAN		17.02.2023
ONAY	MERT YORGANCI		17.02.2023
1500 LT - 11 BAR DİKEY HAVA TANKI			
			Kağıt
			A3
			GBS.AVT.11.01500.00.00
			Tarih
			Rev.

NOZUL LİSTESİ		
REF.	TANIM	ÖLÇÜ
N1	Faturalı Manşon	1"
N2	Faturalı Manşon	1"
N3	Faturalı Manşon	2"
N4	Faturalı Manşon	2"
N5	Faturalı Manşon	1/2"
N6	Faturalı Manşon	1/2"
N7	Flanş	4"
N8	Flanş	4"

GÜVEN BOMBE VE BASINÇLI KAPLAR A.Ş.
 MERKEZ: İ.O.S.B. Demirciler Sit.
 B-3 Blok NO:76 BAŞAKŞEHİR/İST.
 FABİKA : Akçaburgaz Mah. 137.
 Sok. No:11 Esenyurt / İSTANBUL

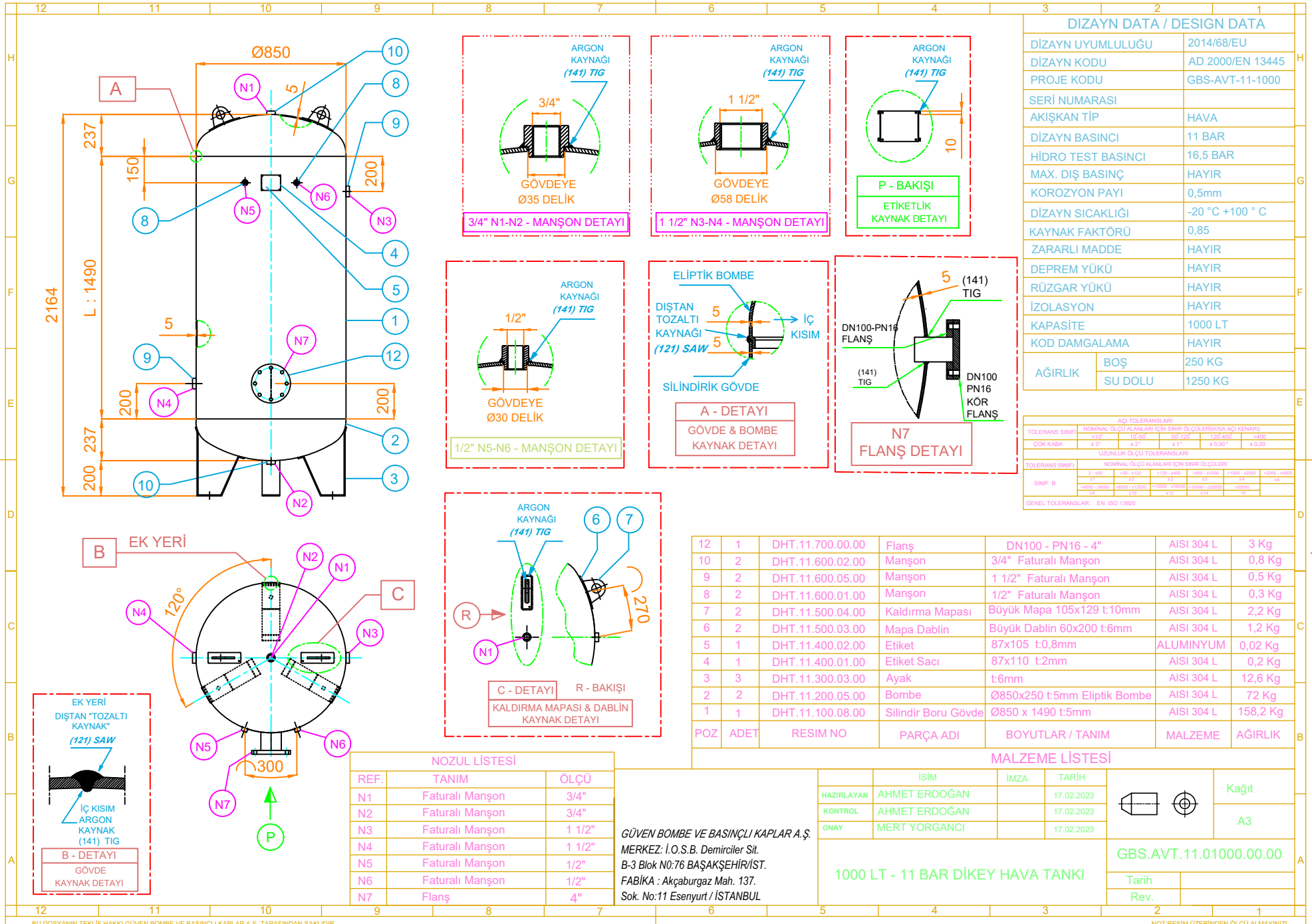

DİZAYN DATA / DESIGN DATA		
DİZAYN UYUMLULUĞU	2014/68/EU	
DİZAYN KODU	AD 2000/EN 13445	
PROJE KODU	GBS-AVT-11-1000	
SERİ NUMARASI		
AKIŞKAN TİPİ	HAVA	
DİZAYN BASINCI	11 BAR	
HİDRO TEST BASINCI	16,5 BAR	
MAX. DIŞ BASINÇ	HAYIR	
KOROZYON PAYI	0,5mm	
DİZAYN SICAKLIĞI	-20 °C +100 ° C	
KAYNAK FAKTÖRÜ	0,85	
ZARARLI MADDE	HAYIR	
DEPREM YÜKÜ	HAYIR	
RÜZGAR YÜKÜ	HAYIR	
İZOLASYON	HAYIR	
KAPASİTE	1000 LT	
KOD DAMGALAMA	HAYIR	
AĞIRLIK	BOŞ	250 KG
	SU DOLU	1250 KG

AĞI TOLERANSLARI	
TOLERANS SINIFI	NOMİNAL ÖLÇÜ ALANLARI İÇİN SINIR DEĞERLERİ(AĞI KENARI)
	≤12" ±0,15" 12"-25" ±0,25" 25"-50" ±0,30" 50"-100" ±0,40" 100"-1500" ±0,50" 1500"-5000" ±0,60"
	ÇOK KABA ±3" ±1" ±0,30" ±0,20"
UZUNLUK ÖLÇÜ TOLERANSLARI	
TOLERANS SINIFI	NOMİNAL ÖLÇÜ ALANLARI İÇİN SINIR DEĞERLERİ
	≤12" ±0,30" 12"-25" ±0,40" 25"-50" ±0,50" 50"-100" ±0,60" 100"-1500" ±0,70" 1500"-5000" ±0,80"
SINIF B	±0,50" ±0,60" ±0,70" ±0,80" ±0,90" ±1,00" ±1,10" ±1,20" ±1,30" ±1,40" ±1,50"
GENEL TOLERANSLAR: EN ISO 13020	

POZ	ADET	RESİM NO	PARÇA ADI	BOYUTLAR / TANIM	MALZEME	AĞIRLIK
12	1	DHT.11.700.00.00	Flanş	DN100 - PN16 - 4"	AISI 304 L	3 Kg
10	2	DHT.11.600.02.00	Manşon	3/4" Faturalı Manşon	AISI 304 L	0,8 Kg
9	2	DHT.11.600.05.00	Manşon	1 1/2" Faturalı Manşon	AISI 304 L	0,5 Kg
8	2	DHT.11.600.01.00	Manşon	1/2" Faturalı Manşon	AISI 304 L	0,3 Kg
7	2	DHT.11.500.04.00	Kaldırma Mapası	Büyük Mapa 105x129 t:10mm	AISI 304 L	2,2 Kg
6	2	DHT.11.500.03.00	Mapa Dublin	Büyük Dublin 60x200 t:6mm	AISI 304 L	1,2 Kg
5	1	DHT.11.400.02.00	Etiket	87x105 t:0,8mm	ALÜMİNYUM	0,02 Kg
4	1	DHT.11.400.01.00	Etiket Sacı	87x110 t:2mm	AISI 304 L	0,2 Kg
3	3	DHT.11.300.03.00	Ayak	t:6mm	AISI 304 L	12,6 Kg
2	2	DHT.11.200.05.00	Bombe	Ø850x250 t:5mm Eliptik Bombe	AISI 304 L	72 Kg
1	1	DHT.11.100.08.00	Silindir Boru Gövde	Ø850 x 1490 t:5mm	AISI 304 L	158,2 Kg

MALZEME LİSTESİ			
HAZIRLAYAN	İSİM	İMZA	TARİH
AHMET ERDOĞAN			17.02.2023
AHMET ERDOĞAN			17.02.2023
MERT YORGANCI			17.02.2023
1000 LT - 11 BAR DİKEY HAVA TANKI			Kağıt
			A3
GBS.AVT.11.01000.00.00			Tarih
			Rev.

NOZUL LİSTESİ		
REF.	TANIM	ÖLÇÜ
N1	Faturalı Manşon	3/4"
N2	Faturalı Manşon	3/4"
N3	Faturalı Manşon	1 1/2"
N4	Faturalı Manşon	1 1/2"
N5	Faturalı Manşon	1/2"
N6	Faturalı Manşon	1/2"
N7	Flanş	4"

GÜVEN BOMBE VE BASINÇLI KAPLAR A.Ş.
 MERKEZ: İ.O.S.B. Demirciler Sit.
 B-3 Blok NO:76 BAŞAKŞEHİR/İST.
 FABİKA : Akçaburgaz Mah. 137.
 Sok. No:11 Esenyurt / İSTANBUL