

ORDIN DE PLATA NR.: 3257

TIP.DOC. 1 :

DATA EMITERII: vineri, 8 noiembrie:

PLATITI: 5000-00

LEI: Cinci Mii lei 00 bani

PLATITOR: (R) "BIOSISTEM
MLD" S.R.L.

CONTUL DE PLATI/CODUL IBAN
MD95ML000000002251429243
CODUL FISCAL :1010600028048 /

PRESTATORUL PLATITOR
BC"Moldindconbank"S.A. suc."Invest" Chisinau

CODUL BANCII:
:MOLDMD2X329:

BENEFICIAR (R) IMSP SPITAL
UL RAIONAL CIMISLIA

CONTUL DE PLATI/CODUL IBAN
MD79AG0000000022512564163
CODUL FISCAL :1003605150319 /

PRESTATORUL BENEFICIAR
BC"MAIB"S.A.

CODUL BANCII:
:AGRNMD2X

DESTINATIA PLATII: Pentru garantia pentru:
oferta la procedura de achizi?ie public:
a nr. ocds-b3wdp1-MD-1730452563533 din
11.11.2024

TIPUL TRANSFERULUI
NORMAL/URGENT :N:

L.S.

CODUL TRANZACTIEI: 001:

DATA PRIMIRII: 08/11/2024

DATA EXECUTARII:

SEMNATURILE
EMITENTULUI

CONDUCTOR: Web Poiata Vitalie

MIIGYwYJKoZiIhvcNAQcCoIIGVDCCBlACAQExCzAJBgUrDgMCGGUAMAsGCSqGSIB3:
DQEHAaCCBGwwggRoMIIDUKADAgECAhNHAAEDi65avx+fxSldAAAAAQOLMAOGCSqG:
SIB3DQEBCwUAMCIxIDAeBgNVBAMTFONFUF1QxLUNBLU1vbGRpbmRjb25iYW5rMB4X:
DTIOMDEyNTEzMzNlOxDTI3MDEyNTEzNDMzNVowgaMxCzAJBgNVBAYTAk1EMRAw:
YDVQIQIEwdNb2xkb3ZhmREwDwYDVQQHEwhDaGlzaW5hdTEWMBQGA1UEChMNQmlv

(semnatura electronica)

CONTABIL-SEF: Web Nasedchin Alexandr

MIIGZwYJKoZiIhvcNAQcCoIIGWDCCBlQCAQExCzAJBgUrDgMCGGUAMAsGCSqGSIB3:
DQEHAaCCBHAWggRsMIIDVKADAgECAhNHAAEDijjVd7aJ5r0rAAAAAQOKMAOGCSqG:
SIB3DQEBCwUAMCIxIDAeBgNVBAMTFONFUF1QxLUNBLU1vbGRpbmRjb25iYW5rMB4X:
DTIOMDEyNTEzMzNVowgaMxCzAJBgNVBAYTAk1EMRAw:
YDVQIQIEwdNb2xkb3ZhmREwDwYDVQQHEwhDaGlzaW5hdTEWMBQGA1UEChMNQmlv

L.S. (semnatura electronica)

CONDUCTOR:

(semnatura manuala)

CONTABIL-SEF:

(semnatura manuala)

SEMNATURA PRESTATORUL

L.S.

MOTIVUL REFUZULUI

L.S.



GUVERNUL
REPUBLICII
MOLDOVA



SERVICIUL FISCAL DE STAT



CERTIFICAT

privind lipsa sau existența restanțelor față de bugetul public național

Nr.
№ 1351048

Din
От 05.11.2024 13:51

DATE DESPRE CONTRIBUABIL / ИНФОРМАЦИЯ О НАЛОГОПЛАТЕЛЬЩИКЕ

Codul fiscal / Numărul de identificare

Фискальный код / Идентификационный номер

1010600028048

Denumirea

Наименование

Societatea cu Răspundere Limitată BIOSISTEM MLD

ATESTAREA LIPSEI SAU EXISTENȚEI RESTANȚELOR CONFORM DATELOR SISTEMULUI

INFORMAȚIONAL AUTOMATIZAT / ПОДТВЕРЖДЕНИЕ ОТСУТСТВИЯ ИЛИ НАЛИЧИЯ
ЗАДОЛЖНОСТЕЙ СОГЛАСНО ДАННЫМ ИНФОРМАЦИОННОЙ АВТОМАТИЗИРОВАННОЙ
СИСТЕМЫ

La data emiterii prezentului certificat restanța față de bugetul public național constituie

На дату выдачи данной справки задолженность перед национальным публичным бюджетом составляет

0 MDL

VALABIL PÂNĂ LA / ДЕЙСТВИТЕЛЕН ДО

20.11.2024 13:51



Prezentul document este eliberat în temeiul Art. 29, alin. (3) din Legea cu privire la registre nr. 71/2007 și în baza datelor furnizate de Serviciul Fiscal de Stat în Portalul Guvernamental al Cetățeanului și al Unităților de Drept / Справка выдана в соответствии со ст. 29 п. (3) Закона о реестрах № 71/2007 на основании данных, предоставленных Государственной налоговой службой на Портале Правительства Гражданина и Юридических Лиц.

Generat și semnat de Portalul Guvernamental al Cetățeanului și al Unităților de Drept la 05.11.2024 13:51

Prezentul certificat este semnat electronic în conformitate cu Legea nr.124 din 19.05.2022

Сертификат подписан электронной подписью в соответствии с Законом № 124 от 19.05.2022



Certificatul este descărcat din Portalul Guvernamental al Cetățeanului și al Unităților de Drept (mcabinet.gov.md) și este semnat electronic de către posesorul acestui portal și are aceeași valoare juridică ca și documentele eliberate pe suport de hârtie de către organele cu atribuții de administrare fiscală. Verificarea autenticității semnăturii electronice poate fi realizată cu ajutorul Serviciului Guvernamental de Semnătură Electronică (msign.gov.md)

Сертификат скачен с Правительственного Портала Гражданина и Юридических Лиц (mcabinet.gov.md) и подписан электронной подписью владельца портала и имеет такую же юридическую силу, как и документы выдаваемые на бумаге органами налоговой администрации. Проверку подлинности электронной подписи можно осуществить с помощью Государственной Службой Электронной Подписью (msign.gov.md)

REPUBLICA



MOLDOVA

CERTIFICAT DE ÎNREGISTRARE

Societatea cu Răspundere Limitată "BIOSISTEM MLD"
— ESTE ÎNREGISTRATĂ LA CAMERA ÎNREGISTRĂRII DE STAT —

Numărul de identificare de stat - codul fiscal
1010600028048

Data înregistrării

12.08.2010

Data eliberării

12.08.2010

Svirepova Ludmila, registrator

*Funcția, numele, prenumele persoanei
care a eliberat certificatul*

L. Svirepova
semnătura

MD 0101250





AGENȚIA SERVICII PUBLICE

Departamentul înregistrare și licențiere a unităților de drept

EXTRAS

din Registrul de stat al persoanelor juridice

Nr. 531522 data 15.09.2023

Denumirea completă: **Societatea cu Răspundere Limitată "BIOSISTEM MLD"**

Denumirea prescurtată: **"BIOSISTEM MLD" S.R.L.**

Forma juridică de organizare: **Societate cu răspundere limitată,**

Numărul de identificare de stat și codul fiscal (IDNO): **1010600028048**

Data înregistrării de stat: **12.08.2010**

Sediul: **MD-2001, str. Albișoara, 16/1, ap. 7, mun. Chișinău, Republica Moldova.**

Obiectul principal de activitate:

- 1. Activitatea farmaceutică; importul și (sau) producerea articolelor de parfumerie și cosmetică**
- 2. Fabricarea, comercializarea, asistența tehnică, repararea și verificarea articolelor de tehnică și optică medicală**
- 3. Acordarea asistenței medicale de către instituțiile medico-sanitare private**
- 4. Comerțul cu ridicata al calculatoarelor, echipamentelor periferice și software-ului**
- 5. Întreținerea și repararea mașinilor de birou și a tehnicii de calcul**
- 6. Consultații în domeniul sistemelor de calcul**

Capitalul social: **5400 lei.**

Administrator: **POIATA VITALIE, IDNP 0983103892591,**

Asociații:

1. **POIATA VITALIE, IDNP 0983103892591, cota 1803,60 lei, ce constituie 33,4%**

Beneficiar efectiv:

1.1. **POIATA VITALIE, IDNP 0983103892591,**

2. **NASEDCHIN ALEXANDR, IDNP 2002001070747, cota 1798,20 lei, ce constituie 33,3%**

Beneficiar efectiv:

2.1. **NASEDCHIN ALEXANDR, IDNP 2002001070747,**

3. **KOJEVNIKOV DMITRII, IDNP 0972305012362, cota 1798,20 lei, ce constituie 33,3%**

Beneficiar efectiv:

3.1. **KOJEVNIKOV DMITRII, IDNP 0972305012362**

Prezentul extras este eliberat în temeiul art.34 al Legii nr.220-XVI din 19 octombrie 2007 privind înregistrarea de stat a persoanelor juridice și a întreprinzătorilor individuali și confirmă datele din Registrul de stat la data de: **15.09.2023.**

**Registrator în domeniul
înregistrării de stat**

Digitally signed by Rusu Diana
Date: 2023.09.15 16:44:17 EEST
Reason: MoldSign Signature
Location: Moldova



Rusu Diana



EB 0461494



BC "MOLDINDCONBANK" S.A. Filiala "Invest"

Republica Moldova, MD-2068
mun. Chişinău, bd. Moscovei, 14/1
Tel. : (373-22) 43-44-81, 43-46-24
Fax : (373-22) 43-44-22
cod: MOLDM2X329

Data 14. IAN. 2016
Nr. 03/2 - 19/23

Республика Молдова, MD-2068
мун. Кишинэу, бул. Московей, 14/1
Тел. : (373-22) 43-44-81, 43-46-24
Факс : (373-22) 43-44-22
код: MOLDM2X329

Filiala „Invest” BC „Moldindconbank” SA confirmă existența contului curent
in moneda nationala al **“BIOSISTEM MLD” S.R.L. (c/f 1010600028048)**, cu
IBAN MD95ML000000002251429243.

Codul băncii MOLDM2X329.

Director

Nina Turcan

Director financiar



Nina Balmuş

Ex. Diana Brinza
Tel. 43-45-96

Lista fondatorilor Biosistem-mld SRL

Nr.	Nume, Prenume	IDNP
1.	Vitalie Poiata	0983103892591
2.	Alexandr Nasedchin	2002001070747
3.	Dmitrii Kojevnikov	0972305012362

Cod Fiscal: 1010600028048; IBAN: MD95ML00000002251429243;
Banca: BC "Moldindconbank" S.A. fil. Invest; Codul bancii: MOLDMD2X329;
Adresa poștală a băncii: mun. Chișinău, bd. Moscovei, 14/1;

Scrisoare de informare

Prin prezenta, SRL „Biosistem mld”, va informeaza ca conform “*legii Nr. 160 din 22-07-2011 privind reglementarea prin autorizare a activității de întreprinzător*”, cu modificarile ulterior adoptate de parlamentul RM, *Importul, comercializarea, asistența tehnică si reparația dispozitivelor medicale* nu mai este activitate licentiata. Respectiv nu mai sunt eliberate licente pentru acest gen de activitate, iar licentele cu termenul de valabilitate expirat nu mai sunt prelungite.



Vitalie Poiata

L.Ș.

SITUAȚIILE FINANCIARE

pentru perioada 01.01.2023 - 31.12.2023

Entitatea: BIOSISTEM MLD S.R.L.

Cod CUIÎO: 40717392

Cod IDNO: 1010600028048

Sediul:

MD:

Raionul(municipiul): 106, DDF RASCANI

Cod CUATM: 0150, SEC.RISCANI

Strada: Albisoara nr.16 bl.1 of.7

Activitatea principală: G4646, Comert cu ridicata al produselor farmaceutice

Forma de proprietate: 16, Proprietate colectivă

Forma organizatorico-juridică: 530, Societăți cu răspundere limitată

Date de contact:

Telefon: +37322808719

WEB:

E-mail: zmii13@mail.ru

Numele și coordonatele al contabilului-șef: DI (dna) Tel.

Numărul mediu al salariaților în perioada de gestiune: 10 persoane.

Persoanele responsabile de semnarea situațiilor financiare* Nasedchin Alexandr

Unitatea de măsură: leu

BILANȚUL

Anexa 1

la

Nr. cpt.	Indicatori	Cod rd.	Sold la	
			Începutul perioadei de gestiune	Sfârșitul perioadei de gestiune
1	2	3	4	5
	A C T I V			
A.	ACTIVE IMOBILIZATE			
	I. Imobilizări necorporale			
	1. Imobilizări necorporale în curs de execuție	010		
	2. Imobilizări necorporale în exploatare, total	020		
	din care:			
	2.1. concesiuni, licențe și mărci	021		
	2.2. drepturi de autor și titluri de protecție	022		
	2.3. programe informatice	023		

2.4. alte immobilizări necorporale	024		
3. Fond comercial	030		
4. Avansuri acordate pentru immobilizări necorporale	040		
Total immobilizări necorporale (rd.010 + rd.020 + rd.030 + rd.040)	050		
II. Immobilizări corporale			
1. Immobilizări corporale în curs de execuție	060		
2. Terenuri	070		
3. Mijloace fixe, total	080	3384131	4438372
din care:			
3.1. clădiri	081		
3.2. construcții speciale	082		
3.3. mașini, utilaje și instalații tehnice	083	3363063	4423127
3.4. mijloace de transport	084		
3.5. inventar și mobilier	085	21068	15245
3.6. alte mijloace fixe	086		
4. Resurse minerale	090		
5. Active biologice immobilizate	100		
6. Investiții imobiliare	110		
7. Avansuri acordate pentru immobilizări corporale	120	5250844	2337159
Total immobilizări corporale (rd.060 + rd.070 + rd.080 + rd.090 + rd.100 + rd.110 + rd.120)	130	8634975	6775531
III. Investiții financiare pe termen lung			
1. Investiții financiare pe termen lung în părți neafiliate	140		
2. Investiții financiare pe termen lung în părți afiliate, total	150		
din care:			
2.1. acțiuni și cote de participație deținute în părțile afiliate	151		
2.2 împrumuturi acordate părților afiliate	152		
2.3 împrumuturi acordate aferente intereselor de participare	153		
2.4 alte investiții financiare	154		
Total investiții financiare pe termen lung (rd.140 + rd.150)	160		
IV. Creanțe pe termen lung și alte active immobilizate			
1. Creanțe comerciale pe termen lung	170		
2. Creanțe ale părților afiliate pe termen lung	180		
inclusiv: creanțe aferente intereselor de participare	181		
3. Alte creanțe pe termen lung	190		

	4. Cheltuieli anticipate pe termen lung	200		
	5. Alte active imobilizate	210		
	Total creanțe pe termen lung și alte active imobilizate (rd.170 + rd.180 + rd.190 + rd.200 + rd.210)	220		
	TOTAL ACTIVE IMOBILIZATE (rd.050 + rd.130 + rd.160 + rd.220)	230	8634975	6775531
B.	ACTIVE CIRCULANTE			
	I. Stocuri			
	1. Materiale și obiecte de mică valoare și scurtă durată	240	13899	24776
	2. Active biologice circulante	250		
	3. Producția în curs de execuție	260		
	4. Produse și mărfuri	270	11123640	11490033
	5. Avansuri acordate pentru stocuri	280		
	Total stocuri (rd.240 + rd.250 + rd.260 + rd.270 + rd.280)	290	11137539	11514809
	II. Creanțe curente și alte active circulante			
	1. Creanțe comerciale curente	300	4552459	2646694
	2. Creanțe ale părților afiliate curente	310		
	inclusiv: creanțe aferente intereselor de participare	311		
	3. Creanțe ale bugetului	320	27696	45618
	4. Creanțele ale personalului	330		
	5. Alte creanțe curente	340		
	6. Cheltuieli anticipate curente	350		
	7. Alte active circulante	360	2268111	2251145
	Total creanțe curente și alte active circulante (rd.300 + rd.310 + rd.320 + rd.330 + rd.340 + rd.350 + rd.360)	370	6848266	4943457
	III. Investiții financiare curente			
	1. Investiții financiare curente în părți nefiliate	380		
	2. Investiții financiare curente în părți afiliate, total	390		
	din care:			
	2.1. acțiuni și cote de participație deținute în părțile afiliate	391		
	2.2. împrumuturi acordate părților afiliate	392		
	2.3. împrumuturi acordate aferente intereselor de participare	393		
	2.4. alte investiții financiare în părți afiliate	394		
	Total investiții financiare curente (rd.380 + rd.390)	400		
	IV. Numerar și documente bănești	410	10281443	27361722
	TOTAL ACTIVE CIRCULANTE (rd.290 + rd.370 + rd.400 + rd.410)	420	28267248	43819988

	TOTAL ACTIVE (rd.230 + rd.420)	430	36902223	50595519
	P A S I V			
	CAPITAL PROPRIU			
	I. Capital social și neînregistrat			
	1. Capital social	440	5400	5400
	2. Capital nevărsat	450	()	()
	3. Capital neînregistrat	460		
	4. Capital retras	470	()	()
	5. Patrimoniul primit de la stat cu drept de proprietate	480		
	Total capital social și neînregistrat (rd.440 + rd.450 + rd.460 + rd.470 + rd.480)	490	5400	5400
	II. Prime de capital	500		
	III. Rezerve			
	1. Capital de rezervă	510		
	2. Rezerve statutare	520		
C.	3. Alte rezerve	530		
	Total rezerve (rd.510 + rd.520 + rd.530)	540		
	IV. Profit (pierdere)			
	1. Corecții ale rezultatelor anilor precedenți	550	X	
	2. Profit nerepartizat (pierdere neacoperită) al anilor precedenți	560	35876971	29813141
	3. Profit net (pierdere netă) al perioadei de gestiune	570	X	18618853
	4. Profit utilizat al perioadei de gestiune	580	X	()
	Total profit (pierdere) (rd.550 + rd.560 + rd.570 + rd.580)	590	35876971	48431994
	V. Rezerve din reevaluare	600		
	VI. Alte elemente de capital propriu	610		
	TOTAL CAPITAL PROPRIU (rd.490 + rd.500 + rd.540 + rd.590 + rd.600 + rd.610)	620	35882371	48437394
D.	DATORII PE TERMEN LUNG			
	1. Credite bancare pe termen lung	630		
	2. Împrumuturi pe termen lung	640		
	din care:			
	2.1. împrumuturi din emisiunea de obligațiuni	641		
	inclusiv: împrumuturi din emisiunea de obligațiuni convertibile	642		
	2.2. alte împrumuturi pe termen lung	643		
	3. Datorii comerciale pe termen lung	650		

	4. Datorii față de părțile afiliate pe termen lung	660		
	inclusiv: datorii aferente intereselor de participare	661		
	5. Avansuri primite pe termen lung	670		
	6. Venituri anticipate pe termen lung	680		
	7. Alte datorii pe termen lung	690		
	TOTAL DATORII PE TERMEN LUNG (rd.630 + rd.640 + rd.650 + rd.660 + rd.670 + rd.680 + rd.690)	700		
	DATORII CURENTE			
	1. Credite bancare pe termen scurt	710		
	2. Împrumuturi pe termen scurt, total	720		
	din care:			
	2.1. Împrumuturi din emisiunea de obligațiuni	721		
	inclusiv: împrumuturi din emisiunea de obligațiuni convertibile	722		
	2.2. alte împrumuturi pe termen scurt	723		
	3. Datorii comerciale curente	730	5266	59765
	4. Datorii față de părțile afiliate curente	740		
E.	inclusiv: datorii aferente intereselor de participare	741		
	5. Avansuri primite curente	750	143160	273711
	6. Datorii față de personal	760	866	
	7. Datorii privind asigurările sociale și medicale	770		
	8. Datorii față de buget	780	831429	1766706
	9. Datorii față de proprietari	790		
	10. Venituri anticipate curente	800		
	11. Alte datorii curente	810	39131	57943
	TOTAL DATORII CURENTE (rd.710 + rd.720 + rd.730 + rd.740 + rd.750 + rd.760 + rd.770 + rd.780 + rd.790 + rd.800 + rd.810)	820	1019852	2158125
	PROVIZIOANE			
	1. Provizioane pentru beneficiile angajaților	830		
	2. Provizioane pentru garanții acordate cumpărătorilor/clientilor	840		
	3. Provizioane pentru impozite	850		
F.	4. Alte provizioane	860		
	TOTAL PROVIZIOANE (rd.830 + rd.840 + rd.850 + rd.860)	870		
	TOTAL PASIVE (rd.620 + rd.700 + rd.820 + rd.870)	880	36902223	50595519

SITUAȚIA DE PROFIT ȘI PIERDERE

de la 01.01.2023 până la 31.12.2023

Anexa 2

Indicatori	Cod rd.	Perioada de gestiune
------------	---------	----------------------

		precedenta	curenta
1	2	3	4
Venituri din vânzări, total	010	40621876	58891757
din care:			
venituri din vânzarea produselor și mărfurilor	011	39203671	57105542
venituri din prestarea serviciilor și executarea lucrărilor	012	1390733	1771148
venituri din contracte de construcție	013		
venituri din contracte de leasing	014		
venituri din contracte de microfinanțare	015		
alte venituri din vânzări	016	27472	15067
Costul vânzărilor, total	020	22086174	32917436
din care:			
valoarea contabilă a produselor și mărfurilor vândute	021	21991682	32793096
costul serviciilor prestate și lucrărilor executate terților	022	92356	124340
costuri aferente contractelor de construcție	023		
costuri aferente contractelor de leasing	024		
costuri aferente contractelor de microfinanțare	025		
alte costuri aferente vânzărilor	026	2136	
Profit brut (pierdere brută) (rd.010 - rd.020)	030	18535702	25974321
Alte venituri din activitatea operațională	040	128694	829270
Cheltuieli de distribuire	050	15271	4167
Cheltuieli administrative	060	3076978	3996115
Alte cheltuieli din activitatea operațională	070	1325483	879808
Rezultatul din activitatea operațională: profit (pierdere) (rd.030 + rd.040 - rd.050 - rd.060 - rd.070)	080	14246664	21923501
Venituri financiare, total	090	1530710	1070406
din care:			
venituri din interese de participare	091		
inclusiv: veniturile obținute de la părțile afiliate	092		
venituri din dobânzi	093	250190	337916
inclusiv: veniturile obținute de la părțile afiliate	094		
venituri din alte investiții financiare pe termen lung	095		
inclusiv: veniturile obținute de la părțile afiliate	096		
venituri aferente ajustărilor de valoare privind investițiile financiare pe termen lung și curente	097		
venituri din ieșirea investițiilor financiare	098		
venituri aferente diferențelor de curs valutar și de sumă	099	1280520	732490

Cheltuieli financiare, total	100	512939	1786338
din care:	101		
cheltuieli privind dobânzile			
inclusiv: cheltuielile aferente părților afiliate	102		
cheltuieli aferente ajustărilor de valoare privind investițiile financiare pe termen lung și curente	103		
cheltuieli aferente ieșirii investițiilor financiare	104		
cheltuieli aferente diferențelor de curs valutar și de sumă	105	512939	1786338
Rezultatul: profit (pierdere) financiar(ă) (rd.090 - rd.100)	110	1017771	-715932
Venituri cu active imobilizate și excepționale	120		
Cheltuieli cu active imobilizate și excepționale	130		
Rezultatul din operațiuni cu active imobilizate și excepționale: profit (pierdere) (rd.120 - rd.130)	140		
Rezultatul din alte activități: profit (pierdere) (rd.110 + rd.140)	150	1017771	-715932
Profit (pierdere) pînă la impozitare (rd.080 + rd.150)	160	15264435	21207569
Cheltuieli privind impozitul pe venit	170	1872862	2588716
Profit net (pierdere netă) al perioadei de gestiune (rd.160 - rd.170)	180	13391573	18618853

SITUAȚIA MODIFICĂRILOR CAPITALULUI PROPRIU

de la pînă la

Anexa 3

Nr. d/o	Indicatori	Cod rd	Sold la începutul perioadei de gestiune	Majorări	Diminuări	Sold la sfîrșitul perioadei de gestiune
1	2	3	4	5	6	7
	Capital social și neînregistrat					
	1. Capital social	010				
	2. Capital nevărsat	020	()	()	()	()
	3. Capital neînregistrat	030				
I.	4. Capital retras	040	()	()	()	()
	5. Patrimoniul primit de la stat cu drept de proprietate	050				
	Total capital social și neînregistrat (rd.010 + rd.020 + rd.030 + rd.040 + rd.050)	060				
II.	Prime de capital	070				
III.	Rezerve					
	1. Capital de rezervă	080				
	2. Rezerve statutare	090				

	3. Alte rezerve	100				
	Total rezerve (rd.080 + rd.090 + rd.100)	110				
	Profit (pierdere)					
IV.	1. Corecții ale rezultatelor anilor precedenți	120	X			
	2. Profit nerepartizat (pierdere neacoperită) al anilor precedenți	130				
	3. Profit net (pierdere netă) al perioadei de gestiune	140	X			
	4. Profit utilizat al perioadei de gestiune	150	X	(((
	Total profit (pierdere) (rd.120 + rd.130 + rd.140 + rd.150)	160				
V.	Rezerve din reevaluare	170				
VI.	Alte elemente de capital propriu	180				
	Total capital propriu (rd.060 + rd.070 + rd.110 + rd.160 + rd.170 + rd.180)	190				

SITUAȚIA FLUXURILOR DE NUMERAR

de la pînă la

Anexa 4

Indicatori	Cod rd	Perioada de gestiune	
		precedentă	curentă
1	2	3	4
Fluxuri de numerar din activitatea operațională			
Încasări din vânzări	010		
Plăți pentru stocuri și servicii procurate	020		
Plăți către angajați și organe de asigurare socială și medicală	030		
Dobânzi plătite	040		
Plata impozitului pe venit	050		
Alte încasări	060		
Alte plăți	070		
Fluxul net de numerar din activitatea operațională (rd.010 - rd.020 - rd.030 - rd.040 - rd.050 + rd.060 - rd.070)	080		
Fluxuri de numerar din activitatea de investiții			
Încasări din vânzarea activelor imobilizate	090		
Plăți aferente intrărilor de active imobilizate	100		
Dobânzi încasate	110		
Dividende încasate	120		
inclusiv: dividende încasate din străinătate	121		

Alte încasări (plăți)	130		
Fluxul net de numerar din activitatea de investiții (rd.090 - rd.100 + rd.110 + rd.120 ± rd.130)	140		
Fluxuri de numerar din activitatea financiară			
Încasări sub formă de credite și împrumuturi	150		
Plăți aferente rambursării creditelor și împrumuturilor	160		
Dividende plătite	170		
inclusiv: dividende plătite nerezidenților	171		
Încasări din operațiuni de capital	180		
Alte încasări (plăți)	190		
Fluxul net de numerar din activitatea financiară (rd.150 - rd.160 - rd.170 + rd.180 ± rd.190)	200		
Fluxul net de numerar total (± rd.080 ± rd.140 ± rd.200)	210		
Diferențe de curs valutar favorabile (nefavorabile)	220		
Sold de numerar la începutul perioadei de gestiune	230		
Sold de numerar la sfârșitul perioadei de gestiune (± rd.210 ± rd.220 + rd.230)	240		

Documente atașate - Notă explicativă (fișierul pdf)

Recipisa

Respondent

Codul fiscal: 1010600028048, denumire: BIOSISTEM MLD S.R.L.

A prezentat raportul: RSF1_21

Pentru perioada fiscala: A/2023

Data prezentarii: 26.03.2024

Marca temporală a raportului înregistrat în Sistemul de Raportare Electronică și expediat pentru procesare în Sistemul Informațional al BNS : 26.03.2024 17:05:42

Recipisa 2

Respondent

Codul fiscal: 1010600028048, denumire: BIOSISTEM MLD S.R.L.

A prezentat raportul: RSF1_21

Pentru perioada fiscala: A/2023

Data prezentarii: 26.03.2024

Marca temporală a raportului înregistrat în Sistemul Informațional al BNS : 09.04.2024 09:26:11

Biroul Național de Statistică (BNS) a recepționat varianta electronică a raportului, expediat de DVs.
Urmează verificarea și validarea raportului de către specialistul BNS pe domeniu.



BioSystems

PRODUCT LIST



From Barcelona to your lab

Argentina · Brazil · Chile · France · India · Italy · Mexico · Philippines ·
Portugal · Romania · Russia · South Korea · Spain · Turkey · Thailand · USA



After almost 40 years, BioSystems - a group of 15 companies - is a reliable partner for laboratories over the 5 continents in the fields of **In-vitro Human and Veterinary Clinical Diagnostic, Food & Beverage Analysis and Monitoring of Bioprocesses.**

Today, the scientific advances in Biotech and Digital technologies drive BioSystems to focus on better understanding your needs and expectations and so provide **Analytical Solutions** to deliver the best **User Experience.**

BioSystems worldwide team of **Scientists, Engineers and Expert Professionals** devote their best efforts to continuously design and develop new solutions and improve existing ones.

I'm convinced that **working together**, we will **design** the best solutions to your future needs.

I invite you to explore [BioSystems Product List](#)



A handwritten signature in black ink that reads "P. Vila." with a horizontal line underneath.

Pau Vila Cases Ph.D
CEO
BioSystems

Summary

Clinical Chemistry	3
Biochemistry Reagents	4
Microcolumn Chromatography	13
Calibrators & Standards	14
Internal Controls	15
PREVECAL Clinical Chemistry	17
Instruments	18
Hematology	24
Analyzers	25
Coagulation	27
Reagents & Instruments	28
Autoimmunity	29
Immunofluorescence	30
ELISA	33
PREVECAL Autoimmunity	35
Instruments	36
Rapid Tests	39
Alphabetical Index	41

BioSystems S.A. reserves the right to change specifications without prior notice.

Icon guide, by profile

(Guide icons of most relevant profiles for clinical chemistry tests)



Cardiac



Renal



Liver



Pancreatic



Diabetes



Fertility



Hemostasis



Anemia



Lipids



Ions



Immune



Inflammatory



















Infectious

Clinical Chemistry



















Biochemistry reagents

Test	Code	RA	RB	mL/Kit	
α1-ACID GLYCOPROTEIN					
Immunoturbidimetric assay					
Multipurpose	31928	1 x 50 mL	-	50	
BA Dedicated	23107	1 x 60 mL	1 x 15 mL	75	
α-AMYLASE DIRECT					
Direct Substrate					
Multipurpose	11583	5 x 5 mL	-	25	
	11550	6 x 25 mL	-	150	
A15/A25 Dedicated	12550	5 x 20 mL	-	100	
BA Dedicated	21550	8 x 20 mL	-	160	
	23550	4 x 20 mL	-	80	
α-AMYLASE-EPS					
IFCC					
Multipurpose	11534	1 x 32 mL	1 x 8 mL	40	WR
BA Dedicated	21534	2 x 60 mL	2 x 15 mL	150	
A15/A25 Dedicated	12535	1 x 32 mL	1 x 8 mL	40	WR
α-AMYLASE PANCREATIC					
IFCC					
Multipurpose	11799	1 x 20 mL	1 x 5 mL	25	
A15/A25 Dedicated	12799	1 x 40 mL	1 x 10 mL	50	
BA Dedicated	21799	2 x 60 mL	2 x 15 mL	150	
ACID PHOSPHATASE (ACP)					
SFBC					
Multipurpose (Total)	11548	4 x 10 mL	lyophilized	40	WR
Multipurpose (Non Prostatic)	11548	2 x 10 mL	lyophilized	20	WR
ADENOSINE DEAMINASE (ADA)					
Adenosine-Glutamate Dehydrogenase					
A15/A25 Dedicated	12754	4 x 8 mL	1 x 10 mL	40	WR
BA Dedicated	23754	2 x 16 mL	1 x 10 mL	40	WR
ALANINE AMINOTRANSFERASE (ALT/GPT)					
IFCC					
Multipurpose	11832	1 x 40 mL	1 x 10 mL	50	WR
	11533	1 x 160 mL	1 x 40 mL	200	WR
	11568	1 x 400 mL	1 x 100 mL	500	WR
	11562	1 x 800 mL	1 x 200 mL	1000	WR
A15/A25 Dedicated	12533	5 x 40 mL	5 x 10 mL	250	WR
BA Dedicated	21533	8 x 60 mL	8 x 15 mL	600	
	23533	4 x 60 mL	4 x 15 mL	300	
Pyridoxal Phosphate (AUX)	11666	1 x 5 mL			
ALBUMIN					
Bromocresol Green					
Multipurpose	11573	1 x 250 mL	-	250	Std Inc
	11547	2 x 250 mL	-	500	Std Inc
A15/A25 Dedicated	12547	5 x 50 mL	-	250	
BA Dedicated	21547	10 x 60 mL	-	600	
	23547	4 x 60 mL	-	240	
ALBUMIN (MICROALBUMINURIA)					
Immunoturbidimetric latex assay					
Multipurpose	31324	1 x 16 mL	1 x 4 mL	20	WR
	31924	1 x 40 mL	1 x 10 mL	50	WR
A15/A25 Dedicated	13324	1 x 40 mL	1 x 10 mL	50	WR
BA Dedicated	22324	4 x 60 mL	4 x 15 mL	300	
	23324	1 x 60 mL	1 x 15 mL	75	

Test	Code	RA	RB	mL/Kit	
ALKALINE PHOSPHATASE (ALP)-AMP AMP Buffer (IFCC)	 				
Multipurpose	11592	1 x 40 mL	1 x 10 mL	50	WR
	11593	1 x 160 mL	1 x 40 mL	200	WR
	11598	4 x 100 mL	2 x 50 mL	500	WR
A15/A25 Dedicated	12518	5 x 16 mL	2 x 10 mL	100	WR
BA Dedicated	21592	4 x 60 mL	4 x 15 mL	300	
	23592	1 x 60 mL	1 x 15 mL	75	
ALKALINE PHOSPHATASE (ALP)-DEA DEA Buffer	 				
Multipurpose	11590	1 x 40 mL	1 x 10 mL	50	WR
	11591	4 x 40 mL	4 x 10 mL	200	WR
	11597	4 x 100 mL	2 x 50 mL	500	WR
A15/A25 Dedicated	12514	5 x 16 mL	2 x 10 mL	100	WR
BA Dedicated	21590	4 x 60 mL	4 x 15 mL	300	
	23590	1 x 60 mL	1 x 15 mL	75	
AMMONIA Glutamate Dehydrogenase	  				
A15/A25 Dedicated	12532	1 x 20 mL	1 x 7 mL	27	RA
BA Dedicated	23532	1 x 20 mL	1 x 7 mL	27	RA
ANGIOTENSIN CONVERTING ENZYME (ACE) FAPGG					
A15/A25 Dedicated	12796	1 x 50 mL	-	50	
BA Dedicated	21796	2 x 60 mL	-	120	
ANTI-STREPTOLYSIN O (ASO) Immunoturbidimetric latex assay	 				
Multipurpose	31323	1 x 16 mL	1 x 4 mL	20	WR
	31923	1 x 40 mL	1 x 10 mL	50	WR
	31031	2 x 160 mL	2 x 40 mL	400	WR
A15/A25 Dedicated	13923	1 x 40 mL	1 x 10 mL	50	WR
BA Dedicated	22923	2 x 60 mL	2 x 15 mL	150	
	23923	1 x 60 mL	1 x 15 mL	75	
ANTITHROMBIN III Immunoturbidimetric assay					
Multipurpose	31936	1 x 40 mL	1 x 10 mL	50	
A15/A25 Dedicated	13936	1 x 40 mL	1 x 10 mL	50	
BA Dedicated	22936	2 x 60 mL	2 x 15 mL	150	
	23936	1 x 60 mL	1 x 15 mL	75	
APOLIPOPROTEIN A-1 (APO A-1) Immunoturbidimetric assay	 				
Multipurpose	31095	1 x 40 mL	1 x 10 mL	50	
BA Dedicated	23095	1 x 60 mL	1 x 15 mL	75	
APOLIPOPROTEIN B (APO B) Immunoturbidimetric assay	 				
Multipurpose	31098	1 x 40 mL	1 x 10 mL	50	
BA Dedicated	23098	1 x 60 mL	1 x 15 mL	75	
ASPARTATE AMINOTRANSFERASE (AST/GOT) IFCC					
Multipurpose	11830	1 x 40 mL	1 x 10 mL	50	WR
	11531	1 x 160 mL	1 x 40 mL	200	WR
	11567	1 x 400 mL	1 x 100 mL	500	WR
	11561	1 x 800 mL	1 x 200 mL	1000	WR
A15/A25 Dedicated	12531	5 x 40 mL	5 x 10 mL	250	WR
BA Dedicated	21531	8 x 60 mL	8 x 15 mL	600	
	23531	4 x 60 mL	4 x 15 mL	300	
Pyridoxal Phosphate (AUX)	11666	1 x 5 mL			

Biochemistry reagents











Test	Code	RA	RB	mL/Kit	
β2-MICROGLOBULIN					
Immunoturbidimetric latex assay					
Multipurpose	31920	1 x 800 mL	1 x 200 mL	1000	WR
	31925	1 x 40 mL	1 x 10 mL	50	WR
BA Dedicated	22925	2 x 60 mL	2 x 15 mL	150	
	23925	1 x 60 mL	1 x 15 mL	75	
β-HYDROXYBUTYRATE					
Hydroxybutyrate Dehydrogenase/Diaphorase					
A15/A25 Dedicated	12525	1 x 40 mL	1 x 10 mL	50	
BA Dedicated	21525	1 x 60 mL	1 x 15 mL	75	
BILIRUBIN (DIRECT)					
Diazotized Sulfanilic					
Multipurpose	11511	4 x 40 mL	4 x 10 mL	200	WR
	11545	2 x 400 mL	2 x 100 mL	1000	WR
BILIRUBIN (DIRECT) DPD					
Dichlorophenyl Diazonium					
A15/A25 Dedicated	12504	5 x 40 mL	5 x 10 mL	250	
BA Dedicated	21504	4 x 60 mL	4 x 15 mL	300	
	23504	1 x 60 mL	1 x 15 mL	75	
BILIRUBIN (TOTAL)					
Diazotized Sulfanilic					
Multipurpose	11510	4 x 40 mL	4 x 10 mL	200	WR
	11544	2 x 400 mL	2 x 100 mL	1000	WR
BILIRUBIN (TOTAL) DPD					
Dichlorophenyl Diazonium					
A15/A25 Dedicated	12506	5 x 40 mL	5 x 10 mL	250	
BA Dedicated	21506	8 x 60 mL	8 x 15 mL	600	
	23506	4 x 60 mL	4 x 15 mL	300	
BILIRUBIN (TOTAL AND DIRECT)					
Diazotized Sulfanilic					
Multipurpose	11515	2 x 50 mL	2 x 50 mL	200	WR
	11555	1 x 500 mL	1 x 500 mL	1000	WR
CALCIUM-ARSENAZO					
Arsenazo III					
Multipurpose	11570	1 x 200 mL	-	200	Std Inc
	11571	1 x 500 mL	-	500	Std Inc
A15/A25 Dedicated	12570	10 x 50 mL	-	500	
BA Dedicated	21570	10 x 60 mL	-	600	
	23570	4 x 60 mL	-	240	
CALCIUM-CRESOLPHTHALEIN					
O-Cresolphthalein Complexone					
Multipurpose	11811	1 x 160 mL	1 x 40 mL	200	Std Inc, WR
	11812	1 x 400 mL	2 x 50 mL	500	Std Inc, WR
A15/A25 Dedicated	12513	5 x 40 mL	5 x 10 mL	250	
BA Dedicated	21511	8 x 60 mL	8 x 15 mL	600	
	23511	2 x 60 mL	2 x 15 mL	150	
CALCIUM-MTB					
Metihylthymol Blue					
Multipurpose	11527	2 x 50 mL	2 x 50 mL	200	Std Inc, WR
	11507	1 x 250 mL	1 x 250 mL	500	Std Inc, WR
CARBON DIOXIDE (CO₂)					
Phosphoenolpyruvate Carboxylase/ Malate Dehydrogenase					
Multipurpose	11827	1 x 200 mL	-	200	
A15/A25 Dedicated	11558	1 x 50 mL	-	50	
BA Dedicated	21558	2 x 60 mL	-	120	

Test	Code	RA	RB	mL/Kit	
CHOLESTEROL					
Cholesterol Oxidase/Peroxidase					
 					
Multipurpose	11805	1 x 50 mL	-	50	Std Inc
	11505	1 x 200 mL	-	200	Std Inc
	11506	1 x 500 mL	-	500	Std Inc
	11539	1 x 1000 mL	-	1000	Std Inc
A15/A25 Dedicated	12505	10 x 50 mL	-	500	
BA Dedicated	21505	10 x 60 mL	-	600	
	23505	4 x 60 mL	-	240	
CHOLESTEROL LDL DIRECT					
Detergent					
 					
Multipurpose	11585	1 x 60 mL	1 x 20 mL	80	
A15/A25 Dedicated	12585	3 x 20 mL	1 x 20 mL	80	
BA Dedicated	21585	2 x 60 mL	2 x 20 mL	160	
	23585	1 x 60 mL	1 x 20 mL	80	
CHOLESTEROL HDL DIRECT					
Detergent					
 					
Multipurpose	11557	1 x 60 mL	1 x 20 mL	80	
A15/A25 Dedicated	12557	3 x 20 mL	1 x 20 mL	80	
BA Dedicated	21557	2 x 60 mL	2 x 20 mL	160	
	23557	1 x 60 mL	1 x 20 mL	80	
CHOLESTEROL HDL					
Phosphotungstate/ Mg+2-Cholesterol Oxidase/ Peroxidase Reagent + Precipitant					
 					
Multipurpose	11523	2 x 50 mL	2 x 50 mL	200	Std Inc
CHOLESTEROL HDL PRECIPITATING REAGENT					
Phosphotungstate/ Mg+2 Precipitant					
 					
Multipurpose	11648	1 x 50 mL	-	50	Std Inc
CHOLESTEROL LDL PRECIPITATING REAGENT					
Polyvinyl Sulphate/ Polyethyleneglycol Precipitant					
 					
Multipurpose	11579	1 x 20 mL	-	20	
CHOLINESTERASE (CHE)					
Butyrylthiocholine					
					
Multipurpose	11588	1 x 40 mL	1 x 10 mL	50	WR
	11589	4 x 40 mL	4 x 10 mL	200	WR
A15/A25 Dedicated	12588	1 x 40 mL	1 x 10 mL	50	WR
BA Dedicated	21588	2 x 60 mL	2 x 15 mL	150	
CITRATE					
Citrate Lyase/ Malate Dehydrogenase					
					
A15/A25 Dedicated	11895	1 x 20 mL	1 x 5 mL	25	RB + Std Inc
	11795	2 x 20 mL	2 x 5 mL	50	RB + Std Inc
BA Dedicated	23795	2 x 20 mL	2 x 5 mL	50	RB + Std Inc
COMPLEMENT COMPONENT C3					
Immunoturbidimetric assay					
					
Multipurpose	31084	1 x 20 mL	-	20	
	31073	1 x 50 mL	-	50	
	31079	1 x 250 mL	-	250	
A15/A25 Dedicated	13084	1 x 50 mL	-	50	
BA Dedicated	23103	1 x 60 mL	1 x 15 mL	75	
COMPLEMENT COMPONENT C4					
Immunoturbidimetric assay					
					
Multipurpose	31085	1 x 20 mL	-	20	
	31074	1 x 50 mL	-	50	
	31080	1 x 250 mL	-	250	
A15/A25 Dedicated	13085	1 x 50 mL	-	50	
BA Dedicated	23104	1 x 60 mL	1 x 15 mL	75	

Biochemistry reagents



















Test	Code	RA	RB	mL/Kit	
C-REACTIVE PROTEIN (CRP)					
Immunoturbidimetric latex assay					
Multipurpose	31321	1 x 16 mL	1 x 4 mL	20	WR
	31921	1 x 40 mL	1 x 10 mL	50	WR
	31029	2 x 160 mL	2 x 40 mL	400	WR
A15/A25 Dedicated	13921	2 x 40 mL	2 x 10 mL	100	WR
BA Dedicated	22921	4 x 60 mL	4 x 15 mL	300	
	23921	1 x 60 mL	1 x 15 mL	75	
C-REACTIVE PROTEIN hs (CRP-hs)					
Immunoturbidimetric latex assay, High Sensitivity					
Multipurpose	31927	1 x 40 mL	1 x 10 mL	50	WR
A15/A25 Dedicated	13927	1 x 40 mL	1 x 10 mL	50	WR
BA Dedicated	22927	2 x 60 mL	2 x 15 mL	150	
	23927	1 x 60 mL	1 x 15 mL	75	
C-REACTIVE PROTEIN-er (CRP-er)					
Immunoturbidimetric latex assay, Extended Range					
BA Dedicated	22942	2 x 60 mL	2 x 15 mL	150	
	23942	1 x 60 mL	1 x 15 mL	75	
CREATINE KINASE (CK)					
IFCC					
Multipurpose	11790	1 x 40 mL	1 x 10 mL	50	WR
	11791	4 x 40 mL	4 x 10 mL	200	WR
A15/A25 Dedicated	12524	3 x 12 mL	1 x 10 mL	45	WR
BA Dedicated	21790	2 x 60 mL	2 x 15 mL	150	
	23790	1 x 60 mL	1 x 15 mL	75	
CREATINE KINASE-MB (CK-MB)					
Immunoinhibition					
Multipurpose	11792	1 x 40 mL	1 x 10 mL	50	WR
A15/A25 Dedicated	12566	3 x 12 mL	1 x 10 mL	45	WR
BA Dedicated	21792	2 x 60 mL	2 x 15 mL	150	
	23792	1 x 60 mL	1 x 15 mL	75	
CREATININE					
Jaffé-compensated					
Multipurpose	11802	1 x 50 mL	1 x 50 mL	100	Std Inc, WR
	11502	2 x 50 mL	2 x 50 mL	200	Std Inc, WR
	11542	1 x 500 mL	1 x 500 mL	1000	Std Inc, WR
A15/A25 Dedicated	12502	5 x 50 mL	5 x 50 mL	500	WR
BA Dedicated	21502	5 x 60 mL	5 x 60 mL	600	
	23502	5 x 20 mL	5 x 20 mL	200	
CREATININE ENZYMATIC					
Enzymatic					
Multipurpose	11734	1 x 60 mL	1 x 20 mL	80	Std Inc
A15/A25 Dedicated	12734	1 x 45 mL	1 x 15 mL	60	
BA Dedicated	21734	2 x 60 mL	2 x 20 mL	160	
D-DIMER					
Phosphoenolpyruvate Carboxylase/Malate					
BA Dedicated	21519	1 x 40 mL	1 x 10 mL	50	
ETHANOL					
Alcohol Dehydrogenase					
A15/A25 Dedicated	12789	1 x 20 mL	1 x 7 mL	27	
BA Dedicated	21789	2 x 20 mL	2 x 7 mL	54	
FERRITIN					
Immunoturbidimetric latex assay					
Multipurpose	31934	1 x 10 mL	1 x 5 mL	15	WR
	31935	1 x 30 mL	1 x 15 mL	45	WR
A15/A25 Dedicated	13934	1 x 30 mL	1 x 15 mL	45	WR
BA Dedicated	22934	2 x 40 mL	2 x 20 mL	120	
	23934	1 x 40 mL	1 x 20 mL	60	

NEW

Test	Code	RA	RB	mL/Kit	
FIBRINOGEN					
Immunoturbidimetric assay 					
Multipurpose	31600	1 x 40 mL	1 x 10 mL	50	
A15/A25 Dedicated	13600	1 x 40 mL	1 x 10 mL	50	
BA Dedicated	22804	2 x 60 mL	2 x 15 mL	150	
	23804	1 x 60 mL	1 x 15 mL	75	
FRUCTOSAMINE					
NBT 					
Multipurpose	11046	2 x 50 mL	-	100	Std Inc
FRUCTOSE					
Hexokinase/ Phosphoglucose Isomerase 					
A15/A25 Dedicated	11794	1 x 40 mL	1 x 10 mL	50	Std Inc, WR
BA Dedicated	23794	1 x 60 mL	1 x 15 mL	75	Std Inc
γ-GLUTAMYL TRANSFERASE (γ-GT)					
IFCC 					
Multipurpose	11584	1 x 40 mL	1 x 10 mL	50	WR
	11520	1 x 160 mL	1 x 40 mL	200	WR
A15/A25 Dedicated	12520	5 x 40 mL	5 x 10 mL	250	WR
BA Dedicated	21520	4 x 60 mL	4 x 15 mL	300	
	23520	2 x 60 mL	2 x 15 mL	150	
GLUCOSE					
Glucose Oxidase/ Peroxidase  					
Multipurpose	11803	1 x 50 mL	-	50	Std Inc
	11503	1 x 200 mL	-	200	Std Inc
	11504	1 x 500 mL	-	500	Std Inc
	11538	1 x 1000 mL	-	1000	Std Inc
A15/A25 Dedicated	12503	10 x 50 mL	-	500	
BA Dedicated	21503	10 x 60 mL	-	600	
	23503	4 x 60 mL	-	240	
GLUCOSE-HEXOKINASE					
Hexokinase  					
Multipurpose	11656	1 x 160 mL	1 x 40 mL	200	Std Inc, WR
A15/A25 Dedicated	12756	2 x 40 mL	2 x 10 mL	100	
BA Dedicated	21656	4 x 60 mL	4 x 15 mL	300	
	23656	1 x 60 mL	1 x 15 mL	75	
HEMOGLOBIN A1C-DIRECT (HbA1C-DIR)					
Immunoturbidimetric latex assay 					
Multipurpose	31047	1 x 50 mL	1 x 10 mL	60	
A15/A25 Dedicated	13047	1 x 50 mL	1 x 10 mL	60	
BA Dedicated	22047	2 x 60 mL	2 x 12 mL	144	
	22147	1 x 60 mL	1 x 12 mL	72	
HOMOCYSTEINE					
Enzymatic Cycling 					
A15/A25 Dedicated	12737	1 x 40 mL	1 x 10.8 mL	50.8	
BA Dedicated	21737	1 x 60 mL	1 x 16.2 mL	76.2	
	23737	1 x 20 mL	1 x 5.4 mL	25.4	
IMMUNOGLOBULIN A (IgA)					
Immunoturbidimetric assay 					
Multipurpose	31082	1 x 20 mL	-	30	
	31071	1 x 50 mL	-	50	
	31077	1 x 250 mL	-	250	
A15/A25 Dedicated	13082	1 x 50 mL	-	50	
BA Dedicated	23101	1 x 60 mL	1 x 15 mL	75	









NGSP
Certified Method

Biochemistry reagents

Test	Code	RA	RB	mL/Kit	
IMMUNOGLOBULIN G (IgG) Immunoturbidimetric assay					
Multipurpose	31081	1 x 20 mL	-	20	
	31070	1 x 50 mL	-	50	
	31076	1 x 250 mL	-	250	
A15/A25 Dedicated	13081	1 x 50 mL	-	50	
BA Dedicated	23100	1 x 60 mL	1 x 15 mL	75	
IMMUNOGLOBULIN M (IgM) Immunoturbidimetric assay					
Multipurpose	31083	1 x 20 mL	-	20	
	31072	1 x 50 mL	-	50	
	31078	1 x 250 mL	-	250	
A15/A25 Dedicated	13083	1 x 50 mL	-	50	
BA Dedicated	23102	1 x 60 mL	1 x 15 mL	75	
IRON-CHROMAZUROL Chromazurol B	 				
Multipurpose	11546	4 x 50 mL	-	200	Std Inc
IRON-FERROZINE Ferrozine	 				
Multipurpose	11509	4 x 40 mL	4 x 10 mL	200	Std Inc, WR
A15/A25 Dedicated	12509	5 x 40 mL	5 x 10 mL	250	
BA Dedicated	21509	4 x 60 mL	4 x 15 mL	300	
	23509	2 x 60 mL	2 x 15 mL	150	
KAPPA Immunoturbidimetric assay	 				
Multipurpose	31216	1x16mL	1x4mL	20mL	
A15/A25 Dedicated	13216	1x40mL	1x10mL	50mL	
BA Dedicated	22216	1x10mL	1x10mL	50mL	
LAMBDA Immunoturbidimetric assay	 				
Multipurpose	31217	1x16mL	1x4mL	20mL	
A15/A25 Dedicated	13217	1x40mL	1x10mL	50mL	
BA Dedicated	22217	1x10mL	1x10mL	50mL	
LACTATE Lactate Oxidase/ Peroxidase					
Multipurpose	11736	1 x 40 mL	1 x 10 mL	50	WR
A15/A25 Dedicated	12736	2 x 40 mL	2 x 10 mL	100	
BA Dedicated	21736	4 x 60 mL	4 x 15 mL	300	
	23736	1 x 60 mL	1 x 15 mL	75	
LACTATE DEHYDROGENASE (LDH) Pyruvate	  				
Multipurpose	11580	1 x 40 mL	1 x 10 mL	50	WR
	11581	1 x 160 mL	1 x 40 mL	200	WR
A15/A25 Dedicated	12580	5 x 40 mL	5 x 10 mL	250	WR
BA Dedicated	21580	8 x 60 mL	8 x 15 mL	600	
	23580	4 x 60 mL	4 x 15 mL	300	
LACTATE DEHYDROGENASE (LDH)-IFCC IFCC	  				
Multipurpose	11587	1 x 160 mL	1 x 40 mL	200	WR
A15/A25 Dedicated	11586	1 x 40 mL	1 x 10 mL	50	WR
BA Dedicated	21586	8 x 60 mL	8 x 15 mL	600	
	23586	2 x 60 mL	2 x 15 mL	150	
LIPASE Color					
Multipurpose	11793	1 x 50 mL	1 x 10 mL	60	Std Inc
A15/A25 Dedicated	12793	2 x 20 mL	1 x 8 mL	48	
BA Dedicated	23793	1 x 50 mL	1 x 10 mL	60	

Test	Code	RA	RB	mL/Kit	
MAGNESIUM					
Xylidyl Blue					
Multipurpose	11797	4 x 40 mL	4 x 10 mL	200	Std Inc, WR
A15/A25 Dedicated	12797	5 x 16 mL	2 x 10 mL	100	WR
BA Dedicated	21797	2 x 60 mL	2 x 15 mL	150	
	23797	1 x 60 mL	1 x 15 mL	75	
OXALATE					
Oxalate Oxidase/ Peroxidase					
A15/A25 Dedicated	12539	1 x 20 mL	1 x 5 mL	25 (20 tubes)	Std Inc, RB
Pretreatment Reagents	11839	-	-	100 tubes	
BA Dedicated (w/o tubes)	23539	1 x 20 mL	1 x 5 mL	25	Std Inc, RB
PHOSPHORUS					
Phosphomolybdate/ UV					
Multipurpose	11508	3 x 40 mL	1 x 50 mL	170	Std Inc, WR
A15/A25 Dedicated	12508	3 x 24 mL	2 x 15 mL	100	
BA Dedicated	21518	4 x 50 mL	4 x 20 mL	280	
	23518	1 x 50 mL	1 x 20 mL	70	
PREALBUMIN					
Immunoturbidimetric assay					
Multipurpose	31929	1 x 50 mL	-	50	
BA Dedicated	23106	1 x 60 mL	1 x 15 mL	75	
PROTEIN (TOTAL)					
Biuret					
Multipurpose	11800	1 x 50 mL	-	50	Std Inc
	11572	1 x 250 mL	-	250	Std Inc
	11500	2 x 250 mL	-	500	Std Inc
	11553	1 x 1000 mL	-	1000	Std Inc
A15/A25 Dedicated	12500	10 x 50 mL	-	500	
BA Dedicated	21513	2 x 60 mL	2 x 20 mL	160	
	23513	1 x 60 mL	1 x 20 mL	80	
PROTEIN (URINE+CSF)					
Pyrogallol Red					
Multipurpose	11501	4 x 50 mL	-	200	Std Inc
	11559	2 x 250 mL	-	500	Std Inc
A15/A25 Dedicated	12501	5 x 50 mL	-	250	Std Inc
BA Dedicated	21512	8 x 20 mL	-	160	
	23512	4 x 20 mL	-	80	
RHEUMATOID FACTORS (RF)					
Immunoturbidimetric latex assay					
Multipurpose	31322	1 x 16 mL	1 x 4 mL	20	
	31922	1 x 40 mL	1 x 10 mL	50	
	31030	2 x 160 mL	2 x 40 mL	400	
A15/A25 Dedicated	13922	1 x 40 mL	1 x 10 mL	50	
BA Dedicated	22922	4 x 60 mL	4 x 15 mL	300	
	23922	1 x 60 mL	1 x 15 mL	75	
TOTAL BILE ACIDS					
Enzymatic Cycling					
A15/A25 Dedicated	12551	1 x 18 mL	1 x 6 mL	24	Std Inc
BA Dedicated	21551	2 x 60 mL	2 x 20 mL	160	
	23551	1 x 60 mL	1 x 20 mL	80	
TOTAL IRON BINDING CAPACITY (TIBC)					
Fe3+ / Magnesium Hydroxide Carbonate Precipitating					
Multipurpose	11554	50 mL	3 g	50	

Biochemistry reagents

Test	Code	RA	RB	mL/Kit	
TRANSFERRIN					
Immunoturbidimetric assay					
Multipurpose	 31091	1 x 20 mL	-	20	
	31092	1 x 50 mL	-	50	
	31093	1 x 250 mL	-	250	
A15/A25 Dedicated	13091	1 x 50 mL	-	50	
BA Dedicated	22105	2 x 60 mL	2 x 15 mL	150	
	23105	1 x 60 mL	1 x 15 mL	75	
TRIGLYCERIDES					
Glycerol Phosphate Oxidase/ Peroxidase					
Multipurpose	  11828	1 x 50 mL	-	50	Std Inc
	11528	4 x 50 mL	-	200	Std Inc
	11529	2 x 250 mL	-	500	Std Inc
A15/A25 Dedicated	12528	10 x 50 mL	-	500	
BA Dedicated	21528	10 x 60 mL	-	600	
	23528	4 x 60 mL	-	240	
UNSATURATED IRON BINDING CAPACITY (UIBC)					
Ferrozine					
Multipurpose	11835	1 x 40 mL	1 x 10 mL	50	
A15/A25 Dedicated	12835	1 x 40 mL	1 x 10 mL	50	
BA Dedicated	21835	2 x 60 mL	2 x 15 mL	150	
UREA/ BUN-COLOR					
Urease/ Salicylate					
Multipurpose	 11536	2 x 50 mL	2 x 50 mL	200	Std Inc, RA
	11537	1 x 250 mL	1 x 250 mL	500	Std Inc, RA
UREA/ BUN-UV					
Urease/ Glutamate Dehydrogenase					
Multipurpose	 11516	4 x 40 mL	4 x 10 mL	200	Std Inc, WR
	11517	2 x 200 mL	2 x 50 mL	500	Std Inc, WR
	11541	1 x 800 mL	1 x 200 mL	1000	Std Inc, WR
A15/A25 Dedicated	12516	5 x 40 mL	5 x 10 mL	250	WR
BA Dedicated	21516	8 x 60 mL	8 x 15 mL	600	
	23516	4 x 60 mL	4 x 15 mL	300	
URIC ACID					
Uricase/Peroxidase					
Multipurpose	 11821	1 x 50 mL	-	50	Std Inc
	11521	1 x 200 mL	-	200	Std Inc
	11522	1 x 500 mL	-	500	Std Inc
	11540	1 x 1000 mL	-	1000	Std Inc
A15/A25 Dedicated	12521	10 x 50 mL	-	500	
BA Dedicated	21521	10 x 60 mL	-	600	
	23521	4 x 60 mL	-	240	
ZINC					
Bromo-PAPS					
A15/A25 Dedicated	  12526	2 x 20 mL	1 x 10 mL	50	Std Inc, RA

Microcolumn Chromatography

Code	Quantity	Comments
5-AMINOLEVULINIC ACID (ALA)/ PORPHOBILINOGEN (PBG) 11017	40 tests	EHRlich REAGENT ALA Standard included
HEMOGLOBIN A2 11077	20 tests	ION EXCHANGE
5-HYDROXYINDOLEACETIC ACID (5-HIAA) 11010	40 tests	NITROSE NAFTOL Standard included
17-HYDROXYCORTICOSTEROIDS (17-OH) 11006	40 tests	PORTER-SILBER Standard included
17-KETOSTEROIDS 11002	40 tests	ZIMMERMANN Standard included
METANEPHRINES 11022	40 tests	PISANO Standard included
VANILMANDELIC ACID 11003	20 tests	PERIODATE Standard included



Calibrators & Standards

Code	Quantity	Components
ADENOSINE DEAMINASE (ADA) 18052	1 x 1 mL	Adenosine Deaminase (ADA)
ALBUMIN (MICROALBUMINURIA) 31130	1 x 1 mL	Albumin (Microalbuminuria)
AMMONIA, ETHANOL, CO2 18065	2 x 5 mL	Ammonia, Ethanol, Carbon Dioxide
ANTI-STREPTOLYSIN O (ASO) 31119	1 x 1 mL	Anti-Streptolysin O (ASO)
APOLIPOPROTEIN A-I 31100	1 x 1 mL	Apolipoprotein A-I
APOLIPOPROTEIN B 31200	1 x 1 mL	Apolipoprotein B
β2-MICROGLOBULIN 31122	1 x 1 mL	β2-Microglobulin
BIOCHEMISTRY (BOVINE) 18011	5 x 5 mL	ACE, ACP, Albumin, ALP, ALT/GPT, AST/GOT, α-Amylase, β-hydroxybutyrate, Total Bilirubin, Calcium, Cholesterol, Chloride, CK, Creatinine, Direct Bilirubin, Iron, Lactate, LDH, Lipase, Glucose, γ-GT, Magnesium, Phosphorus, Potassium, Sodium, Total Bile Acids, Total Protein, Triglycerides, UIBC, Urea, Uric acid, and Zinc.
BIOCHEMISTRY (HUMAN) 18044	5 x 5 mL	ACE, ACP, Albumin, ALP, ALT/GPT, AST/GOT, α-Amylase, α-Amylase Pancreatic, β-hydroxybutyrate, Direct Bilirubin, Direct HDL-Cholesterol, Direct LDL-Cholesterol, Total Bilirubin, Creatinine, Calcium, Chloride, CK, γ-GT, Cholesterol, Lactate, LDH, Lipase, Cholinesterase, Glucose, Iron, Triglycerides, Magnesium, Phosphorus, Potassium, Total Protein, Sodium, UIBC, Urea, Uric acid, and Zinc.
BILIRUBIN 11513	1 x 5 mL	Bilirubin
CHOLESTEROL HDL/LDL 11693	1 x 1 mL	HDL Cholesterol Direct/ LDL Cholesterol Direct
CREATININE KINASE-MB (CK-MB) 11824	1 x 1 mL	CK-MB
C-REACTIVE PROTEIN (CRP/CRP-hs) 31113	1 x 1 mL 1 x 5 mL	CRP CRP-hs
C-REACTIVE PROTEIN (CRP-er) 31182	1 x 3 mL	CRP-er
D-DIMER 18077	1 x 3 mL	D-Dimer
FERRITIN 31127	1 x 3 mL	Ferritin
FIBRINOGEN 31601	1 x 1 mL	Fibrinogen

NEW

Code	Quantity	Components
HbA1C-DIRECT 31048	4 x 0.5 mL	HbA1C
HOMOCYSTEINE 11750	5 x 1 mL	Homocysteine
KAPPA/LAMBDA CALIBRATOR 18070	5 x 1 mL	Kappa Light Chains and Lamda Light Chains
PROTEIN 31075	5 x 1 mL	Set of five Levels. α1-Acid Glycoprotein, Antithrombin III, IgA, IgG, IgM, Complement C3 and C4, Prealbumin and Transferrin.
PROTEIN (URINE) 11603	1 x 5 mL	Protein (Urine)
RHEUMATOID FACTORS (RF) 31116	1 x 3 mL	Rheumatoid Factor (RF)

Internal Controls

Code	Quantity	Components
ADA 18048	2 x 1 mL	LEVEL I and II Adenosine Deaminase
AMMONIA, ETHANOL, CO2 18063	3 x 5 mL	LEVEL I Ammonia, Ethanol, Carbon Dioxide
18064	3 x 5 mL	LEVEL II
BIOCHEMISTRY SERUM 18009	5 x 5 mL	LEVEL I ACE, ACP, Albumin, ALP, ALT/GPT, AST/GOT,
18005	20 x 5 mL	α-Amylase, β-hydroxybutyrate, Direct and Total
18010	5 x 5 mL	LEVEL II Bilirubin, , Calcium, Chloride, Cholesterol, HDL-
18007	20 x 5 mL	Cholesterol, CK, Creatinine, Glucose, γ-GT, Iron, LDH, Lactate, Lipase, Magnesium, Phosphorus, Potassium, Protein Total, Sodium, Total Bile Acids, Triglycerides, UIBC, Urea, Uric acid and Zinc.
BIOCHEMISTRY SERUM (HUMAN) 18042	5 x 5 mL	LEVEL I ACE, ACP, Albumin, ALP, ALT/GPT, AST/GOT,
18043	5 x 5 mL	LEVEL II α-Amylase, α-Amylase Pancreatic, β-hydroxybutyrate, Direct and Total Bilirubin, Calcium, Chloride, Cholesterol, Direct Cholesterol-HDL, Direct Cholesterol-LDL, Cholinesterase, CK, Creatinine, Glucose, γ-GT, Iron, Lactate, LDH, Lipase, Magnesium, Phosphorus, Potassium, Protein total, Sodium, Triglycerides, UIBC, Urea, Uric acid and Zinc.
BIOCHEMISTRY URINE 18054	1 x 5 mL	LEVEL I Albumin, α-Amylase, α-Amylase Pancreatic,
18066	1 x 5 mL	LEVEL II Calcium, Chloride, Citrate, Creatinine, Glucose, Magnesium, Phosphorus, Potassium, Protein urine, Sodium, Urea and Uric acid.

Controls

Code	Quantity	Components	
β2-MICROGLOBULIN			
31592	2 x 1 mL	LEVEL I and II	β2-Microglobulin
β2-MICROGLOBULIN URINE			
31215	1 x 3 mL		β2-Microglobulin
CREATININE KINASE-MB			
18024	1 x 1 mL	LEVEL I	CK, and CK-MB
18061	1 x 1 mL	LEVEL II	
CONTROL URINE			
18036	1 x 20 mL		Albumin, 5-Aminolevulinic Acid
18037	10 x 20 mL		(ALA), 5-Hydroxyindolacetic acid, 17-Hydroxycorticosteroids, 17-Ketosteroids, Metanephrines, Protein and Vanilmandelic acid.
D-DIMER			
18078	2 x 1 mL	LEVEL I and II	D-Dimer
FERTILITY BIOCHEMISTRY			
18053	1 x 1 mL		Citrate, Fructose and Zinc
FIBRINOGEN			
31602	1 x 1 mL		Fibrinogen
FRUCTOSAMINE			
18057	1 x 1 mL		Fructosamine
HEMOGLOBIN A1C			
18001	1 x 0.5 mL	NORMAL	HbA1c Direct turbidimetry
18002	1 x 0.5 mL	ELEVATED	
HEMOGLOBIN A2			
10011	1 x 0.5 mL	ELEVATED	HbA2 Chromatography
HOMOCYSTEINE			
18058	1 x 1 mL	LEVEL I	Homocysteine
18059	1 x 1 mL	LEVEL II	
LIPID SERUM			
18040	3 x 1 mL	LEVEL I	Apolipoprotein A-I, Apolipoprotein B, Cholesterol, Cholesterol-HDL, Cholesterol-LDL and Triglycerides
18041	3 x 1 mL	LEVEL II	
OXALATE URINE			
18080	1 x 5 mL	LEVEL I	Oxalate
18041	1 x 5 mL	LEVEL II	
PROTEIN SERUM			
31211	3 x 1 mL	LEVEL I	α1-Acid Glycoprotein, Antithrombin III, Complement C3 and C4, C-Reactive Protein-hs, Ferritin, IgA, IgG, IgM, Prealbumin, Transferrin, Kappa Light Chains and Lambda Light Chains
31212	3 x 1 mL	LEVEL II	
RHEUMATOID SERUM			
31213	3 x 1 mL	LEVEL I	Anti-Streptolysin O, C-Reactive Protein, Rheumatoid Factors, CRPer
31214	3 x 1 mL	LEVEL II	

External Quality Control

PREVECAL

www.prevecal.net

International External Quality Assessment Scheme

- ▶ Yearly program for the comparison of results between laboratories.
- ▶ Monthly measurements of different control materials
- ▶ The final report summarises all monthly reports and shows additional data on performance and capability
- ▶ 6-sigma quality management for the assessment for each measurement procedure of the laboratory
- ▶ On-line participation through www.prevecal.net
- ▶ Accredited by ISO 17043

Clinical Chemistry

Code	Quantity	Components
PREVECAL BIOCHEMISTRY (BOVINE)		
18027	12 x 5 mL	ACP, Albumin, ALP, ALT/GPT, AST/GOT, α-Amylase, Total Bilirubin, Calcium, Chloride, Cholesterol, HDL-Cholesterol, Cholinesterase, CK, Creatinine, Glucose, γ-GT, Iron, Lactate LDH, Lipase, Magnesium, Phosphorus, Potassium, Proteins, Sodium, Triglycerides, Urea and Uric acid.
PREVECAL BIOCHEMISTRY HUMAN		
18045	12 x 5 mL	ALT, Albumin, α-Amylase, α-Amylase Pancreatic, AST, Direct and Total Bilirubin, Calcium, (human sera) Chloride, Cholesterol, Cholinesterase, HDL-Cholesterol, CK, Creatinine, ACP, ALP, Phosphorus, Glucose, γ-GT, Iron, Lactate LDH, LDL-Cholesterol, Lipase, Magnesium, Potassium, Proteins, Sodium, Triglycerides, Uric Acid and Urea.
PREVECAL RHEUMA		
31009	12 x 1 mL	Anti-streptolysin O, C-reactive Protein and Rheumatoid Factors (human sera).
PREVECAL PROTEINS		
31010	12 x 1 mL	α1-Acid Glycoprotein, CRP-hs, Immunoglobulins (A, G and M), Complements C3 (human sera) and C4, Ferritin, Prealbumin and Transferrin.
PREVECAL URINE		
18067	12 x 5 mL	Albumin, α-Amylase, α-Amylase Pancreatic, Calcium, Chloride, Citrate, Creatinine, Glucose, Magnesium, Phosphorus, Potassium, Protein Urine, Sodium, Urea and Uric Acid.

ISO 17043 — ACCREDITED

All kits include general instructions and cards for results.

Instruments

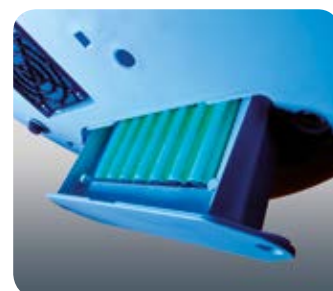

BTS 350 SEMI-AUTOMATIC ANALYZER

Code 80175

Semi-Automatic Analyzer LED Technology

- ▶ LED configuration: 340, 405, 505, 535, 560, 600, 635, 670 nm, (optional: 450 nm).
- ▶ Durable, humidity proof Hard Coated Filters.
- ▶ Battery Power Pack (2hrs)-OPTIONAL (AC14773).
- ▶ Photometric Range 0.0-3.5A for all wavelengths.
- ▶ Flow Cuvette 18 μ L (macro, semi-micro and microcuvette).
- ▶ Levy-Jennings QC chart (based on Westgard's Rules).
- ▶ Calibration by Factor, single calibrator or calibration curve.
- ▶ Maximum power of 30 W. (minimal energy consumption).
- ▶ USB Port to export data (results and graphs).
- ▶ The lowest maintenance.



Instruments



A15

Random Access Analyzer

- ▶ Continuous loading of samples during working session (STAT samples).
- ▶ Innovative design and functional robustness.
- ▶ Low water consumption, less than 0.5 L/ hour.
- ▶ Throughput of 150 tests/hour.
- ▶ Real prozone detection function.
- ▶ Primary tubes and pediatric vials in any position.
- ▶ Maximum flexibility in the positioning of samples and reagents.
- ▶ Minimum reading volume of 180 mL.
- ▶ Clinical Chemistry and Turbidimetry dedicated reagents.
- ▶ Filter configuration 340, 405, 505, 535, 560, 600, 635, 670 nm (adaptable).

Code 83105

Optional configurations

A15 with cooling system for 20 refrigerated reagents positions

Code 83105 C

Instruments



Code 83101-V2

Random Access Analyzer

- ▶ Throughput of 240 tests/hour.
- ▶ Clinical Chemistry and Turbidimetry dedicated reagents.
- ▶ 30 refrigerated positions by 20 and 50 mL reagents bottles.
- ▶ Flexibility in positioning with polyvalent (sample and reagent) racks.
- ▶ Real prozone detection function non lot dependent.
- ▶ Unlimited STAT capabilities. Run at any time.
- ▶ Minimum reading volume of 180 mL.
- ▶ Filter configuration 340, 405, 505, 535, 560, 600, 635, 670 nm (adaptable).
- ▶ Automatic conditioning of fluid system.

Consumables A15/A25

Code	Quantity	Description
BO11524	1000 mL	Concentrated system liquid
BO13416	100 mL	Concentrated washing solution
AC11485	10 uds.	Reaction rotor
A1K110	1 unit	Power Supply Unit, 110V
A1K220	1 unit	Power Supply Unit, 220V
AC17200	4 x 20 mL	Acid Washing Solution (WS1)
AC10770	1000 units	Sample wells (pediatric cups)
BO11493	10 units	Reagent bottles 50 mL + caps
BO11494	10 units	Reagent bottles 20 mL + caps
BO13442	10 units	Amber reagent bottles 50 mL + caps
LA10418	5 units	Halogen lamp A25 12V/20W
LA10429	5 units	Halogen lamp A15 6V/10W
AC14681	1 unit	External barcode reader



BA200

LED TECHNOLOGY

Random Access Analyzer

Code 83200

- ▶ STAT and Routine Laboratories Benchtop Random Clinical Chemistry Analyzer.
- ▶ Dynamic Baseline with SMART LED Technology.
- ▶ High reagent and sample capacity (88 positions), the highest grade in flexibility.
- ▶ Barcoded dedicated reagents.
- ▶ Highly accurate dispensing.
- ▶ 120 - cuvette rotor with washing station.
- ▶ Compact system with low maintenance.
- ▶ Real 200 t/h, even with bi reagent reactions.



Accessories BA200

Code	Quantity	Description
AC17346	1 unit	Wheeled table + computer support
AC17345	1 unit	Wheeled table

Instruments

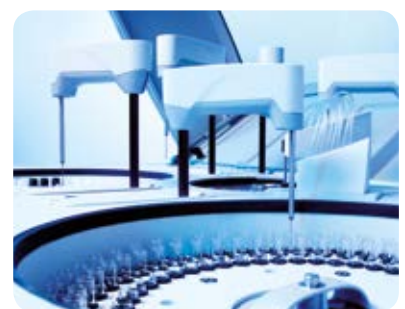
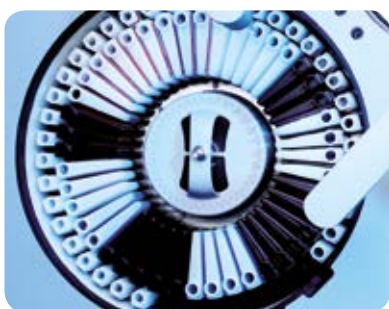

Random Access Analyzer

- ▶ Throughput of 400 test/hour (Clinical Chemistry and Turbidimetry).
- ▶ Optical system based on LED technology that assures unlimited lifetime avoiding lamp replacement and improving sensitivity.
- ▶ Photometric range up to 3.5 Abs and optical resolution of 0.0001 Abs.
- ▶ Capacity up to 135 sample positions (90 samples with barcode).
- ▶ 88 Cooling reagents on board (5 - 8°C) by 20 and 60 mL dedicated reagent bottles.
- ▶ Easy STAT samples positioning.
- ▶ Non fixed positions for samples, control, calibrator nor STAT.
- ▶ Barcode readers for sample and reagents.
- ▶ ISE module, Na⁺, K⁺, Cl⁻, Li⁺ (optional).
- ▶ Minimum user maintenance.
- ▶ Less than 14 L/h water consumption and energy-efficient management (500 VA).
- ▶ Capacity to fully integrate into LIS (ASTM, HL7).
- ▶ Compact system with no peripherals (external bottles, pumps/ compressors, weighing scales, additional tubes, etc.).



**reddot award 2014
winner**

Red Dot Award for
high design quality

Consumables and accessories BA200/BA400

Code	Presentation	Description
AC11485	10 units	Reaction rotors
AC16434	500 mL	Concentrated washing solution
A1K1500	1 unit	Power Supply Unit 1500 VA
AC10770	1000 units	Sample wells (Pediatric cups)
AC16362	10 units	Reagent bottles 60 mL + caps
AC16363	10 units	Reagent bottles 20 mL + caps
AC16364	10 units	Amber reagent bottles 60 mL + caps
AC16365	10 units	Amber reagent bottles 20 mL + caps
AC17201	4 x 20 mL	Acid washing solution (WS1)
AC17205	4 x 15 mL	Alkaline washing solution (WS2)
AC14681	1 unit	External barcode reader

ISE Module	Presentation	Description
5201	1 unit	Sodium Electrode (Na ⁺)
5202	1 unit	Potassium Electrode (K ⁺)
5207	1 unit	Chloride Electrode (Cl ⁻)
5204	1 unit	Reference Electrode
5205	1 unit	Lithium Electrode (Li ⁺)
5420	1 unit	Reagent pack Na ⁺ /K ⁺ /Cl ⁻ /Li ⁺
5412	125 mL	Urine diluent 125 ml
5408	500 mL	Urine diluent 500 ml
5421	1 unit	ISE Cleaning solution Kit
2814	1 unit	Bi-level quality control kit (Na ⁺ /K ⁺ /Cl ⁻ /Li ⁺)
2815	1 unit	Tri-level quality control kit (Na ⁺ /K ⁺ /Cl ⁻ /Li ⁺)

Hematology



Analyzer systems

Microfluidic technology

Hematology Analyzers

- ▶ Low consumption: Only 3 reagents
- ▶ Compact design
- ▶ Full-color touch screen
- ▶ Connectivity: LIS connection; results sent by email



HA5

Code 86103

HA5^{OP}

Code 86203

Complete Hematology system 5-DIFF uses laser based flow cytometry with forward-scattered light detection for WBC, volumetric impedance method for RBC and photometric method for HGB.

- ▶ Sampling mode: closed
- ▶ Processed sample volume : 2x1.4µL
- ▶ Throughput: 60 test/hour
- ▶ 26 parameters, 1 scattergram, 3 histograms

Consumables

Product	Code	Quantity
Reagent pack 5 DIFF 100 test	60126	4.3L
Reagent pack 5 DIFF 400 test	60128	6.3L
Control blood 5 DIFF (level: high, normal,low)	60122	3x3mL

- ▶ Sampling mode: open
- ▶ Processed sample volume : 2x1.4µL
- ▶ Throughput: 57 test/hour
- ▶ 26 parameters, 1 scattergram, 3 histograms

Consumables

Product	Code	Quantity
Reagent pack 5 DIFF OP 100 test	60140	3.78L
Reagent pack 5 DIFF OP 250 test	60141	5.55L
Control blood 5 DIFF (level: high, normal,low)	60122	3x3mL

Analyzer systems

Microfluidic technology



HA3

Code 86003

Complete hematology system 3-DIFF based on the volumetric impedance method.

- ▶ Two operating modes: open/closed
- ▶ Processed sample volume : 2.5µL
- ▶ Throughput: 60t/h in closed mode
- ▶ 22 parameter, 3 histograms

Consumables

Product	Code	Quantity
Reagent pack 3 DIFF 100 test	60110	1.85L
Reagent pack 3 DIFF 500 test	60112	5.45L
Control blood 3 diff (level: high, normal,low)	60109	3x2.5mL
Cleaning solution	60108	100mL

Accessories



HALOADER

Code HA86000

The HALoader is an automatic sample vial loading device. The Autoloader is compatible with HA5 hematology analyzer and it supports the different vial types: **Greiner Vacuette, BD vacutainer y BD MAP.**

- ▶ 60t/h — Throughput
- ▶ 50 samples/tray — Capacity
- ▶ Random access mode
- ▶ Built in sample mixer and barcode reader
- ▶ All operations can be paused at any time

Net weight – 8.5Kg

Coagulation



Reagents & Instruments

Test	Code	Quantity
PROTHROMBIN TIME (PT)		
Rabbit Brain Thromboplastin	61001	4 x 5 mL
ACTIVATED PARTIAL THROMBOPLASTIN TIME (APTT)		
APTT A: Rabbit Brain Cephalin and Micronized Silica	61004	4 x 4 mL
APTT B: CaCl ₂ buffer solution	61005	4 x 16 mL
APTT A + APTT B	61009	4 x 4 mL + 1 x 16 mL
FIBRINOGEN CLAUSS		
Human Thrombin	61002	4 x 2 mL
Fibrinogen B: Imidazol buffer solution	61003	4 x 15 mL
Fibrinogen A + Fibrinogen B	61020	4 x 2 mL + 4 x 15 mL
THROMBIN TIME (TT)		
Human Thrombin	61000	4 x 3 mL
COAGULATION CALIBRATOR		
Prothrombin Time (TP) and Fibrinogen Clauss	61006	4 x 1 mL
COAGULATION CONTROL		
LEVEL I: PT, APTT, TT and Fibrinogen Clauss	61007	4 x 1 mL
LEVEL II: PT, APTT and Fibrinogen Clauss	61008	4 x 1 mL



COA X

Semi-automated coagulometers

- ▶ Three models: 1, 2 or 4 optical channels.
- ▶ Prepared for the daily routine and the upcoming requirements.
- ▶ High quality results.

Specifications

Code	85001	85002	85004
Optic channels	1	2	4
Wavelength (mm)	620 (red)	405 (UV)	405 (UV)
Global Coag. Tests	PT, APTT, TT, FIB	PT, APTT, TT, FIB	PT, APTT, TT, FIB
Specific Coag. Tests	-	individual factors	
Latex Tests	D-Dimer	D-Dimer	
Chromogenic Coag. Tests	-	AT,PC	
Display	Color Touch screen display		
Dimensions	230 x 140 x 90 mm (l,b,h)		
Interfaces	RS 232 (2x) Printer, barcode reader USB (2x) Network, Firmware update		



Consumables

Product	
1 box 500 cuvettes	85020

Autoimmunity



Immunofluorescence

Code	Quantity	Description
ANTI-NUCLEAR ANTIBODIES HEp-2 (ANA-HEp-2)		
<i>HEp-2 cells</i>		
44108	24 tests	Complete kit, 6 wells
44508	60 tests	Complete kit, 6 wells
44509	120 tests	Complete kit, 12 wells
44546	10 slides	Slide box, 6 wells
44547	10 slides	Slide box, 12 wells
ANTI-nDNA ANTIBODIES (nDNA)		
<i>Crithidia luciliae</i>		
44825	24 tests	Complete kit, 6 wells
44818	60 tests	Complete kit, 6 wells
44817	120 tests	Complete kit, 12 wells
44820	10 slides	Slide box, 6 wells
44819	10 slides	Slide box, 12 wells
ANTI-NEUTROPHIL CYTOPLASMIC ANTIBODIES (ANCA)		
<i>Ethanol fixed ANCA</i>		
44850	24 tests	Complete kit, 6 wells
44851	60 tests	Complete kit, 6 wells
44852	10 slides	Slide box, 6 wells
44911	10 slides	Slide box, 12 wells
<i>Formalin fixed ANCA</i>		
44878	10 slides	Slide box, 6 wells
44898	60 tests	Complete kit, 6 wells
<i>Methanol fixed ANCA</i>		
44895	10 slides	Slide box, 6 wells
ANTI-ENDOMYSIUM ANTIBODIES (AEA)		
<i>Monkey Esophagus (Endomysium)</i>		
44548	48 tests	Complete kit, 4 wells
44715	96 tests	Complete kit, 8 wells
44557	12 slides	Slide box, 4 wells
44710	12 slides	Slide box, 8 wells
AUTOANTIBODIES RL/RK/RS (ANA-AMA-ASMA-APCA-LKM)		
<i>Rat Liver/Kidney/Stomach</i>		
44558	48 tests	Complete kit, 4 wells
44648	96 tests	Complete kit, 8 wells
44570	12 slides	Slide box, 4 wells
44639	12 slides	Slide box, 8 wells
AUTOANTIBODIES MsL/MsK/MsS (ANA-AMA-ASMA-APCA-LKM)		
<i>Mouse Liver/Kidney/Stomach</i>		
44826	12 slides	Slide box, 4 wells
44827	12 slides	Slide box, 8 wells
ANTI-MITOCHONDRIAL ANTIBODIES (AMA)		
<i>Rat Kidney</i>		
44510	48 tests	Complete kit, 4 wells
44514	96 tests	Complete kit, 8 wells
44511	12 slides	Slide box, 4 wells
44515	12 slides	Slide box, 8 wells
ANTI-SMOOTH MUSCLE ANTIBODIES (ASMA)		
<i>Rat Stomach</i>		
44520	48 tests	Complete kit, 4 wells
44524	96 tests	Complete kit, 8 wells
44521	12 slides	Slide box, 4 wells
44525	12 slides	Slide box, 8 wells

Code	Quantity	Description
GLOMERULAR BASEMENT MEMBRANE ANTIBODIES (GBMA)		
		<i>Monkey Kidney</i>
44588	12 slides	Slide box, 4 wells
ANTI-ADRENAL CORTEX ANTIBODIES (AACA)		
		<i>Monkey Adrenal</i>
44574	48 slides	Slide box, 4 wells
44575	12 slides	Slide box, 4 wells
ANTI-STRIATED MUSCLE ANTIBODIES (AStMA)		
		<i>Rat Striated Muscle</i>
44649	12 slides	Slide box, 4 wells
ANTI-ISLET CELL ANTIBODIES (AICA)		
		<i>Monkey Pancreas</i>
44609	48 tests	Complete kit, 4 wells*
44572	12 slides	Slide box, 4 wells
ANTI-THYROID ANTIBODIES (ATA)		
		<i>Monkey Thyroid</i>
44550	48 tests	Complete kit 4 wells
44551	12 slides	Slide box, 4 wells
ANTI-SKIN ANTIBODIES (ASA)		
		<i>Monkey Esophagus</i>
44560	48 tests	Complete kit, 4 wells*
44561	12 slides	Slide box, 4 wells
ANTI-KERATIN ANTIBODIES (AKA)		
		<i>Rat Esophagus</i>
44618	48 tests	Complete kit, 4 wells*
44517	12 slides	Slide box, 4 wells
AUTOANTIBODIES DUO		
44874	60 tests	HEp2/ML. Slide box, 6 wells
TISSUE SLIDES FOR RESEARCH USE ONLY (RUO)		
44571		Monkey Heart
44679		Monkey Stomach
44573		Monkey Ovary
44685		Monkey Sciatic Nerve
44687		Monkey Brain
44684		Monkey Cerebellum
44589		Monkey Hypophysis
44688		Monkey Jejunum
44638		Monkey Submaxillary
44566		Monkey Testicle
44516		Rat Colon
44527		Rat Sciatic Nerve
Conjugates for Monkey tissues		
IgG FITC/Evans (M)		
44847	3.5 mL	Anti-(Monkey adsorbed) IgG FITC conjugate, contains Evans Blue.
44882	10 mL	For use with AEA, GBMA, AICA, ATA, ASA and AACA.
IgG FITC/Evans (M) hs		
44914	3.5 mL	High sensitive Anti-(Monkey absorbed) IgG FITC conjugate, contains Evans Blue.
44915	10 mL	For use with AEA, GBMA, AICA, ATA, ASA and AACA

Immunofluorescence

Code	Quantity	Description
IgA FITC/Evans		
44692	3.5 mL	Anti-IgA FITC conjugate, contains Evans Blue.
44835	10 mL	For use with AEA.

Conjugates for Rat and Mouse tissues

FITC/Evans (R)		
44590	3.5 mL	(Rat adsorbed) Anti-IgG, IgA, IgM FITC conjugate, contains Evans Blue.
44836	10 mL	For use with Autoantibodies Screening, AMA and ASMA.

Conjugates for HEp-2, nDNA and ANCA

IgG FITC/Evans		
44697	3 mL	Anti-IgG FITC conjugate, contains Evans Blue.
44834	10 mL	For use with HEp-2, nDNA, ANCA AStMA and AKA.

Auxiliary Reagents

Miscellaneous

44846	10 mL	Glycin (for GBMA)
44592	100 mL	PBS (10x)
44694	3 mL	Mounting medium
44897	100 u.	Coverslips (24 x 60 mm)

Immunofluorescence Controls*

44696	0.3 mL	Negative Control
44889	2.0 mL	Negative Control
44502	0.3 mL	Anti-Nuclear Antibodies-Homogeneous Positive Control
44890	2.0 mL	Anti-Nuclear Antibodies-Homogeneous Positive Control
44585	0.3 mL	Anti-Nuclear Antibodies-Centromere Positive Control
44504	0.3 mL	Anti-Nuclear Antibodies-Nucleolar Positive Control
44503	0.3 mL	Anti-Nuclear Antibodies-Speckled Positive Control
44549	0.3 mL	Anti-Endomysium Antibodies IgA Positive Control
44893	2.0 mL	Anti-Endomysium Antibodies IgA Positive Control
44732	0.3 mL	Anti-Endomysium Antibodies IgG Positive Control
44512	0.3 mL	Anti-Mitochondrial Antibodies Positive Control
44891	2.0 mL	Anti-Mitochondrial Antibodies Positive Control
44522	0.3 mL	Anti-Smooth Muscle Antibodies Positive Control
44892	2.0 mL	Anti-Smooth Muscle Antibodies Positive Control
44553	0.3 mL	Anti-Thyroid Antibodies Positive Control
44542	0.3 mL	Anti-nDNA Antibodies Positive Control
44894	2.0 mL	Anti-nDNA Antibodies Positive Control
44854	0.3 mL	C-ANCA Positive Control
44912	2.0 mL	C-ANCA Positive Control
44855	0.3 mL	P-ANCA Positive Control
44913	2.0 mL	P-ANCA Positive Control
44896	0.3 mL	X-ANCA Positive Control

ELISA

Code	Quantity	Description
ANA-SCREENING 44785	96 tests	Purified SSA(Ro), SSB(La), Sm/RNP, RNP (70, A and C), Sm, Scl70, Jo1, dsDNA, ssDNA, nucleosomes, total histones, PMScl 100, Centromere B
ENA 6-SCREENING 44740	96 tests	SSA (Ro), SSB (La), Sm, Sm/RNP, Jo1, Scl70
ENA 4-PROFILE 44775	96 tests	Highly purified SSA, SSB, Sm, Sm/RNP
ENA 6-PROFILE 44910	96 tests	Highly purified SSA (Ro), SSB (La), Sm, Sm/RNP, Jo1, Scl70
ANTI-Sm ANTIBODIES 44755	96 tests	Highly purified human antigen
ANTI-Sm/RNP ANTIBODIES 44770	96 tests	Highly purified human antigen
ANTI-SSA (Ro) ANTIBODIES 44765	96 tests	Highly purified antigen
ANTI-SSB (La) ANTIBODIES 44750	96 tests	Highly purified antigen
ANTI-CENTROMERE B ANTIBODIES (CENP-B) 44865	96 tests	Recombinant antigen
ANTI-Jo1 ANTIBODIES 44864	96 tests	Highly purified antigen
ANTI-Scl70 ANTIBODIES 44863	96 tests	Highly purified antigen
ANTI-HISTONES ANTIBODIES (HIST) 44862	96 tests	Highly purified antigen
ANTI-NUCLEOSOME ANTIBODIES (NCL) 44861	96 tests	Purified antigen
ANTI-dsDNA ANTIBODIES 44705	96 tests	Calf thymus antigen
ANTI-CITRULLINATED PROTEIN ANTIBODIES (ACPA) 44860	96 tests	Highly purified antigen
ANTI-CARDIOLIPIN ANTIBODIES (ACA-IgG/IgM) 44780	96 tests	Highly purified antigen
ANTI-PHOSPHOLIPID ANTIBODIES IgG/IgM (APLA) 44867	96 tests	Mixture of cardiolipin, phosphatidyl serine, phosphatidyl inositol, phosphatidic acid and human b2-Glycoprotein 1

ELISA

Code	Quantity	Description
ANTI- β 2-GLYCOPROTEIN 1 ANTIBODIES IgG/IgM (β 2-GP1) 44868	96 tests	Highly purified antigen
ANTI-ANNEXIN V ANTIBODIES IgG/IgM (ANX) 44869	96 tests	Highly purified antigen
ANTI-PR3 ANTIBODIES (C-ANCA) 44791	96 tests	Purified human antigen
ANTI-MPO ANTIBODIES (P-ANCA) 44790	96 tests	Purified human antigen
ANTI-BPI ANTIBODIES 44905	96 tests	Purified human antigen
ANTI-CATHEPSIN G ANTIBODIES 44906	96 tests	Purified human antigen
ANTI-ELASTASE ANTIBODIES 44907	96 tests	Purified human antigen
ANTI-LACTOFERRIN ANTIBODIES 44908	96 tests	Purified human antigen
ANTI-LYSOZYME ANTIBODIES 44909	96 tests	Purified human antigen
ANTI-GLOMERULAR BASEMENT MEMBRANE ANTIBODIES (GBM) 44870	96 tests	Highly purified antigen
ANTI-tTRANSGLUTAMINASE IgA ANTIBODIES (Anti-tTG IgA)* 44754	96 tests	Recombinant human antigen activated by calcium and gliadin
ANTI-tTRANSGLUTAMINASE IgG ANTIBODIES (Anti-tTG IgG)* 44798	96 tests	Recombinant human antigen activated by calcium and gliadin
ANTI-GLIADIN ANTIBODIES (AGA-IgG/IgA) 44704	96 tests	Gliadin
ANTI-DEAMIDATED GLIADIN (DGP-IgG) 44884	96 tests	Synthetic deamidated gliadin
ANTI-DEAMIDATED GLIADIN (DGP-IgA) 44885	96 tests	Synthetic deamidated gliadin

Code	Quantity	Description
ANTI-SACCHAROMYCES CEREVISIAE ANTIBODIES IgG/IgA (ASCA) 44872	96 tests	Highly purified mannan from Saccharomyces cerevisiae
ANTI-THYROID PEROXIDASE ANTIBODIES (anti-TPO) 44795	96 tests	Recombinant human thyroid Peroxidase
ANTI-THYROGLOBULIN ANTIBODIES (anti-TG) 44796	96 tests	Highly purified human antigen
ANTI-INSULIN ANTIBODIES 44873	96 tests	Mixture of recombinant and purified insulin
ANTI-M2 ANTIBODIES (M2) 44871	96 tests	Highly purified mitochondrial M2 subtype antigen

External Quality Control



International External Quality
Assessment Scheme

- ▶ Yearly program for the comparison of results between laboratories
- ▶ Monthly measurements of different control materials
- ▶ The final report summarises all monthly reports and shows additional data on performance
- ▶ On-line participation through www.prevecal.net

Autoimmunity

Code	Quantity	Description
Prevecal ANA 18046	12 x 0.3 mL	Antinuclear antibodies
Prevecal ANCA 18056	4 x 0.3 mL	ANCA
Prevecal nDNA 18047	12 x 0.3 mL	Anti-nDNA antibodies
Prevecal CELIAC 18051	4 x 0.3 mL	Anti-endomysium, anti-tTG, anti-Gliadin, and DGP antibodies.

All kits include general instructions and cards for results.

Instruments

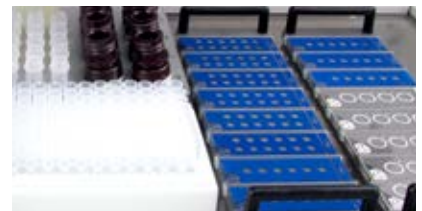

Code 84101

Immunofluorescence Processor

- ▶ Sample volume 3 μ L.
- ▶ Sample tray interchangeable racks (13mm x 100 mm, 15 mm x 100 mm or 2 mL).
- ▶ Dilution tray 96 vials (1.2 mL).
- ▶ Slides (plates) 16 (2).
- ▶ Reagent tray 8 conjugates (15 mL), 15 controls (2 mL), 1 additional diluent (50 mL).
- ▶ Reagents reservoirs 1 L bottle of washing solution, 1 L waste bottle, 1 L buffer bottle.
- ▶ Level sensor probe conductive.
- ▶ Slide washing flux system utilizing simultaneous dispensing and aspirating probes.
- ▶ Barcode reader hand-held barcode reader.

Consumables

Code	Quantity	Description
44592	100 mL	PBS (10x)
BO13416	100 mL	Concentrated Washing Solution
AC14682	120 strips	iPro Dilution Tubes (1,1 mL)

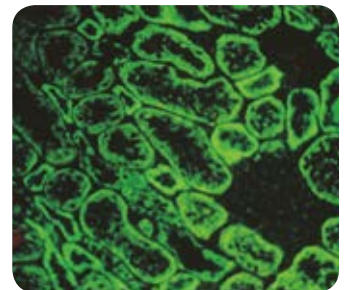
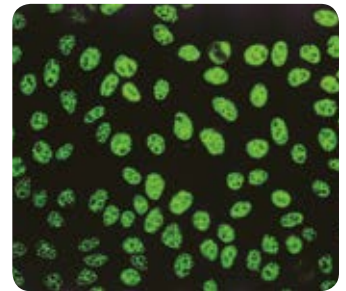

Code 84201

Fluorescence Microscope (LED Technology)

- ▶ Optical system Infinity corrected plan objectives, (10x, 20x and 40x).
- ▶ Head & Eyepieces WF10x paired eyepiece.
- ▶ Bright Field Illumination 12V, 20W halogen light source with precentred light condenser bulb coupled with a collector lens system provides optimum brightness along the optical path.
- ▶ Fluorescence Light Source High power blue LED (470-480nm).
- ▶ Fluorescence Filters FITC.
- ▶ Power Supply 110 - 240V AC. 50/60Hz. Single phase.

Consumables

Code	Description
ME15035	4x objective
ME15039	100x objective
AC15045	Trinocular head
AC15277	Digital Camera

Instruments



Immunofluorescence Laboratory Software: Total Integration

Code 84301

- ▶ LIMS Communication.
- ▶ Bidirectional communication with iPro: import sessions and request new test.
- ▶ Patterns, titers and images of controls configurable by test.
- ▶ Patient results management in association with images from the camera (TWAIN compatible).
- ▶ Patient historical of results and images: SQL Server Database.
- ▶ Possibility to print results report with images.
- ▶ Image reference Atlas.

Rapid tests



Rapid tests

Code	Quantity	Method
Latex Seroagglutination		
ANTI-STREPTOLYSIN O (ASO) - SLIDE		
31448	1 x 3 mL	Agglutination
31019	50 tests	LATEX
31086	150 tests	
C-REACTIVE PROTEIN (CRP) - SLIDE		
31107	1 x 3 mL	Agglutination
31011	50 tests	LATEX
31012	150 tests	
RHEUMATOID FACTORS (RF) - SLIDE		
31108	1 x 3 mL	Agglutination
31013	50 tests	LATEX
31014	150 tests	
Syphilis Serodiagnostics		
RPR-CARBON		
36001	100 tests	Agglutination
36002	500 tests	
TPHA		
36005	200 tests	Hemagglutination
Febril Serodiagnostics		
MULTISCREENING		
33001	6 x 100 tests	Agglutination SLIDE AND TUBE TESTS Salmonella paratyphi AH, Salmonella paratyphi BH, Salmonella typhi H, Salmonella typhi O, B. abortus (Rose Bengal), Proteus Ox19. Positive (Salmonella, Brucella and Proteus) and negative controls included.
SALMONELLA		
33080	8 x 100 tests	Agglutination SLIDE AND TUBE TEST Salmonella paratyphi AO, Salmonella paratyphi AH, Salmonella paratyphi BO, Salmonella paratyphi BH, Salmonella paratyphi CO, Salmonella paratyphi CH, Salmonella typhi H, Salmonella typhi O.
FEBRILE ANTIGENS		
33309	5 mL	Brucella abortus
33315	5 mL	Brucella abortus (Rose Bengal)
33301	5 mL	Salmonella paratyphi AH
33302	5 mL	Salmonella paratyphi AO
33303	5 mL	Salmonella paratyphi BH
33304	5 mL	Salmonella paratyphi BO
33305	5 mL	Salmonella paratyphi CH
33306	5 mL	Salmonella paratyphi CO
33307	5 mL	Salmonella typhi H
33308	5 mL	Salmonella typhi O
33311	5 mL	Proteus Ox19

Alphabetical Index

	Pg.		Pg.
α-AMYLASE DIRECT	4	ANTI-MPO ANTIBODIES (P-ANCA)	34
α-AMYLASE PANCREATIC	4	ANTI-nDNA ANTIBODIES (nDNA)	30
α-AMYLASE-EPS	4	ANTI-NEUTROPHIL CYTOPLASMIC ANTIBODIES (ANCA)	30
α1-ACID GLYCOPROTEIN	4	ANTI-NUCLEAR ANTIBODIES HEp-2 (ANA-HEp-2)	30
A15	19	ANTI-NUCLEOSOME ANTIBODIES (NCL)	33
A25	20	ANTI-PHOSPHOLIPID ANTIBODIES IgG/IgM (APLA)	33
Accesories BA200	21	ANTI-PR3 ANTIBODIES (C-ANCA)	34
ACID PHOSPHATASE (ACP)	4	ANTI-SACCHAROMYCES CEREVISIAE ANTIBODIES IgG/IgA (ASCA)	35
ACTIVATED PARTIAL THROMBOPLASTIN TIME (APTT)	28	ANTI-Sci70 ANTIBODIES	33
ADA	15	ANTI-SKIN ANTIBODIES (ASA)	31
ADENOSINE DEAMINASE (ADA)	4	ANTI-Sm ANTIBODIES	33
ADENOSINE DEAMINASE (ADA)	14	ANTI-Sm/RNP ANTIBODIES	33
ALANINE AMINOTRANSFERASE (ALT/GPT)	4	ANTI-SMOOTH MUSCLE ANTIBODIES (ASMA)	30
ALBUMIN	4	ANTI-SSA (Ro) ANTIBODIES	33
ALBUMIN (MICROALBUMINURIA)	4	ANTI-SSB (La) ANTIBODIES	33
ALBUMIN (MICROALBUMINURIA)	14	ANTI-STREPTOLYSIN O (ASO)	5
ALKALINE PHOSPHATASE (ALP)-AMP	5	ANTI-STREPTOLYSIN O (ASO)	14
ALKALINE PHOSPHATASE (ALP)-DEA	5	ANTI-STREPTOLYSIN O (ASO) - SLIDE	40
AMMONIA	5	ANTI-STRIATED MUSCLE ANTIBODIES (ASiMA)	31
AMMONIA, ETHANOL, CO2	14	ANTI-THYROGLOBULIN ANTIBODIES (anti-TG)	35
AMMONIA, ETHANOL, CO2	15	ANTI-THYROID ANTIBODIES (ATA)	31
5-AMINOLEVULINIC ACID (ALA)/ PORPHOBILINOGEN (PBG)	13	ANTI-THYROID PEROXIDASE ANTIBODIES (anti-TPO)	35
ANA-SCREENING	33	ANTI-t TRANSGLUTAMINASE IgA ANTIBODIES (Anti-tTG IgA)*	34
ANGIOTENSIN CONVERTING ENZYME (ACE)	5	ANTI-t TRANSGLUTAMINASE IgG ANTIBODIES (Anti-tTG IgG)*	34
ANTI-ADRENAL CORTEX ANTIBODIES (AACA)	31	ANTI-β2-GLYCOPROTEIN 1 ANTIBODIES IgG/IgM (β2-GP1)	34
ANTI-ANNEXIN V ANTIBODIES IgG/IgM (ANX)	34	ANTITHROMBIN III	5
ANTI-BPI ANTIBODIES	34	APOLIPOPROTEIN A-1 (APO A-1)	5
ANTI-CARDIOLIPIN ANTIBODIES (ACA-IgG/IgM)	33	APOLIPOPROTEIN A-I	14
ANTI-CATHEPSIN G ANTIBODIES	34	APOLIPOPROTEIN B	14
ANTI-CENTROMERE B ANTIBODIES (CENP-B)	33	APOLIPOPROTEIN B (APO B)	5
ANTI-CITRULLINATED PROTEIN ANTIBODIES (ACPA)	33	ASPARTATE AMINOTRANSFERASE (AST/GOT)	5
ANTI-DEAMIDATED GLIADIN (DGP-IgA)	34	AUTOANTIBODIES DUO	31
ANTI-DEAMIDATED GLIADIN (DGP-IgG)	34	AUTOANTIBODIES MsL/MsK/MsS (ANA-AMA-ASMA-APCA-LKM)	30
ANTI-dsDNA ANTIBODIES	33	AUTOANTIBODIES RL/RK/RS (ANA-AMA-ASMA-APCA-LKM)	30
ANTI-ELASTASE ANTIBODIES	34		
ANTI-ENDOMYSIUM ANTIBODIES (AEA)	30	β-HYDROXYBUTYRATE	6
ANTI-GLIADIN ANTIBODIES (AGA-IgG/IgA)	34	β2-MICROGLOBULIN	6
ANTI-GLOMERULAR BASEMENT MEMBRANE ANTIBODIES (GBM)	34	β2-MICROGLOBULIN	14
ANTI-HISTONES ANTIBODIES (HIST)	33	β2-MICROGLOBULIN	16
ANTI-INSULIN ANTIBODIES	35	β2-MICROGLOBULIN URINE	16
ANTI-ISLET CELL ANTIBODIES (AICA)	31	β-HYDROXYBUTYRATE	6
ANTI-Jo1 ANTIBODIES	33	β2-MICROGLOBULIN	6
ANTI-KERATIN ANTIBODIES (AKA)	31	β2-MICROGLOBULIN	14
ANTI-LACTOFERRIN ANTIBODIES	34	β2-MICROGLOBULIN	16
ANTI-LYSOZYME ANTIBODIES	34	β2-MICROGLOBULIN URINE	16
ANTI-M2 ANTIBODIES (M2)	35	BA200	21
ANTI-MITOCHONDRIAL ANTIBODIES (AMA)	30	BA400	23

Alphabetical Index

	Pg.		Pg.
BILIRUBIN	14	CREATININE ENZYMATIC	8
BILIRUBIN (DIRECT)	6	CREATININE KINASE-MB	16
BILIRUBIN (DIRECT) DPD	6	CREATININE KINASE-MB (CK-MB)	14
BILIRUBIN (TOTAL AND DIRECT)	6		
BILIRUBIN (TOTAL)	6	D-DIMER	
BILIRUBIN (TOTAL) DPD	6	D-DIMER	14
BIOCHEMISTRY (BOVINE)	14	D-DIMER	16
BIOCHEMISTRY (HUMAN)	14		
BIOCHEMISTRY SERUM	15	ENA 4-PROFILE	33
BIOCHEMISTRY SERUM (HUMAN)	15	ENA 6-PROFILE	33
BIOCHEMISTRY URINE	15	ENA 6-SCREENING	33
BTS 350	24	ETHANOL	9
C-REACTIVE PROTEIN (CRP-er)	14	FEBRILE ANTIGENS	40
C-REACTIVE PROTEIN (CRP)	8	FERRITIN	8
C-REACTIVE PROTEIN (CRP) - SLIDE	40	FERRITIN	14
C-REACTIVE PROTEIN (CRP/CRP-hs)	14	FERTILITY BIOCHEMISTRY	16
C-REACTIVE PROTEIN hs (CRP-hs)	8	FIBRINOGEN	9
C-REACTIVE PROTEIN-er (CRP-er)	8	FIBRINOGEN	15
CALCIUM-ARSENAZO	6	FIBRINOGEN	16
CALCIUM-CRESOLPHTHALEIN	6	FIBRINOGEN CLAUSS	28
CALCIUM-MTB	6	FITC/Evans(R)	32
CARBON DIOXIDE (CO2)	6	FRUCTOSAMINE	9
CHOLESTEROL	7	FRUCTOSAMINE	16
CHOLESTEROL HDL	7	FRUCTOSE	9
CHOLESTEROL HDL DIRECT	7		
CHOLESTEROL HDL PRECIPITATING REAGENT	7	GLOMERULAR BASEMENT MEMBRANE ANTIBODIES (GBMA)	31
CHOLESTEROL HDL/LDL	14	GLUCOSE	9
CHOLESTEROL LDL DIRECT	7	GLUCOSE-HEXOKINASE	9
CHOLESTEROL LDL PRECIPITATING REAGENT	7	γ-GLUTAMYL TRANSFERASE (γ-GT)	9
CHOLINESTERASE (CHE)	7		
CITRATE	7	HA3	26
COAGULATION CALIBRATOR	28	HA5	26
COAGULATION CONTROL	28	HbA1C-DIRECT	15
COAX	28	HEMOGLOBIN A1C	16
COMPLEMENT COMPONENT C3	7	HEMOGLOBIN A1C-DIRECT (HbA1C-DIR)	9
COMPLEMENT COMPONENT C4	7	HEMOGLOBIN A2	13
CONSUMABLES A15/A25	20	HEMOGLOBIN A2	16
CONSUMABLES AND ACCESSORIES BA200/BA400	23	HOMOCYSTEINE	10
CONSUMABLES COAX	28	HOMOCYSTEINE	15
CONSUMABLES HA3/HA5	26	HOMOCYSTEINE	16
CONSUMABLES IMLD	37	17-HYDROXYCORTICOSTEROIDS (17-OH)	13
CONSUMABLES IPRO	36	5-HYDROXYINDOLEACETIC ACID (5-HIAA)	13
CONTROL URINE	16		
CREATINE KINASE (CK)	8	IgA FITC/Evans	32
CREATINE KINASE-MB (CK-MB)	8	IgG FITC/Evans	32
CREATININE	8	IgG FITC/Evans (M)	32

	Pg.		Pg.
IMLD	37	RPR-CARBON	40
IMLS	38		
Immunofluorescence Controls*	32	SALMONELLA	40
IMMUNOGLOBULIN A (IgA)	9		
IMMUNOGLOBULIN G (IgG)	10	THROMBIN TIME (TT)	28
IMMUNOGLOBULIN M (IgM)	10	TISSUE SLIDES FOR RESEARCH USE ONLY (RUO)	31
I PRO	36	TOTAL BILE ACIDS	11
IRON-CHROMAZUROL	10	TOTAL IRON BINDING CAPACITY (TIBC)	11
IRON-FERROZINE	10	TRANSFERRIN	12
		TRIGLYCERIDES	12
17-KETOSTEROIDS	13		
		UNSATURATED IRON BINDING CAPACITY (UIBC)	12
LACTATE	10	UREA/ BUN-COLOR	12
LACTATE DEHYDROGENASE (LDH)	10	UREA/ BUN-UV	12
LACTATE DEHYDROGENASE (LDH)-IFCC	10	URIC ACID	12
LIPASE	10		
LIPID SERUM	16	VANILMANDELIC ACID	13
MAGNESIUM	11	ZINC	12
METANEPHRINES	13		
MISCELLANEOUS	32		
MULTISCREENING	40		
OXALATE	11		
OXALATE URINE	16		
PHOSPHORUS	11		
PREALBUMIN	11		
PREVECAL ANA	17		
PREVECAL ANCA	17		
PREVECAL BIOCHEMISTRY (BOVINE)	17		
PREVECAL BIOCHEMISTRY HUMAN	17		
PREVECAL CELIAC	17		
PREVECAL nDNA	17		
PREVECAL PROTEINS	17		
PREVECAL RHEUMA	17		
PREVECAL URINE	17		
PROTEIN	15		
PROTEIN (TOTAL)	11		
PROTEIN (URINE)	15		
PROTEIN (URINE+CSF)	11		
PROTEIN SERUM	16		
PROTHROMBIN TIME (PT)	28		
RHEUMATOID FACTORS (RF)	11		
RHEUMATOID FACTORS (RF)	15		
RHEUMATOID FACTORS (RF) - SLIDE	40		
RHEUMATOID SERUM	16		







Ginger Group



BioSystems

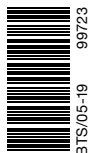

Manufactured by: **BioSystems S.A.**
Costa Brava 30, 08030 Barcelona (Spain) Tel. +34 93 311 00 00
biosystems@biosystems.es - www.biosystems.es



- Certified Management System
- EN ISO 9001
- EN ISO 13485

Why do we need 5-part hematology analyzers?

WBC differential: 3-part

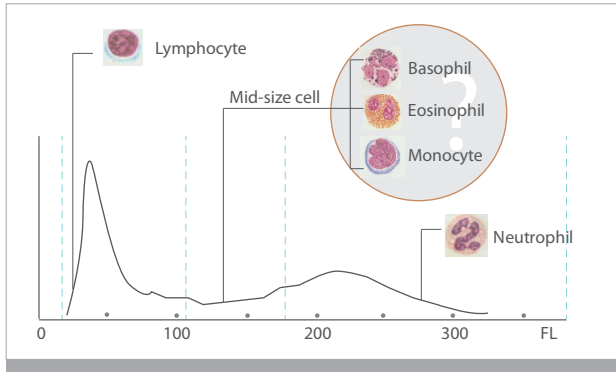

3-part hematology analyzers can not differentiate Basophil, Eosinophil and Monocyte. Additionally, Lymphocyte and Neutrophil results are easily affected by abnormal cells.

Flag information: 3-part

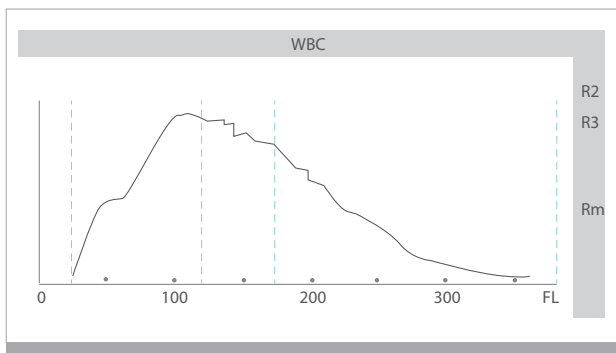

WBC histogram only indicates regional abnormal graph, it can't bring specific flags for different clinical cases.

WBC differential: 5-part

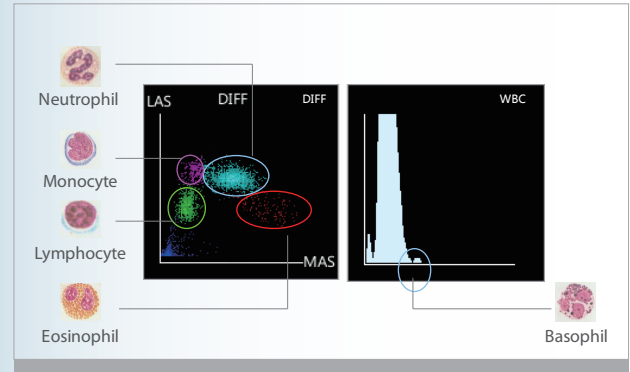

5-part hematology analyzers can provide Lymphocyte, Monocyte, Neutrophil, Eosinophil and Basophil results for every sample. Additionally, the 5-part results are less affected by abnormal cells.

Flag information: 5-part

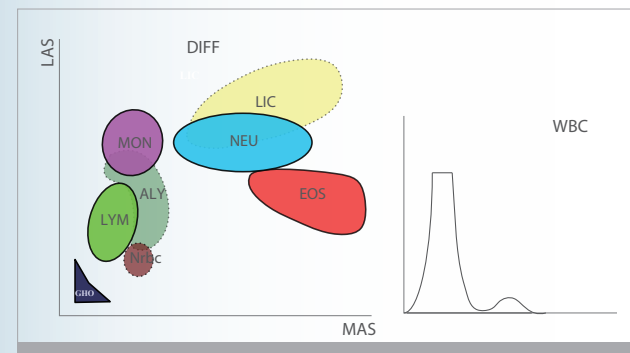

5-part hematology analyzers provide more detailed and specific flag information. Users are able to clearly understand the clinical significance of flags and make a decision.



Dr Marisela Ramos, lab manager

Users are able to access our tailored innovation and intelligent diagnosis support to safeguard their diagnoses decisions with maximum confidence.

She said: "we upgraded to a 5-part hematology analyzer 3 months ago, and it's been working very well. Our lab has lots of abnormal samples, such as Eosinophilia and Monocytosis samples. We could only get the information that the mid-size cells percentage was higher than normal level, but couldn't distinguish which kind of cells increased exactly. Now, the 5-part hematology analyzer provides flags directly, which reduces smears need to be reviewed, and significantly improves our work efficiency."

BC-5150

Auto Hematology Analyzer

Based on Mindray's continuous innovation in hematology field, BC-5150 is especially tailored to assist diagnostic labs who need full CBC + 5-part results, with relatively low daily sample volume, restricted lab space and tight budget.

As the lightest and most compact 5-part hematology analyzer so far from Mindray, BC-5150 is a highly user-friendly and innovative analyzer that offers cost efficient CBC and 5-part white cell differential results. It is targeted to fulfill and exceed the demands of our global customers by providing more accurate, more efficient and more innovative solutions for labs.

WBC 5-part differentiation, 25 reportable parameters and 24 research parameters, 3 histograms and 4 scattergrams

Whole blood mode, Capillary whole blood mode and Prediluted mode

Tri-angle Laser scatter + Chemical dye + Flow cytometry technology

Dedicated optical counting channel for Basophil measurement

Powerful capability of flagging abnormal cells

10.4 inch large TFT touch screen with user-friendly software

Large storage capacity: up to 250,000 samples

Throughput: 60 samples per hour

Sample volume is only 15 μ L which is ideal for pediatrics



Tri-angle laser scatter + focused flow + chemical dye, creating the possibility for a better 5-part WBC differentiation even on samples with high Eosinophil.

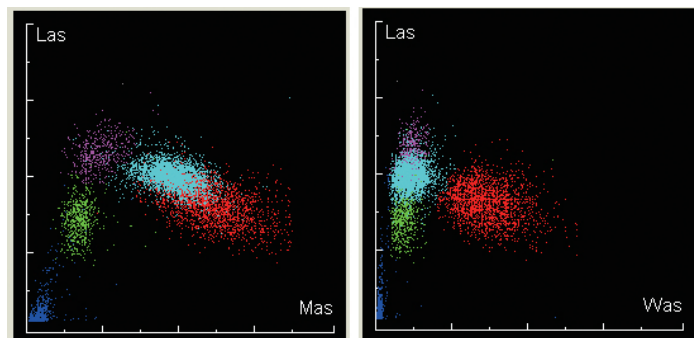
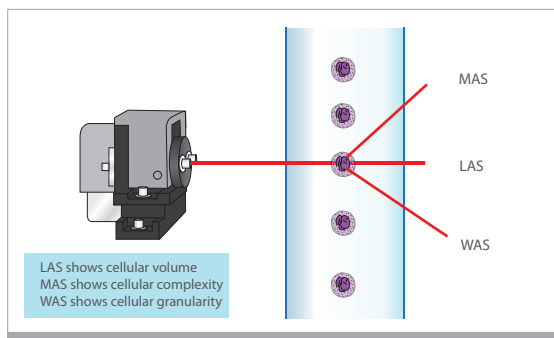

BC-5150, the 5-part hematology analyzer offers a great solution for clinical labs, especially for those who have limited space. Its compact foot-print is a result of innovative technology improvements, including miniaturized semi-conductor laser source, highly integrated electronic boards and optimized liquid handling system.

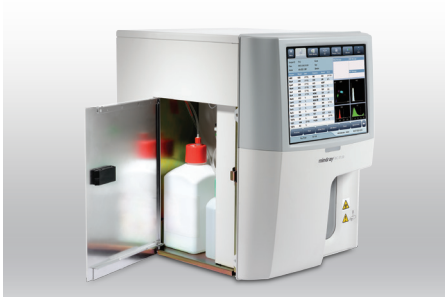

Compact

Two kinds of lyse reagents are located inside of BC-5150, which helps the small labs to save space.



Utility

The 10.4 inch TFT touch screen with a wide viewing angle, brings convenience to clinicians. Users can complete all instrument operations on the screen, practically eliminating the need for an external PC.



BC-5150 inherits its convenient and proven powerful software design from BC-6800 and BC-3600 platforms, the friendly interface is ideal for small sized labs.



Running capillary blood through the sample probe directly is more convenient for the users in children's hospitals, etc. For Prediluted mode, BC-5150 has higher dilution ratio than other 5-part hematology analyzers, thus it brings a better mixing effect.



4 USB ports are located on the instrument's left side. They permit BC-5150 users to transmit data conveniently and connect with printers, keyboard, mouse, barcode scanner, etc.

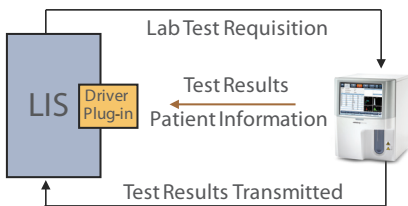

BC-5150 supports bi-directional LIS with test results and patient information. HL7 protocol is supported as well.



Technology

Compared with traditional helium neon laser or argon laser, semi-conductor laser has smaller size, lower cost and longer life cycle.

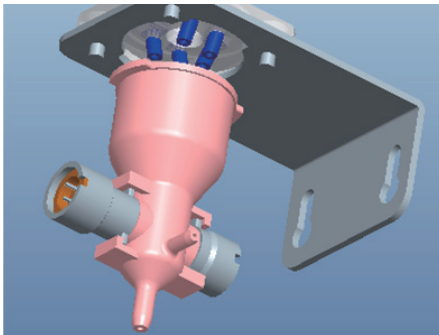

Improved DC impedance technology is used to count and size the RBC and PLT. The smaller counting aperture (50 μm in diameter) provides better performance on samples with low PLT.



Efficient

Only three routine reagents are required. These have 2 years shelf life and also less consumed by BC-5150. Original QC and calibrator are also provided to ensure the hematology analyzer's traceability and testing quality.

Technical Specifications

Principles

Impedance method for RBC and PLT counting
Cyanide free reagent for hemoglobin test
Flow Cytometry (FCM) + Tri-angle laser scatter + Chemical dye method for WBC 5-part differential analysis and WBC counting

Parameters

25 parameters: WBC, Lym%, Mon%, Neu%, Bas%, Eos%, Lym#, Mon#, Neu#, Eos#, Bas#, RBC, HGB, HCT, MCV, MCH, MCHC, RDW-CV, RDW-SD, PLT, MPV, PDW, PCT, P-LCR, P-LCC.
24 research parameters including LIC%, LIC#, ALY%, ALY#, PLT Clump#, PLT Clump%, Lip#, Lip%, NRBC#, NRBC%, Blast#, Blast%, PDW-SD, NLR, PLR, Neu-X, Neu-Y, Neu-Z, Lym-X, Lym-Y, Lym-Z, Mon-X, Mon-Y, Mon-Z
3 histograms for WBC, RBC and PLT
4 scattergrams for WBC differential

Reagent

M-52D Diluent, M-52DIFF Lyse, M-52LH Lyse, Probe Cleanser

Performance

Parameter	Linearity Range	Precision	Carryover
WBC	0-500×10 ⁹ /L	≤2% (4-15×10 ⁹ /L)	≤0.5%
RBC	0-8×10 ¹² /L	≤1.5% (3.5-6.0×10 ¹² /L)	≤0.5%
HGB	0-250g/L	≤1.5% (110-180g/L)	≤0.6%
PLT	0-5000×10 ⁹ /L	≤6.0% (100-149×10 ⁹ /L) ≤4.0% (150-500×10 ⁹ /L)	≤1.0%

Sample Volume

Prediluted mode	20 μL
Whole blood mode	15 μL
Capillary whole blood mode	15 μL

Throughput

60 samples per hour

Display

10.4 inch TFT Touch Screen

Multi-language

Chinese, English, Spanish, Portuguese, Russian, French, Bahasa Indonesia

Data Storage Capacity

Up to 250,000 results including numeric and graphical information

Communication

LAN port supports HL7 protocol

Interface

USB, LAN

Support bi-directional LIS

Printout

External Thermal printer / Laser printer / Inkjet printer, various printout formats and user-defined formats

Operating Environment

Temperature: 10°C~30°C

Humidity: 20%~85%

Air pressure: 70 kPa~106 kPa

Power requirement

100V-240V

50Hz/60Hz

Dimension and Weight

Depth(400 mm) x width(320 mm) x height(410 mm)

Weight :24kg

Surpassing Performance

Surpassing Performance

Superior Reagents, Quality Controls and Calibrators

High quality original reagents, calibrators and controls offer a complete system for our users. Cyanide free reagents allow laboratories to meet necessary environmental regulations. Complete traceability system ensures closest consistency with standard methods.



High Quality Design

New internal structural design separates electronic components from the fluidic system, decreasing interference while at the same time allowing for easier maintenance.

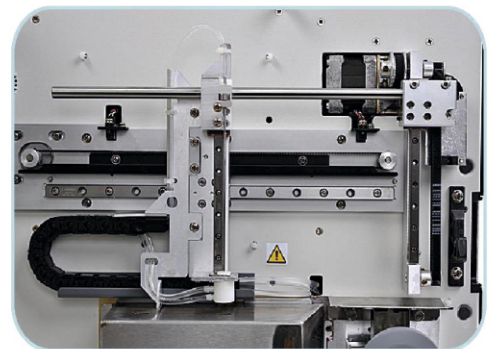

BC-3600

Auto Hematology Analyzer

Technical Specifications

Parameters

WBC, Lymph#, Mid#, Gran#, Lymph%, Mid%, Gran%, RBC, HGB, HCT, MCV, MCH, MCHC, RDW, PLT, MPV and histograms for WBC, RBC, PLT

Principles

Electrical impedance method for cell counting and Cyanide - free for hemoglobin

Performance

Parameter	Linearity Range	Precision (CV%)
WBC ($10^3/\mu\text{L}$)	0.3 - 99.9	3.0(≥ 4.0)
RBC ($10^6/\mu\text{L}$)	0.2 - 7.99	2.5
HGB (g/dL)	1.0 - 24.99	2.0
MCV (fL)		2.0
PLT ($10^3/\mu\text{L}$)	10 - 999	6(≥ 150)

Sample Volume

Prediluted	20 μL
Whole Blood	21 μL

Throughput

60 samples per hour

Display

Large color touch screen
Resolution: 800x600

Carryover

WBC, RBC, HGB $\leq 0.5\%$
PLT $\leq 1.0\%$

Connectivity

4 USB ports (for external printer, software upgrade, barcode reader, keyboard and mouse), LAN port (1), RS232 (1)

Printout

Thermal recorder, 50mm width paper, various printout formats, external printer (optional)

Operating Environment

Temperature: 15°C~30°C
Humidity: 30%~85%

Power requirement

AC 100-240V, 50/60 ± 1 Hz

Dimensions

16 in(W) x 18 in(H) x 18 in(D)

Configuration

Close Tube Sampling

Weight

62 lbs

Mindray North America
800 MacArthur Blvd., Mahwah, NJ 07430-0619, USA
Toll Free: +1(800) 288 2121
E-mail: intl-market@mindray.com www.mindray.com

Mindray is listed on the NYSE under the symbol "MR"

mindray are registered trademarks or trademarks owned by Shenzhen Mindray Bio-medical Electronics Co., LTD.
©2014 Shenzhen Mindray Bio-Medical Electronics Co., Ltd. All rights reserved. Specifications subject to changes without prior notice.
P/N: ENG-BC3600FDA-21285x6-20150924

mindray

BC-3600

Auto Hematology Analyzer

Labs today are facing a multitude of challenges including limited laboratory budgets, increasing requirements for high quality as well as reliable products, a shortage of experienced clinicians and so on. We understand the specific needs of end users, and use them as the foundation for our new solution BC-3600. Complete with an intuitive operation system, convenient data communication interface, excellent performance, BC-3600 is a system solution for satellite labs and clinics.

- CBC+3-DIFF, 16 parameters+3 histograms
- Throughput: 60 samples per hour
- Intuitive operation system with TFT touch screen
- Enhanced performance by proven technologies
- Closed Tube Sampling
- 40,000 results storage with histograms
- High quality QC, calibrators and reagents



User-friendly User-friendly

Intuitive and Powerful Software

The well organized software interface eases your operation and gives you easy control of sample results, patient records, and report customizations. Shortcut menu simplifies your work process and improves efficiency. Distinguishable areas display WBC, RBC and PLT results clearly. Automatic maintenance programs can be executed by double-clicking the function keys while operational errors can be removed with single clicks.

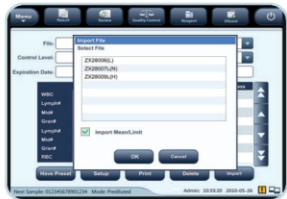

Complete Data Communication

Integrated HL7 communication protocol for LIS connection. A wide selection of interface options are available including RS232 for computer connection, USB for QC assay values upload, barcode scanner, and key board connection.

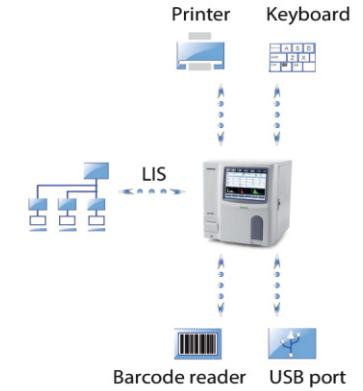

Intelligence and Efficiency

Efficient ZAP and flush method removes clog completely. For Closed Tube model, 3 types of tube adaptors are provided to satisfy individual laboratory needs. With the on-line reminder function, users can conveniently monitor the reagent residual volumes through the software.

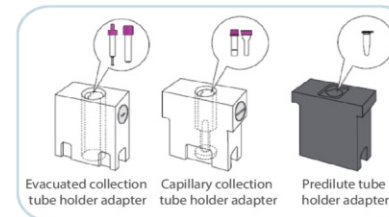
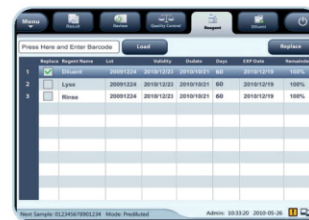

PRODUCT NAME	CODE
CLINICAL CHEMISTRY - BIOCHEMISTRY	
a-AMYLASE - DIRECT	11583
	11550
	12550
	21550
	23550
a-AMYLASE - EPS	11534
	21534
a-AMYLASE-PANCREATIC	11799
	12799
	21799
ACID PHOSPHATASE (ACP)	11548
ALANINE AMINOTRANSFERASE (ALT/GPT)	11832
	11533
	11568
	11562
	12533
	21533
	23533
ALBUMIN	11573
	11547
	12547
	21547
	23547
ALKALINE PHOSPHATASE (ALP) - AMP	11592
	11593
	11598
	12518
	21592
	23592
ALKALINE PHOSPHATASE (ALP) - DEA	11590
	11591
	11597
	12514
	21590
	23590
ASPARTATE AMINOTRANSFERASE (AST/GOT)	11830
	11531
	11567
	11561
	12531
	21531
BILIRUBIN (DIRECT)	23531
	11511
	11545
	21504

PRODUCT NAME	CODE
	23504
BILIRUBIN (TOTAL AND DIRECT)	11515
	11555
BILIRUBIN (TOTAL)	11510
	11544
	21506
	23506
CALCIUM-ARSENAZO	11570
	11571
	12570
	21570
	23570
CALCIUM-CRESOLPHTHALEIN	11811
	11812
	12513
	21511
	23511
CALCIUM-MTB	11527
	11507
CARBON DIOXIDE (CO2)	11558
	11827
	12558
	21558
CHOLESTEROL	11805
	11505
	11506
	11539
	12505
	21505
	23505
	11523
CHOLESTEROL HDL DIRECT	11557
	12557
	21557
	23557
CHOLESTEROL HDL PRECIPITATING REAGENT	11648
CHOLESTEROL LDL DIRECT	11585
	12585
	21585
	23585
CHOLESTEROL LDL PRECIPITATING REAGENT	11579
CHOLINESTERASE (CHE)	11588
	11589
	21588
CITRATE	11795
	11895
	23795
CREATINE KINASE (CK)	11790
	11791
	12524
	21790

P.S.

PRODUCT NAME	CODE
	23790
CREATINE KINASE-MB (CK-MB)	11792
	12566
	21792
	23792
CREATININE	11802
	11502
	11542
	12502
	21502
	23502
CREATININE-ENZYMATIC	11734
	12734
	21734
FRUCTOSAMINE	11046
FRUCTOSE	11794
	23794
g-GLUTAMYLTRANSFERASE (g-GT)	11584
	11520
	12520
	21520
	23520
GLUCOSE	11803
	11503
	11504
	11538
	12503
	21503
	23503
GLUCOSE-HEXOKINASE	11656
	12756
	21656
	23656
IRON- CHROMAZUROL	11546
IRON-FERROZINE	11509
	12509
	21509
	23509
LACTATE	11736
	12736
	21736
	23736
LACTATE DEHYDROGENASE (LDH)	11580
	11581
	12580
	21580
	23580
LACTATE DEHYDROGENASE (LDH) - IFCC	11586
	11587
	21586
	23586

P-21

PRODUCT NAME	CODE
LIPASE	11793
	12793
	23793
MAGNESIUM	11797
	12797
	21797
	23797
PHOSPHORUS	11508
	12508
	21518
	23518
PROTEIN (TOTAL)	11800
	11572
	11500
	11553
	12500
	21513
	23513
PROTEIN (URINE)	11501
	11559
	12501
	21512
	23512
PYRIDOXAL PHOSPHATE	11666
TOTAL IRON BINDING CAPACITY (TIBC)	11554
TRIGLYCERIDES	11828
	11528
	11529
	12528
	21528
	23528
UNSATURATED IRON BINDING CAPACITY (UIBC)	11835
	12835
	21835
UREA/BUN - COLOR	11536
	11537
UREA/BUN - UV	11516
	11517
	11541
	12516
	21516
URIC ACID	23516
	11821
	11521
	11522
	11540
	12521
21521	
23521	
ZINC	12526
CLINICAL CHEMISTRY - TURBIDIMETRY	

175

PRODUCT NAME	CODE
a1-ACID GLYCOPROTEIN	31928
	23107
ALBUMIN (MICROALBUMINURIA)	31324
	31924
	13324
	22324
	23324
ACTIVATED PARTIAL THROMBOPLASTIN TIME (APTT)	61004
	61005
	61009
ANTI-STREPTOLYSIN O (ASO)	31323
	31923
	31031
	13923
	22923
	23923
ANTITHROMBIN III	31936
	13936
	22936
	23936
APOLIPOPROTEIN A-I (APO A-I)	31095
	23095
APOLIPOPROTEIN B (APO B)	31098
	23098
b2-MICROGLOBULIN	31925
	22925
	23925
COMPLEMENT COMPONENT C3	31073
	31079
	13084
	23103
COMPLEMENT COMPONENT C4	31074
	31080
	13085
	23104
C-REACTIVE PROTEIN (CRP)	31321
	31921
	31029
	13921
	22921
	23921
C-REACTIVE PROTEIN-hs (CRP-hs)	31927
	13927
	22927
	23927
FERRITIN	31934
	31935
	22934
	23934
	13934

2-4-1

PRODUCT NAME	CODE
FIBRINOGEN	31600
	13600
	22804
	23804
FIBRINOGEN CLAUSS	61002
	61003
	61020
HEMOGLOBIN A1C-DIRECT (HbA1C-DIR)	31047
	13047
	22047
	22147
IMMUNOGLOBULIN A (IgA)	31071
	31077
	13082
	23101
IMMUNOGLOBULIN G (IgG)	31070
	31076
	13081
	23100
IMMUNOGLOBULIN M (IgM)	31072
	31078
	13083
	23102
PREALBUMIN	31929
	23106
PROTHROMBIN TIME (PT)	61001
RHEUMATOID FACTORS (RF)	31322
	31922
	31030
	13922
	22922
23922	
THROMBIN TIME (TT)	61000
TRANSFERRIN	31091
	31092
	31093
	13091
	22105
	23105
CLINICAL CHEMISTRY - MICROCOLUMN CHROMATOGRAPHY	
17-HYDROXYCORTICOSTEROIDS (17-OH)	11006
17-KETOSTEROIDS	11002
5-AMINOLEVULINIC ACID (ALA) / PORPHOBILINOGEN (PBG)	11017
5-HYDROXYINDOLEACETIC ACID (5-HIAA)	11010
HEMOGLOBIN A2	11077
METANEPHRINES	11022
VANILMANDELIC ACID	11003
CLINICAL CHEMISTRY - STANDARDS & CALIBRATORS	

P-511

PRODUCT NAME	CODE
ADENOSINE DEAMINASE (ADA) STANDARD	18052
ALBUMIN (MICROALBUMINURIA) STANDARD	18011
AMMONIA/ETHANOL/CO2 CALIBRATOR	18065
ANTI-STREPTOLYSIN O (ASO) STANDARD	31119
APOLIPOPROTEIN A-I (APO A-I) STANDARD	31100
APOLIPOPROTEIN B (APO B) STANDARD	31200
b2-MICROGLOBULIN STANDARD	31122
BILIRUBIN STANDARD	11693
BIOCHEMISTRY CALIBRATOR	31075
BIOCHEMISTRY CALIBRATOR (HUMAN)	18044
CARBON DIOXIDE STANDARD	11822
	11833
CHOLESTEROL HDL/LDL CALIBRATOR	11824
COAGULATION CALIBRATOR	61006
CREATINE KINASE-MB (CK-MB) STANDARD	11750
CRP/CRP-hs STANDARD	31113
CRP-er STANDARD	31182
FERRITIN STANDARD	31127
FIBRINOGEN STANDARD	31601
HEMOGLOBIN A1C-DIRECT (HbA1C-DIR) STANDARDS	31048
HOMOCYSTEINE STANDARDS	11603
PREALBUMIN STANDARD	31196
PROTEIN (URINE) STANDARD	31130
PROTEIN CALIBRATORS	11513
RHEUMATOID FACTORS (RF) STANDARD	31116
CLINICAL CHEMISTRY - INSTRUMENTS	
A15	83105
A25	83101
BA400	83400
BA200	83200
BTS-350	80175
CONSUMABLES (INSTRUMENTS)	
ALKALINE WASHING SOLUTION	AC17204
	AC17205
ACID WASHING SOLUTION	AC17200
	AC17201
CONCENTRATED SYSTEM LIQUID	BO11524
CONCENTRATED SYSTEM LIQUID 2	AC17206
CONCENTRATED WASHING SOLUTION	BO13416
	AC16434
Reaction Rotor	AC11485
Sample Wells (1000 units)	AC10770
WASHING SOLUTION	AC10415
	BO10771
CLINICAL CHEMISTRY - BIOCHEMISTRY - REAGENTS AUTOMATED SYSTEMS A15/A25	
ADENOSINE DEAMINASE (ADA)	12754
	23754
AMMONIA	12532
	23532

25/11

PRODUCT NAME	CODE
ANGIOTENSIN CONVERTING ENZYME (ACE)	12796
	21796
b-HYDROXYBUTYRATE	12525
	21525
ETHANOL	12789
	21789
HOMOCYSTEINE	12737
	21737
	23737
OXALATE	12539
OXALATE PRETREATMENT REAGENTS	11839
TOTAL BILE ACIDS	12551
	21551
	23551
a-1-Microglobulin	22941
C-REACTIVE PROTEIN-er (CRP-er)	22942
	23942
CLINICAL CHEMISTRY - INTERNAL QUALITY CONTROL	
ADA CONTROLS	18048
AMMONIA/ETHANOL/CO2 CONTROL I	18063
AMMONIA/ETHANOL/CO2 CONTROL II	18064
b2-MICROGLOBULIN CONTROL URINE	31215
b2-MICROGLOBULIN CONTROLS	31592
BIOCHEMISTRY CONTROL SERUM (HUMAN) I	18042
BIOCHEMISTRY CONTROL SERUM (HUMAN) II	18043
BIOCHEMISTRY CONTROL SERUM I	18009
	18005
BIOCHEMISTRY CONTROL SERUM II	18010
	18007
BIOCHEMISTRY CONTROL URINE	18054
BIOCHEMISTRY CONTROL URINE II	18066
CK-MB CONTROL SERUM	18024
CK-MB CONTROL SERUM II	18061
COAGULATION CONTROL I	61007
COAGULATION CONTROL II	61008
CONTROL URINE	18036
	18037
FERTILITY BIOCHEMISTRY CONTROL	18053
FIBRINOGEN CONTROL PLASMA	31602
FRUCTOSAMINE CONTROL SERUM	18057
HEMOGLOBIN A1C CONTROL (ELEVATED)	18002
HEMOGLOBIN A1C CONTROL (NORMAL)	18001
HEMOGLOBIN A2 CONTROL	10011
HOMOCYSTEINE CONTROL I	18058
HOMOCYSTEINE CONTROL II	18059
LIPID CONTROL SERUM I	18040
LIPID CONTROL SERUM II	18041
OXALATE CONTROL URINE	18062
PROTEIN CONTROL SERUM I	31211
PROTEIN CONTROL SERUM II	31212

17-51

PRODUCT NAME	CODE
RHEUMATOID CONTROL SERUM I	31213
RHEUMATOID CONTROL SERUM	31214
AUTOIMMUNITY - IFA (IMMUNOFLUORESCENCE)	
ANTI-ADRENAL CORTEX ANTIBODIES (AACA)	44574
	44575
	29022
ANTI-ENDOMYSIUM ANTIBODIES (AEA)	44148
	44548
	44715
	44557
	44710
ANTI-ISLET CELL ANTIBODIES (AICA)	44609
	44572
ANTI-KERATIN ANTIBODIES (AKA)	44618
	44517
ANTI-MITOCHONDRIAL ANTIBODIES (AMA)	44510
	44514
	44511
	44515
ANTI-nDNA ANTIBODIES (nDNA)	44825
	44818
	44817
	44820
	44819
ANTI-NEUTROPHIL CYTOPLASMIC ANTIBODIES (ANCA)	44850
	44851
	44852
	44911
ANTI-NUCLEAR ANTIBODIES HEp-2 (ANA-HEp-2)	44108
	44508
	44509
	44546
	44547
ANTI-NUCLEAR ANTIBODIES RL (ANA-RL)	44506
	44507
ANTI-SKIN ANTIBODIES (ASA)	44560
	44561
ANTI-SMOOTH MUSCLE ANTIBODIES (ASMA)	44520
	44524
	44521
	44525
ANTI-STRIATED MUSCLE ANTIBODIES (AStMA)	44649
	29017
ANTI-THYROID ANTIBODIES (ATA)	44550
	44551
	29012
AUTOANTIBODIES DUO-HEp2/ML (DUO-HEp2/ML)	44874
AUTOANTIBODIES MSK/MSS (AA-MSK/MSS)	44518
AUTOANTIBODIES MSL/MSK/MSS (AA-MSL/MSK/MSS)	44826
	44827

P-51

PRODUCT NAME	CODE
AUTOANTIBODIES-RK/RS (AA-RK/RS)	44758
	44568
AUTOANTIBODIES-RL/RK/RS (AA-RL/RK/RS)	44558
	44648
	44570
	44639
GLOMERULAR BASEMENT MEMBRANE ANTIBODIES (GBMA)	44588
AUTOIMMUNITY - IFA (IMMUNOFLUORESCENCE) - AUXILIARY REAGENTS	
AACA POSITIVE CONTROL	44578
AEA POSITIVE CONTROL	44549
	44893
	44732
AICA POSITIVE CONTROL	44577
AKA POSITIVE CONTROL	44619
AMA POSITIVE CONTROL	44512
	44891
ANA-Ce POSITIVE CONTROL	44585
ANA-Ho POSITIVE CONTROL	44502
	44890
ANA-Nu POSITIVE CONTROL	44504
ANA-Sp POSITIVE CONTROL	44503
APCA POSITIVE CONTROL	44532
ASA-bm POSITIVE CONTROL	44562
ASA-is POSITIVE CONTROL	44563
ASMA POSITIVE CONTROL	44522
	44892
AStMA POSITIVE CONTROL	44883
ATA POSITIVE CONTROL	44553
BLOTTING PAPER 12	44669
BLOTTING PAPER 4	44731
BLOTTING PAPER 6	44667
BLOTTING PAPER 8	44716
C-ANCA POSITIVE CONTROL	44854
	44912
FITC/EVANS (R)	44590
	44836
	44916
GBMA POSITIVE CONTROL	44678
GLYCIN	44846
IgA FITC/EVANS	44692
	44835
IgG FITC/EVANS	44697
	44834
IgG FITC/EVANS (M)	44847
	44882
LKM POSITIVE CONTROL	44766
MOUNTING MEDIUM	44694
nDNA POSITIVE CONTROL	44542
	44894

2-4-1

PRODUCT NAME	CODE
NEGATIVE CONTROL	44696
	44889
P-ANCA POSITIVE CONTROL	44855
	44913
PBS (10x)	44592
X-ANCA POSITIVE CONTROL	44896
AUTOIMMUNITY - ELISA	
ANA-SCREENING	44785
ANTI-ANNEXIN V IgG/IgM (ANX)	44869
ANTI-beta-2-GLYCOPROTEIN 1 IgG/IgM (beta2GP1)	44868
ANTI-BPI ANTIBODIES	44905
ANTI-CARDIOLIPIN ANTIBODIES (ACA-IgG/IgM)	44780
ANTI-CATHEPSIN G ANTIBODIES	44906
ANTI-CENTROMERE B ANTIBODIES (CENP-B)	44865
ANTI-CITRULLINATED PROTEIN ANTIBODIES (ACPA)	44860
ANTI-DEAMIDATED GLIADIN PEPTIDES IgA (DGP IgA)	44885
ANTI-DEAMIDATED GLIADIN PEPTIDES IgG (DGP IgG)	44884
ANTI-dsDNA ANTIBODIES	44705
ANTI-ELASTASE ANTIBODIES	44907
ANTI-GBM ANTIBODIES-EIA (GBM)	44870
ANTI-GLIADIN ANTIBODIES (AGA-IgG/IgA)	44704
ANTI-HISTONES ANTIBODIES (HIS)	44862
ANTI-INSULIN ANTIBODIES (INS)	44873
ANTI-Jo1 ANTIBODIES	44864
ANTI-LACTOFERRIN ANTIBODIES	44908
ANTI-LYSOZYME ANTIBODIES	44909
ANTI-M2 ANTIBODIES (M2)	44871
ANTI-MPO ANTIBODIES (P-ANCA)	44790
ANTI-NUCLEOSOME ANTIBODIES (NCL)	44861
ANTI-PHOSPHOLIPID IgG/IgM (APLA)	44867
ANTI-PR3 ANTIBODIES (C-ANCA)	44791
ANTI-RIBOSOMAL P ANTIBODIES (Rib P)	44866
ANTI-Sci70 ANTIBODIES	44863
ANTI-Sm ANTIBODIES	44755
ANTI-Sm/RNP ANTIBODIES	44770
ANTI-SSA (Ro) ANTIBODIES	44765
ANTI-SS-B (La) ANTIBODIES	44750
ANTI-THYROGLOBULIN ANTIBODIES (ANTI-Tg)	44796
ANTI-THYROID PEROXIDASE ANTIBODIES (ANTI-TPO)	44795
ANTI-tTRANSGLUTAMINASE ANTIBODIES IgA (ANTI-tTG IgA)	44754
ANTI-tTRANSGLUTAMINASE ANTIBODIES IgG (ANTI-tTG IgG)	44798
ASCA-IgG/IgA (ASCA)	44872
ENA 4-PROFILE	44775
ENA 6-PROFILE	44910
ENA 6-SCREENING	44740
AUTOIMMUNITY - INSTRUMENTS	

P-1-1

PRODUCT NAME	CODE
iPRO	84101
RAPID TESTS - LATEX AGGLUTINATION	
ANTI-STREPTOLYSIN O (ASO) - SLIDE	31019
	31319
	31086
	31448
C-REACTIVE PROTEIN (CRP) - SLIDE	31011
	31311
	31012
	31107
RHEUMATOID FACTORS (RF) - SLIDE	31013
	31313
	31014
	31108
INFECTIOUS IMMUNOLOGY - SYPHILIS	
RPR-CARBON	36001
	36002
TPHA	36005
INFECTIOUS IMMUNOLOGY - FEBRILE ANTIGENS	
BRUCELLA ABORTUS	33309
BRUCELLA ABORTUS, ROSE BENGAL	33315
BRUCELLA POSITIVE CONTROL	33509
FEBRILE SERODIAGNOSTICS MULTISCREENING	33001
FEBRILE SERODIAGNOSTICS SALMONELLA	33080
	33081
PROTEUS OX19	33311
PROTEUS POSITIVE CONTROL	33502
SALMONELLA PARATYPHI AH	33301
SALMONELLA PARATYPHI AO	33302
SALMONELLA PARATYPHI BH	33303
SALMONELLA PARATYPHI BO	33304
SALMONELLA PARATYPHI CH	33305
SALMONELLA PARATYPHI CO	33306
SALMONELLA POSITIVE CONTROL	33510

P-6.1.

Annex to certificate

Standard **ISO 9001:2015**

Certificate Registr. No. **01 100 6696**

No.	Location	Scope
/01	BIOSYSTEMS S.A. Costa Brava 30 08030 Barcelona Spain	Design, development, manufacture, distribution, installation and service of instruments and reagents for: - Clinical diagnostics. - Agri-food analysis. - Veterinary diagnostics.
/02	BIOSYSTEMS, S.A. Pol. Ind. Can Tapiolas Naves 12, 13, 21 y 22 08110 Montcada i Reixac (Barcelona) Spain	Reagent labelling and assembly. Storage of raw materials for instruments, instruments and reagents for: - Clinical diagnostics. - Agri-food analysis. - Veterinary diagnostics. Dispatched of stored product.

2022-12-15



TÜV Rheinland Cert GmbH
Am Grauen Stein · 51105 Köln

Certificate

Standard **ISO 9001:2015**

Certificate Registr. No. **01 100 6696**

Certificate Holder: **BIOSYSTEMS S.A.**
Costa Brava 30
08030 Barcelona
Spain

including the locations according to annex

Scope: Design, development, manufacture, distribution, installation and service of instruments and reagents for:

- Clinical diagnostics.
- Agri-food analysis.
- Veterinary diagnostics.

Reagent labelling and assembly.
Storage of raw materials for instruments, instruments and reagents for:

- Clinical diagnostics.
- Agri-food analysis.
- Veterinary diagnostics.

Dispatched or stored product.

Proof has been furnished by means of an audit that the requirements of ISO 9001:2015 are met.

Validity: The certificate is valid from 2022-12-19 until 2025-12-18.
First certification 1996

2022-12-15



TÜV Rheinland Cert GmbH
Am Grauen Stein · 51105 Köln

Certificate

Quality Management System EN ISO 13485:2016

Registration No.: SX 1695779-1

Organization: BIOSYSTEMS S.A.
Costa Brava 30
08030 Barcelona
Spain

Scope: Design and development, production, distribution and servicing
of instruments and reagents for clinical diagnostic.

The Certification Body of TÜV Rheinland LGA Products GmbH certifies that the organization has established and applies a quality management system for medical devices. Proof has been furnished that the requirements specified in the abovementioned standard are fulfilled. The quality management system is subject to yearly surveillance.

Report No.: 92648791-40
Effective date: 2022-12-12
Expiry date: 2025-12-12
Issue date: 2022-12-12

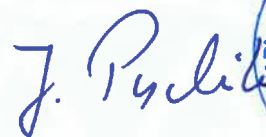

Jaroslaw Pyclik
TÜV Rheinland LGA Products GmbH
Tillystraße 2 · 90431 Nürnberg · Germany

Certificate

Quality Management System EN ISO 13485:2016

Registration No.: SX 1695779-1

Organization: BIOSYSTEMS S.A.
Costa Brava 30
08030 Barcelona
Spain

The scope of certification includes the following additional sites:

No.	Facility	Scope
/01	BIOSYSTEMS S.A. Costa Brava 30 08030 Barcelona Spain	Design and development, production, distribution and servicing of instruments and reagents for clinical diagnostic.
/02	BIOSYSTEMS S.A. Polígono Industrial Can Tapioles Naves 12, 13, 21, 22 08010, Montcada i Reixac – Barcelona, Spain	Labelling and assembling of reagents, warehousing and shipment of instruments and reagents for clinical diagnostic.

Report No.: 92648791-40
Effective date: 2022-12-12
Expiry date: 2025-12-12
Issue date: 2022-12-12



J. Pyclik



Jarosław Pyclik
TÜV Rheinland LGA Products GmbH
Tillystraße 2 · 90431 Nürnberg · Germany

Declaration of Conformity V 1.0

Declaration of Conformity



Manufacturer: Shenzhen Mindray Bio-Medical Electronics Co., Ltd.
Mindray Building, Keji 12th Road South, Hi-tech Industrial
Park, Nanshan, Shenzhen, 518057, P. R. China

EC-Representative: Shanghai International Holding Corp. GmbH (Europe)
Eiffestraße 80
20537 Hamburg, Germany

Product: **Auto Hematology Analyzer**

Model: **BC-5150**
Including reagents as following:
M-52D DILUENT
M-52DIFF LYSE
M-52LH LYSE
PROBE CLEANSER

Classification: The device not in IVDD annex II and not for self
testing/performance evaluation

Conformity Assessment Route: IVDD Annex III(excluding Section 6)

We herewith declare that the above mentioned products meet the provisions of the Directive 98/79/EC on In Vitro Diagnostic Medical Devices. All supporting documentations are retained under the premises of the manufacturer.

Standards Applied:

List of (harmonized) standards for which documented evidence for compliance can be provided as attachment.

Start of CE-Marking: 2013-9-26

Place, Date of Issue: Shenzhen, 2013-9-26

Signature: _____

Name of Authorized Signatory: Mr.tan ChuanBin
Position Held in Company: Manager ,Technical Regulation

Declaration of Conformity V 1.0

Applied Standards List

Product: Auto Hematology Analyzer
BC-5150、BC-5000
Including reagents as following:
M-52D DILUENT
M-52DIFF LYSE
M-52LH LYSE
PROBE CLEANSER

Applied Standards:

EN ISO 18113-1:2009	In vitro diagnostic medical devices —Information supplied by the manufacturer(labelling) Part 1: Terms, definitions and general requirements
EN ISO 18113-2:2009	In vitro diagnostic medical devices - Information supplied by the manufacturer (labelling) - Part 2: In vitro diagnostic reagents for professional use
EN ISO 18113-3:2009	In vitro diagnostic medical devices — Information supplied by the manufacturer (labelling) Part 3: In vitro diagnostic instruments for professional use
EN ISO 15223-1:2012	Medical devices — Symbols to be used with medical device labels, labelling and information to be supplied —Part 1: General requirements
EN 13612: 2002	Performance evaluation of in vitro diagnostic medical devices
ISO 14971:2012	Medical devices – Application of risk management to medical devices
EN 61010-1:2001	Safety requirements for electrical equipment for measurement, control, and laboratory use Part 1: General requirement
EN 61010-2-081:2002+A1: 2003+A1: 2003	Safety requirements for electrical equipment for measurement, control and laboratory use - Part 2-081: Particular requirements for automatic and semi-automatic laboratory equipment for analysis and other purposes
EN 61010-2-101: 2002	Safety requirements for electrical equipment for measurement, control, and laboratory use - Part 2-101: Particular requirements for in vitro diagnostic (IVD) medical equipment

Declaration of Conformity V 1.0

IEC 61010-2-010: 2005	Safety requirements for electrical equipment for measurement, control and laboratory use - Part 2-010: Particular requirements for laboratory equipment for the heating of materials
EN 61326-1:2006	Electrical equipment for measurement, control and laboratory use - EMC requirements - Part 1: General requirements
EN 61326-2-6:2006	Electrical equipment for measurement, control and laboratory use - EMC requirements - Part 2-6: Particular requirements - In vitro diagnostic (IVD) medical equipment
EN 62304:2008	Medical device software- Software life cycle processes
EN 62366:2008	Medical devices — Application of usability engineering to medical devices
EN 13640: 2002	Stability testing of in vitro diagnostic medical devices

Declaration of Conformity **CE**

Manufacturer: Shenzhen Mindray Bio-Medical Electronics Co., Ltd.
Mindray Building, Keji 12th Road South, Hi-tech Industrial
Park, Nanshan, Shenzhen, 518057, P. R. China

EC-Representative: Shanghai International Holding Corp. GmbH (Europe)
Eiffestraße 80
20537 Hamburg, Germany

Product: Auto Hematology Analyzer
Model: BC-3600

Including reagents as following:

M-30D DILUENT
M-30CFL LYSE
M-30R RINSE
PROBE CLEANSER

Classification: The device not in IVDD annex II and not for self
testing/performance evaluation

Conformity Assessment Route: IVDD Annex III(excluding Section 6)

We herewith declare that the above mentioned products meet the
provisions of the Directive 98/79/EC on In Vitro Diagnostic Medical
Devices. All supporting documentations are retained under the premises
of the manufacturer.

Standards Applied:

List of (harmonized) standards for which documented evidence for compliance can be
provided as attachment.

Start of CE-Marking: 2011-01-14

Place, Date of Issue: Shenzhen, 2011-01-14

Signature: _____

Name of Authorized Signatory: Mr. Yang Long

Position Held in Company: Management Representative

Declaration of Conformity



Manufacturer: Shenzhen Mindray Bio-Medical Electronics Co., Ltd.
Mindray Building, Keji 12th Road South, Hi-tech Industrial
Park, Nanshan, Shenzhen, 518057, P. R. China

EC-Representative: Shanghai International Holding Corp. GmbH (Europe)
Eiffestraße 80
20537 Hamburg, Germany

Product: Auto Hematology Analyzer

Model: BC-5000

Including reagents as following:
M-52D DILUENT
M-52DIFF LYSE
M-52LH LYSE
PROBE CLEANSER

Classification: The device not in IVDD annex II and not for self
testing/performance evaluation

Conformity Assessment Route: IVDD Annex III(excluding Section 6)

We herewith declare that the above mentioned products meet the provisions of the Directive 98/79/EC on In Vitro Diagnostic Medical Devices. All supporting documentations are retained under the premises of the manufacturer.

Standards Applied:

List of (harmonized) standards for which documented evidence for compliance can be provided as attachment.

Start of CE-Marking: 2013-9-26

Place, Date of Issue: Shenzhen, 2013-9-26

Signature: _____

Name of Authorized Signatory: Mr.tan ChuanBin

Position Held in Company: Manager ,Technical Regulation

Declaration of Conformity



Manufacturer: Shenzhen Mindray Bio-Medical Electronics Co., Ltd.
Mindray Building, Keji 12th Road South, Hi-tech Industrial
Park, Nanshan, Shenzhen, 518057, P. R. China

EC-Representative: Shanghai International Holding Corp. GmbH (Europe)
Eiffestraße 80
20537 Hamburg, Germany

Product: Auto Hematology Analyzer

Model: BC-5150

Including reagents as following:

M-52D DILUENT
M-52DIFF LYSE
M-52LH LYSE
PROBE CLEANSER

Classification: The device not in IVDD annex II and not for self
testing/performance evaluation

Conformity Assessment Route: IVDD Annex III(excluding Section 6)

We herewith declare that the above mentioned products meet the provisions of the Directive 98/79/EC on In Vitro Diagnostic Medical Devices. All supporting documentations are retained under the premises of the manufacturer.

Standards Applied:

List of (harmonized) standards for which documented evidence for compliance can be provided as attachment.

Start of CE-Marking: 2013-9-26

Place, Date of Issue: Shenzhen, 2013-9-26

Signature: _____

Name of Authorized Signatory: Mr.tan ChuanBin

Position Held in Company: Manager ,Technical Regulation

Applied Standards List

Product: Auto Hematology Analyzer

BC-5150、BC-5000

Including reagents as following:

M-52D DILUENT

M-52DIFF LYSE

M-52LH LYSE

PROBE CLEANSER

Applied Standards:

EN ISO 18113-1:2009	In vitro diagnostic medical devices —Information supplied by the manufacturer(labelling) Part 1: Terms, definitions and general requirements
ENISO 18113-2:2009	I In vitro diagnostic medical devices - Information supplied by the manufacturer (labelling) - Part 2: In vitro diagnostic reagents for professional use
EN ISO 18113-3:2009	In vitro diagnostic medical devices — Information supplied by the manufacturer(labeling) Part 3: In vitro diagnostic instruments for professional use
EN ISO 15223-1:2012	Medical devices — Symbols to be used with medical device labels, labelling and information to be supplied —Part 1: General requirements
EN 13612: 2002	Performance evaluation of in vitro diagnostic medical devices
ISO 14971:2012	Medical devices – Application of risk management to medical devices
EN 61010-1:2001	Safety requirements for electrical equipment for measurement, control, and laboratory use Part 1: General requirement
EN 61010-2-081:2002+A1: 2003+A1: 2003	Safety requirements for electrical equipment for measurement, control and laboratory use - Part 2-081: Particular requirements for automatic and semi-automatic laboratory equipment for analysis and other purposes
EN 61010-2-101: 2002	Safety requirements for electrical equipment for measurement, control, and laboratory use - Part 2-101: Particular requirements for in vitro diagnostic (IVD) medical equipment

Declaration of Conformity V 1.0

IEC 61010-2-010: 2005	Safety requirements for electrical equipment for measurement, control and laboratory use - Part 2-010: Particular requirements for laboratory equipment for the heating of materials
EN 61326-1:2006	Electrical equipment for measurement, control and laboratory use - EMC requirements - Part 1: General requirements
EN 61326-2-6:2006	Electrical equipment for measurement, control and laboratory use - EMC requirements - Part 2-6: Particular requirements - In vitro diagnostic (IVD) medical equipment
EN 62304:2008	Medical device software- Software life cycle processes
EN 62366:2008	Medical devices — Application of usability engineering to medical devices
EN 13640: 2002	Stability testing of in vitro diagnostic medical devices

AMZ MEDICAL

Declaration of Conformity



Manufacturer: Shenzhen Mindray Bio-Medical Electronics Co., Ltd.
Mindray Building, Keji 12th Road South, Hi-tech Industrial
Park, Nanshan, Shenzhen, 518057, P. R. China

EC-Representative: Shanghai International Holding Corp. GmbH (Europe)
Eiffestraße 80
20537 Hamburg, Germany

Product: **Auto Hematology Analyzer**
Model: **BC-3600**
Including reagents as following:
M-30D DILUENT
M-30CFL LYSE
M-30R RINSE
PROBE CLEANSER

Classification: The device not in IVDD annex II and not for self testing/performance evaluation

Conformity Assessment Route: IVDD Annex III(excluding Section 6)

We herewith declare that the above mentioned products meet the provisions of the Directive 98/79/EC on In Vitro Diagnostic Medical Devices. All supporting documentations are retained under the premises of the manufacturer.

Standards Applied:

List of (harmonized) standards for which documented evidence for compliance can be provided as attachment.

Start of CE-Marking: 2011-01-14

Place, Date of Issue: Shenzhen, 2012.12.7

Signature: _____
[Handwritten signature]

Name of Authorized Signatory: Mr. Tan ChuanBin

Position Held in Company: Manager ,Technical Regulation

Declaration of Conformity



Manufacturer: Shenzhen Mindray Bio-Medical Electronics Co., Ltd.
Mindray Building, Keji 12th Road South, Hi-tech Industrial
Park, Nanshan, Shenzhen, 518057, P. R. China

EC-Representative: Shanghai International Holding Corp. GmbH (Europe)
Eiffestraße 80
20537 Hamburg, Germany

Product: **Auto Hematology Analyzer**
Model: **BC-3300**
Including reagents as following:
M-30D DILUENT
M-30CFL LYSE
M-30R RINSE
PROBE CLEANSER

Classification: The device not in IVDD annex II and not for self
testing/performance evaluation

Conformity Assessment Route: IVDD Annex III(excluding Section 6)

We herewith declare that the above mentioned products meet the provisions of the Directive 98/79/EC on In Vitro Diagnostic Medical Devices. All supporting documentations are retained under the premises of the manufacturer.

Standards Applied:

List of (harmonized) standards for which documented evidence for compliance can be provided as attachment.

Start of CE-Marking: 2011-01-14

Place, Date of Issue: Shenzhen, 2012-12-7

Signature: _____ 谭传斌

Name of Authorized Signatory: Mr. Tan ChuanBin

Position Held in Company: Manager ,Technical Regulation

Declaration of Conformity



Manufacturer: Shenzhen Mindray Bio-Medical Electronics Co., Ltd.
Mindray Building, Keji 12th Road South, Hi-tech Industrial
Park, Nanshan, Shenzhen, 518057, P. R. China

EC-Representative: Shanghai International Holding Corp. GmbH (Europe)
Eiffestraße 80
20537 Hamburg, Germany

Product: **Auto Hematology Analyzer**
Model: **BC-3300CT**
Including reagents as following:
M-30D DILUENT
M-30CFL LYSE
M-30R RINSE
PROBE CLEANSER

Classification: The device not in IVDD annex II and not for self
testing/performance evaluation

Conformity Assessment Route: IVDD Annex III(excluding Section 6)

We herewith declare that the above mentioned products meet the provisions of the Directive 98/79/EC on In Vitro Diagnostic Medical Devices. All supporting documentations are retained under the premises of the manufacturer.

Standards Applied:

List of (harmonized) standards for which documented evidence for compliance can be provided as attachment.

Start of CE-Marking: 2011-01-14

Place, Date of Issue: Shenzhen, 2012.12.7

Signature: _____
[Handwritten signature]

Name of Authorized Signatory: Mr. Tan ChuanBin

Position Held in Company: Manager ,Technical Regulation

Declaration of Conformity



Manufacturer: Shenzhen Mindray Bio-Medical Electronics Co., Ltd.
Mindray Building, Keji 12th Road South, Hi-tech Industrial
Park, Nanshan, Shenzhen, 518057, P. R. China

EC-Representative: Shanghai International Holding Corp. GmbH (Europe)
Eiffestraße 80
20537 Hamburg, Germany

Product: **Auto Hematology Analyzer**
Model: **ULTIMA 3**
Including reagents as following:
M-30D DILUENT
M-30CFL LYSE
M-30R RINSE
PROBE CLEANSER

Classification: The device not in IVDD annex II and not for self
testing/performance evaluation

Conformity Assessment Route: IVDD Annex III(excluding Section 6)

We herewith declare that the above mentioned products meet the provisions of the Directive 98/79/EC on In Vitro Diagnostic Medical Devices. All supporting documentations are retained under the premises of the manufacturer.

Standards Applied:

List of (harmonized) standards for which documented evidence for compliance can be provided as attachment.

Start of CE-Marking: 2011-08-19

Place, Date of Issue: Shenzhen, 2012-12-7

Signature: _____ 谭传斌

Name of Authorized Signatory: Mr. Tan ChuanBin

Position Held in Company: Manager ,Technical Regulation

Applied Standards List

Product: **Auto Hematology Analyzer**
BC-3600 、 BC-3300、 BC-3300CT、 ULTIMA 3
Including reagents as following:
M-30D DILUENT
M-30CFL LYSE
M-30R RINSE
PROBE CLEANSER

Applied Standards:

EN ISO 18113-1:2011	In vitro diagnostic medical devices - Information supplied by the manufacturer (labelling) - Part 1: Terms, definitions and general requirements
EN ISO 18113-2:2011	In vitro diagnostic medical devices - Information supplied by the manufacturer (labelling) - Part 2: In vitro diagnostic reagents for professional use
EN ISO 18113-3:2011	In vitro diagnostic medical devices - Information supplied by the manufacturer (labelling) - Part 3: In vitro diagnostic instruments for professional use
ISO 15223-1:2012	Medical devices — Symbols to be used with medical device labels, labelling and information to be supplied —Part 1: General requirements
EN 13612:2002	Performance evaluation of in vitro diagnostic medical devices
EN 13640: 2002	Stability testing of in vitro diagnostic reagents
EN 13641: 2002	Elimination or reduction of risk of infection related to in vitro diagnostic medical devices
EN ISO 14971:2007	Medical devices - Application of risk management to medical devices
EN 61010-1:2001	Safety requirements for electrical equipment for measurement, control, and laboratory use Part 1: General requirement
EN 61010-2-101: 2002	Safety requirements for electrical equipment for measurement, control, and laboratory use - Part 2-101: Particular requirements for in vitro diagnostic (IVD) medical equipment
IEC 61010-2-010:2005	Safety requirements for electrical equipment for measurement,

Declaration of Conformity V 4.0

EN 61010-2-081:2002 ++A1: 2003	control and laboratory use - Part 2-010:Particular requirements for laboratory equipment for heating of materials Safety requirements for electrical equipment for measurement, control and laboratory use - Part 2-081: Particular requirements for automatic and semi-automatic laboratory equipment for analysis and other purposes
EN 61326-1;2006	Electrical equipment for measurement control and laboratory use-EMC requirements-Part1: General requirement
EN 61326-2-6:2006	Electrical equipment for measurement control and laboratory use-EMC requirements-Part2-6: Particular requirement-In vitro diagnostic (IVD) medical equipment
EN 62366:2008	Medical devices —Application of usability engineering to medical devices
EN 62304 :2008	Medical device software- Software life cycle processes
ISO13485:2003/AC:2009	Medical devices - Quality management systems - Requirements for regulatory purposes