



SIDAPHARM[®]

Ophthalmic & Medical Disposable Products

Ophthalmic Catalogue

Who we are

Sidapharm was founded in 2000 and is a CE-certified manufacturer of a vast range of ophthalmic products such as intraocular lenses, knives and cannulas, viscoelastics, BSS, cataract kits and ophthalmic instruments. Based in Thessaloniki, Greece, a city which connects Europe with Asia, Middle East and Africa, the company managed to take advantage of its location, expand its network and build strong collaborations through these continents.

Nowadays, Sidapharm has presence in more than 50 countries, mostly through very dynamic and reliable distributors. Our focus is on investing in long-lasting partnerships and on that ground we assist our distributors in every possible way, to become competitive and win every day bigger market shares.



Table of contents

Who we are

1

Intraocular Lenses

2-5

Ophthalmic Microsurgical Knives

6-7

Ophthalmic Cannulas

8-9

Ophthalmic Viscoelastics (OVDs)

10

Ophthalmic Solutions

11

Miscellaneous Disposables

12

Cataract Packs

13

Surgical Apparel

13

Intraocular Lenses

Embracing the constant need for development and improvement Sidapharm's IOLs result in an innovative and high-quality product.

Thoroughly inspected for their resolution, diopter, surface quality and dimensions they provide excellent perception.

After IOL implantation recipients enjoy optimal optical outcome.

The IOLs are accompanied by an injector and can be smoothly implanted through a small incision

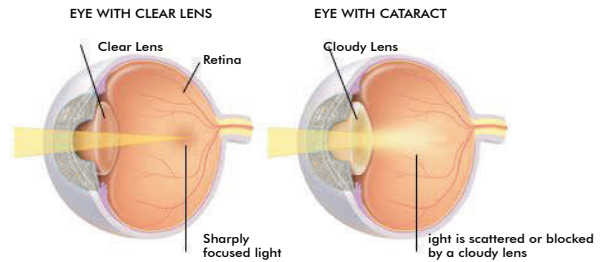

Hydrophobic IOLs

CAST MOLDING TECHNOLOGY

Superb quality of raw materials using pre-molded blanks

Biocompatible hydrophobic acrylic material with UV absorption

With Biconvex surfaces which minimize effects of tilt, decentration and aberration and with a 360° square-edge profile for reduced PCO rates

PREMIUM PRECISION

HYDROPHOBIC PRELOADED SYSTEM SDHBP

Tip that facilitates easy delivery through small incision

Ergonomic grip

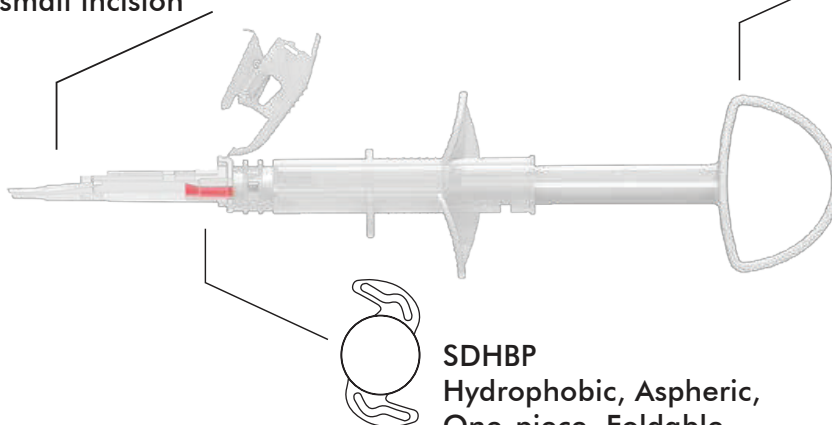

SDHBP
Hydrophobic, Aspheric,
One-piece, Foldable,
Acrylic IOL

HYDROPHOBIC IOL SDHB6130

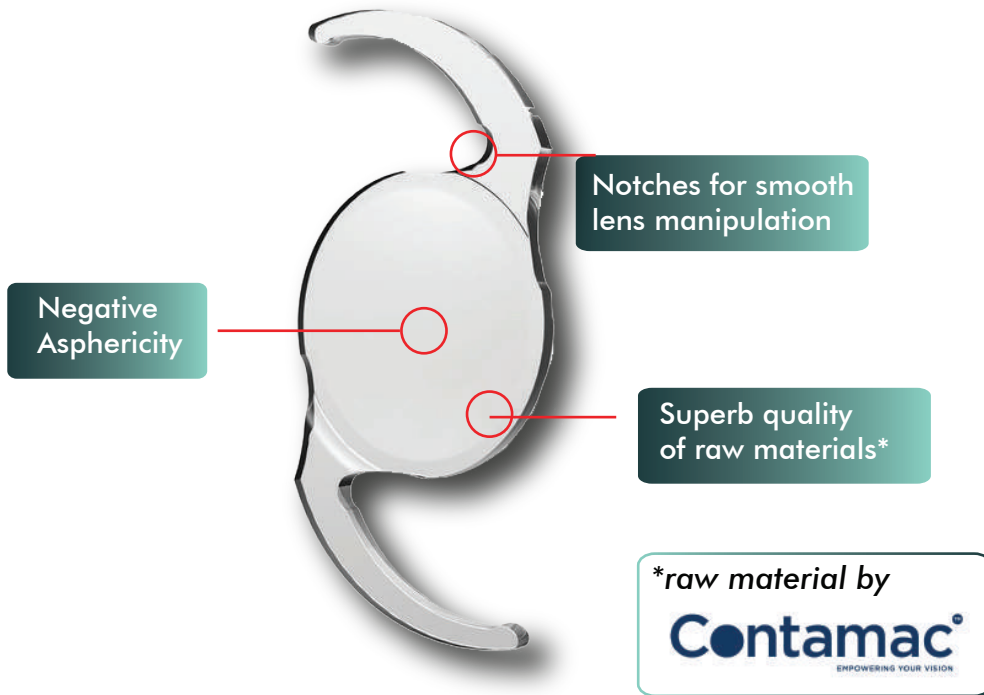

SDHB6130

Aspheric,
360° Square Edge

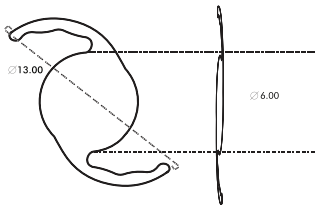

Optic Design: Biconvex
Optic Size: 6.00
Overall Length: 13.00
Haptic Angle: 0°
Refractive Index 1.56
A-constant: 118.5

SDHBY

Aspheric,
360° Square Edge
Yellow, Blue Light Filtering

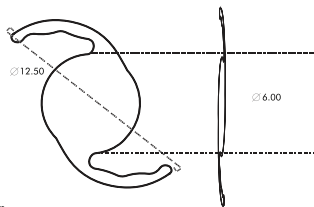

Optic Design: Biconvex
Optic Size: 6.00
Overall Length: 12.50
Haptic Angle: 0°
Refractive Index 1.5430
A-constant: 118.5

SDHB

Aspheric,
360° Square Edge

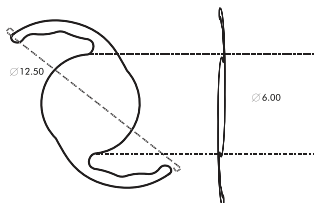

Optic Design: Biconvex
Optic Size: 6.00
Overall Length: 12.50
Haptic Angle: 0°
Refractive Index 1.56
A-constant: 118.5

Hydrophilic IOLs

Exceptional biocompatibility and UV absorption

High Resolution, Diopter Accuracy Preciseness

Easy lens manipulation

Controlled surgical handling

SDA
Aspheric,
360° Square Edge

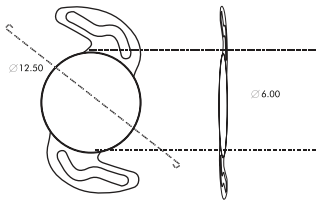

Optic Design: Biconvex
Optic Size: 6.00
Overall Length: 12.50
Haptic Angle: 5°
Refractive Index: 1.46
A-constant: 118.0

SDYA ■
Aspheric,
360° Square Edge,
Yellow, Blue Light Filtering

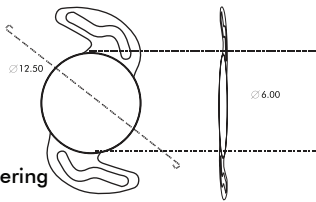

Optic Design: Biconvex
Optic Size: 6.00
Overall Length: 12.50
Haptic Angle: 5°
Refractive Index: 1.46
A-constant: 118.0

SDAC
Aspheric,
360° Square Edge

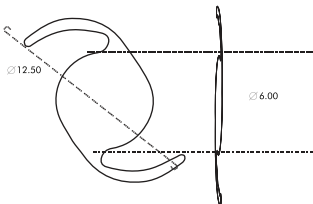

Optic Design: Biconvex
Optic Size: 6.00
Overall Length: 12.50
Haptic Angle: 5°
Refractive Index: 1.46
A-constant: 118.0

SDACY ■
Aspheric,
360° Square Edge
Yellow, Blue Light Filtering

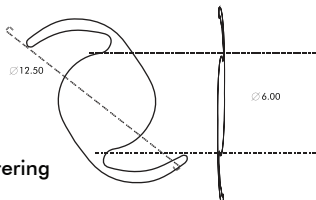

Optic Design: Biconvex
Optic Size: 6.00
Overall Length: 12.50
Haptic Angle: 5°
Refractive Index: 1.46
A-constant: 118.0

SDA4
Aspheric,
360° Square Edge

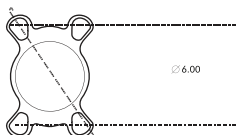

Optic Design: Biconvex
Optic Size: 6.00
Overall Length: 11.00
Haptic Angle: 5°
Refractive Index: 1.46
A-constant: 118.0

PMMA, One-Piece

Clinical quality PMMA with **UV absorber**

YAG laser compatible

ANTERIOR CHAMBER

SDANT

4 points of fixation

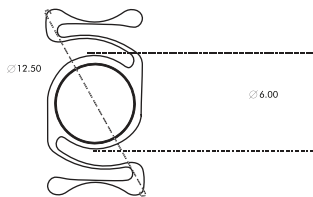

Optic Design: Equiconvex
Optic Size: 6.00
Overall Length: 12.50
Haptic Design: S Loop
Refractive Index 1.487
A-constant: 115.3

POSTERIOR CHAMBER

SDHS

2 Dialing holes

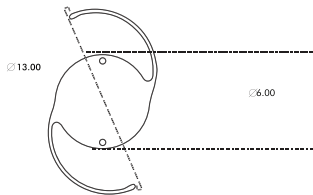

Optic Design: Equiconvex
Optic Size: 6.00
Overall Length: 13.00
Haptic Design: C Loop
Refractive Index 1.487
A-constant: 118.2

SDALP

2 Dialing holes

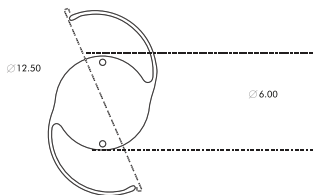

Optic Design: Equiconvex
Optic Size: 6.00
Overall Length: 12.50
Haptic Design: C Loop
Refractive Index 1.487
A-constant: 118.4

SDSFP

2 Eyelets

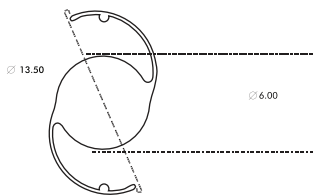

Optic Design: Equiconvex
Optic Size: 6.50
Overall Length: 13.50
Haptic Design: C Loop
Refractive Index 1.487
A-constant: 118.2

Ophthalmic Microsurgical Knives

Chemically polishing technology

Minimized micro-roughness

Cleanability of surfaces

Low contamination levels

Effect of chemical polishing on surface finish



Surface Before Electropolishing



Surface After Electropolishing

© KEPCO, Inc.

Check our Superiority!
(microscope photos)



SIDAPHARM®
Knives

- ✓ Even Edges
- ✓ Smooth Surface



- Other
Grinded Knives
- ✗ Uneven Edges
 - ✗ Scratched Surface

Sharpness Comparison

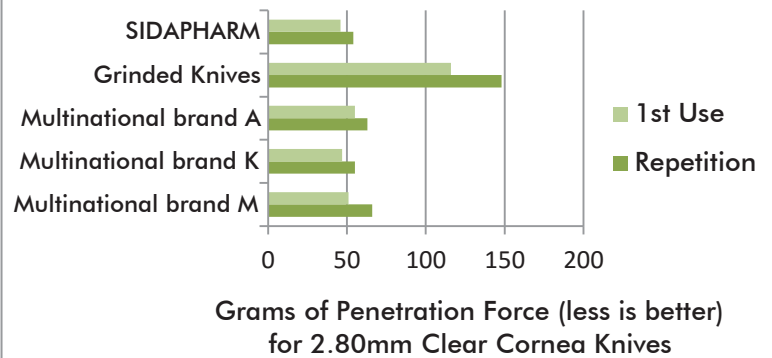

Precision
Diamond like
sharpness
Exact Dimensions

Quality
Matt
anti-glare
finish

Performance
Incisions with
accuracy and
complete control

Minimum wound for rapid healing
Perfect visibility of the blade within the eye chamber



Ophthalmic Microsurgical Knives

All-procedures microsurgical knives

Our knives allow enhanced control and precision, deliver great sharpness and quality, while maintaining the cost low.

Stab Knives



Ref. No.	Description
62000	15°
62021	22.5°
62001	30°
62002	45°

Crescent Knives



Ref. No.	Description
62003	Angled
62003 - 1	Straight

MVR Knives



Ref. No.	Description
62004	19G Straight
62009	19G Angled
62005	20G Straight
62010	20G Angled
62007	23G Straight
62012	23G Angled

Slit Knives



Ref. No.	Description
62016*	2.20mm Angled
62017*	2.40mm Angled
62052	2.60mm Angled
62018 - 1*	2.75mm Angled
62018*	2.80mm Angled
62019*	3.00mm Angled
62020*	3.20mm Angled

Implant Knives (Rounded Tip)



Ref. No.	Description
62015	5.10mm Angled
62027	5.20mm Angled

*Double Bevel also available

Ophthalmic Cannulas

Steel and Plastic of the highest quality
Guaranteed hygiene
Constant Development & Improvement

Cystotomes

Formed, 16mm tip

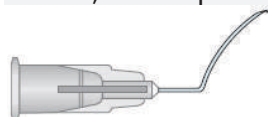

Ref. No.	Description
77005	23G
77006	25G
77007	27G
77008	30G

Anterior Chamber

Viscoelastic, angled 22mm, formed

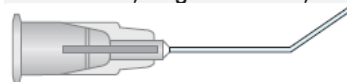

77104	25G
77082	27G

Rycroft / Air Cannula , angled tip

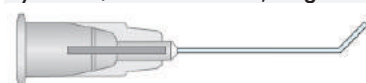

77044	23G, 4mm
77001	25G, 8mm
77003 - 1	27G, 4mm
77056	27G, 8mm
77003	27G, 10mm
77046	30G, 4mm
77004	30G, 6mm

Hydrodissectors

Angled, flat tip



77062	23G, 8mm tip
77010	25G, 8mm tip
77012	27G, 8mm tip
77013	30G, 8mm tip

Curved, flat tip

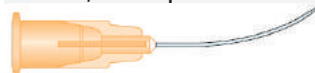

77014	27G, Horizontal tip
77063	27G, Vertical tip

J-shaped, vertical flat tip



77067	25G
77068	27G

Capsule Polishers

Posterior, angled top port

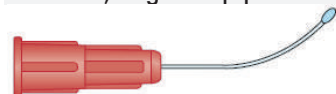

77073	21G, 9mm tip
77074	23G, 9mm tip



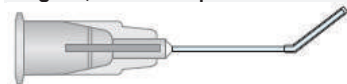

Angled, silicon tip



77070	23G, 7mm tip
77072	23G, 9mm tip
77071	27G, 7mm tip

Ophthalmic Cannulas

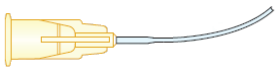
Anesthesia

	Ref. No.	Description
Retrobulbar, straight Atkinson tip		
	77026	23G, 38mm tip
	77027	25G, 38mm tip
	77028	27G, 38mm tip
Retrobulbar, curved Atkinson tip		
	77033	25G, 38mm tip
Retrobulbar, straight sharp tip		
	77034	25G, 25mm tip
	77035	25G, 38mm tip
	77036	30G, 12.5mm tip
Subtenon		
	77032	19G, 22mm tip
Peribulbar, straight Atkinson tip		
	77029	23G, 22mm tip
	77037	23G, 32mm tip
	77030	25G, 22mm tip
	77038	25G, 32mm tip

A/C Maintainers

	77015	19G, Screw tip
	77088	19G, Smooth tip
	77016	20G, Screw tip
	77041	20G, Smooth tip
	77089	21G, Smooth tip
	77040	23G, Screw tip

Simcoe

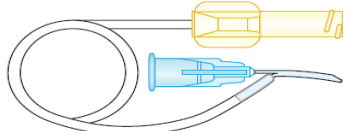
	77022	20G
	77025	23G

Lacrimal

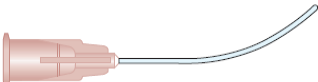
Lacrimal, 28mm		
	77021	26G

Intubation Set

	77083	23G, 17.5cm Straight tip
	77084	23G, 11cm Olive tip

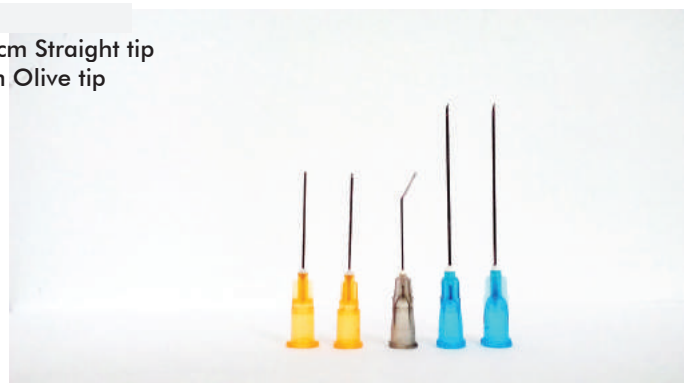

Ophthalmic Viscoelastics (OVDs)

SODIUM HYALURONATE Ophthalmic Solution

Provides the protection and control needed during the ophthalmic operations of :

- > Cataract extraction
- > IOL implantation
- > Glaucoma filtering surgery
- > Corneal transplantation surgery

Product features:

- > High viscosity for space creation during operations
- > Very easy injection and removal from the eye
- > Latex-free
- > It provides excellent endothelial protection
- > Ideal for cartridge lubrication during IOL implantation



Available in 1 ml pre-filled syringe with the following concentrations (cohesive/dispersible)

10mg/ml 14mg/ml 15 mg/ml 18 mg/ml



HPMC 2% Hydroxypropyl Methyl Cellulose (HPMC) Ophthalmic solution

Offering an ophthalmic viscosurgical device that has low viscosity properties, is ideal for coating and protecting the eye during anterior segment surgical procedures.

HPMC 2% exhibits moderate viscoelasticity characteristics, with retentive but also excellent tissue coating abilities. Offers good space maintenance and excellent tissue protection throughout the ophthalmic procedure

KEY Product features

- > Low molecular weight and low surface tension
- > High concentration of HPMC
- > Non-antigenic (allergic)
- > Non-pyrogenic
- > Completely transparent
- > Sterile pre-filled syringe supplied with a cannula
- > Available in 2 ml luer-lock glass syringe
- > Preservative-free

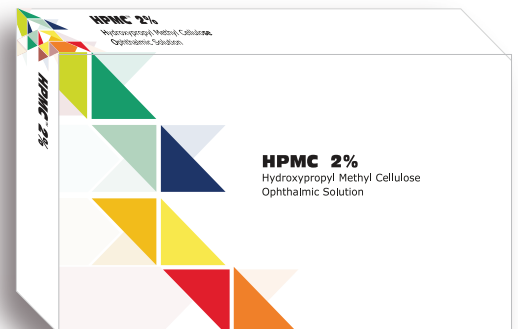

Preservative-free
Ambient storage

Ophthalmic Solutions

TRYPAN BLUE

Ophthalmic Solution 0.06 v/w

Excellent visualization of the capsulorhexis in eyes with mature cataract or small pupils
Clear outline of the capsulorhexis rim during the entire surgery.
Capsule staining is quick, easy and safe to perform.
Creates excellent staining contrast for anterior and posterior capsulorhexis
Reduces surgical time.



Indicated for:

- > For Cataract surgery with poor red reflex
- > Phacoemulsification
- > Small incision cataract surgery
- > Extra capsular cataract surgery
- > Incomplete capsulorhexis
- > Anterior/posterior capsulotomy
- > Any high risk cataract case
- > Trauma Cases
- > Teaching trainee surgeons

Available in :
1 ml vial



Prefilled syringe
Ready to use syringe. NO mixing required.
Ergonomic grip for better control of the injection



BSS Balanced Salt Solution

BSS is a sterile physiological solution for use in irrigating ocular tissues of the eye.
It hydrates and protects tissues and cells during any ophthalmic surgery.

Indicated for:

- > Refractive surgery
- > Phacoemulsification
- > Vitrectomy
- > Corneal irrigation

Available in a two way volumetric 500ml plastic bottle
with retractable, attached, hanging loop at the base.

Now also available in 250ml & 500ml GLASS BOTTLE



Miscellaneous Disposables

IRIS RETRACTORS

Flexible hooks used to increase pupillary diameter during surgery. The attached silicon stopper allows better grip and easy adjustment of pupil size .

Provided in a sterile pack of 5 pieces



CTR / CAPSULAR TENSION RINGS

Rings in order to safely ensure stability and support centration.

Available in variations in sizes



EYE SPEARS

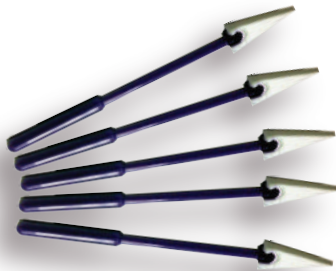

A soft, absorbing tool to drain excessive fluids.

Provided in a sterile pack of 5 pieces, available in PVA or Cellulose material.

EYE SHIELDS



For preventive use after surgery. Made from light and strong plastic, protects the eye and keeps it properly ventilated.

Non-sterile

Cataract Packs

Specially designed for cataract eye operations.
Ideal as one-stop supply solution.
Great quality for great price.

Basic Cataract Pack

Designed to be user friendly, convenient and efficient in order to meet any special needs of the doctor and the surgical team

- 1 x Table Cover (140cm x 150cm)
- 1 x Ophthalmic Drape with pouch (100cm x 120cm)
- 1 x Surgical Drape (100cm x 160cm)
- 1x 1 ml syringe 26g
- 2x 3ml syringe
- 2x 5ml syringe
- 1x 10ml syringe
- 10x Gauze swab 7.5 x 7.5
- 1x Eye Pad
- 2x Gowns with towels (Large)
- 1x 60 ml plastic bowl
- 5x Eye spears

Custom Cataract Pack

Build your own customized surgery pack choosing among the full range of cataract and ophthalmic disposables product line.

Contact SIDAPHARM'S team to prepare a high-quality and cost effective pack.



Surgical Apparel

After years of constant research and cooperation with doctors our complete line of surgical apparel is here to cover your needs. Individually sterile packaging optimizes time and resources .

Bigger variety is available in sizes and features(i.e. adhesive tape).
Custom solutions !

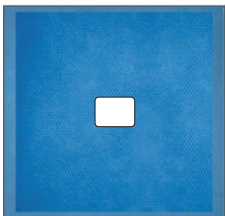

20028
Ophthalmic Drape
Biflex 2ply
50cm x 60 cm

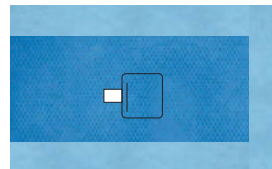

20029
Ophthalmic Drape
Biflex 2ply
With pouch and
incision film
40cm x 60cm

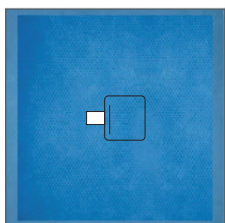

20014
Ophthalmic Drape
45g SMS
With pouch and
incision film
100cm x 120 cm



25001
Surgical Gown
50g SMS non-woven
Fluid repellent
Provides unrestricted
movement

21, Stageiriti & 24, Em.Fili str.
Thessaloniki, Gr-54352, Greece
Tel. +30 2310906660
Fax +30 2310989846
sales@sidapharm.gr
www.sidapharm.gr

All figures and images used are for illustrative purposes only. They are indicative of the quality and style of the specification and may not represent wholly the actual items. The specifications may be subject to change. Please ask our sales adviser for details. Whilst all reasonable care has been taken in providing true information, we accept no responsibility for the accuracy of any information contained herein.

SIDAPHARM[®]
introduces: **SDHBP**

PRELOADED

Hydrophobic IOL

PREMIUMPRECISION

Tip that facilitates
easy delivery
through small incision

Ergonomic grip

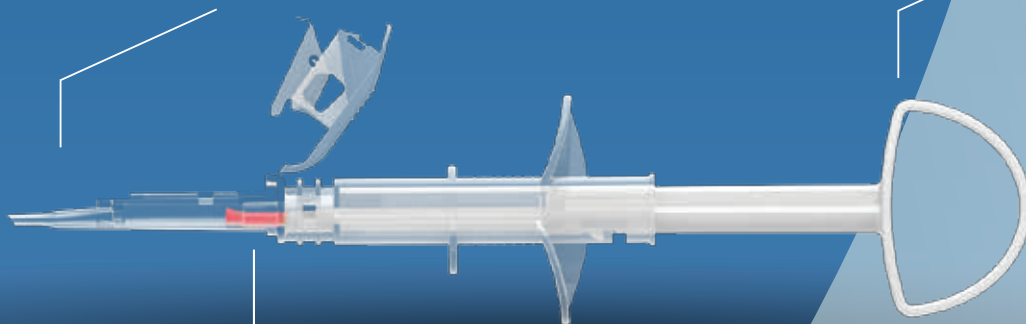

SDHBP
Hydrophobic, Aspheric,
One-piece, Foldable,
Acrylic IOL

fullyPRELOADED

Technical Detail

IOL Model	SDHBP
Optic Design	BICONVEX
Optic Size	6.00
Overall Length	13.00
Haptic Angle	0°
A-constant	118.5
AC depth	5.0
Further information	360°, Square-Edge

Additional detail

Superb quality of raw materials using pre-molded blanks

Cast molding technology, which delivers optics of the highest quality with a **negative asphericity** of -0.25

Biocompatible hydrophobic acrylic material with UV absorption

The refractive index of the material is **1.56**

Products are CE-certified



SIDAPHARM[®]

Ophthalmic & Medical Disposable Products

21, Stageiriti & 24, Em.Fili str.
Thessaloniki, GR-54352, Greece

T: +30 2310906660

www.sidapharm.gr

sales@sidapharm.gr

PRELOADED Hydrophobic IOL

Instructions

Release safety

1

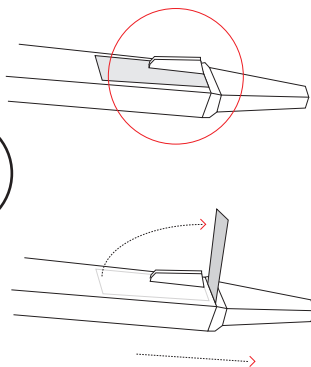

2

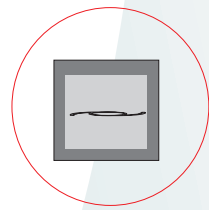
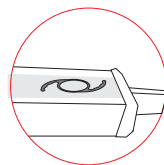
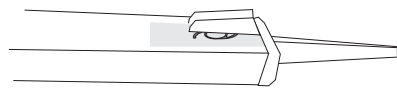

Make sure that IOL is straight and properly placed

3

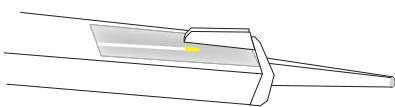

Apply **SIDA-VISC**[®]
into cartridge slot

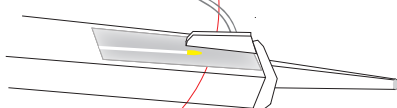
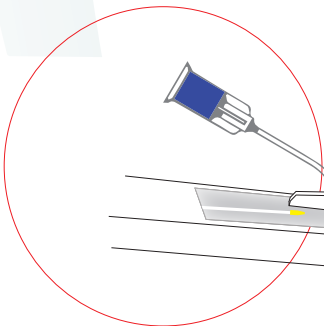

4

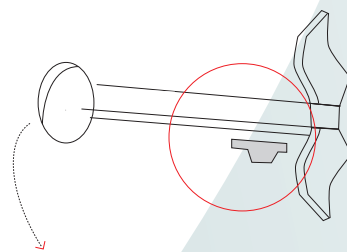

Remove safety pin
and start implantation

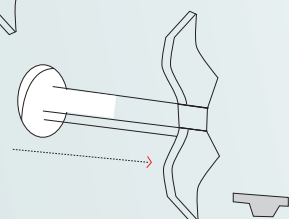

SIDA - LENS

by:  **SIDAPHARM**[®]
Ophthalmic & Medical Disposable Products

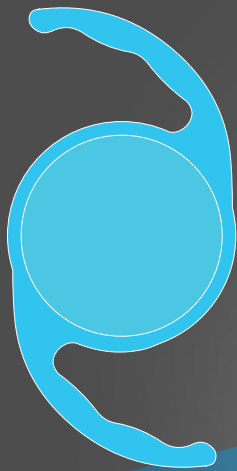

Hydrophobic
One-Piece, Acrylic,
Foldable, Intraocular Lens

Hydrophobic IOL

_ Superb quality of raw materials using **pre-molded blanks** manufactured by Contateq®, the Netherlands

_ Using the cast molding technology, which is available to extremely few manufacturers, **Sidapharm** delivers optics of the highest quality **with a negative aspericity of -0.25** and **glistening-free intraocular lens**

_ Biocompatible hydrophobic acrylic material with UV absorption

_ With Biconvex surfaces which minimize effects of tilt, decentration and aberration and **with a 360° square-edge profile** for reduced **PCO rates**

_ Haptic's design carries a notch for smooth lens manipulation

_ The refractive index of the material is **1.56**, one of the best available in the market

_ High refractive index helps us to reach **low center thickness** of the optic allowing a **smooth delivery of the IOL** through **smaller incisions**

_ Easily inserted through a 2.0mm incision

_ Accompanied by cartridges manufactured in Europe

_ Wide diopter range; 0.0 to +34.0 D, in half diopter steps (out-of-range diopters available upon request)

_ Products are CE-certified

_ Company is certified for implementing a Quality Management System according to **ISO 9001:2008 & ISO 13485:2012** standards

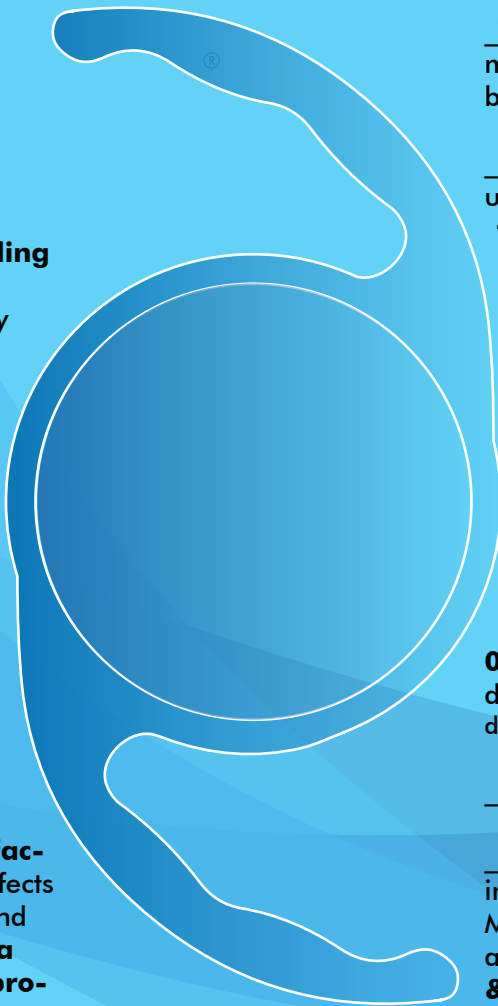

 **SIDAPHARM**
Ophthalmic & Medical Disposable Products

21, Stageiriti & 24, Em.Fili str.
Thessaloniki, Gr-54352, Greece
T: +30 2310906660 www.sidapharm.gr

TRYPAN BLUE PFS

Ophthalmic solution 0.06%



PFS

Trypan Blue 
Prefilled syringe (1.0ml)

Smooth opening and simple to use
Time Saving
Sterility maintenance

Ergonomic grip
Better control of the injection

Good value for money

Sidacel

MAKES THE DIFFERENCE
Soluble Hemostatic Gauze
from Oxidized Regenerated Cellulose



Sidacel ENT

MAKES THE DIFFERENCE
New Hemostatic Ear/Nasal sponges



SIDAPHARM[®]
Ophthalmic & Medical Disposable Products



SOLUBLE HEMOSTATIC GAUZE FROM OXIDIZED REGENERATED CELLULOSE

SIDACEL hemostatic gauze, from **100% oxidized, regenerated cellulose** derived from plants, is intended to control bleeding. Accelerates the coagulation process, while interrupts immediately the bleeding. Unlike other competing products, when held for a long period on the wound, it does not bring any unpleasant burning feeling to the patient.

Functional Description:

By applying the gauze to the wound, the blood secretions are directly absorbed and a viscous gel is created in the area, which contributes to the coagulation process.

Features:

- 100% oxidized regenerated cellulose derived from plants
- Easy removal of residues
- Neutral pH
- Non-irritating
- Bacteriostatic properties*
- Easy to use
- Sterile in individual or multiple packaging
- Competitive price

Suitable For:

- For Hospital-Healthcare fields (Surgeons, Pathologists, Dentists-Periodontists, Otolaryngologists, Gynaecologists, Veterinarians, First-aid Personnel)

**Based on clinical trials*



ΚΩΔΙΚΟΣ	ΔΙΑΣΤΑΣΕΙΣ	ΣΥΣΚΕΥΑΣΙΑ
18000	10 x 20cm	5 pcs
18001	5 x 7,5cm	15 pcs
18002	5 x 35cm	5 pcs
18006	7,5 x 10cm	10 pcs
18007	2,5 x 2,5cm	20 pcs
18009	1,25 x 5cm	20 pcs
18008*	1,9 x 1,9cm	10 pcs



STERILE R

**Specifically designed for dental use*

NEW HEMOSTATIC SPONGES FOR EAR AND NASAL USE

SIDACEL ENT hemostatic sponges are specifically designed to stop effectively and quickly ear and nasal bleeding. Available in different dimensions and specifications, covering every demand.

They consist of high-absorption PVA material, which, when it comes in touch with blood or other fluids, within the ear or nasal cavities, swells and seals capillary ends.

Particularly, when immediate hemostasis is required, choose the **SIDACEL ENT with additional hemostatic gauze-coating products**, which achieve rapid blood clotting and help the healing process.

Features:

- Non-irritating
- Neutral pH
- Bacteriostatic properties*
- Simple to use
- Easily removable
- Sterile in individual packaging



ΚΩΔΙΚΟΣ	ΧΡΗΣΗ	ΔΙΑΣΤΑΣΕΙΣ	ΣΥΣΚΕΥΑΣΙΑ
18108	Ωτική	9 x 15 mm With drawstring	10 τεμ.
18109	Ωτική	9 x 24 mm With drawstring	10 τεμ.
18110	Ωτική	15 x 22 mm With drawstring	10 τεμ.
18100	Ρινική	80 x 20 x 15 mm With airway tube and drawstring	10 τεμ.
18101	Ρινική	80 x 20 x 15 mm With gauze coating and drawstring	10 τεμ.
18102	Ρινική	80 x 20 x 15 mm With drawstring	10 τεμ.
18103	Ρινική	80 x 20 x 15 mm Without drawstring	10 τεμ.
18104	Ρινική	80 x 30 x 15 mm With drawstring	10 τεμ.
18105	Ρινική	100 x 20 x 15 mm With gauze coating and drawstring	5 τεμ.
18106	Ρινική	100 x 20 x 15 mm With drawstring	5 τεμ.
18107	Ρινική	100 x 20 x 15 mm Without drawstring	5 τεμ.

Sidacel ENT
MAKES THE DIFFERENCE

Sidacel
MAKES THE DIFFERENCE



SIDAPHARM[®]
Ophthalmic & Medical Disposable Products

SIDAPHARM GREECE

DIANA MOHINDRA

21, Stageiriti str, 54352,
Thessaloniki, Greece

Tel.: +30 2310 906660,
+30 2310 945899

Fax: +30 2310 989846

e-mail: info@sidapharm.gr

www.sidapharm.gr



ΕΘΝΙΚΟ ΚΕΝΤΡΟ ΑΞΙΟΛΟΓΗΣΗΣ
ΤΗΣ ΠΟΙΟΤΗΤΑΣ & ΤΕΧΝΟΛΟΓΙΑΣ
ΣΤΗΝ ΥΓΕΙΑ Α.Ε.



ΕΘΝΙΚΟ ΚΕΝΤΡΟ ΑΞΙΟΛΟΓΗΣΗΣ
ΤΗΣ ΠΟΙΟΤΗΤΑΣ & ΤΕΧΝΟΛΟΓΙΑΣ
ΣΤΗΝ ΥΓΕΙΑ Α.Ε.



SIDAPHARM[®]
Ophthalmic & Medical Disposable Products

Ophthalmic Surgical Instruments Catalogue



INDEX

FORCEPS	
Tying	3
Toothed	4
Notched	5
Chalazion	5
Capsulorhexis	6
Lens	7
Hemostatic	8
Prechopper	8
NEEDLE HOLDERS	9
SCISSORS	10
HOOKS	13
CHOPPERS	14
FIXATION RING	14
MANIPULATORS	15
SPATULA	15
SPECULUMS	16
CALIPERS	17
PUNCHES	18
LASIK	18
VITREORETINAL	19
IRRIGATION / ASPIRATION	25
SETS	26
STERILIZATION TRAYS	27

- Illustrations not drawn to scale -
- All items are individually packed unless otherwise stated -
- For orders, contact us as stated at the back cover page -

FORCEPS

1. TYING FORCEPS

Straight Tying Forceps

Straight shafts with 4.50mm tying platforms

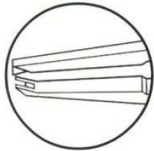

TT0101B
TT0101C
TT0102B
TT0102C

85mm long | Standard tips
85mm long | Ultrafine tips
115mm long | Standard tips
115mm long | Ultrafine tips

Curved Tying Forceps

Curved shafts with 6mm tying platforms | ideal for 10/0 or 11/0 suture



TT0102G
TT0101J

115mm long
85mm long

McPherson Tying Forceps

Angled 4.50mm tying platforms

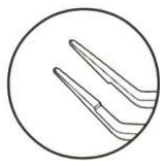

TT0101D
TT0101CA
TT0101F
TT0101G
TT0102D
TT0102E

85mm long | Standard tips | 12mm angled shafts
85mm long | Ultrafine tips | 7mm angled shafts
85mm long | Ultrafine tips | 10mm angled shafts
85mm long | Ultrafine tips | 12mm angled shafts
115mm long | Standard tips
115mm long | Ultrafine tips

2. TOOTHED FORCEPS

Straight Toothed Forceps

1 x 2 teeth, with 5.0mm tying platforms

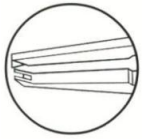

TT0111C
TT0111B
TT0112C
TT0112B

85mm long | 0.10mm teeth
85mm long | 0.12mm teeth
115mm long | 0.10mm teeth
115mm long | 0.12mm teeth

Colibri Conjunctiva Toothed Forceps

1 x 2 teeth, with 5.0mm tying platforms



TT0111H

85mm long | 0.12mm teeth

Bonn Toothed Forceps

1 x 2 teeth

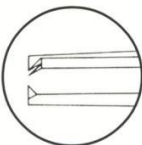

TT0116A

85mm long | 0.12mm teeth

Colibri Toothed Forceps

1 x 2 teeth

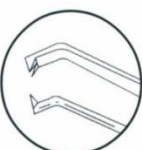

TT0111D
TT0112D

85mm long | 0.12mm teeth with tying platform
115mm long | 0.12mm teeth with tying platform

Harms-Colibri Toothed Forceps

1 x 2 teeth | 75mm long

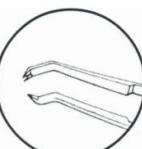

TT0115B
TT0116B
TT2110G

0.12mm teeth with tying platform
0.30mm teeth with tying platform
0.50mm teeth with tying platform

3. NOTCHED FORCEPS

Straight Notched Forceps

0.25mm notched | with tying platforms | 85mm long

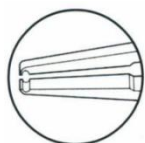

TT0106B
TT0106C



Standard Tips
Ultrafine Tips

Angled Notched Forceps

0.25mm notched | with tying platforms | 85mm long



TT0106D
TT0106F



Standard Tips
Ultrafine Tips

Pierse Corneal Forceps

0.25 mm notched | very delicate | 115 mm long

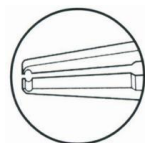

TT0108B
TT0108C



Straight shafts
Curved shafts

4. CHALAZION FORCEPS

Hunt Chalazion Forceps

98mm long



TT0141A
TT0140G
TT0140F
TT0140H



Oval 8x11mm
Round 8mm
Oval 12x14 mm
Round 15mm

5. CAPSULORHEXIS FORCEPS

Utrata-Style Capsulorhexis Forceps

Fine angled sharp tips, 12mm 45°angled shafts



TT0117D



Utrata-Style Capsulorhexis Forceps, *curved*

Fine angled sharp tips, 12mm 45°angled and curved shafts

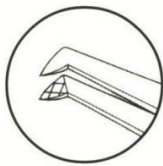

TT0117E



Utrata-Style Capsulorhexis Forceps

45° angled tips with slim 10mm shafts | Round handle for fingertip rotational control



TT0122H



105 mm long | With guide pin | Iris stop |

Corydon-Style Capsulorhexis Forceps, cystotome teeth

Fine 45°angled sharp tips, with curved 12mm shafts



TT0117G
TT0118G



85mm long
115mm long

Corydon-Style Capsulorhexis Forceps, cystotome teeth

Fine 45° angled tips with curved 12 mm shafts | Round handle for fingertip rotational control



TT0122D



105 mm long | With guide pin | Iris stop

Lehner-Utrata Style Capsulorhexis Forceps

Fine angled sharp tips with curved 12mm shafts for capsulorhexis through tunnel incisions



TT0122B



105 mm long | With guide pin

Capsulorhexis Forceps

45° angled and Iris stop

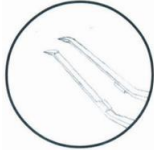

TT0122F
TT0122G



12mm straight shafts
12mm curved shafts

6. LENS FORCEPS

Kelman-McPherson Lens Forceps

7.5mm long smooth jaws | very delicate



TT0130B



108mm long

Shepard Lens Forceps

Gently curved shafts with flat Tungsten Carbide coated jaws

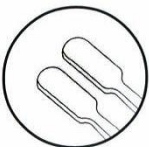

TT0128G



125mm long

7. HEMOSTATIC FORCEPS

Hartmann Mosquito Forceps

Ring handle with ratchet lock, 95mm long

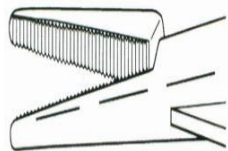

TT0141E
TT0141F



Straight 20mm serrated jaws
Curved 20mm long serrated jaws

8. PRECHOPPER

Akahoshi PreChopper

Conventional smooth sharp pointed tips | 12mm angled curved shafts | cross-action



TT0139J



3 mm maximum tip opening | 120mm long

NEEDLE HOLDERS

Barraquer Needle Holder - Curved

Delicate, 9mm gently curved jaws, sharp tips, 115mm long



TT0210G
TT0210B



With Lock
Without Lock

Troutman Needle Holder

Curved, 6mm delicate jaws, 110mm long



TT0224B
TT0223D



With Lock
Without Lock

SCISSORS

Conjunctiva Scissors

Gently curved blades, 12mm tip to pivot length, blunt tips



TT307BR 115mm long

Eye Scissors

Straight blade, Pointed tips, 32mm from pivot to tip



TT0306C 110mm long

Castroviejo Corneal Section Scissors

Blunt tips, 0.5mm longer lower blades than upper ones, 9mm from pivot to tip, 105mm long



TT0304D Right
TT0304E Left

Iris Scissors

Ring handle, Pointed tips



TT2301D Straight tips, 18mm from mid-screw to tip, 98mm long
TT2301E Curved tips, 18mm from mid-screw to tip, 98mm long
TT2301F Straight Tips, 25mm from mid-screw to tip, 105mm long
TT2301G Curved Tips, 25mm from mid-screw to tip, 105mm long
TT2301H Straight Tips, 28mm from mid-screw to tip, 100mm long
TT0301I Curved Tips, 28mm from mid-screw to tip, 100mm long
TT0303E Sharp tips, 11mm blade length, Straight blades, 105mm long

Westcott Tenotomy Scissors

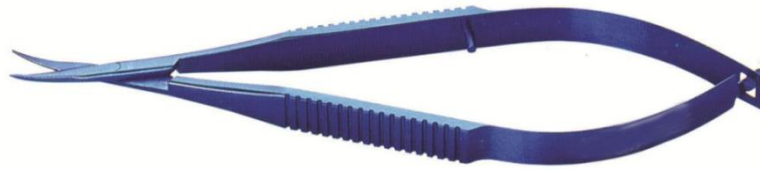

- TT0307J 19mm from pivot to tip, curved blunt tip, 110mm long
- TT0305I 21mm from pivot to tip, curved blunt tip, 115mm long
- TT2300G 23mm from pivot to tip, curved blunt tip, 140mm long
- TT2300H 23mm from pivot to tip, curved sharp tip, 140mm long

Vannas Capsulotomy Scissors

Sharp pointed tips, curved blades, 95mm long

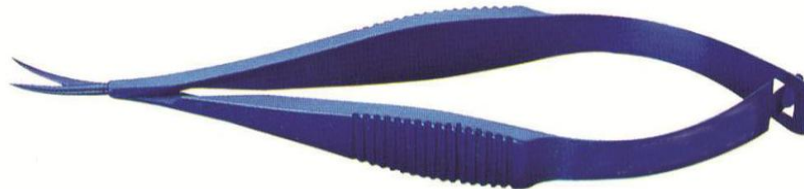

- TT0303H 10.5mm blade
- TT0303I 12.5mm blade

Vannas Scissors



- TT0300B Sharp pointed, straight 7.5mm blades, 9.5mm from pivot to tip, 82mm
- TT0300C Sharp pointed, curved 7.5mm blades, 9.5mm from pivot to tip, 82mm
- TT0300H Sharp pointed, side angled 7.0mm blades, 9.0mm from pivot to tip, 82mm
- TT0306B Extra thin 7.0mm long blades, sharp pointed, 9.0mm from pivot to tip, 105mm

Osher IOL Cutter



- TT2300E Side-angled
- TT2300D Straight

Stitch Scissors

Ring handle, 24mm blade, 28mm from pivot to tip, 95mm long

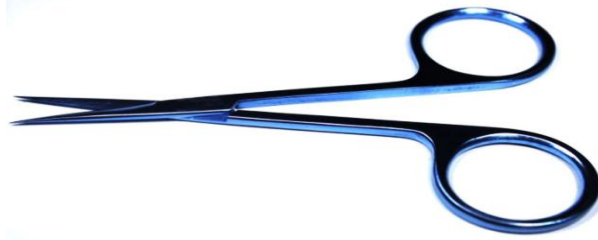

- | | |
|---------|---|
| TT2305H | Straight, pointed tips |
| TT2305I | Straight, pointed left tip, blunt right tip |
| TT2305J | Straight, blunt tips |
| TT2306A | Curved, pointed tips |
| TT2306B | Curved, pointed left tip, blunt right tip |
| TT2306C | Curved, blunt tips |

Stitch Scissors

Ring handle, 26mm blade, 30mm from pivot to tip, 106mm long



- | | |
|---------|---|
| TT2306D | Straight, pointed tips |
| TT2306E | Straight, pointed left tip, blunt right tip |
| TT2306F | Straight, blunt tips |
| TT2306G | Curved, pointed tips |
| TT2306H | Curved, pointed left tip, blunt right tip |
| TT2306I | Curved, blunt tips |

Stitch Scissors

Ring handle, 15mm blade, 20mm from pivot to tip, 88mm long



- | | |
|---------|------------------------|
| TT2306J | Straight, pointed tips |
| TT2307A | Straight, blunt tips |
| TT2307B | Curved, pointed tips |
| TT2307C | Curved, blunt tips |

HOOKS

Kuglen Iris Hook and Lens Manipulator

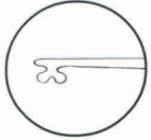

TT0410B
TT0410C



Angled
Straight

Sinskey Lens Manipulating Hook



TT0411A



0.15 mm diameter, blunt tip, angled to right

Jameson Muscle Hook



TT2407A
TT2406J

1.5mm bulbous tips
2.0mm bulbous tips with 6mm flat portion

Graefe Strabismus Hook



TT2407C
TT2407D
TT2407E
TT2407F

Size 8mm x 1.5mm, 135mm long
Size 9mm x 1.5mm, 135mm long
Size 10mm x 1.5mm, 135mm long
Size 10mm x 2.0mm, 135mm long

CHOPPERS

Phaco Chopper



TT0412B
TT0412C



Straight
Angled

Phaco Chopper



TT0412F
TT0412FL



Right hand
Left hand

Phaco Chopper

Double-ended



TT0430C



Paddle manipulator / 60° phaco chopper



Phaco Chopper

Double-ended for vertical and horizontal phaco chopping



TT0430D



Lieberman Micro Finger / Phaco Chopper



FIXATION RING

Fine/Thornton Fixation Ring

Swivel head



TT0414H
TT0414I

13mm/ 9mm cut out
16mm/14mm cut out

MANIPULATORS

Mushroom Nucleus Manipulator



TT2409D



Drysdale Nucleus Manipulator



TT0411D



Paddle-shaped tip

SPATULA

Castroviejo Cyclodialysis/Synechia Spatula

Double-ended



TT2411A

0.25mm wide

TT2411B

0.50mm wide

Membrane Spatula

TT2403I

Curved blunt tip, 2mm

TT2403J

Angled blunt tip, 4mm

TT2404A

Angled sharp tip, 5mm

TT2404B

0.5mm, 25G

TT2404C

angled sharp tip, 0.6mm, 23G

TT2404D

angled sharp tip, 0.8mm, 20G

SPECULUMS

Lindstrom-Chu Aspirating Speculum

Prevents excess pooling of BSS from eyelid margins. Unique reversible speculum design to rest the device nasally or temporally.

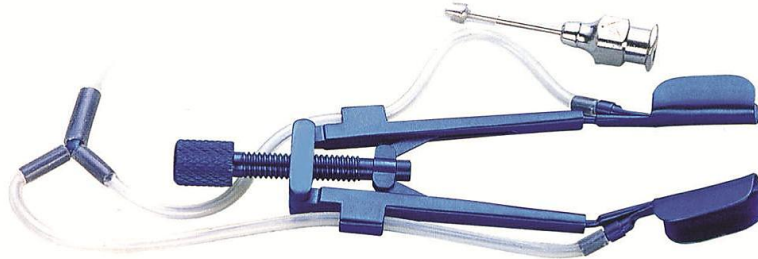

TT0500E 65mm long

Lieberman Speculum, K-wire

Adjustable wire speculum



TT0500F 45° angled shaft. 14.5mm open blades. 65mm long

Kratz-Barraquer Wire Speculum

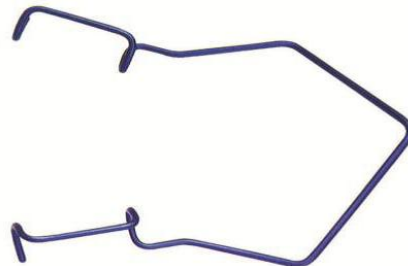

TT0500H 13.5mm open blades, 52mm long

Barraquer Solid Speculum



TT0500I 14.5mm long blades, 52mm long

Slade LASIK Wire Speculum

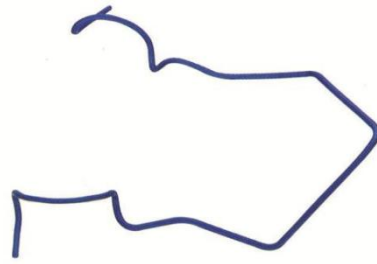

TT0501D

52mm long

CALIPERS

Braunstein Fixed Caliper

Fine tips mark sclerotomy sites for vitreous surgery



TT1000D

3.5/4.0mm

TT1000E

3.0/3.5mm

Castroviejo Caliper

0-20mm measurements in 0.5mm increments. Scale reading on one side



TT1000F

Straight Tips

TT1000FC

Curved Tips

PUNCHES

Luntz-Dodick Trabeculectomy Punch

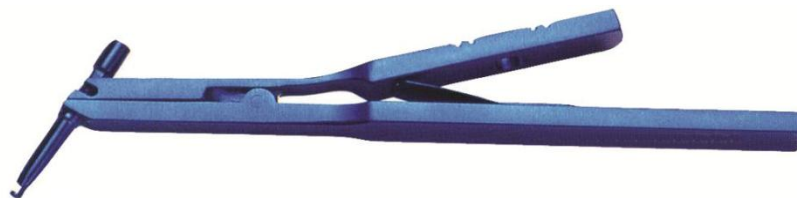

TT1001A	0.75 mm
TT1001B	1.00 mm
TT1001G	1.20 mm
TT1001F	1.50 mm

LASIK

Katzen LASIK Flap Unzipper



TT0504G

double-ended (modified Sinsky hook / bi-convex spatula)

LASIK Multi-purpose Forceps

Combines the features of a spatula, dissector and forceps



TT0502I

Curved jaws, 115mm long

Buratto LASIK Cannula

One front and two side ports. 6 ports for multi-directional irrigation

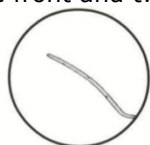

TT0504D

25G

VITREORETINAL

Side Gripping Forceps



VR1150B



1.25 jaws, 23G

Foreign Body Forceps



VR1150C



Cap jaws, 23G

Micro Capsulorhexis Forceps



VR1150D



1.25 jaws, Curved, 23G

Gripping Forceps, straight, VR



VR1150F



1.25mm jaws, 23G

Gripping Forceps, straight, VR



VR1150G



1.25mm jaws, 23G

Serrated Forceps, VR



VR1150H

1.25mm jaws, 23G



Straight toothed Forceps, VR



VR1150I

1.25mm jaws, 23G, VR



Gripping Forceps, VR



VR1150J

1.25mm jaws, 23G, VR



Angled Forceps, membrane peeler, VR



VR1151A

1.25mm, 23G, VR



Angled Forceps, membrane peeler, VR



VR1151B

1.25mm, 23G, VR



Fine Gripping Forceps, VR



VR1151C

3mm jaws, VR, 23G



End Gripping Forceps



VR1151D

1.25mm jaws, 23G



End Gripping Forceps



VR1151E

3mm jaws, 23G



Flat Gripping Forceps, VR
with Tungsten Carbide coating



VR1151F

1.25mm jaws, 23G



Pick Forceps, VR

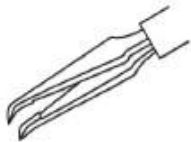

VR1151G

3mm jaws, 23G



Pointed Gripping Forceps, VR



VR1151J

1.5mm jaws, pointed end, 23G



Offset Gripping Forceps, VR



VR1152A

0.9mm jaws, 23G



ILM Gripping Forceps, VR



VR1152D



2.2mm jaws, 23G, VR

Fine Gripping Forceps, VR



VR1152E



1.25mm jaws, 23G

Serrated Forceps



VR1152G

VR1153B

VR1152H



1.5mm jaws, 23G, VR

1.5mm jaws, curved, 23G, VR

3.0mm jaws, 23G, VR

Gripping Forceps, VR



VR1152J



2.75mm jaws, 23G

Straight Scissors, VR



VR1315B



1.25mm blade, 23G

Straight Scissors, VR



VR1315C



Blunt-tipped, 1.25mm blade, 23G

Curved Scissors, VR



VR1315D



Sharp-tipped, 1.25mm blade, 23G

Angled Scissors, VR



VR1315E



45° angled, 1.5mm blade, 23G

Vertical Scissors, VR



VR1315G



23G

Vertical Scissors, VR



VR1315H



23G

Straight Scissors, VR



VR1315I
VR1315J



Sharp-tipped, 2.25mm blade, 23G
Blunt-tipped, 2.25mm blade, 23G

Curved Scissors, VR



VR1316A



Sharp-tipped, 2.25mm blades, 23G

Straight Scissors, VR



VR1316H



3mm blade, 23G, VR

Vertical Scissors, VR



VR1316I



45° angled, 0.6mm blade, 23G, VR

Vertical Scissors, VR



VR1317A
VR1316J



Curved Scissors, 2.5mm blade, 15mm curved shaft, 23G, VR
Curved Scissors, 3.0mm blade, 25mm curved shaft, 23G, VR

Angled Scissors, VR



VR1317B



45° angled 2mm blade, 23G, VR

Straight Scissors

VR1317C

(Pictures Non Available)
2.5mm blade, 25mm curved shaft, 23G, VR

I/A

Irrigation Tips

I-21G	straight, 0.3mm side port, 21G
I-21G angled	45° angled, 0.3mm side port, 21G
I-23G	Akahoshi mini curved I/A tip, 0.3mm side port, S-shape, 23G

Aspiration Tips

A-21G	straight, 0.3mm side port, 21G
A-21G angled	45° angled, 0.3mm side port, 21G
A-23G	Akahoshi mini curved I/A tip, 0.3mm side port, S-shape, 23G

Bi-Manual Irrigation Handpieces



T301i-1	Curved, 21G, 0.3mm dual side ports
T301i-2	Curved, 23G, 0.3mm dual side ports
T301i-3	Curved, 21G, 0.5mm dual side ports
T301i-4	Curved, 21G, 0.5mm front port
T301i-5	Curved, 21G, 30° beveled tip
T301i-6	Straight, 23G, 0.4mm dual side ports
T301i-7	Straight, 21G, 0.5mm dual side ports

Bi-Manual Aspiration Handpieces



T301a-1	Curved, 20G, 0.2mm side-port, with capsule polisher
T301a-2	Curved, 20G, 0.3mm side-port, with capsule polisher
T301a-3	Curved, 20G, 0.3mm side-port, cortex extractor with capsule polisher
T301a-4	Curved, 20G, 0.3mm dual side-port, 1.4mm incision
T301a-5	Straight, 20G, 0.3mm dual side-port, 1.4mm incision
T301a-6	Curved, 21G, 0.3mm side-port
T301a-7	Curved, 21G, 0.4mm dual side-port
T301a-8	Curved, 23G, 0.3mm
T301a-9	Curved, 23G, 0.3mm side-port
T301a-10	Curved, 23G, 0.3mm side-port, with polisher
T301a-11	Curved, 23G, 0.4mm side-port
T301a-12	Curved, 23G, 0.4mm side-port, with polisher

Handles

HI1	Irrigating Handle
HA1	Aspirating Handle
IHMM	Infusion Handle, M/M connectors
IHMF	Infusion Handle, M/F connectors
IHMT	Infusion Handle, M/tubing connectors

SETS

	DESCRIPTION	BASIC	FULL
	Utrata-Style Capsulorhexis Forceps, curved (see Code TT0117E at page 6, for complete specs)	✓	✓
	Barraquer Needle Holder, curved (see Code TT0210B at page 9, for complete specs)	✓	✓
	Vannas Capsulotomy Scissors (see Code TT0303H at page 11, for complete specs)	✓	✓
	McPherson Tying Forceps (see Code TT0102D at page 3, for complete specs)	✓	✓
	Kratz-Barraquer Wire Speculum (see Code TT0500H at page 16, for complete specs)	✓	
	Phaco Chopper (see Code TT0430C at page 14, for complete specs)		✓
	Lieberman Speculum, K-wire (see Code TT0500F at page 16, for complete specs)		✓
	Utrata-Style Capsulorhexis Forceps, curved (see Code TT0306C at page 10, for complete specs)		✓
	Bi-Manual Irrigation Handpiece (see Code T301i at page 25, for complete specs)		✓
	Bi-Manual Aspiration Handpiece (see Code T301a at page 25, for complete specs)		✓
	Sterilization Tray / Medium (see Code T104 at page 27, for complete specs)	✓	
	Sterilization Tray / Large (see Code T105 at page 27, for complete specs)		✓

CHALAZION SET

DESCRIPTION



Hunt Chalazion Forceps
(see Code TT0140H at page 5, for complete specs)



Meyerhoeffer Chalazion Curette
TT3400G 2mm
TT3401A 4mm

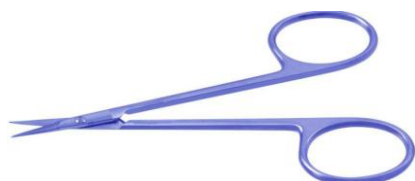

Iris Scissors
(see Code TT0301I at page 10, for complete specs)



Colibri Toothed Forceps
(see Code TT0111D at page 4, for complete specs)



Sterilization Tray / Medium
(see Code T104 at page 27, for complete specs)

STERILIZATION TRAYS



Poly-Carbonate Sterilization Trays with Silicone Mat

Code	Sizes / Dimensions	
T103	Small	(19cm x 10cm x 2cm)
T104	Medium	(24cm x 13cm x 2cm)
T105	Large	(24cm x 13cm x 5.5cm)



21, Stageiriti str., GR-55534, Thessaloniki, Greece

Tel. +30 2310906660

Fax +30 2310989846

sales@sidapharm.gr

www.sidapharm.gr

All images and drawings used are for illustrative purposes only. They are indicative of the quality and style of the specification and may not represent wholly the actual items. The specifications may be subject to change. Please ask our sales adviser for details. Whilst all reasonable care has been taken in providing true information, we accept no responsibility for the accuracy of any information contained herein.