

Tracheostomy/ Laryngectomy

PRODUCT CATALOG



Primed[®]



Primed[®] Halberstadt Medizintechnik GmbH is a highly experienced manufacturer of medical devices for tracheostomized and laryngectomized patients.

For many years we have been supplying our customers with high quality products "MADE IN GERMANY".

In line with our corporate policy, the medical devices offered by **Primed[®]** are developed, produced and marketed in our own company. This is done in close cooperation with our customers and academic institutions.

The basis is formed by a certified development process in accordance with the DIN 13485 standard, in which highly innovative medical devices are continuously developed on the basis of ongoing market research and analysis.

Our vertical integration extends throughout the entire manufacturing process (injection moulding, extrusion, assembly).

The bundling of all the product-related processes in one company allows us to react flexibly to market requirements and guarantee the continuous further improvement of our existing products as well as to launch new products on the market.

PercuTrach®

PDT SETS

(Complete sets for percutaneous dilatational tracheostomy including tracheostomy tube) 7

 PDT Set Type 1 8

 with* **Optima PercuTrach®** 10

 with **Priflex PercuTrach®** 14

 with **ProLine PercuTrach®** 16

 PDT Set Type 2 24

NEW

Dilation sets (Sets for percutaneous dilatational tracheostomy without tracheostomy tube) 30

Optima PercuTrach®

Tracheostomy tubes 31

NEW

Priflex PercuTrach®

Tracheostomy tubes 38

NEW

ProLine PercuTrach®

Tracheostomy tubes 43

Proline XT PercuTrach® tracheostomy tubes 50

Optima

Tracheostomy tubes 54

Replacement inner cannulas 63

Ultrasoft

Tracheostomy tubes 64

Replacement inner cannulas 73

ProLine

Tracheostomy tubes 74

ProLine replacement inner cannulas 83

NEW ProLine XT Tracheostomy tubes 84

ProLine XT replacement inner cannulas 90

Priflex®

Tracheostomy tubes 91

Priflex® MRI

Tracheostomy tubes 99

Primedistom®

Tracheostomy tubes 104

Replacement inner cannulas 111

Silver

Tracheostomy tubes 113

NEO PED PEDL PEDC PEDCL

Tracheostomy tubes for neonates and children 123

 Neonatal tracheostomy tubes without Cuff 126

 Pediatric tracheostomy tubes without Cuff 127

 Pediatric tracheostomy tubes without Cuff, long 128

 Pediatric tracheostomy tubes with Cuff 129

 Pediatric tracheostomy tubes with Cuff, long 130

Primedisilk®

Laryngectomy tubes 131

Tracheostomy placeholders 139

 Tracheosafe 140

 T-Tubus 141

 Primedibutton® 142

Primedistrip®	145
Primed Tracheo Seal®	151
Accessories for pulmonary rehabilitation	152
Heat and Moisture Exchangers (HME)	153
Heat and Moisture Exchangers (HME) with speaking option.....	156
Heat and Moisture Exchangers (HME) for neonates and children	157
Speaking valves	158
• for tracheostomized patients	159
• for ventilated tracheostomized patients	163
• for laryngectomized & tracheostomized patients	164
• with filter function for laryngectomized & tracheostomized patients.....	165
Bacteria and virus filters	166
Tracheal compresses	167
Neck straps	168
Shower guard	169
Tracheal suction set.....	170
Accessories for cleaning	171
Lubricant gel	172
Pictograms	173
Grafics	174

PDT SETS

(Complete sets for percutaneous dilatational tracheostomy including tracheostomy tube)

Percutaneous dilatational tracheostomy is a standardized method in intensive medical treatment. As alternative for surgical tracheostomy it may be carried out less time-consuming at the bedside in ICU's. The dilated tracheostoma closes spontaneously and long-term cosmetic results are far superior to conventional tracheostomy.

All **Primed**® PDT sets include a dilation set and a matching tracheostomy tube set .

PDT set type 1 includes a dilation set for the Ciaglia dilation technique and a PercuTrach® tracheostomy tube with atraumatic inserter (Optima PercuTrach®, ProLine (XT) PercuTrach® or Priflex PercuTrach®).

PDT set type 2 includes a dilation set for the Griggs dilation technique, with tracheal dilating forceps, and an Optima tracheostomy tube.

Our dilation sets are ideally adapted to the use of **Optima** tracheostomy tubes and different **PercuTrach**® tracheostomy tubes which are available with or without sieving (Optima PercuTrach®, ProLine (XT) PercuTrach®) and with or without subglottic suction line.

Dilation sets and tracheostomy tube sets are also available separately.



DILATATION TRACHEOSTOMY

developed by Ciaglia

The percutaneous dilatation tracheostomy technique according to Ciaglia is a minimal-invasive treatment which implies the stepless bouginage of the trachea by a conically shaped dilator via guide wire, thus enabling the insertion of a suitable tracheostomy tube.

Primed® PDT Set Type 1 includes a conically shaped dilator which has a hydrophilic coating for assuring good gliding capabilities. After removing the dilator, the tracheostomy tube can be gently placed in the trachea via the atraumatic inserter.

The procedure should be performed under bronchoscopic control.



Position patient with hyperextension of neck, cover area around the neck with sterile dressing, disinfect skin

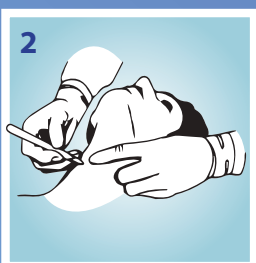

Palpation of neck, sonography (recommended), diaphanoscopy of neck area (obligatory), horizontal incision (1,5-2,0 cm) and blunt preparation up to trachea

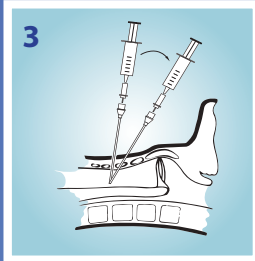

Puncture of trachea

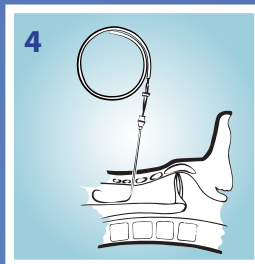

Insertion of guide wire (Seldinger wire)

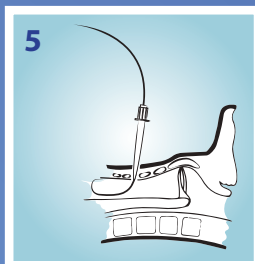

Pre-dilation of injection canal by predilator, removing of pre-dilator

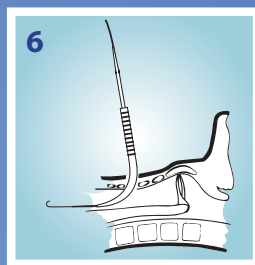

Moisten dilator. Push dilator with inserted guiding catheter into the trachea via guide wire up to the required size of tracheal orifice. After that, remove dilator. (When using **Priflex PercuTrach®** the dilator including guiding catheter is to be removed)

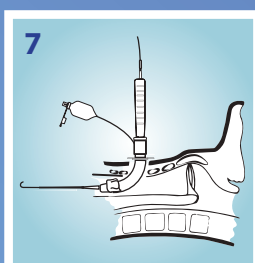

Place the atraumatic inserter in the tracheostomy tube, coat the cuff which has already been checked for leaks with lubricant gel and introduce it into the trachea orifice via the guiding catheter with guide wire inside.

(When using **Priflex PercuTrach®** the appropriate guiding catheter is already placed in the atraumatic inserter. The tracheostomy tube is inserted by advancing the atraumatic inserter with guiding catheter over the prepositioned guide wire into the trachea.)

After positioning, remove the atraumatic inserter, guiding catheter and guide wire together.

**PDT SET Type 1
with Optima PercuTrach®**

Package contents per set:

PercuTrach® Dilation set I

- Pre-dilator
- Puncture cannula (14G)
- Dilator (hydrophilic coating)
- Guiding catheter with safety lock
- Guide wire with dispenser
- Gauze compresses
- Syringe
- Scalpel

Optima PercuTrach® Basic Cuff

- Outer cannula with low-pressure cuff and 15 mm connector
- Atraumatic inserter
- 1 transparent, unfenestrated inner cannula
- 1 white, unfenestrated, radiopaque inner cannula
- Obturator, perforated
- Neck strap
- Lubricant gel



SIZE CHART:

Size	ID _{OC}	ID _{IC}	OD	Length along centre line (OC)	Length along outer bend (OC)	PU	Article number PDT SET TYPE 1
7	7,0 mm	5,4 mm	10,5 mm	70,0 mm	79,0 mm	1 Complete Set (Dilation set I + Optima Percutrach® tracheostomy tube)	112424
8	8,0 mm	6,4 mm	11,6 mm	75,5 mm	87,0 mm	1 Complete Set (Dilation set I + Optima Percutrach® tracheostomy tube)	112425
9	9,0 mm	7,4 mm	12,6 mm	81,0 mm	93,0 mm	1 Complete Set (Dilation set I + Optima Percutrach® tracheostomy tube)	112426

INCLUDING:



NECK STRAP

OBTURATOR

LUBRICANT GEL

PDT SET Type 1
with Optima PercuTrach®

Package contents per set:

PercuTrach® Dilation set I

- Pre-dilator
- Puncture cannula (14G)
- Dilator (hydrophilic coating)
- Guiding catheter with safety lock
- Guide wire with dispenser
- Gauze compresses
- Syringe
- Scalpel

Optima PercuTrach® Voice Cuff

- Sieved outer cannula with low-pressure cuff and 15 mm connector
- Atraumatic inserter
- 1 red, fenestrated inner cannula
- 1 white, unfenestrated, radiopaque inner cannula
- Obturator, perforated
- Decannulation cap
- Speaking valve
- Neck strap
- Lubricant gel



SIZE CHART:

Size	ID _{OC}	ID _{IC}	OD	Length along centre line (OC)	Length along outer bend (OC)	PU	Article number PDT SET TYPE 1
7	7,0 mm	5,4 mm	10,5 mm	70,0 mm	79,0 mm	1 Complete Set (Dilation set I + Optima Percutrach® tracheostomy tube)	112434
8	8,0 mm	6,4 mm	11,6 mm	75,5 mm	87,0 mm	1 Complete Set (Dilation set I + Optima Percutrach® tracheostomy tube)	112435
9	9,0 mm	7,4 mm	12,6 mm	81,0 mm	93,0 mm	1 Complete Set (Dilation set I + Optima Percutrach® tracheostomy tube)	112436

INCLUDING:

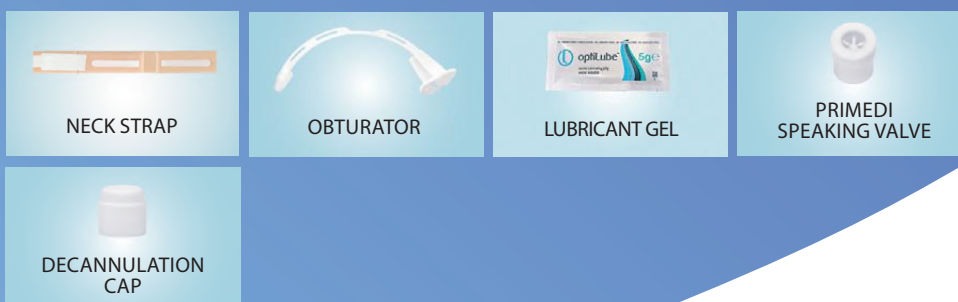

DECANNULATION CAP

PDT SET Type 1
with Optima PercuTrach®

Package contents per set:

PercuTrach® Dilation set I

- Pre-dilator
- Puncture cannula (14G)
- Dilator (hydrophilic coating)
- Guiding catheter with safety lock
- Guide wire with dispenser
- Gauze compresses
- Syringe
- Scalpel

Optima PercuTrach® Suction

- Outer cannula with low-pressure cuff, subglottic suction function and 15 mm connector
- Atraumatic inserter
- 1 transparent, unfenestrated inner cannula
- 1 white, unfenestrated, radiopaque inner cannula
- Obturator, perforated
- Funnel connector
- Neck strap
- Lubricant gel



SIZE CHART:

Size	ID _{OC}	ID _{IC}	OD	Length along centre line (OC)	Length along outer bend (OC)	PU	Article number PDT SET TYPE 1
7	7,0 mm	5,4 mm	10,5 mm	70,0 mm	79,0 mm	1 Complete Set (Dilation set I + Optima Percutrach® tracheostomy tube)	112454
8	8,0 mm	6,4 mm	11,6 mm	75,5 mm	87,0 mm	1 Complete Set (Dilation set I + Optima Percutrach® tracheostomy tube)	112455
9	9,0 mm	7,4 mm	12,6 mm	81,0 mm	93,0 mm	1 Complete Set (Dilation set I + Optima Percutrach® tracheostomy tube)	112456

INCLUDING:



NECK STRAP

OBTURATOR

LUBRICANT GEL

FUNNEL CONNECTOR

PDT SET Type 1
with Optima PercuTrach®

Package contents per set:

PercuTrach® Dilation set I

- Pre-dilator
- Puncture cannula (14G)
- Dilator (hydrophilic coating)
- Guiding catheter with safety lock
- Guide wire with dispenser
- Gauze compresses
- Syringe
- Scalpel

Optima PercuTrach® Suction Voice

- Sieved outer cannula with low-pressure cuff, subglottic suction function and 15 mm connector
- Atraumatic inserter
- 1 red, fenestrated inner cannula
- 1 white, unfenestrated, radiopaque inner cannula
- Obturator, perforated
- Funnel connector
- Decannulation cap
- Speaking valve
- Neck strap
- Lubricant gel



SIZE CHART:

Size	ID _{OC}	ID _{IC}	OD	Length along centre line (OC)	Length along outer bend (OC)	PU	Article number PDT SET TYPE 1
7	7,0 mm	5,4 mm	10,5 mm	70,0 mm	79,0 mm	1 Complete Set (Dilation set I + Optima Percutrach® tracheostomy tube)	112444
8	8,0 mm	6,4 mm	11,6 mm	75,5 mm	87,0 mm	1 Complete Set (Dilation set I + Optima Percutrach® tracheostomy tube)	112445
9	9,0 mm	7,4 mm	12,6 mm	81,0 mm	93,0 mm	1 Complete Set (Dilation set I + Optima Percutrach® tracheostomy tube)	112446

INCLUDING:



PDT SET Type 1
with Priflex PercuTrach®

Package contents per set:

PercuTrach® Dilation set I

- Pre-dilator
- Puncture cannula (14G)
- Dilator (hydrophilic coating)
- Guiding catheter with safety lock
- Guide wire with dispenser
- Gauze compresses
- Syringe
- Scalpel

Priflex PercuTrach® with Cuff

- Spiral-reinforced tracheostomy tube with low-pressure cuff, 15 mm connector and individually adjustable neck flange
- Atraumatic inserter with guiding catheter
- Obturator with suction function
- Neck strap
- Lubricant gel

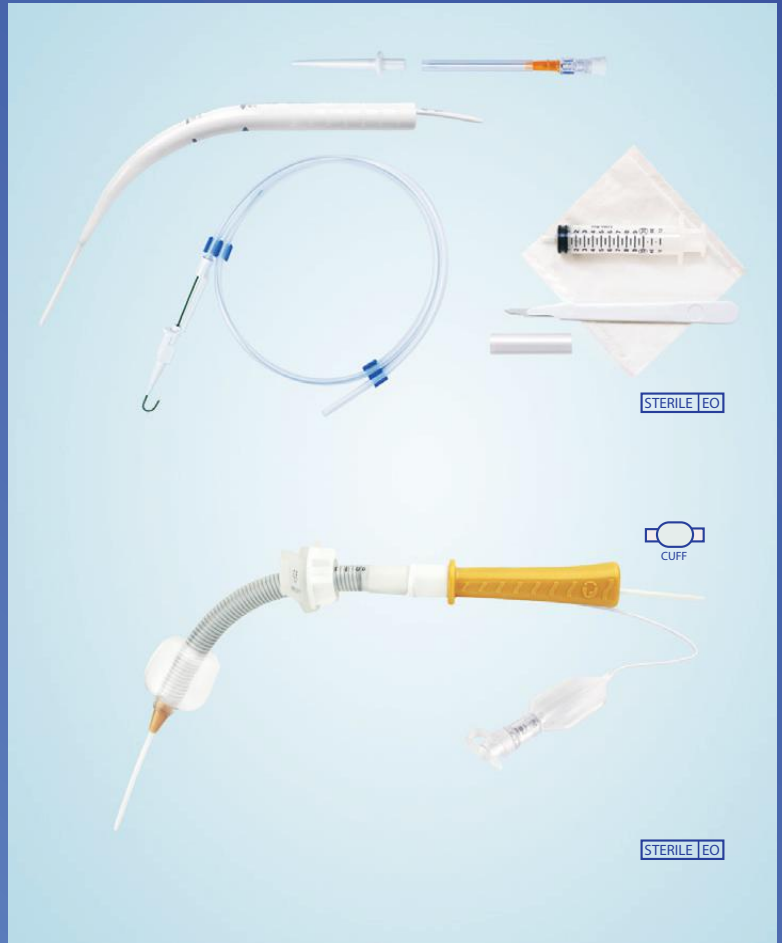

SIZE CHART:

Size	ID	OD	Length along centre line adjustable to	PU	Article number PDT SET TYPE 1
7	7,0 mm	10,4 mm	69 mm	1 Complete Set (Dilation set I+ Priflex Percutrach® tracheostomy tube)	112404
8	8,0 mm	11,4 mm	96 mm	1 Complete Set (Dilation set I+ Priflex Percutrach® tracheostomy tube)	112405
9	9,0 mm	12,4 mm	122 mm	1 Complete Set (Dilation set I+ Priflex Percutrach® tracheostomy tube)	112406

INCLUDING:

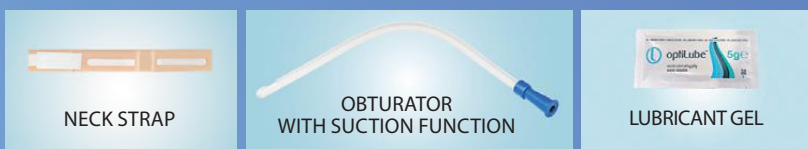

NECK STRAP

OBTURATOR WITH SUCTION FUNCTION

LUBRICANT GEL

PDT SET Type 1
with Priflex PercuTrach®

Package contents per set:

PercuTrach® Dilation set I

- Pre-dilator
- Puncture cannula (14G)
- Dilator (hydrophilic coating)
- Guiding catheter with safety lock
- Guide wire with dispenser
- Gauze compresses
- Syringe
- Scalpel

Priflex PercuTrach® Suction

- Spiral-reinforced tracheostomy tube with 15 mm connector, individually adjustable neck flange and subglottic suction function
- Atraumatic inserter with guiding catheter
- Obturator with suction function
- Neck strap
- Funnel connector
- Lubricant gel



SIZE CHART:

Size	ID	OD	Length along centre line adjustable to	PU	Article number PDT SET TYPE 1
7	7,0 mm	10,4 mm	69 mm	1 Complete Set (Dilation set I+ Priflex Percutrach® tracheostomy tube)	112464
8	8,0 mm	11,4 mm	96 mm	1 Complete Set (Dilation set I+ Priflex Percutrach® tracheostomy tube)	112465
9	9,0 mm	12,4 mm	122 mm	1 Complete Set (Dilation set I+ Priflex Percutrach® tracheostomy tube)	112466

INCLUDING:



NECK STRAP

OBTURATOR WITH SUCTION FUNCTION

LUBRICANT GEL

FUNNEL CONNECTOR

PDT SET Type 1
with ProLine PercuTrach®

Package contents per set:

PercuTrach® Dilation set I

- Pre-dilator
- Puncture cannula (14G)
- Dilator (hydrophilic coating)
- Guiding catheter with safety lock
- Guide wire with dispenser
- Gauze compresses
- Syringe
- Scalpel

ProLine PercuTrach® Cuff

- Outer cannula with bayonet catch and polyurethane low-pressure cuff
- Atraumatic inserter
- 2 unfenestrated, radiopaque inner cannulas with white bayonet ring and swivelling 15 mm connector
- Obturator, perforated
- Neck strap
- Disconnecting wedge
- Lubricant gel



SIZE CHART:

Size	ID _{OC}	ID _{IC}	OD	Length along centre line (OC)	Length along outer bend (OC)	PU	Article number PDT SET TYPE 1
7	8,4 mm	7,0 mm	10,0 mm	75 mm	81 mm	1 Complete Set (Dilation set I+ ProLine Percutrach® tracheostomy tube)	1031270
8	9,4 mm	8,0 mm	11,0 mm	77 mm	84 mm	1 Complete Set (Dilation set I+ ProLine Percutrach® tracheostomy tube)	1031280
9	10,4 mm	9,0 mm	12,0 mm	79 mm	87 mm	1 Complete Set (Dilation set I+ ProLine Percutrach® tracheostomy tube)	1031290

INCLUDING:

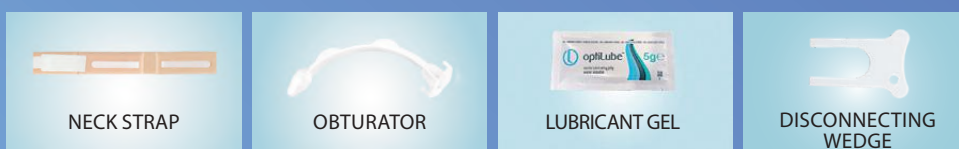

NECK STRAP

OBTURATOR

LUBRICANT GEL

DISCONNECTING WEDGE

**PDT SET Type 1
with ProLine PercuTrach®**

Package contents per set:

PercuTrach® Dilation set I

- Pre-dilator
- Puncture cannula (14G)
- Dilator (hydrophilic coating)
- Guiding catheter with safety lock
- Guide wire with dispenser
- Gauze compresses
- Syringe
- Scalpel

ProLine PercuTrach® Cuff Voice

- Sieved outer cannula with bayonet catch and polyurethane low-pressure cuff
- Atraumatic inserter
- 1 fenestrated, radiopaque inner cannula with blue bayonet ring and swivelling 15 mm connector
- 1 unfenestrated, radiopaque inner cannula with white bayonet ring and swivelling 15 mm connector
- Obturator, perforated
- Neck strap
- Disconnecting wedge
- Funnel connector
- Decannulation cap
- Speaking valve
- Lubricant gel



SIZE CHART:

Size	ID _{OC}	ID _{IC}	OD	Length along centre line (OC)	Length along outer bend (OC)	PU	Article number PDT SET TYPE 1
7	8,4 mm	7,0 mm	10,0 mm	75 mm	81 mm	1 Complete Set (Dilation set I+ ProLine Percutrach® tracheostomy tube)	1031570
8	9,4 mm	8,0 mm	11,0 mm	77 mm	84 mm	1 Complete Set (Dilation set I+ ProLine Percutrach® tracheostomy tube)	1031580
9	10,4 mm	9,0 mm	12,0 mm	79 mm	87 mm	1 Complete Set (Dilation set I+ ProLine Percutrach® tracheostomy tube)	1031590

INCLUDING:



PDT SET Type 1
with ProLine PercuTrach®

Package contents per set:

PercuTrach® Dilatation set I

- Pre-dilator
- Puncture cannula (14G)
- Dilator (hydrophilic coating)
- Guiding catheter with safety lock
- Guide wire with dispenser
- Gauze compresses
- Syringe
- Scalpel

ProLine PercuTrach® Suction

- Outer cannula with bayonet catch, polyurethane low-pressure cuff and subglottic suction function
- Atraumatic inserter
- 2 unfenestrated, radiopaque inner cannulas with white bayonet ring and swivelling 15 mm connector
- Obturator, perforated
- Neck strap
- Disconnecting wedge
- Funnel connector
- Lubricant gel

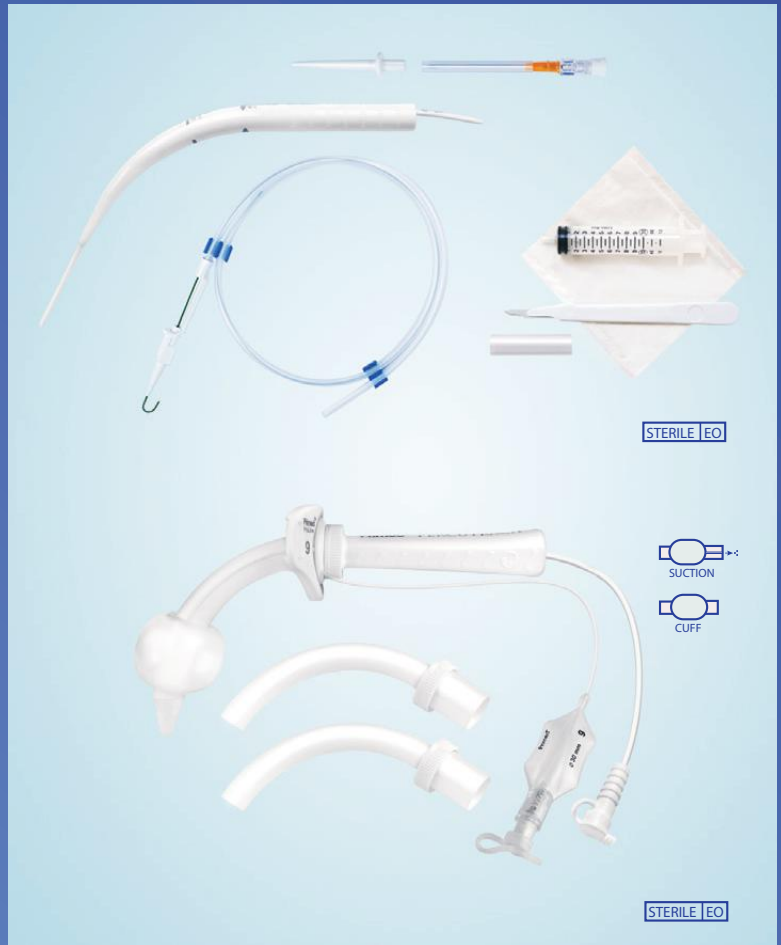

SIZE CHART:

Size	ID _{OC}	ID _{IC}	OD	Length along centre line (OC)	Length along outer bend (OC)	PU	Article number PDT SET TYPE 1
7	8,4 mm	7,0 mm	10,0 mm	75 mm	81 mm	1 Complete Set (Dilatation set I+ ProLine Percutrach® tracheostomy tube)	1031370
8	9,4 mm	8,0 mm	11,0 mm	77 mm	84 mm	1 Complete Set (Dilatation set I+ ProLine Percutrach® tracheostomy tube)	1031380
9	10,4 mm	9,0 mm	12,0 mm	79 mm	87 mm	1 Complete Set (Dilatation set I+ ProLine Percutrach® tracheostomy tube)	1031390

INCLUDING:

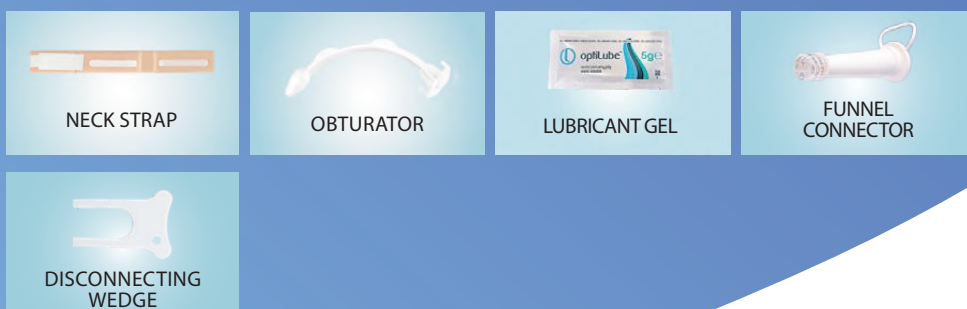

PDT SET Type 1
with ProLine PercuTrach®

Package contents per set:

PercuTrach® Dilatation set I

- Pre-dilator
- Puncture cannula (14G)
- Dilator (hydrophilic coating)
- Guiding catheter with safety lock
- Guide wire with dispenser
- Gauze compresses
- Syringe
- Scalpel

ProLine PercuTrach® Suction Voice

- Sieved outer cannula with bayonet catch, polyurethane low-pressure cuff and subglottic suction function
- Atraumatic inserter
- 1 fenestrated, radiopaque inner cannula with blue bayonet ring and swivelling 15 mm connector
- 1 unfenestrated, radiopaque inner cannula with white bayonet ring and swivelling 15 mm connector
- Obturator, perforated
- Neck strap
- Disconnecting wedge
- Funnel connector
- Decannulation cap
- Speaking valve
- Lubricant gel



SIZE CHART:

Size	ID _{OC}	ID _{IC}	OD	Length along centre line (OC)	Length along outer bend (OC)	PU	Article number PDT SET TYPE 1
7	8,4 mm	7,0 mm	10,0 mm	75 mm	81 mm	1 Complete Set (Dilatation set I+ ProLine Percutrach® tracheostomy tube)	1031670
8	9,4 mm	8,0 mm	11,0 mm	77 mm	84 mm	1 Complete Set (Dilatation set I+ ProLine Percutrach® tracheostomy tube)	1031680
9	10,4 mm	9,0 mm	12,0 mm	79 mm	87 mm	1 Complete Set (Dilatation set I+ ProLine Percutrach® tracheostomy tube)	1031690

INCLUDING:



PDT SET Type 1
with ProLine XT PercuTrach®

Package contents per set:

PercuTrach® Dilation set I

- Pre-dilator
- Puncture cannula (14G)
- Dilator (hydrophilic coating)
- Guiding catheter with safety lock
- Guide wire with dispenser
- Gauze compresses
- Syringe
- Scalpel

ProLine XT PercuTrach® Cuff

- Outer cannula with bayonet catch and polyurethane low-pressure cuff
- Atraumatic inserter
- 2 unfenestrated, radiopaque inner cannulas with white bayonet ring and swivelling 15 mm connector
- Obturator, perforated
- Neck strap
- Disconnecting wedge
- Lubricant gel



SIZE CHART:

Size	ID _{OC}	ID _{IC}	OD	Length along centre line (OC)	Length along outer bend (OC)	PU	Article number PDT SET TYPE 1
7	8,4 mm	7,0 mm	10,0 mm	86 mm	93 mm	1 Complete Set (Dilation set I+ ProLine XT Percutrach® tracheostomy tube)	1032270
8	9,4 mm	8,0 mm	11,0 mm	88 mm	96 mm	1 Complete Set (Dilation set I+ ProLine XT Percutrach® tracheostomy tube)	1032280
9	10,4 mm	9,0 mm	12,0 mm	90 mm	99 mm	1 Complete Set (Dilation set I+ ProLine XT Percutrach® tracheostomy tube)	1032290
10	11,4 mm	10,0 mm	13,0 mm	92 mm	102 mm	1 Complete Set (Dilation set I+ ProLine XT Percutrach® tracheostomy tube)	1032210

INCLUDING:



NECK STRAP

OBTURATOR

LUBRICANT GEL

DISCONNECTING WEDGE

PDT SET Type 1
with ProLine XT PercuTrach®

Package contents per set:

PercuTrach® Dilation set I

- Pre-dilator
- Puncture cannula (14G)
- Dilator (hydrophilic coating)
- Guiding catheter with safety lock
- Guide wire with dispenser
- Gauze compresses
- Syringe
- Scalpel

ProLine XT PercuTrach® Cuff Voice

- Sieved outer cannula with bayonet catch and polyurethane low-pressure cuff
- Atraumatic inserter
- 1 fenestrated, radiopaque inner cannula with blue bayonet ring and swivelling 15 mm connector
- 1 unfenestrated, radiopaque inner cannula with white bayonet ring and swivelling 15 mm connector
- Obturator, perforated
- Neck strap
- Disconnecting wedge
- Funnel connector
- Decannulation cap
- Speaking valve
- Lubricant gel



SIZE CHART:

Size	ID _{OC}	ID _{IC}	OD	Length along centre line (OC)	Length along outer bend (OC)	PU	Article number PDT SET TYPE 1
7	8,4 mm	7,0 mm	10,0 mm	86 mm	93 mm	1 Complete Set (Dilation set I+ ProLine XT Percutrach® tracheostomy tube)	1032570
8	9,4 mm	8,0 mm	11,0 mm	88 mm	96 mm	1 Complete Set (Dilation set I+ ProLine XT Percutrach® tracheostomy tube)	1032580
9	10,4 mm	9,0 mm	12,0 mm	90 mm	99 mm	1 Complete Set (Dilation set I+ ProLine XT Percutrach® tracheostomy tube)	1032590
10	11,4 mm	10,0 mm	13,0 mm	92 mm	102 mm	1 Complete Set (Dilation set I+ ProLine XT Percutrach® tracheostomy tube)	1032510

INCLUDING:



PDT SET Type 1
with ProLine XT PercuTrach®

Package contents per set:

PercuTrach® Dilation set I

- Pre-dilator
- Puncture cannula (14G)
- Dilator (hydrophilic coating)
- Guiding catheter with safety lock
- Guide wire with dispenser
- Gauze compresses
- Syringe
- Scalpel

ProLine XT PercuTrach® Suction

- Outer cannula with bayonet catch, polyurethane low-pressure cuff and subglottic suction function
- Atraumatic inserter
- 2 unfenestrated, radiopaque inner cannulas with white bayonet ring and swivelling 15 mm connector
- Obturator, perforated
- Neck strap
- Disconnecting wedge
- Funnel connector
- Lubricant gel



SIZE CHART:

Size	ID _{OC}	ID _{IC}	OD	Length along centre line (OC)	Length along outer bend (OC)	PU	Article number PDT SET TYPE 1
7	8,4 mm	7,0 mm	10,0 mm	86 mm	93 mm	1 Complete Set (Dilation set I+ ProLine XT Percutrach® tracheostomy tube)	1032370
8	9,4 mm	8,0 mm	11,0 mm	88 mm	96 mm	1 Complete Set (Dilation set I+ ProLine XT Percutrach® tracheostomy tube)	1032380
9	10,4 mm	9,0 mm	12,0 mm	90 mm	99 mm	1 Complete Set (Dilation set I+ ProLine XT Percutrach® tracheostomy tube)	1032390
10	11,4 mm	10,0 mm	13,0 mm	92 mm	102 mm	1 Complete Set (Dilation set I+ ProLine XT Percutrach® tracheostomy tube)	1032310

INCLUDING:

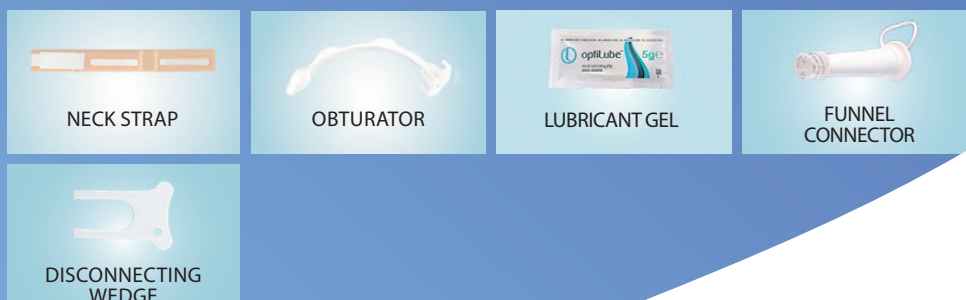

PDT SET Type 1
with ProLine XT PercuTrach®

Package contents per set:

PercuTrach® Dilation set I

- Pre-dilator
- Puncture cannula (14G)
- Dilator (hydrophilic coating)
- Guiding catheter with safety lock
- Guide wire with dispenser
- Gauze compresses
- Syringe
- Scalpel

ProLine XT PercuTrach® Suction Voice

- Sieved outer cannula with bayonet catch, polyurethane low-pressure cuff and subglottic suction function
- Atraumatic inserter
- 1 fenestrated, radiopaque inner cannula with blue bayonet ring and swivelling 15 mm connector
- 1 unfenestrated, radiopaque inner cannula with white bayonet ring and swivelling 15 mm connector
- Obturator, perforated
- Neck strap
- Disconnecting wedge
- Funnel connector
- Decannulation cap
- Speaking valve
- Lubricant gel



SIZE CHART:

Size	ID _{OC}	ID _{IC}	OD	Length along centre line (OC)	Length along outer bend (OC)	PU	Article number PDT SET TYPE 1
7	8,4 mm	7,0 mm	10,0 mm	75 mm	81 mm	1 Complete Set (Dilation set I+ ProLine XT Percutrach® tracheostomy tube)	1032670
8	9,4 mm	8,0 mm	11,0 mm	77 mm	84 mm	1 Complete Set (Dilation set I+ ProLine XT Percutrach® tracheostomy tube)	1032680
9	10,4 mm	9,0 mm	12,0 mm	79 mm	87 mm	1 Complete Set (Dilation set I+ ProLine XT Percutrach® tracheostomy tube)	1032690
10	11,4 mm	10,0 mm	13,0 mm	92 mm	102 mm	1 Complete Set (Dilation set I+ ProLine XT Percutrach® tracheostomy tube)	1032610

INCLUDING:



DILATATION TRACHEOSTOMY

developed by Griggs

The percutaneous dilatation tracheostomy technique according to Griggs is a minimal-invasive treatment. This method implies the tracheal dilation by a tracheal dilating forceps. The closed forceps, featuring a longitudinal duct, is pushed into the trachea via a guide wire. Then the forceps is spread and thus dilates the trachea until the insertion of the required tracheostomy tube is possible.

This technique is a quick and efficient, tissue-conserving dilation procedure and, similar to the Ciaglia method, is characterized by a small skin incision and causing few complications.

The procedure should be performed under bronchoscopic control.

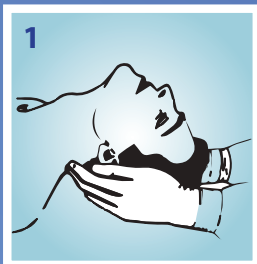

Position patient with hyperextension of neck, cover area around the neck with sterile dressing, disinfect skin

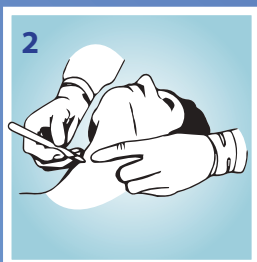

Palpation of neck, sonography (recommended), diaphanoscopy of neck area (obligatory), horizontal incision (1,5-2,0 cm) and blunt preparation up to trachea

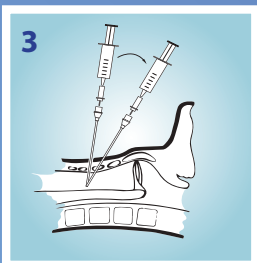

Puncture of trachea

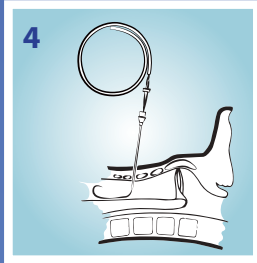

Insertion of guide wire (Seldinger wire)

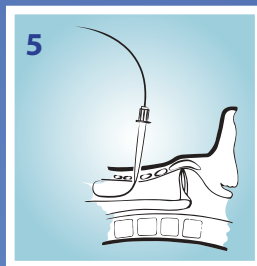

Opening of injection canal by pre-dilator

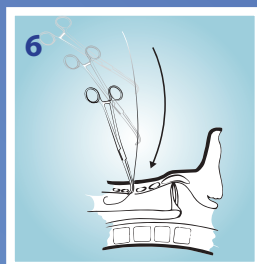

Insert closed tracheal dilating forceps via guide wire and dilate pre-tracheal tissue first.

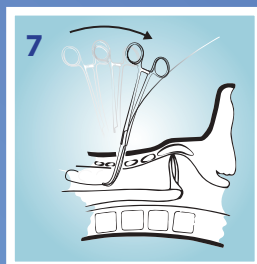

Insert forceps further into trachea and dilate tracheal tissue by spreading.

Remove spread forceps.

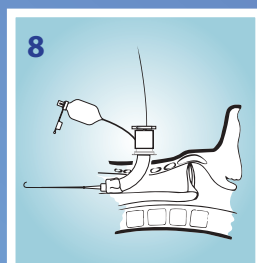

Check the cuff of the tracheostomy tube for leaks. Then introduce the tracheostomy tube with the inserted obturator into the trachea orifice via the guide wire. After positioning, remove the guide wire and obturator together.

Package contents per set:

PercuTrach® Dilatation set II

- Tracheal dilating forceps
- Pre-dilator
- Puncture cannula (14G)
- Gauze compresses
- Syringe
- Scalpel
- Guide wire with dispenser

Optima Basic Cuff

- Outer cannula with cuff and 15 mm universal connector
- 1 transparent, unfenestrated inner cannula
- 1 white, unfenestrated, radiopaque inner cannula
- Obturator, perforated
- Neck strap



SIZE CHART:

Size	ID _{OC}	ID _{IC}	OD	Length along centre line (OC)	Length along outer bend (OC)	PU	Article number PDT SET TYPE 2
7	7,0 mm	5,4 mm	10,5 mm	70,0 mm	79,0 mm	1 Complete Set (Dilatation set II + Optima tracheostomy tube)	112324
8	8,0 mm	6,4 mm	11,6 mm	75,5 mm	87,0 mm	1 Complete Set (Dilatation set II + Optima tracheostomy tube)	112325
9	9,0 mm	7,4 mm	12,6 mm	81,0 mm	93,0 mm	1 Complete Set (Dilatation set II + Optima tracheostomy tube)	112326

INCLUDING:

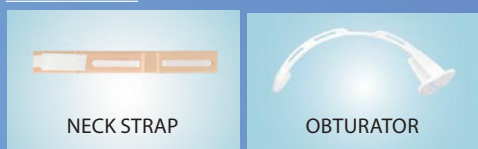

NECK STRAP

OBTURATOR

Package contents per set:

PercuTrach® Dilation set II

- Tracheal dilating forceps
- Pre-dilator
- Puncture cannula (14G)
- Gauze compresses
- Syringe
- Scalpel
- Guide wire with dispenser

Optima Voice Cuff

- Sieved outer cannula with cuff and 15 mm universal connector
- 1 red, fenestrated inner cannula
- 1 white, unfenestrated, radiopaque inner cannula
- Obturator, perforated
- Decannulation cap
- Speaking valve
- Neck strap



SIZE CHART:

Size	ID _{OC}	ID _{IC}	OD	Length along centre line (OC)	Length along outer bend (OC)	PU	Article number PDT SET TYPE 2
7	7,0 mm	5,4 mm	10,5 mm	70,0 mm	79,0 mm	1 Complete Set (Dilation set II + Optima tracheostomy tube)	112334
8	8,0 mm	6,4 mm	11,6 mm	75,5 mm	87,0 mm	1 Complete Set (Dilation set II + Optima tracheostomy tube)	112335
9	9,0 mm	7,4 mm	12,6 mm	81,0 mm	93,0 mm	1 Complete Set (Dilation set II + Optima tracheostomy tube)	112336

INCLUDING:

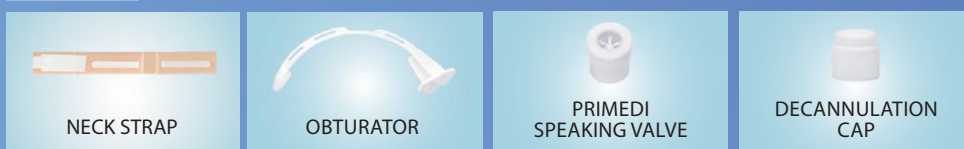

NECK STRAP

OBTURATOR

PRIMEDI
SPEAKING VALVE

DECANNULATION
CAP

Package contents per set:

PercuTrach® Dilation set II

- Tracheal dilating forceps
- Pre-dilator
- Puncture cannula (14G)
- Gauze compresses
- Syringe
- Scalpel
- Guide wire with dispenser

Optima Suction

- Outer cannula with cuff, subglottic suction function and 15 mm universal connector
- 1 transparent, unfenestrated inner cannula
- 1 white, unfenestrated, radiopaque inner cannula
- Obturator, perforated
- Funnel connector
- Neck strap



SIZE CHART:

Size	ID _{OC}	ID _{IC}	OD	Length along centre line (OC)	Length along outer bend (OC)	PU	Article number PDT SET TYPE 2
7	7,0 mm	5,4 mm	10,5 mm	70,0 mm	79,0 mm	1 Complete Set (Dilation set II + Optima tracheostomy tube)	112354
8	8,0 mm	6,4 mm	11,6 mm	75,5 mm	87,0 mm	1 Complete Set (Dilation set II + Optima tracheostomy tube)	112355
9	9,0 mm	7,4 mm	12,6 mm	81,0 mm	93,0 mm	1 Complete Set (Dilation set II + Optima tracheostomy tube)	112356

INCLUDING:



NECK STRAP

OBTURATOR

FUNNEL CONNECTOR

Package contents per set:

PercuTrach® Dilation set II

- Tracheal dilating forceps
- Pre-dilator
- Puncture cannula (14G)
- Gauze compresses
- Syringe
- Scalpel
- Guide wire with dispenser

Optima Suction Voice

- Sieved outer cannula with cuff, subglottic suction function and 15 mm universal connector
- 1 red, fenestrated inner cannula
- 1 white, unfenestrated, radiopaque inner cannula
- Obturator, perforated
- Funnel connector
- Decannulation cap
- Speaking valve
- Neck strap



SIZE CHART:

Size	ID _{OC}	ID _{IC}	OD	Length along centre line (OC)	Length along outer bend (OC)	PU	Article number PDT SET TYPE 2
7	7,0 mm	5,4 mm	10,5 mm	70,0 mm	79,0 mm	1 Complete Set (Dilation set II + Optima tracheostomy tube)	112344
8	8,0 mm	6,4 mm	11,6 mm	75,5 mm	87,0 mm	1 Complete Set (Dilation set II + Optima tracheostomy tube)	112345
9	9,0 mm	7,4 mm	12,6 mm	81,0 mm	93,0 mm	1 Complete Set (Dilation set II + Optima tracheostomy tube)	112346

INCLUDING:

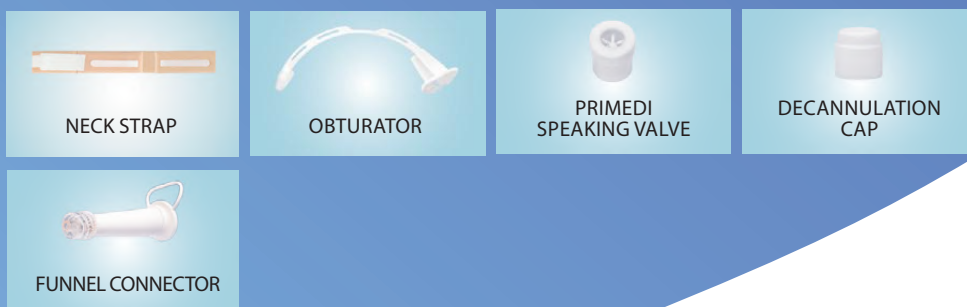

Sets for percutaneous dilatational tracheostomy without tracheostomy tube

Dilation set I

- Pre-dilator
- Puncture cannula (14G)
- Dilator (hydrophilic coating)
- Guiding catheter with safety lock
- Guide wire with dispenser
- Gauze compresses
- Syringe
- Scalpel



Dilation set II

- Tracheal dilating forceps
- Pre-dilator
- Puncture cannula (14G)
- Gauze compresses
- Syringe
- Scalpel
- Guide wire with dispenser



	PU	Article number
Dilation set I	1 set	102086
Dilation set II	1 set	102087

Dilation set II can also be used in conjunction with Percutrach® tracheostomy tubes



TRACHEOSTOMY TUBES

OPTIMA PercuTrach® tracheostomy tubes with atraumatic inserters have been specially developed for use during a dilatational tracheostomy.

The thermosensitive material of the outer cannula with a rigid 15 mm universal connector ensures pleasant wearing comfort. The atraumatic inserter is perfectly adapted for this purpose and snaps securely into the outer cannula. Moreover, it features a practical handle which incorporates elevations that prevent slipping.

The tracheostomy tube set is always provided with two inner cannulas which can be inserted and removed without difficulty and are fixed securely in the outer cannula.

OPTIMA PercuTrach® tracheostomy tubes always have a thin-walled low-pressure cuff which is filled via a one-way valve and securely seals the cannula against the tracheal wall. This avoids inadvertent inhalation of secretions. The soft cuff adapts superbly to the trachea anatomy and ensures reliable sealing, even where low filling pressure is involved.

OPTIMA PercuTrach® tracheostomy tubes are available in sizes 7 – 9 and different designs.

All materials are biocompatible and free of latex and DEHP.

The 15 mm outer cannula connector enables attachment of accessories (HMEs and speaking valves) and serves as a connection for ventilators,- with or without the use of an inner cannula.

TRACHEOSTOMY TUBES

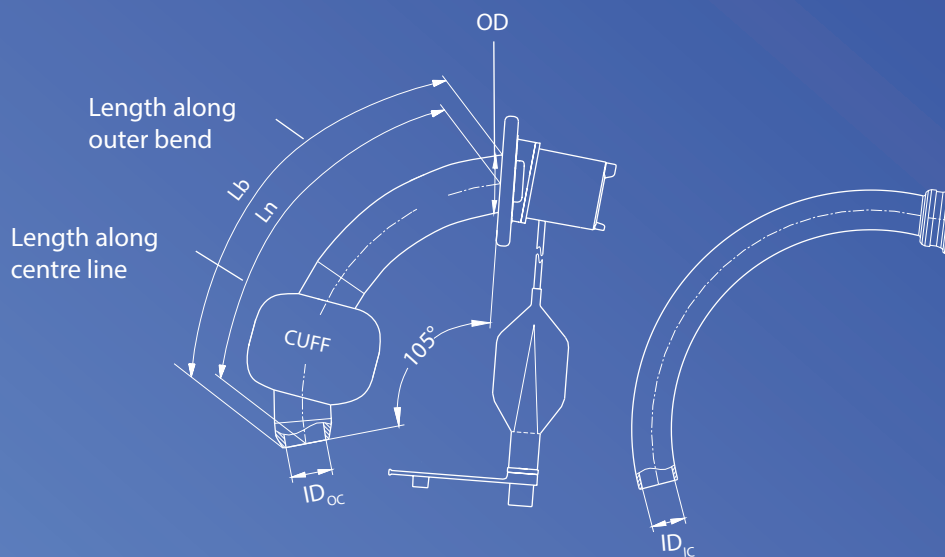

MEASUREMENTS FOR OPTIMA PERCUTRACH®:

Size	ID _{OC}	ID _{IC}	OD	Ln Length along centre line (OC)	Lb Length along outer bend (OC)
7	7,0 mm	5,4 mm	10,5 mm	70,0 mm	79,0 mm
8	8,0 mm	6,4 mm	11,6 mm	75,5 mm	87,0 mm
9	9,0 mm	7,4 mm	12,6 mm	81,0 mm	93,0 mm

ID_{OC} = Inside diameter (clear width) at bottom of outer cannula

ID_{IC} = Inside diameter at bottom of inner cannula

OD = Outside diameter of outer cannula behind the flange

IC = Inner cannula

OC = Outer cannula

Ln = Length along centre line of the outer cannula from neck flange to bottom of the tube

Lb = Length along outer bend of the outer cannula from neck flange to bottom of the tube

PU = Packaging unit

TRACHEOSTOMY TUBES

Product features

- Outer cannula with 15 mm connector and low-pressure cuff
- With atraumatic inserter which ensures gentle and safe positioning of the tracheostomy tube during dilatational tracheostomy or subsequent tube changing
- With inner cannula system
- 1 transparent inner cannula for improved secretion assessment
- 1 white inner cannula made of radiopaque material for position control
- Material: PVC, latex-free, DEHP-free



Indication

- Dilatation tracheostomy
- Tracheostomy/ Laryngectomy
- To prevent aspiration
- Ventilation

OPTIMA PERCUTRACH® BASIC CUFF

SIZE CHART:

Size	ID _{OC}	ID _{IC}	OD	Length		PU	Article number
				Ln	Lb		
7	7,0 mm	5,4 mm	10,5 mm	70,0 mm	79,0 mm	1 set	102424
8	8,0 mm	6,4 mm	11,6 mm	75,5 mm	87,0 mm	1 set	102425
9	9,0 mm	7,4 mm	12,6 mm	81,0 mm	93,0 mm	1 set	102426

INCLUDING:

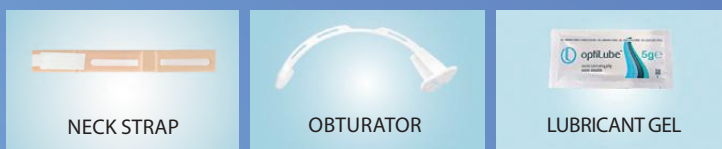

NECK STRAP

OBTURATOR

LUBRICANT GEL



**OPTIONAL
ACCESSORIES**

TRACHEOSTOMY TUBES

Product features

- Sieved outer cannula with 15 mm connector and low-pressure cuff
- With atraumatic inserter which ensures gentle and safe positioning of the tracheostomy tube during dilatational tracheostomy or subsequent tube changing
- With inner cannula system
- 1 red, fenestrated inner cannula enables phonation in conjunction with a speaking valve
- 1 white inner cannula made of radiopaque material for position control
- Material: PVC, latex-free, DEHP-free



Indication

- Dilatation tracheostomy
- Tracheostomy
- Phonation
- Ventilation

OPTIMA PERCUTRACH® VOICE CUFF

SIZE CHART:

Size	ID _{OC}	ID _{IC}	OD	Length		PU	Article number
				Ln	Lb		
7	7,0 mm	5,4 mm	10,5 mm	70,0 mm	79,0 mm	1 set	102434
8	8,0 mm	6,4 mm	11,6 mm	75,5 mm	87,0 mm	1 set	102435
9	9,0 mm	7,4 mm	12,6 mm	81,0 mm	93,0 mm	1 set	102436

INCLUDING:



**OPTIONAL
ACCESSORIES**

TRACHEOSTOMY TUBES

Product features

- Outer cannula with 15 mm connector, low-pressure cuff and subglottic suction function (features an integrated suction line for subglottic secretion suctioning on demand)
- With atraumatic inserter which ensures gentle and safe positioning of the tracheostomy tube during dilatational tracheostomy or subsequent tube changing
- With inner cannula system
- 1 transparent inner cannula for improved secretion assessment
- 1 white inner cannula made of radiopaque material for position control
- Material: PVC, latex-free, DEHP-free

Indication

- Dilatation tracheostomy
- Tracheostomy/ Laryngectomy
- To prevent aspiration
- Ventilation

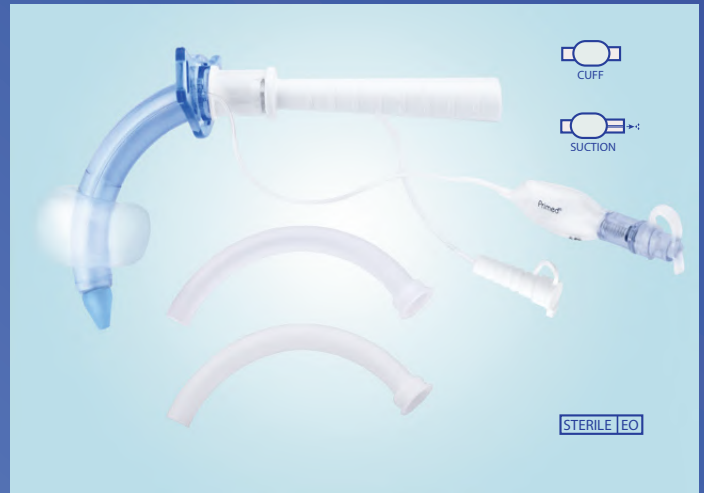

OPTIMA PERCUTRACH® SUCTION

SIZE CHART:

Size	ID _{OC}	ID _{IC}	OD	Length		PU	Article number
				Ln	Lb		
7	7,0 mm	5,4 mm	10,5 mm	70,0 mm	79,0 mm	1 set	102454
8	8,0 mm	6,4 mm	11,6 mm	75,5 mm	87,0 mm	1 set	102455
9	9,0 mm	7,4 mm	12,6 mm	81,0 mm	93,0 mm	1 set	102456

INCLUDING:

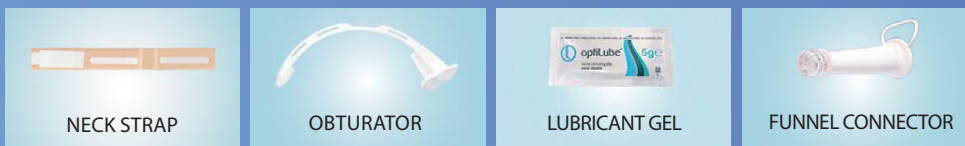

NECK STRAP

OBTURATOR

LUBRICANT GEL

FUNNEL CONNECTOR



**OPTIONAL
ACCESSORIES**

TRACHEOSTOMY TUBES

Product features

- Sieved outer cannula with 15 mm connector, low-pressure cuff and subglottic suction function (features an integrated suction line for subglottic secretion suctioning on demand)
- With atraumatic inserter which ensures gentle and safe positioning of the tracheostomy tube during dilatational tracheostomy or subsequent tube changing
- With inner cannula system
- 1 red, fenestrated inner cannula enables phonation in conjunction with a speaking valve
- 1 white inner cannula made of radiopaque material for position control
- Material: PVC, latex-free, DEHP-free



OPTIMA PERCUTRACH® SUCTION VOICE







Indication

- Dilatation tracheostomy
- Tracheostomy
- Phonation
- Ventilation

SIZE CHART:

Size	ID _{OC}	ID _{IC}	OD	Length		PU	Article number
				Ln	Lb		
7	7,0 mm	5,4 mm	10,5 mm	70,0 mm	79,0 mm	1 set	102444
8	8,0 mm	6,4 mm	11,6 mm	75,5 mm	87,0 mm	1 set	102445
9	9,0 mm	7,4 mm	12,6 mm	81,0 mm	93,0 mm	1 set	102446

INCLUDING:

 NECK STRAP	 OBTURATOR	 LUBRICANT GEL	 PRIMEDI SPEAKING VALVE	 DECANNULATION CAP
 FUNNEL CONNECTOR				



OPTIONAL ACCESSORIES



TRACHEOSTOMY TUBES

Priflex PercuTrach® tracheostomy tubes with atraumatic inserters have been specially developed for use during a dilatational tracheostomy.

They combine a highly stable shape with soft and flexible material properties.

The soft, pliable neck flange has a screw cap for variable adjustment and moulds perfectly to the patient's unique anatomical situation.

The firm 15 mm connector enables attachment of accessories (HMEs and speaking valves) and serves as a connection for ventilators.

The atraumatic inserter is perfectly matched to the tracheostomy tube and has a practical handle which incorporates elevations that prevent slipping.

Priflex PercuTrach® tracheostomy tubes also include a guiding catheter with safety lock in every set.

Priflex PercuTrach® tracheostomy tubes are available with and without subglottic suction function, in sizes 7 – 9.

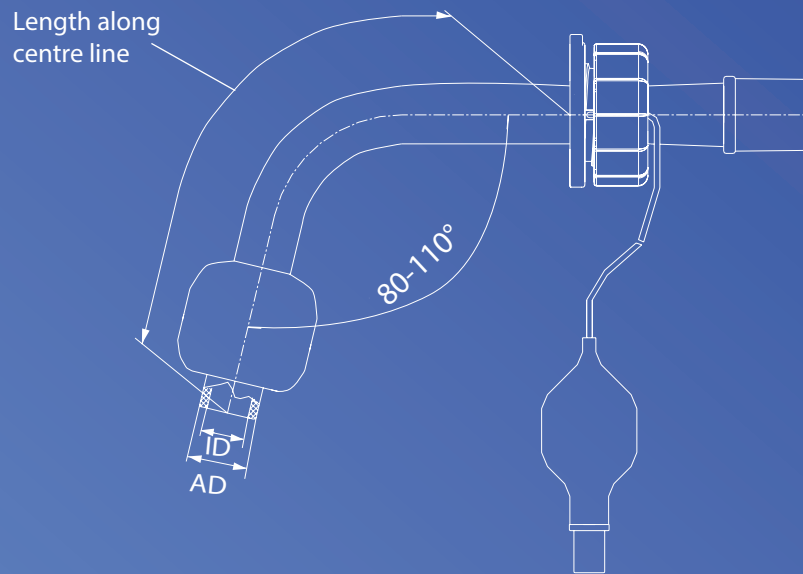

MEASUREMENTS FOR PRIFLEX PERCUTRACH®:

Size	ID	OD	L Length along centre line adjustable to
7	7,0 mm	10,4 mm	69,0 mm
8	8,0 mm	11,4 mm	96,0 mm
9	9,0 mm	12,4 mm	122,0 mm

ID = Inside diameter (clear width) at bottom of tube
 OD = Outside diameter at bottom of tube
 L = Length along centre line from neck flange to bottom of the tube

PU = Packaging unit

TRACHEOSTOMY TUBES

Product features

- Spiral-reinforced tracheostomy tube with 15 mm connector, low-pressure cuff and individually adjustable neck flange
- With atraumatic inserter which ensures gentle and safe positioning of the tracheostomy tube during dilatational tracheostomy or subsequent tube changing
- With guiding catheter
- Material: PVC, metal spiral, latex-free, DEHP-free

Indication

- Dilatation tracheostomy
- Tracheostomy/ Laryngectomy
- To prevent aspiration
- Ventilation
- Obesity/ Oedema

PRIFLEX PERCUTRACH®
WITH CUFF

SIZE CHART:

Size	ID	OD	Length along centre line adjustable to	PU	Article number
7	7,0 mm	10,4 mm	69,0 mm	1 Set	102404
8	8,0 mm	11,4 mm	96,0 mm	1 Set	102405
9	9,0 mm	12,4 mm	122,0 mm	1 Set	102406

INCLUDING:

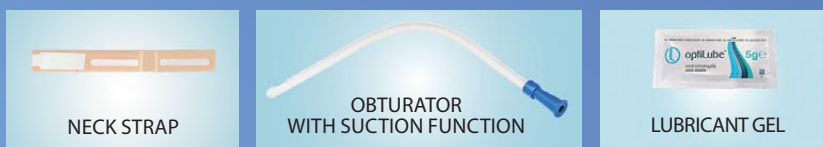

NECK STRAP

OBTURATOR
WITH SUCTION FUNCTION

LUBRICANT GEL

OPTIONAL
ACCESSORIES

TRACHEOSTOMY TUBES

Product features

- Spiral-reinforced tracheostomy tube with 15 mm connector, low-pressure cuff, individually adjustable neck flange and subglottic suction function (features an integrated suction line for subglottic secretion suctioning on demand)
- With atraumatic inserter which ensures gentle and safe positioning of the tracheostomy tube during dilatational tracheostomy or subsequent tube changing
- With guiding catheter
- Material: PVC, metal spiral, latex-free, DEHP-free



PRIFLEX PERCUTRACH® SUCTION

Indication

- Dilatation tracheostomy
- Tracheostomy/ Laryngectomy
- Aspiration
- Ventilation
- Obesity/ Oedema

SIZE CHART:

Size	ID	OD	Length along centre line adjustable to	PU	Article number
7	7,0 mm	10,4 mm	69,0 mm	1 Set	102464
8	8,0 mm	11,4 mm	96,0 mm	1 Set	102465
9	9,0 mm	12,4 mm	122,0 mm	1 Set	102466

INCLUDING:



**OPTIONAL
ACCESSORIES**



TRACHEOSTOMY TUBES

ProLine PercuTrach® and the extra-long **ProLine XT PercuTrach®** tracheostomy tubes with atraumatic inserters have been specially developed for use during a dilatational tracheostomy.

They are made of tissue-friendly polyurethane. Due to the excellent ratio between the inner and outer diameters they allow for maximum air flow.

The atraumatic inserter is perfectly matched to the ProLine outer cannula and can be securely locked in via its bayonet connection. It has a practical handle which incorporates elevations that prevent slipping.

All versions feature an advanced microthin cylindrical polyurethane cuff which adapts ideally to the trachea.

Secretion that accumulates above the cuff, can be removed through an integrated subglottic suction line, featured on our SUCTION models. This suction line is embedded perfectly into the outer cannula to avoid pressure necrosis.

ProLine PercuTrach® tracheostomy tubes are available in sizes 7 – 9, **ProLine XT PercuTrach®** tracheostomy tubes in sizes 7 – 10, and can be ordered each in four different designs.

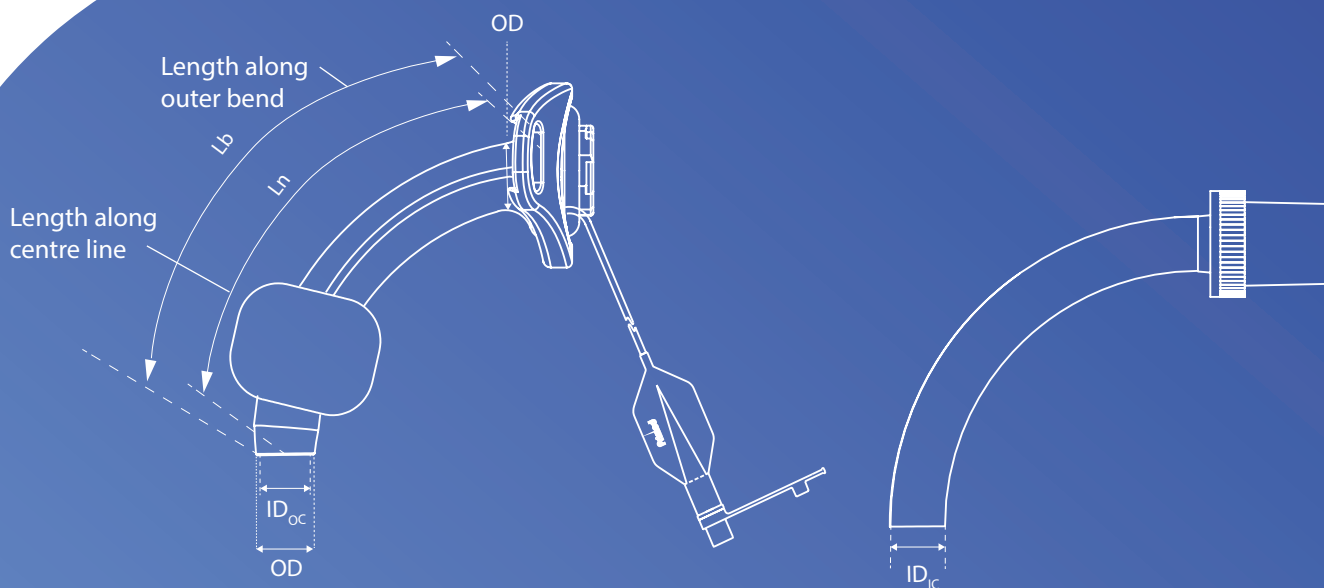

MEASUREMENTS FOR PROLINE PERCUTRACH® & PROLINE XT PERCUTRACH®:

Size	ID_{oc}	ID_{ic}	OD	PROLINE PERCUTRACH®		PROLINE XT PERCUTRACH®	
				L_n Length along centre line (OC)	L_b Length along outer bend (OC)	L_n Length along centre line (OC)	L_b Length along outer bend (OC)
7	8,4 mm	7,0 mm	10,0 mm	75 mm	81 mm	86 mm	93 mm
8	9,4 mm	8,0 mm	11,0 mm	77 mm	84 mm	88 mm	96 mm
9	10,4 mm	9,0 mm	12,0 mm	79 mm	87 mm	90 mm	99 mm
10	11,4 mm	10,0 mm	13,0 mm			92 mm	102 mm

ID_{oc} = Inside diameter (clear width) at bottom of outer cannula

ID_{ic} = Inside diameter at bottom of inner cannula

OD = Outside diameter of outer cannula

IC = Inner cannula

OC = Outer cannula

L_n = Length along centre line of the outer cannula from neck flange to bottom of the tube

L_b = Length along outer bend of the outer cannula from neck flange to bottom of the tube

PU = Packaging unit

Product features

- Outer cannula with bayonet catch and polyurethane low-pressure cuff
- With atraumatic inserter which ensures gentle and safe positioning of the tracheostomy tube during dilatational tracheostomy or subsequent tube changing
- With inner cannula system
- 2 unfenestrated, radiopaque inner cannulas with white bayonet ring and swivelling 15 mm connector
- Material: PU, latex-free, DEHP-free

Indication

- Dilatation tracheostomy
- Tracheostomy/ Laryngectomy
- To prevent aspiration
- Ventilation



PROLINE PERCUTRACH®
CUFF

SIZE CHART:

Size	ID _{OC}	ID _{IC}	OD	Length		PU	Article number
				Ln	Lb		
7	8,4 mm	7,0 mm	10,0 mm	75 mm	81 mm	1 Set	1021270
8	9,4 mm	8,0 mm	11,0 mm	77 mm	84 mm	1 Set	1021280
9	10,4mm	9,0 mm	12,0 mm	79 mm	87 mm	1 Set	1021290

INCLUDING:

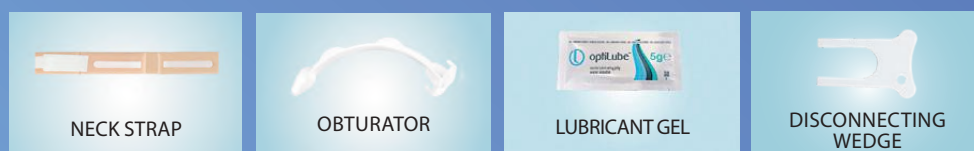

OPTIONAL ACCESSORIES

TRACHEOSTOMY TUBES

Product features

- Sieved outer cannula with bayonet catch, and polyurethane low-pressure cuff
- With atraumatic inserter which ensures gentle and safe positioning of the tracheostomy tube during dilatational tracheostomy or subsequent tube changing
- With inner cannula system
- 1 fenestrated, radiopaque inner cannula with blue bayonet ring and swivelling 15 mm connector
- 1 unfenestrated, radiopaque inner cannula with white bayonet ring and swivelling 15 mm connector
- Material: PU, latex-free, DEHP-free



**PROLINE PERCUTRACH®
CUFF VOICE**







Indication

- Dilatation tracheostomy
- Tracheostomy
- Phonation
- Ventilation

SIZE CHART:

Size	ID _{OC}	ID _{IC}	OD	Length		PU	Article number
				Ln	Lb		
7	8,4 mm	7,0 mm	10,0 mm	75 mm	81 mm	1 Set	1021570
8	9,4 mm	8,0 mm	11,0 mm	77 mm	84 mm	1 Set	1021580
9	10,4mm	9,0 mm	12,0 mm	79 mm	87 mm	1 Set	1021590

INCLUDING:

 NECK STRAP	 OBTURATOR	 LUBRICANT GEL	 PRIMEDI SPEAKING VALVE	 DECANNULATION CAP
 DISCONNECTING WEDGE				



**OPTIONAL
ACCESSORIES**

Product features

- Outer cannula with bayonet catch, polyurethane low-pressure cuff and subglottic suction function (features an integrated suction line for subglottic secretion suctioning on demand)
- With atraumatic inserter which ensures gentle and safe positioning of the tracheostomy tube during dilatational tracheostomy or subsequent tube changing
- With inner cannula system
- 2 unfenestrated, radiopaque inner cannulas with white bayonet ring and swivelling 15 mm connector
- Material: PU, latex-free, DEHP-free



PROLINE PERCUTRACH®
SUCTION

Indication

- Dilatation tracheostomy
- Tracheostomy/ Laryngectomy
- To prevent aspiration
- Ventilation

SIZE CHART:

Size	ID _{OC}	ID _{IC}	OD	Length		PU	Article number
				Ln	Lb		
7	8,4 mm	7,0 mm	10,0 mm	75 mm	81 mm	1 Set	1021370
8	9,4 mm	8,0 mm	11,0 mm	77 mm	84 mm	1 Set	1021380
9	10,4mm	9,0 mm	12,0 mm	79 mm	87 mm	1 Set	1021390

INCLUDING:



OPTIONAL ACCESSORIES

TRACHEOSTOMY TUBES

Product features

- Sieved outer cannula with bayonet catch, polyurethane low-pressure cuff and sub glottic suction function (features an integrated suction line for subglottic secretion suctioning on demand)
- With atraumatic inserter which ensures gentle and safe positioning of the tracheostomy tube during dilatational tracheostomy or subsequent tube changing
- With inner cannula system
- 1 fenestrated, radiopaque inner cannula with blue bayonet ring and swivelling 15 mm connector
- 1 unfenestrated, radiopaque inner cannula with white bayonet ring and swivelling 15 mm connector
- Material: PU, latex-free, DEHP-free



**PROLINE PERCUTRACH®
SUCTION VOICE**







Indication

- Dilatation tracheostomy
- Tracheostomy
- Phonation
- Ventilation

SIZE CHART:

Size	ID _{OC}	ID _{IC}	OD	Length		PU	Article number
				Ln	Lb		
7	8,4 mm	7,0 mm	10,0 mm	75 mm	81 mm	1 Set	1021670
8	9,4 mm	8,0 mm	11,0 mm	77 mm	84 mm	1 Set	1021680
9	10,4mm	9,0 mm	12,0 mm	79 mm	87 mm	1 Set	1021690

INCLUDING:

 NECK STRAP	 OBTURATOR	 LUBRICANT GEL	 PRIMEDI SPEAKING VALVE	 DECANNULATION CAP
 DISCONNECTING WEDGE	 FUNNEL CONNECTOR			



**OPTIONAL
ACCESSORIES**

TRACHEOSTOMY TUBES

Product features

- Outer cannula with bayonet catch and polyurethane low-pressure cuff
- With atraumatic inserter which ensures gentle and safe positioning of the tracheostomy tube during dilatational tracheostomy or subsequent tube changing
- With inner cannula system
- 2 unfenestrated, radiopaque inner cannulas with white bayonet ring and swivelling 15 mm connector
- Material: PU, latex-free, DEHP-free



**PROLINE XT PERCUTRACH®
CUFF**

Indication

- Dilatation tracheostomy
- Tracheostomy/ Laryngectomy
- To prevent aspiration
- Ventilation

SIZE CHART:

Size	ID _{OC}	ID _{IC}	OD	Length		PU	Article number
				Ln	Lb		
7	8,4 mm	7,0 mm	10,0 mm	86 mm	93 mm	1 Set	1022270
8	9,4 mm	8,0 mm	11,0 mm	88 mm	96 mm	1 Set	1022280
9	10,4mm	9,0 mm	12,0 mm	90 mm	99 mm	1 Set	1022290
10	9,4 mm	8,0 mm	11,0 mm	92 mm	102 mm	1 Set	1022210

INCLUDING:

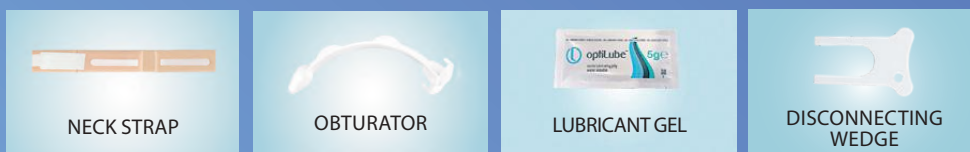

NECK STRAP

OBTURATOR

LUBRICANT GEL

DISCONNECTING WEDGE



**OPTIONAL
ACCESSORIES**

TRACHEOSTOMY TUBES

Product features

- Sieved outer cannula with bayonet catch, and polyurethane low-pressure cuff
- With atraumatic inserter which ensures gentle and safe positioning of the tracheostomy tube during dilatational tracheostomy or subsequent tube changing
- With inner cannula system
- 1 fenestrated, radiopaque inner cannula with blue bayonet ring and swivelling 15 mm connector
- 1 unfenestrated, radiopaque inner cannula with white bayonet ring and swivelling 15 mm connector
- Material: PU, latex-free, DEHP-free



**PROLINE XT PERCUTRACH®
CUFF VOICE**







Indication

- Dilatation tracheostomy
- Tracheostomy
- Phonation
- Ventilation

SIZE CHART:

Size	ID _{OC}	ID _{IC}	OD	Length		PU	Article number
				Ln	Lb		
7	8,4 mm	7,0 mm	10,0 mm	86 mm	93 mm	1 Set	1022570
8	9,4 mm	8,0 mm	11,0 mm	88 mm	96 mm	1 Set	1022580
9	10,4 mm	9,0 mm	12,0 mm	90 mm	99 mm	1 Set	1022590
10	11,4 mm	10,0 mm	13,0 mm	92 mm	102 mm	1 Set	1022510

INCLUDING:

 NECK STRAP	 OBTURATOR	 LUBRICANT GEL	 PRIMEDI SPEAKING VALVE	 DECANNULATION CAP
 DISCONNECTING WEDGE				



**OPTIONAL
ACCESSORIES**

TRACHEOSTOMY TUBES

Product features

- Outer cannula with bayonet catch, polyurethane low-pressure cuff and subglottic suction function (features an integrated suction line for subglottic secretion suctioning on demand)
- With atraumatic inserter which ensures gentle and safe positioning of the tracheostomy tube during dilatational tracheostomy or subsequent tube changing
- With inner cannula system
- 2 unfenestrated, radiopaque inner cannulas with white bayonet ring and swivelling 15 mm connector
- Material: PU, latex-free, DEHP-free



**PROLINE XT PERCUTRACH®
SUCTION**

Indication

- Dilatation tracheostomy
- Tracheostomy/ Laryngectomy
- To prevent aspiration
- Ventilation

SIZE CHART:

Size	ID _{OC}	ID _{IC}	OD	Length		PU	Article number
				Ln	Lb		
7	8,4 mm	7,0 mm	10,0 mm	86 mm	93 mm	1 Set	1022370
8	9,4 mm	8,0 mm	11,0 mm	88 mm	96 mm	1 Set	1022380
9	10,4 mm	9,0 mm	12,0 mm	90 mm	99 mm	1 Set	1022390
10	11,4 mm	10,0 mm	13,0 mm	92 mm	102 mm	1 Set	1022310

INCLUDING:



**OPTIONAL
ACCESSORIES**

TRACHEOSTOMY TUBES

Product features

- Sieved outer cannula with bayonet catch, polyurethane low-pressure cuff and sub glottic suction function (features an integrated suction line for subglottic secretion suctioning on demand)
- With atraumatic inserter which ensures gentle and safe positioning of the tracheostomy tube during dilatational tracheostomy or subsequent tube changing
- With inner cannula system
- 1 fenestrated, radiopaque inner cannula with blue bayonet ring and swivelling 15 mm connector
- 1 unfenestrated, radiopaque inner cannula with white bayonet ring and swivelling 15 mm connector
- Material: PU, latex-free, DEHP-free



**PROLINE XT PERCUTRACH®
SUCTION VOICE**







Indication

- Dilatation tracheostomy
- Tracheostomy
- Phonation
- Ventilation

SIZE CHART:

Size	ID _{OC}	ID _{IC}	OD	Length		PU	Article number
				Ln	Lb		
7	8,4 mm	7,0 mm	10,0 mm	86 mm	93 mm	1 Set	1022670
8	9,4 mm	8,0 mm	11,0 mm	88 mm	96 mm	1 Set	1022680
9	10,4 mm	9,0 mm	12,0 mm	90 mm	99 mm	1 Set	1022690
10	11,4 mm	10,0 mm	13,0 mm	92 mm	102 mm	1 Set	1022610

INCLUDING:

 NECK STRAP	 OBTURATOR	 LUBRICANT GEL	 PRIMEDI SPEAKING VALVE	 DECANNULATION CAP
 DISCONNECTING WEDGE	 FUNNEL CONNECTOR			



**OPTIONAL
ACCESSORIES**



TRACHEOSTOMY TUBES

All types of **OPTIMA** tracheostomy tubes are characterized by a transparent outer cannula with a firmly attached universal 15 mm ISO connector and flexible thermosensitive material properties which ensure good wear properties.

The tubes are lightweight and the inserting and removing of the inner cannula is simple. The inner cannula can be fitted into the 15 mm connector of the outer cannula and is easy to grip via lateral grooves.

The soft flange has lateral eyelets for fixing the inserted tube with a neck strap.

The **OPTIMA** series comprises a complete range of tracheostomy tubes for tracheostomized patients. They are available in five adult sizes 6-10, as uncuffed or cuffed types, with and without phonation or subglottic suction function.

With or without inner cannula in place, the built-in 15 mm ISO connector of the outer cannula allows the attachment of accessories (heat and moisture exchangers (HMEs) and speaking valves) and can also be used for attaching ventilators (in case of cuffed tubes).

TRACHEOSTOMY TUBES

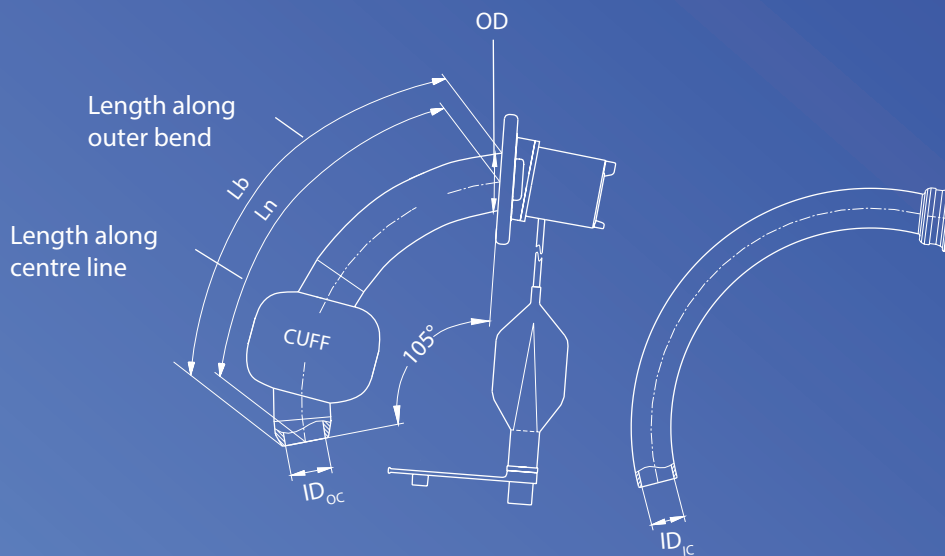

MEASUREMENTS FOR OPTIMA:

Size	ID_{oc}	ID_{ic}	OD	L_n Length along centre line (OC)	L_b Length along outer bend (OC)
6	6,0 mm	4,4 mm	9,2 mm	64,5 mm	73,0 mm
7	7,0 mm	5,4 mm	10,5 mm	70,0 mm	79,0 mm
8	8,0 mm	6,4 mm	11,6 mm	75,5 mm	87,0 mm
9	9,0 mm	7,4 mm	12,6 mm	81,0 mm	93,0 mm
10	10,0 mm	8,4 mm	13,6 mm	87,5 mm	100,0 mm

ID_{oc} = Inside diameter (clear width) at bottom of outer cannula
 ID_{ic} = Inside diameter at bottom of inner cannula
 OD = Outside diameter of outer cannula behind the flange
 IC = Inner cannula
 OC = Outer cannula
 L_n = Length along centre line of the outer cannula from neck flange to bottom of the tube
 L_b = Length along outer bend of the outer cannula from neck flange to bottom of the tube

PU = Packaging unit

TRACHEOSTOMY TUBES

Product features

- Outer cannula with 15 mm connector
- With inner cannula system
- 1 transparent inner cannula for improved secretion assessment
- 1 white inner cannula made of radiopaque material for position control
- Material: PVC, latex-free, DEHP-free

Indication

- Tracheostomy/ Laryngectomy
- Suitable for radiation/ MRI



OPTIMA BASIC

SIZE CHART:

Size	ID _{OC}	ID _{IC}	OD	Length		PU	Article number
				Ln	Lb		
6	6,0 mm	4,4 mm	9,2 mm	64,5 mm	73 mm	1 set	102013
7	7,0 mm	5,4 mm	10,5 mm	70,0 mm	79 mm	1 set	102014
8	8,0 mm	6,4 mm	11,6 mm	75,5 mm	87 mm	1 set	102015
9	9,0 mm	7,4 mm	12,6 mm	81,0 mm	93 mm	1 set	102016
10	10,0 mm	8,4 mm	13,6 mm	87,5 mm	100 mm	1 set	102017

INCLUDING:

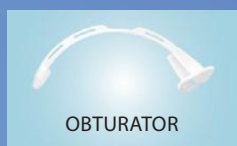

TRACHEOSTOMY TUBES

Product features

- Sieved outer cannula with 15 mm connector
- With inner cannula system
- 1 red, fenestrated inner cannula enables phonation in conjunction with a speaking valve
- 1 white inner cannula made of radiopaque material for position control
- Material: PVC, latex-free, DEHP-free

Indication

- Tracheostomy
- Phonation
- Suitable for radiation/ MRI

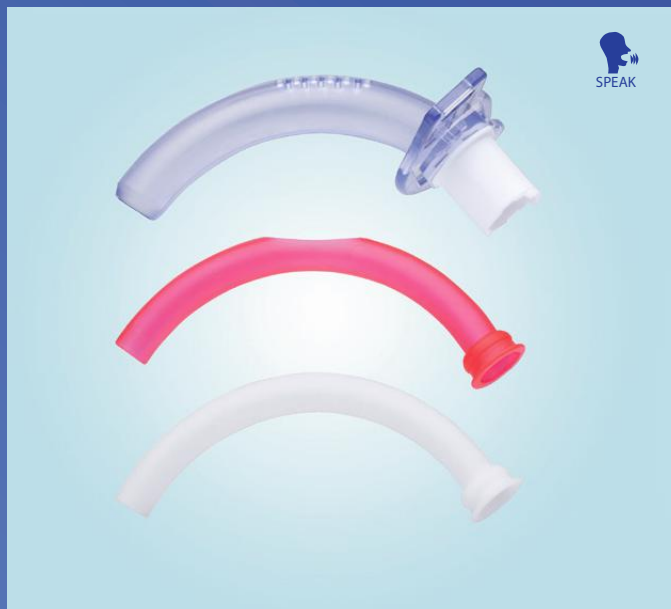

OPTIMA VOICE

SIZE CHART:

Size	ID _{OC}	ID _{IC}	OD	Length		PU	Article number
				L _n	L _b		
6	6,0 mm	4,4 mm	9,2 mm	64,5 mm	73 mm	1 set	102033
7	7,0 mm	5,4 mm	10,5 mm	70,0 mm	79 mm	1 set	102034
8	8,0 mm	6,4 mm	11,6 mm	75,5 mm	87 mm	1 set	102035
9	9,0 mm	7,4 mm	12,6 mm	81,0 mm	93 mm	1 set	102036
10	10,0 mm	8,4 mm	13,6 mm	87,5 mm	100 mm	1 set	102037

INCLUDING:

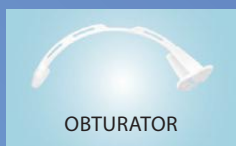

TRACHEOSTOMY TUBES

Product features

- Outer cannula with 15 mm connector and low-pressure cuff
- With inner cannula system
- 1 transparent inner cannula for improved secretion assessment
- 1 white inner cannula made of radiopaque material for position control
- Material: PVC, latex-free, DEHP-free

Indication

- Tracheostomy/ Laryngectomy
- To prevent aspiration
- Ventilation



OPTIMA BASIC CUFF

SIZE CHART:

Size	ID _{OC}	ID _{IC}	OD	Length		PU	Article number
				Ln	Lb		
6	6,0 mm	4,4 mm	9,2 mm	64,5 mm	73 mm	1 set	102023
7	7,0 mm	5,4 mm	10,5 mm	70,0 mm	79 mm	1 set	102024
8	8,0 mm	6,4 mm	11,6 mm	75,5 mm	87 mm	1 set	102025
9	9,0 mm	7,4 mm	12,6 mm	81,0 mm	93 mm	1 set	102026
10	10,0 mm	8,4 mm	13,6 mm	87,5 mm	100 mm	1 set	102027

INCLUDING:

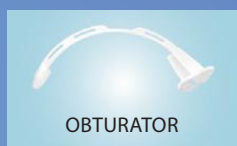

TRACHEOSTOMY TUBES

Product features

- Sieved outer cannula with 15 mm connector and low-pressure cuff
- With inner cannula system
- 1 red, fenestrated inner cannula enables phonation in conjunction with a speaking valve
- 1 white inner cannula made of radiopaque material for position control
- Material: PVC, latex-free, DEHP-free

Indication

- Tracheostomy
- Phonation
- Ventilation

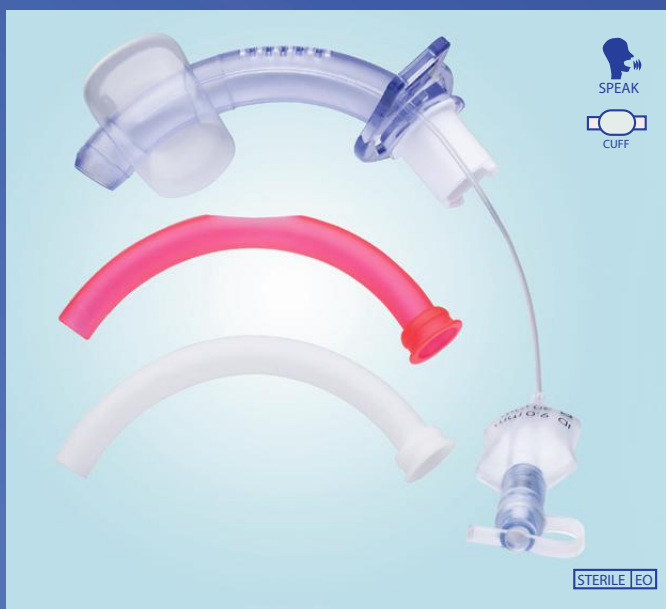

OPTIMA VOICE CUFF

SIZE CHART:

Size	ID _{oc}	ID _{ic}	OD	Length		PU	Article number
				Ln	Lb		
6	6,0 mm	4,4 mm	9,2 mm	64,5 mm	73 mm	1 set	102043
7	7,0 mm	5,4 mm	10,5 mm	70,0 mm	79 mm	1 set	102044
8	8,0 mm	6,4 mm	11,6 mm	75,5 mm	87 mm	1 set	102045
9	9,0 mm	7,4 mm	12,6 mm	81,0 mm	93 mm	1 set	102046
10	10,0 mm	8,4 mm	13,6 mm	87,5 mm	100 mm	1 set	102047

INCLUDING:

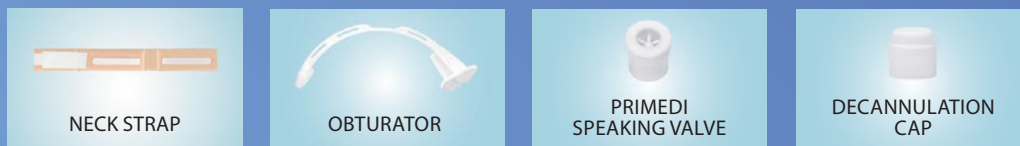

OPTIONAL ACCESSORIES

TRACHEOSTOMY TUBES

Product features

- Outer cannula with 15 mm connector, low-pressure cuff and subglottic suction function (features an integrated suction line for subglottic secretion suctioning on demand)
- With inner cannula system
- 1 transparent inner cannula for improved secretion assessment
- 1 white inner cannula made of radiopaque material for position control
- Material: PVC, latex-free, DEHP-free

Indication

- Tracheostomy/ Laryngectomy
- To prevent aspiration
- Ventilation

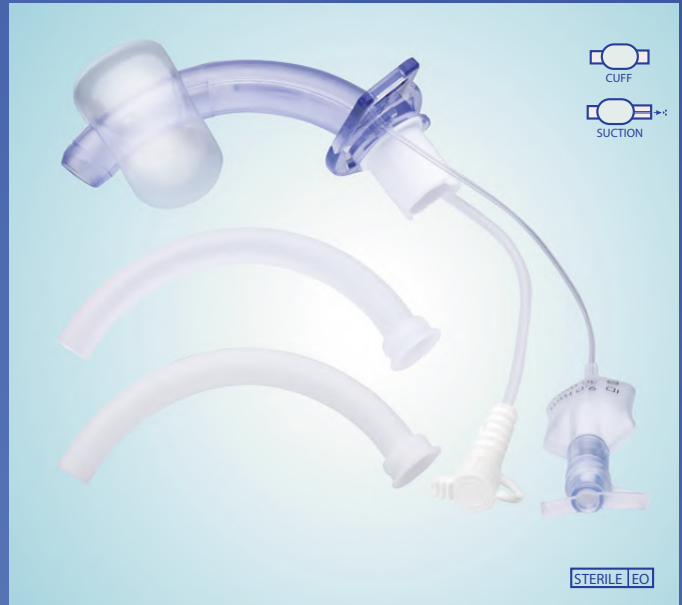

OPTIMA SUCTION

SIZE CHART:

Size	ID _{oc}	ID _{ic}	OD	Length		PU	Article number
				Ln	Lb		
6	6,0 mm	4,4 mm	9,2 mm	64,5 mm	73 mm	1 set	102053
7	7,0 mm	5,4 mm	10,5 mm	70,0 mm	79 mm	1 set	102054
8	8,0 mm	6,4 mm	11,6 mm	75,5 mm	87 mm	1 set	102055
9	9,0 mm	7,4 mm	12,6 mm	81,0 mm	93 mm	1 set	102056
10	10,0 mm	8,4 mm	13,6 mm	87,5 mm	100 mm	1 set	102057

INCLUDING:

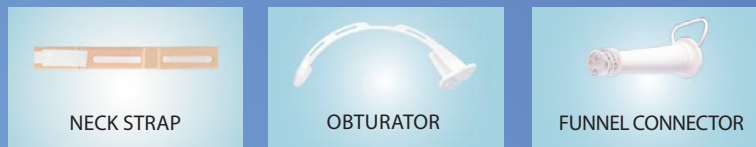

NECK STRAP

OBTURATOR

FUNNEL CONNECTOR



OPTIONAL ACCESSORIES

TRACHEOSTOMY TUBES

Product features

- Sieved outer cannula with 15 mm connector, low-pressure cuff and subglottic suction function (features an integrated suction line for subglottic secretion suctioning on demand)
- With inner cannula system
- 1 red, fenestrated inner cannula enables phonation in conjunction with a speaking valve
- 1 white inner cannula made of radiopaque material for position control
- Material: PVC, latex-free, DEHP-free

Indication

- Tracheostomy
- Phonation
- Ventilation



OPTIMA SUCTION VOICE

SIZE CHART:

Size	ID _{OC}	ID _{IC}	OD	Length		PU	Article number
				Ln	Lb		
6	6,0 mm	4,4 mm	9,2 mm	64,5 mm	73 mm	1 set	102063
7	7,0 mm	5,4 mm	10,5 mm	70,0 mm	79 mm	1 set	102064
8	8,0 mm	6,4 mm	11,6 mm	75,5 mm	87 mm	1 set	102065
9	9,0 mm	7,4 mm	12,6 mm	81,0 mm	93 mm	1 set	102066
10	10,0 mm	8,4 mm	13,6 mm	87,5 mm	100 mm	1 set	102067

INCLUDING:

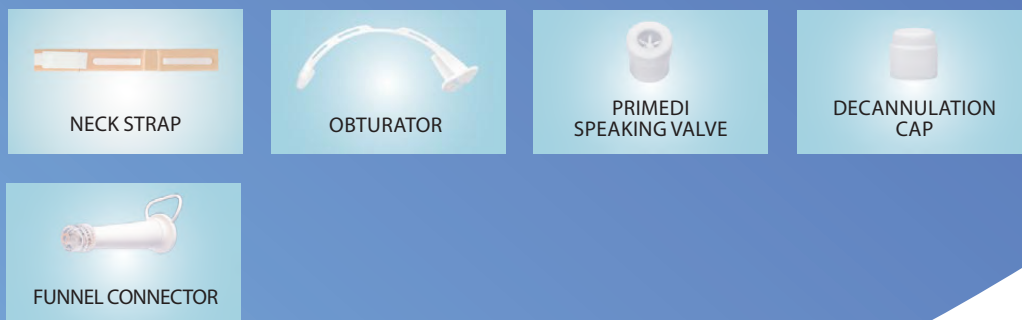

OPTIONAL ACCESSORIES

REPLACEMENT INNER CANNULAS

(A)

Inner cannula A is unfenestrated and transparent for improved secretion assessment



(B)

Inner cannula B is red, fenestrated and enables phonation in conjunction with a speaking valve which is connected to the 15 mm connector of the outer cannula



(C)

Inner cannula C is unfenestrated, white and radiopaque.



SIZE CHART:

REPLACEMENT INNER CANNULAS				
		Transparent (A)	Red, fenestrated (B)	White, radiopaque (C)
Size	PU	Article number	Article number	Article number
6	5/Box	102018	102028	102038
7	5/Box	102019	102029	102039
8	5/Box	102020	102030	102040
9	5/Box	102021	102031	102041
10	5/Box	102022	102032	102042
6	30/Box	102018-30	102028-30	102038-30
7	30/Box	102019-30	102029-30	102039-30
8	30/Box	102020-30	102030-30	102040-30
9	30/Box	102021-30	102031-30	102041-30
10	30/Box	102022-30	102032-30	102042-30



ULTRASOFT tracheostomy tubes are distinguished by particularly soft and flexible material. This applies both to the outer cannula and the inner cannulas. This guarantees wearing properties which ensure maximum wearing comfort.

The cannula is therefore often used in the out-clinical area and of patients with long-term tracheostoma.

Its multidimensional movable neck flange enables adaptation of the **ULTRASOFT** tracheostomy tube to the individual anatomical conditions of every patient. The head remains freely movable without exerting pressure on the trachea.

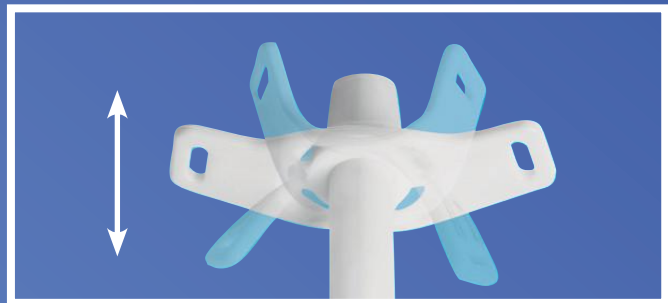
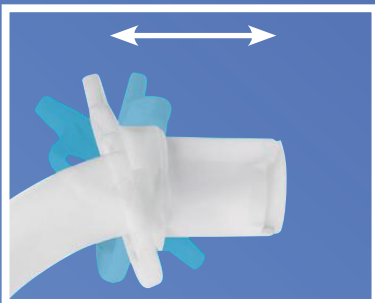

Variants with a cuff are equipped with an extremely thin-walled cylindrical low-pressure polyurethane (PU) cuff which adapts ideally to the trachea. This cuff is functionally superior to conventional PVC balloons and minimises micro-aspiration to the greatest possible extent.*

The **ULTRASOFT** series comprises a complete range of tracheostomy tubes for tracheostomized patients. They are available in five adult sizes 6-10, as uncuffed or cuffed types, with and without phonation or subglottic suction function.

All types of **ULTRASOFT** tracheostomy tubes are characterized by a white outer cannula with a firmly attached universal 15 mm connector. With or without inner cannula in place, this connector allows the attachment of accessories (heat and moisture exchangers (HME) and speaking valves) and can also be used to attach ventilators (in case of cuffed tubes).

Handling is easy and safe. The inner cannula can be inserted in the outer cannula and fitted into the 15 mm connector. The lateral grooves make it easy to grip and remove the inner cannula.

*Lorente L., Lecuona M, Jiménez A, Mora ML, Sierra A: Influence of an endotracheal tube with polyurethane cuff and subglottic secretion drainage on pneumonia. Am J Respir Crit Care Med. 2007 Dec 1;176(11):1079-83. Epub 2007 Sep 13.

Poelaert, J, Depuydt, P, De Wolf, A, Van de Velde, S, Herck, I, and Blot, S. Polyurethane cuffed endotracheal tubes to prevent early postoperative pneumonia after cardiac surgery: a pilot study. J Thorac Cardiovasc Surg. 2008; 135: 771-776.

Dullenkopf, A.; Gerber, A.C.; Weiss, M.; Fit and seal characteristics of a new paediatric tracheal tube with high volume-low pressure polyurethane cuff. Acta Anaesthesiol Scand. 2005 Feb; 49(2): 232-7.

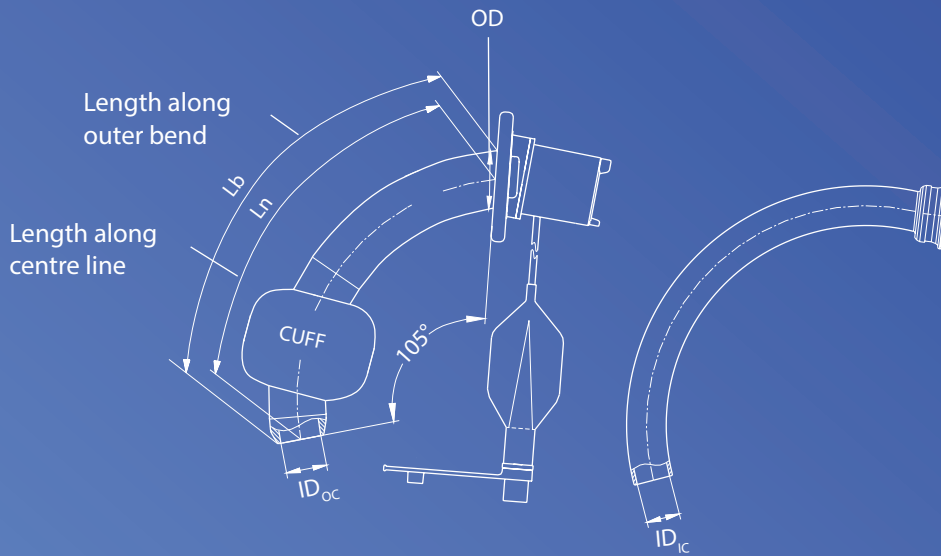

MEASUREMENTS FOR ULTRASOFT:

Size	ID _{oc}	ID _{ic}	OD	Ln Length along centre line (OC)	Lb Length along outer bend (OC)
6	6,0 mm	4,4 mm	9,2 mm	64,5 mm	73,0 mm
7	7,0 mm	5,4 mm	10,5 mm	70,0 mm	79,0 mm
8	8,0 mm	6,4 mm	11,6 mm	75,5 mm	87,0 mm
9	9,0 mm	7,4 mm	12,6 mm	81,0 mm	93,0 mm
10	10,0 mm	8,4 mm	13,6 mm	87,5 mm	100,0 mm

ID_{oc} = Inside diameter (clear width) at bottom of outer cannula

ID_{ic} = Inside diameter at bottom of inner cannula

OD = Outside diameter of outer cannula behind the flange

IC = Inner cannula

OC = Outer cannula

Ln = Length along centre line of the outer cannula from neck flange to bottom of the tube

Lb = Length along outer bend of the outer cannula from neck flange to bottom of the tube

PU = Packaging unit

TRACHEOSTOMY TUBES

Product features

- Outer cannula with 15 mm connector
- High wearing comfort due to especially soft material of both outer and inner cannula
- With inner cannula system
- 1 transparent inner cannula for improved secretion assessment
- 1 white inner cannula made of radiopaque material for position control
- Material: PVC, latex-free, DEHP-free

Indication

- Tracheostomy/ Laryngectomy
- Suitable for radiation/ MRI



ULTRASOFT BASIC

SIZE CHART:

Size	ID _{oc}	ID _{ic}	OD	Length		PU	Article number
				Ln	Lb		
6	6,0 mm	4,4 mm	9,2 mm	64,5 mm	73 mm	1 set	103013
7	7,0 mm	5,4 mm	10,5 mm	70,0 mm	79 mm	1 set	103014
8	8,0 mm	6,4 mm	11,6 mm	75,5 mm	87 mm	1 set	103015
9	9,0 mm	7,4 mm	12,6 mm	81,0 mm	93 mm	1 set	103016
10	10,0 mm	8,4 mm	13,6 mm	87,5 mm	100 mm	1 set	103017

INCLUDING:

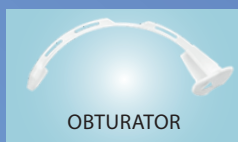

TRACHEOSTOMY TUBES

Product features

- Sieved outer cannula with 15 mm connector
- High wearing comfort due to especially soft material of both outer and inner cannula
- With inner cannula system
- 1 red, fenestrated inner cannula enables phonation in conjunction with a speaking valve
- 1 white inner cannula made of radiopaque material for position control
- Material: PVC, latex-free, DEHP-free

Indication

- Tracheostomy
- Phonation
- Suitable for radiation/ MRI



ULTRASOFT VOICE

SIZE CHART:

Size	ID _{OC}	ID _{IC}	OD	Length		PU	Article number
				Ln	Lb		
6	6,0 mm	4,4 mm	9,2 mm	64,5 mm	73 mm	1 set	103033
7	7,0 mm	5,4 mm	10,5 mm	70,0 mm	79 mm	1 set	103034
8	8,0 mm	6,4 mm	11,6 mm	75,5 mm	87 mm	1 set	103035
9	9,0 mm	7,4 mm	12,6 mm	81,0 mm	93 mm	1 set	103036
10	10,0 mm	8,4 mm	13,6 mm	87,5 mm	100 mm	1 set	103037

INCLUDING:

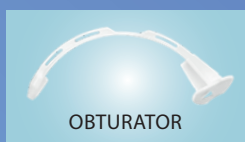

OPTIONAL ACCESSORIES

TRACHEOSTOMY TUBES

Product features

- Outer cannula with 15 mm connector and particularly thin-walled Polyurethan (PU) low-pressure cuff
- High wearing comfort due to especially soft material of both outer and inner cannula
- With inner cannula system
- 1 transparent inner cannula for improved secretion assessment
- 1 white inner cannula made of radiopaque material for position control
- Material: PVC, PU, latex-free, DEHP-free

Indication

- Tracheostomy/ Laryngectomy
- To prevent aspiration
- Ventilation



ULTRASOFT BASIC CUFF

SIZE CHART:

Size	ID _{OC}	ID _{IC}	OD	Length		PU	Article number
				Ln	Lb		
6	6,0 mm	4,4 mm	9,2 mm	64,5 mm	73 mm	1 set	103023
7	7,0 mm	5,4 mm	10,5 mm	70,0 mm	79 mm	1 set	103024
8	8,0 mm	6,4 mm	11,6 mm	75,5 mm	87 mm	1 set	103025
9	9,0 mm	7,4 mm	12,6 mm	81,0 mm	93 mm	1 set	103026
10	10,0 mm	8,4 mm	13,6 mm	87,5 mm	100 mm	1 set	103027

INCLUDING:

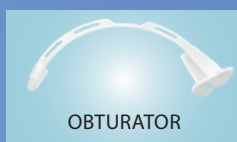

Product features

- Sieved outer cannula with 15 mm connector and particularly thin-walled Polyurethan (PU) low-pressure cuff
- High wearing comfort due to especially soft material of both outer and inner cannula
- With inner cannula system
- 1 red, fenestrated inner cannula enables phonation in conjunction with a speaking valve
- 1 white inner cannula made of radiopaque material for position control
- Material: PVC, PU, latex-free, DEHP-free

Indication

- Tracheostomy
- Phonation
- Ventilation



ULTRASOFT VOICE CUFF

SIZE CHART:

Size	ID _{OC}	ID _{IC}	OD	Length		PU	Article number
				Ln	Lb		
6	6,0 mm	4,4 mm	9,2 mm	64,5 mm	73 mm	1 set	103043
7	7,0 mm	5,4 mm	10,5 mm	70,0 mm	79 mm	1 set	103044
8	8,0 mm	6,4 mm	11,6 mm	75,5 mm	87 mm	1 set	103045
9	9,0 mm	7,4 mm	12,6 mm	81,0 mm	93 mm	1 set	103046
10	10,0 mm	8,4 mm	13,6 mm	87,5 mm	100 mm	1 set	103047

INCLUDING:



OPTIONAL ACCESSORIES

Product features

- Outer cannula with 15 mm connector, particularly thin-walled Polyurethan (PU) low-pressure cuff and subglottic suction function (features an integrated suction line for subglottic secretion suctioning on demand)
- High wearing comfort due to especially soft material of both outer and inner cannula
- With inner cannula system
- 1 transparent inner cannula for improved secretion assessment
- 1 white inner cannula made of radiopaque material for position control
- Material: PVC, PU, latex-free, DEHP-free

Indication

- Tracheostomy/ Laryngectomy
- To prevent aspiration
- Ventilation



ULTRASOFT SUCTION

SIZE CHART:

Size	ID _{OC}	ID _{IC}	OD	Length		PU	Article number
				Ln	Lb		
6	6,0 mm	4,4 mm	9,2 mm	64,5 mm	73 mm	1 set	103053
7	7,0 mm	5,4 mm	10,5 mm	70,0 mm	79 mm	1 set	103054
8	8,0 mm	6,4 mm	11,6 mm	75,5 mm	87 mm	1 set	103055
9	9,0 mm	7,4 mm	12,6 mm	81,0 mm	93 mm	1 set	103056
10	10,0 mm	8,4 mm	13,6 mm	87,5 mm	100 mm	1 set	103057

INCLUDING:

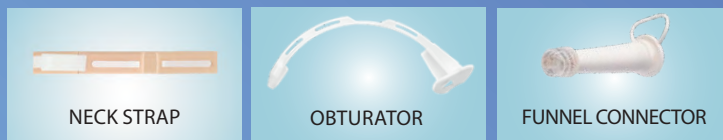

OPTIONAL ACCESSORIES

Product features

- Sieved outer cannula with 15 mm connector, particularly thin-walled Polyurethan (PU) low-pressure cuff and subglottic suction function (features an integrated suction line for subglottic secretion suctioning on demand)
- High wearing comfort due to especially soft material of both outer and inner cannula
- With inner cannula system
- 1 red, fenestrated inner cannula enables phonation in conjunction with a speaking valve
- 1 white inner cannula made of radiopaque material for position control
- Material: PVC, PU, latex-free, DEHP-free

Indication

- Tracheostomy
- Phonation
- Ventilation



ULTRASOFT SUCTION VOICE

SIZE CHART:

Size	ID _{OC}	ID _{IC}	OD	Length		PU	Article number
				Ln	Lb		
6	6,0 mm	4,4 mm	9,2 mm	64,5 mm	73 mm	1 set	103063
7	7,0 mm	5,4 mm	10,5 mm	70,0 mm	79 mm	1 set	103064
8	8,0 mm	6,4 mm	11,6 mm	75,5 mm	87 mm	1 set	103065
9	9,0 mm	7,4 mm	12,6 mm	81,0 mm	93 mm	1 set	103066
10	10,0 mm	8,4 mm	13,6 mm	87,5 mm	100 mm	1 set	103067

INCLUDING:

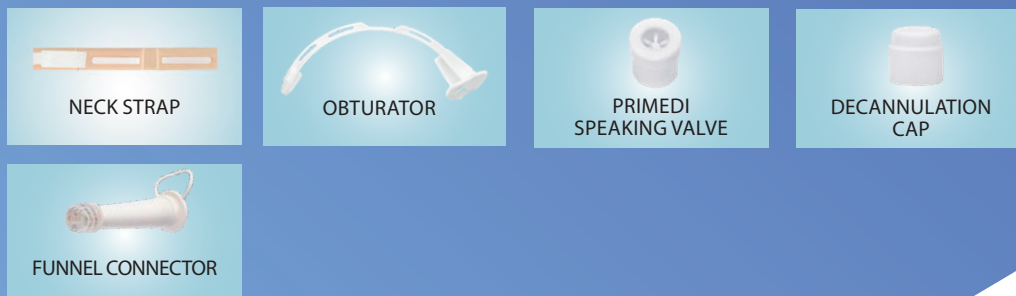

OPTIONAL ACCESSORIES

REPLACEMENT INNER CANNULAS

(A)

Inner cannula A is unfenestrated and transparent for improved secretion assessment



(B)

Inner cannula B is red, fenestrated and enables phonation in conjunction with a speaking valve which is connected to the 15 mm connector of the outer cannula



(C)

Inner cannula C is unfenestrated, white and radiopaque.



SIZE CHART:

REPLACEMENT INNER CANNULAS				
		Transparent (A)	Red, fenestrated (B)	White, radiopaque (C)
Size	PU	Article number	Article number	Article number
6	5/Box	102018	102028	102038
7	5/Box	102019	102029	102039
8	5/Box	102020	102030	102040
9	5/Box	102021	102031	102041
10	5/Box	102022	102032	102042
6	30/Box	102018-30	102028-30	102038-30
7	30/Box	102019-30	102029-30	102039-30
8	30/Box	102020-30	102030-30	102040-30
9	30/Box	102021-30	102031-30	102041-30
10	30/Box	102022-30	102032-30	102042-30



ProLine and the extra-long **ProLine XT** tracheostomy tubes are modern ventilation and therapy tubes suitable for everyday clinical practice as well as for the rehabilitation and Home Care treatment.

They are made of tissue-friendly polyurethane. Due to the excellent relationship between the inner and outer diameters they allow for maximum air flow.

But despite their extremely thin walls, they ensure a high wearing comfort.

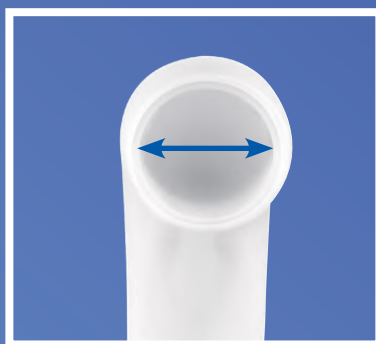

Different types of inner cannulas can be connected to the outer cannula by means of a bayonet catch. These are all equipped with a swivelling 15mm connector, which reduces tensile and shear forces and ensures stable positioning.

For all cuffed models an advanced microthin cylindrical polyurethane cuff is used which adapts ideally to the trachea and minimises microaspiration to the greatest possible extent.*

Secretion that accumulates above the cuff, can be removed through an integrated subglottic suction line, featured on our SUCTION models. This suction line is embedded perfectly into the outer cannula to avoid pressure necrosis.

*Lorente L, Lecuona M, Jiménez A, Mora ML, Sierra A: Influence of an endotracheal tube with polyurethane cuff and subglottic secretion drainage on pneumonia. Am J Respir Crit Care Med. 2007 Dec 1;176(11):1079-83. Epub 2007 Sep 13.

Poelaert, J, Depuydt, P, De Wolf, A, Van de Velde, S, Herck, I, and Blot, S. Polyurethane cuffed endotracheal tubes to prevent early postoperative pneumonia after cardiac surgery: a pilot study. J Thorac Cardiovasc Surg. 2008; 135: 771-776.

Dullenkopf, A.; Gerber, A.C.; Weiss, M.; Fit and seal characteristics of a new paediatric tracheal tube with high volume-low pressure polyurethane cuff. Acta Anaesthesiol Scand. 2005 Feb; 49(2): 232-7.

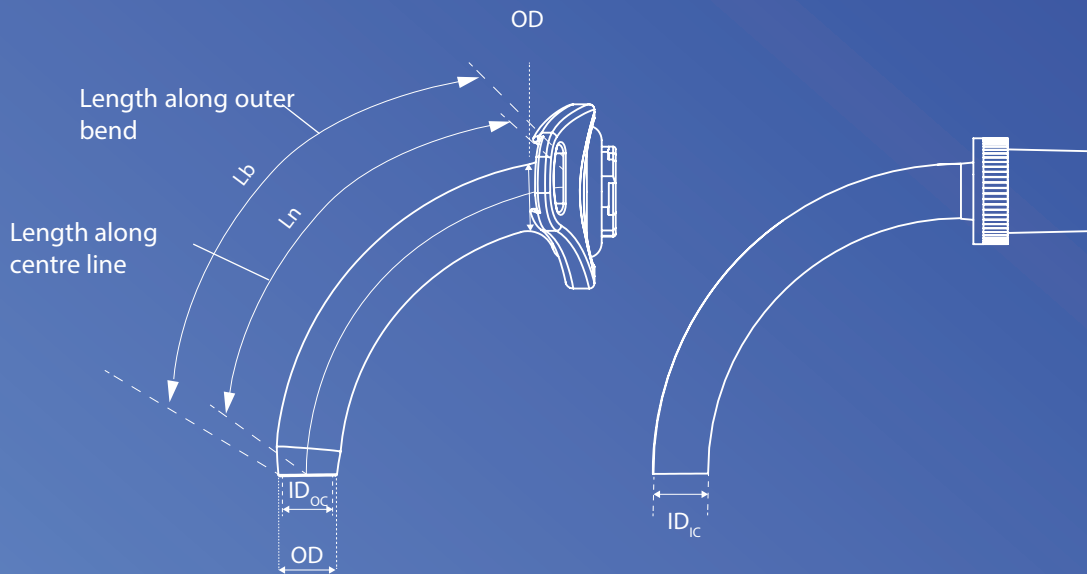

MEASUREMENTS FOR PROLINE & PROLINE XT:

Size	ID _{OC}	ID _{IC}	OD	PROLINE		PROLINE XT	
				Ln Length along centre line (OC)	Lb Length along outer bend (OC)	Ln Length along centre line (OC)	Lb Length along outer bend (OC)
6	7,4 mm	6,0 mm	9,0 mm	73 mm	78 mm		
7	8,4 mm	7,0 mm	10,0 mm	75 mm	81 mm	86 mm	93 mm
8	9,4 mm	8,0 mm	11,0 mm	77 mm	84 mm	88 mm	96 mm
9	10,4 mm	9,0 mm	12,0 mm	79 mm	87 mm	90 mm	99 mm
10	11,4 mm	10,0 mm	13,0 mm	81 mm	90 mm	92 mm	102 mm

ID_{OC} = Inside diameter (clear width) at bottom of outer cannula

ID_{IC} = Inside diameter at bottom of inner cannula

OD = Outside diameter of outer cannula

IC = Inner cannula

OC = Outer cannula

Ln = Length along centre line of the outer cannula from neck flange to bottom of the tube

Lb = Length along outer bend of the outer cannula from neck flange to bottom of the tube

PU = Packaging unit

TRACHEOSTOMY TUBES

Product features

- Outer cannula with bayonet catch
- Generous air supply thanks to extremely thin-walled design and cylindrical form
- With inner cannula system (all inner cannulas are made of radiopaque material for position control)
- 2 inner cannulas with white bayonet ring and swivelling 15 mm connector
- Material: PU, latex-free, DEHP-free

Indication

- Tracheostomy/ Laryngectomy
- Suitable for radiation/ MRI



PROLINE BASIC

SIZE CHART:

Size	ID _{OC}	ID _{IC}	OD	Length		PU	Article number
				Ln	Lb		
6	7,4 mm	6,0 mm	9,0 mm	73 mm	78 mm	1 set	1001160
7	8,4 mm	7,0 mm	10,0 mm	75 mm	81 mm	1 set	1001170
8	9,4 mm	8,0 mm	11,0 mm	77 mm	84 mm	1 set	1001180
9	10,4 mm	9,0 mm	12,0 mm	79 mm	87 mm	1 set	1001190
10	11,4 mm	10,0 mm	13,0 mm	81 mm	90 mm	1 set	1001110

INCLUDING

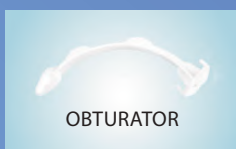

Product features

- Sieved outer cannula with bayonet catch
- Generous air supply thanks to extremely thin-walled design and cylindrical form
- With innercannulasystem (all innercannulas are made of radiopaque material for position control)
- 1 fenestrated inner cannula with blue bayonet ring and swivelling 15 mm connector enables phonation in conjunction with a speaking valve
- 1 inner cannula with swivelling 15 mm connector and white bayonet ring
- Material: PU, latex-free, DEHP-free

Indication

- Tracheostomy
- Phonation
- Suitable for radiation/ MRI



PROLINE BASIC VOICE

SIZE CHART:

Size	ID _{OC}	ID _{IC}	OD	Length		PU	Article number
				Ln	Lb		
6	7,4 mm	6,0 mm	9,0 mm	73 mm	78 mm	1 set	1001460
7	8,4 mm	7,0 mm	10,0 mm	75 mm	81 mm	1 set	1001470
8	9,4 mm	8,0 mm	11,0 mm	77 mm	84 mm	1 set	1001480
9	10,4 mm	9,0 mm	12,0 mm	79 mm	87 mm	1 set	1001490
10	11,4 mm	10,0 mm	13,0 mm	81 mm	90 mm	1 set	1001410

INCLUDING



NECK STRAP



OBTURATOR



PRIMED
SPEAKING VALVE



DECANNULATION
CAP



DISCONNECTING
WEDGE



OPTIONAL ACCESSORIES

TRACHEOSTOMY TUBES

Product features

- Outer cannula with bayonet catch and particularly thin-walled polyurethane (PU) low-pressure cuff
- Generous air supply thanks to extremely thin-walled design and cylindrical form
- With inner cannula system (all inner cannulas are made of radiopaque material for position control)
- 2 inner cannulas with white bayonet ring and swivelling 15 mm connector
- Material: PU, latex-free, DEHP-free

Indication

- Tracheostomy/ Laryngectomy
- To prevent aspiration
- Ventilation



PROLINE CUFF

SIZE CHART:

Size	ID _{OC}	ID _{IC}	OD	Length		PU	Article number
				Ln	Lb		
6	7,4 mm	6,0 mm	9,0 mm	73 mm	78 mm	1 set	1001260
7	8,4 mm	7,0 mm	10,0 mm	75 mm	81 mm	1 set	1001270
8	9,4 mm	8,0 mm	11,0 mm	77 mm	84 mm	1 set	1001280
9	10,4 mm	9,0 mm	12,0 mm	79 mm	87 mm	1 set	1001290
10	11,4 mm	10,0 mm	13,0 mm	81 mm	90 mm	1 set	1001210

INCLUDING

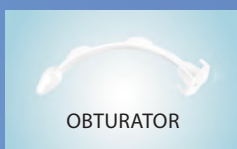

OPTIONAL ACCESSORIES

Product features

- Sieved outer cannula with bayonet catch and particularly thin-walled polyurethane (PU) low-pressure cuff
- Generous air supply thanks to extremely thin-walled design and cylindrical form
- With inner cannula system (all inner cannulas are made of radiopaque material for position control)
- 1 fenestrated inner cannula with blue bayonet ring and swivelling 15 mm connector enables phonation in conjunction with a speaking valve
- 1 inner cannula with swivelling 15 mm connector and white bayonet ring
- Material: PU, latex-free, DEHP-free

Indication

- Tracheostomy
- Phonation
- Ventilation



PROLINE CUFF VOICE

SIZE CHART:

Size	ID _{OC}	ID _{IC}	OD	Length		PU	Article number
				Ln	Lb		
6	7,4 mm	6,0 mm	9,0 mm	73 mm	78 mm	1 set	1001560
7	8,4 mm	7,0 mm	10,0 mm	75 mm	81 mm	1 set	1001570
8	9,4 mm	8,0 mm	11,0 mm	77 mm	84 mm	1 set	1001580
9	10,4 mm	9,0 mm	12,0 mm	79 mm	87 mm	1 set	1001590
10	11,4 mm	10,0 mm	13,0 mm	81 mm	90 mm	1 set	1001510

INCLUDING

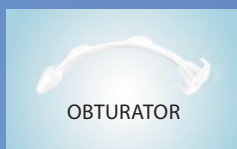

**OPTIONAL
ACCESSORIES**

Product features

- Outer cannula with bayonet catch, particularly thin-walled polyurethane (PU) low-pressure cuff and subglottic suction function (features an integrated suction line for subglottic secretion suctioning on demand)
- Generous air supply thanks to extremely thin-walled design and cylindrical form
- With innercannula system (all inner cannulas are made of radiopaque material for position control)
- 2 inner cannulas with white bayonet ring and swivelling 15 mm connector
- Material: PU, latex-free, DEHP-free

Indication

- Tracheostomy/ Laryngectomy
- To prevent aspiration
- Ventilation



PROLINE SUCTION

SIZE CHART:

Size	ID _{OC}	ID _{IC}	OD	Length		PU	Article number
				Ln	Lb		
6	7,4 mm	6,0 mm	9,0 mm	73 mm	78 mm	1 set	1001360
7	8,4 mm	7,0 mm	10,0 mm	75 mm	81 mm	1 set	1001370
8	9,4 mm	8,0 mm	11,0 mm	77 mm	84 mm	1 set	1001380
9	10,4 mm	9,0 mm	12,0 mm	79 mm	87 mm	1 set	1001390
10	11,4 mm	10,0 mm	13,0 mm	81 mm	90 mm	1 set	1001310

INCLUDING

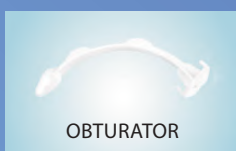

OPTIONAL ACCESSORIES

Product features

- Sieved outer cannula with bayonet catch, particularly thin-walled polyurethane (PU) low-pressure cuff and subglottic suction function (features an integrated suction line for subglottic secretion suctioning on demand)
- Generous air supply thanks to extremely thin-walled design and cylindrical form
- With innercannula system (all innercannulas are made of radiopaque material for position control)
- 1 fenestrated inner cannula with blue bayonet ring and swivelling 15 mm connector enables phonation in conjunction with a speaking valve
- 1 inner cannula with swivelling 15 mm connector and white bayonet ring
- Material: PU, latex-free, DEHP-free

Indication

- Tracheostomy
- Phonation
- Ventilation



PROLINE SUCTION VOICE

SIZE CHART:

Size	ID _{OC}	ID _{IC}	OD	Length		PU	Article number
				Ln	Lb		
6	7,4 mm	6,0 mm	9,0 mm	73 mm	78 mm	1 set	1001660
7	8,4 mm	7,0 mm	10,0 mm	75 mm	81 mm	1 set	1001670
8	9,4 mm	8,0 mm	11,0 mm	77 mm	84 mm	1 set	1001680
9	10,4 mm	9,0 mm	12,0 mm	79 mm	87 mm	1 set	1001690
10	11,4 mm	10,0 mm	13,0 mm	81 mm	90 mm	1 set	1001610

INCLUDING



OPTIONAL ACCESSORIES

REPLACEMENT INNER CANNULAS

All ProLine inner cannulas are made of radiopaque material for precise position control.

They feature a swivelling 15 mm connector, which prevents tensile and shear forces from being transmitted to the tube when ventilators are connected. **(A)**

The standard inner cannula is equipped with a white bayonet ring (A).

The fenestrated inner cannula is equipped with a blue bayonet ring (B.) In conjunction with a speaking valve this cannula enables phonation. **(B)**



SIZE CAHRT:

REPLACEMENT INNER CANNULAS			
Size	PU	WITH WHITE BAYONET RING, UNFENESTRATED (A)	WITH BLUE BAYONET RING, FENESTRATED (B)
		Article number	Article number
6	5/Box	1011160	1011260
7	5/Box	1011170	1011270
8	5/Box	1011180	1011280
9	5/Box	1011190	1011290
10	5/Box	1011110	1011210
6	30/Box	1011160-30	1011260-30
7	30/Box	1011170-30	1011270-30
8	30/Box	1011180-30	1011280-30
9	30/Box	1011190-30	1011290-30
10	30/Box	1011110-30	1011210-30

Product features

- Outer cannula with bayonet catch
- Generous air supply thanks to extremely thin-walled design and cylindrical form
- With inner cannula system (all inner cannulas are made of radiopaque material for position control)
- 2 inner cannulas with white bayonet ring and swivelling 15 mm connector
- Material: PU, latex-free, DEHP-free

Indication

- Tracheostomy/ Laryngectomy
- Suitable for radiation/ MRI



PROLINE XT BASIC

SIZE CHART:

Size	ID _{OC}	ID _{IC}	OD	Length		PU	Article number
				Ln	Lb		
7	8,4 mm	7,0 mm	10,0 mm	86 mm	93 mm	1 Set	1002170
8	9,4 mm	8,0 mm	11,0 mm	88 mm	96 mm	1 Set	1002180
9	10,4 mm	9,0 mm	12,0 mm	90 mm	99 mm	1 Set	1002190
10	11,4 mm	10,0 mm	13,0 mm	92 mm	102 mm	1 Set	1002110

INCLUDING

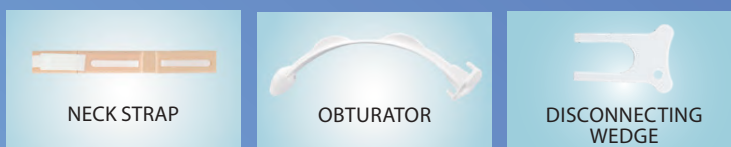

OPTIONAL ACCESSORIES

Product features

- Sieved outer cannula with bayonet catch
- Generous air supply thanks to extremely thin-walled design and cylindrical form
- With inner cannula system (all inner cannulas are made of radiopaque material for position control)
- 1 fenestrated inner cannula with blue bayonet ring and swivelling 15 mm connector enables phonation in conjunction with a speaking valve
- 1 inner cannula with swivelling 15 mm connector and white bayonet ring
- Material: PU, latex-free, DEHP-free

Indication

- Tracheostomy
- Phonation
- Suitable for radiation/ MRI



PROLINE XT BASIC VOICE

SIZE CHART:

Size	ID _{OC}	ID _{IC}	OD	Length		PU	Article number
				Ln	Lb		
7	8,4 mm	7,0 mm	10,0 mm	86 mm	93 mm	1 Set	1002470
8	9,4 mm	8,0 mm	11,0 mm	88 mm	96 mm	1 Set	1002480
9	10,4 mm	9,0 mm	12,0 mm	90 mm	99 mm	1 Set	1002490
10	11,4 mm	10,0 mm	13,0 mm	92 mm	102 mm	1 Set	1002410

INCLUDING



OPTIONAL ACCESSORIES

Product features

- Outer cannula with bayonet catch and particularly thin-walled polyurethane (PU) low-pressure cuff
- Generous air supply thanks to extremely thin-walled design and cylindrical form
- With inner cannula system (all inner cannulas are made of radiopaque material for position control)
- 2 inner cannulas with white bayonet ring and swivelling 15 mm connector
- Material: PU, latex-free, DEHP-free

Indication

- Tracheostomy/ Laryngectomy
- To prevent aspiration
- Ventilation



PROLINE XT CUFF

SIZE CHART:

Size	ID _{OC}	ID _{IC}	OD	Length		PU	Article number
				Ln	Lb		
7	8,4 mm	7,0 mm	10,0 mm	86 mm	93 mm	1 Set	1002270
8	9,4 mm	8,0 mm	11,0 mm	88 mm	96 mm	1 Set	1002280
9	10,4 mm	9,0 mm	12,0 mm	90 mm	99 mm	1 Set	1002290
10	11,4 mm	10,0 mm	13,0 mm	92 mm	102 mm	1 Set	1002210

INCLUDING

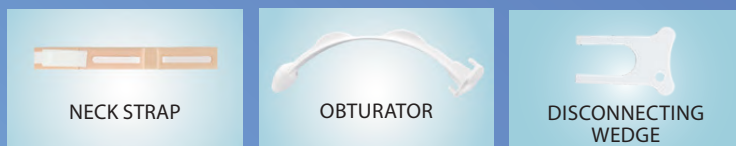

OPTIONAL ACCESSORIES

Product features

- Sieved outer cannula with bayonet catch and particularly thin-walled polyurethane (PU) low-pressure cuff
- Generous air supply thanks to extremely thin-walled design and cylindrical form
- With inner cannula system (all inner cannulas are made of radiopaque material for position control)
- 1 fenestrated inner cannula with blue bayonet ring and swivelling 15 mm connector enables phonation in conjunction with a speaking valve
- 1 inner cannula with swivelling 15 mm connector and white bayonet ring
- Material: PU, latex-free, DEHP-free

Indication

- Tracheostomy
- Phonation
- Ventilation



PROLINE XT CUFF VOICE

SIZE CHART:

Size	ID _{OC}	ID _{IC}	OD	Length		PU	Article number
				Ln	Lb		
7	8,4 mm	7,0 mm	10,0 mm	86 mm	93 mm	1 Set	1002570
8	9,4 mm	8,0 mm	11,0 mm	88 mm	96 mm	1 Set	1002580
9	10,4 mm	9,0 mm	12,0 mm	90 mm	99 mm	1 Set	1002590
10	11,4 mm	10,0 mm	13,0 mm	92 mm	102 mm	1 Set	1002510

INCLUDING



OPTIONAL ACCESSORIES

Product features

- Outer cannula with bayonet catch, particularly thin-walled polyurethane (PU) low-pressure cuff and subglottic suction function (features an integrated suction line for subglottic secretion suctioning on demand)
- Generous air supply thanks to extremely thin-walled design and cylindrical form
- With inner cannula system (all inner cannulas are made of radiopaque material for position control)
- 2 inner cannulas with white bayonet ring and swivelling 15 mm connector
- Material: PU, latex-free, DEHP-free



Indication

- Tracheostomy/ Laryngectomy
- To prevent aspiration
- Ventilation

PROLINE XT SUCTION

SIZE CHART:

Size	ID _{OC}	ID _{IC}	OD	Length		PU	Article number
				Ln	Lb		
7	8,4 mm	7,0 mm	10,0 mm	86 mm	93 mm	1 Set	1002370
8	9,4 mm	8,0 mm	11,0 mm	88 mm	96 mm	1 Set	1002380
9	10,4 mm	9,0 mm	12,0 mm	90 mm	99 mm	1 Set	1002390
10	11,4 mm	10,0 mm	13,0 mm	92 mm	102 mm	1 Set	1002310

INCLUDING

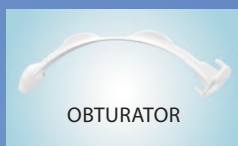

Product features

- Sieved outer cannula with bayonet catch, particularly thin-walled polyurethane (PU) low-pressure cuff and subglottic suction function (features an integrated suction line for subglottic secretion suctioning on demand)
- Generous air supply thanks to extremely thin-walled design and cylindrical form
- With inner cannula system (all inner cannulas are made of radiopaque material for position control)
- 1 fenestrated inner cannula with blue bayonet ring and swivelling 15 mm connector enables phonation in conjunction with a speaking valve
- 1 inner cannula with swivelling 15 mm connector and white bayonet ring
- Material: PU, latex-free, DEHP-free



PROLINE XT SUCTION VOICE

Indication

- Tracheostomy
- Phonation
- Ventilation

SIZE CHART:

Size	ID _{OC}	ID _{IC}	OD	Length		PU	Article number
				Ln	Lb		
7	8,4 mm	7,0 mm	10,0 mm	86 mm	93 mm	1 Set	1002670
8	9,4 mm	8,0 mm	11,0 mm	88 mm	96 mm	1 Set	1002680
9	10,4 mm	9,0 mm	12,0 mm	90 mm	99 mm	1 Set	1002690
10	11,4 mm	10,0 mm	13,0 mm	92 mm	102 mm	1 Set	1002610

INCLUDING

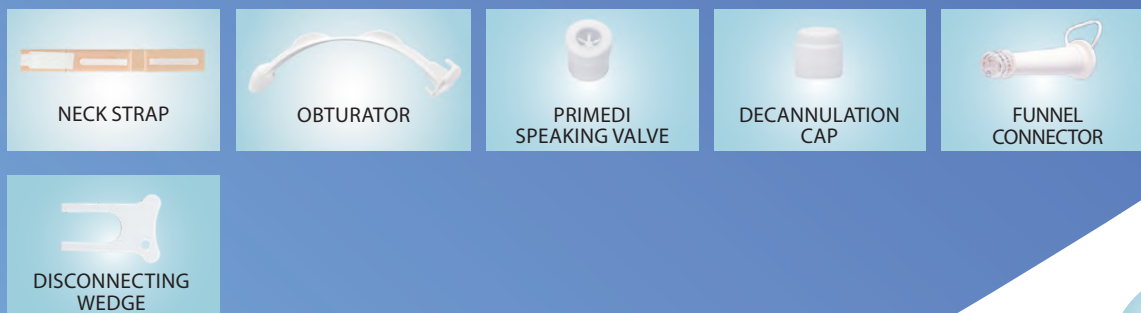

OPTIONAL ACCESSORIES

REPLACEMENT INNER CANNULAS

All ProLine XT inner cannulas are made of radiopaque material for precise position control.

They feature a swivelling 15 mm connector, which prevents tensile and shear forces from being transmitted to the tube when ventilators are connected. **(A)**

The standard inner cannula is equipped with a white bayonet ring (A).

The fenestrated inner cannula is equipped with a blue bayonet ring (B.) In conjunction with a speaking valve this cannula enables phonation. **(B)**



SIZE CAHRT:

REPLACEMENT INNER CANNULAS			
Size	PU	WITH WHITE BAYONET RING, UNFENESTRATED (A)	WITH BLUE BAYONET RING, FENESTRATED (B)
		Article number	Article number
7	5/Box	1012170	1012270
8	5/Box	1012180	1012280
9	5/Box	1012190	1012290
10	5/Box	1012110	1012210



TRACHEOSTOMY TUBES

PRIFLEX® tracheostomy tubes are spiral-reinforced cannulas that combine a highly stable shape with soft and flexible material properties.

The flexible **PRIFLEX®** tracheostomy tubes feature an individually adjustable neck flange with soft and flexible wings which ensures accurate placement of the cannula. A scale on the tracheostomy tube facilitates the exact positioning.

PRIFLEX® tracheostomy tubes feature a firm 15 mm universal connector which enables the attachment of accessories (HME and speaking valves) as well as mechanical ventilators.

The metal spiral in the wall of the soft tube ensures that the tube retains its shape and it prevents kinking. Even the **PRIFLEX®** tracheostomy tubes with speech function have a continuous spiral reinforcement, in which a phonation sieving is imbedded.



Sieving in continuous reinforcement
(PRIFLEX® tracheostomy tube)

PRIFLEX® tracheostomy tubes are high-quality sterile products made of latex-free medical-grade materials.

These tracheostomy tubes are appropriate for insertion especially in ventilated patients, adipose patients and in case of postoperative oedema as well as a sunken tracheostoma.

TRACHEOSTOMY TUBES

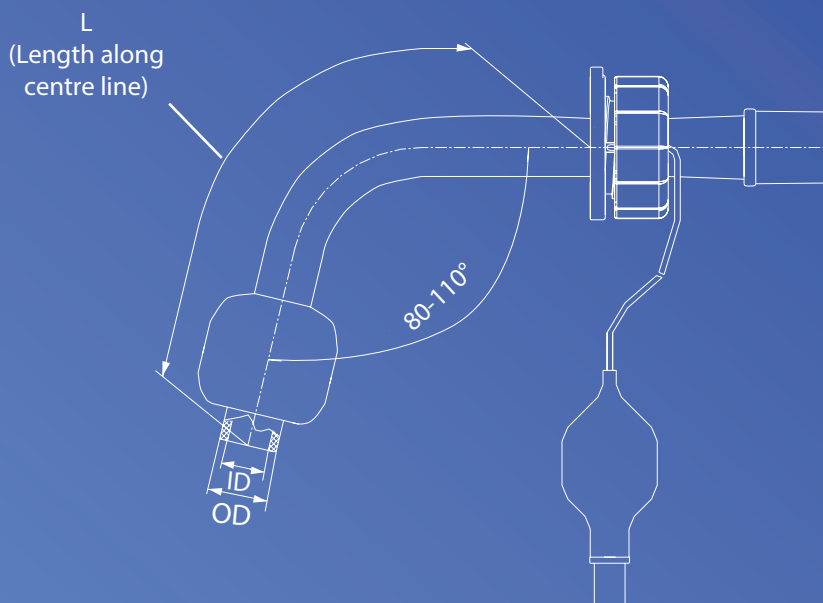

MEASUREMENTS FOR PRIFLEX®:

for the types
PRIFLEX® without Cuff, PRIFLEX® with Cuff and PRIFLEX® Suction

Size	ID	OD	L Lenght along centre line adjustable to
6	6,0 mm	9,4 mm	69,0 mm
7	7,0 mm	10,4 mm	69,0 mm
8	8,0 mm	11,4 mm	96,0 mm
9	9,0 mm	12,4 mm	122,0 mm
10	10,0 mm	13,4 mm	122,0 mm
11	11,0 mm	14,4 mm	123,0 mm

ID = Inside diameter at the bottom of the tube

OD = Outside diameter at the bottom of the tube

L = Length along centre line of the tube from neck flange to bottom of the tube

PU = Packaging unit

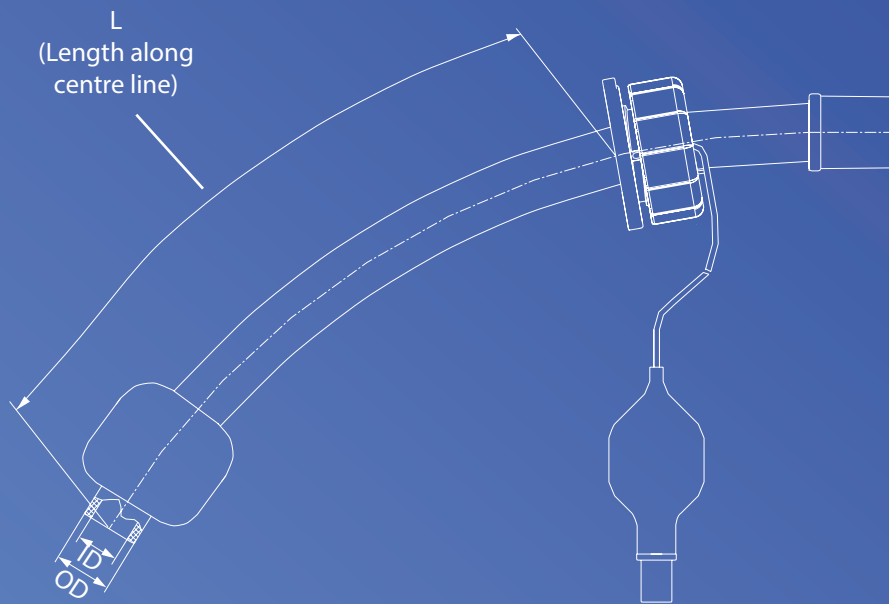

MEASUREMENTS FOR PRIFLEX® XL:

Size	ID	OD	L Lenght along centre line adjustable to
7	7,0 mm	10,4 mm	155,0 mm
8	8,0 mm	11,4 mm	155,0 mm
9	9,0 mm	12,4 mm	155,0 mm
10	10,0 mm	13,4 mm	155,0 mm
11	11,0 mm	14,4 mm	155,0 mm

ID = Inside diameter at the bottom of the tube

OD = Outside diameter at the bottom of the tube

L = Length along centre line of the tube from neck flange to bottom of the tube

PU = Packaging unit

TRACHEOSTOMY TUBES

Product features

- Spiral-reinforced tracheostomy tube with 15 mm connector and individually adjustable neck flange
- Versions with speaking option feature a special kink-resistant sieving within a continuous spiral-reinforcement
- Material: PVC, metal spiral, latex-free, DEHP-free

Indication

- Tracheostomy/ Laryngectomy
- Obesity/ Oedema

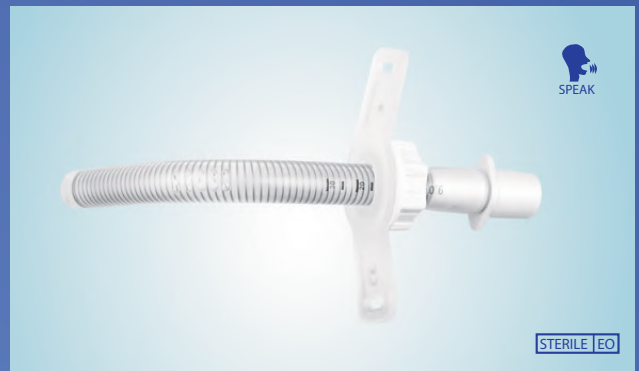

SIZE CHART:

Size	ID	OD	Length (adjustable to)	PU	WITHOUT CUFF	WITHOUT CUFF/ WITH SIEVING
					Article number	Article number
6	6,0 mm	9,4 mm	69 mm	1 set	200802	200803
7	7,0 mm	10,4 mm	69 mm	1 set	200804	200809
8	8,0 mm	11,4 mm	96 mm	1 set	200805	200810
9	9,0 mm	12,4 mm	122 mm	1 set	200806	200811
10	10,0 mm	13,4 mm	122 mm	1 set	200807	200812
11	11,0 mm	14,4 mm	123 mm	1 set	200808	200813

INCLUDING:

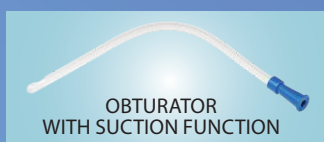

Product features

- Spiral-reinforced tracheostomy tube with 15 mm connector, low-pressure cuff and individually adjustable neck flange
- Versions with speaking option feature a special kink-resistant sieving within a continuous spiral-reinforcement
- Material: PVC, metal spiral, latex-free, DEHP-free

Indication

- Tracheostomy/ Laryngectomy
- Ventilation
- Obesity/ Oedema



SIZE CHART:

Size	ID	OD	Length (adjustable to)	PU	WITH CUFF	
					Article number	WITH CUFF/ WITH SIEVING Article number
6	6,0 mm	9,4 mm	69 mm	1 set	200824	200825
7	7,0 mm	10,4 mm	69 mm	1 set	200814	200819
8	8,0 mm	11,4 mm	96 mm	1 set	200815	200820
9	9,0 mm	12,4 mm	122 mm	1 set	200816	200821
10	10,0 mm	13,4 mm	122 mm	1 set	200817	200822
11	11,0 mm	14,4 mm	123 mm	1 set	200818	200823

INCLUDING:

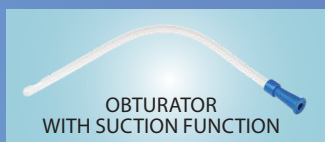

OPTIONAL ACCESSORIES

TRACHEOSTOMY TUBES

Product features

- Spiral-reinforced tracheostomy tube with 15 mm connector, low-pressure cuff, individually adjustable neck flange and subglottic suction function (features an integrated suction line for subglottic secretion suctioning on demand)
- Material: PVC, metal spiral, latex-free, DEHP-free

Indication

- Tracheostomy/ Laryngectomy
- To prevent aspiration
- Ventilation
- Obesity/ Oedema



PRIFLEX® SUCTION

SIZE CHART:

Size	ID	OD	Length (adjustable to)	PU	Article number
6	6,0 mm	9,4 mm	69 mm	1 set	203713
7	7,0 mm	10,4 mm	69 mm	1 set	203714
8	8,0 mm	11,4 mm	96 mm	1 set	203715
9	9,0 mm	12,4 mm	122 mm	1 set	203716
10	10,0 mm	13,4 mm	122 mm	1 set	203717
11	11,0 mm	14,4 mm	123 mm	1 set	203718

INCLUDING:



NECK STRAP



OBTURATOR
WITH SUCTION FUNCTION



FUNNEL CONNECTOR



**OPTIONAL
ACCESSORIES**

TRACHEOSTOMY TUBES

Product features

- Extra-long spiral-reinforced tracheostomy tube with 15 mm connector, low-pressure cuff and individually adjustable neck flange
- Not performed, thus enables individual adaptation to the anatomical conditions of the patient
- Material: PVC, metal spiral, latex-free, DEHP-free

Indication

- Tracheostomy/ Laryngectomy
- To prevent aspiration
- Ventilation
- Obesity/ Oedema
- Tracheal stenoses
- Presence of large parastomal soft tissue (e.g. tumours)



PRIFLEX® XL

SIZE CHART:

Size	ID	OD	Length (adjustable to)	PU	Article number
7	7,0 mm	10,4 mm	155 mm	1 set	200797
8	8,0 mm	11,4 mm	155 mm	1 set	200798
9	9,0 mm	12,4 mm	155 mm	1 set	200799
10	10,0 mm	13,4 mm	155 mm	1 set	200800
11	11,0 mm	14,4 mm	155 mm	1 set	200801

INCLUDING:

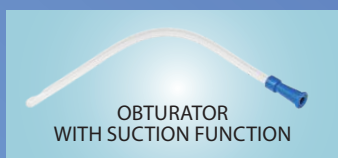



TRACHEOSTOMY TUBES

PRIFLEX® MRI stand for a new generation of tracheostomy tubes with plastic spiral reinforcement which are suitable for MRI.

These tracheostomy tubes **do not contain any metal parts** - even the pilot balloon is equipped with a special plastic spring -, what makes them suitable for patients who undergo a magnetic resonance imaging (MRI) procedure or need radiation therapy.

They combine a high form stability with soft and flexible material features, which is also characteristic for tubes with classical metal spiral reinforcement. The soft and flexible tube flange is variably adjustable by a simple screw cap. It adapts exactly to the individual patient requirements.

A scale on the tracheostomy tube facilitates the exact positioning, and a firm 15 mm universal connector enables the attachment of accessories (HME and speaking valves) as well as mechanical ventilators.

The integrated plastic spiral ensures the form stability and kink resistance of the tracheostomy tubes.

PRIFLEX® MRI tracheostomy tubes are suitable especially for the use in ventilated neurological patients, as well as in patients whose treatment plan includes MRI or radiation therapy.

TRACHEOSTOMY TUBES

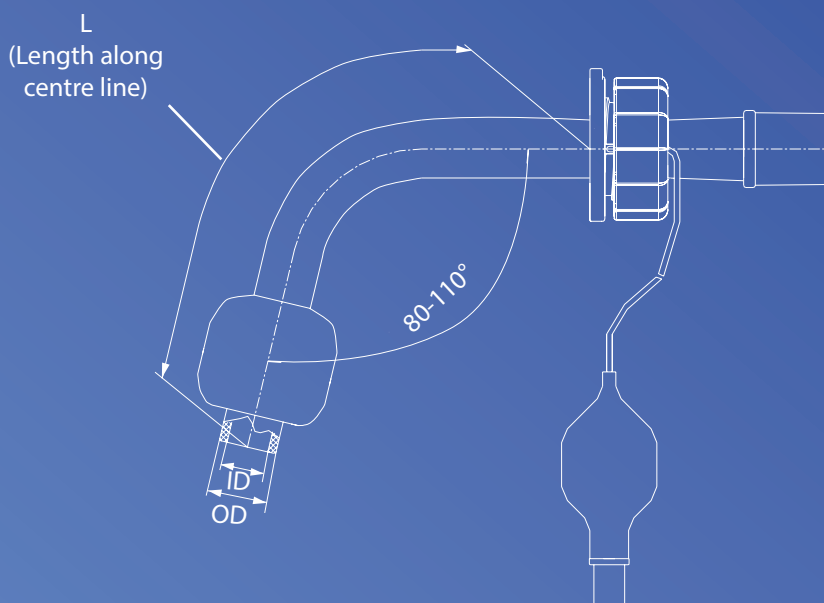

MEASUREMENTS FOR PRIFLEX® MRI:

Size	ID	OD	L Length along centre line adjustable to
6	6,0 mm	8,9 mm	70,0 mm
7	7,0 mm	9,9 mm	80,0 mm
8	8,0 mm	10,9 mm	100,0 mm
9	9,0 mm	11,9 mm	120,0 mm
10	10,0 mm	12,9 mm	130,0 mm
11	11,0 mm	13,9 mm	130,0 mm

ID = Inside diameter at the bottom of the tube

OD = Outside diameter at the bottom of the tube

L = Length along centre line of the tube from neck flange to bottom of the tube

PU = Packaging unit

TRACHEOSTOMY TUBES

Product features

- Metal-free tracheostomy tube with plastic spiral reinforcement, with 15 mm connector and individually adjustable neck flange
- Material: PVC, plastic spiral, latex-free, DEHP-free

Indication

- Tracheostomy/ Laryngectomy
- Obesity/ Oedema
- Suitable for radiation/ MRI



SIZE CHART:

Size	ID	OD	Length (adjustable to)	PU	Article number
6	6,0 mm	8,9 mm	70 mm	1 set	203802
7	7,0 mm	9,9 mm	80 mm	1 set	203804
8	8,0 mm	10,9 mm	100 mm	1 set	203805
9	9,0 mm	11,9 mm	120 mm	1 set	203806
10	10,0 mm	12,9 mm	130 mm	1 set	203807
11	11,0 mm	13,9 mm	130 mm	1 set	203808

INCLUDING:



NECK STRAP



OBTURATOR WITH SUCTION FUNCTION



OPTIONAL ACCESSORIES

TRACHEOSTOMY TUBES

Product features

- Metal-free tracheostomy tube with plastic spiral reinforcement, with 15 mm connector, low-pressure cuff and individually adjustable neck flange
- Material: PVC, plastic spiral, latex-free, DEHP-free

Indication

- Tracheostomy/ Laryngectomy
- Ventilation
- Obesity/ Oedema
- Suitable for radiation/ MRI



SIZE CHART:

Size	ID	OD	Length (adjustable to)	PU	Article number
6	6,0 mm	8,9 mm	70 mm	1 set	203824
7	7,0 mm	9,9 mm	80 mm	1 set	203814
8	8,0 mm	10,9 mm	100 mm	1 set	203815
9	9,0 mm	11,9 mm	120 mm	1 set	203816
10	10,0 mm	12,9 mm	130 mm	1 set	203817
11	11,0 mm	13,9 mm	130 mm	1 set	203818

INCLUDING:

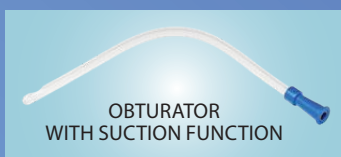
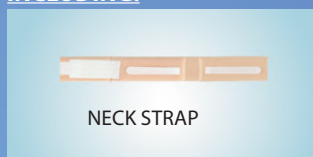



PRIMEDISTOM® tracheostomy tubes are designed for permanent wearers after tracheostomy and laryngectomy.

Their soft, flexible and extremely lightweight material guarantees maximum wearing comfort. **PRIMEDISTOM**® tracheostomy tubes are thermo-sensitive and reach their ideal properties at body temperature. Due to these material characteristics **PRIMEDISTOM**® tracheostomy tubes adapt very well to the shape of the trachea.

PRIMEDISTOM® tracheostomy tubes are offered in a wide range of different types and sizes to ensure that all individual patient's requirements are met.

Patient-optimized adaptation is available on request.

TRACHEOSTOMY TUBES

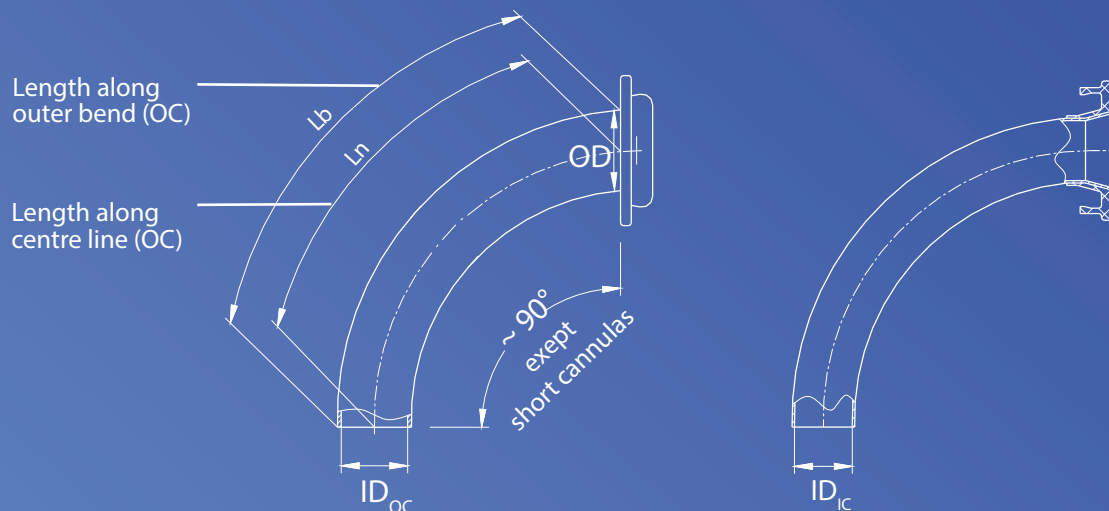

MEASUREMENTS FOR PRIMEDISTOM®:

Size	ID _{OC}	ID _{IC}	OD ₁	OD ₂	Ln Length along centre line (OC)		Lb Length along outer bend (OC)	
					standard version	long version	standard version	long version
4	4,4 mm	3,3 mm	7,2 mm	5,8 mm	50 mm		55 mm	
5	5,4 mm	4,3 mm	8,2 mm	6,8 mm	52 mm	87 mm	57 mm	92 mm
6	6,2 mm	4,9 mm	9,2 mm	7,8 mm	54 mm	88 mm	60 mm	95 mm
7	7,0 mm	5,8 mm	10,2 mm	9,0 mm	57 mm	93 mm	65 mm	100 mm
8	8,0 mm	6,8 mm	11,2 mm	10,0 mm	61 mm	97 mm	70 mm	105 mm
9	9,0 mm	7,8 mm	12,2 mm	11,0 mm	65 mm	101 mm	75 mm	110 mm
10	10,0 mm	8,8 mm	13,2 mm	12,0 mm	74 mm	105 mm	85 mm	115 mm
11	11,0 mm	9,8 mm	14,2 mm	13,0 mm	76 mm	109 mm	87 mm	120 mm
12	12,0 mm	10,8 mm	15,2 mm	14,0 mm	78 mm	113 mm	90 mm	125 mm
13	13,0 mm	11,2 mm	16,2 mm	15,5 mm	88 mm	118 mm	100 mm	130 mm

ID_{OC} = Inside diameter (clear width) at bottom of outer cannula

ID_{IC} = Inside diameter at bottom of inner cannula

OD₁ = Outside diameter of outer cannula behind the flange

OD₂ = Outside diameter of outer cannula at the bottom of the tube

IC = Inner cannula

OC = Outer cannula

Ln = Length along centre line of the outer cannula from neck flange to bottom of the tube

Lb = Length along outer bend of the outer cannula from neck flange to bottom of the tube

PU = Packaging unit



EASY-CLICK

A fixing ring is attached to the inner cannula which is connected through engaging with the outer cannula. Furthermore, the inner cannula can be removed again with ease (pull forwards-downwards without rotation!)

TRACHEOSTOMY TUBES

Product features

- Outer cannula with integrated X-ray contrast line for position control
- 1 inner cannula with 15 mm connector
- Secure fixing of inner cannula to outer cannula with Easy-Click-System (see p. 92)
- Conical form facilitates insertion
- Material: PVC, latex-free, DEHP-free, thermo-sensitive

Indication

- Tracheostomy/ Laryngectomy
- Suitable for radiation/ MRI
- Tracheal stenoses/ Granuloma (for long version)



LONG VERSION

SIZE CHART: :

Size	ID _{OC}	ID _{IC}	OD ₁	Length		PU	Article number
				Ln	Lb		
5	5,4 mm	4,3 mm	8,2 mm	52 mm	57 mm	1 set	201112
6	6,2 mm	4,9 mm	9,2 mm	54 mm	60 mm	1 set	201113
7	7,0 mm	5,8 mm	10,2 mm	57 mm	65 mm	1 set	201114
8	8,0 mm	6,8 mm	11,2 mm	61 mm	70 mm	1 set	201115
9	9,0 mm	7,8 mm	12,2 mm	65 mm	75 mm	1 set	201116
10	10,0 mm	8,8 mm	13,2 mm	74 mm	85 mm	1 set	201117
11	11,0 mm	9,8 mm	14,2 mm	76 mm	87 mm	1 set	201118
12	12,0 mm	10,8 mm	15,2 mm	78 mm	90 mm	1 set	201119
13	13,0 mm	11,2 mm	16,2 mm	88 mm	100 mm	1 set	201120

LONG VERSION			
Length Ln	Length Lb	PU	Article number
88 mm	95 mm	1 set	201124
93 mm	100 mm	1 set	201125
97 mm	105 mm	1 set	201126
101 mm	110 mm	1 set	201127
105 mm	115 mm	1 set	201128
109 mm	120 mm	1 set	201129
113 mm	125 mm	1 set	201130
118 mm	130 mm	1 set	201131

INCLUDING:



OPTIONAL ACCESSORIES

TRACHEOSTOMY TUBES CUFFLESS

Product features

- Outer cannula with integrated X-ray contrast line for position control
- With inner cannula system
- 1 inner cannula with 15 mm connector
- 1 inner cannula with 22 mm connector
- Secure fixing of inner cannula to outer cannula with Easy-Click-System (see p. 92)
- Conical form facilitates insertion
- Material: PVC, latex-free, DEHP-free, thermo-sensitive

Indication

- Tracheostomy/ Laryngectomy
- Suitable for radiation/ MRI
- Tracheal stenoses/ Granuloma (for long version)



LONG VERSION

SIZE CHART:

Size	ID _{OC}	ID _{IC}	OD ₁	Length		PU	Article number
				Ln	Lb		
5	5,4 mm	4,3 mm	8,2 mm	52 mm	57 mm	1 set	201212
6	6,2 mm	4,9 mm	9,2 mm	54 mm	60 mm	1 set	201213
7	7,0 mm	5,8 mm	10,2 mm	57 mm	65 mm	1 set	201214
8	8,0 mm	6,8 mm	11,2 mm	61 mm	70 mm	1 set	201215
9	9,0 mm	7,8 mm	12,2 mm	65 mm	75 mm	1 set	201216
10	10,0 mm	8,8 mm	13,2 mm	74 mm	85 mm	1 set	201217
11	11,0 mm	9,8 mm	14,2 mm	76 mm	87 mm	1 set	201218
12	12,0 mm	10,8 mm	15,2 mm	78 mm	90 mm	1 set	201219
13	13,0 mm	11,2 mm	16,2 mm	88 mm	100 mm	1 set	201220

LONG VERSION			
Length Ln	Length Lb	PU	Article number
88 mm	95 mm	1 set	201274
93 mm	100 mm	1 set	201275
97 mm	105 mm	1 set	201276
101 mm	110 mm	1 set	201277
105 mm	115 mm	1 set	201278
109 mm	120 mm	1 set	201279
113 mm	125 mm	1 set	201280
118 mm	130 mm	1 set	201281

INCLUDING:



OPTIONAL ACCESSORIES

TRACHEOSTOMY TUBES CUFFLESS

Product features

- Sieved outer cannula with integrated X-ray contrast line for position control
- With inner cannula system
- 1 fenestrated inner cannula with silver speaking valve enables phonation
- 1 inner cannula with 15 mm connector
- Secure fixing of inner cannula to outer cannula with Easy-Click-System (see p. 92)
- Conical form facilitates insertion
- Material: PVC, sterling silver (925), latex-free, DEHP-free, thermo-sensitive

Indication

- Tracheostomy
- Phonation
- Tracheal stenoses/ Granuloma (for long version)



LONG VERSION

SIZE CHART:

Size	ID _{OC}	ID _{IC}	OD ₁	Length		PU	Article number
				Ln	Lb		
4	4,4 mm	3,3 mm	7,2 mm	50 mm	55 mm	1 set	200301
5	5,4 mm	4,3 mm	8,2 mm	52 mm	57 mm	1 set	200302
6	6,2 mm	4,9 mm	9,2 mm	54 mm	60 mm	1 set	200303
7	7,0 mm	5,8 mm	10,2 mm	57 mm	65 mm	1 set	200304
8	8,0 mm	6,8 mm	11,2 mm	61 mm	70 mm	1 set	200305
9	9,0 mm	7,8 mm	12,2 mm	65 mm	75 mm	1 set	200306
10	10,0 mm	8,8 mm	13,2 mm	74 mm	85 mm	1 set	200307
11	11,0 mm	9,8 mm	14,2 mm	76 mm	87 mm	1 set	200308
12	12,0 mm	10,8 mm	15,2 mm	78 mm	90 mm	1 set	200309
13	13,0 mm	11,2 mm	16,2 mm	88 mm	100 mm	1 set	200310

LONG VERSION			
Length Ln	Length Lb	PU	Article number
88 mm	95 mm	1 set	200323
93 mm	100 mm	1 set	200324
97 mm	105 mm	1 set	200325
101 mm	110 mm	1 set	200326
105 mm	115 mm	1 set	200327
109 mm	120 mm	1 set	200328
113 mm	125 mm	1 set	200329
118 mm	130 mm	1 set	200330

INCLUDING:



OPTIONAL ACCESSORIES

TRACHEOSTOMY TUBES CUFFLESS

Product features

- Sieved outer cannula with integrated X-ray contrast line for position control
- With inner cannula system
- 1 fenestrated inner cannula with 15 mm connector enables phonation in conjunction with a speaking valve
- 1 inner cannula with 15 mm connector
- Secure fixing of inner cannula to outer cannula with Easy-Click-System (see p. 92)
- Conical form facilitates insertion
- Material: PVC, latex-free, DEHP-free, thermo-sensitive



Indication

- Tracheostomy
- Phonation
- Suitable for radiation/ MRI

SIZE CHART:

Size	ID _{OC}	ID _{IC}	OD ₁	Length		PU	Article number
				Ln	Lb		
5	5,4 mm	4,3 mm	8,2 mm	52 mm	57 mm	1 set	201372
6	6,2 mm	4,9 mm	9,2 mm	54 mm	60 mm	1 set	201373
7	7,0 mm	5,8 mm	10,2 mm	57 mm	65 mm	1 set	201374
8	8,0 mm	6,8 mm	11,2 mm	61 mm	70 mm	1 set	201375
9	9,0 mm	7,8 mm	12,2 mm	65 mm	75 mm	1 set	201376
10	10,0 mm	8,8 mm	13,2 mm	74 mm	85 mm	1 set	201377
11	11,0 mm	9,8 mm	14,2 mm	76 mm	87 mm	1 set	201378
12	12,0 mm	10,8 mm	15,2 mm	78 mm	90 mm	1 set	201379
13	13,0 mm	11,2 mm	16,2 mm	88 mm	100 mm	1 set	201380

INCLUDING:



REPLACEMENT INNER CANNULAS

Unfenestrated replacement inner cannulas for PRIMEDISTOM® tracheostomy tube in standard length

(A)



(B)



(C)



SIZE CHART:

Size	Suitable for Primedistom® outer cannula with Length Lb	PU	Inner cannula unfenestrated, without connector (A) Article number	Inner cannula unfenestrated, with 15 mm connector (B) Article number	Inner cannula unfenestrated, with 22 mm connector (C) Article number
5	57 mm	1 piece	201402	201432	201462
6	60 mm	1 piece	201403	201433	201463
7	65 mm	1 piece	201404	201434	201464
8	70 mm	1 piece	201405	201435	201465
9	75 mm	1 piece	201406	201436	201466
10	85 mm	1 piece	201407	201437	201467
11	87 mm	1 piece	201408	201438	201468
12	90 mm	1 piece	201409	201439	201469
13	100 mm	1 piece	201410	201440	201470

REPLACEMENT INNER CANNULAS

Fenestrated replacement inner cannulas for PRIMEDISTOM® tracheostomy tube in standard length

(A)



(B)



(C)



SIZE CHART:

Size	Suitable for Primedistom® outer cannula with Length Lb	PU	Inner cannula fenestrated, without connector (A) Article number	Inner cannula fenestrated, with 15 mm connector (B) Article number	Inner cannula fenestrated, with 22 mm connector (C) Article number
5	57 mm	1 piece	201413	201443	201473
6	60 mm	1 piece	201414	201444	201474
7	65 mm	1 piece	201415	201445	201475
8	70 mm	1 piece	201416	201446	201476
9	75 mm	1 piece	201417	201447	201477
10	85 mm	1 piece	201418	201448	201478
11	87 mm	1 piece	201419	201449	201479
12	90 mm	1 piece	201420	201450	201480
13	100 mm	1 piece	201421	201451	201481



TRACHEOSTOMY TUBES

SILVER tracheostomy tubes are HAND-MADE in GERMANY from high-grade sterling silver (925) of medical quality.

Due to their conical and seamless tube form these tracheostomy tubes enable easy insertion and avoid irritations to the tracheal wall.

The material of these tubes has an anti-bacterial impact and their smooth surface is easy to clean. The flange of these cannulas features two lateral eyelets to fix the inserted tracheostomy tube with a neck strap.

The extremely thin walls of these tracheostomy tubes provide a maximum lumen and therefore a large capacity for ventilation, even in small-sized cannulas. The material properties allow the increment of the inner diameter without changing the outer diameter. More air can enter and pass through the cannula. This increased inner volume makes silver cannulas superior to thicker medical-grade polymer cannulas in their intake capacity.

In addition, **SILVER** tracheostomy tubes are characterized by their high durability which allows a longer duration of use. Therefore they are often considered as economical long-term tubes.

This type of tracheostomy tube is always presented in sets with the inner cannula and outer cannula fitting together perfectly. This guarantees safe removal of the inner cannula for cleaning purposes or in case of shortness of breath.

The inner cannula can be fixed or released by moving a small silver lever on the outer cannula.

Patient-optimized adaptation is available on request.

TRACHEOSTOMY TUBES

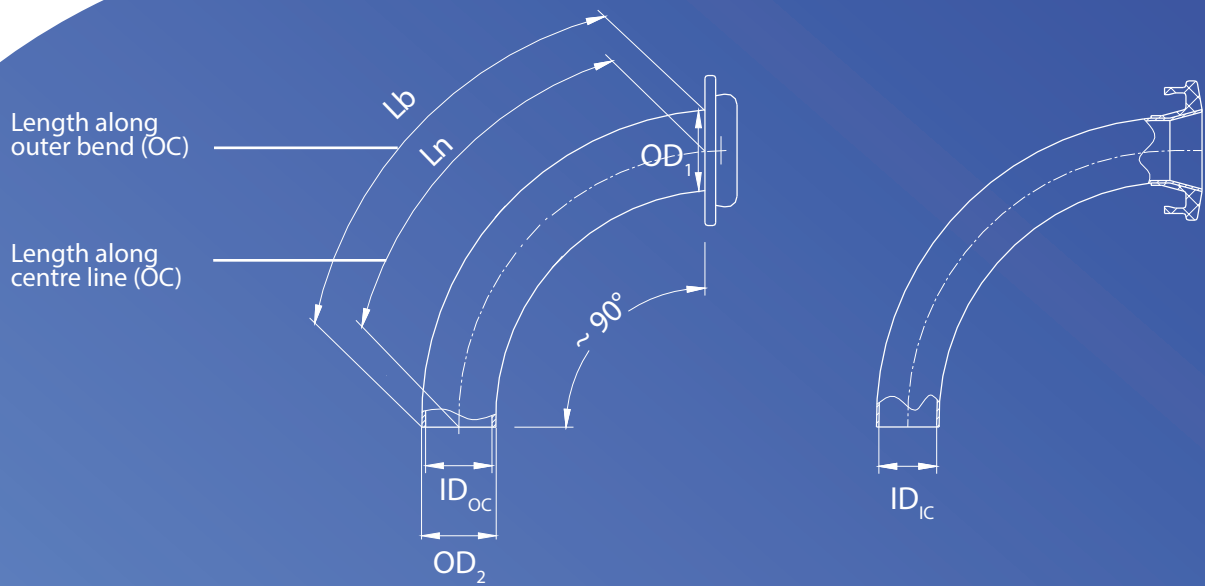

MEASUREMENTS FOR SILVER CANNULAS:

Size	ID _{OC}	ID _{IC}	OD ₁	OD ₂	Ln Length along centre line (OC)	Lb Length along outer bend (OC)
6	6,8 mm	5,9 mm	9,8 mm	8,4 mm	55 mm	60 mm
7	7,5 mm	6,5 mm	10,9 mm	9,0 mm	60 mm	65 mm
8	7,8 mm	7,0 mm	11,6 mm	9,7 mm	66 mm	70 mm
9	8,5 mm	7,6 mm	12,3 mm	10,4 mm	65 mm	75 mm
10	9,0 mm	8,4 mm	13,2 mm	11,0 mm	74 mm	80 mm
11	9,8 mm	9,0 mm	13,8 mm	11,7 mm	84 mm	90 mm
12	10,4 mm	9,6 mm	14,6 mm	12,4 mm	83 mm	90 mm
13	11,4 mm	10,5 mm	15,0 mm	13,0 mm	83 mm	90 mm
14	11,8 mm	10,7 mm	15,8 mm	13,7 mm	83 mm	90 mm

ID_{OC} = Inside diameter (clear width) at bottom of outer cannula

ID_{IC} = Inside diameter at bottom of inner cannula

OD₁ = Outside diameter of outer cannula behind the flange

OD₂ = Outside diameter of outer cannula at the bottom of the tube

IC = Inner cannula

OC = Outer cannula

Ln = Length along centre line of the outer cannula from neck flange to bottom of the tube

Lb = Length along outer bend of the outer cannula from neck flange to bottom of the tube

PU = Packaging unit

TRACHEOSTOMY TUBES

Product features

- Outer cannula
- With inner cannula system
- 2 inner cannulas without connector
- Conical form facilitates insertion
- Large inner lumen
- Long duration of use due to high durability of silver material
- Material: sterling silver (925), antibacterial

Indication

- Tracheostomy/ Laryngectomy



SIZE CHART:

Size	ID _{OC}	ID _{IC}	OD ₁	Length		PU	Article number
				Ln	Lb		
6	6,8 mm	5,9 mm	9,8 mm	55 mm	60 mm	1 set	200856
7	7,5 mm	6,5 mm	10,9 mm	60 mm	65 mm	1 set	200857
8	7,8 mm	7,0 mm	11,6 mm	66 mm	70 mm	1 set	200858
9	8,5 mm	7,6 mm	12,3 mm	65 mm	75 mm	1 set	200859
10	9,0 mm	8,4 mm	13,2 mm	74 mm	80 mm	1 set	200860
11	9,8 mm	9,0 mm	13,8 mm	84 mm	90 mm	1 set	200861
12	10,4 mm	9,6 mm	14,6 mm	83 mm	90 mm	1 set	200862
13	11,4 mm	10,5 mm	15,0 mm	83 mm	90 mm	1 set	200863
14	11,8 mm	10,7 mm	15,8 mm	83 mm	90 mm	1 set	200864

INCLUDING:



TRACHEOSTOMY TUBES

Product features

- Outer cannula
- With inner cannula system
- 1 inner cannula without connector
- 1 inner cannula with 15 mm connector
- Conical form facilitates insertion
- Large inner lumen
- Long duration of use due to high durability of silver material
- Material: sterling silver (925), antibacterial

Indication

- Tracheostomy/ Laryngectomy



SIZE CHART:

Size	ID _{OC}	ID _{IC}	OD ₁	Length		PU	Article number
				Ln	Lb		
6	6,8 mm	5,9 mm	9,8 mm	55 mm	60 mm	1 set	200871
7	7,5 mm	6,5 mm	10,9 mm	60 mm	65 mm	1 set	200872
8	7,8 mm	7,0 mm	11,6 mm	66 mm	70 mm	1 set	200873
9	8,5 mm	7,6 mm	12,3 mm	65 mm	75 mm	1 set	200874
10	9,0 mm	8,4 mm	13,2 mm	74 mm	80 mm	1 set	200875
11	9,8 mm	9,0 mm	13,8 mm	84 mm	90 mm	1 set	200876
12	10,4 mm	9,6 mm	14,6 mm	83 mm	90 mm	1 set	200877

INCLUDING:



**OPTIONAL
ACCESSORIES**

TRACHEOSTOMY TUBES

Product features

- Outer cannula
- With inner cannula system
- 1 inner cannula without connector
- 1 inner cannula with 22 mm connector
- Conical form facilitates insertion
- Large inner lumen
- Long duration of use due to high durability of silver material
- Material: sterling silver (925), antibacterial

Indication

- Tracheostomy/ Laryngectomy



SIZE CHART:

Size	ID _{OC}	ID _{IC}	OD ₁	Length		PU	Article number
				Ln	Lb		
6	6,8 mm	5,9 mm	9,8 mm	55 mm	60 mm	1 set	200936
7	7,5 mm	6,5 mm	10,9 mm	60 mm	65 mm	1 set	200937
8	7,8 mm	7,0 mm	11,6 mm	66 mm	70 mm	1 set	200938
9	8,5 mm	7,6 mm	12,3 mm	65 mm	75 mm	1 set	200939
10	9,0 mm	8,4 mm	13,2 mm	74 mm	80 mm	1 set	200940
11	9,8 mm	9,0 mm	13,8 mm	84 mm	90 mm	1 set	200941
12	10,4 mm	9,6 mm	14,6 mm	83 mm	90 mm	1 set	200942
13	11,4 mm	10,5 mm	15,0 mm	83 mm	90 mm	1 set	200943

INCLUDING:



TRACHEOSTOMY TUBES

Product features

- Sieved outer cannula
- 1 fenestrated inner cannula with detachable silver speaking valve enables phonation (secured against falling off by a small silver chain)
- Conical form facilitates insertion
- Large inner lumen
- Long duration of use due to high durability of silver material
- Material: sterling silver (925), antibacterial

Indication

- Tracheostomy
- Phonation



SIZE CHART:

Size	ID _{OC}	ID _{IC}	OD ₁	Length		PU	Article number
				Ln	Lb		
6	6,8 mm	5,9 mm	9,8 mm	55 mm	60 mm	1 set	200916
7	7,5 mm	6,5 mm	10,9 mm	60 mm	65 mm	1 set	200917
8	7,8 mm	7,0 mm	11,6 mm	66 mm	70 mm	1 set	200918
9	8,5 mm	7,6 mm	12,3 mm	65 mm	75 mm	1 set	200919
10	9,0 mm	8,4 mm	13,2 mm	74 mm	80 mm	1 set	200920
11	9,8 mm	9,0 mm	13,8 mm	84 mm	90 mm	1 set	200921
12	10,4 mm	9,6 mm	14,6 mm	83 mm	90 mm	1 set	200922
13	11,4 mm	10,5 mm	15,0 mm	83 mm	90 mm	1 set	200923
14	11,8 mm	10,7 mm	15,8 mm	83 mm	90 mm	1 set	200924

INCLUDING:



NECK STRAP

TRACHEOSTOMY TUBES

Product features

- Sieved outer cannula
- With inner cannula system
- 1 fenestrated inner cannula with detachable silver speaking valve enables phonation (secured against falling off by a small silver chain)
- 1 inner cannula with 15 mm connector
- Conical form facilitates insertion
- Large inner lumen
- Long duration of use due to high durability of silver material
- Material: sterling silver (925), antibacterial

Indication

- Tracheostomy
- Phonation



SIZE CHART:

Size	ID _{OC}	ID _{IC}	OD ₁	Length Ln	Length Lb	PU	Article number
6	6,8 mm	5,9 mm	9,8 mm	55 mm	60 mm	1 set	200886
7	7,5 mm	6,5 mm	10,9 mm	60 mm	65 mm	1 set	200887
8	7,8 mm	7,0 mm	11,6 mm	66 mm	70 mm	1 set	200888
9	8,5 mm	7,6 mm	12,3 mm	65 mm	75 mm	1 set	200889
10	9,0 mm	8,4 mm	13,2 mm	74 mm	80 mm	1 set	200890
11	9,8 mm	9,0 mm	13,8 mm	84 mm	90 mm	1 set	200891
12	10,4 mm	9,6 mm	14,6 mm	83 mm	90 mm	1 set	200892
13	11,4 mm	10,5 mm	15,0 mm	83 mm	90 mm	1 set	200893

INCLUDING:



NECK STRAP



**OPTIONAL
ACCESSORIES**

TRACHEOSTOMY TUBES

Product features

- Sieved outer cannula
- With inner cannula system
- 1 fenestrated inner cannula with O₂-port and detachable silver speaking valve which enables phonation (secured against falling off by a small silver chain)
- 1 inner cannula with 15 mm connector
- Conical form facilitates insertion
- Large inner lumen
- Long duration of use due to high durability of silver material
- Material: sterling silver (925), antibacterial

Indication

- Tracheostomy
- Phonation
- Hypoxia



SIZE CHART:

Size	ID _{oc}	ID _{ic}	OD ₁	Length Ln	Length Lb	PU	Article number
6	6,8 mm	5,9 mm	9,8 mm	55 mm	60 mm	1 set	200901
7	7,5 mm	6,5 mm	10,9 mm	60 mm	65 mm	1 set	200902
8	7,8 mm	7,0 mm	11,6 mm	66 mm	70 mm	1 set	200903
9	8,5 mm	7,6 mm	12,3 mm	65 mm	75 mm	1 set	200904
10	9,0 mm	8,4 mm	13,2 mm	74 mm	80 mm	1 set	200905
11	9,8 mm	9,0 mm	13,8 mm	84 mm	90 mm	1 set	200906
12	10,4 mm	9,6 mm	14,6 mm	83 mm	90 mm	1 set	200907
13	11,4 mm	10,5 mm	15,0 mm	83 mm	90 mm	1 set	200908
14	11,8 mm	10,7 mm	15,8 mm	83 mm	90 mm	1 set	200909

INCLUDING:



TRACHEOSTOMY TUBES

Product features

- Sieved outer cannula
- With inner cannula system
- 1 inner cannula without connector
- 1 fenestrated inner cannula with 22 mm connector enables phonation in conjunction with a speaking valve
- Conical form facilitates insertion
- Large inner lumen
- Long duration of use due to high durability of silver material
- Material: sterling silver (925), antibacterial

Indication

- Tracheostomy
- Phonation



SIZE CHART:

Size	ID _{OC}	ID _{IC}	OD ₁	Length Ln	Length Lb	PU	Article number
6	6,8 mm	5,9 mm	9,8 mm	55 mm	60 mm	1 set	200836
7	7,5 mm	6,5 mm	10,9 mm	60 mm	65 mm	1 set	200837
8	7,8 mm	7,0 mm	11,6 mm	66 mm	70 mm	1 set	200838
9	8,5 mm	7,6 mm	12,3 mm	65 mm	75 mm	1 set	200839
10	9,0 mm	8,4 mm	13,2 mm	74 mm	80 mm	1 set	200840
11	9,8 mm	9,0 mm	13,8 mm	84 mm	90 mm	1 set	200841
12	10,4 mm	9,6 mm	14,6 mm	83 mm	90 mm	1 set	200842
13	11,4 mm	10,5 mm	15,0 mm	83 mm	90 mm	1 set	200843

INCLUDING:



NECK STRAP



**OPTIONAL
ACCESSORIES**

TRACHEOSTOMY TUBES

FOR NEONATES
AND CHILDREN



TRACHEOSTOMY TUBES

FOR NEONATES
AND CHILDREN

Our tracheostomy tubes for neonates and children are specially tailored to the requirements of little patients.

They are made of particularly soft, flexible DEHP-free material and formed atraumatically. Due to their thin-walled design they ensure high air supply, but at the same time retain their high stability of form.

The swivelling 15 mm connector of these tracheostomy tubes enables easy connection of ventilation circuits and minimizes the transmission of tensile and shear forces to the tube.



Swivelling 15 mm connector



The cuffed version have an ultra-thin Polyurethane (PU) cuff



Special recesses on the flange enable maximum flexibility



Different flange designs for neonatal and pediatric patients

TRACHEOSTOMY TUBES

FOR NEONATES
AND CHILDREN

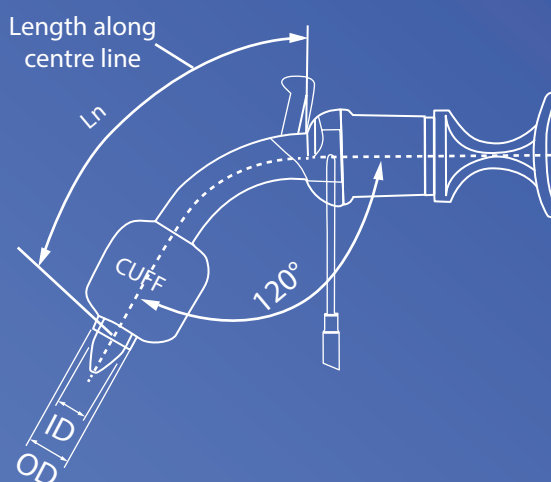

MEASUREMENTS FOR NEO, PED, PEDL, PEDC, PEDCL:

Size	ID	OD	Ln Length along centre line			
			NEO	PED	PEDC	PEDL, PEDCL
3.0	3,0 mm	4,5 mm	30 mm	39 mm		
3.5	3,5 mm	5,2 mm	32 mm	40 mm		
4.0	4,0 mm	5,9 mm	34 mm	41 mm	41 mm	
4.5	4,5 mm	6,5 mm	36 mm	42 mm	42 mm	
5.0	5,0 mm	7,1 mm		44 mm	44 mm	50 mm
5.5	5,5 mm	7,7 mm		46 mm	46 mm	52 mm
6.0	6,0 mm	8,3 mm				54 mm
6.5	6,5 mm	9,0 mm				56 mm

ID = Inside diameter at bottom of tube

OD = Outside diameter at bottom of tube

Ln = Length along centre line from neck flange to bottom of the tube

PU = Packaging unit

NEONATAL TRACHEOSTOMY TUBES WITHOUT CUFF

Product features

- Neonatal tracheostomy tube made of radio-paque material for position control, with swivelling 15 mm connector
- 1 Obturator for easy insertion
- Without inner cannula system in order to provide a large inner lumen
- Cylindrical form ensures greatest possible inner diameter
- For removal of the swivelling connector and disconnecting of accessories the included disconnecting wedge can be used
- Material: PVC, latex-free, DEHP-free, bisphenol A-free, thermo-sensitive

Indication

- Tracheostomy in neonates
- Suitable for radiation/ MRI depending on tumour localisation



NEO - NEONATAL TRACHEOSTOMY TUBES WITHOUT CUFF

SIZE CHART:

Size	ID	OD	Length along centre line	PU	Article number
3.0	3,0 mm	4,5 mm	30 mm	1 set	200041
3.5	3,5 mm	5,2 mm	32 mm	1 set	200042
4.0	4,0 mm	5,9 mm	34 mm	1 set	200043
4.5	4,5 mm	6,5 mm	36 mm	1 set	200044

INCLUDING:

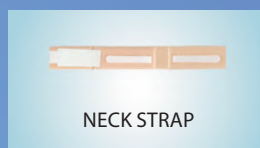

PEDIATRIC TRACHEOSTOMY TUBES WITHOUT CUFF

Product features

- Pediatric tracheostomy tube made of radiopaque material for position control, with swivelling 15 mm connector
- 1 Obturator for easy insertion
- Without inner cannula system in order to provide a large inner lumen
- Cylindrical form ensures greatest possible inner diameter
- For removal of the swivelling connector and disconnecting of accessories the included disconnecting wedge can be used
- Material: PVC, latex-free, DEHP-free, bisphenol A-free, thermo-sensitive



Indication

- Tracheostomy in children
- Suitable for radiation/ MRI depending on tumour localisation

PED - PEDIATRIC TRACHEOSTOMY TUBE WITHOUT CUFF

SIZE CHART:

Size	ID	OD	Length along centre line	PU	Article number
3.0	3,0 mm	4,5 mm	39 mm	1 set	200051
3.5	3,5 mm	5,2 mm	40 mm	1 set	200052
4.0	4,0 mm	5,9 mm	41 mm	1 set	200053
4.5	4,5 mm	6,5 mm	42 mm	1 set	200054
5.0	5,0 mm	7,1 mm	44 mm	1 set	200055
5.5	5,5 mm	7,7 mm	46 mm	1 set	200056

INCLUDING:

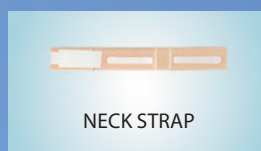

PEDIATRIC TRACHEOSTOMY TUBES WITHOUT CUFF LONG

Product features

- Long pediatric tracheostomy tube made of radio-paque material for position control, with swivelling 15 mm connector
- 1 Obturator for easy insertion
- Without inner cannula system in order to provide a large inner lumen
- Cylindrical form ensures greatest possible inner diameter
- For removal of the swivelling connector and disconnecting of accessories the included disconnecting wedge can be used
- Material: PVC, latex-free, DEHP-free, bisphenol A-free, thermo-sensitive

Indication

- Tracheostomy in children
- Suitable for radiation/ MRI depending on tumour localisation
- Tracheal stenoses/ Granuloma

SIZE CHART:

Size	ID	OD	Length along centre line	PU	Article number
5.0	5,0 mm	7,1 mm	50 mm	1 set	200065
5.5	5,5 mm	7,7 mm	52 mm	1 set	200066
6.0	6,0 mm	8,3 mm	54 mm	1 set	200067
6.5	6,5 mm	9,0 mm	56 mm	1 set	200068

INCLUDING:

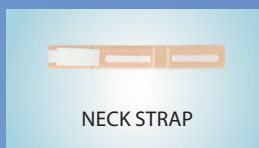

PEDL - PEDIATRIC TRACHEOSTOMY TUBE WITHOUT CUFF, LONG



PEDIATRIC TRACHEOSTOMY TUBES WITH CUFF

Product features

- Pediatric tracheostomy tube made of radiopaque material for position control, with particularly thin-walled low-pressure Polyurethan (PU) cuff and swivelling 15 mm connector
- 1 Obturator for easy insertion
- Without inner cannula system in order to provide a large inner lumen
- Cylindrical form ensures greatest possible inner diameter
- For removal of the swivelling connector and disconnecting of accessories the included disconnecting wedge can be used
- Material: PVC, PU, latex-free, DEHP-free, bisphenol A-free, thermo-sensitive

Indication

- Tracheostomy in children
- Ventilation
- To prevent aspiration



PEDC - PEDIATRIC TRACHEOSTOMY TUBE WITH CUFF

SIZE CHART:

Size	ID	OD	Length along centre line	PU	Article number
4.0	4,0 mm	5,9 mm	41 mm	1 set	200073
4.5	4,5 mm	6,5 mm	42 mm	1 set	200074
5.0	5,0 mm	7,1 mm	44 mm	1 set	200075
5.5	5,5 mm	7,7 mm	46 mm	1 set	200076

INCLUDING:



NECK STRAP

DISCONNECTING WEDGE



OPTIONAL ACCESSORIES

**PEDIATRIC
TRACHEOSTOMY TUBES
WITH CUFF
LONG**

Product features

- Long pediatric tracheostomy tube made of radio-paque material for position control, with particularly thin-walled low-pressure Polyurethan (PU) cuff and swivelling 15 mm connector
- 1 Obturator for easy insertion
- Without inner cannula system in order to provide a large inner lumen
- Cylindrical form ensures greatest possible inner diameter
- For removal of the swivelling connector and disconnecting of accessories the included disconnecting wedge can be used
- Material: PVC, PU, latex-free, DEHP-free, bisphenol A-free, thermo-sensitive

Indication

- Tracheostomy in children
- Ventilation
- To prevent aspiration
- Tracheal stenoses/ Granuloma



**PEDCL - PEDIATRIC
TRACHEOSTOMY TUBE WITH CUFF
LONG**

SIZE CHART:

Size	ID	OD	Length along centre line	PU	Article number
5.0	5,0 mm	7,1 mm	50 mm	1 set	200085
5.5	5,5 mm	7,7 mm	52 mm	1 set	200086
6.0	6,0 mm	8,3 mm	54 mm	1 set	200087
6.5	6,5 mm	9,0 mm	56 mm	1 set	200088

INCLUDING:



NECK STRAP

DISCONNECTING WEDGE



**OPTIONAL
ACCESSORIES**



LARYNGECTOMY TUBES

PRIMEDISILK® laryngectomy tubes are made of pure, medical-grade silicone. Due to high flexibility and the outstanding material properties of silicone, the tubes adjust well to the shape of the trachea and assure high wearing comfort.

An atraumatic rounded tip prevents irritation of the mucous membranes in the trachea and facilitates insertion.

PRIMEDISILK® tubes are recommended for laryngectomized patients whose tracheostoma still has to be stabilized, and for tracheostomized patients, who need a placeholder during the weaning process.

LARYNGECTOMY TUBES

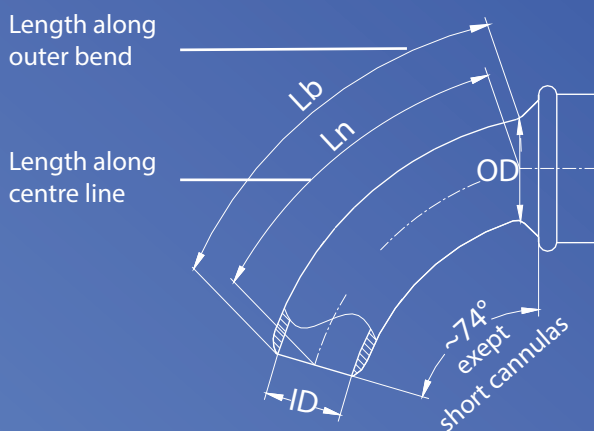

MEASUREMENTS FOR PRIMEDSILK®:

Size	ID	OD	Ln Length along centre line		Lb Length along outer bend	
			short version	standard version	short version	standard version
8	9,5 mm	12,0 mm	37,0 mm	54,0 mm	44,0 mm	62,0 mm
9	10,5 mm	13,5 mm	37,0 mm	54,0 mm	44,0 mm	62,0 mm
10	12,0 mm	15,0 mm	37,0 mm	54,0 mm	44,0 mm	62,0 mm
12	13,5 mm	17,0 mm	37,0 mm	54,0 mm	44,0 mm	62,0 mm

ID = Inside diameter (clear width) at bottom of cannula
 OD = Outside diameter of cannula behind the flange
 Ln = Length along centre line from neck flange to bottom of the tube
 Lb = Length along outer bend from neck flange to bottom of the tube

PU = Packaging unit

LARYNGECTOMY TUBES

Product features

- Low-profile laryngectomy tube without connector
- Prevents shrinkage of tissue
- High wearing comfort due to flexible and soft material
- Ensures good tissue compatibility
- Atraumatic rounded tip facilitates insertion
- Available in two lengths
- Material: silicone, latex-free

Indication

- Laryngectomy/ Tracheostomy
- Suitable for radiation/ MRI



PRIMEDISK®



SHORT VERSION

SIZE CHART:

Size	ID	OD	Length		PU	Article number	SHORT VERSION			
			Ln	Lb			Length Ln	Length Lb	PU	Article number
8	9,5 mm	12,0 mm	54 mm	62 mm	1 set	200614	37 mm	44 mm	1 set	200660
9	10,5 mm	13,5 mm	54 mm	62 mm	1 set	200615	37 mm	44 mm	1 set	200661
10	12,0 mm	15,0 mm	54 mm	62 mm	1 set	200616	37 mm	44 mm	1 set	200662
12	13,5 mm	17,0 mm	54 mm	62 mm	1 set	200617	37 mm	44 mm	1 set	200663

INCLUDING:



LARYNGECTOMY TUBES

Product features

- Laryngectomy tube with 22 mm connector
- Prevents shrinkage of tissue
- High wearing comfort due to flexible and soft material
- Ensures good tissue compatibility
- Atraumatic rounded tip facilitates insertion
- Available in two lengths
- Material: silicone, latex-free

Indication

- Laryngectomy/ Tracheostomy
- Suitable for radiation/ MRI



PRIMEDISILK-VENT®



SHORT VERSION

SIZE CHART:

Size	ID	OD	Length		PU	Article number	SHORT VERSION			
			Ln	Lb			Length Ln	Length Lb	PU	Article number
8	9,5 mm	12,0 mm	54 mm	62 mm	1 set	200628	37 mm	44 mm	1 set	200668
9	10,5 mm	13,5 mm	54 mm	62 mm	1 set	200629	37 mm	44 mm	1 set	200669
10	12,0 mm	15,0 mm	54 mm	62 mm	1 set	200630	37 mm	44 mm	1 set	200670
12	13,5 mm	17,0 mm	54 mm	62 mm	1 set	200631	37 mm	44 mm	1 set	200671

INCLUDING:



OPTIONAL ACCESSORIES

LARYNGECTOMY TUBES

Product features

- Sieved laryngectomy tube with 22 mm connector
- Sieving enables phonation (for laryngectomized patients with normal position of voice prosthesis)
- Prevents shrinkage of tissue
- High wearing comfort due to flexible and soft material
- Ensures good tissue compatibility
- Atraumatic rounded tip facilitates insertion
- Available in two lengths
- Material: silicone, latex-free

Indication

- Laryngectomized patients (with voice prosthesis)/
Tracheostomized patients with intact larynx
- Phonation
- Suitable for radiation/ MRI



PRIMEDISILK-VENT®



SHORT VERSION

SIZE CHART:

Size	ID	OD	Length		PU	Article number	SHORT VERSION			
			Ln	Lb			Length Ln	Lb	PU	Article number
8	9,5 mm	12,0 mm	54 mm	62 mm	1 set	200624	37 mm	44 mm	1 set	200664
9	10,5 mm	13,5 mm	54 mm	62 mm	1 set	200625	37 mm	44 mm	1 set	200665
10	12,0 mm	15,0 mm	54 mm	62 mm	1 set	200626	37 mm	44 mm	1 set	200666
12	13,5 mm	17,0 mm	54 mm	62 mm	1 set	200627	37 mm	44 mm	1 set	200667

INCLUDING:



LARYNGECTOMY TUBES

Product features

- Laryngectomy tube with 22 mm connector without flange
- To be used in conjunction with adhesive base-plates (PRIMEDISTRIP® stoma patches)
- Enables application without neck strap
- Prevents shrinkage of tissue
- High wearing comfort due to flexible and soft material
- Ensures good tissue compatibility
- Atraumatic rounded tip facilitates insertion
- Available in two lengths
- Material: silicone, latex-free

Indication

- Laryngectomy/ Tracheostomy
- Suitable for radiation/ MRI



PRIMEDISILK-CLIP®



SHORT VERSION

SIZE CHART:

Size	ID	OD	Length		PU	Article number	SHORT VERSION			
			Ln	Lb			Ln	Lb	PU	Article number
8	9,5 mm	12,0 mm	54 mm	62 mm	1 set	200684	37 mm	44 mm	1 set	200692
9	10,5 mm	13,5 mm	54 mm	62 mm	1 set	200685	37 mm	44 mm	1 set	200693
10	12,0 mm	15,0 mm	54 mm	62 mm	1 set	200686	37 mm	44 mm	1 set	200694
12	13,5 mm	17,0 mm	54 mm	62 mm	1 set	200687	37 mm	44 mm	1 set	200695

INCLUDING:



OPTIONAL ACCESSORIES

LARYNGECTOMY TUBES

Product features

- Sieved laryngectomy tube with 22 mm connector without flange
- Sieving enables phonation (for laryngectomized patients with normal position of voice prosthesis)
- To be used in conjunction with adhesive base-plates (PRIMEDISTRIP® stoma patches)
- Enables application without neck strap and an improved sealing of the tracheostoma during phonation
- Prevents shrinkage of tissue
- High wearing comfort due to flexible and soft material
- Ensures good tissue compatibility
- Atraumatic rounded tip facilitates insertion
- Available in two lengths
- Material: silicone, latex-free

Indication

- Laryngectomized patients (with voice prosthesis)/ Tracheostomized patients with intact larynx
- Phonation
- Suitable for radiation/ MRI



**PRIMEDISILK-CLIP®
WITH SIEVING**



SHORT VERSION

SIZE CHART:

Size	ID	OD	Length		PU	Article number	SHORT VERSION			
			Ln	Lb			Length Ln	Length Lb	PU	Article number
8	9,5 mm	12,0 mm	54 mm	62 mm	1 set	200680	37 mm	44 mm	1 set	200688
9	10,5 mm	13,5 mm	54 mm	62 mm	1 set	200681	37 mm	44 mm	1 set	200689
10	12,0 mm	15,0 mm	54 mm	62 mm	1 set	200682	37 mm	44 mm	1 set	200690
12	13,5 mm	17,0 mm	54 mm	62 mm	1 set	200683	37 mm	44 mm	1 set	200691

INCLUDING:



**OPTIONAL
ACCESSORIES**

TRACHEOSTOMY PLACEHOLDERS

PRIMEDISK® tracheostomy placeholders provide a secondary airway by gently holding the tracheostoma open. They provide access during a bronchial toilet and are used for decannulation.

Made of soft, medical-grade silicone they ensure a very high wearing comfort and good tissue compatibility.

We offer different types of **PRIMEDISK®** tracheostomy placeholders which should be selected according to the individual anatomical features of each patient:

TRACHEO-SAFE T-TUBUS STOMA-BUTTON

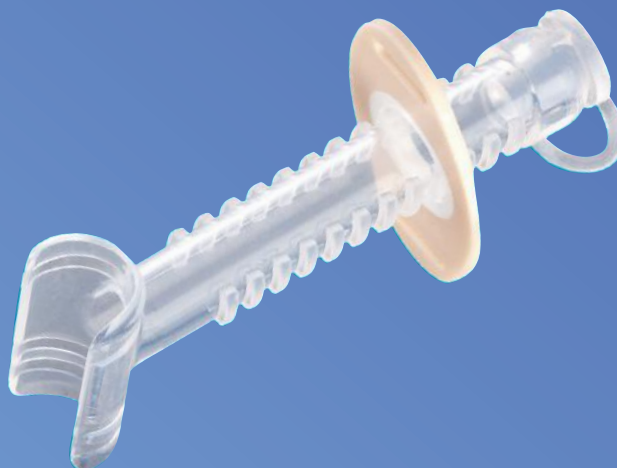

PU = Packaging unit
ID = Inside diameter
OD = Outside diameter

Product features

- Tracheostomy placeholder following a decannulation and prior to a tracheostomy seal
- The extended semitubular form of the tracheal shank ideally adapts to the shape of the trachea
- Variably adjustable skin-colored flange ensures secure positioning in the trachea
- Optional closure plug enables respiration via the upper respiratory tract (can be opened with ease at any time for suctioning of secretion)
- Prevents shrinkage of tissue
- Enables patient to cough up the stimulus secretion very fast
- Provides an artificial airway and access for pulmonary hygiene
- High wearing comfort due to flexible and soft material
- Ensures good tissue compatibility
- Material: silicone, latex-free

Indication

- Tracheostomy
- Patients with stable breathing who primarily breath through the upper airways
- Weaning
- Suitable for radiation/ MRI

SIZE CHART:

	Length	ID	OD	PU	Article number
A	45 mm	8 mm	14,0 mm	1 piece	20895
B	70 mm	8 mm	13,8 mm	1 piece	20898



TRACHEO-SAFE



T-TUBUS

Product features

- Tracheostomy placeholder for the stabilization of the trachea
- Maintains an adequate airway from larynx to mouth and nose
- Height-adjustable distancing ring ensures optimum fit and protects against dislocation
- Can be closed off, if necessary, with the sealing plug (removing the plug allows suction of tracheal secretions)
- Atraumatically shaped ends ensure easy insertion
- High wearing comfort due to flexible and soft material
- Ensures good tissue compatibility
- Material: silicone, latex-free

Indication

- Tracheostomy
- Tracheal and subglottic stenoses and related reconstructive measures
- Tracheomalacia/ unstable trachea
- Suitable for radiation/ MRI

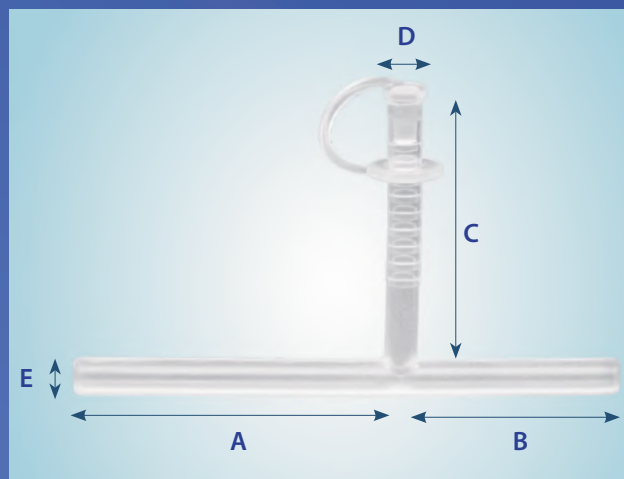

T-TUBUS

SIZE CHART:

Size	A	B	C	D (OD)	E (OD)	PU	Article number
8	63 mm	49 mm	45 mm	6,5 mm	8 mm	1 piece	200640
9	75 mm	50 mm	63 mm	8 mm	9 mm	1 piece	200641
10	75 mm	50 mm	63 mm	8 mm	10 mm	1 piece	200642
11	75 mm	50 mm	63 mm	9 mm	11 mm	1 piece	200643
12	75 mm	75 mm	48 mm	11 mm	12 mm	1 piece	200644
13	100 mm	50 mm	63 mm	11 mm	13 mm	1 piece	200645
14	100 mm	50 mm	63 mm	11 mm	14 mm	1 piece	200646

Product features

- Tracheostomy placeholder for the stabilization of the tracheostoma
- Flat unobtrusive design with ring-shaped shield
- Integrated bulge at the proximal end ensures that it is held securely in the trachea
- Prevents shrinkage of tissue
- Short, atraumatic form can be introduced with ease and reduces the associated risk of injury
- High wearing comfort due to flexible and soft material
- Ensures good tissue compatibility
- Can be closed with a finger to enable phonation
- Material: silicone, latex-free



**STOMA BUTTON
TYPE I**

Indication

- Laryngectomized patients (with voice prosthesis)/ Tracheostomized patients with intact larynx
- Weaning
- Suitable for radiation/ MRI

SIZE CHART:

Size	ID	OD	Length	PU	Article number
6	8,0 mm	9,5 mm	12,5 mm	1 piece	200602
8	9,5 mm	12,0 mm	13,5 mm	1 piece	200603
9	10,5 mm	13,5 mm	14,5 mm	1 piece	200604
10	12,0 mm	15,0 mm	15,5 mm	1 piece	200605
10 (short)	12,0 mm	15,0 mm	6,5 mm	1 piece	200606
12	13,5 mm	17,0 mm	14,5 mm	1 piece	200607

Product features

- Tracheostomy placeholder for the stabilization of the tracheostoma
- The shield is a funnel-shaped ring which ensures effective sealing against the tracheostoma
- Integrated bulge at the proximal end ensures that it is held securely in the trachea
- Available with and without eyelets (for additional fixation with a neck strap)
- Prevents shrinkage of tissue
- Short, atraumatic form can be introduced with ease and reduces the associated risk of injury
- High wearing comfort due to flexible and soft material
- Ensures good tissue compatibility
- Can be closed with a finger to enable phonation
- Available in two lengths
- Material: silicone, latex-free

Indication

- Laryngectomized patients (with voice prosthesis)/ Tracheostomized patients with intact larynx
- Weaning
- Suitable for radiation/ MRI



**STOMA BUTTON
TYPE II**



SIZE CHART:

Size	ID	OD	Length	PU	WITHOUT EYELETS (A)		WITH EYELETS (B)	
					Article number	Article number	Article number	Article number
8	8,0 mm	11,0 mm	15,0 mm	1 piece	200555	200545		
			22,0 mm	1 piece	200550	200540		
9	9,0 mm	12,0 mm	15,0 mm	1 piece	200556	200546		
			22,0 mm	1 piece	200551	200541		
10	10,0 mm	13,0 mm	15,0 mm	1 piece	200557	200547		
			22,0 mm	1 piece	200552	200542		
11	11,0 mm	14,0 mm	15,0 mm	1 piece	200558	200548		
			22,0 mm	1 piece	200553	200543		
12	12,0 mm	15,0 mm	15,0 mm	1 piece	200559	200549		
			22,0 mm	1 piece	200554	200544		

Product features

- Tracheostomy placeholder for the stabilization of the tracheostoma
- The shield is a funnel-shaped housing which ensures effective sealing against the tracheostoma and features an integrated 22 mm connector
- Integrated bulge at the proximal end ensures that it is held securely in the trachea
- Available with and without eyelets (for additional fixation with a neck strap)
- Prevents shrinkage of tissue
- Short, atraumatic form can be introduced with ease and reduces the associated risk of injury
- High wearing comfort due to flexible and soft material
- Ensures good tissue compatibility
- In order to enable phonation it can either be closed with a finger or a speaking valve can be attached
- Available in two lengths
- Material: silicone, latex-free

Indication

- Laryngectomized patients (with voice prosthesis)/ Tracheostomized patients with intact larynx
- Weaning
- Suitable for radiation/ MRI



**STOMA BUTTON
TYPE III**



SIZE CHART:

Size	ID	OD	Length	PU	WITHOUT EYELETS (A)	WITH EYELETS (B)
					Article number	Article number
8	8,0 mm	11,0 mm	15,0 mm	1 piece	200575	200565
			22,0 mm	1 piece	200570	200560
9	9,0 mm	12,0 mm	15,0 mm	1 piece	200576	200566
			22,0 mm	1 piece	200571	200561
10	10,0 mm	13,0 mm	15,0 mm	1 piece	200577	200567
			22,0 mm	1 piece	200572	200562
11	11,0 mm	14,0 mm	15,0 mm	1 piece	200578	200568
			22,0 mm	1 piece	200573	200563
12	12,0 mm	15,0 mm	15,0 mm	1 piece	200579	200569
			22,0 mm	1 piece	200574	200564



**OPTIONAL
ACCESSORIES**

PRIMEDISTRIP® is a retaining ring in combination with a self-adhesive patch as a carrier plate.

PRIMEDISTRIP® is suitable for patients with a tracheostoma who, although no longer needing a tracheostomy tube, still require aids such as heat and moisture exchangers (HME) or speaking valves.

It can be secured easily and rapidly, thanks to the skin-friendly adhesive surface. It provides secure protection against the escape of secretion and air. Irritation of the skin is avoided and an optimum seal achieved as a result.

The retaining ring of a **PRIMEDISTRIP®** has an inner diameter of 22 mm and enables attachment of speaking valves (e.g. PRIMEDI RESISTANCE VALVE and PRIMEDI LOW-RESISTANCE VALVE) or heat and moisture exchangers (e.g. PRIMEDIAIR® KAS or PRIMEDIAIR® PHON).

PRIMEDISTRIP® tracheostoma patches can be selected in different variants (Basic, Basic Plus, Comfort, Comfort Plus, Sensitive) to suit the individual requirements of each patient. These are available in different shapes (oval, round), materials and adhesive strengths.



Product features

- Self-adhesive tracheostoma patch with a 22 mm retaining ring for sealing the tracheostoma
- Enables attachment of heat and moisture exchangers or speaking vales
- Transparent
- Easy to remove
- Available in round and oval shape
- Average utilization period: 24 hours

Indication

- Tracheostomy/ Laryngectomy
- Suitable for patients with a normal stoma and normal skin

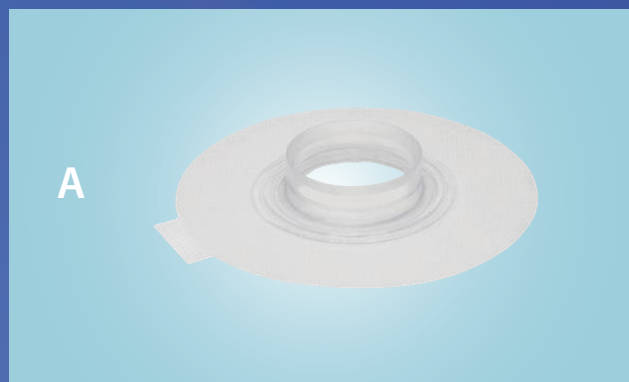

BASIC

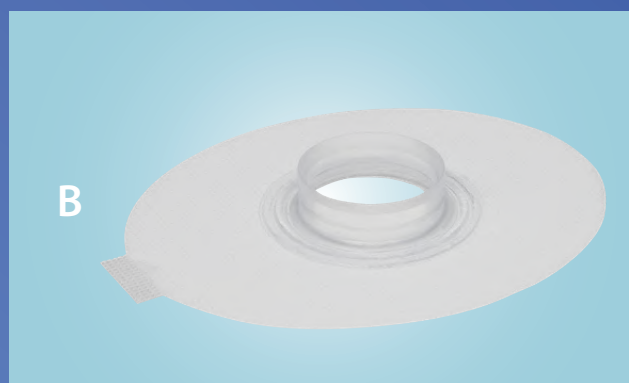

	PU	Shape	Article number
A	15 pieces	round	200360
B	15 pieces	oval	200362



OPTIONAL ACCESSORIES

Product features

- Self-adhesive tracheostoma patch with a 22 mm retaining ring for sealing the tracheostoma
- Enables attachment of heat and moisture exchangers or speaking vales
- Transparent
- Highly flexible
- Very strong adhesive properties
- Available in round and oval shape
- Average utilization period: 48 hours

Indication

- Tracheostomy/ Laryngectomy
- Suitable for patients with an irregular or deep stoma

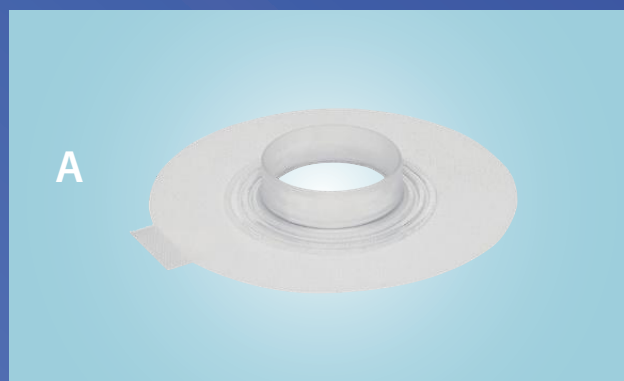

BASIC PLUS

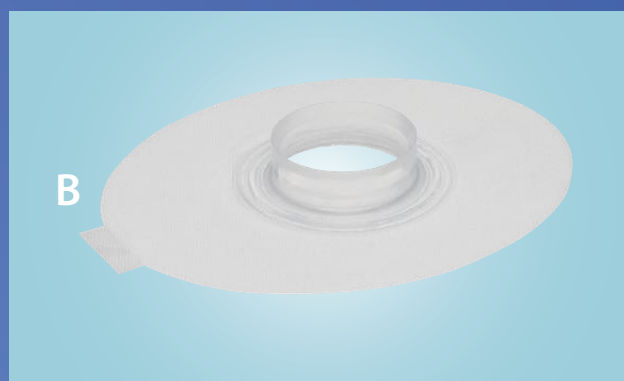

	PU	Shape	Article number
A	15 pieces	round	200364
B	15 pieces	oval	200365



OPTIONAL ACCESSORIES

Product features

- Self-adhesive tracheostoma patch with a 22 mm retaining ring for sealing the tracheostoma
- Enables attachment of heat and moisture exchangers or speaking vales
- Skin-friendly hydrocolloid material absorbs moisture, thereby ensuring high wearing comfort
- Skin-colored
- Combines high flexibility with strong adhesive properties
- Available in round and oval shape
- Average utilization period: 36 hours

Indication

- Tracheostomy/ Laryngectomy
- Suitable for patients with normal and sensitive skin



COMFORT



	PU	Shape	Article number
A	15 pieces	round	200361
B	15 pieces	oval	200363



OPTIONAL ACCESSORIES

Product features

- Self-adhesive tracheostoma patch with a 22 mm retaining ring for sealing the tracheostoma
- Enables attachment of heat and moisture exchangers or speaking vales
- Soft texture ensures high wearing comfort
- Skin-colored
- Highly flexible
- Strong adhesive properties
- Available in round and oval shape
- Average utilization period: 48 hours

Indication

- Tracheostomy/ Laryngectomy
- Suitable for patients with normal and sensitive skin

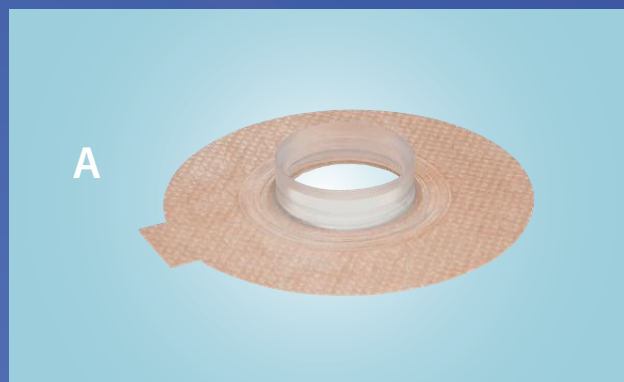

COMFORT PLUS

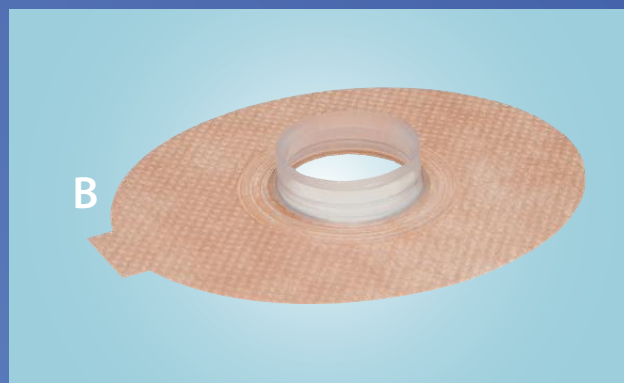

	PU	Shape	Article number
A	15 pieces	round	200366
B	15 pieces	oval	200367



OPTIONAL ACCESSORIES

Product features

- Self-adhesive tracheostoma patch with a 22 mm retaining ring for sealing the tracheostoma
- Enables attachment of heat and moisture exchangers or speaking vales
- Made of special hypoallergenic material that avoids skin irritations and ensures high wearing comfort
- White
- Highly flexible
- Available in round and oval shape
- Average utilization period: 48 hours

Indication

- Tracheostomy/ Laryngectomy
- Suitable for patients with normal and highly sensitive skin

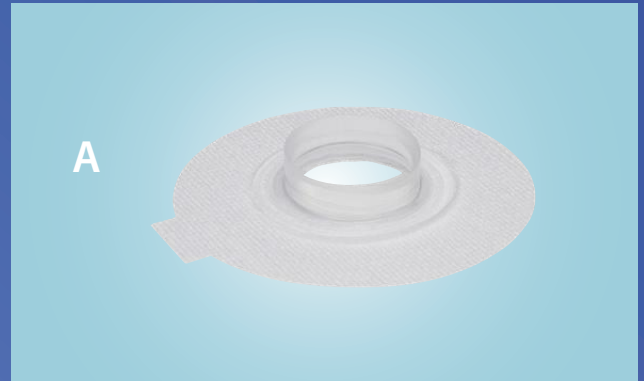

SENSITIVE

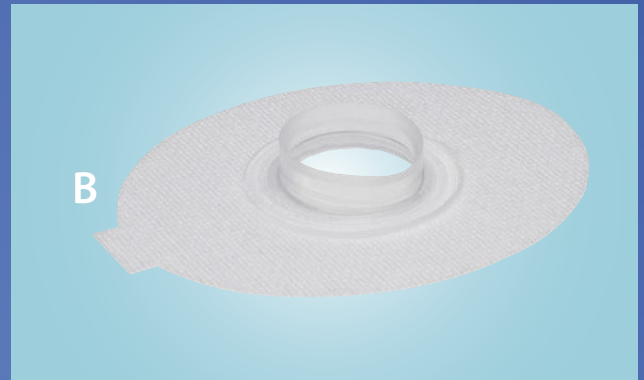

	PU	Shape	Article number
A	15 pieces	round	200369
B	15 pieces	oval	200370



OPTIONAL ACCESSORIES

Product features

- Sealing patch of skin-coloured, biocompatible silicone used for sealing and padding between the tracheostoma and a tracheostomy tube
- Skin-friendly adhesive material enables rapid fixing without adhesives
- Highly flexible
- Natural adaptation to the musculature and tissue allows for a new quality of freedom of movement
- Due to its plano-convex shape the patch even adapts to irregular tracheostomata and seals these effectively
- Improves phonation through the high degree of sealing (making it also suitable for laryngectomized patients with voice prostheses)
- Stabilizes the seat of the tracheostomy tube
- Reduces the emergence of air and secretion, thus improves secretion management
- Facilitates the setting of uniform ventilation parameters in the case of ventilated patients
- Skin-colored
- Available in three sizes, for adults and children

Indication

- Tracheostomy/ Laryngectomy
- Suitable for patients with normal and sensitive skin
- Suitable for patients with an irregular stoma

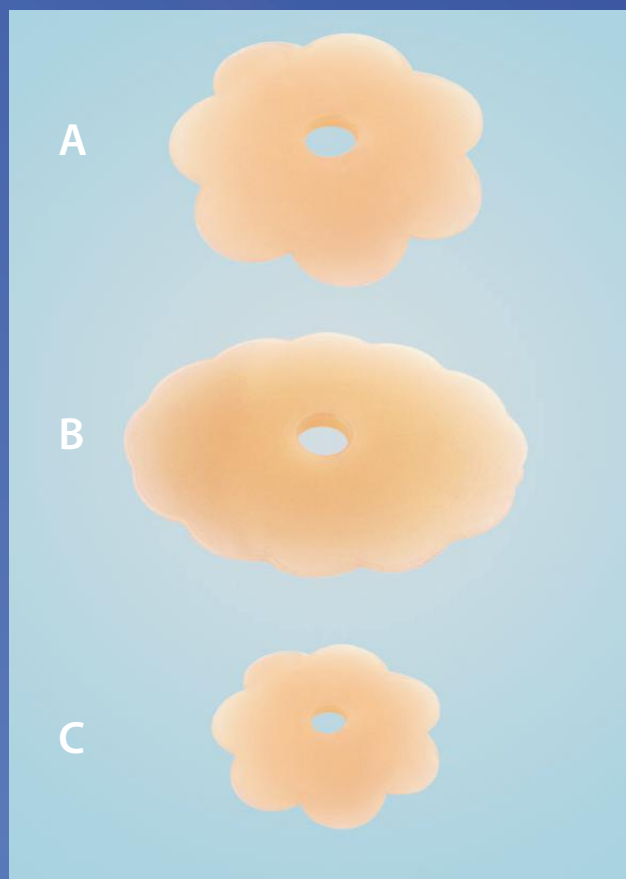

	PU	Shape	Article number
PRIMED TRACHEO SEAL® for adults, round (A)	3 pieces	round	200236
PRIMED TRACHEO SEAL® for adults, oval (B)	3 pieces	oval	200237
PRIMED TRACHEO SEAL® for children, round (C)	3 pieces	round	200238

Accessories for pulmonary rehabilitation are specially designed for the needs of patients both in hospital and rehabilitation care and receiving nursing care at home.

Patients are either completely or partially incapable of breathing via their larynx, mouth and nose following a laryngectomy or tracheostomy. This is also accompanied by a loss of function of the upper respiratory tract. The accessories specially developed for laryngectomized and tracheostomized patients take on these functions, achieving a considerable improvement in the quality of life.

In addition to **heat and moisture exchangers (HME)** which contribute to pulmonary rehabilitation through the humidification, heating and filtration of respiratory air, we also provide a large selection of **speaking valves** which are suitable for both laryngectomized patients with voice prosthesis and tracheostomized patients with an intact larynx which enable phonation. We also provide **speaking valves with a filter function** and **respiration valves** (for ventilated tracheostomized patients).



PU = Packaging unit
I = Inspiration
Ex = Expiration

Product features

- Enables heat and moisture exchange of breathing air and particle filtration (for infection prevention)
- Low breathing resistance thanks to large surface
- With foam filter
- Standardized 15 mm opening for attachment to a tracheostomy tube or endotracheal tube with 15 mm connection
- Integrated oxygen supply port
- PRIMEDIAIR® VO2 features additionally a self-opening safety/ suction port in the lid which can be used for suctioning and in case of coughing or blockage acts as a relief valve



PRIMEDIAIR® -VO2

Indication

- Spontaneously breathing intubated, tracheostomized and laryngectomized patients

	PU	Connector	Article number
PRIMEDIAIR®-VO2	30 pieces	15 mm	21063
Resistance at			
30 l/min	0,08 hPa (I);		0,09 hPa (Ex)
60 l/min	0,13 hPa (I);		0,14 hPa (Ex)
90 l/min	0,16 hPa (I);		0,17 hPa (Ex)
Moisture loss			
Vt = 250 ml		8,5 mg/l	
Vt = 500 ml		10,6 mg/l	
Vt = 750 ml		13,0 mg/l	
Vt = 1000 ml		17,0 mg/l	

Product features

- Enables heat and moisture exchange of breathing air and particle filtration (for infection prevention)
- Low breathing resistance thanks to large surface
- With 15 mm connector for attachment to a tracheostomy tube or endotracheal tube with 15 mm connection
- Integrated oxygen supply port
- Integrated self-opening safety/ suction port in the lid which can be used for suctioning and in case of coughing or blockage acts as a relief valve
- Available with two different filter media:

Type A with hygroscopic foam filter
 Type B with hygroscopic microwell paper

Indication

- Spontaneously breathing intubated, tracheostomized and laryngectomized patients



PRIMEDIAIR®-DUAL



	PU	Connector	Article number
WITH FOAM FILTER (A)	30 pieces	15 mm	21065
WITH PAPER FILTER (B)	30 pieces	15 mm	20497

	WITH FOAM FILTER (A)	WITH PAPER FILTER (B)
Resistance at		
30 l/min	0,35 hPa (I) 0,42 hPa (Ex)	0,38 hPa (I) 0,36 hPa (Ex)
60 l/min	1,05 hPa (I) 1,15 hPa (Ex)	1,05 hPa (I) 0,75 hPa (Ex)
90 l/min	2,01 hPa (I) 2,12 hPa (Ex)	1,86 hPa (I) 1,10 hPa (Ex)
Moisture loss		
Vt = 250 ml	8,05 mg/l	10,14 mg/l
Vt = 500 ml	11,76 mg/l	12,2 mg/l
Vt = 750 ml	12,83 mg/l	13,11 mg/l
Vt = 1000 ml	14,52 mg/l	13,99 mg/l

HEAT AND MOISTURE EXCHANGERS (HME)

Product features

- Enables heat and moisture exchange of breathing air and particle filtration (for infection prevention)
- Particularly flat and unobtrusive design
- With foam filter
- With 22 mm connector for attachment to a tracheostomy or laryngectomy tube with 22 mm connection, a stoma button (Type III) or a tracheostoma patch (PRIMEDISTRIP®)

Indication

- Spontaneously breathing tracheostomized and laryngectomized patients

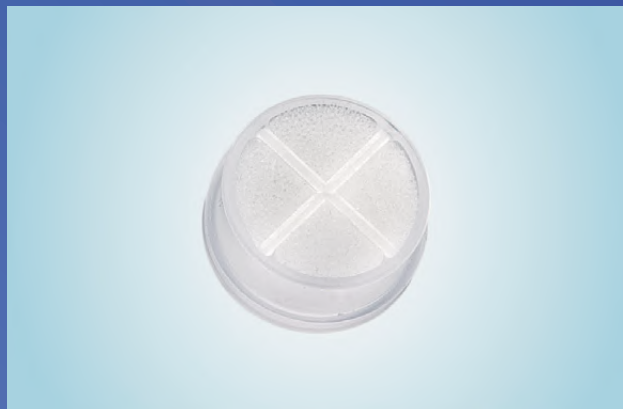

PRIMEDIAIR®-KAS

	PU	Connector	Article number
PRIMEDIAIR®-Kas	30 pieces	22 mm	20482

HEAT AND MOISTURE EXCHANGERS (HME) WITH SPEAKING FUNCTION

Product features

- Enables heat and moisture exchange of breathing air and particle filtration (for infection prevention)
- With speech button (to speak, press the speech button down gently using one finger, sealing off the system to allow phonation)
- Unobtrusive design: flat and skin-colored
- With 22 mm connector for attachment to a tracheostomy or laryngectomy tube with 22 mm connection, a stoma button (Type III) or a tracheostoma patch (PRIMEDISTRIP®)
- Foam filter available in two material versions:
 - EASYTOUCH features a normal foam filter
 - EASYTOUCH ULTRAFLOW is equipped with an Ultra-Flow foam filter with a particularly low resistance to inspiration

Indication

- Laryngectomized patients (with voice prosthesis)/
Tracheostomized patients with intact larynx



EASYTOUCH



EASYTOUCH ULTRAFLOW

	PU	Connector	Article number
EASYTOUCH	30 pieces	22 mm	200311
EASYTOUCH ULTRAFLOW	30 pieces	22 mm	200312

	EASYTOUCH	EASYTOUCH ULTRAFLOW
Resistance at		
30 l/min	0,43 hPa (I); 0,43 hPa (Ex)	0,28 hPa (I) 0,32 hPa (Ex)
60 l/min	1,30 hPa (I); 1,40 hPa (Ex)	0,90 hPa (I) 1,10 hPa (Ex)
90 l/min	2,49 hPa (I); 2,79 hPa (Ex)	1,79 hPa (I) 2,28 hPa (Ex)
Moisture loss		
Vt = 1000 ml	19,7 mg/l	23,5 mg/l



With speech button

HEAT AND MOISTURE EXCHANGERS (HME) FOR NEONATES AND CHILDREN

Product features

- Enables heat and moisture exchange of breathing air and particle filtration (for infection prevention)
- Specially designed for the tidal volume of neonates and children
- With 15 mm connector for attachment to a tracheostomy tube with 15 mm connection
- Available in two different filter media:

Typ A with hygroscopic blue foam filter
 Typ B with hygroscopic white paper filter

Indication

- Spontaneously breathing tracheostomized neonates and children



PRIMEDIAIR®-NATAL



	PU	Connector	Article number
A With foam filter	30 pieces	15 mm	21062
B With paper filter	30 pieces	15 mm	20496

	PRIMEDIAIR®- Natal with foam filter (A)	PRIMEDIAIR®- Natal with paper filter (B)
Restistance at		
5 l/min	0,14 hPa (I) 0,14 hPa (Ex)	0,3 hPa (I) 0,3 hPa (Ex)
Moisture loss		
Vt = 30 ml	10,2 mg/l	9,7 mg/l

Speaking valves can be divided into two different groups. There are valves for tracheostomized patients with preserved larynx and those for laryngectomized patients with voice prosthesis. There are technical and functional differences between both types of speaking valves.

Speaking valves for tracheostomized patients with preserved larynx:

Tracheostomized patients can use the natural respiratory tract via the mouth and nose, breathing in through the speaking valve and exhaling via the upper respiratory tract. As the speaking valve closes following inspiration, the expiration air escapes over the available larynx, thus enabling phonation.

Speaking valves suitable for this purpose include the PRIMEDI SPEAKING VALVE, PRIMEDI-PHON PLUS® and PRIMEDI-PHON VENT®.

These speaking valves for tracheostomized patients must not be used on laryngectomees!

Speaking valves for laryngectomized patients with voice prosthesis:

Laryngectomized patients with a voice prosthesis can cultivate their own compensatory voice with the aid of a special speaking valve. As these patients breathe exclusively via the tracheostoma, the speaking valve needs to remain open during the respiration process to ensure an unobstructed exchange of air.

For this reason, speaking valves for laryngectomized patients are either purposely closed with a finger to generate speech (PRIMEDIAIR®-PHON) or function with a special valve membrane which, due to the increased exhalation pressure during phonation, diverts the expiration air over the voice prosthesis, but otherwise remains open (PRIMEDI RESISTANCE VALVES).

These speaking valves can also be used by tracheostomized patients with an intact larynx.



SPEAKING VALVES FOR TRACHEOSTOMIZED PATIENTS

PRIMEDI SPEAKING VALVE

Product features

- Small speaking valve in white design
- With 15 mm connector for attachment to sieved/ fenestrated tracheostomy tubes with 15 mm connection (suitable for all tube sizes)

Indication

- Spontaneously breathing tracheostomized patients
(The use on laryngectomized patients is contraindicated!)



PRIMEDI SPEAKING VALVE

	PU	Connector	Article number
PRIMEDI SPEAKING VALVE	10 pieces	15 mm	20489

SPEAKING VALVES FOR TRACHEOSTOMIZED PATIENTS

Product features

- Speaking valve with closed basic position of the silicone membrane
- Available in two different colour schemes:
 - transparent: suitable for the use in the outpatient sector and for home care, due to its unobtrusive colour scheme
 - blue-transparent: designed for use with inpatients, due to its conspicuous colouring
- Available with or without integrated oxygen supply port
- Suitable for the following:
 - Sieved/ fenestrated tracheostomy tubes
 - Tracheostomy tubes with completely unblocked cuff and tracheostomy tubes without cuff
 - (IMPORTANT: An adequate airflow around the tracheostomy tube must be ensured!)
- The filter cartridge contained in the scope of delivery can be optionally connected to the PRIMEDI-PHON PLUS® speaking valve for filtering inspiration air (also available separately)

How does it work?

- A special feature of this speaking valve is the closed basic position of the silicone membrane
- The membrane only opens briefly during inspiration and reacts to even very weak inhalation
- Afterwards it automatically returns to the tightly sealed basic position without exhalation pressure (expiration pressure) being required (an extremely short shutting time); phonation therefore does not require any build-up of expiration pressure



**PRIMEDI-PHON PLUS®
(TRANSPARENT)**



SPEAKING VALVES FOR TRACHEOSTOMIZED PATIENTS

- The impermeability of the PRIMEDI-PHON PLUS® speaking valve creates an air column in the tube during exhalation (in sieved tubes above the sieving) which prevents secretion from penetrating and, consequently, any relocation of the tracheostomy tube
- The expiration air is channelled completely via the larynx and upper respiratory tract
- This enables the formation of speech (phonation) and expectoration of secretions

Indication

- Spontaneously breathing tracheostomized patients
(The use on laryngectomized patients is contraindicated!)



**PRIMEDI-PHON PLUS®
(BLUE-TRANSPARENT)**



	PU	O ₂ -port	Connector	Article number
PRIMEDI-PHON® PLUS (transparent)	1 piece	no	15 mm/ 22 mm	200354
PRIMEDI-PHON® PLUS (transparent, with O ₂ -port)	1 piece	yes	15 mm/ 22 mm	200355
PRIMEDI-PHON® PLUS (blue-transparent)	1 piece	no	15 mm/ 22 mm	200356
PRIMEDI-PHON® PLUS (blue-transparent, with O ₂ -port)	1 piece	yes	15 mm/ 22 mm	200357
FILTER CARTIDGE 15/22 for PRIMEDI-PHON® PLUS	30 pieces	no	15 mm	200351

INCLUDING:



SPEAKING VALVES FOR TRACHEOSTOMIZED PATIENTS

Product features:

- Speaking valve with closed basic position of the silicone membrane
- With additional oxygen supply port
- Adjustable lateral air inlets and outlets can be opened or closed steplessly by rotating through up to max. 90°

CLOSED: If the air inlets and outlets are closed, the TwinPhon® functions only in the inhalation direction and behaves like a normal speaking valve. In this way, the air is routed through the upper airways during exhalation, thus allowing phonation.

OPEN: Following stepless rotation of the valve in the other direction, the lateral openings are opened again and it is possible to regulate the exhaled air in this way.

What is special about TwinPhon® Extra?

TwinPhon® Extra includes an additional HME filter cassette in the rotatable accessory and functions in the opened position like an HME. The HME filter cassette can be replaced and is available separately.

Indication

- Spontaneously breathing tracheostomized patients with intact larynx (The use on laryngectomized patients is contraindicated!)
- Weaning

	PU	Connector	Article number
TwinPhon®	1piece	15 mm	200319
TwinPhon® Extra	1piece	15mm	200318
HME filter cassette for TwinPhon® Extra	30 pieces	-	200317

INCLUDING:

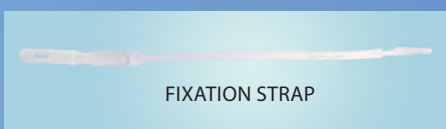

TWINPHON®



TWINPHON® EXTRA

SPEAKING VALVES FOR VENTILATED TRACHEOSTOMIZED PATIENTS

Product features

- Speaking valve with closed basic position of the silicone membrane and connection for attachment to a ventilator
- Suitable for the following:
Sieved/ fenestrated tracheostomy tubes
Tracheostomy tubes with completely unblocked cuff and tracheostomy tubes without cuff
(IMPORTANT: An adequate airflow around the tracheostomy tube must be ensured!)
- Can be attached to a ventilator via swivelling 15 mm connector (For setting of ventilation parameters observe instructions for use!)
- Inhalation takes place via ventilator; at the end of inspiration the silicone membrane automatically returns to the tightly sealed basic position and the expiration air is channelled completely via the larynx and upper respiratory tract, thus enabling phonation

Indication

- Tracheostomized, ventilated patients with intact larynx (adults, children and neonates)
- Spontaneously breathing tracheostomized patients (**The use on laryngectomized patients is contraindicated!**)
- Neuromuscular disorders
- Ventilation
- Weaning



PRIMEDI-PHON VENT® (PPV)



	PU	Connector	Article number
PRIMEDI-PHON® VENT	1 piece	15 mm/ 22 mm (near the patient) - swivelling 15 mm (near the ventilator)	200320

INCLUDING:

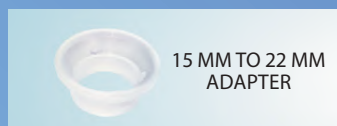

SPEAKING VALVES FOR LARYNGECTOMIZED & TRACHEOSTOMIZED PATIENTS

Product features

- Speaking valve with silicone membrane
- Infinitely adjustable (via the integrated rotation mechanism) to the individual exhalation pressure of the patient
- Available in two different versions:
 - A PRIMEDI-RESISTANCE-VALVE with normal resistance (blue silicone membrane)
 - B PRIMEDI-LOW-RESISTANCE-VALVE with low resistance (white silicone membrane); here only relatively little pressure is required to close it
- Air can pass unobstructed through the speaking valve during respiration. Only the increased exhalation pressure during expiration leads to closing of the silicone membrane, and exhalation air is conducted through the voice prosthesis or the larynx to generate speech
- With 22 mm connector for attachment to a tracheostomy or laryngectomy tube with 22 mm connection, a stoma button (Type III) or a tracheostoma patch (PRIMEDISTRIP®)

Indication

- Laryngectomized patients (with voice prosthesis)/
Tracheostomized patients with intact larynx



PRIMEDI-RESISTANCE-VALVES



	PU	Connector	Article number
PRIMEDI-RESISTANCE-VALVE (A)	1 piece	22 mm	20481
PRIMEDI-LOW-RESISTANCE-VALVE (B)	1 piece	22 mm	20480

SPEAKING VALVES WITH FILTER FUNCTION FOR LARYNGECTOMIZED & TRACHEOSTOMIZED PATIENTS

Product features

- Speaking valve with filter function
- Low profile
- Discrete design: skin-coloured or transparent
- Filtration, humidification and heating of inhaled air thanks to the integrated special foam (resulting in a reduction of secretion, coughing and incrustations)
- Enables phonation merely by closing it with a finger
- With 22 mm connector for attachment to a tracheostomy or laryngectomy tube with 22 mm connection, a stoma button (Type III) or a tracheostoma patch (PRIMEDISTRIP®)
- Available in two different filter media:
PRIMEDIAIR®-PHON with normal foam filter
PRIMEDIAIR®-PHON ULTRAFLOW with Ultra-Flow foam filter with a particularly low resistance to inspiration
- PRIMEDIAIR®-PHON ULTRAFLOW facilitates respiration and is particularly recommended for strenuous physical activity

Indication

- Laryngectomized patients (with voice prosthesis)/
Tracheostomized patients with intact larynx



PRIMEDIAIR®-PHON



**PRIMEDIAIR®-PHON
ULTRAFLOW**

	PU	Connector	Article number
PRIMEDIAIR® -PHON	30 pieces	22 mm	20483
PRIMEDIAIR® -PHON ULTRAFLOW	30 pieces	22 mm	200359

Product features

- BACTERIA and VIRUS FILTERS for protecting the patient as well as the ventilation unit during ventilation
- Verified retention effect of 99,999% for bacteria and viruses
- Minimize the risk of cross-infections
- Feature a built-in CO₂ - port
- Designed for adults with a tidal volume of 300-1500 ml
- Available with and without integrated heat and moisture exchanger (HME)
- Filter with HME additionally humidifies and warms the respiratory gases
- To be positioned between an endotracheal tube or tracheostomy tube and the Y-piece of a ventilation system

Indication

- Ventilation

(Do not use in combination with volatile oils and inhalation devices!)



WITHOUT HME



WITH HME

	WITHOUT HME	WITH HME
Article number	27304	27305
Connector	22 mm F/ 15 mm M 22 mm M/15 mm F	22 mm F/ 15 mm M 22 mm M/15 mm F
PU	50 pieces	50 pieces
Compressible volume	45 ml	45 ml
Resistance at		
30 l/min	1,1 hPa (I) 1,2 hPa (Ex)	1,4 hPa (I) 1,3 hPa (Ex)
60 l/min	2,6 hPa (I) 2,7 hPa (Ex)	3,3 hPa (I) 3,2 hPa (Ex)
90 l/min	4,0 hPa (I) 4,3 hPa (Ex)	5,5 hPa (I) 5,4 hPa (Ex)
Moisture loss		
Vt = 500 ml		11 mg/l
Vt = 750 ml		12 mg/l
Vt = 1000 ml		13,9 mg/l

Product features

- Absorb secretions from the tracheostoma quickly to avoid skin irritation
- Act as a pad between the tracheostoma and the tracheostomy tube
- They are slit and can therefore be replaced while wearing the tracheostomy tube
- Available in a variety of materials and absorption strengths:

Nonwoven compresses made of lint-free, skin-friendly material are available in one-layer (A, D,F) and two-layer (B, E) variants (sterile or non sterile)

Compresses coated on one side with aluminium prevent adherence with wound secretion on the skin (C)

Moreover, high-quality tracheal compresses made of special polyurethane foam (PU) are also available which are particularly well tolerated by the skin and can absorb 20 times their own weight in liquid (G,H,I).

These PU compresses are available in a variety of designs and sizes, including in smaller format for children (I)

Indication

- Tracheostomy/ Laryngectomy

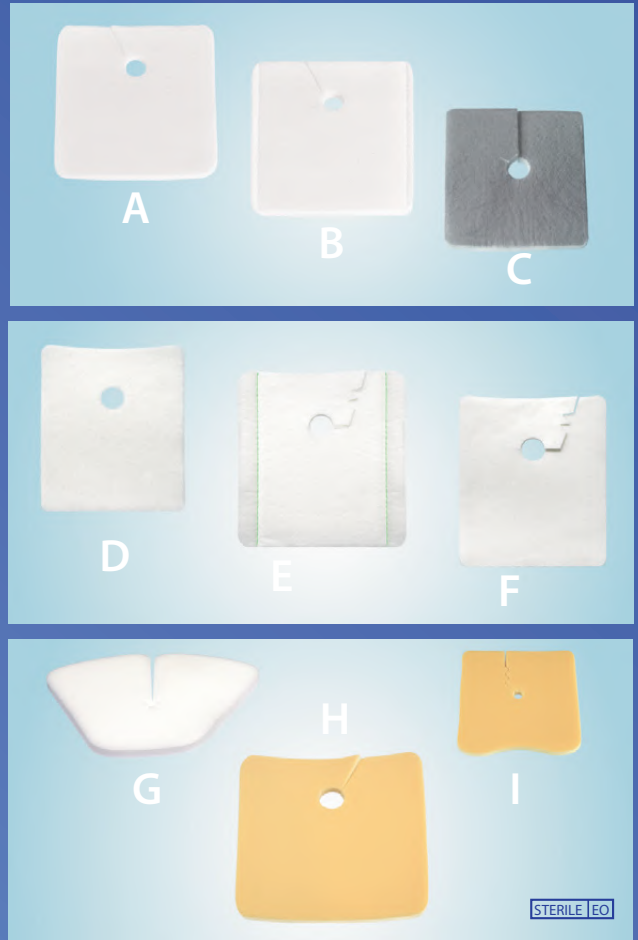

		PU	Article number
A	Tracheal compress, one-layer, 9 x 10 cm (slit, with push-through opening), individually packaged, sterile	10 pieces	200230
A	Tracheal compress, one-layer, 9 x 10 cm (slit, with push-through opening), non sterile	10 pieces	200212
B	Tracheal compress, two-layer, 9 x 10 cm (slit, with push-through opening), individually packaged, sterile	10 pieces	200231
B	Tracheal compress, two-layer, 9 x 10 cm (slit, with push-through opening), non sterile	10 pieces	200213
C	Tracheal compress, aluminium-coated, 8 x 9 cm (slit, with push-through opening), individually packaged, sterile	10 pieces	200233

		PU	Article number
D	Tracheal compress, one-layer, 9 x 10 cm (with push-through opening), non sterile	10 pieces	200200
E	Tracheal compress, two-layer, coated, 9 x 10 cm (slit, with push-through opening), non sterile	10 pieces	200202
F	Tracheal compress, one-layer, 9 x 10 cm (slit, with push-through opening), non sterile	10 pieces	200201

		PU	Article number
G	Special compress, PU-foam, (slit, with push-through opening), individually packaged, sterile	10 pieces	21858
H	Tracheal compress, PU-foam, 9,6 x 10 cm (slit, with push-through opening), individually packaged, sterile	10 pieces	21840
I	Tracheal compress for children, PU-foam, 6,5 x 6,5 cm, (slit, with push-through opening), individually packaged, sterile	10 pieces	200234

Product features

- For securely holding a tracheostomy tube, a laryngectomy tube or a Stoma button with eyelets in place
- Provide an optimum wearing comfort, as they are made of soft, skin-compatible material
- Available in different widths
- Individually adjustable
- Especially suitable for sensitive skin
- Variants for adults and children

Indication

- Tracheostomy/ Laryngectomy
- Radiation/ MRI

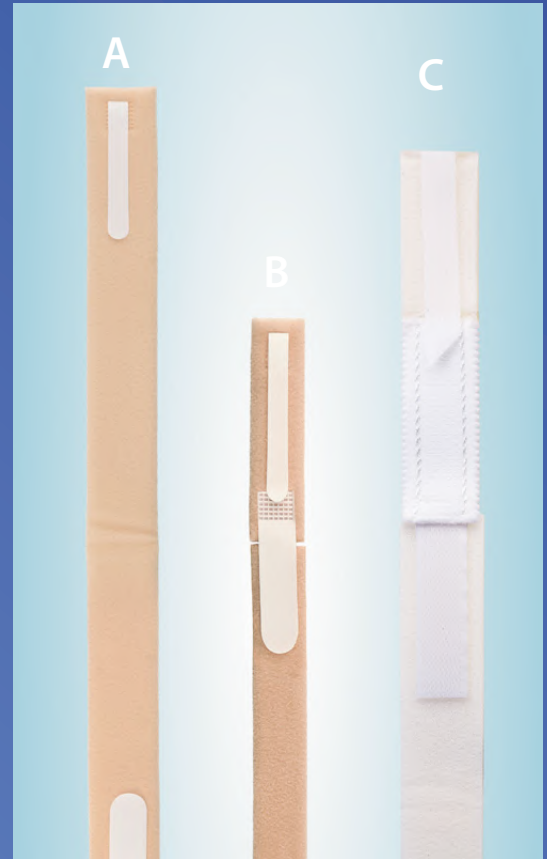

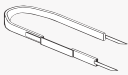
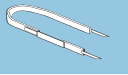
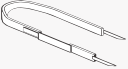
		PU	Article number
A	PRIMEDIFIX® neck strap, 2-part, skin-colored, with velcro fastener, width = 24 mm, length = 47 cm, non sterile		10 pieces 200211
B	PRIMEDIFIX® neck strap for children, 2-part, skin-colored, with velcro fastener, width = 20 mm, length = 24 cm, non sterile		10 pieces 200203
C	PRIMEDIFIX® neck strap, 2-part, white, with velcro fastener width = 26 mm, length = 45,5 cm, sterile		10 pieces 21450

Product features

- Covers the whole stoma while showering
- Ensures good tissue compatibility (made of soft medical-grade silicone)
- Adjustable length
- Integrated struts stabilize the cover
- With protective edge which fits seamlessly to the skin
- The openings for breathing are located in the lower area of the device which also avoids the ingress of liquids

Indication

- Tracheostomy/ Laryngectomy
(Not to be used for bathing or swimming!)



SHOWER GUARD

	PU	Article number
Shower guard	1 piece	102085

Product features

- Complete set for tracheal suctioning
- Supplied with an extra sealing cap and an extra label for patient information
- Available with or without vacuum control

Indication

- Tracheostomy/ Laryngectomy

TRACHEAL SUCTION SET		PU	Article number
without picture	TRACHEAL SUCTION SET, without vacuum control, sterile	60 pieces	21214
see picture	TRACHEAL SUCTION SET with vacuum control, sterile	60 pieces	21215



TRACHEAL SUCTION SET

PRIMEDICLEAN®

Product features

- Highly effective product for cleaning and disinfecting tracheostomy tubes
- Comes in a 250ml bottle.

Indication

- Suitable for medical-grade polymer and silver tracheostomy tubes



PRIMEDICLEAN®

	PU	Article number
PRIMEDICLEAN® (250 ml)	1 bottle	70810

CLEANING BRUSHES

Product features

- For gentle and effective cleaning of tracheostomy tubes
- Feature an extremely flexible wire netting and have sturdy yet soft nylon bristles
- Wool tip avoids damaging and scratching of the tube
- Flexible form allows for individual adjustment
- With plastic grip for safe handling

Indication

- Tracheostomy/ Laryngectomy



Size	suitable for tubes with an inside diameter of	PU	Article number
6	5-7 mm	5 pieces	200220
8	8-9 mm	5 pieces	200221
10	10-11 mm	5 pieces	200222
12	12-13 mm	5 pieces	200223
14	14-15 mm	5 pieces	200224

LUBRICANT GEL

Product features

- OPTILUBE is a sterile lubricant gel which enables an easy insertion of tracheostomy tubes and stoma buttons



	PU	Article number
Optilube (5 g)	50 pieces	70295



With speaking option



With low-pressure cuff



With subglottic suction function



Sterilization with ethylene oxide

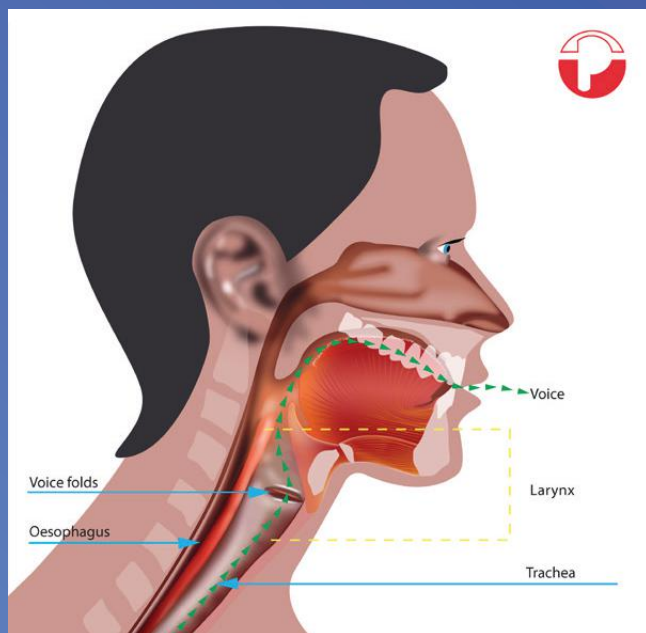

Before Laryngectomy/Tracheostomy

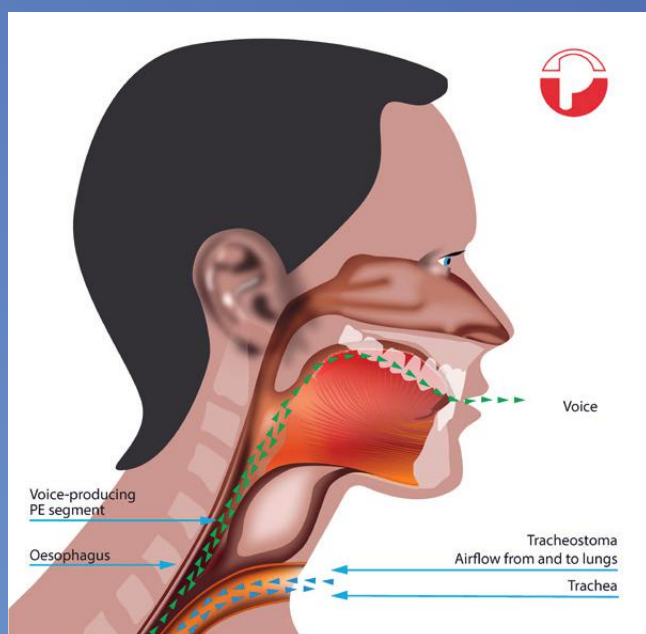

After Laryngectomy

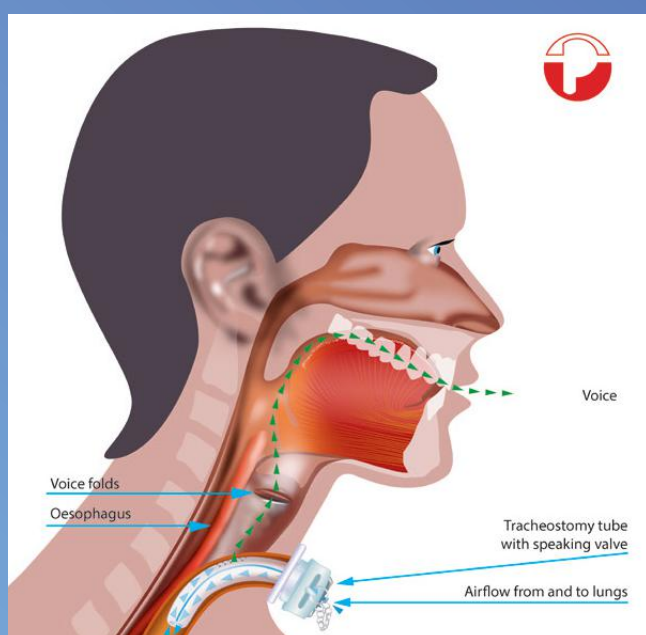

After Tracheostomy
(sieved tracheostomy tube with speaking valve)

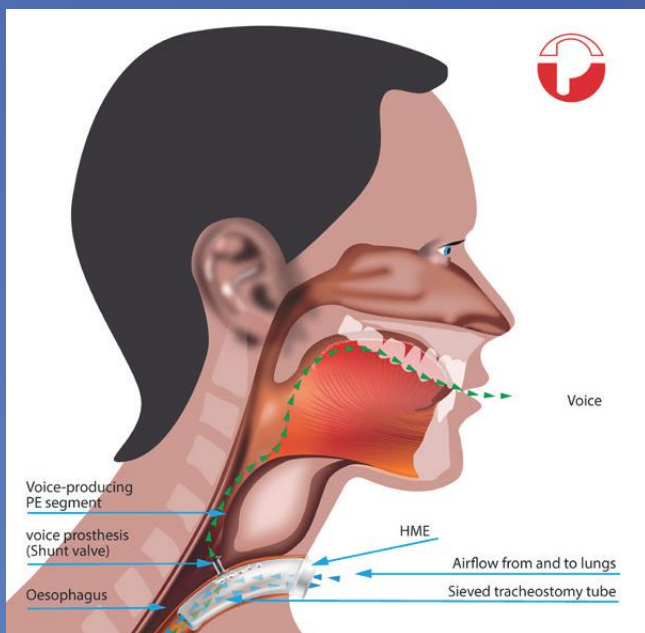

After Laryngectomy with voice prosthesis (sieved tracheostomy tube with HME)

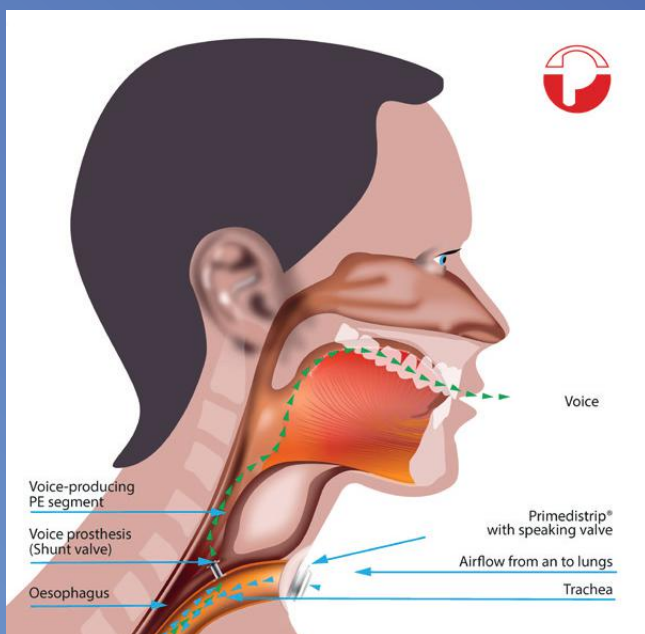

After Laryngectomy with voice prosthesis (Primedistrip® with speaking valve)

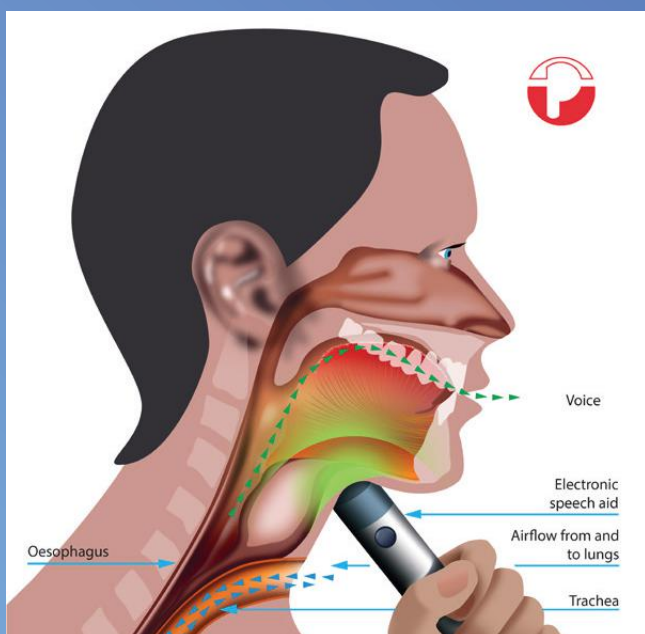

After Laryngectomy (with electronic speech aid)

MANUFACTURER

Primed[®] HALBERSTADT
MEDIZINTECHNIK GMBH
STRASSE DES 20. JULI 1
D-38820 HALBERSTADT
Phone.: 0049-(0)3941-668-6
FAX: 0049-(0)3941-24565
PRIMED@PRIMED-HALBERSTADT.DE

Your distributor

All rights to technical modifications reserved!

Revision status: 06/2022-07-27