



**Comprehensive solutions  
for healthcare providers**



**since 1989...**

ZARYS. We create good solutions

[WWW.ZARYS.COM](http://WWW.ZARYS.COM)



ZARYS International Group is a company with **32-year** experience in the medical device industry. Since the foundation in 1989 ZARYS has surmounted a variety of business, trading and economic upheavals in becoming the market leader in healthcare distribution in Poland and abroad.

ZARYS offers a wide range of products including dressings, surgical drapes, examination gloves, disposable medical devices for urology, gynecology, oxygen therapy and many other items. The company is still expanding its product list in order to meet new market needs.

What distinguishes ZARYS from the competitors is strong ethics and continuous search for new solutions. In order to meet our clients' expectations we are constantly reviewing our product range. All of our devices are selected very carefully with great attention paid to current needs, quality convenient availability. The company has the pleasure to cooperate with highly qualified health care specialists, who share with us their expertise and understanding of the latest trends in clinical practice.

We offer products under our own brand and distribute the world's top manufacturers' medical devices. Our team believes that maintaining fair and reliable relationships with our international partners is the key to turn a business opportunity into a major success story, therefore we regularly visit our customers and suppliers in their own countries and handle challenges together.

Our values, strategies and comprehensiveness guarantee successful and satisfactory cooperation.

# MEDICAL GLOVES pp.8-17

## EXAMINATION GLOVES

### nitrile examination gloves

- 11 | **mediCARE** nitrile lime green
- 11 | **mediCARE** nitrile pink
- 12 | **mediCARE** nitrile AMG
- 13 | **mediCARE** nitrile Hydra+
- 14 | **easyCARE** nitrile black
- 14 | **easyCARE** nitrile pink
- 15 | **easyCARE** nitrile

### latex examination gloves

- 16 | **easyCARE** latex
- 16 | **easyCARE** latex PF

### vinyl examination gloves

- 17 | **easyCARE** vinyl
- 17 | **easyCARE** vinyl PF

# BASIC MEDICAL DEVICES pp.18-71

## BASIC DISPOSABLE EQUIPMENT

- 21 | **dispoFINE** injection needle
- 21 | **dispoGUARD** safety injection needle
- 23 | **duoNEX** single-use syringe, 2-part, luer
- 23 | **dicoNEX SN** single-use syringe, 3-part, luer, with needle alongside the syringe
- 24 | **dicoNEX** single-use syringe, 3-part, luer
- 24 | **dicoNEX** single-use syringe, 3-part, luer lock
- 25 | **dicoNEX** single-use catheter syringe, 3-part
- 25 | **dicoNEX** single-use catheter syringe, 3-part
- 26 | **dicoTUBER** tuberculin syringe
- 26 | **dicoSULIN** insulin syringe
- 27 | **safeLANCE** pressure-activated safety lancet
- 27 | **dispoSULIN** insulin pen needle
- 28 | side hole needle **NEW!**
- 29 | stomach tube/duodenal tube
- 30 | feeding tube graduated, with X-ray contrast
- 30 | suction catheter
- 31 | suction catheter with vacuum control
- 31 | suction catheter with frozen surface, phthalate-free
- 32 | vaginal speculum cusco type
- 32 | **dicoSPIKE** withdrawal cannula
- 33 | cervical brush standard
- 33 | cervical brush special
- 33 | umbilical cord clamp

## INFUSION THERAPY

- 35 | **SANViflon** I.V. cannula
- 35 | **SANViflon S** I.V. cannula without port
- 36 | **easyFLOW IS** infusion set
- 36 | **easyFLOW IS ECO** infusion set
- 37 | **easyFLOW LINE** extension tube for infusion pump
- 37 | **easyFLOW TS** transfusion set
- 38 | 3-way stopcock
- 38 | 3-way stopcock with extension tube
- 39 | needle-free valve
- 39 | cannula stopper

## UROLOGICAL CATHETERS AND URINE BAGS

- 41 | foley catheter 2-way, silicone-coated latex
- 42 | foley catheter 3-way, silicone-coated latex
- 42 | foley catheter 2-way, 100% silicone
- 43 | foley catheter 3-way, 100% silicone
- 43 | foley catheter 2-way with tiemann tip, silicone-coated latex
- 44 | pezzet catheter, silicone-coated latex
- 44 | nelaton catheter
- 45 | tiemann catheter
- 45 | urine bag
- 46 | urine bag with sample port
- 46 | urine bag with sample port 2W
- 47 | samples taking urine bag
- 47 | urine bag hanger
- 47 | enema bag, sterile
- 48 | enema bag, non-sterile
- 48 | enema set, non-sterile
- 48 | vomit bag, non-sterile

## OXYGEN THERAPY

- 50 | oxygen mask with tubing
- 50 | non-rebreather mask with tubing
- 51 | nebulizer mask with tubing
- 51 | multi-vent mask with tubing
- 52 | nasal oxygen cannula
- 52 | oxygen tubing
- 52 | nebulizer with mouthpiece and tubing
- 53 | nebulizer with T adaptor, mouthpiece, corrugated tube and tubing
- 53 | nebulizer with T F/M adaptor, mouthpiece, corrugated tube and tubing **NEW!**

## ANAESTHESIA PRODUCTS

- 55 | laryngeal mask PVC
- 55 | laryngeal mask silicone
- 56 | intubation stylet
- 56 | tracheal tube introducer curved
- 56 | endotracheal tube uncuffed
- 57 | endotracheal tube cuffed
- 57 | reinforced endotracheal tube cuffed
- 58 | endotracheal tube holder
- 58 | tracheostomy tube cuffed
- 59 | dual-limb breathing circuit
- 59 | catheter mount with double swivel elbow connector
- 60 | oropharyngeal airway/guedel airway
- 60 | air cushion anaesthetic mask

## GENERAL SURGERY

- 62 | Yankauer surgical suction cannula, standard
- 62 | Yankauer surgical suction cannula, bulb tip
- 63 | surgical suction tube
- 64 | surgical suction set, with Yankauer cannula, standard
- 65 | surgical suction set, with Yankauer cannula, bulb tip

## OTHER DISPOSABLE PRODUCTS

- 67 | latex-free tourniquet
- 67 | automatic tourniquet
- 68 | dental brush with suction
- 68 | oral swab
- 68 | tonque depressor
- 69 | wash glove MOLTON
- 69 | wash glove SPUNLACE
- 69 | wash glove with film lining
- 70 | ID wristband
- 70 | entrance mat
- 71 | PE gloves
- 71 | electronic thermometer

## TRADITIONAL DRESSING MATERIALS

### gauze and non-woven dressings

- 75 | **GAZA lux** dressing gauze, zig-zag folded
- 75 | **GAZA lux** cutting gauze
- 75 | **GAZA lux S** cutting gauze
- 76 | **KOMPRI lux** gauze swabs **BESTSELLER!**
- 77 | **KOMPRI lux S** gauze swabs
- 78 | **SERVI lux** gauze lap sponges
- 78 | **SERVI lux S** gauze lap sponges
- 79 | **TUPFER lux** gauze balls
- 79 | **TUPFER lux S** gauze balls
- 80 | **NONVI lux** non-woven swabs
- 80 | **NONVI lux S** non-woven swabs
- 80 | **NONVI lux S** non-woven swabs, with Y-incision
- 81 | **MULTIabsorb** ABD pads, multi-layer
- 81 | **MULTIabsorb S** ABD pads, multi-layer
- 82 | **elastoLUMENAL** eye pads
- 82 | **elastoLUMENAL S** eye pads

## ADHESIVE TAPES AND PLASTERS WITH DRESSING

### adhesive tapes

- 84 | **SENSiplast** adhesive fabric tape, white
- 84 | **PLASTiplast** adhesive fabric tape, skin colour
- 85 | **SOFTiplast** adhesive non-woven tape
- 85 | **SILKplast** adhesive silk tape
- 86 | **FILMplast** adhesive PE tape
- 86 | **POREplast** adhesive perforated non-woven tape

### plasters with dressing

- 87 | **NONVIplast** non-woven plaster with dressing
- 87 | **FABRIplast** fabric plaster with dressing

## SPECIAL PURPOSE DRESSINGS

### self-adhesive non-woven dressings

- 89 | **elastopor, elastopor E** adhesive non-woven dressing tape
- 90 | **elastopor STERIL** non-woven dressing with absorbent pad **BESTSELLER!**
- 90 | **elastopor IV** non-woven IV cannula dressing **BESTSELLER!**
- 91 | **elastopor STERIL D** non-woven dressing with absorbent pad, incision and O-hole
- 91 | **elastopor EYE** non-woven eye dressing with absorbent pad
- 92 | **elastoKIDS IV** non-woven IV cannula dressing
- 92 | **elastoKIDS STERIL** non-woven dressing with absorbent pad

### stabilizing tapes

- 93 | **elastoNASAL** non-woven nasal cannula fixation plaster
- 93 | **elastoFIXAL** adhesive tape for catheter tubing fixation
- 94 | **elastoFIXAL Set** adhesive tape for endotracheal tube
- 94 | **elastoFIXAL TUBE** band for tracheostomy tube fixation **NEW!**

## STABILIZING DRESSINGS

### fixation of dressings

- 96 | **elastoBAND BASIC** knitted supporting bandage
- 96 | **elastoBAND FLEX** elastic supporting bandage, woven
- 97 | **elastoNET** elastic tubular net bandage

### immobilizing dressings

- 98 | **orthoNATURAL** orthopedic padding, natural
- 98 | **orthoSYNTHETIC** orthopedic padding, synthetic
- 99 | **elastoSLING** triangular sling
- 100 | **orthoBAND FAST, orthoBAND NORMAL, orthoBAND LONG** P.O.P. bandages

## SPECIALIST DRESSINGS

- 103 | **paraffinET** paraffin gauze dressing

### foil dressings

- 104 | **elastoDERM** foil dressing
- 104 | **elastoDERM F** foil dressing with frame
- 105 | **elastoDERM F-IV** IV cannula dressing with frame
- 105 | **elastoDERM IV** IV cannula dressing
- 105 | **elastoDERM PAD** foil dressing with absorbent pad

## ADDITIONAL PRODUCTS

- 107 | **alkoCLEAN** gauze pad moistened with alcohol
- 107 | **ALKOPAD** gauze pad moistened with alcohol **NEW!**
- 107 | **ALKOPAD DUO** gauze pad moistened with alcohol **NEW!**
- 107 | **thermCARE** rescue blanket, foil, termic

# MEDICAL CLOTHING pp.108-131

## MEDICAL GOWNS

- 111 | medical gown with elastic cuffs, non-woven
- 111 | medical gown with knitted cuffs, non-woven

## SURGICAL CLOTHING

- 113 | surgical suit, short-sleeved shirt+trousers, non-woven
- 114 | surgical shirt, short-sleeved, non-woven
- 114 | surgical shirt, long-sleeved, non-woven
- 115 | surgical trousers, with ties, non-woven

## CAPS AND PROTECTIVE MASKS

- 117 | medical bouffant cap, non-woven
- 117 | **DONA** medical bouffant cap
- 117 | **LILI** medical cap with rubber
- 118 | **POLA** medical cap with rubber
- 118 | **SOL** medical cap with ties
- 118 | **ABI** medical cap with ties
- 119 | **NINO** medical cap
- 119 | **KOKO long** medical cap with snood
- 119 | **DORA long** medical cap with snood
- 120 | **BEN** medical cap with ties
- 120 | **TOM** medical cap with ties
- 120 | **ROS** medical cap with ties
- 121 | medical mask with ties
- 121 | medical mask with earloops

## PATIENT CLOTHING

- 123 | patient's gown, tied-up, non-woven
- 123 | patient's gown, Y-neck, non-woven
- 123 | patient's gown, V-neck, non-woven
- 124 | patient's gown, for delivery, non-woven
- 124 | colonoscopy boxers, SMS non-woven
- 124 | colonoscopy boxers, PP non-woven
- 125 | gynecological skirt, non-woven
- 125 | examination underpants, single-use
- 125 | examination underpants, single-use

## SHOE COVERS AND SLIPPERS

- 127 | shoe covers
- 127 | shoe covers, calf-high

## BEDCLOTHES AND ABSORBENT UNDERPADS

- 129 | disposable medical bed sheet
- 129 | disposable medical pillow case
- 129 | disposable medical quilt cover
- 130 | disposable medical bedding set
- 130 | disposable absorbent underpad
- 130 | disposable absorbent underpad for operating table
- 131 | disposable medical bed sheet, reinforced
- 131 | thermal patient cover soft
- 131 | thermal patient cover

## BETASAFE

133 | protective coverall **SAFE +** against chemical and infective agents type 4b-5b-6b

# SURGICAL SETS, DRAPES AND GOWNS pp.134-187

## SURGICAL DRAPES

### 2-layer surgical drapes

- 141 | sterile surgical drapes with cellulose layer
- 141 | sterile surgical drapes
- 141 | sterile surgical drapes with adhesive edge
- 142 | sterile surgical drapes with adhesive edge
- 142 | sterile surgical drapes with central fenestration
- 142 | sterile surgical drapes with adhesive central fenestration
- 143 | sterile surgical drapes with adhesive central adjustable fenestration
- 143 | sterile adhesive epidural drapes
- 143 | sterile instrument table covers

### 3-layer surgical drapes

- 144 | sterile surgical drapes
- 144 | sterile surgical drapes with adhesive edge
- 144 | sterile surgical drapes with central fenestration
- 145 | sterile surgical drapes with adhesive central fenestration
- 145 | sterile surgical drapes with adhesive fenestration, reinforced

### specialistic surgical drapes

- 146 | abdominal drape 1-IF
- 146 | abdo-perineal drape 1
- 146 | laparoscopy drape 3
- 147 | orthopaedic drape 1
- 147 | orthopaedic drape 2
- 147 | orthopaedic drape 3
- 147 | orthopaedic drape 4
- 148 | extremity drape 1
- 148 | extremity drape 2
- 148 | extremity drape 3
- 148 | extremity drape 4
- 149 | extremity drape 5
- 149 | gynaecology drape 1
- 149 | gynaecology drape 2
- 149 | delivery drape 1
- 150 | ophthalmic drape 1-IF
- 150 | ophthalmic drape 2-IF
- 150 | ophthalmic drape 3-IF
- 150 | ophthalmic drape 4-IF

### surgical covers

- 152 | sterile mayo stand cover, reinforced - red **BESTSELLER!**
- 152 | sterile set of limb covers
- 152 | sterile limb covers
- 152 | sterile camera cabs covers - perforated, with 2 adhesive tapes **BESTSELLER!**
- 152 | sterile camera cable cover - unperforated, without adhesive tape

- 153 | sterile camera cable cover - unperforated, with an adhesive tape
- 153 | sterile circular banded covers for medical devices
- 153 | sterile rectangular banded covers for medical devices
- 153 | sterile c-arm cover set
- 153 | sterile armboard cover set

### accessories

- 154 | sterile surgical tapes
- 154 | sterile adhesive pouches
- 154 | sterile adhesive fluid collection pouch
- 154 | sterile absorbent drape
- 155 | sterile absorbent drape
- 155 | sterile incise film **elastoFILM**

## SURGICAL SETS

### universal sets

- 157 | basic set 1
- 157 | universal set 1
- 157 | universal set 2
- 157 | universal set 4 **BESTSELLER!**
- 158 | universal set 5 **BESTSELLER!**
- 158 | universal set 6
- 158 | universal set 7
- 159 | universal set 8
- 159 | paediatric universal set 9
- 159 | universal set 10
- 160 | universal set 5-G
- 160 | universal set 5-GP

### general surgery

- 161 | abdominal set 1-IF
- 161 | abdo-perineal set 1
- 162 | laparoscopy set 1-IF
- 162 | laparoscopy set 2 **BESTSELLER!**
- 163 | laparoscopy set 3
- 163 | varicose vein set 1
- 163 | varicose vein set 2

### orthopaedics and traumatology

- 164 | extremity set 1
- 164 | extremity set 2
- 165 | arthroscopy set 1
- 165 | arthroscopy set 2
- 166 | arthroscopy set 2-IP
- 166 | arthroscopy set 3
- 167 | arthroscopy set 4
- 167 | arthroscopy set 5
- 168 | hip set 1
- 168 | hip set 2
- 169 | hip set 3
- 169 | shoulder set 1
- 170 | shoulder set 2

### gynaecology and urology

- 171 | gynaecology set 1
- 171 | gynaecology set 2 **BESTSELLER!**
- 172 | gynaecology set 3
- 172 | cystoscopy set 1
- 172 | uro/gynaecology set 2
- 173 | uro/gynaecology set 3
- 173 | tur set 1
- 173 | tur set 1 P1 **NEW!**
- 174 | percutaneous lithotripsy set 1-IP

### obstetrics

- 174 | c-section set 1
- 175 | c-section set 1-IF
- 175 | c-section set 2-IF
- 176 | c-section set 3-IF
- 176 | delivery set 1
- 176 | delivery set 2
- 177 | delivery set 3
- 177 | delivery set 4
- 177 | delivery set 5

### ophthalmology

- 178 | ophthalmic set 2-IF
- 178 | ophthalmic set 3-IF

### neurosurgery and otolaryngology

- 179 | otolaryngology set 1
- 179 | otolaryngology set 2
- 179 | craniotomy set 1-IF

### cardiosurgery and angiography

- 180 | ablation set 1-IF
- 180 | angiography set 2

## SURGICAL GOWNS

- 182 | sterile gown NORMAL
- 182 | surgical gown STANDARD **BESTSELLER!**
- 182 | surgical gown STANDARD
- 182 | surgical gown STANDARD
- 183 | surgical gown STANDARD
- 183 | surgical gown SOFT
- 183 | surgical gown STANDART PLUS **BESTSELLER!**
- 183 | surgical gown STANDART PLUS
- 184 | surgical gown STANDART PLUS
- 184 | surgical gown STANDART PLUS
- 184 | surgical gown EXTRA SAFE
- 184 | surgical gown COMFORT
- 185 | surgical gown COMFORT PLUS

### non-sterile surgical gowns

- 185 | surgical gown STANDARD
- 185 | surgical gown PREMIUM

# SPORTS LINE pp.188-193

## yellowBAND

- 190 | cohesive bandage

## yellowTAPE

- 190 | kinesiotape

## yellowRIGID TAPE

- 191 | sports tape, line glue coating

## yellowSPORTS TAPE

- 191 | sports tape

## yellowWRAP

- 191 | foam underwrap

## yellowFOAM

- 192 | foam tape

## scissors

- 192 | for sports tapes

## yellowBOX

- 192 | dispenser for kinesiotapes

# Comprehensive range of medical equipment

Operating theater is the heart of every hospital, where hundreds or even thousands of surgical procedures take place, during which the patient's skin layers are opened and cut. We present a comprehensive offer that allows you to protect the patient in the operating room while ensuring the safety of medical personnel.

## Examination gloves

**easyCARE** **mediCARE**

## Surgical gowns

**a** ALPHAtex

## Sets of surgical drapes and accesories ALPHAtex

adjusted to protect any medical procedure

## Dressing materials

- swabs
- gauze lap sponges
- adhesive tapes
- island dressings
- special purpose dressings
- foil dressings

## Products for sport enthuziasts and physiotherapists

**yellow**  
SPORT

## Surgical sutures

## Suction sets

Pharmacy line  
**vita**health

Specialistic disposable  
medical devices

Surgical  
gloves



### Custom surgical sets



### Custom procedure kits



### Wound drainage

### Basic medical devices

- devices for injection
- devices for infusion and transfusion
- urological devices
- devices for oxygen therapy and many others



### Personal protective equipment

### Medical clothing

- surgical clothing
- shoe covers
- caps and protective masks
- patient clothing



### Anaesthesia products

### Prevention of hospital infections

- patient hygiene
- prevention of surgical site infections
- patient isolation







# Medical gloves

**EXAMINATION GLOVES** are intended for temporary use during medical examinations, diagnostic and therapeutic procedures, for handling medical contaminated material in order to reduce the risk of: transferring dangerous biological material through hands to a patient, acquisition of infections from patients by healthcare workers. Gloves are subject to the restrictive requirements of standards harmonized with the Regulation (EU) 2017/745 concerning medical devices and the Regulation (EU) 2016/425 of the European Parliament and of the Council on personal protective equipment.

**NITRILE GLOVES** are made of synthetic acrylonitrile butadiene rubber (NBR), they are an alternative to latex gloves. They do not contain latex proteins that cause type I allergic reactions, and the content of chemical accelerators is minimized, so they are friendly to the skin. They are characterized by high mechanical strength (also for puncture), chemical and biological resistance (constitute a barrier for viruses and bacteria), flexibility, thanks to which they adjust to the hand, providing the work comfort to the user. Thin walls and textured finger surface enhance grip and guarantee excellent tactile sensitivity.

**LATEX GLOVES** made of natural rubber are recognized as the best barrier against blood-borne pathogens and part of hazardous chemical substances. They are also characterized by high flexibility, providing the work comfort to the user by fitting to the hand like a „second skin”. Latex gloves, due to the natural raw material, are biodegradable. However, they can cause type I allergic reactions at people sensitive to proteins of natural rubber. Powdered gloves usually contain modified maize flour to facilitate glove donning. In the case of powder-free gloves, the inner surface is usually chlorinated or polymer-coated.

**VINYL GLOVES** made of PVC (polyvinyl chloride) are intended for low-risk procedures due to limited mechanical, chemical and biological resistance. The glove material does not cause Type I allergic reactions, only plasticizers can provoke a reaction in sensitized people - phthalates added during production to increase flexibility. ZARYS vinyl gloves are free of harmful phthalates.



## EXAMINATION GLOVES

WWW.ZARYS.COM



DIAGNOSTICS  
NURSING CARE



EMERGENCY  
MEDICAL SERVICES



LABORATORIES



CYTOSTATIC  
WORKSHOPS



STERILISATION  
UNITS



DENTISTRY



CONTACT  
WITH FOOD













HYGIENIC  
AND SANITARY  
FACTORS



PATIENT HYGIENE

## mediCARE nitrile lime green













type	examination, <b>nitrile</b> , non-sterile
external surface	textured fingertips
internal surface	chlorinated
cuff	beaded
colour	lime green
AQL	1.5
classification	<ul style="list-style-type: none"> <li>• class I medical device</li> <li>• personal protective equipment category III</li> </ul>
features	pleasant, calming colour
indication	    
packaging unit/ bulk packaging	50 pcs/ 20x50 pcs
REF	RNBL03xx (xx:XS-XL)
sizes	    



## mediCARE nitrile pink



type	examination, <b>nitrile</b> , non-sterile
external surface	textured fingertips
internal surface	chlorinated
cuff	beaded
colour	dark pink
AQL	1.5
classification	<ul style="list-style-type: none"> <li>• class I medical device</li> <li>• personal protective equipment category III</li> </ul>
features	intense colour
indication	     
packaging unit/ bulk packaging	100 pcs/ 10x100 pcs
REF	RNBM03xx (xx:XS-XL)
sizes	    





type	examination, <b>nitrile</b> , non-sterile
external surface	textured fingertips
internal surface	chlorinated
cuff	beaded
colour	violet blue
AQL	1.0
classification	<ul style="list-style-type: none"> <li>• class I medical device</li> <li>• personal protective equipment category III</li> </ul>
features	antimicrobial
indication	
packaging unit/ bulk packaging	200 pcs/ 10x200 pcs
REF	RNBA08xx (xx: XS-XL)
sizes	<span style="background-color: purple; color: white; padding: 2px 5px;">XS</span> <span style="background-color: pink; color: white; padding: 2px 5px;">S</span> <span style="background-color: orange; color: white; padding: 2px 5px;">M</span> <span style="background-color: green; color: white; padding: 2px 5px;">L</span> <span style="background-color: blue; color: white; padding: 2px 5px;">XL</span>



**INNOVATIVE  
ANTIMICROBIAL  
GLOVE**  
MANUFACTURED IN NON-LEACH TECHNOLOGY

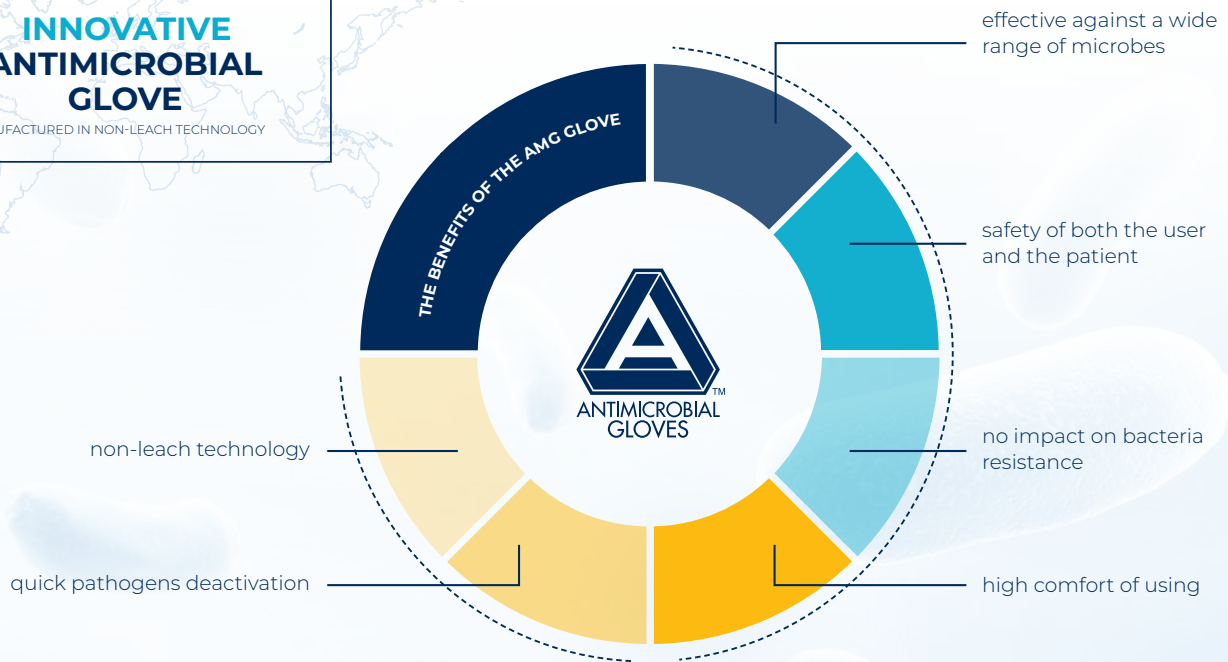

**Goodpac™ Technology**

**INNOVATIVE**  
antimicrobial glove  
manufactured in  
non-leach technology

kills up to  
**99.999%**  
of microbes

provides  
**ACTIVE PROTECTION**  
against infections  
in healthcare

**NON-SENSITIZING**  
on skin





type	examination, <b>nitrile</b> , non-sterile
external surface	textured fingertips
internal surface	chlorinated
cuff	beaded
colour	violet blue
AQL	1.0
classification	<ul style="list-style-type: none"> <li>• class I medical device</li> <li>• personal protective equipment category III</li> </ul>
features	moisturizing and nourishing coating
indication	
packaging unit/ bulk packaging	100 pcs/ 10x100 pcs
REF	RNBH03xx (xx:XS-XL)
sizes	<span style="background-color: #800080; color: white; padding: 2px 5px;">XS</span> <span style="background-color: #FF00FF; color: white; padding: 2px 5px;">S</span> <span style="background-color: #FFA500; color: white; padding: 2px 5px;">M</span> <span style="background-color: #008000; color: white; padding: 2px 5px;">L</span> <span style="background-color: #000080; color: white; padding: 2px 5px;">XL</span>



## Nitrile gloves with moisturizing and nourishing coating



### GLYCERIN

moisturizes, improves skin appearance, smoothens and soothes irritations



### VITAMIN E

natural antioxidant, vitamin of youth - fights off free radicals and prevents wrinkles, moisturizes for a long time



### ALMOND OIL

regenerates, moisturizes, slows the aging process of the skin, smoothens, firms and helps removing dead cells, brighten the skin, soothes irritations and accelerates healing skin lesions, strengthens the hydro-lipid layer of the skin

## DERMATOLOGY SOLUTION FOR SKIN PROBLEMS

- gloves that protect and nourish the hands at the same time, while providing long-lasting hydration











### Anti-wrinkle effects proven in clinical tests\*

\*mediCARE Hydra+ glove presents a better anti-wrinkle effect compared to a traditional nitrile glove with visible reduction of wrinkles from the first day of use with progressive increase in improvement until the end of the tests

## easyCARE nitrile black











type	examination, <b>nitrile</b> , non-sterile
external surface	textured fingertips
internal surface	chlorinated
cuff	beaded
colour	black
AQL	1.0
classification	<ul style="list-style-type: none"> <li>• class I medical device</li> <li>• personal protective equipment category III</li> </ul>
features	masking colour, increased endurance
indication	   
packaging unit/ bulk packaging	100 pcs/ 10x100 pcs
REF	RNBC03xx (xx:XS-XL)
sizes	    



## easyCARE nitrile pink



type	examination, <b>nitrile</b> , non-sterile
external surface	textured fingertips
internal surface	chlorinated
cuff	beaded
colour	light pink
AQL	1.5
classification	<ul style="list-style-type: none"> <li>• class I medical device</li> <li>• personal protective equipment category III</li> </ul>
features	pleasant, calming colour
indication	    
packaging unit/ bulk packaging	100 pcs/ 10x100 pcs
REF	RNBR03xx (xx:XS-L)
sizes	   





type	examination, <b>nitrile</b> , non-sterile
external surface	textured fingertips
internal surface	chlorinated
cuff	beaded
colour	blue
AQL	1.0
classification	<ul style="list-style-type: none"> <li>• class I medical device</li> <li>• personal protective equipment category III</li> </ul>
features	increased tactile sensitivity
indication	
packaging unit/ bulk packaging	100 pcs/ 10x100 pcs 200 pcs/ 10x200 pcs
REF	a'100: RNB-xx-100 (xx:XS-XL) a'200: RNB-xx-200 (xx:XS-XL)
sizes	



# UNIVERSAL GLOVE DISPENSER

for examination gloves

► TYPES OF DISPENSERS:

- SINGLE
- DOUBLE
- TRIPLE
- QUADRUPLE

vertical mounting option



## advantages of the dispensers:



**HYGIENE**

- reduces the contamination risk of the packaging surface (no need to touch)
- coated with antibacterial paint to reduce the bacteria (Escherichia coli, MRSA) multiplication on the dispenser\*  
\*on request



**CUSTOMIZED TO INDIVIDUAL CUSTOMER NEEDS**

- wall mounting on a flat surface vertically or horizontally (equipped with a mounting kit)
- vertically or horizontally mounted on a medical trolley, patient's bed or anaesthetic column (assembly kit on request)



**BETTER ORGANIZATION OF THE WORKPLACE**

- space saving
- improvement of putting on gloves procedure











**UNIVERSALITY**

- vertical or horizontal assembly
- fit to almost every glove box available on the medical market

**easyCARE latex**













type	examination, <b>latex</b> , non-sterile
external surface	textured
internal surface	powdered
cuff	beaded
colour	natural latex
AQL	1.5
classification	<ul style="list-style-type: none"> <li>• class I medical device</li> <li>• personal protective equipment category III</li> </ul>
features	standard latex glove
indication	   
packaging unit/ bulk packaging	100 pcs/ 10x100 pcs
REF	RLP03xx (xx:XS-XL)
sizes	    



**easyCARE latex PF**









type	examination, <b>latex</b> , non-sterile
external surface	textured
internal surface	powder-free, polymer-coated
cuff	beaded
colour	natural latex
AQL	1.5
classification	<ul style="list-style-type: none"> <li>• class I medical device</li> <li>• personal protective equipment category III</li> </ul>
features	easier donning due to inner polymer coating
indication	    
packaging unit/ bulk packaging	100 pcs/ 10x100 pcs
REF	RLB03xx (xx:XS-XL)
sizes	    





## easyCARE vinyl









type	examination, <b>vinyl</b> , non-sterile
external surface	smooth
internal surface	powdered
cuff	beaded
colour	transparent
AQL	1.5
classification	<ul style="list-style-type: none"> <li>• class I medical device</li> <li>• personal protective equipment category III</li> </ul>
indication	 
packaging unit/ bulk packaging	100 pcs/ 10x100 pcs
REF	RWP07xx (xx:XS-XL)
sizes	    



## easyCARE vinyl PF



type	examination, <b>vinyl</b> , non-sterile
external surface	smooth
internal surface	powder-free
cuff	beaded
colour	transparent
AQL	1.5
classification	<ul style="list-style-type: none"> <li>• class I medical device</li> <li>• personal protective equipment category III</li> </ul>
indication	 
packaging unit/ bulk packaging	100 pcs/ 10x100 pcs
REF	RWB07xx (xx:XS-XL)
sizes	    





# Basic medical devices

ZARYS International Group prides itself with a long lasting experience gained in the medical industry being a leading manufacturer and supplier of single use medical devices.

A wide range of products and complex solutions make it possible to successfully respond to our customers' needs and meet their expectations.

High standards of design, production, storing and transportation allow to maintain quality, safety and comfort of use to both the medical personnel and patients.

A wide range of single use products include basic medical devices and those dedicated to specialized procedures.

ZARYS branded products find a wide application in anesthesiology, urology, gynecology, oxygen and fluid therapy and in many other medical specialities. They make it possible to perform medical procedures including patient diagnostics, prophylaxis, treatment and care.



## BASIC DISPOSABLE EQUIPMENT

# dispoFINE

## injection needle, sterile

### features

- needle tube is made of smooth and durable stainless steel
- sheath and hub made of polypropylene
- thin walls assure adequate stream pace
- tip sharpened in three surfaces (back cut)
- bevel type: LB/BL standard long bevel
- surface of needle tube covered with sliding agent (silicone)
- glued needle elements to prevent their separation (glue - epoxy resin)
- hubs coloured in accordance with ISO code allowing fast recognition of needle size
- latex-free, phthalate-free
- non-toxic, non-pyrogenic
- EO sterilized
- packaging: 1 pc./paper-foil

### indication

- device designed for intravenous, intramuscular and hypodermic injections



REF	size	colour	G	intermediate packaging
IN-03X13	0,3 mm x 13 mm	yellow	30	100 pcs
IN-04X19	0,4 mm x 19 mm	medium grey	27	100 pcs
IN-045X12	0,45 mm x 12 mm	brown	26	100 pcs
IN-045X16	0,45 mm x 16 mm	brown	26	100 pcs
IN-045X22	0,45 mm x 22 mm	brown	26	100 pcs
IN-05X16	0,5 mm x 16 mm	orange	25	100 pcs
*IN-05X20	0,5 mm x 20 mm	orange	25	100 pcs
IN-05X25	0,5 mm x 25 mm	orange	25	100 pcs
IN-05X40	0,5 mm x 40 mm	orange	25	100 pcs
IN-06X25	0,6 mm x 25 mm	deep blue	23	100 pcs
IN-06X30	0,6 mm x 30 mm	deep blue	23	100 pcs
IN-06X40	0,6 mm x 40 mm	deep blue	23	100 pcs
IN-07X30	0,7 mm x 30 mm	black	22	100 pcs
IN-07X40	0,7 mm x 40 mm	black	22	100 pcs
*IN-07X50	0,7 mm x 50 mm	black	22	100 pcs

REF	size	colour	G	intermediate packaging
IN-08X25	0,8 mm x 25 mm	deep green	21	100 pcs
IN-08X40	0,8 mm x 40 mm	deep green	21	100 pcs
*IN-08X50	0,8 mm x 50 mm	deep green	21	100 pcs
IN-09X25	0,9 mm x 25 mm	yellow	20	100 pcs
IN-09X40	0,9 mm x 40 mm	yellow	20	100 pcs
IN-11X40	1,1 mm x 40 mm	cream	19	100 pcs
IN-12X40	1,2 mm x 40 mm	pink	18	100 pcs
IN-12X50	1,2 mm x 50 mm	pink	18	100 pcs
IN-16X40	1,6 mm x 40 mm	white	16	100 pcs
IN-18X40	1,8 mm x 40 mm	blue-grey	15	100 pcs
IN-21X40	2,1 mm x 40 mm	pale green	14	100 pcs

 bulk packaging:  
50 x 100 pcs

 \* available  
on request

# dispoGUARD

## safety injection needle, sterile

### features

- safety cover can be activated with one hand and it shields needle immediately after injection
- cover integrated with needle
- tip sharpened in three surfaces (back cut)
- colour coding system for size, marked on hub
- activation of safety mechanism signaled by audible click
- needle is securely closed inside activated safety cover
- latex-free, phthalate-free
- non-toxic, non-pyrogenic
- EO sterilized
- packaging: 1 pc./paper-foil

### indication

- device designed for intravenous, intramuscular and hypodermic injections



REF	size	colour	G	intermediate packaging
INB-03X13	0,3 mm x 13 mm	yellow	30	50 pcs
INB-045X12	0,45 mm x 12 mm	brown	26	50 pcs
INB-05X25	0,5 mm x 25 mm	orange	25	50 pcs
INB-05X40	0,5 mm x 40 mm	orange	25	50 pcs
INB-06X25	0,6 mm x 25 mm	deep blue	23	50 pcs
INB-06X30	0,6 mm x 30 mm	deep blue	23	50 pcs
INB-07X30	0,7 mm x 30 mm	black	22	50 pcs
INB-07X40	0,7 mm x 40 mm	black	22	50 pcs
INB-08X40	0,8 mm x 40 mm	deep green	21	50 pcs
INB-09X40	0,9 mm x 40 mm	yellow	20	50 pcs
INB-11X40	1,1 mm x 40 mm	cream	19	50 pcs
INB-12X40	1,2 mm x 40 mm	pink	18	50 pcs

 bulk packaging:  
50 x 50 pcs

## construction of the syringe

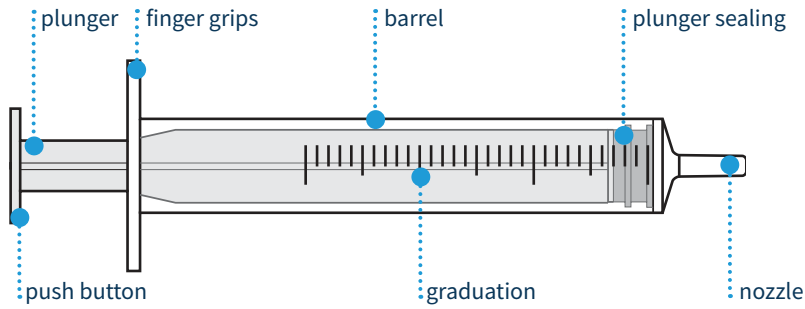

**GET TO KNOW OUR SYRINGES**

### nozzle types:

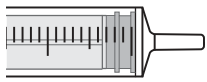

#### luer slip, centric

tip of the syringe is pushed into the hub of the needle or other device (e.g. catheters) and twisted. It allows to remove the connection immediately if necessary

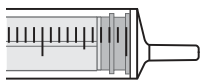

#### luer slip, eccentric

eccentric location of the tip is used in procedures involving the administration of drugs and fluids where closer proximity to skin is necessary

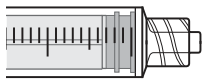

#### luer lock

designed to secure connection between the syringe and the device (needle, tube, catheter, stopcock, etc.). The tip is equipped with thread to screw in the syringe to prevent disconnection

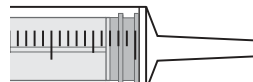

#### catheter tip 90°

type of connection used for rinsing (cleaning) catheters, stomach tubes and feeding purposes

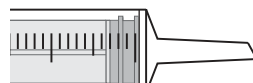

#### catheter tip 45°

nozzle cut at 45 degrees increases the lumen surface

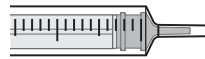

#### insulin and tuberculin syringes

special design of the plunger seal reduces the drug/liquid residues

## duoNEX

### syringe type:

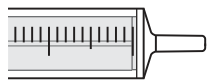

2-part - without plunger sealing

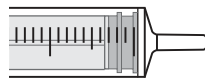

3-part - with plunger sealing

### graduation type:

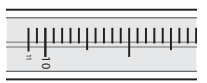

extended graduation

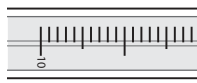

luer slip and luer-lock syringes

regular graduation

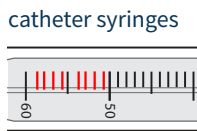

catheter syringes

extended graduation

### package colour and shape code:

luer slip nozzle:



luer slip nozzle:



luer lock nozzle:



amber type

catheter tip:



# duoNEX

## single-use syringe, 2-part, luer, sterile

### features

- white line
- transparent barrel allows full visual control of content
- white contrasting plunger
- luer nozzle centrally located in 2 ml syringe, eccentric in 5, 10, 20 ml syringes
- smooth plunger sliding
- limitation flange securing against accidental removal of plunger
- clear, legible and permanent black graduation facilitating dosage, adequately:
  - every 0,1 ml for capacity of 2 ml
  - every 0,2 ml for capacity of 5 ml
  - every 0,5 ml for capacity of 10 ml
  - every 1 ml for capacity of 20 ml
- extended graduation that includes a 10% extension of the nominal capacity
- name of syringe and manufacturer's logo placed on barrel
- single-use
- non-pyrogenic, non-toxic
- latex-free, phthalate-free
- EO sterilized
- packaging: 1 pc./paper-foil

### indication

- 2-piece syringe for subcutaneous, intramuscular and intravenous infusions intended for drawing up and administering of medicines/liquids to patient and collecting body fluid samples from patient

REF	type	capacity	position of nozzle	intermediate packaging	bulk packaging
002ML-2CZ-B	luer	2 ml	centric	100 pcs	30 x 100 pcs
005ML-2CZ-B	luer	5 ml	eccentric	100 pcs	24 x 100 pcs
010ML-2CZ-B	luer	10 ml	eccentric	100 pcs	16 x 100 pcs
020ML-2CZ-B	luer	20 ml	eccentric	50 pcs	16 x 50 pcs



# dicoNEX SN

## single-use syringe, 3-part, luer, with needle alongside the syringe, sterile

### features

- in set with needle alongside the syringe
- transparent barrel allows full visual control of content, green contrasting plunger
- luer nozzle placed centrally for 2 ml capacity, eccentric for 5, 10, 20, 50 ml capacity
- sealing in the form of double ring on plunger stopper situated on the top of plunger
- smooth plunger sliding thanks to rubber sealing
- limitation flange securing against accidental removal of plunger
- name of syringe and manufacturer's logo placed on barrel
- clear, legible and permanent black graduation facilitating dosage, adequately:
  - every 0,1 ml for capacity of 2 ml
  - every 0,2 ml for capacity of 5 ml (extended to 6 ml)
  - every 0,2 ml for capacity of 10 ml
  - every 0,5 ml for capacity of 20 ml
  - every 1 ml for capacity of 50 ml
- needle tube is made of smooth and durable stainless steel
- needle tip sharpened in three surfaces
- bevel type: LB/BL standard long bevel
- hubs coloured in accordance with ISO code
- non-toxic, non-pyrogenic
- latex-free, phthalate-free

### indication

- 3-piece syringe for subcutaneous, intramuscular and intravenous infusions

REF	type	capacity	position of nozzle	needle size	needle colour	intermediate packaging	bulk packaging
002ML-3CZ-SN	luer	2 ml	centric	0,6mm x 30mm	deep blue	100 pcs	30 x 100 pcs
005ML-3CZ-SN	luer	5 ml	eccentric	0,7mm x 30mm	black	100 pcs	24 x 100 pcs
010ML-3CZ-SN	luer	10 ml	eccentric	0,8mm x 40mm	deep green	100 pcs	16 x 100 pcs
020ML-3CZ-SN	luer	20 ml	eccentric	0,8mm x 40mm	deep green	50 pcs	16 x 50 pcs
050ML-3CZ-SN	luer	50 ml	eccentric	0,8mm x 40mm	deep green	25 pcs	16 x 25 pcs



## dicoNEX

### single-use syringe, 3-part, luer, sterile

#### features

- transparent barrel allows full visual control of content
- green contrasting plunger
- luer nozzle
- sealing in the form of double ring on plunger stopper situated on the top of plunger
- smooth plunger sliding thanks to rubber sealing
- limitation flange securing against accidental removal of plunger
- special design of the 1 ml syringe plunger stopper reduces dead space
- name of syringe and manufacturer's logo placed on barrel
- clear, legible and permanent black graduation facilitating dosage, adequately:
  - every 0,01ml for capacity of 1ml
  - every 0,1 ml for capacity of 2 ml
  - every 0,2 ml for capacity of 5 ml
  - every 0,2 ml for capacity of 10 ml
  - every 0,5 ml for capacity of 20 ml
  - every 1 ml for capacity of 50/60 ml
- single-use, non-pyrogenic, non-toxic
- latex-free, phthalate-free
- EO sterilized
- packaging: 1 pc./paper-foil

#### indication

- 3-piece syringe intended for drawing up and administering of medicines/liquids to patient and collecting body fluid samples from patient

REF	type	capacity	position of nozzle	intermediate packaging	bulk packaging
001ML-3CZ-BL	luer	1 ml	centric	100 pcs	32 x 100 pcs
002ML-3CZ-BL	luer	2 ml	centric	100 pcs	30 x 100 pcs
005ML-3CZ-BL	luer	5 ml	centric	100 pcs	24 x 100 pcs
010ML-3CZ-BL	luer	10 ml	centric	100 pcs	16 x 100 pcs
020ML-3CZ-BL	luer	20 ml	eccentric	50 pcs	16 x 50 pcs
050ML-3CZ-BL	luer	50/60 ml	eccentric	25 pcs	16 x 25 pcs



## dicoNEX

### single-use syringe, 3-part, luer lock, sterile

#### features

- transparent barrel allows full visual control of content
- green contrasting plunger (amber-coloured syringe - white contrasting plunger)
- luer lock nozzle
- sealing in the form of double ring on plunger stopper situated on the top of plunger
- smooth plunger sliding thanks to rubber sealing
- limitation flange securing against accidental removal of plunger
- name of syringe and manufacturer's logo placed on barrel
- clear, legible and permanent black graduation facilitating dosage, adequately:
  - every 0,1 ml for capacity of 2 ml
  - every 0,2 ml for capacity of 5 ml and of 10 ml
  - every 0,5 ml for capacity of 20 ml
  - every 1 ml for capacity of 30 ml and of 50/60 ml
- single-use
- non-pyrogenic, non-toxic
- latex-free, phthalate-free
- EO sterilized
- packaging: 1 pc./paper-foil

#### indication

- 3-piece syringe intended for drawing up and administering of medicines/liquids to patient and collecting body fluid samples from patient
- amber-coloured syringe is intended for drawing up and administering of photosensitive medicines

REF	type	capacity	position of nozzle	colour of plunger	intermediate packaging	bulk packaging
003ML-3CZ-LL-BL	luer lock	3 ml	centric	green	100 pcs	30 x 100 pcs
005ML-3CZ-LL-BL	luer lock	5 ml	centric	green	100 pcs	24 x 100 pcs
010ML-3CZ-LL-BL	luer lock	10 ml	centric	green	100 pcs	16 x 100 pcs
020ML-3CZ-LL-BL	luer lock	20 ml	centric	green	50 pcs	16 x 50 pcs
030ML-3CZ-LL-BL	luer lock	30 ml	centric	green	50 pcs	16 x 50 pcs
050ML-3CZ-LL-BL	luer lock	50/60 ml	centric	green	25 pcs	16 x 25 pcs

#### amber type

050ML-3CZ-LL-B-BL	luer lock	50/60 ml	centric	white	25 pcs	16 x 25 pcs
-------------------	-----------	----------	---------	-------	--------	-------------





# dicoNEX

## single-use catheter syringe, 3-part, sterile

### features

- transparent barrel allows full visual control of content
- green contrasting plunger
- two luer connectors attached
- sealing in the form of double ring on plunger stopper situated on the top of plunger
- smooth plunger sliding thanks to rubber sealing
- limitation flange securing against accidental removal of plunger
- nozzle cut at 90°
- catheter nozzle secured with cap
- name of syringe and manufacturer's logo placed on barrel
- extended graduation
- clear, legible and permanent black graduation facilitating dosage
- graduated every 1 ml
- single-use
- non-pyrogenic
- latex-free, phthalate-free
- EO sterilized
- packaging: 1 pc./paper-foil

### indication

- 3-piece syringe with catheter nozzle
- intended for drawing up and administering of medicines/liquids to patient and collecting body fluid samples from patient

REF	type	capacity	position of nozzle	intermediate packaging
050ML-3CZ-CEW-BL	catheter tip	50/60 ml	centric	25 pcs



bulk packaging:  
16 x 25 pcs



# dicoNEX

## single-use catheter syringe, 3-part, sterile

### features

- 3-piece syringe with centrally located nozzle for catheter
- two luer connectors attached
- made of polypropylene
- transparent barrel allows full visual control of content
- white contrasting plunger
- sealing in the form of double ring on plunger stopper situated on the top of plunger
- smooth plunger sliding thanks to rubber sealing
- limitation flange securing against accidental removal of plunger
- nozzle cut at 45°
- name of syringe and manufacturer's logo placed on barrel
- clear, legible and permanent black graduation facilitating dosage
- graduated every 2 ml
- latex-free, phthalate-free
- single-use
- EO sterilized
- packaging: 1 pc./paper-foil

### indication

- 3-piece syringe with catheter nozzle
- intended for drawing up and administering of medicines/liquids to patient and collecting body fluid samples from patient

REF	type	capacity	position of nozzle	intermediate packaging
100ML-3CZ-CEW-BL	catheter tip	100 ml	centric	25 pcs



bulk packaging:  
4 x 25 pcs



# dicoTUBER

## tuberculin syringe, sterile

### features

- with bypacked needle 0,45 x 13 mm
- made entirely of polypropylene
- white contrasting plunger
- transparent barrel allows full visual control of content
- luer nozzle
- smooth plunger sliding thanks to rubber sealing
- limitation flange securing against accidental removal of plunger
- clear, legible and permanent black graduation every 0,01 ml that allows precise dosing of medicine/liquid
- special design of plunger stopper reduces the residual volume of medicine/liquid
- name of syringe and manufacturer's logo placed on barrel
- single-use
- non-pyrogenic, non-toxic
- latex-free, phthalate-free
- EO sterilized
- packaging: 1 pc./paper-foil

### indication

- 3-piece syringe intended for precise drawing up and administering of medicines/liquids

REF	no. of units	capacity	intermediate packaging
TU-U20-1-BL	20	1 ml	100 pcs



bulk packaging:  
32 x 100 pcs



# dicoSULIN

## insulin syringe, sterile

### features

- with bypacked needle 0,4 x 13 mm
- transparent barrel made of polypropylene allows full visual control of content
- sealing in the form of double ring on plunger stopper situated on the top of plunger
- smooth plunger sliding thanks to rubber sealing
- limitation flange securing against accidental removal of plunger
- special design of plunger stopper reduces the residual volume of medicine/liquid
- clear, legible and permanent black graduation facilitating dosage
- name of syringe and manufacturer's logo placed on barrel
- single-use
- non-pyrogenic, non-toxic
- latex-free, phthalate-free
- EO sterilized
- packaging: 1 pc./paper-foil

### indication

- 3-piece syringe for subcutaneous, intramuscular and intravenous infusions
- for insulin shots

REF	no. of units	capacity	colour of plunger	intermediate packaging
IN-U40-1-BL	40	1 ml	red	100 pcs
IN-U100-1-BL	100	1 ml	orange	100 pcs



bulk packaging:  
32 x 100 pcs



# safeLANCE

## pressure-activated safety lancet, sterile

### features

- easy to use, minimizes unpleasant feelings
- special construction allows lancet tip to be automatically inserted into finger pad and then to be retracted so that needle is not visible before or after puncturing
- correctly matched size of lancet allows you to get optimal amount of blood with minimal patient's pain
- design ensures safety for medical personnel and patient by eliminating accidental puncture and infection
- perfect guidance of lancet needle inside housing reduces vibration, thus decreases patient's pain and prevents damage to skin tissue
- available in two sizes:
  - 23 G, puncture depth 1,8 mm - green, dedicated for women and children
  - 21 G, puncture depth 2,4 mm - pink, dedicated for men
- latex-free, phthalate-free
- single-use
- sterilized by radiation
- packaging: 100 pcs/box

### indication

- capillary blood sampling from fingertip or ear flap for testing, for example, glucose level

REF	size / puncture depth	colour	intermediate packaging
NA-18	23 G / 1,8 mm	green	100 pcs
NA-24	21 G / 2,4 mm	pink	100 pcs



bulk packaging:  
20 x 100 pcs



# dispoSULIN

## insulin pen needle, sterile

### features

- made of polypropylene, polyethylene and stainless steel
- triple-point needle blade allows easy and atraumatic skin penetration
- covering the needle with silicone lubricant reduces resistance during injection
- thin walls of needle ensure easy flow of medicine and the right flow rate
- coloured cap and paper cover of packaging make it easy to quickly recognize size of needle
- available in various sizes, allowing you to adapt to individual needs
- universal, compatible with all pen models
- single-use
- non-pyrogenic, non-toxic
- latex-free, phthalate-free
- EO sterilized
- packaging: 100 pcs/box

### indication

- for subcutaneous injection
- dedicated for use with pre-filled pens (insulin pens)

REF	size	colour	G	intermediate packaging
INP-033X12	0,33 mm x 12 mm	pink	29	100 pcs
INP-030X08	0,30 mm x 8 mm	yellow	30	100 pcs
INP-025X06	0,25 mm x 6 mm	purple	31	100 pcs
INP-025X08	0,25 mm x 8 mm	blue	31	100 pcs



bulk packaging:  
50 x 100 pcs



# side hole needle

## insulin pen needle, sterile

### features

- made of stainless steel
- the needle hub ideally suited for Luer and Luer-Lock (to ensure full tightness of the connection with syringes)
- CE sign comply with PN-EN-ISO 7864
- individual packaging comply with PN-EN 556 and PN-EN 868, type blister- pack coloured cap and paper cover of packaging make it easy to quickly recognize
- single-use
- EO sterilized
- shelf life: 5 years

### indication

- made of high quality materials, using the latest technology, which guarantees its high quality and failure-free, intended usage
- special design needle with a pencil cut with a side hole, designed to withdraw medication from a vial, including vials with a rubber stopper
- needle construction prevents from accidental, unintended production of rubber scrubs, in order to avoid contamination of the drug
- side hole with special cut, placed on the top of the needle enables free dissolution of the drug and limits foaming by directing the fluid directly onto the walls of the vial

REF	size	colour	G	intermediate packaging
HPP-1830	1,2 x 30 mm	pink	18	100 pcs



bulk packaging:  
10 x 100 pcs

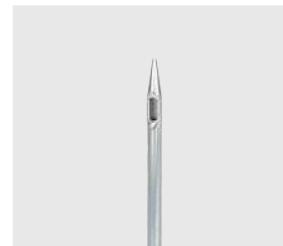

# stomach tube/duodenal tube

sterile

## features

- made of PVC
- made of material that is resistant to bending and kinking due to the appropriate degree of hardness
- atraumatic, soft rounded closed tip
- four lateral eyes with smooth edges
- colour-coded connectors for size recognition, numerical size identification on packaging
- stomach tube is available in 3 lengths: 80 cm, 100 cm, 125 cm and duodenal tube is available in 150 cm length
- latex-free
- single-use
- EO sterilized
- packaging: 1 pc./paper-foil

## indication

- inserted through nose or mouth into stomach or duodenum
- drainage of stomach/intestinal content
- decompression of stomach (air or food evacuation)
- gastric lavage
- taking samples of stomach content
- control of bleeding from the upper section of digestive tract
- evaluation of secretory function
- administration of medicines, fluids and/or food content into stomach or duodenum



REF	size	length	colour	intermediate packaging	bulk packaging
* ZZ-80/CH05	CH 5	800 mm	grey	35 pcs	20 x 35 pcs
* ZZ-80/CH06	CH 6	800 mm	light green	35 pcs	20 x 35 pcs
ZZ-80/CH08	CH 8	800 mm	blue	35 pcs	20 x 35 pcs
ZZ-80/CH10	CH 10	800 mm	black	35 pcs	20 x 35 pcs
ZZ-80/CH12	CH 12	800 mm	white	35 pcs	20 x 35 pcs
ZZ-80/CH14	CH 14	800 mm	green	30 pcs	20 x 30 pcs
ZZ-80/CH16	CH 16	800 mm	orange	30 pcs	20 x 30 pcs
ZZ-80/CH18	CH 18	800 mm	red	25 pcs	20 x 25 pcs
ZZ-80/CH20	CH 20	800 mm	yellow	15 pcs	20 x 15 pcs
ZZ-80/CH22	CH 22	800 mm	purple	15 pcs	20 x 15 pcs
ZZ-80/CH24	CH 24	800 mm	dark blue	15 pcs	20 x 15 pcs
* ZZ-100/CH05	CH 5	1000 mm	grey	30 pcs	20 x 30 pcs
* ZZ-100/CH06	CH 6	1000 mm	light green	30 pcs	20 x 30 pcs
ZZ-100/CH08	CH 8	1000 mm	blue	30 pcs	20 x 30 pcs
ZZ-100/CH10	CH 10	1000 mm	black	30 pcs	20 x 30 pcs
ZZ-100/CH12	CH 12	1000 mm	white	30 pcs	20 x 30 pcs
ZZ-100/CH14	CH 14	1000 mm	green	25 pcs	20 x 25 pcs
ZZ-100/CH16	CH 16	1000 mm	orange	20 pcs	20 x 20 pcs
ZZ-100/CH18	CH 18	1000 mm	red	15 pcs	20 x 15 pcs
ZZ-100/CH20	CH 20	1000 mm	yellow	15 pcs	20 x 15 pcs
ZZ-100/CH22	CH 22	1000 mm	purple	10 pcs	20 x 10 pcs
ZZ-100/CH24	CH 24	1000 mm	dark blue	10 pcs	20 x 10 pcs
* ZZ-125/CH05	CH 5	1250 mm	grey	30 pcs	20 x 30 pcs
* ZZ-125/CH06	CH 6	1250 mm	light green	30 pcs	20 x 30 pcs
ZZ-125/CH08	CH 8	1250 mm	blue	30 pcs	20 x 30 pcs
ZZ-125/CH10	CH 10	1250 mm	black	30 pcs	20 x 30 pcs
ZZ-125/CH12	CH 12	1250 mm	white	20 pcs	20 x 20 pcs
ZZ-125/CH14	CH 14	1250 mm	green	25 pcs	20 x 25 pcs
ZZ-125/CH16	CH 16	1250 mm	orange	20 pcs	20 x 20 pcs
ZZ-125/CH18	CH 18	1250 mm	red	20 pcs	20 x 20 pcs
ZZ-125/CH20	CH 20	1250 mm	yellow	15 pcs	20 x 15 pcs
ZZ-125/CH22	CH 22	1250 mm	purple	10 pcs	20 x 10 pcs
ZZ-125/CH24	CH 24	1250 mm	dark blue	10 pcs	20 x 10 pcs
ZD-150/CH5	CH 5	1500 mm	grey	30 pcs	20 x 30 pcs
ZD-150/CH6	CH 6	1500 mm	light green	30 pcs	20 x 30 pcs
ZD-150/CH8	CH 8	1500 mm	blue	30 pcs	20 x 30 pcs
* ZD-150/CH10	CH 10	1500 mm	black	30 pcs	20 x 30 pcs
* ZD-150/CH12	CH 12	1500 mm	white	30 pcs	20 x 30 pcs
* ZD-150/CH14	CH 14	1500 mm	green	20 pcs	20 x 20 pcs
* ZD-150/CH16	CH 16	1500 mm	orange	15 pcs	20 x 15 pcs
* ZD-150/CH18	CH 18	1500 mm	red	15 pcs	20 x 15 pcs
ZD-150/CH20	CH 20	1500 mm	yellow	10 pcs	20 x 10 pcs
ZD-150/CH22	CH 22	1500 mm	purple	10 pcs	20 x 10 pcs
ZD-150/CH24	CH 24	1500 mm	dark blue	10 pcs	20 x 10 pcs



available on request

# feeding tube graduated, with X-ray contrast

## sterile

### features

- made of soft PVC with a frosted surface, resistant to bending and kinking due to the appropriate degree of hardness
- atraumatic, soft rounded, closed tip facilitates precise insertion of catheter
- two alternate end holes with gently stretched edges
- connector compatible with the conical tip of luer syringe
- integrated stoper allows the tube to be closed tightly
- colour-coded connectors for size recognition, numerical size identification on packaging
- radiopaque line along the entire length of the catheter
- digital depth graduation every 1 cm (from 5 cm to 40 cm)
- length 50 cm
- name of the manufacturer placed on the catheter
- individually packed straight
- latex-free
- phthalate-free
- single-use
- EO sterilized
- shelf life: 5 years
- packaging: 1 pc. / paper-foil

### indication

- device inserted through patient's nose or mouth to perform enteral nutrition

REF	size	length	colour	intermediate packaging
CKS-04-50	CH 4	500 mm	red	100 pcs
CKS-05-50	CH 5	500 mm	grey	100 pcs
CKS-06-50	CH 6	500 mm	pink	100 pcs
CKS-08-50	CH 8	500 mm	pale green	100 pcs
CKS-10-50	CH 10	500 mm	black	100 pcs



bulk packaging:  
10 x 100 pcs

# suction catheter

## sterile

### features

- made of soft and flexible PVC, that is resistant to bending and kinking
- frozen surface prevents the catheter from sticking to the wall of the endotracheal tube
- atraumatic, soft rounded, open tip
- tip with two alternating lateral eyes with smooth edges
- colour-coded connectors for size recognition, numerical size identification on the packaging
- latex-free
- single-use
- EO sterilized
- packaging: 1 pc./paper-foil

### indication

- device designed for suction of secretions from the upper respiratory tract
- recommended for source of suction with its own suction force regulation

REF	size	length	colour	intermediate packaging
CO-B06-40	CH 6	400 mm	light green	50 pcs
CO-B08-40	CH 8	400 mm	blue	50 pcs
CO-B10-40	CH 10	400 mm	black	50 pcs
CO-B12-50	CH 12	500 mm	white	50 pcs
CO-B12-60	CH 12	600 mm	white	50 pcs
CO-B14-50	CH 14	500 mm	green	50 pcs
CO-B14-60	CH 14	600 mm	green	50 pcs
CO-B16-50	CH 16	500 mm	orange	50 pcs
CO-B16-60	CH 16	600 mm	orange	50 pcs
CO-B18-50	CH 18	500 mm	red	50 pcs
CO-B18-60	CH 18	600 mm	red	50 pcs
CO-B20-50	CH 20	500 mm	yellow	50 pcs
CO-B20-60	CH 20	600 mm	yellow	50 pcs
CO-B22-50	CH 22	500 mm	purple	50 pcs
CO-B22-60	CH 22	600 mm	purple	50 pcs



bulk packaging:  
10 x 50 pcs

# suction catheter with vacuum control

## sterile

### features

- made of soft and flexible PVC, that is resistant to bending and kinking
- frozen surface prevents the catheter from sticking to the wall of the endotracheal tube
- full control over the suction
- atraumatic, soft rounded, open tip
- tip with two alternating lateral eyes with smooth edges
- colour-coded connectors for size recognition, numerical size identification on the packaging
- latex-free
- single-use
- EO sterilized
- packaging: 1 pc./paper-foil

### indication

- device designed for suction of secretions from the upper respiratory tract

REF	size	length	colour	intermediate packaging
CO-A06-60	CH 6	600 mm	light green	50 pcs
CO-A08-60	CH 8	600 mm	blue	50 pcs
CO-A10-60	CH 10	600 mm	black	50 pcs
CO-A12-60	CH 12	600 mm	white	50 pcs
CO-A14-60	CH 14	600 mm	green	50 pcs
CO-A16-60	CH 16	600 mm	orange	50 pcs
CO-A18-60	CH 18	600 mm <td red	50 pcs	



bulk packaging:  
10 x 50 pcs

# suction catheter with frozen surface

## phthalate-free, sterile

### features

- made of soft and flexible PVC, that is resistant to bending and kinking
- frozen surface enabling easy insertion
- atraumatic, soft rounded, open tip
- tip with two opposite lateral eyes with smooth edges
- colour-coded connectors for size recognition, numerical size identification on the packaging
- single-use
- latex-free, phthalate-free
- EO sterilized
- packaging: 1 pc./paper-foil

### indication

- device designed for suction of secretions from the upper respiratory tract
- recommended for source of suction with its own suction force regulation

REF	size	length	colour	intermediate packaging
CO-BF-ZP-B06-40	CH 6	400 mm	light green	50 pcs
CO-BF-ZP-B06-60	CH 6	600 mm	light green	50 pcs
CO-BF-ZP-B08-40	CH 8	400 mm	blue	50 pcs
CO-BF-ZP-B08-60	CH 8	600 mm	blue	50 pcs
CO-BF-ZP-B10-40	CH 10	400 mm	black	50 pcs
CO-BF-ZP-B10-60	CH 10	600 mm	black	50 pcs
CO-BF-ZP-B12-60	CH 12	600 mm	white	50 pcs
CO-BF-ZP-B14-60	CH 14	600 mm	green	50 pcs
CO-BF-ZP-B16-60	CH 16	600 mm	orange	50 pcs
CO-BF-ZP-B18-60	CH 18	600 mm	red	50 pcs
CO-BF-ZP-B20-60	CH 20	600 mm	yellow	50 pcs
CO-BF-ZP-B22-60	CH 22	600 mm	purple	50 pcs
CO-BF-ZP-B24-60	CH 24	600 mm	dark blue	50 pcs



bulk packaging:  
10 x 50 pcs

# vaginal speculum

cusco type, sterile

## features

- both blades made of transparent polystyrene
- locking bolt made of polyethylene
- blades position blocked by a quarter turn of the locking bolt (without screwing in the bolt)
- perfectly smooth and streamlined edges
- colour coded bolts depending on the size
- single-use
- latex-free, phthalate-free
- EO sterilized
- packaging: 1 pc./foil

## indication

- device designed for gynecological examination of the cervix and vagina

REF	width	colour	size
WG-XXS	16 mm	yellow	XXS
WG-XS	20 mm	white	XS
WG-S	24 mm	blue	S
WG-M	26 mm	red	M
WG-L	30 mm	green	L
WG-XL	34 mm	black	XL



bulk packaging:  
100 pcs



# dicoSPIKE

withdrawal cannula, sterile

## features

- easy to use, ergonomic shape
- body with knurled surface for a secure grip
- sharp receiving spike enabling tight and safe connection with containers of different capacity
- receiving spike groove guarantees complete emptying of the container
- hermetic self-locking cap securing the connector against contamination
- available in version with air filter and in version with air and particle filter
- air filter protects against microbiological contamination and against harmful aerosols
- particle filter is an effective barrier to protect drugs and liquids from contamination
- female luer lock connector compatible with products with either male or female luer lock
- free of latex, PVC and phthalates
- non-pyrogenic
- single-use
- EO sterilized
- packaging: 1 pc./ paper-foil

## indication

- device for needle-free dissolving and / or withdrawing drugs from multi-dose packages (bottles, vials, etc.) - in both directions
- dicoSPIKE Chemo model is designed for medicines releasing dangerous aerosols such as cytostatics

REF	cap colour	air filter	particle filter	purpose	intermediate packaging
PPLZ	green	0,1 µm	-	standard medicines	100 pcs
PPLN	blue	0,1 µm	5 µm	standard medicines	100 pcs
PPLC	red	0,1 µm	5 µm	cytostatics	100 pcs



bulk packaging:  
10 x 100 pcs





## cervical brush

standard, sterile

### features

- straight shape enables obtaining samples from the cervical canal
- soft bristle tips to prevent irritation
- optimal outreach thanks to the long handle
- single-use
- latex-free, phthalate-free
- EO sterilized
- packaging: 1 pc./paper-foil

### indication

- device designed for obtaining cell samples from the cervix, cervical canal and transformation zone in smear tests

REF	type	intermediate packaging
SC-001	standard	100 pcs



bulk packaging:  
10 x 100 pcs



## cervical brush

special, sterile

### features

- broom type enables obtaining samples from the cervix, cervical canal and transformation zone
- soft bristle tips enables precise collection of material for examination
- made entirely of polyethylene
- optimal outreach thanks to the long handle
- single-use
- latex-free, phthalate-free
- EO sterilized
- packaging: 1 pc./paper-foil

### indication

- device designed for obtaining cell samples from the cervix, cervical canal and transformation zone in smear tests

REF	type	intermediate packaging
SC-002	special	100 pcs



bulk packaging:  
10 x 100 pcs

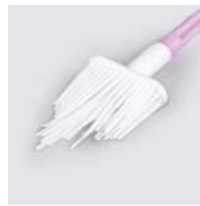

## umbilical cord clamp

sterile

### features

- made of polypropylene
- safe clamping teeth with rounded edges do not cut the umbilical cord
- serrated clamping surface of the arms stabilize the clamp on the umbilical cord, after closing it is not possible to open the clamp again
- double lock catch prevents accidental opening
- universal size
- single-use
- non-pyrogenic
- latex-free, phthalate-free
- EO sterilized
- packaging: 1 pc./paper-foil

### indication

- device is designed for clamping the umbilical cord of a newborn in a labour ward in order to close the lumen of the umbilical blood vessels after cutting it off of the placenta

REF	size	colour	intermediate packaging
ZDPB	universal	white	50 pcs



bulk packaging:  
50 x 50 pcs





## INFUSION THERAPY

WWW.ZARYS.COM



# SANViflon

## I.V. cannula, sterile

### features

- needle (stylet) made of stainless steel with back-cut blade
- cannula catheter made of Teflon (FEP), equipped with 4 radiopaque lines
- cannula equipped with wings and hand-closed cap of the upper port colour coded according to size
- handle that allows you to insert with one hand
- valve that prevents blood leakage to outside after inserting the cannula into the vessel
- flashback chamber secured with a luer lock cap
- available in various sizes from 14 G to 26 G
- single-use
- latex-free
- phthalate-free
- EO sterilized
- packaging: 1 pc. – hard blister (PVC + lacquered paper) with a colour print in accordance with the colour identification of the size

### indication

for cannulation of intravenous, peripheral vessels to:

- multiple injections of intravenous drugs
- intravenous infusion of solutions and parenteral nutrition suitable for peripheral veins
- maintain the patient's hydration and / or reduce dehydration if the patient is unable to take sufficient fluid orally
- blood transfusions and blood-like preparations
- ensuring vascular access in the event of the need for rapid drug delivery, especially during diagnostic and therapeutic procedures



REF	size [G]	size [mm]	colour	flow rate [ml/min]	intermediate packaging
KDF-06-19	26 x 3/4"	0,6 x 19	violet	17	100 pcs
KDF-07-19	24 x 3/4"	0,7 x 19	yellow	23	100 pcs
KDF-09-25	22 x 1"	0,9 x 25	blue	36	100 pcs
KDF-11-32	20 x 1 1/4"	1,1 x 32	pink	56	100 pcs
KDF-13-45	18 x 1 3/4"	1,3 x 45	green	90	100 pcs
KDF-15-45	17 x 1 3/4"	1,5 x 45	white	142	100 pcs
KDF-17-45	16 x 1 3/4"	1,7 x 45	grey	200	100 pcs
KDF-20-45	14 x 1 3/4"	2,0 x 45	orange	305	100 pcs



bulk packaging:  
10 x 100 pcs

# SANViflon S

## I.V. cannula without port, sterile

### features

- needle (stylet) made of stainless steel with back-cut blade
- cannula catheter made of Teflon (FEP), equipped with 4 radiopaque lines
- cannula equipped with coloured fixing wings, without upper port
- handle that allows you to insert with one hand
- valve that prevents blood leakage to outside after inserting the cannula into the vessel
- flashback chamber secured with a luer lock cap
- available in two sizes: 24 G and 26 G
- single-use
- latex-free
- phthalate-free
- EO sterilized
- packaging: 1 pc. – hard blister (PVC + lacquered paper) with a colour print in accordance with the colour identification of the size

### indication

for cannulation of intravenous, peripheral vessels to:

- multiple injections of intravenous drugs
- intravenous infusion of solutions
- maintain the patient's hydration and / or reduce dehydration if the patient is unable to take sufficient fluid orally
- ensuring vascular access in the event of the need for rapid drug delivery, especially during diagnostic and therapeutic procedures



REF	size [G]	size [mm]	colour	flow rate [ml/min]	intermediate packaging
KDFS-06-19	26 x 3/4"	0,6 x 19	violet	17	100 pcs
KDFS-07-19	24 x 3/4"	0,7 x 19	yellow	23	100 pcs



bulk packaging:  
10 x 100 pcs

# easyFLOW IS

## infusion set, sterile

### features

- 2-way sharp closure-piercing device of the drip chamber with anti-slip surface that guarantees tight and reliable connection with fluid containers/bags
- air inlet with anti-bacterial filter and coloured (blue) flap
- pliable drip chamber, size 6 cm, equipped with additional pressure wings to facilitate insertion into containers with liquids
- dropper: 20 drops = 1 ml +/- 0,1 ml
- fluid filter protecting against larger particles with pore size 15 µm
- min. 150 cm-long, soft, flexible tubing with luer lock conical fitting
- precise safe flow regulator with integrated holder for the closure-piercing device and with hook for securing the tubing
- name of the manufacturer placed on the flow regulator
- both tips of the device additionally secured with protective caps
- device available in a version containing phthalates and without phthalates
- single-use
- non-pyrogenic, non-toxic
- latex-free
- EO sterilized
- packaging: 1 pc./paper-foil with a coloured code (blue) identifying the device

### indication

- device for fluid transfer in infusion therapy

REF	version
IS	with phthalates
IS-BF	without phthalates



bulk packaging:  
250 pcs



# easyFLOW IS ECO

## infusion set, sterile

### features

- made of high quality materials
- 2-way sharp closure-piercing device of the drip chamber that guarantees tight and reliable connection with fluid containers
- air inlet with anti-bacterial filter and colored (blue) flap
- pliable drip chamber, size 4cm
- dropper: 20 drops = 1 ml +/- 0.1 ml
- fluid filter protecting against larger particles with pore size 15 µm
- min. 150 cm-long, soft, flexible tubing
- universal luer lock conical fitting
- precise safe flow regulator
- both tips of the device additionally secured with protective caps
- latex-free
- device available in a version containing phthalates and without phthalates
- packaging: 1pc./foil bag
- EO sterilized
- single-use

### indication

- device for fluid transfer in infusion therapy

REF	version
IS-E	with phthalates
IS-BF-E	without phthalates



bulk packaging:  
400 pcs



# easyFLOW LINE

## extension tube for infusion pump, sterile

### features

- tubing made of PVC
- device available in a transparent and amber version for photosensitive medicines
- diameter of the tubing - outer: 2,4 mm; inner: 1,24 mm
- luer lock fitting - male and female
- single-use
- latex-free, phthalate-free
- non-pyrogenic, non-toxic
- EO sterilized
- packaging: 1 pc./paper-foil

### indication

- device used to extend infusion line

REF	colour of tube	length	intermediate packaging
P450-BF	transparent	45 cm	50 pcs
P1500-BF	transparent	150 cm	50 pcs
PB1500-BF	amber	150 cm	50 pcs



bulk packaging:  
24 x 50 pcs



# easyFLOW TS

## transfusion set, sterile

### features

- 2-way sharp closure-piercing device of the drip chamber with anti-slip surface that guarantees tight and reliable connection with containers/bags
- air inlet with anti-bacterial filter and a coloured (red) flap
- pliable drip chamber
- dropper: 20 drops = 1 ml +/- 0,1 ml
- special blood filter with large area, pore size 200 µm
- min. 150 cm-long, soft, flexible tubing
- universal luer lock fitting at the end of tubing
- precise safe flow regulator with integrated holder for the closure-piercing device and with hook for securing the tubing
- name of the manufacturer placed on the flow regulator
- both tips of the device additionally secured with protective caps
- device available in a version containing phthalates and without phthalates
- single-use
- non-pyrogenic, non-toxic
- latex-free
- EO sterilized
- packaging: 1 pc./paper-foil with a coloured code (red) identifying the device

### indication

- device used for the administration of blood and blood products

REF	version
TS	with phthalates
TS-BF	without phthalates



bulk packaging:  
250 pcs



## 3-way stopcock

### sterile

#### features

- made of polycarbonate
- transparent housing
- clear optical identifier of open/close position (marked flow directions) operating in 360 degrees
- consistent, straight flow channels and an optimal internal diameter ensure correct pressure measurement
- rotating male luer lock
- all inlets protected with caps
- resistant to lipids
- latex-free, phthalate-free
- single-use
- non-pyrogenic, non-toxic
- EO sterilized
- packaging: 1 pc./paper-foil

#### indication

- device designed for managing the flow of infusion fluids during administration
- enables switching the infusion flow path
- for blood pressure monitoring
- for direct medicine/fluid supply

REF	colour	intermediate packaging
KT-002	blue	50 pcs



bulk packaging:  
20 x 50 pcs



## 3-way stopcock with extension tube

### sterile

#### features

- three-way stopcock with an extension tube of various lengths (from 7 cm to 100 cm)
- transparent housing
- clear optical identifier of open/close position (marked flow directions)
- three-way stopcock made of polycarbonate, extension tube made of PVC
- all inlets protected with caps
- resistant to lipids
- latex-free, phthalate-free
- single-use
- non-pyrogenic, non-toxic
- EO sterilized
- packaging: 1 pc./paper-foil

#### indication

- device designed for managing the flow of infusion fluids during administration
- enables switching the infusion flow path
- for blood pressure monitoring
- for direct medicine/fluid supply

REF	length of tube	intermediate packaging
KTP-7	7 cm	50 pcs
KTP-10	10 cm	50 pcs
KTP-25	25 cm	50 pcs
KTP-50	50 cm	50 pcs
KTP-75	75 cm	50 pcs
KTP-100	100 cm	50 pcs



bulk packaging:  
20 x 50 pcs



# needle-free valve

## sterile

### features

- body made of transparent material - polycarbonate
- high-quality silicone membrane allows multiple port injections
- flat injection surface - smooth and evenly ended port membrane that facilitates disinfection
- metal-free, suitable for MRI examination
- male connector of the transparent port is secured with a cap allowing for aseptic removal of the item from the packaging
- may be used for 7 days or up to 350 activations
- priming capacity: 0,09 ml
- high flow rate: 350 ml/min
- withstands injection fluid pressure of 3 bars (44 PSI)
- withstands back pressure of 2 bars (29 PSI)
- latex-free, phthalate-free
- EO sterilized
- packaging: 1 pc./paper-foil

### indication

- intended for closing infusion ports
- device intended for multiple, needle-free injections (liquid drug administration, blood sample taking)
- protects infusion lines from contamination and infection during infusion therapy
- does not require using safety caps
- dedicated for standard luer and luer lock connectors

REF	colour	intermediate packaging
PB-N	blue	100 pcs
PB-T	transparent	100 pcs



bulk packaging:  
20 x 100 pcs



# cannula stopper

## sterile

### features

- precisely and safely closes standard ports
- luer lock stopper has only one male tip
- combi stopper with male and female tip especially dedicated for securing luer lock fitting in infusion and transfusion sets
- single-use
- non-pyrogenic
- latex-free, phthalate-free
- EO sterilized
- packaging: 1 pc./paper-foil

### indication

- as a stopper of intravenous cannulas, ports and catheters
- intended to be used in combination with other devices during infusion therapy, protecting against the outflow of blood through the cannula and protecting against contamination and infection

REF	type	intermediate packaging	bulk packaging
KDKLL	luer lock	250 pcs	10 x 250 pcs
KDKC	combi	100 pcs	50 x 100 pcs





## UROLOGICAL CATHETERS AND URINE BAGS

[WWW.ZARYS.COM](http://WWW.ZARYS.COM)





# foley catheter

## 2-way, silicone-coated latex, sterile

### features

- made of soft and flexible latex, that is resistant to bending and kinking
- atraumatic, soft rounded, special tip facilitating insertion of the catheter to the bladder
- tip with two lateral eyes with smooth edges
- universal urine drainage port of the catheter fits into standard connectors in urine bags
- silicone-coated surface that allows atraumatic insertion of the catheter
- easy to fill and to empty, tear-resistant balloon of various capacities
- plastic or rubber valve to ensure balloon tightness
- CH 6, CH 8, CH 10 size has a guide to facilitate catheterization
- contains latex, does not contain phthalates
- single-use
- EO sterilized
- packaging: 1 pc./double packaging: internal- foil, external- paper-foil

### indication

- to drain urine from the bladder

### with plastic valve

REF	length	balloon	size	colour	intermediate packaging
CFNL-2D-06-03-P	270 mm	3 ml	CH 6	light green	10 pcs
CFNL-2D-08-05-P	270 mm	3-5 ml	CH 8	blue	10 pcs
CFNL-2D-10-05-P	270 mm	3-5 ml	CH 10	black	10 pcs
CFNL-2D-12-10-P	400 mm	5-10 ml	CH 12	white	10 pcs
CFNL-2D-14-10-P	400 mm	5-10 ml	CH 14	green	10 pcs
CFNL-2D-16-10-P	400 mm	5-10 ml	CH 16	orange	10 pcs
CFNL-2D-18-10-P	400 mm	5-10 ml	CH 18	red	10 pcs
CFNL-2D-20-10-P	400 mm	5-10 ml	CH 20	yellow	10 pcs
CFNL-2D-22-10-P	400 mm	5-10 ml	CH 22	purple	10 pcs
CFNL-2D-24-10-P	400 mm	5-10 ml	CH 24	dark blue	10 pcs
CFNL-2D-12-30-P	400 mm	30 ml	CH 12	white	10 pcs
CFNL-2D-26-30-P	400 mm	30 ml	CH 26	pink	10 pcs
CFNL-2D-28-30-P	400 mm	30 ml	CH 28	brown	10 pcs
CFNL-2D-30-30-P	400 mm	30 ml	CH 30	grey	10 pcs
CFNL-2D-14-50-P	400 mm	30-50 ml	CH 14	green	10 pcs
CFNL-2D-16-50-P	400 mm	30-50 ml	CH 16	orange	10 pcs
CFNL-2D-18-50-P	400 mm	30-50 ml	CH 18	red	10 pcs
CFNL-2D-20-50-P	400 mm	30-50 ml	CH 20	yellow	10 szt.
CFNL-2D-22-50-P	400 mm	30-50 ml	CH 22	purple	10 pcs
CFNL-2D-24-50-P	400 mm	30-50 ml	CH 24	dark blue	10 pcs
CFNL-2D-26-50-P	400 mm	30-50 ml	CH 26	pink	10 pcs
CFNL-2D-28-50-P	400 mm	30-50 ml	CH 28	brown	10 pcs
CFNL-2D-30-50-P	400 mm	30-50 ml	CH 30	grey	10 pcs

### with rubber valve

REF	length	balloon	size	colour	intermediate packaging
CFNL-2D-06-03-L	270 mm	3 ml	CH 6	light green	10 pcs
CFNL-2D-08-05-L	270 mm	3-5 ml	CH 8	blue	10 pcs
CFNL-2D-10-05-L	270 mm	3-5 ml	CH 10	black	10 pcs
CFNL-2D-12-10-L	400 mm	5-10 ml	CH 12	white	10 pcs
CFNL-2D-14-10-L	400 mm	5-10 ml	CH 14	green	10 pcs
CFNL-2D-16-10-L	400 mm	5-10 ml	CH 16	orange	10 pcs
CFNL-2D-18-10-L	400 mm	5-10 ml	CH 18	red	10 pcs
CFNL-2D-20-10-L	400 mm	5-10 ml	CH 20	yellow	10 pcs
CFNL-2D-22-10-L	400 mm	5-10 ml	CH 22	purple	10 pcs
CFNL-2D-24-10-L	400 mm	5-10 ml	CH 24	dark blue	10 pcs
CFNL-2D-26-10-L	400 mm	5-10 ml	CH 26	pink	10 pcs
CFNL-2D-16-30-L	400 mm	30 ml	CH 16	orange	10 pcs
CFNL-2D-18-30-L	400 mm	30 ml	CH 18	red	10 pcs
CFNL-2D-20-30-L	400 mm	30 ml	CH 20	yellow	10 pcs
CFNL-2D-22-30-L	400 mm	30 ml	CH 22	purple	10 pcs
CFNL-2D-24-30-L	400 mm	30 ml	CH 24	dark blue	10 pcs
CFNL-2D-26-30-L	400 mm	30 ml	CH 26	pink	10 pcs

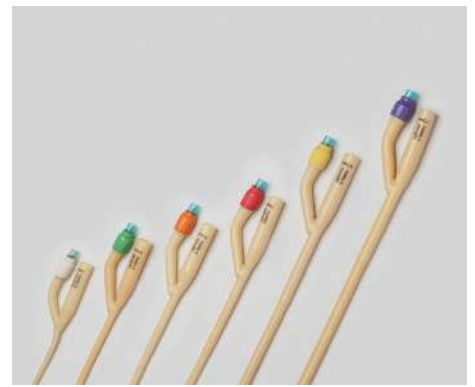

bulk packaging:  
40 x 10 pcs



bulk packaging:  
50 x 10 pcs

# foley catheter

## 3-way, silicone-coated latex, sterile

### features

- made of soft and flexible latex, that is resistant to bending and kinking
- universal urine drainage port of the catheter fits into standard connectors in urine bags
- additional inlet for flushing out the bladder
- atraumatic, soft rounded, special tip facilitating insertion of the catheter to the bladder
- tip with two lateral eyes with smooth edges
- silicone-coated surface that allows atraumatic insertion of the catheter
- easy to fill and to empty, tear-resistant balloon
- plastic valve to ensure balloon tightness
- contains latex, does not contain phthalates
- single-use
- EO sterilized
- packaging: 1 pc./double packaging: internal- foil, external- paper-foil

### indication

- to drain urine from the bladder

REF	length	balloon	size	colour	intermediate packaging
CFNL-3D-16-30-P	400 mm	30 ml	CH 16	orange	10 pcs
CFNL-3D-18-30-P	400 mm	30 ml	CH 18	red	10 pcs
CFNL-3D-20-30-P	400 mm	30 ml	CH 20	yellow	10 pcs
CFNL-3D-22-30-P	400 mm	30 ml	CH 22	purple	10 pcs
CFNL-3D-24-30-P	400 mm	30 ml	CH 24	dark blue	10 pcs
CFNL-3D-26-30-P	400 mm	30 ml	CH 26	pink	10 pcs



bulk packaging:  
40 x 10 pcs

# foley catheter

## 2-way, 100% silicone, sterile

### features

- made of soft and flexible silicone, that reduces the allergic reaction of the mucous membranes and increases the patient's comfort
- atraumatic, soft rounded, special tip facilitating insertion of the catheter to the bladder
- tip with two lateral eyes with smooth edges
- universal urine drainage port of the catheter fits into standard connectors in urine bags
- radiopaque line along the entire length of the catheter
- easy to fill and to empty, tear-resistant balloon of various capacities
- plastic valve to ensure balloon tightness
- CH 6, CH 8, CH 10 size has a nylon guide to facilitate catheterization
- available in version with 10 ml sterile water pre-filled syringe with 10% glycerin to seal the balloon
- separately packed Catheter Spigot inside the packaging
- latex-free, phthalate-free
- single-use
- EO sterilized
- packaging: 1 pc./double packaging: internal- foil, external- paper-foil
- intermediate packaging: 10 pcs for REF: CFNS-2D-XX-XX-P, 5 pcs for REF: CFNSG-2D-XX-XX-P
- bulk packaging: 40 x 10 pcs for REF: CFNS-2D-XX-XX-P, 50 x 5 pcs for REF: CFNSG-2D-XX-XX-P

### indication

- to drain urine from the bladder
- recommended for patients with blood clots or sediment in their urine



REF	intermediate packaging	REF with pre-filled syringe	intermediate packaging	length	balloon	size	colour
* CFNS-2D-06-03-P	10 pcs	CFNSG-2D-06-03-P	5 pcs	310 mm	3 ml	CH 6	pink
* CFNS-2D-08-05-P	10 pcs	CFNSG-2D-08-05-P	5 pcs	310 mm	3-5 ml	CH 8	black
* CFNS-2D-10-05-P	10 pcs	CFNSG-2D-10-05-P	5 pcs	310 mm	3-5 ml	CH 10	grey
* CFNS-2D-12-10-P	10 pcs	CFNSG-2D-12-10-P	5 pcs	400 mm	5-10 ml	CH 12	white
* CFNS-2D-14-10-P	10 pcs	CFNSG-2D-14-10-P	5 pcs	400 mm	5-10 ml	CH 14	green
* CFNS-2D-16-10-P	10 pcs	CFNSG-2D-16-10-P	5 pcs	400 mm	5-10 ml	CH 16	orange
* CFNS-2D-18-10-P	10 pcs	CFNSG-2D-18-10-P	5 pcs	400 mm	5-10 ml	CH 18	red
* CFNS-2D-20-10-P	10 pcs	CFNSG-2D-20-10-P	5 pcs	400 mm	5-10 ml	CH 20	yellow
* CFNS-2D-22-10-P	10 pcs	CFNSG-2D-22-10-P	5 pcs	400 mm	5-10 ml	CH 22	purple
* CFNS-2D-24-10-P	10 pcs	CFNSG-2D-24-10-P	5 pcs	400 mm	5-10 ml	CH 24	dark blue



bulk packaging:  
50 x 5 pcs



bulk packaging:  
\*40 x 10 pcs

# foley catheter

## 3-way, 100% silicone, sterile

### features

- made of soft and flexible silicone, that reduces the allergic reaction of the mucous membranes and increases the patient's comfort
- universal urine drainage port of the catheter fits into standard connectors in urine bags
- additional inlet for flushing out the bladder
- atraumatic, soft rounded, special tip facilitating insertion of the catheter to the bladder
- tip with two lateral eyes with smooth edges
- radiopaque line along the entire length of the catheter
- easy to fill and to empty, tear-resistant balloon
- plastic valve to ensure balloon tightness
- separately packed Catheter Spigot inside the packaging
- latex-free, phthalate-free
- single-use
- EO sterilized
- packaging: 1 pc./double packaging: internal- foil, external- paper-foil

### indication

- to drain urine from the bladder
- recommended for patients with blood clots or sediment in their urine

REF	length	balloon	size	colour	intermediate packaging
CFNS-3D-16-30-P	400 mm	30 ml	CH 16	orange	10 pcs
CFNS-3D-18-30-P	400 mm	30 ml	CH 18	red	10 pcs
CFNS-3D-20-30-P	400 mm	30 ml	CH 20	yellow	10 pcs
CFNS-3D-22-30-P	400 mm	30 ml	CH 22	purple	10 pcs
CFNS-3D-24-30-P	400 mm	30 ml	CH 24	dark blue	10 pcs



bulk packaging:  
40 x 10 pcs

# foley catheter

## 2-way with tiemann tip, silicone-coated latex, sterile

### features

- made of soft and flexible latex, that is resistant to bending and kinking
- universal urine drainage port of the catheter fits into standard connectors in urine bags
- angled tip makes it easier to overcome obstacles in the urinary tract
- tip with two lateral eyes with smooth edges
- silicone-coated surface that allows atraumatic insertion of the catheter
- easy to fill and to empty, tear-resistant balloon
- plastic valve to ensure balloon tightness
- contains latex, does not contain phthalates
- single-use
- EO sterilized
- packaging: 1 pc./double packaging: internal- foil, external- paper-foil

### indication

- to drain urine from the bladder in the case of a narrowed urethra

REF	length	balloon	size	colour	intermediate packaging
CFTL-2D-12-10-P	400 mm	5-10 ml	CH 12	white	10 pcs
CFTL-2D-14-10-P	400 mm	5-10 ml	CH 14	green	10 pcs
CFTL-2D-16-10-P	400 mm	5-10 ml	CH 16	orange	10 pcs
CFTL-2D-18-10-P	400 mm	5-10 ml	CH 18	red	10 pcs
CFTL-2D-20-10-P	400 mm	5-10 ml	CH 20	yellow	10 pcs
CFTL-2D-22-10-P	400 mm	5-10 ml	CH 22	purple	10 pcs
CFTL-2D-24-10-P	400 mm	5-10 ml	CH 24	dark blue	10 pcs
CFTL-2D-12-30-P	400 mm	30 ml	CH 12	white	10 pcs
CFTL-2D-14-30-P	400 mm	30 ml	CH 14	green	10 pcs
CFTL-2D-16-30-P	400 mm	30 ml	CH 16	orange	10 pcs
CFTL-2D-18-30-P	400 mm	30 ml	CH 18	red	10 pcs
CFTL-2D-20-30-P	400 mm	30 ml	CH 20	yellow	10 pcs



bulk packaging:  
40 x 10 pcs

# pezzer catheter

silicone-coated latex, sterile

## features

- made of soft and flexible silicone-coated latex, resistant to bending and kinking
- atraumatic, soft rounded, special tip facilitating insertion of the catheter to the bladder
- tip with three lateral eyes with smooth edges
- contains latex, does not contain phthalates
- single-use
- EO sterilized
- packaging: 1 pc./double packaging: internal- foil, external- paper-foil

## indication

- to secure proper urinary drainage directly from the bladder or kidney in patients after surgical procedures
- introduced by the surgical wound, it is used for permanent urinary drainage, facilitating wound healing

REF	length	size	intermediate packaging
CP-12-40	400 mm	CH 12	10 pcs
CP-14-40	400 mm	CH 14	10 pcs
CP-16-40	400 mm	CH 16	10 pcs
CP-18-40	400 mm	CH 18	10 pcs
CP-20-40	400 mm	CH 20	10 pcs
CP-22-40	400 mm	CH 22	10 pcs
CP-24-40	400 mm	CH 24	10 pcs
CP-26-40	400 mm	CH 26	10 pcs
CP-28-40	400 mm	CH 28	10 pcs
CP-30-40	400 mm	CH 30	10 pcs
CP-32-40	400 mm	CH 32	10 pcs
CP-34-40	400 mm	CH 34	10 pcs
CP-36-40	400 mm	CH 36	10 pcs
CP-38-40	400 mm	CH 38	10 pcs
CP-40-40	400 mm	CH 40	10 pcs



bulk packaging:  
40 x 10 pcs



# nelaton catheter

sterile

## features

- made of soft and flexible PVC, that is resistant to bending and kinking
- atraumatic, soft rounded, special tip facilitating insertion of the catheter to the bladder
- tip with two lateral eyes with smooth edges
- transparent tube allowing visual inspection of excreted urine
- colour-coded connectors for size recognition, numerical size identification on the packaging
- single-use
- latex-free, phthalate-free
- EO sterilized
- packaging: 1 pc./paper-foil

## indication

- to drain urine from the bladder

REF	length	size	colour	intermediate packaging
CN-06-40	400 mm	CH 6	light green	50 pcs
CN-08-40	400 mm	CH 8	blue	50 pcs
CN-10-40	400 mm	CH 10	black	50 pcs
CN-12-40	400 mm	CH 12	white	50 pcs
CN-14-40	400 mm	CH 14	green	50 pcs
CN-16-40	400 mm	CH 16	orange	50 pcs
CN-18-40	400 mm	CH 18	red	50 pcs
CN-20-40	400 mm	CH 20	yellow	50 pcs
CN-22-40	400 mm	CH 22	purple	50 pcs
CN-24-40	400 mm	CH 24	dark blue	50 pcs



bulk packaging:  
10 x 50 pcs



# tiemann catheter

sterile

## features

- made of soft and flexible PVC, that is resistant to bending and kinking
- atraumatic, soft rounded, special tip facilitating insertion of the catheter to the bladder
- tip with two lateral eyes with smooth edges
- cone-shaped angled tip, bent at an angle of 45°
- transparent tube allowing visual inspection of excreted urine
- colour-coded connectors for size recognition, numerical size identification on the packaging
- single-use
- latex-free
- EO sterilized
- packaging: 1 pc./paper-foil

## indication

- to drain urine from the bladder in the case of a narrowed urethra

REF	length	size	colour	intermediate packaging	bulk packaging
CT-08-40	400 mm	CH 8	blue	60 pcs	10 x 60 pcs
CT-10-40	400 mm	CH 10	black	60 pcs	10 x 60 pcs
CT-12-40	400 mm	CH 12	white	50 pcs	10 x 50 pcs
CT-14-40	400 mm	CH 14	green	50 pcs	10 x 50 pcs
CT-16-40	400 mm	CH 16	orange	50 pcs	10 x 50 pcs
CT-18-40	400 mm	CH 18	red	40 pcs	10 x 40 pcs
CT-20-40	400 mm	CH 20	yellow	40 pcs	10 x 40 pcs
CT-22-40	400 mm	CH 22	purple	40 pcs	10 x 40 pcs
CT-24-40	400 mm	CH 24	dark blue	40 pcs	10 x 40 pcs



# urine bag

sterile

## features

- latex-free 2000 ml bag made of 0,22 mm thick PVC (double wall)
- double sealed PVC for maximum protection against tearing the bag
- effective non-return valve
- tight T-valve, that can be easily operated with one hand
- connecting tubing with universal stepped connector, standard tubing length 90 cm and 150 cm
- tubing made of material that is resistant to bending and kinking and which ensures a free and effective urine outflow
- precise, easy-to-read scale (every 100 ml), adequate for diuresis measurement
- strengthened holes for hanging, matching standard hangers
- white back wall making urine easy to notice
- single-use
- latex-free
- EO sterilized
- packaging: 1 pc./foil

## indication

- for 24-hour extracorporeal collection of urine and other body fluids
- maximum time of use - 24 hours

REF	capacity	length of tubing	intermediate packaging
WMD2000-90	2000 ml	90 cm	10 pcs
WMD2000-150	2000 ml	150 cm	10 pcs



bulk packaging:  
25 x 10 pcs



## urine bag

### with sample port, sterile

#### features

- latex-free 2000 ml bag made of 0,40 mm thick PVC (double wall)
- effective non-return valve
- tight T-valve, that can be easily operated with one hand
- connecting tubing with universal stepped connector, standard tubing length 120 cm (other lengths available: 90 cm, 150 cm)
- tubing made of material that is resistant to bending and kinking and which ensures a free and effective urine outflow
- self-tightening port for sample taking
- precise, easy-to-read scale, adequate for diuresis measurement, with high measurement accuracy from 25 ml, every 50 ml from 50 ml to 200 ml and every 100 ml to 2000 ml
- strengthened holes for hanging, matching standard hangers
- white back wall making urine easy to notice
- single-use
- latex-free
- EO sterilized
- packaging: 1 pc./paper-foil

#### indication

- for extracorporeal collection of urine and other body fluids
- maximum time of use - 7 days

REF	capacity	length of tubing	intermediate packaging
WMT2000-90	2000 ml	90 cm	10 pcs
WMT2000-120	2000 ml	120 cm	10 pcs
WMT2000-150	2000 ml	150 cm	10 pcs



bulk packaging:  
10 x 10 pcs



## urine bag

### with sample port 2W, sterile

#### features

- latex-free 2000 ml bag made of medical grade PVC
- white back wall making urine easy to notice
- effective non-return valve
- tight T-valve, that can be easily operated with one hand and which can be folded and tucked in a hard sheath
- Pasteur type droplet chamber providing a „dry” air barrier
- two hydrophobic air filters (in a bag and chamber), which prevent sucking, balancing the pressure inside the system
- 120 cm long, large diameter tubing, ensuring a free and effective urinary outflow with a universal stepped connector
- self-tightening port for sample taking at the end of tubing
- tubing equipped with a sliding clamp and a fastening pin to stabilize the tubing
- at the place where the tubing connects to the chamber, an additional reinforcing element prevents bending and kinking the tubing
- precise, easy-to-read scale, adequate for diuresis measurement, with high measurement accuracy, every 25 ml from 25 ml to 100 ml and every 100 ml from 100 ml to 2000 ml
- tag to describe the patient's details and date
- integrated universal hanger system matching the round and square bed rails
- additional fixing with a string
- single-use
- latex-free
- EO sterilized
- packaging: 1 pc./paper-foil

#### indication

- device is intended for 14-days urine collection in a closed system

REF	capacity	length of tubing
WM2T2000-120	2000 ml	120 cm



bulk packaging:  
40 pcs



# samples taking urine bag

## sterile

### features

- latex-free bag with a capacity of 100 ml, size 19 cm x 7 cm
- made of delicate, durable PE foil
- easy-to-read scale, adequate for diuresis measurement, highly accurate - every 10 ml
- adhesive part of the bag coated with anti-allergic, high-quality glue
- additional sealing made of anti-allergic foam that protects against the wall sticking of the bag, thanks to which free flow of urine is possible
- single-use
- latex-free, phthalate-free
- EO sterilized
- packaging: 1 pc./foil

### indication

- for urine sample collection in infants and small children

REF	capacity	purpose	version	intermediate packaging
WMCH-001	100 ml	for boys	with sponge	100 pcs
WMCH-002	100 ml	for boys	without sponge	100 pcs
WMDZ-001	100 ml	for girls	with sponge	100 pcs
WMDZ-002	100 ml	for girls	without sponge	100 pcs



bulk packaging:  
25 x 100 pcs



# urine bag hanger

## non-sterile

### features

- made of strong and durable plastic
- special clamp that prevents tube bending
- suitable for round and square bed rails
- two handles on each side for hanging urine bags of various sizes
- manufacturer's name placed on the device
- latex-free, phthalate-free
- non-sterile

### indication

- for hanging standard urine collection bags

REF	intermediate packaging
WNM01	50 pcs



bulk packaging:  
4 x 50 pcs



# enema bag

## sterile

### features

- bag with a capacity of 1750 ml with two holes for hanging
- made of medical PVC
- scaled from 50 ml to 1750 ml
- linear scale every 100 ml, digital scale every 200 ml
- tube with a length of 150 cm with a sliding clamp, ended with an atraumatic opening and one lateral opening
- tube end is secured with a tube cap
- upper part of the bag is reinforced with an additional flange stabilizing the inlet during filling with liquid
- flange is equipped with a non-return valve
- single-use
- latex-free
- EO sterilized
- packaging: 1 pc./foil

### indication

- bag that allows introduction of fluid into the large bowel through the anus to remove fecal material and stimulate peristaltic bowel movement

REF
WLS



bulk packaging:  
150 x 1 pc.



# enema bag

## non-sterile

### features

- bag with a capacity of 1500 ml with a hole for hanging
- made of medical PVC
- digitally scaled every 250 ml
- tube with a length of 115 cm with a sliding clamp, ended with an atraumatic opening and one lateral opening
- greased end of the tube secured with a cap
- single-use
- latex-free
- non-sterile

### indication

- bag that allows introduction of fluid into the large bowel through the anus to remove fecal material and stimulate peristaltic bowel movement

REF



bulk packaging:  
100 pcs

WLN



# enema set

## non-sterile

### features

- bag with a capacity of 1500 ml with a hole for hanging
- made of medical PVC
- digitally scaled every 250 ml
- tube with a length of 115 cm with a sliding clamp, ended with an atraumatic opening and one lateral opening
- greased end of the tube secured with a cap
- drape 42 cm x 45 cm
- liquid soap (9 ml)
- PE gloves - 1 pair
- single-use
- latex-free
- non-sterile
- packaging: 1 set/foil

### indication

- set that allows introduction of fluid into the large bowel through the anus to remove fecal material and stimulate peristaltic bowel movement

REF



bulk packaging:  
50 x 1 set

ZLN



# vomit bag

## non-sterile

### features

- bag is made of durable, transparent blue foil, enabling the observation of secretions.
- total bag capacity: 2000 ml
- exact measuring graduation (from 10 ml to 100 ml every 10 ml and from 100 to 2000 ml every 100 ml) placed on the bag allows accurate estimation of fluid volume
- direction of graduation reading for small volumes is marked with the tip
- wide bag inlet protected by a plastic collar
- circle-shaped collar ensures a firm grip, makes it easier to maneuver the bag, reducing the risk of content contamination
- collar equipped with a special incision to close the bag and hygienic disposal of the vomit - „twist and hook”
- device name, manufacturer’s name and pictorial instructions for use printed directly on the bag
- single-use
- latex-free
- phthalate-free
- class I non-sterile medical device
- packaging: 20 pcs/foil bag

### indication

- recommended in uncomfortable situations, in cases of gastroesophageal reflux requiring immediate action
- used in hospitals, outpatient departments, ambulances, etc.



bulk packaging:  
30 x 20 pcs

REF	colour	intermediate packaging
WW-01	blue	20 pcs





## OXYGEN THERAPY

WWW.ZARYS.COM



## oxygen mask

### with tubing, sterile

#### features

- made of transparent, non-toxic PVC
- adjustable nose metal plate and rubber fastening
- equipped with a 210 cm (+/- 5%) long tubing with universal connectors
- tubing with star cross-section that is resistant to bending
- revolving connector that allows adjusting to patient's position
- single-use
- latex-free
- EO sterilized
- packaging: 1 pc./paper-foil

#### indication

- designed to deliver oxygen with precise regulation of concentration, for medium oxygen concentration

REF	length of tubing	size
MTS-S	210 cm +/- 5%	S
MTS-M	210 cm +/- 5%	M
MTS-L	210 cm +/- 5%	L
MTS-XL	210 cm +/- 5%	XL



bulk packaging:  
50 x 1 pc.



## non-rebreather mask

### with tubing, sterile

#### features

- made of transparent, non-toxic PVC
- adjustable nose metal plate and rubber fastening
- equipped with a 210 cm (+/- 5%) long tubing with universal connectors
- tubing with star cross-section that is resistant to bending
- 1000 ml oxygen reservoir
- revolving connector that allows adjusting to patient's position
- silicone valves on the connector and ventilation openings
- single-use
- latex-free
- EO sterilized
- packaging: 1 pc./paper-foil

#### indication

- designed to deliver oxygen with precise regulation of concentration, for high oxygen concentration

REF	length of tubing	size
MTW-S	210 cm +/- 5%	S
MTW-M	210 cm +/- 5%	M
MTW-L	210 cm +/- 5%	L
MTW-XL	210 cm +/- 5%	XL



bulk packaging:  
50 x 1 pc.



# nebulizer mask

## with tubing, sterile

### features

- made of transparent, non-toxic PVC
- adjustable nose metal plate and rubber fastening
- equipped with a 210 cm (+/- 5%) long tubing with universal connectors
- tubing with star cross-section that is resistant to bending
- 8 ml nebulizer (graduated every 1 ml)
- average size of the molecule at a flow of 6l / min - 3,23 µm
- single-use
- latex-free
- EO sterilized
- packaging: 1 pc./paper-foil

### indication

- for producing aerosol containing a comminuted medicine, that can be delivered directly to the respiratory system as the patient breathes

REF	length of tubing	size
MTN-S	210 cm +/- 5%	S
MTN-M	210 cm +/- 5%	M
MTN-L	210 cm +/- 5%	L
MTN-XL	210 cm +/- 5%	XL



bulk packaging:  
50 x 1 pc.



51

# multi-vent mask

## with tubing, sterile

### features

- made of transparent, non-toxic PVC
- adjustable nose metal plate and rubber fastening
- equipped with a 210 cm (+/- 5%) long tubing with universal connectors
- tubing with star cross-section that is resistant to bending
- equipped with 2 jets - white to set mid flow concentration (35%, 40% and 50%) and green to set low concentration (24%, 26%, 28% and 30%)
- single-use
- latex-free
- EO sterilized
- packaging: 1 pc./foil

### indication

- designed to deliver oxygen with precise regulation of concentration, regardless of way of patient's breathing

REF	length of tubing	size
MTDV-L	210 cm +/- 5%	L
MTDV-XL	210 cm +/- 5%	XL



bulk packaging:  
100 x 1 pc.



## nasal oxygen cannula

sterile

### features

- made of medical PVC
- very soft tips with smooth edges
- fastening under the chin with a soft, sliding adjustment ring
- various spacing of the nasal part of the cannula depending on the size
- universal connector compatible with any source of oxygen
- tubing with star cross-section that is resistant to bending
- available in 3 sizes: for adults, for children and for infants with 140 cm, 200 cm, 300 cm and 500 cm long tubing
- single-use
- latex-free
- EO sterilized
- packaging: 1 pc./foil

### indication

- designed to deliver oxygen through the nose

REF	length of tubing	purpose	intermediate packaging	 bulk packaging
CTNN-200	200 cm	for infants	25 pcs	10 x 25 pcs
CTNZ-200	200 cm	for children	25 pcs	10 x 25 pcs
CTND-140	140 cm	for adults	30 pcs	10 x 30 pcs
CTND-200	200 cm	for adults	25 pcs	10 x 25 pcs
CTND-300	300 cm	for adults	15 pcs	10 x 15 pcs
CTND-500	500 cm	for adults	10 pcs	10 x 10 pcs



## oxygen tubing

sterile

### features

- made of transparent, non-toxic PVC
- tubing with star cross-section that is resistant to bending, with reinforcing straps along the entire length
- standardized connectors at the end of the tubing allowing connection to oxygen devices
- single-use
- latex-free
- EO sterilized
- packaging: 1 pc./paper-foil

### indication

- for transporting oxygen from an oxygen source to another medical device for oxygen supply, e.g. oxygen mask

REF	length of tubing	 bulk packaging
DT2100	210 cm +/- 2%	100 x 1 pc.
DT4260	426 cm +/- 2%	50 x 1 pc.
DT7620	762 cm +/- 2%	25 x 1 pc.



## nebulizer

with mouthpiece and tubing, sterile

### features

- made of transparent, non-toxic PVC
- tubing with star cross-section that is resistant to bending
- 15 ml nebulizer (graduated at 2, 4, 6, 9, 12, 15 ml)
- set components: nebulizer, tubing, mouthpiece
- single-use
- latex-free
- EO sterilized
- packaging: 1 pc./foil

### indication

- designed for producing aerosol containing a comminuted medicine, that can be delivered directly to the respiratory system as the patient breathes

REF	length of tubing	 bulk packaging:
NUD	210 cm +/- 5%	50 x 1 pc.



# nebulizer

with T adaptor, mouthpiece,  
corrugated tube and tubing, sterile

## features

- made of transparent, non-toxic PVC
- tubing with star cross-section that is resistant to bending
- 20 ml nebulizer (graduated every 2 ml)
- set components: nebulizer, tubing, T adaptor, mouthpiece and 15 cm long corrugated tube
- diameter of T adaptor: 22F/22F
- single-use
- latex-free
- EO sterilized
- packaging: 1 pc./foil

## indication

- designed for producing aerosol containing a comminuted medicine, that can be delivered directly to the respiratory system as the patient breathes

REF	length of tubing
NUT	210 cm +/- 5%



bulk packaging:  
100 x 1 pc.



# nebulizer

with T F/M adaptor, mouthpiece,  
corrugated tube and tubing, sterile

## features

- made of non-toxic materials
- 210 cm long, bend-resistant tubing with star-shaped cross-section
- nebuliser with a 6ml capacity (graduated every 1ml), producing particles with an average size of MMAD = 3.91  $\mu$ m at a flow rate of 6 l/min.
- nebuliser, tubing, T-adaptor, mouthpiece, one-way valve and corrugated tube included in a kit
- universal T-adaptor with a diameter of 22M/15F - 22F enables the kit to be connected to endotracheal, tracheostomy tube or breathing circuit and perform nebulisation on mechanically ventilated patients
- the universal (detachable) mouthpiece allows nebulisation to be given to patients who are breathing on their own
- silicone one-way valve (detachable) reduces medication waste during nebulisation
- single-use
- latex-free, phthalate-free
- EO sterilized
- packaging: 1 pc./foil

## indication

- device is designed to produce an aerosol containing fragmented medication, which can be delivered deep into the respiratory system with the patient's inhalation
- enables nebulisation to be carried out in mechanically ventilated patients by connecting directly to the endotracheal tube, tracheostomy tube or inspiratory arm of the ventilator breathing system
- allows you to perform nebulisation in patient „on one's own breath”

REF	length of tubing
NUTR	210 cm +/- 5%



bulk packaging:  
100 x 1 pc.





## ANAESTHESIA PRODUCTS

WWW.ZARYS.COM



# laryngeal mask

## PVC, sterile

### features

- made of medical PVC
- elastic mask body with description (size, cuff volume, suggested patient's weight)
- elliptic shape, flexible sealing cuff and universal, transparent connector: 15 mm
- colour-coded valve protection makes it easy to quickly recognize size
- single-use
- latex-free
- phthalate-free
- EO sterilized
- packaging: 1 pc./paper-foil

### indication

- device inserted through the mouth, up to the back of the throat, forms a seal at the top of the glottis in order to:
  - direct protecting the patient's airway patency
  - artificial ventilation also during cardiopulmonary resuscitation
  - maintaining airway patency in: short-term surgical procedures, without the need of muscles relaxation, when endotracheal intubation is not necessary and under anesthesia for diagnostic procedures



REF	size	colour of valve protection	weight of patient	max. inflation	intermediate packaging
MKPJ-10	1	pink	≤ 5 kg	4 ml	5 pcs
MKPJ-15	1.5	orange	5-10 kg	7 ml	5 pcs
MKPJ-20	2	dark green	10-20 kg	10 ml	5 pcs
MKPJ-25	2.5	brown	20-30 kg	14 ml	5 pcs
MKPJ-30	3	green	30-50 kg	20 ml	5 pcs
MKPJ-40	4	purple	50-70 kg	30 ml	5 pcs
MKPJ-50	5	dark blue	70-100 kg	40 ml	5 pcs



bulk packaging:  
10 x 5 pcs

# laryngeal mask

## silicone, sterile

### features

- made of biocompatible silicone, which ensures excellent flexibility of the device
- elastic mask body with description (size, cuff volume, suggested patient's weight)
- elliptic shape, flexible sealing cuff and universal, transparent connector: 15 mm
- single-use
- latex-free, phthalate-free
- EO sterilized
- packaging: 1 pc./paper-foil

### indication

- device inserted through the mouth, up to the back of the throat, forms a seal at the top of the glottis in order to:
  - direct protecting the patient's airway patency
  - artificial ventilation also during cardiopulmonary resuscitation
  - maintaining airway patency in: short-term surgical procedures, without the need of muscles relaxation, when endotracheal intubation is not necessary and under anesthesia for diagnostic procedures



REF	size	weight of patient	max. inflation	intermediate packaging
MKSJ-10	1	≤ 5 kg	4 ml	5 pcs
MKSJ-15	1.5	5-10 kg	7 ml	5 pcs
MKSJ-20	2	10-20 kg	10 ml	5 pcs
MKSJ-25	2.5	20-30 kg	14 ml	5 pcs
MKSJ-30	3	30-50 kg	20 ml	5 pcs
MKSJ-40	4	50-70 kg	30 ml	5 pcs
MKSJ-50	5	70-100 kg	40 ml	5 pcs



bulk packaging:  
10 x 5 pcs

# intubation stylet

sterile

## features

- made of PVC-coated aluminium
- special material for both stiffness and pliability
- intended for use during difficult intubation
- size and diameter markings
- soft distal tip
- single-use
- phthalate-free
- latex-free
- EO sterilized
- packaging: 1 pc./paper-foil

## indication

- allows you to give the endotracheal tube the right curvature
- introduced to the endotracheal tube facilitates intubation in routine and difficult cases, when the laryngeal inlet is not visible



REF	size	diameter	length	tube size	intermediate packaging	bulk packaging
PRI-06	6 Fr	2,0 mm	310 mm (±10)	from 2,0 to 4,0	20 pcs	20 x 20 pcs
PRI-10	10 Fr	3,3 mm	390 mm (±10)	from 4,5 to 6,5	20 pcs	20 x 20 pcs
PRI-14	14 Fr	4,7 mm	390 mm (±10)	from 7,0 to 10,0	20 pcs	20 x 20 pcs

# tracheal tube introducer

curved, sterile

## features

- made of medical grade low density polyethylene
- curved and rounded tip enables safe intubation without damaging the soft tissues
- optimum flexibility and rigidity facilitate correct insertion and safe removal of the introducer after intubation
- imprint of the size, diameter and manufacturer's name on the device
- bright yellow body for increased visibility of the introducer in the tracheal tube canal
- clear, easy to read graduation every 1 cm
- available in three sizes and lengths
- single-use
- PVC free
- latex-free
- phthalate-free
- EO sterilized
- packaging: 1 pc./paper-foil

## indication

- for use during difficult intubation procedures
- as an aid to facilitate the insertion of the endotracheal tube during standard intubation



 bulk packaging:  
20 x 10 pcs

REF	size	diameter O.D.	total length	tube size	graduation	intermediate packaging
PTIZ-06-535	6 Fr	2,0 mm	535 mm	from 2,0 to 4,0	10 – 45 mm	10 pcs
PTIZ-10-600	10 Fr	3,3 mm	600 mm	from 4,5 to 6,0	10 – 50 mm	10 pcs
PTIZ-10-800	10 Fr	3,3 mm	800 mm	from 4,5 to 6,0	10 – 60 mm	10 pcs
PTIZ-15-600	15 Fr	5,0 mm	600 mm	from 6,5 to 10,0	10 – 50 mm	10 pcs
PTIZ-15-800	15 Fr	5,0 mm	800 mm	from 6,5 to 10,0	10 – 60 mm	10 pcs

# endotracheal tube

uncuffed, sterile

## features

- made of flexible PVC
- radiopaque line over the entire tube length
- equipped with lateral Murphy eye
- graduated every 1 cm
- double depth marker to control the position of the tube
- tube size marked in 3 places (on the connector and in two places on the tube body)
- detachable connector with an outer diameter of 15 mm
- single-use
- latex-free
- EO sterilized
- packaging: 1 pc./paper-foil

## indication

- for both oral and nasal intubation
- inserted into the trachea to prevent airway obstruction and respiratory failure

REF	size	intermediate packaging
RIB-20	I.D. (mm) 2.0	20 pcs
RIB-25	I.D. (mm) 2.5	20 pcs
RIB-30	I.D. (mm) 3.0	20 pcs
RIB-35	I.D. (mm) 3.5	20 pcs
RIB-40	I.D. (mm) 4.0	20 pcs
RIB-45	I.D. (mm) 4.5	20 pcs
RIB-50	I.D. (mm) 5.0	20 pcs
RIB-55	I.D. (mm) 5.5	20 pcs
RIB-60	I.D. (mm) 6.0	20 pcs
RIB-65	I.D. (mm) 6.5	20 pcs
RIB-70	I.D. (mm) 7.0	20 pcs
RIB-75	I.D. (mm) 7.5	20 pcs
RIB-80	I.D. (mm) 8.0	20 pcs
RIB-85	I.D. (mm) 8.5	20 pcs
RIB-90	I.D. (mm) 9.0	20 pcs
RIB-95	I.D. (mm) 9.5	20 pcs
RIB-100	I.D. (mm) 10.0	20 pcs



 bulk packaging:  
10 x 20 pcs



# endotracheal tube

cuffed, sterile

## features

- made of flexible PVC
- equipped with lateral Murphy eye and radiopaque line over the entire tube length
- graduated every 1 cm, double depth marker to control the position of the tube
- low-pressure, high-volume cuff
- tube size marked in 4 places (on the connector, on the pilot balloon and in two places on the tube body)
- detachable connector with an outer diameter of 15 mm
- pilot balloon with LOT and size indication
- single-use
- latex-free
- EO sterilized
- packaging: 1 pc./paper-foil

## indication

- for both oral and nasal intubation
- inserted into the trachea to prevent airway obstruction and respiratory failure

REF	size	intermediate packaging
RIM-30	I.D. (mm) 3.0	20 pcs
RIM-35	I.D. (mm) 3.5	20 pcs
RIM-40	I.D. (mm) 4.0	20 pcs
RIM-45	I.D. (mm) 4.5	20 pcs
RIM-50	I.D. (mm) 5.0	20 pcs
RIM-55	I.D. (mm) 5.5	20 pcs
RIM-60	I.D. (mm) 6.0	20 pcs
RIM-65	I.D. (mm) 6.5	20 pcs
RIM-70	I.D. (mm) 7.0	20 pcs
RIM-75	I.D. (mm) 7.5	20 pcs
RIM-80	I.D. (mm) 8.0	20 pcs
RIM-85	I.D. (mm) 8.5	20 pcs
RIM-90	I.D. (mm) 9.0	20 pcs
RIM-95	I.D. (mm) 9.5	20 pcs
RIM-100	I.D. (mm) 10.0	20 pcs



bulk packaging:  
10 x 20 pcs



# reinforced endotracheal tube

cuffed, sterile

## features

- made of flexible PVC
- reinforcing within the wall of the entire tube
- equipped with lateral Murphy eye and radiopaque line over the entire tube length
- graduated every 1 cm, double depth marker to control the position of the tube
- tube size marked in 4 places (on the connector, on the pilot balloon and in two places on the tube body)
- indissociable connector with an outer diameter of 15 mm
- single-use
- latex-free
- EO sterilized
- packaging: 1 pc./paper-foil

## indication

- for both oral and nasal intubation
- inserted into the trachea to prevent airway obstruction and respiratory failure
- for intubation of the patient in an unusual position, with a high risk of kinking the endotracheal tube

REF	size	intermediate packaging
RIMZP-30	I.D. (mm) 3.0	10 pcs
RIMZP-35	I.D. (mm) 3.5	10 pcs
RIMZP-40	I.D. (mm) 4.0	10 pcs
RIMZP-45	I.D. (mm) 4.5	10 pcs
RIMZP-50	I.D. (mm) 5.0	10 pcs
RIMZP-55	I.D. (mm) 5.5	10 pcs
RIMZP-60	I.D. (mm) 6.0	10 pcs
RIMZP-65	I.D. (mm) 6.5	10 pcs
RIMZP-70	I.D. (mm) 7.0	10 pcs
RIMZP-75	I.D. (mm) 7.5	10 pcs
RIMZP-80	I.D. (mm) 8.0	10 pcs
RIMZP-85	I.D. (mm) 8.5	10 pcs
RIMZP-90	I.D. (mm) 9.0	10 pcs
RIMZP-95	I.D. (mm) 9.5	10 pcs
RIMZP-100	I.D. (mm) 10.0	10 pcs



bulk packaging:  
10 x 10 pcs



# endotracheal tube holder

sterile

## features

- made of high-quality materials
- universal Velcro fasteners enabling fast and effective fixing of the holder around the head
- adjustable handle allows for easy and fast fixation of every size of endotracheal tube
- special design of the bite-piece prevents patient trauma or damaging the tube (by biting)
- additional opening allows for chyme, saliva and blood suction from the oral cavity
- single-use
- latex-free, phthalate-free
- EO sterilized
- packaging: 1 pc./paper-foil

## indication

- to stabilize the position of the endotracheal tube after its insertion into the trachea

REF	version	colour
SRI-N	horizontal fixation	blue-red
SRI-A	vertical fixation	green



bulk packaging:  
100 x 1 pc.



# tracheostomy tube

cuffed, sterile

## features

- made of medical, flexible PVC
- swivel 15 mm connector
- flexible neckplates with slits for strap insertion to secure tube position
- soft, low-pressure, thin-walled cuff
- pilot balloon in contrasting colour clearly indicates the level of the cuff's inflation
- 2 fixation straps protected with foil
- clear size marking on the neckplates
- atraumatic, soft rounded tip, curved cannula
- radiopaque line
- equipped with obturator
- single-use
- latex-free
- EO sterilized
- packaging: 1 pc./rigid blister

## indication

- to control respiratory tracts in people after tracheostomy
- introduced to the airways by a surgical incision of the tracheal's front wall to allow ventilation
- provides free breathing bypassing the nose, throat and larynx

REF	size	intermediate packaging
RTM-40	4.0	10 pcs
RTM-45	4.5	10 pcs
RTM-50	5.0	10 pcs
RTM-60	6.0	10 pcs
RTM-65	6.5	10 pcs
RTM-70	7.0	10 pcs
RTM-75	7.5	10 pcs
RTM-80	8.0	10 pcs
RTM-85	8.5	10 pcs
RTM-90	9.0	10 pcs
RTM-95	9.5	10 pcs
RTM-100	10.0	10 pcs



bulk packaging:  
10 x 10 pcs



# dual-limb breathing circuit

sterile

## features

- made of high quality EVA material, without PVC
- 15F/22M and 22F universal connector fits compatible products and devices for mechanical ventilation or anesthesia machine
- expandable arms with maximum length of 160 cm
- adjustable length of circuit enabling adjustment of length of respiratory system and optimization of dead space
- equipped with latex-free breathing bag: 3l (for adults) or 1l (for children)
- additional expandable tube, length: 100 cm
- elbow with luer lock port
- single-use
- latex-free, phthalate-free
- EO sterilized
- packaging: 1 pc./foil

## indication

- for patient's mechanical ventilation
- it enables transporting breathing mixture from equipment (ventilator, anesthesia machine) to respiratory protection device (e.g. tracheal tube, tracheostomy mask) and vice versa



REF	purpose	capacity of bag
OBWD-1601L	for children	1 liter
OBWD-1603L	for adults	3 liters



bulk packaging:  
40 x 1 pc.

# catheter mount with double swivel elbow connector

sterile

## features

- smooth bore type made of medical PVC
- expandable type made of high quality PE, EVA
- universal patient connection: 22M/15F
- ventilation device side connector: 15M or 22F
- expandable version characterized by shape memorizing and by the ability to control the position of the connector
- double swivel elbow connector
- port for suctioning and bronchoscope secured with a stopper
- available in versions: smooth bore and expandable
- single-use
- latex-free
- EO sterilized
- packaging: 1 pc./paper-foil

## indication

- used to connect the tracheostomy tube or endotracheal tube with the breathing circuit of the ventilation device
- provides greater mobility and rotation of the connection, increasing patient comfort and safety



REF	type	connection	length (without connectors)	intermediate packaging
PM-15-G	smooth bore (not expandable)	22M/15F-15M	15 cm	10 pcs
PM-22-G	smooth bore (not expandable)	22M/15F-22F	15 cm	10 pcs
PMR-15-K	expandable	22M/15F-15M	8-15 cm	10 pcs
PMR-22-K	expandable	22M/15F-22F	8-15 cm	10 pcs



bulk packaging:  
10 x 10 pcs

# oropharyngeal airway/guedel airway

sterile

## features

- made of high quality PE (polyethylene), free of PVC
- distinctive anatomical curve of airway tube allows for the opening of the upper respiratory tract and the free flow of anaesthetic gases, air
- colour coded sizes
- numeric marking of the size on the airway
- single-use
- latex-free, phthalate-free
- EO sterilized
- packaging: 1 pc./foil

## indication

- used during artificial ventilation procedures to ensure the airway patency
- as a tool for paramedic to assist in the management of a casualty's airway which increases the effectiveness of the rescue operation
- facilitates the stabilization of the endotracheal tube and protects it against biting

REF	size	number	colour	intermediate packaging
RG-40	40 mm	000	pink	50 pcs
RG-50	50 mm	00	dark blue	50 pcs
RG-60	60 mm	0	black	50 pcs
RG-70	70 mm	1	white	50 pcs
RG-80	80 mm	2	green	50 pcs
RG-90	90 mm	3	yellow	50 pcs
RG-100	100 mm	4	red	50 pcs
RG-110	110 mm	5	blue	50 pcs
RG-120	120 mm	6	orange	50 pcs



bulk packaging:  
10 x 50 pcs

# air cushion anaesthetic mask

non-sterile

## features

- due to the high quality of materials used, ventilation is conducted in an atraumatic and safe way for the patient
- anatomically shaped inflatable cuff, ensures perfect tightness of the mask with minimal pressure
- device, when applied to the face, tightly covers the patient's mouth and nose without compressing the eyes
- clear shell provides continuous visual observation of the patient
- colour-coded retaining rings, easy for size recognition
- retaining ring can be removed when it is not needed
- full size range allows to properly choose the size of the mask depending on the age of the patient
- all sizes are equipped with inflatable check valve to adjust air amount for best cushion fitting auto patient's face
- single-use
- latex-free, phthalate-free
- non-sterile
- packaging: 1 pc./foil

## indication

- intended for the administration of a gas mixture coming through devices for artificial ventilation
- enables performing medical procedures including artificial ventilation, administration of anesthetic gas and carrying out emergency treatment of an unconscious patient

REF	size	age of patient/ size	colour
MAP-0	0	neonate	-
MAP-1	1	infant	-
MAP-2	2	pediatric	yellow
MAP-3	3	adult S	green
MAP-4	4	adult M	red
MAP-5	5	adult L	blue
MAP-6	6	adult XL	orange



bulk packaging:  
100 x 1 pc.



## GENERAL SURGERY

# Yankauer surgical suction cannula

## standard CH21, sterile

### features

- completely transparent for full possibility of observing the sucked secretion
- light and perfectly balanced handle ensures high comfort of work and reduces hand fatigue
- perfectly smooth inner surface prevents blocking or retaining the sucked content, ensuring correct and optimal flow
- cannula with double bend of curvature
- four lateral eyes, which prevent the tip from sticking to the tissues and one central opening
- universal stepped connector ensures tight connection with a wide range of suction connecting tubes
- single-use
- latex-free, phthalate-free
- EO sterilized
- packaging: 1 pc./double packaging: internal- foil, external- paper-foil

### indication

- evacuating secretions and body fluids from the operating field in general surgery

REF	features	packaging	intermediate packaging
KO-00204	without suction control	1 pc.	50 pcs
KO-00214	with suction control	1 pc.	50 pcs



bulk packaging:  
4 x 50 pcs



# Yankauer surgical suction cannula

## bulb tip CH23, sterile

### features

- cannula with bulb tip with four lateral eyes, which prevent the tip from sticking to the tissues and one central opening
- completely transparent for full possibility of observing the sucked secretion
- light and perfectly balanced handle ensures high comfort of work and reduces hand fatigue
- perfectly smooth inner surface prevents blocking or retaining the sucked content, ensuring correct and optimal flow
- cannula with double bend of curvature
- universal stepped connector ensures tight connection with a wide range of suction connecting tubes
- single-use
- latex-free, phthalate-free
- EO sterilized
- packaging: 1 pc./double packaging: internal- foil, external- paper-foil

### indication

- evacuating secretions and body fluids from the operating field in general surgery

REF	features	packaging	intermediate packaging
KO-00104	without suction control	1 pc.	50 pcs
KO-00114	with suction control	1 pc.	50 pcs



bulk packaging:  
4 x 50 pcs



# surgical suction tube

## sterile

### features

- made of soft and flexible PVC
- along the tube a special longitudinal reinforcement to prevent bending and sucking of the tube
- perfectly smooth inner surface of tube prevents the sucked content from settling on the walls, ensuring correct and optimal flow
- connector type funnel-funnel cut-to-fit with the possibility of cutting in the marked places of the connector and matching to any type of medical suction device (for the diameter of 8 mm to 18 mm)
- funnel connector equipped with a special bending system, enabling convenient manipulation of the tube
- tube connectors compatible with the standard suction cannulas, enabling their reliable, effective and tight connection
- single-use
- latex-free
- EO sterilized
- packaging: 1 pc./double packaging: internal- foil, external- paper-foil

### indication

- device designed for connecting the suction cannula to medical suction device
- Kapkon connector – designed to connect the catheter for aspiration of upper respiratory tract to medical suction device



REF	size	length of tube	connector
DO-24201	CH24	210 cm	funnel-funnel
DO-24301	CH24	300 cm	funnel-funnel
DO-30201	CH30	210 cm	funnel-funnel
DO-30301	CH30	300 cm	funnel-funnel
DO-24204	CH24	210 cm	funnel-funnel cut-to-fit
DO-24202	CH24	210 cm	funnel-Kapkon

  
bulk packaging:  
50 x 1 pc.



## Connectors guide

### FUNNEL-FUNNEL CONNECTOR

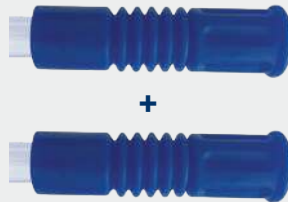

### FUNNEL-FUNNEL CUT-TO-FIT CONNECTOR



### 3-STEP CONNECTOR TO CUT



### FUNNEL-KAPKON CONNECTOR



# surgical suction set

with Yankauer cannula, standard, sterile

## CANNULA

- completely transparent for full possibility of observing the sucked secretion
- light and perfectly balanced handle ensures high comfort of work and reduces hand fatigue
- perfectly smooth inner surface prevents blocking or retaining the sucked content, ensuring correct and optimal flow
- cannula with double bend of curvature
- four lateral eyes, which prevent the tip from sticking to the tissues and one central opening
- universal stepped connector ensures tight connection with a wide range of suction connecting tubes

## TUBE

- made of soft and flexible PVC
- along the tube a special longitudinal reinforcement to prevent bending and sucking of the tube
- perfectly smooth inner surface of tube prevents the sucked content from settling on the walls, ensuring correct and optimal flow
- connector type funnel-funnel cut-to-fit with the possibility of cutting in the marked places of the connector and matching to any type of medical suction device (for the diameter of 8 mm to 18 mm)
- funnel connector equipped with a special bending system, enabling convenient manipulation of the tube
- tube connectors compatible with the standard suction cannulas, enabling their reliable, effective and tight connection

## features

- available with or without suction control
- single-use
- latex-free
- EO sterilized
- packaging: 1 set/double packaging: internal- foil, external- paper-foil

## indication

- evacuating secretions and body fluids from the operating field in general surgery



REF	size	length of tube	connector
ZO-212400104	CH21/CH24	210 cm	without suction control funnel-funnel
ZO-212400114	CH21/CH24	210 cm	without suction control funnel-funnel
ZO-402423104	CH21/CH24	400 cm	without suction control funnel-funnel
ZO-402423114	CH21/CH24	400 cm	without suction control funnel-funnel
ZO-2124001041	CH21/CH24	210 cm	without suction control funnel-funnel cut-to-fit
ZO-2124001141	CH21/CH24	210 cm	without suction control funnel-funnel cut-to-fit



bulk packaging:  
50 x 1 set



# surgical suction set

with Yankauer cannula, bulb tip, sterile

## CANNULA

- cannula with bulb tip with four lateral eyes, which prevent the tip from sticking to the tissues and one central opening
- completely transparent for full possibility of observing the sucked secretion
- light and perfectly balanced handle ensures high comfort of work and reduces hand fatigue
- perfectly smooth inner surface prevents blocking or retaining the sucked content, ensuring correct and optimal flow
- cannula with double bend of curvature
- universal stepped connector ensures tight connection with a wide range of suction connecting tubes

## TUBE

- made of soft and flexible PVC
- along the tube a special longitudinal reinforcement to prevent bending and sucking of the tube
- perfectly smooth inner surface of tube prevents the sucked content from settling on the walls, ensuring correct and optimal flow
- connector type funnel-funnel cut-to-fit with the possibility of cutting in the marked places of the connector and matching to any type of medical suction device (for the diameter of 8 mm to 18 mm)
- funnel connector equipped with a special bending system, enabling convenient manipulation of the tube
- tube connectors compatible with the standard suction cannulas, enabling their reliable, effective and tight connection

## features

- available with or without suction control
- single-use
- latex-free
- EO sterilized
- packaging: 1 set/double packaging: internal- foil, external- paper-foil

## indication

- evacuating secretions and body fluids from the operating field in general surgery



REF	size	length of tube	connector
ZO-2124002041	CH23/CH24	210 cm	with suction control, funnel-funnel cut-to-fit
ZO-2124002141	CH23/CH24	210 cm	with suction control, funnel-funnel cut-to-fit
ZO-3024002041	CH23/CH24	300 cm	with suction control, funnel-funnel cut-to-fit
ZO-3024002141	CH23/CH24	300 cm	with suction control, funnel-funnel cut-to-fit



bulk packaging:  
50 x 1 set



## OTHER DISPOSABLE PRODUCTS

# latex-free tourniquet

## non-sterile

### features

- made of a wide stretch TPE strap (thermoplastic elastomer)
- latex-free material prevents allergic reactions and skin irritation
- high tensile strength
- single-use bands reduce the risk of infection
- total roller length 11,25 m
- single-use
- latex-free, phthalate-free
- individual packaging contains: 25 tourniquets
- non-sterile
- packaging: 1 roll/paper dispenser that allows convenient sharing of perforated tourniquets

### indication

- used to induce venous stasis and to make a vein selected for puncture more prominent

REF	size	colour
S001	25 mm x 450 mm	blue
S002	25 mm x 450 mm	pink



bulk packaging:  
100 rolls



# automatic tourniquet

## non-sterile

### features

- components: blue stretchy strap and white ABS plastic buckle
- length 480 mm +/- 10 mm, width 25 mm +/- 10 mm
- wide, stretchable band put above the venipuncture site reduces the pressure intensity
- protects against the congestion of the arm, minimizes unpleasant sensations, improves the quality of the blood sample
- reusable
- contains latex, phthalate-free
- non-sterile
- packaging: 1 pc./double packaging: internal- foil, external- box

### indication

- used to induce venous stasis and to make a vein selected for puncture more prominent

REF	intermediate packaging
SA-001	21 pcs



bulk packaging:  
20 x 21 pcs



## dental brush

with suction, non-sterile

### features

- made of polypropylene
- soft bristles on one side, foam on the other side
- total length 18 cm
- length of the cleaning part 2,5 cm
- suction opening from both the bristle side and the space between the foam and the bristles
- controlled suction connector at 45° angle for convenient manipulation
- single-use
- latex-free, phthalate-free
- non-sterile
- packaging: 1 pc./foil

### indication

- hygiene of the patient's oral cavity
- function for simultaneous brushing, rinsing and suction

REF	intermediate packaging
HJM-SO	50 pcs



bulk packaging:  
10 x 50 pcs



## oral swab

non-sterile

### features

- overall length 15 cm (+/- 2 mm)
- length of the foam part 2,5 cm
- handle made of polyester
- swab made of polypropylene
- single-use
- latex-free, phthalate-free
- non-sterile
- packaging: 1 pc./foil

### indication

- intended for oral hygiene in patients partially or completely dependent on medical personnel
- allows the oral mucosa to be kept in proper humidity
- allows you to perform a procedure to prevent pathological changes in the mouth

REF	intermediate packaging
HJM-GB	50 pcs



bulk packaging:  
10 x 50 pcs



## tongue depressor

wooden

### features

- made of birch wood
- rounded edges preventing injuries
- natural colour
- long outreach thanks to appropriate length
- durable
- single-use
- available in sterile or non-sterile version
- packaging: sterile - 1 pc./paper, non-sterile - 100 pcs/box

### indication

- diagnostic examination of the oral cavity

REF	version	dimensions	bulk packaging
SLN-001	non-sterile	150 mm x 17 mm	50 x 100 pcs
SLS-001	sterile	150 mm x 17 mm	20 x 100 pcs



conallhealth  
Your Partner In Healthcare

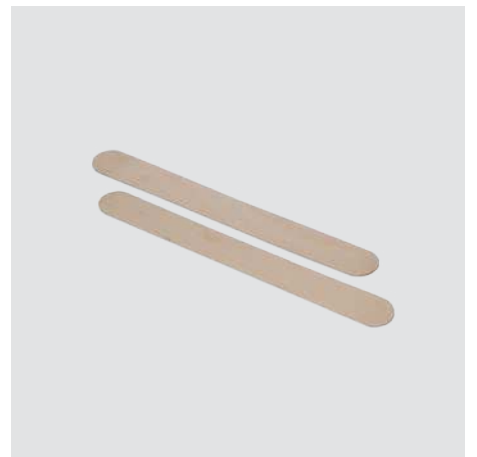

## Wash glove

molton

### features

- wash glove in the form of a glove to put on a hand
- made of MOLTON material
- ultrasonic sewing
- soft, smooth, gentle and absorbent
- dry, without cleaning agents
- tear resistant
- single-use

REF	grammage	dimensions	unit packaging	 bulk packaging
MB11	75 g/m <sup>2</sup>	160 mm x 220 mm	50 pcs	20 x 50 pcs



## Wash glove

spunlace

### features

- wash glove in the form of a glove to put on a hand. Made of MOLTON material
- made of SPUNLACE material
- ultrasonic sewing
- very soft, gentle and absorbent
- dry, without cleaning agents
- tear resistant
- single-use

REF	grammage	dimensions	unit packaging	 bulk packaging
MB12	80 g/m <sup>2</sup>	160 mm x 220 mm	50 pcs	20 x 50 pcs



## Wash glove

with film lining

### features

- wash glove with film lining in the form of a glove to put on a hand
- made of Airlaid material + PE
- ultrasonic sewing
- gentle and absorbent
- dry, without cleaning agents
- tear resistant
- single-use

REF	grammage	dimensions	unit packaging	 bulk packaging
MB13PE	80 g/m <sup>2</sup>	160 mm x 220 mm	50 pcs	20 x 50 pcs



# ID wristband

## non-sterile

### features

- durable wristband coating characterized by high humidity resistance and resistance to the activity of soaps, hand disinfectants and other liquids used in hospitals
- made of soft and delicate vinyl
- flexible, delicate, very light and easy to put on
- rounded edges prevent from injuring
- high tensile strength
- colour marking depending on the purpose
- single-use fastening resistant to accidental break
- hypoallergenic, latex-free, phthalate-free
- available in a version with a description field directly on the band and with an insert card
- non-sterile
- packaging: 100 pcs/box

### indication

- for identification of patients in hospital wards

REF	purpose	colour	version	intermediate packaging
OPD-B-01	for children and adults	white	insert card	100 pcs
OPN-R-01	for infants	pink	insert card	100 pcs
OPN-N-01	for infants	blue	insert card	100 pcs



bulk packaging:  
50 x 100 pcs



# entrance mat

## non-sterile

### features

- blue mat consisting of 30 layers - thin sticky sheets
- each of the sticky sheets made of polyethylene resin
- does not contain heavy metals
- excellent adhesive properties
- the first and last sheets secured with a non-adhesive foil
- low mat profile: app. 2 mm thick
- the bottom surface adheres very well to the floor over the entire surface, preventing adverse movement of the mat, allowing trouble-free passage of trolleys with equipment or beds, without the risk of curling up the mat or tearing
- no need to clean the mat - as soon as the surface of the mat is contaminated, it should be torn off to uncover a new, clean sheet
- there is numbering of sheets on a white non-adhesive material in the mat corner facilitate quick identification and easy removal of subsequent sheets
- light, easy to spread
- non-sterile

### indication

- preventing spreading of contamination brought on shoe soles and wheelchairs to operating rooms

REF	dimensions	intermediate packaging
M001	45 cm x 115 cm	10 pcs



bulk packaging:  
5 x 10 pcs

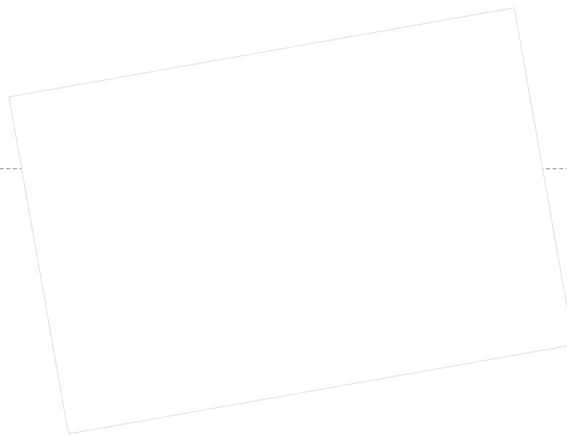

# PE gloves

## non-sterile

### features

- made of polyethylene
- coarse surface and tear-resistant weld
- ambidextrous
- elongation min. 130%, tensile strength min. 10 MPa
- approved for contact with food
- single-use
- non-sterile
- packaging: 100 pcs/foil bag enabling individual removal of gloves

### indication

- intended for use as a contribution to other gloves (double-gloving) and for minimally invasive procedures such as drug preparation, feeding the patient

REF	size	length
BS-RF-M	M (women)	280 mm
BS-RF-L	L (men)	300 mm



bulk packaging:  
100 x 100 pcs



71

# electronic thermometer

## non-sterile

### features

- digital thermometer
- fast, safe and reliable
- temperature readings
- waterproof
- measurement in 10 seconds
- range 32.0°C-42.9°C (90.0°F-109.9°F)
- accuracy  $\pm 0.1^{\circ}\text{C}$  ( $\pm 0.2^{\circ}\text{F}$ )
- has a soft, flexible measuring tip
- sound signal
- automatic turning off
- memory of the last measurement
- low battery indicator
- battery life: approximately 200 hours
- package: 1 piece / plastic cover and paper box

### indication

- for measuring body temperature in the mouth, armpit and rectal area

REF	intermediate packaging
MT-403S	10 pcs



bulk packaging:  
30 x 10 pcs

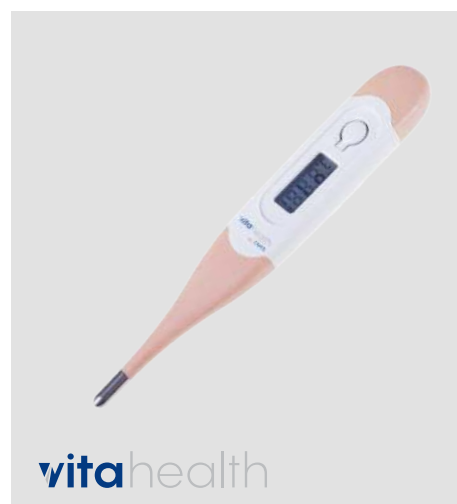





# Dressings

Dressing materials have for years been the core of patient care. Constant development in this field causes more advanced products to appear next to the basic ones only. Dressing does not translate into using only the basic compresses and tapes any more. Naturally the function of each dressing depends on the requirements, overall patient health and the conditions in which the product is to be used.

The offer of ZARYS International Group falls into a few categories and encompasses a complex range of solutions such as:

- gauze and non-woven dressings, compresses and drapes whose main function is to absorb the exudate and dress the wound in hospital and home care conditions,
- adhesive tapes made of various materials used for dressing and drain fixation as well as dressings with absorbent pads that enable fast dressing of minor injuries,
- special purpose dressings composing of solutions dedicated to specific conditions such as the dressing of post-operative wounds, cannula and drain fixation,
- supporting dressings- including products such as knitted and elastic bandages and tapes,
- stiffening dressings- including padding and P.O.P. bandages.



## TRADITIONAL DRESSINGS MATERIALS

## DRESSING GAUZE

### features

- 100% hydrophilic cotton
- bleached with the use of hydrogen peroxide
- soft and very absorbent
- increase in absorption capacity with increasing number of gauze threads
- homogeneous structure through a strong twist of fibers eliminates the risk of loose fibers on the surface

### indication

- general wound dressing in out-patient clinics, surgical sites, procedure department



## dressing gauze, zig-zag folded

### GAZA lux



non-sterile

Before use on open wounds, the device must be sterilized in accordance with a validated sterilization method. It can be sterilized with steam, ethylene oxide or radiation.

REF	dimensions	no. of threads	packaging unit foil bag	bulk packaging carton
GR1309100	0,9 m x 100 m	13	1 pc.	5 x 1 pc.
GR1709100	0,9 m x 100 m	17	1 pc.	5 x 1 pc.



can be cut and formed



## cutting gauze

### GAZA lux



non-sterile

Before use on open wounds, the device must be sterilized in accordance with a validated sterilization method. It can be sterilized with steam, ethylene oxide or radiation.

REF	size	no. of threads	packaging unit paper-foil	bulk packaging carton
*CG1325SQM	1/4 m <sup>2</sup>	13	1 pc.	100 x 1 pc.
*CG1305SQM	1/2 m <sup>2</sup>	13	1 pc.	50 x 1 pc.
CG131SQM	1 m <sup>2</sup>	13	1 pc.	25 x 1 pc.
*CG1725SQM	1/4 m <sup>2</sup>	17	1 pc.	100 x 1 pc.
*CG1705SQM	1/2 m <sup>2</sup>	17	1 pc.	50 x 1 pc.
CG171SQM	1 m <sup>2</sup>	17	1 pc.	25 x 1 pc.



edges ES-type folded



available on request

### GAZA lux S



sterile

REF	size	no. of threads	packaging unit paper-foil	bulk packaging carton
CG1325SQM-SS	1/4 m <sup>2</sup>	13	1 pc.	100 x 1 pc.
CG1305SQM-SS	1/2 m <sup>2</sup>	13	1 pc.	50 x 1 pc.
CG131SQM-SS	1 m <sup>2</sup>	13	1 pc.	25 x 1 pc.
CG1725SQM-SS	1/4 m <sup>2</sup>	17	1 pc.	100 x 1 pc.
CG1705SQM-SS	1/2 m <sup>2</sup>	17	1 pc.	50 x 1 pc.
CG171SQM-SS	1 m <sup>2</sup>	17	1 pc.	25 x 1 pc.

Sterilization method:

- -S - EO sterilized product - on request
- -SS - steam sterilized product

# GAUZE SWABS

## features

- 100% hydrophilic cotton
- bleached with the use of hydrogen peroxide
- edges ES-type folded, which prevents fraying of loose threads
- available with a sewed in X-ray detectable thread, which enables fast and non-invasive identification of the swab left in the operating field

## indication

- general wound dressing in out-patient clinics, surgical sites, procedure departments



Before use on open wounds, the device must be sterilized in accordance with a validated sterilization method. It can be sterilized with steam or ethylene oxide.



available on request

## gauze swabs

### KOMPRI lux



non-sterile

#### without X-ray detectable thread

REF	dimensions	no. of threads	no. of plies	packaging unit paper bag	bulk packaging carton
GS1305081	5 cm x 5 cm	13	8	100 pcs	250 x 100 pcs
GS1375081	7,5 cm x 7,5 cm	13	8	100 pcs	60 x 100 pcs
GS1310081	10 cm x 10 cm	13	8	100 pcs	40 x 100 pcs
GS1305121	5 cm x 5 cm	13	12	100 pcs	80 x 100 pcs
GS1305125	5 cm x 5 cm	13	12	500 pcs	4 x 500 pcs
GS1375121	7,5 cm x 7,5 cm	13	12	100 pcs	40 x 100 pcs
GS1375125	7,5 cm x 7,5 cm	13	12	500 pcs	4 x 500 pcs
GS1310121	10 cm x 10 cm	13	12	100 pcs	20 x 100 pcs
GS1310125	10 cm x 10 cm	13	12	500 pcs	4 x 500 pcs
GS1705081	5 cm x 5 cm	17	8	100 pcs	80 x 100 pcs
GS1775081	7,5 cm x 7,5 cm	17	8	100 pcs	90 x 100 pcs
GS1710081	10 cm x 10 cm	17	8	100 pcs	40 x 100 pcs
GS171020081	10 cm x 20 cm	17	8	100 pcs	40 x 100 pcs
GS1705121	5 cm x 5 cm	17	12	100 pcs	96 x 100 pcs
GS1705125	5 cm x 5 cm	17	12	500 pcs	4 x 500 pcs
GS1775121	7,5 cm x 7,5 cm	17	12	100 pcs	60 x 100 pcs
GS1775125	7,5 cm x 7,5 cm	17	12	500 pcs	4 x 500 pcs
GS1710121	10 cm x 10 cm	17	12	100 pcs	20 x 100 pcs
GS1710125	10 cm x 10 cm	17	12	500 pcs	4 x 500 pcs
GS171020121	10 cm x 20 cm	17	12	100 pcs	20 x 100 pcs
GS1705161	5 cm x 5 cm	17	16	100 pcs	96 x 100 pcs
GS1775161	7,5 cm x 7,5 cm	17	16	100 pcs	60 x 100 pcs
GS1710161	10 cm x 10 cm	17	16	100 pcs	40 x 100 pcs
GS171020161	10 cm x 20 cm	17	16	100 pcs	20 x 100 pcs

#### with X-ray detectable thread

REF	dimensions	no. of threads	no. of plies	packaging unit paper bag	bulk packaging carton
*GS1705081X	5 cm x 5 cm	17	8	100 pcs	80 x 100 pcs
GS1775081X	7,5 cm x 7,5 cm	17	8	100 pcs	90 x 100 pcs
GS1710081X	10 cm x 10 cm	17	8	100 pcs	40 x 100 pcs
*GS1705121X	5 cm x 5 cm	17	12	100 pcs	96 x 100 pcs
GS1775121X	7,5 cm x 7,5 cm	17	12	100 pcs	60 x 100 pcs
GS1710121X	10 cm x 10 cm	17	12	100 pcs	20 x 100 pcs
GS171020121X	10 cm x 20 cm	17	12	100 pcs	20 x 100 pcs
GS1705161X	5 cm x 5 cm	17	16	100 pcs	96 x 100 pcs
GS1775161X	7,5 cm x 7,5 cm	17	16	100 pcs	60 x 100 pcs
GS1710161X	10 cm x 10 cm	17	16	100 pcs	40 x 100 pcs
GS171020161X	10 cm x 20 cm	17	16	100 pcs	20 x 100 pcs



BESTSELLER



## KOMPRI lux S STERILE sterile

without X-ray detectable thread

REF	dimensions	no. of threads	no. of plies	packaging unit paper-foil	bulk packaging box
GS1705081-S	5 cm x 5 cm	17	8	1 pc.	50 x 1 pc.
GS1705082-SS	5 cm x 5 cm	17	8	2 pcs	50 x 2 pcs
GS1705083-SS	5 cm x 5 cm	17	8	3 pcs	50 x 3 pcs
GS1705085-SS	5 cm x 5 cm	17	8	5 pcs	20 x 5 pcs
GS17050810-SS	5 cm x 5 cm	17	8	10 pcs	40 x 10 pcs
GS17050820-SS	5 cm x 5 cm	17	8	20 pcs	20 x 20 pcs
GS1775081-S	7,5 cm x 7,5 cm	17	8	1 pc.	50 x 1 pc.
GS1775082-SS	7,5 cm x 7,5 cm	17	8	2 pcs	50 x 2 pcs
GS1775083-SS	7,5 cm x 7,5 cm	17	8	3 pcs	50 x 3 pcs
GS1775085-SS	7,5 cm x 7,5 cm	17	8	5 pcs	20 x 5 pcs
GS17750810-SS	7,5 cm x 7,5 cm	17	8	10 pcs	40 x 10 pcs
GS17750820-SS	7,5 cm x 7,5 cm	17	8	20 pcs	20 x 20 pcs
GS1710081-S	10 cm x 10 cm	17	8	1 pc.	50 x 1 pc.
GS1710082-SS	10 cm x 10 cm	17	8	2 pcs	50 x 2 pcs
GS1710083-SS	10 cm x 10 cm	17	8	3 pcs	50 x 3 pcs
GS1710085-SS	10 cm x 10 cm	17	8	5 pcs	50 x 5 pcs
GS17100810-SS	10 cm x 10 cm	17	8	10 pcs	40 x 10 pcs
GS17100820-SS	10 cm x 10 cm	17	8	20 pcs	10 x 20 pcs
GS1705122-SS	5 cm x 5 cm	17	12	2 pcs	50 x 2 pcs
GS1705123-SS	5 cm x 5 cm	17	12	3 pcs	50 x 3 pcs
<b>GS1705123-S-IP</b>	<b>5 cm x 5 cm</b>	<b>17</b>	<b>12</b>	<b>3x1 pcs</b>	<b>20 x 3 pcs</b>
GS1705125-SS	5 cm x 5 cm	17	12	5 pcs	20 x 5 pcs
GS17051210-SS	5 cm x 5 cm	17	12	10 pcs	20 x 10 pcs
GS1775122-SS	7,5 cm x 7,5 cm	17	12	2 pcs	50 x 2 pcs
GS1775123-SS	7,5 cm x 7,5 cm	17	12	3 pcs	50 x 3 pcs
<b>GS1775123-S-IP</b>	<b>7,5 cm x 7,5 cm</b>	<b>17</b>	<b>12</b>	<b>3x1 pcs</b>	<b>20 x 3 pcs</b>
GS1775125-SS	7,5 cm x 7,5 cm	17	12	5 pcs	20 x 5 pcs
GS17751210-SS	7,5 cm x 7,5 cm	17	12	10 pcs	40 x 10 pcs
GS17751220-SS	7,5 cm x 7,5 cm	17	12	20 pcs	20 x 20 pcs
GS1710123-SS	10 cm x 10 cm	17	12	3 pcs	50 x 3 pcs
<b>GS1710123-S-IP</b>	<b>10 cm x 10 cm</b>	<b>17</b>	<b>12</b>	<b>3x1 pcs</b>	<b>20 x 3 pcs</b>
GS1710125-SS	10 cm x 10 cm	17	12	5 pcs	20 x 5 pcs
GS17101210-SS	10 cm x 10 cm	17	12	10 pcs	20 x 10 pcs
GS17101220-SS	10 cm x 10 cm	17	12	20 pcs	20 x 20 pcs
GS171020123-SS	10 cm x 20 cm	17	12	3 pcs	50 x 3 pcs
GS1710201210-SS	10 cm x 20 cm	17	12	10 pcs	10 x 10 pcs
GS171020125-SS	10 cm x 20 cm	17	12	5 pcs	20 x 5 pcs
GS1705163-SS	5 cm x 5 cm	17	16	3 pcs	50 x 3 pcs
GS1705165-SS	5 cm x 5 cm	17	16	5 pcs	30 x 5 pcs
GS1775163-SS	7,5 cm x 7,5 cm	17	16	3 pcs	50 x 3 pcs
GS1775165-SS	7,5 cm x 7,5 cm	17	16	5 pcs	20 x 5 pcs
GS17751610-SS	7,5 cm x 7,5 cm	17	16	10 pcs	16 x 10 pcs
GS1710163-SS	10 cm x 10 cm	17	16	3 pcs	50 x 3 pcs
GS1710165-SS	10 cm x 10 cm	17	16	5 pcs	30 x 5 pcs
GS17101610-SS	10 cm x 10 cm	17	16	10 pcs	20 x 10 pcs
GS171020163-SS	10 cm x 20 cm	17	16	3 pcs	50 x 3 pcs
GS1710201610-SS	10 cm x 20 cm	17	16	10 pcs	10 x 10 pcs

Sterilization method:

- -S - EO sterilized product - on request
- -SS - steam sterilized product

with X-ray detectable thread

REF	dimensions	no. of threads	no. of plies	packaging unit paper-foil	bulk packaging box
GS17750810-SSXR	7,5 cm x 7,5 cm	17	8	10 pcs	40 x 10 pcs
GS17750820-SSXR	7,5 cm x 7,5 cm	17	8	20 pcs	20 x 20 pcs
✓ GS17100810-SSXR	10 cm x 10 cm	17	8	10 pcs	40 x 10 pcs
* GS1705125-SSXR	5 cm x 5 cm	17	12	5 pcs	20 x 5 pcs
* GS17051210-SSXR	5 cm x 5 cm	17	12	10 pcs	40 x 10 pcs
✓ GS1775125-SSXR	7,5cm x 7,5cm	17	12	5 pcs	20 x 5 pcs
✓ GS17751210-SSXR	7,5cm x 7,5cm	17	12	10 pcs	10 x 10 pcs
✓ GS17101210-SSXR	10cm x 10cm	17	12	10 pcs	20 x 10 pcs
✓ GS17101220-SSXR	10cm x 10cm	17	12	20 pcs	20 x 20 pcs
✓ GS17101240-SSXR	10cm x 10cm	17	12	40 pcs	10 x 40 pcs
✓ GS1710201210-SSXR	10cm x 20cm	17	12	10 pcs	10 x 10 pcs
✓ GS1710201220-SSXR	10cm x 20cm	17	12	20 pcs	6 x 20 pcs
* GS17051610-SSXR	5 cm x 5 cm	17	16	10 pcs	30 x 10 pcs
✓ GS1775165-SSXR	7,5 cm x 7,5 cm	17	16	5 pcs	20 x 5 pcs
✓ GS17751610-SSXR	7,5 cm x 7,5 cm	17	16	10 pcs	16 x 10 pcs
* GS1710165-SSXR	10 cm x 10 cm	17	16	5 pcs	20 x 5 pcs
✓ GS17101610-SSXR	10 cm x 10 cm	17	16	10 pcs	20 x 10 pcs



✓  
self-adhesive  
labels for medical  
documentation

\*   
available  
on request

# GAUZE LAP SPONGES

## features

- 100% hydrophilic cotton
- bleached with the use of hydrogen peroxide
- with a sewed in X-ray detectable thread or chip, which enables fast and non-invasive identification of the lap sponge left in the operating field
- with a belt to fix the lap sponge beyond the operating field

## indication

- as a surgical invasive dressing material for intraoperative absorption of large amounts of blood and body fluids from surgical wounds



Before use on open wounds, the device must be sterilized in accordance with a validated sterilization method. It can be sterilized with steam or ethylene oxide.

## gauze lap sponges

### SERVI lux



non-sterile

with X-ray thread and belt

REF	dimensions	no. of threads	no. of plies	packaging unit foil bag	bulk packaging carton
LS1745454-XB	45 cm x 45 cm	17	4	20 pcs	10 x 20 pcs
LS1745704-XB	45 cm x 70 cm	17	4	20 pcs	10 x 20 pcs
LS1745456-XB	45 cm x 45 cm	17	6	20 pcs	10 x 20 pcs
LS1745706-XB	45 cm x 70 cm	17	6	20 pcs	10 x 20 pcs
LS1745458-XB	45 cm x 45 cm	17	8	20 pcs	10 x 20 pcs
LS2045454-XB	45 cm x 45 cm	20	4	20 pcs	10 x 20 pcs

pre-washed with X-ray chip and belt

REF	dimensions	no. of threads	no. of plies	packaging unit foil bag	bulk packaging carton
LS2045454-XB-PW	45 cm x 45 cm	20	4	20 pcs	10 x 20 pcs



The advantages of self-adhesive labels for medical documentation:

- fast data transport without the need to rewrite,
- safe identification of the device - elimination of the possibility of errors,
- improvement of the preparation of medical documentation.

### SERVI lux S



sterile

with X-ray thread and belt

REF	dimensions	no. of threads	no. of plies	packaging unit paper-foil	bulk packaging box
✓ LS1745454-SSXB	45 cm x 45 cm	17	4	2 pcs	20 x 2 pcs
✓ LS1745454-SSXB	45 cm x 45 cm	17	4	5 pcs	8 x 5 pcs
✓ LS1745704-SSXB	45 cm x 70 cm	17	4	2 pcs	20 x 2 pcs
✓ LS1745456-SSXB	45 cm x 45 cm	17	6	3 pcs	10 x 3 pcs
✓ LS1745458-SSXB	45 cm x 45 cm	17	8	2 pcs	10 x 2 pcs
✓ LS1745458-SSXB	45 cm x 45 cm	17	8	5 pcs	5 x 5 pcs
✓ LS1745704-SSXB	45 cm x 70 cm	17	4	3 pcs	10 x 3 pcs
✓ LS17759041-SSXB	75 cm x 90 cm	17	4	1 pc.	15 x 1 pcs

✓  
self-adhesive labels for medical documentation



Before use on open wounds, the device must be sterilized in accordance with a validated sterilization method. It can be sterilized with steam or ethylene oxide.

## gauze balls

### TUPFER lux

 non-sterile

#### features

- 100% hydrophilic cotton
- bleached with the use of hydrogen peroxide
- available in a version with or without X-ray detectable thread, which enables fast and non-invasive identification of the gauze ball left in the operating field

#### indication

- absorption of blood and body fluids from surgical wounds and hard to reach places

#### without X-ray thread

REF	size of gauze	shape	packaging unit foil bag	bulk packaging carton
TK1515250	15 cm x 15 cm	ball	250 pcs	24 x 250 pcs
TK2020250	20 cm x 20 cm	ball	250 pcs	24 x 250 pcs
TK3030100	30 cm x 30 cm	ball	100 pcs	10 x 100 pcs

#### with X-ray thread

REF	size of gauze	shape	packaging unit foil bag	bulk packaging carton
TK1515250X	15 cm x 15 cm	ball	250 pcs	24 x 250 pcs
TK2020250X	20 cm x 20 cm	ball	250 pcs	24 x 250 pcs
TK2525250X	25 cm x 25 cm	ball	250 pcs	8 x 250 pcs
TK3030100X	30 cm x 30 cm	ball	100 pcs	10 x 100 pcs
TK3040100X	30 cm x 40 cm	ball	100 pcs	10 x 100 pcs
TK5050100X	50 cm x 50 cm	ball	100 pcs	10 x 100 pcs



### TUPFER lux S

 sterile

  
self-adhesive labels for medical documentation

REF	size of gauze	shape	packaging unit paper-foil	bulk packaging carton
✓ TF959505-SSXR	9,5 cm x 9,5 cm	bean	5 pcs	50 x 5 pcs
✓ TF959510-SSXR	9,5 cm x 9,5 cm	bean	10 pcs	25 x 10 pcs
✓ TF151505-SSXR	15 cm x 15 cm	bean	5 pcs	25 x 5 pcs
✓ TF151510-SSXR	15 cm x 15 cm	bean	10 pcs	20 x 10 pcs
✓ TR121205-SSXR	12 cm x 12 cm	triangular	5 pcs	15 x 5 pcs
✓ TR181810-SSXR	18 cm x 18 cm	triangular	10 pcs	10 x 10 pcs
✓ TK151510-SSXR	15 cm x 15 cm	ball	10 pcs	20 x 10 pcs
✓ TK202010-SSXR	20 cm x 20 cm	ball	10 pcs	20 x 10 pcs
✓ TK303010-SSXR	30 cm x 30 cm	ball	10 pcs	10 x 10 pcs



## non-woven swabs

### NONVI lux



non-sterile

Before use on open wounds, the device must be sterilized in accordance with a validated sterilization method. It can be sterilized with steam, ethylene oxide or radiation.

REF	dimensions	grammage	packaging unit paper bag	bulk packaging carton
NL50-100	5 cm x 5 cm	30 g/m <sup>2</sup>	100 pcs	50 x 100 pcs
NL50-100-40	5 cm x 5 cm	40 g/m <sup>2</sup>	100 pcs	50 x 100 pcs
NL75-100	7,5 cm x 7,5 cm	30 g/m <sup>2</sup>	100 pcs	40 x 100 pcs
NL75-100-40	7,5 cm x 7,5 cm	40 g/m <sup>2</sup>	100 pcs	40 x 100 pcs
NL100-100	10 cm x 10 cm	30 g/m <sup>2</sup>	100 pcs	40 x 100 pcs
NL100-100-40	10 cm x 10 cm	40 g/m <sup>2</sup>	100 pcs	20 x 100 pcs
NL1020-100	10 cm x 20 cm	30 g/m <sup>2</sup>	100 pcs	20 x 100 pcs



### NONVI lux S



sterile

REF	dimensions	grammage	packaging unit paper-foil	bulk packaging box
NL052-S	5 cm x 5 cm	30 g/m <sup>2</sup>	2 pcs	25 x 2 pcs
NL053-S	5 cm x 5 cm	30 g/m <sup>2</sup>	3 pcs	25 x 3 pcs
NL055-S	5 cm x 5 cm	30 g/m <sup>2</sup>	5 pcs	25 x 5 pcs
NL0510-S	5 cm x 5 cm	30 g/m <sup>2</sup>	10 pcs	10 x 10 pcs
NL052-S-40	5 cm x 5 cm	40 g/m <sup>2</sup>	2 pcs	25 x 2 pcs
NL053-S-40	5 cm x 5 cm	40 g/m <sup>2</sup>	3 pcs	25 x 3 pcs
NL055-S-40	5 cm x 5 cm	40 g/m <sup>2</sup>	5 pcs	25 x 5 pcs
NL0510-S-40	5 cm x 5 cm	40 g/m <sup>2</sup>	10 pcs	10 x 10 pcs
NL752-S	7,5 cm x 7,5 cm	30 g/m <sup>2</sup>	2 pcs	25 x 2 pcs
NL753-S	7,5 cm x 7,5 cm	30 g/m <sup>2</sup>	3 pcs	25 x 3 pcs
NL755-S	7,5 cm x 7,5 cm	30 g/m <sup>2</sup>	5 pcs	25 x 5 pcs
NL7510-S	7,5 cm x 7,5 cm	30 g/m <sup>2</sup>	10 pcs	10 x 10 pcs
NL752-S-40	7,5 cm x 7,5 cm	40 g/m <sup>2</sup>	2 pcs	25 x 2 pcs
NL753-S-40	7,5 cm x 7,5 cm	40 g/m <sup>2</sup>	3 pcs	25 x 3 pcs
NL755-S-40	7,5 cm x 7,5 cm	40 g/m <sup>2</sup>	5 pcs	25 x 5 pcs
NL7510-S-40	7,5 cm x 7,5 cm	40 g/m <sup>2</sup>	10 pcs	10 x 10 pcs
* NL7520-S-40	7,5 cm x 7,5 cm	40 g/m <sup>2</sup>	20 pcs	5 x 20 pcs
NL102-S	10 cm x 10 cm	30 g/m <sup>2</sup>	2 pcs	25 x 2 pcs
NL103-S	10 cm x 10 cm	30 g/m <sup>2</sup>	3 pcs	25 x 3 pcs
NL105-S	10 cm x 10 cm	30 g/m <sup>2</sup>	5 pcs	20 x 5 pcs
NL1010-S	10 cm x 10 cm	30 g/m <sup>2</sup>	10 pcs	10 x 10 pcs
NL102-S-40	10 cm x 10 cm	40 g/m <sup>2</sup>	2 pcs	25 x 2 pcs
NL103-S-40	10 cm x 10 cm	40 g/m <sup>2</sup>	3 pcs	25 x 3 pcs
NL105-S-40	10 cm x 10 cm	40 g/m <sup>2</sup>	5 pcs	20 x 5 pcs
NL1010-S-40	10 cm x 10 cm	40 g/m <sup>2</sup>	10 pcs	10 x 10 pcs
NL1020-S-40	10 cm x 10 cm	40 g/m <sup>2</sup>	20 pcs	5 x 20 pcs

Sterilization method:

- -S - EO sterilized product
- -SS - steam sterilized product

## NON-WOVEN SWABS

### features

- hydrophilic medical non-woven, 30 or 40 g/m<sup>2</sup>
- 4-ply
- soft, non-fraying, durable

### indication

- general wound dressing in out-patient clinics, surgical sites, procedure department



available on request



swab with „Y“ incision

## NONVI lux S with Y-incision



sterile

### features

- hydrophilic medical non-woven 40 g/m<sup>2</sup>
- 4-ply
- Y-incision for precise, aseptic protection of the outlet of various types of medical drains

### indication

- securing the outlet of drains, catheters, tracheostomy tubes etc.

REF sterilized by EO	REF sterilized by steam	dimensions	packaging unit paper-foil	bulk packaging box
NL105-S-40Y	* NL105-SS-40Y	10 cm x 10 cm	5 pcs	20 x 5 pcs



# ABSORBENT WOUND DRESSINGS

## features

- layered structure: non-woven - cellulose - cellulose pulp
- increased absorption capacity due to the high absorbent cellulose layer
- bottom layer of the dressing covered with waterproof blue non-woven

## indication

- removing the exudate from strongly oozing wounds
- covering wounds after surgical procedures

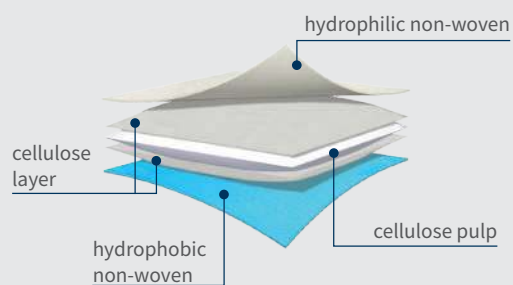

## ABD pads, multi-layer

### MULTIabsorb

~~STERILE~~ non-sterile

Before use on open wounds, the device must be sterilized in accordance with a validated sterilization method. It can be sterilized with ethylene oxide or radiation.

REF	dimensions	packaging unit foil bag	bulk packaging carton
ABD1010	10 cm x 10 cm	50 pcs	40 x 50 pcs
ABD1020	10 cm x 20 cm	50 pcs	20 x 50 pcs
ABD2025	20 cm x 25 cm	50 pcs	12 x 50 pcs



### MULTIabsorb S

STERILE sterile

REF	dimensions	packaging unit paper-foil	intermediate packaging box	bulk packaging carton
ABD1010-S	10 cm x 10 cm	1 pc.	25 x 1 pc.	24 x 25 pcs
ABD1020-S	10 cm x 20 cm	1 pc.	25 x 1 pc.	18 x 25 pcs
ABD2025-S	20 cm x 25 cm	1 pc.	15 x 1 pc.	18 x 15 pcs
ABD2040-S	20 cm x 40 cm	1 pc.	8 x 1 pc.	12 x 8 pcs

## EYE DRESSINGS

### features

- layered structure: non-woven + cellulose pulp
- needs to be fixed with a secondary dressing e.g. with adhesive tape or tubular net bandage
- hypoallergenic

### indication

- covering an eye and its area after ophthalmic procedures and surgical procedures
- sight correction in strabismus therapy

82



## eye pads

### elastoLUMENAL



non-sterile

Before use on open wounds, the device must be sterilized in accordance with a validated sterilization method. It can be sterilized with ethylene oxide or radiation.

REF	dimensions	packaging unit paper-paper	intermediate packaging box	bulk packaging carton
803311	5,5 cm x 7,5 cm	1 pc.	50 x 1 pc.	24 x 50 pcs



### elastoLUMENAL S



sterile

REF	dimensions	packaging unit paper-paper	intermediate packaging box	bulk packaging carton
803310	5,5 cm x 7,5 cm	1 pc.	50 x 1 pc.	24 x 50 pcs

Conforms well to facial contours thanks to the oval shape.



## ADHESIVE TAPES AND PLASTERS WITH DRESSING

## ADHESIVE TAPES

### features

- flexible, conforms to the body's contours, guarantees freedom of movement
- characterized by adequate air and water vapour permeability
- good adhesion
- can be divided lengthwise and widthwise without the use of scissors
- hypoallergenic

### indication

- stabilization, protection and fixation of primary, non-adhesive dressings, applied directly to wounds and skin damages
- stabilization, protection and fixation of drains, catheters, medical tubes that do not require specialized fixing in the place of their insertion



## adhesive fabric tape, white

### SENSIplast

 non-sterile

REF	dimensions	packaging unit box	bulk packaging carton
STA12505W	1,25 cm x 5 m	24 pcs	30 x 24 pcs
STA25005W	2,5 cm x 5 m	12 pcs	30 x 12 pcs
STA50005W	5 cm x 5 m	6 pcs	30 x 6 pcs
STA12509W	1,25 cm x 9,14 m	24 pcs	30 x 24 pcs
STA25009W	2,5 cm x 9,14 m	12 pcs	30 x 12 pcs
STA50009W	5 cm x 9,14 m	6 pcs	30 x 6 pcs

  
made of woven fabric

  
serrated edge

  
spooled

  
white colour



## adhesive fabric tape, beige colour

### PLASTIplast

 non-sterile

REF	dimensions	packaging unit box	bulk packaging carton
SZO12505S	1,25 cm x 5 m	24 pcs	30 x 24 pcs
SZO25005S	2,5 cm x 5 m	12 pcs	30 x 12 pcs
SZO50005S	5 cm x 5 m	6 pcs	30 x 6 pcs

  
made of woven fabric

  
serrated edge

  
on a roll

  
beige colour



## adhesive non-woven tape

### SOFTplast

 non-sterile

REF	dimensions	packaging unit box	bulk packaging carton
SNW12505W	1,25 cm x 5 m	24 pcs	30 x 24 pcs
SNW25005W	2,5 cm x 5 m	12 pcs	30 x 12 pcs
SNW50005W	5 cm x 5 m	6 pcs	30 x 6 pcs
SNW12509W	1,25 cm x 9,14 m	24 pcs	30 x 24 pcs
SNW25009W	2,5 cm x 9,14 m	12 pcs	30 x 12 pcs
SNW50009W	5 cm x 9,14 m	6 pcs	30 x 6 pcs

  
made of  
non-woven  
fabric

  
straight  
edge

  
on a roll

  
white  
colour



## adhesive silk tape

### SILKplast

 non-sterile

REF	dimensions	packaging unit box	bulk packaging carton
SS12505W	1,25 cm x 5 m	24 pcs	30 x 24 pcs
SS25005W	2,5 cm x 5 m	12 pcs	30 x 12 pcs
SS50005W	5 cm x 5 m	6 pcs	30 x 6 pcs
SS12509W	1,25 cm x 9,14 m	24 pcs	30 x 24 pcs
SS25009W	2,5 cm x 9,14 m	12 pcs	30 x 12 pcs
SS50009W	5 cm x 9,14 m	6 pcs	30 x 6 pcs

  
made of  
rayon

  
serrated  
edge

  
on a roll

  
white  
colour



## adhesive PE tape

### FILMplast

 non-sterile

REF	dimensions	packaging unit box	bulk packaging carton
SPE12505W	1,25 cm x 5 m	24 pcs	30 x 24 pcs
SPE25005W	2,5 cm x 5 m	12 pcs	30 x 12 pcs
SPE50005W	5 cm x 5 m	6 pcs	30 x 6 pcs
SPE12509W	1,25 cm x 9,14 m	24 pcs	30 x 24 pcs
SPE25009W	2,5 cm x 9,14 m	12 pcs	30 x 12 pcs
SPE50009W	5 cm x 9,14 m	6 pcs	30 x 6 pcs

  
made of poly-ethylene foil

  
straight edge

  
on a roll

  
transparent

  
perforation for easy dividing

  
air permeable structure

Microporous structure permeable to air and water vapor, allowing proper gas exchange between the foil and the skin, which prevents maceration of the skin.



## adhesive perforated non-woven tape

### POREplast

 non-sterile

REF	dimensions	packaging unit box	bulk packaging carton
SPW25009W	2,5 cm x 9,14 m	12 pcs	30 x 12 pcs

  
made of perforated non-woven fabric

  
straight edge

  
on a roll

  
white colour

  
perforation for easy dividing



## PLASTERS WITH DRESSING

### features

- self-adhesive plasters with absorbent pads
- centrally situated absorbent pad absorbs a small and medium amount of exudate and protects from external factors
- absorbent pad coated with a polyethylene mesh that prevents sticking to the wound
- characterized by adequate air and water vapour permeability
- flexible, conforms to the body's contours, guarantees freedom of movement
- silicone backing paper facilitates precise, painless and efficient application
- hypoallergenic

### indication

- protection of small skin injuries, cuts, abrasions and lacerations



## non-woven plaster with dressing

### NONVIplast

 non-sterile

REF	dimensions	packaging unit box	bulk packaging carton
NP6100	6 cm x 1 m	1 pc.	200 x 1 pc.
NP6500	6 cm x 5 m	1 pc.	100 x 1 pc.
NP8100	8 cm x 1 m	1 pc.	200 x 1 pc.
NP8500	8 cm x 5 m	1 pc.	100 x 1 pc.

  
made of hydrophobic non-woven

  
air permeable structure

  
possibility of cutting

  
white colour



## fabric plaster with dressing

### FABRIplast

 non-sterile

REF	dimensions	packaging unit box	bulk packaging carton
FP6100	6 cm x 1 m	1 pc.	200 x 1 pc.
FP6500	6 cm x 5 m	1 pc.	100 x 1 pc.
FP8100	8 cm x 1 m	1 pc.	200 x 1 pc.
FP8500	8 cm x 5 m	1 pc.	100 x 1 pc.

  
made of cotton fabric

  
air permeable structure

  
possibility of cutting

  
beige colour



## SPECIAL PURPOSE DRESSINGS

[WWW.ZARYS.COM](http://WWW.ZARYS.COM)







## SELF-ADHESIVE NON-WOVEN DRESSINGS

### DRESSING TAPE

#### features

- made of hydrophobic non-woven
- covered with hypoallergenic acrylic glue
- micropores in the structure of the non-woven provide adequate vapor permeability, thanks to which a proper gas exchange between the dressing and the skin takes place
- flexible, conforms to the body's contours, guarantees freedom of movement
- backing layer made of silicone paper
- backing paper with metric scale facilitates the division of the tape and precise, painless and efficient application
- packed in a cardboard box - a dispenser that allows dosing without removing the tape from the packaging

#### indication

- stabilization, protection and fixation of primary, non-adhesive dressings, applied directly to wounds and skin damages
- stabilization, protection and fixation of drains, catheters, medical tubes



made of hydrophobic non-woven



air permeable structure



possibility of cutting



white colour

### adhesive non-woven dressing tape

#### elastopor



non-sterile

REF	dimensions	packaging unit box	bulk packaging carton
806009	2,5 cm x 10 m	1 pc.	200 pcs
806010	5 cm x 10 m	1 pc.	100 pcs
806011	10 cm x 10 m	1 pc.	50 pcs
806012	15 cm x 10 m	1 pc.	50 pcs
806013	20 cm x 10 m	1 pc.	25 pcs
806014	25 cm x 10 m	1 pc.	25 pcs
806015	30 cm x 10 m	1 pc.	25 pcs



straight intersection of backing paper

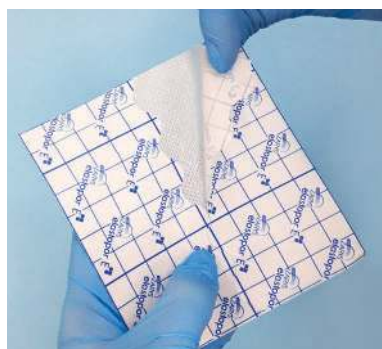

made of hydrophobic non-woven



air permeable structure



possibility of cutting



white colour

#### elastopor E



non-sterile

REF	dimensions	packaging unit box	bulk packaging carton
* 806009E	2,5 cm x 10 m	1 pc.	200 pcs
806010E	5 cm x 10 m	1 pc.	100 pcs
806011E	10 cm x 10 m	1 pc.	50 pcs
806012E	15 cm x 10 m	1 pc.	50 pcs
806013E	20 cm x 10 m	1 pc.	25 pcs
806014E	25 cm x 10 m	1 pc.	25 pcs
806015E	30 cm x 10 m	1 pc.	25 pcs



wavy intersection of backing paper



available on request

## SELF-ADHESIVE DRESSINGS WITH ABSORBENT PAD

### features

- self-adhesive dressings with centrally situated absorbent pad, made of hydrophobic non-woven, covered with acrylic glue
- absorbent pad coated with a polyethylene mesh that prevents sticking to the wound, absorbs a small and medium amount of exudate and protects against the influence of external factors
- rounded edges prevent accidental removal of the dressing
- silicone backing paper facilitates the precise, painless and efficient application
- micropores in the structure of the non-woven provide adequate vapor permeability, thanks to which a proper gas exchange between the dressing and the skin takes place
- hypoallergenic



## non-woven dressing with absorbent pad

### elastopor STERIL



#### indication

- especially recommended for covering surgical wounds
- for treating wounds with a small and medium amount of exudate

REF	dimensions	packaging unit paper-paper	bulk packaging box
801001	5 cm x 7,2 cm	1 pc.	100 x 1 pc.
801012	6 cm x 10 cm	1 pc.	50 x 1 pc.
801002	8 cm x 10 cm	1 pc.	30 x 1 pc.
801013	10 cm x 10 cm	1 pc.	30 x 1 pc.
801021	10 cm x 12 cm	1 pc.	30 x 1 pc.
801014	10 cm x 15 cm	1 pc.	30 x 1 pc.
801003	6 cm x 15 cm	1 pc.	50 x 1 pc.
801004	8 cm x 15 cm	1 pc.	30 x 1 pc.
801005	8 cm x 20 cm	1 pc.	30 x 1 pc.
801015	10 cm x 20 cm	1 pc.	25 x 1 pc.
801016	10 cm x 25 cm	1 pc.	25 x 1 pc.
801017	10 cm x 30 cm	1 pc.	25 x 1 pc.
801018	10 cm x 35 cm	1 pc.	25 x 1 pc.



## non-woven IV cannula dressing

### elastopor IV



#### features

- centrally situated absorbent pad protects the non-woven material from sticking to the injection site
- non-woven lining should be placed under cannula's wings, which prevents it from causing damage to the skin

#### indication

- dressing application around the inserted cannula
- stabilization, protection and fixation of intravenous cannulas

REF	dimensions	packaging unit paper-paper	bulk packaging box
811013	6 cm x 8 cm	1 pc.	100 x 1 pc.
811012	5,1 cm x 7,6 cm	1 pc.	100 x 1 pc.
811023	6 cm x 8 cm	1 pc.	50 x 1 pc.
811022	5,1 cm x 7,6 cm	1 pc.	50 x 1 pc.



## non-woven dressing with absorbent pad, incision and O-hole

### elastopor STERIL D

**STERILE** sterile

#### indication

- dressing application around the inserted drain
- securing the outlet of drains and catheters
- for treating wounds with a small and medium amount of exudate

 made of hydrophobic non-woven

 air permeable structure

 white colour

REF	dimensions	packaging unit paper-paper	bulk packaging box
801031	9 cm x 10 cm	1 pc.	30 x 1 pc.
801030	12 cm x 14 cm	1 pc.	25 x 1 pc.



## non-woven eye dressing with absorbent pad

### elastopor EYE

**STERILE** sterile

#### indication

- covering an eye and its area after ophthalmic procedures and surgical procedures
- sight correction in strabismus therapy

Conforms well to facial contours thanks to the oval shape.

 white or skin colour

REF	dimensions	shape	colour	packaging unit paper-paper	bulk packaging box
803010	5,8 cm x 8,3 cm		absorbent pad - white	1 pc.	50 x 1 pc.
803011	6,5 cm x 9,4 cm		non-woven material - white	1 pc.	50 x 1 pc.
803212	5 cm x 7,5 cm		absorbent pad - white non-woven material - beige colour	1 pc.	50 x 1 pc.



## HOW TO CHOOSE A DRESSING PROPERLY?

When choosing the proper type of dressing, pay special attention to:

- absorption rate and absorption capacity,
- vapor permeability,
- possibility of an atraumatic dressing change,
- safety of use.

## SELF-ADHESIVE DRESSINGS FOR KIDS

### features

- self-adhesive dressing with absorbent pad, made of hydrophobic non-woven material with color overprint, covered by hypoallergenic glue
- absorbent pad coated with polyethylene mesh to prevent sticking to the wound, absorbing small and medium amounts of exudate and protecting against external influences
- rounded edges to prevent accidental removal of the dressing
- protective layer of silicone paper for precise, painless and effective application
- micropores in the non-woven material structure provide an adequate rate of moisture vapour permeability so correct gas exchange between the dressing and skin is guaranteed



### non-woven IV cannula dressing

#### elastoKIDS IV



#### features

- centrally situated absorbent pad protects the non-woven material from sticking to the injection site
- non-woven lining should be placed under cannula's wings, which prevents it from causing damage to the skin

#### indication

- application of the dressing around the cannula
- stabilization, protection and fixation of intravenous cannulas

REF	dimensions	packaging unit paper-paper	bulk packaging box
811001A	5,1 cm x 7,6 cm	1 pc.	100 x 1 pc.



### non-woven dressing with absorbent pad

#### elastoKIDS STERIL



#### indication

- especially recommended for covering surgical wounds
- treating wounds with a small and medium amount of exudate

REF	dimensions	packaging unit paper-paper	bulk packaging box
801012A	6 cm x 10 cm	1 pc.	50 x 1 pc.



## STABILIZING TAPES



↑↑↑  
: : :  
air permeable structure

beige colour

## non-woven nasal cannula fixation plaster

### elastoNASAL

 non-sterile

#### features

- flexible fixation plaster made of non-woven
- covered with acrylic glue
- adequate vapor permeability, thanks to which a proper gas exchange between the dressing and the skin takes place
- thin and flexible plaster is comfortable for the patient, conforms to the body's contours
- "two-stage" application type facilitates precise and efficient application
- self-adhesive
- hypoallergenic

#### indication

- stabilization of catheters and stomach tubes fixed in the nasal area

REF	dimensions	purpose	packaging unit box
811014	7 cm x 7,1 cm	for adults	50 x 1 pc.
811015	5,9 cm x 6,2 cm	for children	50 x 1 pc.
811016	3,6 cm x 4 cm	for infants	50 x 1 pc.

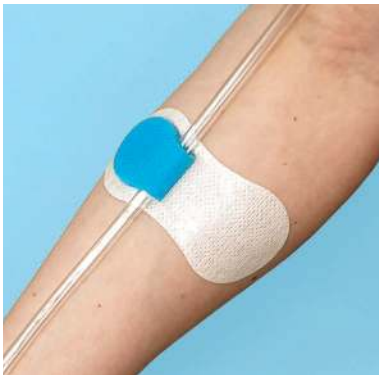

↑↑↑  
: : :  
air permeable structure

blue-white colour

## adhesive tape for catheter tubing fixation

### elastoFIXAL

 non-sterile

#### features

- two-part fixing tape consisting of a part attached to the skin and a part fastening the drain
- part attached to the patient's skin made of non-woven fabric
- drain fixing part is integrated with a part adhered to the patient's skin and has an additional adhesive tape - Velcro and adhesive field for better drain stabilization
- possibility of reposition and correction of the drain position thanks to Velcro
- covered with hypoallergenic glue

#### indication

- stabilization of various types of drains and catheters

REF	dimensions	packaging unit paper-foil	bulk packaging box
816101	9 cm x 4 cm	1 pc.	50 x 1 pc.



↑↑↑  
: : :  
air permeable  
structure

white  
colour

## adhesive tape for endotracheal tube

### elastoFIXAL Set

 non-sterile

#### features

- set consisting of 2 self-adhesive non-woven pads and a fastening strap
- self-adhesive non-woven pads attached to the patient's cheeks with an adhesive part with Velcro on the other side
- a strap for stabilization of the endotracheal or oropharyngeal tube made of non-woven fabric which should be attached to the velcro layer with which the pads are covered
- adhesive area in the middle of the strip for better stabilization of the medical tube
- the possibility of repositioning and correcting the position of the tube thanks to the Velcro
- pads and strap covered with hypoallergenic glue
- has excellent adhesive properties and high mechanical strength which prevents premature and accidental detachment from the skin

#### indication

- long-term stabilization of the endotracheal or oropharyngeal tube

REF	kit composition	packaging unit paper-foil	bulk packaging
816102	2 self-adhesive non-woven pads 1 fastening strap	1 set	100x1 set



  
made of  
a delicate  
material

beige  
colour

## band for tracheostomy tube fixation

### elastoFIXAL TUBE

 non-sterile

#### features

- stabilising band consisting of two parts made of gentle hydrophobic non-woven fabric in flesh-coloured
- on each part there are fastening strips with Velcro on one side enabling to attach to the fastening wings of the tracheostomy tube
- shorter part of the stabilising band is additionally equipped with a second Velcro strap attached to an elastic white rubber band which makes it possible to adjust and determine the total length of the band stabilising the tracheostomy tube
- hypoallergenic
- single use
- non-sterile
- shelf life: 5 years

REF	dimensions	packaging unit paper-foil	bulk packaging
EFT2520	25cm x 2,0 cm	1 set	30x30 pcs
EFT4325	43cm x 2,5 cm	1 set	30x20 pcs



## STABILIZING DRESSINGS



## FIXATION OF DRESSINGS

### SUPPORTING BANDAGES

#### features

- delicate, light, air and X-ray permeable
- conforms good to the body's contours
- hypoallergenic

#### indication

- fixation of all types of non-adhesive dressings



### knitted supporting bandage

#### elastoBAND BASIC

 non-sterile

#### features

- contains viscose
- single-use

REF	dimensions	packaging unit paper	bulk packaging carton
OD05400	5 cm x 4 m	1 pc.	250 x 1 pc.
OD10400	10 cm x 4 m	1 pc.	150 x 1 pc.
OD15400	15 cm x 4 m	1 pc.	100 x 1 pc.



### elastic supporting bandage, woven

#### elastoBAND FLEX

 non-sterile

#### features

- supporting bandage, elastic, woven
- high cotton content makes the bandage safe for the skin and well-tolerated by people with allergic tendency
- equipped with a clip for fixing

#### indication

- fixation of all types of non-adhesive dressings, especially where a non-elastic bandages can slide down
- in compression therapy to facilitate correct blood circulation
- stabilization at bone-articular system damage, e.g. dislocation, joint twisting, weakness of muscles, tendons and ligaments
- as a sports bandage
- securing and strengthening integument after surgery

REF - cardboard box	REF - paper pouch	dimensions	packaging unit box/paper	bulk packaging carton
OE08400-E	OE08400P-E	8 cm x 4 m	1 pc.	124 x 1 pc.
OE10400-E	OE10400P-E	10 cm x 4 m	1 pc.	108 x 1 pc.
OE12400-E	OE12400P-E	12 cm x 4 m	1 pc.	96 x 1 pc.
OE15400-E	OE15400P-E	15 cm x 4 m	1 pc.	72 x 1 pc.
OE08500-E	OE08500P-E	8 cm x 5 m	1 pc.	124 x 1 pc.
OE10500-E	OE10500P-E	10 cm x 5 m	1 pc.	108 x 1 pc.
OE12500-E	OE12500P-E	12 cm x 5 m	1 pc.	96 x 1 pc.
OE15500-E	OE15500P-E	15 cm x 5 m	1 pc.	72 x 1 pc.



reusable





## elastic tubular net bandage

### elastoNET



#### features

- elastic net bandage in the form of a tube
- contains polyamide and elastomer
- high stretchability and strength of returning to pre-stretch state
- elastic and very soft
- easy and quick to use
- length before stretching:
  - 1 m, stretched: 2,5 m
  - 10 m, stretched: 25 m

#### indication

- fixation of all dressings on the patient's body, replacing the traditional bandage
- the use of tubular net bandage reduces the time of wound dressing and makes it easier to fix the dressing to the patient's body

REF	length before stretching	size	indication	packaging unit box - dispenser
SO-0101	1 m	1	finger	1 pc.
SO-0110	10 m	1	finger	1 pc.
SO-0201	1 m	2	hand, toe	1 pc.
SO-0210	10m	2	hand, toe	1 pc.
SO-0301	1 m	3	hand, foot	1 pc.
SO-0310	10 m	3	hand, foot	1 pc.
SO-0401	1 m	4	lower leg, knee, arm, foot, elbow	1 pc.
SO-0410	10 m	4	lower leg, knee, arm, foot, elbow	1 pc.
SO-0601	1 m	6	head, shoulder, lower leg, knee	1 pc.
SO-0610	10 m	6	head, shoulder, lower leg, knee	1 pc.
SO-0801	1 m	8	thigh, head, hips	1 pc.
SO-0810	10 m	8	thigh, head, hips	1 pc.
SO-1001	1 m	10	hips, trunk	1 pc.
SO-1010	10 m	10	hips, trunk	1 pc.
SO-1401	1 m	14	chest, trunk	1 pc.
SO-1410	10 m	14	chest, trunk	1 pc.



### How to make a HIPOCRATES CAP?

### FIRST AID FOR DRESSING WOUNDS USING BANDAGES

Hippocrates' achievements in treating head wounds were so widespread and advanced that they are still used today. The Hippocrates cap also called "mitra" is a headgear that allows you to hold the dressing and stop bleeding of the head wound. It is made of two bandage tapes. The main purpose of using the Hippocrates cap is to hold the dressing directly protecting the bleeding head wound, seal and warm the head, hold the compress applied to the skull area, compression, strengthening and immobilization after surgery and additional protection against the external environment. This solution is used in the absence of access to dressings such as elastic dressings and scarves.

### RULES FOR BANDAGING

1. Prepare a two-head bandage about 5-6 cm wide by sewing together two bands or by twisting the free end to the middle.
2. Put the two-headed bandage on the back of the head and drive bandage to the forehead a circular move.
3. Cross the bandages on the forehead and drive one through the top of the head towards the occiput by a longitudinal move.
4. Drive the other bandage above the ear to the occiput also (half-round).
5. Scroll the longitudinal course through the circular course bandage.
6. Drive back the longitudinal course bandage across the top of the head to the forehead.
7. Drive the circular course bandage around the other ear to the forehead
8. Continue longitudinal and circular moves, the circular course bandage wraps around the scalp
9. Little by little, move the longitudinal course bandage towards the temples
10. After covering the whole area with a two-head bandage, fix the ends of bandage





## IMMOBILIZING DRESSINGS

### ORTHOPEDIC PADDINGS

#### features

- very soft and fluffy
- adhere well and adjusts to the shape of the body
- coherent structure resistant to stratification makes it easier placement of the immobilizing dressing
- minimize the risk of skin abrasions and irritations under the P.O.P. bandage
- do not absorb moisture and thus do not allow for its contact with the skin
- hypoallergenic

#### indication

- as a protective layer put under plaster of Paris bandages
- in compression therapy as a padding under the bandages of various elasticity



made of viscose



white colour



available on request

### orthopedic padding, natural

#### orthoNATURAL



non-sterile

REF	dimensions	packaging unit paper cover	bulk packaging foil bag
*ON-63	6 cm x 3 m	1 pc.	12 x 1 pc.
*ON-83	8 cm x 3 m	1 pc.	12 x 1 pc.
ON-103	10 cm x 3 m	1 pc.	12 x 1 pc.
ON-123	12 cm x 3 m	1 pc.	6 x 1 pc.
ON-153	15 cm x 3 m	1 pc.	6 x 1 pc.
*ON-203	20 cm x 3 m	1 pc.	6 x 1 pc.
*ON-253	25 cm x 3 m	1 pc.	6 x 1 pc.



made of polyester



white colour

### orthopedic padding, synthetic

#### orthoSYNTHETIC



non-sterile

REF	dimensions	packaging unit paper cover	bulk packaging foil bag
OS-63	6 cm x 3 m	1 pc.	12 x 1 pc.
OS-83	8 cm x 3 m	1 pc.	12 x 1 pc.
OS-103	10 cm x 3 m	1 pc.	12 x 1 pc.
OS-123	12 cm x 3 m	1 pc.	6 x 1 pc.
OS-153	15 cm x 3 m	1 pc.	6 x 1 pc.
OS-203	20 cm x 3 m	1 pc.	6 x 1 pc.
OS-253	25 cm x 3 m	1 pc.	6 x 1 pc.



white  
colour

## triangular sling

### elastoSLING



non-sterile

#### features

- triangle shaped sling made of non-woven or cotton
- thin, light and elastic - comfortable for the patient, adjusts to the shape of the body, provides freedom of movement
- possibility of connecting several slings to achieve bigger immobilization
- hypoallergenic

#### indication

- short-term immobilization and support of the upper limb in case of various injuries e.g. dislocation or fracture of collar bone, humerus, forearm or hand bone

REF	dimensions	description	packaging unit zipper pouch	bulk packaging foil bag
CHTW9696136	96 cm x 96 cm x 136 cm	non-woven	1 pc.	12 x 1 pc.
CHTB9696130	96 cm x 96 cm x 130 cm	cotton	1 pc.	12 x 1 pc.



### HOW TO PROPERLY PUT ON A TRIANGULAR SLING?

1. Place the triangular sling on the patient's body so that one of the corners of the sling is at the level of the elbow of the immobilized hand.
2. Place the second corner of the sling on the opposite arm in relation to the immobilized hand.
3. Carefully place the sick / injured limb on the sling.
4. Wrap the sick/injured limb with dangling, third corner of the sling.
5. Make sure that the hand is in the right position, and then tie the corners of the sling around the neck.

# P.O.P. BANDAGES

## features

- made of cotton gauze coated with natural plaster of Paris on both sides
- on a plastic roll
- enable fast and durable immobilization
- before fixing need to be soaked in a container with water at 20°C temperature
- do not absorb X-rays

## indication

- large and small immobilizing dressings in orthopedic, ambulatory and surgical procedures



## P.O.P. bandage



### orthoBAND FAST



fast-setting

setting time approx. **3 minutes**  
fully dry after approx. **24 hours**

REF	dimensions	type of edge	packaging unit foil bag	bulk packaging carton
OB06300-F	6 cm x 3 m	straight	1 pc.	48 x 1 pc.
OB08300-F	8 cm x 3 m	straight	1 pc.	48 x 1 pc.
OB10300-F	10 cm x 3 m	serrated	1 pc.	48 x 1 pc.
OB12300-F	12 cm x 3 m	serrated	1 pc.	48 x 1 pc.
OB14300-F	14 cm x 3 m	serrated	1 pc.	36 x 1 pc.
OB15300-F	15 cm x 3 m	serrated	1 pc.	36 x 1 pc.
OB20300-F	20 cm x 3 m	serrated	1 pc.	24 x 1 pc.



### orthoBAND NORMAL



fast-setting

setting time approx. **5-6 minutes**  
fully dry after approx. **24 hours**

REF	dimensions	type of edge	packaging unit foil bag	bulk packaging carton
OB06300-N	6 cm x 3 m	straight	1 pc.	48 x 1 pc.
OB08300-N	8 cm x 3 m	straight	1 pc.	48 x 1 pc.
OB10300-N	10 cm x 3 m	serrated	1 pc.	48 x 1 pc.
OB12300-N	12 cm x 3 m	serrated	1 pc.	48 x 1 pc.
OB14300-N	14 cm x 3 m	serrated	1 pc.	36 x 1 pc.
OB15300-N	15 cm x 3 m	serrated	1 pc.	36 x 1 pc.
OB20300-N	20 cm x 3 m	serrated	1 pc.	24 x 1 pc.



### orthoBAND LONG



slow-setting

setting time approx. **8-12 minutes**  
fully dry after approx. **24 hours**

REF	dimensions	type of edge	packaging unit foil bag	bulk packaging carton
OB10400-L	10 cm x 4 m	serrated	1 pc.	48 x 1 pc.
OB12400-L	12 cm x 4 m	serrated	1 pc.	36 x 1 pc.
OB15400-L	15 cm x 4 m	serrated	1 pc.	24 x 1 pc.

# RULES FOR BANDAGING

1.



Select a bandage of proper type and size for the part of the body to be bandaged.

2.

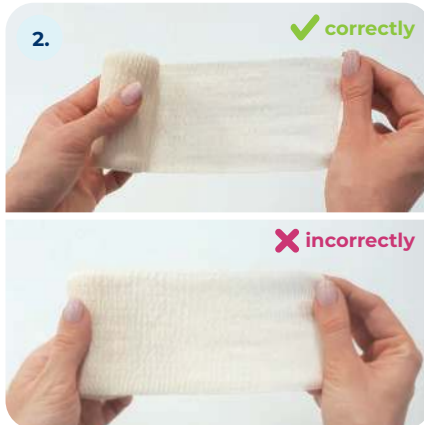

With your right hand, grasp the beginning of the band, and with your left hand hold the rolled part so called "head".

3.



Put the patient in a comfortable position supporting the bandaged lower or upper limb.

4.



For proper stabilization of dressing, start bandaging with a circular wrap, each subsequent layer covers exactly the previous one in a durable and aesthetic way. Little by little unroll the band during bandaging. Finish the bandaging with a circular wrap, end of the dressing secure with a clip or tie it.

5.



The bandage should adhere correctly to the patient's body and be rolled up with adequate power – too much pressure can lead to impaired circulation, too loose it will slide and fall.

6.



Remove the bandage by transferring it from one hand to other to minimize patient movement.



## SPECIALIST DRESSINGS

[WWW.ZARYS.COM](http://WWW.ZARYS.COM)





# paraffin gauze dressing

## paraffiNET



### features

- wide-mesh dressing made of cotton gauze covered with paraffin
- structure of the carrier material allows exudate to be freely drained to the covering secondary dressing
- covering with a layer of paraffin reduces risk of adhesion to the wound and allows a painless change of dressing
- neutral properties of paraffin allow for using the dressing in combination with other preparations containing medicinal substances or antiseptics
- can be shaped and cut according to the needs aseptically
- needs to be covered with a dressing with absorbent properties, e.g. compress, high-absorption dressing, polyurethane foam
- non-adhesive, necessary fixing with a tape, bandage or net tubular dressing
- hypoallergenic

### indication

- keeping proper moisture in the wound
- preventing the wound edges from drying and maceration
- recommended for uninfected wounds
- treatment of chronic wounds: various ulcers, bedsores
- treatment of surgical and burn wounds, skin donor and grafting sites, skin damage, cuts
- protection against radiation skin damage



soaked with paraffin



possibility of cutting

REF	dimensions	packaging unit paper-aluminum foil	bulk packaging box
PAR-01	5 cm x 5 cm	1 pc.	10 x 1 pc.
PAR-02	10 cm x 10 cm	1 pc.	10 x 1 pc.
PAR-06	10 cm x 40 cm	1 pc.	10 x 1 pc.
PAR-07	15 cm x 20 cm	1 pc.	10 x 1 pc.

## A NEW APPROACH TO WOUND HEALING

The most important factor affecting the effectiveness of wound healing is maintaining constant humidity within the wound. George D. Winter is a precursor of wet wound therapy, who in 1962 published his observations after experiment of creating a moist environment under polyurethane film and observing wound healing. Experience has shown that the wound heals under these conditions twice as fast as in unprotected conditions with a special film dressing.

Maintaining a moist environment in the wound stimulates the self-cleaning process, facilitates the autolysis of dead tissue, granulation growth, reduce the healing time.

It also prevents the dressing from sticking to the wound, allowing it to be changed without pain. While removing dressing there is no secondary tissue damage.



## FOIL DRESSINGS

### FOIL DRESSINGS

#### features

- made of polyurethane film
- covered with hypoallergenic acrylic glue
- transparent - they allow observation of the dressed place without the need to remove the dressing
- vapour permeability guarantees correct gas exchange between the dressing and the skin, and prevents it from excessive moisture accumulation and maceration
- barrier against microorganisms and bacteria, minimizing the risk of infection
- very thin and elastic - adjust to the shape of the body, guarantee freedom of movement
- waterproof
- self-adhesive
- hypoallergenic



1. Remove the back paper protection.



2. Apply the dressing to the desired place.

### foil dressing



sterile

#### features

- “frame” or three-stage” application system makes dressing placement precise and accurate
- available in several sizes and options:
  - with a central absorbent pad
  - with notch enabling the dressing to fit the cannulas
  - without notch and absorbent pad

### elastoDERM

dressing without absorbent pad, with “three-stage” application type

REF	dimensions	shape	indication	packaging unit paper-paper	bulk packaging box
811210	6 cm x 7 cm		- fixing and securing intravenous cannulas - secondary dressing - bedsore prevention, works as so-called „second skin” - for small epidermal abrasions and damages of the skin surface	1 pc.	100 x 1 pc.

### elastoDERM F

dressing without absorbent pad, with “frame” application type

REF	dimensions	shape	indication	packaging unit paper-paper	bulk packaging box
812003	4,4 cm x 4,4 cm		- fixing and securing intravenous cannulas - secondary dressing - bedsore prevention, works as so-called „second skin” - for small epidermal abrasions and damages of the skin surface	1 pc.	100 x 1 pc.
812005	6 cm x 7 cm		- fixing and securing intravenous cannulas - secondary dressing - bedsore prevention, works as so-called „second skin” - for small epidermal abrasions and damages of the skin surface	1 pc.	100 x 1 pc.
with the tape to describe the dressing					
812008	10 cm x 12 cm		- fixing and securing central venous catheters - fixing epidural catheters - secondary dressing - bedsore prevention, works as so-called „second skin” - for small epidermal abrasions and damages of the skin surface	1 pc.	100 x 1 pc.
with the tape to describe the dressing					
812011	10 cm x 15 cm		- fixing and securing central venous catheters - fixing epidural catheters - secondary dressing - bedsore prevention, works as so-called „second skin” - for small epidermal abrasions and damages of the skin surface	1 pc.	100 x 1 pc.
with the tape to describe the dressing					





3. Remove the paper protection on the outer side of the dressing starting from the cut.



4. Put the notes on the tape to describe the dressing and apply it on the dressing without covering the wound/ the place of needle insertion.

## elastoDERM F-IV

IV cannula dressing, with "frame" application type

REF	dimensions	shape	indication	packaging unit paper-paper	bulk packaging box
812006	6 cm x 7 cm		- fixing and securing peripheral cannulas in adults - securing cannulas inserted into central veins	1 pc.	100 x 1 pc.

with the tape to describe the dressing

## elastoDERM IV

IV cannula dressing, with "three-stage" application type

REF	dimensions	shape	indication	packaging unit paper-paper	bulk packaging box
811301	5,8 cm x 8 cm		- fixing and securing peripheral cannulas in adults	1 pc.	100 x 1 pc.

with the tape to describe the dressing

## elastoDERM PAD

dressing with central absorbent pad, with "three-stage" application type

REF	dimensions	shape	indication	packaging unit paper-paper	bulk packaging box
802012	6 cm x 7 cm		- protection of post-operative wounds and stitches	1 pc.	100 x 1 pc.
802014	9 cm x 10 cm			1 pc.	50 x 1 pc.
802015	9 cm x 15 cm			1 pc.	50 x 1 pc.
802016	10 cm x 20 cm			1 pc.	50 x 1 pc.
802018	10 cm x 25 cm			1 pc.	50 x 1 pc.





## ADDITIONAL PRODUCTS



non-sterile



available on request

## gauze pad moistened with alcohol alkoCLEAN

### features

- made of non-woven
- soaked with isopropyl alcohol (70%)
- two pouches connected in one-piece packaging can be separated thanks to perforation

### indication

- disinfection of small surfaces

REF	dimensions	no. of plies	packaging unit paper-aluminum foil	bulk packaging box
L-02	30 mm x 65 mm (unfolded) 30 mm x 32,5 mm (folded)	2	2 x 1 pc.	100 x 1 pc. (50 x 2 pcs)
*L-03	56 mm x 65 mm (unfolded) 28 mm x 32,5 mm (folded)	4	2 x 1 pc.	100 x 1 pc. (50 x 2 pcs)



non-sterile

## gauze pad moistened with alcohol ALKOPAD

### features

- made of non-woven
- each gauze pad is packed separately, in aluminum foil - paper
- soaked with isopropyl alcohol (70%)
- two pouches connected in one-piece packaging can be separated thanks to perforation (without L-06)

### indication

- disinfection low surface

REF	dimensions	packaging unit paper-aluminum foil	bulk packaging box
L-04	M 32,5 mm x 27,5 mm (folded) 65 mm x 55 mm (unfolded)	2 x 1 pc.	100 x 1 pc. (50 x 2 pcs.)
L-05	XL 55 mm x 45 mm (folded) 110 mm x 90 mm (unfolded)	2 x 1 pc.	100 x 1 pc. (50 x 2 pcs.)
L-06	XXL 190 mm x 140 mm (unfolded)	2 x 1 pc.	50 x 1 pc. (25 x 2 pcs.)



non-sterile

## gauze pad moistened with alcohol ALKOPAD DUO

### features

- made of non-woven
- each gauze pad is packed separately, in aluminum foil - paper
- gauze pad wet soaked with isopropyl alcohol (70%) and gauze pad dry
- two pouches connected in one-piece packaging can be separated thanks to perforation

### indication

- disinfection low surface

REF	dimensions	packaging unit paper-aluminum foil	bulk packaging box
L-05DUO	125 mm x 125 mm	2 x 1 pc.	50 x 2 pcs



non-sterile

## rescue blanket, foil, termic thermCARE

### features

- made of metallized PE foil
- protects against adverse weather conditions - cold, rain, heat, wind, depending on the side, which is applied towards the victim's body, prevents the life-threatening heat disorders and reduces the risk of shock
- resistant to damage

### indication

- protection against hypothermia and overheating of the victim's body
- in emergency cases such as car accidents, ski accidents, in mountain tourism, in sport

REF	dimensions	purpose	packaging unit zipper pouch	bulk packaging foil bag
KR160210	160 cm x 210 cm	for adults	1 pc.	12 x 1 pc.



# Medical clothing

It is extremely important for us to offer our clients products that ensure high standards of working conditions and comfort of use.

In order to achieve this goal, we have created a line of high quality products made of different types of non-woven materials:

- polypropylene non-woven
- SMS non-woven
- Spunlace non-woven
- viscose non-woven
- Spunlace Mesh non-woven

A combination of several factors such as optimal design, perfect fit, breathability and structure makes BETAtex products comfortable and reliable. A wide range of solutions will certainly meet our clients' individual preferences and secure both medical personnel and patients' comfort and dignity.



## MEDICAL GOWNS

[WWW.ZARYS.COM](http://WWW.ZARYS.COM)



# MEDICAL GOWN

with elastic cuffs, non-woven, non-sterile

## features:

- made of polypropylene non-woven 20 g/m<sup>2</sup>, 25 g/m<sup>2</sup>, 30 g/m<sup>2</sup> or 40 g/m<sup>2</sup>
- ties at waist and neck
- long sleeves with elastic cuffs
- breathable
- available sizes: L, XL
- single-use

REF	grammage	size	colour	packaging unit
BT-019-20B3-L	20 g/m <sup>2</sup>	L	blue	10 pcs
BT-019-20G3-L	20 g/m <sup>2</sup>	L	green	10 pcs
BT-019-20G4-XL	20 g/m <sup>2</sup>	XL	green	10 pcs
BT-019-20W3-L	20 g/m <sup>2</sup>	L	white	10 pcs
BT-019-25G3-L	25 g/m <sup>2</sup>	L	green	10 pcs
BT-019-25G4-XL	25 g/m <sup>2</sup>	XL	green	10 pcs
BT-019-25B3-L	25 g/m <sup>2</sup>	L	blue	10 pcs
BT-019-30G3-L	30 g/m <sup>2</sup>	L	green	10 pcs
BT-019-30G4-XL	30 g/m <sup>2</sup>	XL	green	10 pcs
BT-019-40G3-L	40 g/m <sup>2</sup>	L	green	10 pcs
BT-019-40B3-L	40 g/m <sup>2</sup>	L	blue	10 pcs

 bulk packaging:  
10 x 10 pcs

 available colours:  
  



# MEDICAL GOWN

with knitted cuffs, non-woven, non-sterile

## features:

- made of polypropylene non-woven 20 g/m<sup>2</sup>, 25 g/m<sup>2</sup>, 30 g/m<sup>2</sup> or 40 g/m<sup>2</sup>
- ties at waist and neck
- long sleeves with knitted cuffs
- breathable
- available sizes: L, XL, XXL
- single-use

REF	grammage	size	colour	packaging unit
BT-015-20G3-L	20 g/m <sup>2</sup>	L	green	10 pcs
BT-015-20G4-XL	20 g/m <sup>2</sup>	XL	green	10 pcs
BT-015-25G3-L	25 g/m <sup>2</sup>	L	green	10 pcs
BT-015-25B3-L	25 g/m <sup>2</sup>	L	blue	10 pcs
BT-015-25G4-XL	25 g/m <sup>2</sup>	XL	green	10 pcs
BT-015-30G3-L	30 g/m <sup>2</sup>	L	green	10 pcs
BT-015-30G4-XL	30 g/m <sup>2</sup>	XL	green	10 pcs
BT-015-30G5-XXL	30 g/m <sup>2</sup>	XXL	green	10 pcs
BT-015-40G3-L	40 g/m <sup>2</sup>	L	green	10 pcs
BT-015-40B3-L	40 g/m <sup>2</sup>	L	blue	10 pcs
BT-015-40G4-XL	40 g/m <sup>2</sup>	XL	green	10 pcs

 bulk packaging:  
10 x 10 pcs

 available colours:  
 





## SURGICAL CLOTHING

[WWW.ZARYS.COM](http://WWW.ZARYS.COM)





# SURGICAL SUIT

short-sleeved shirt+trousers, non-woven, non-sterile

## features:

- made of SMS non-woven 35 g/m<sup>2</sup>
- short-sleeved shirt with V-neck and 3 pockets
- trousers with guiding ties
- blue shirt and trousers available also in individual packaging
- single-use



## SET (SHIRT + TROUSERS)

REF	size	colour	packaging unit
BT-017-S35B1-S-SMS	S	blue	1 set
BT-017-S35B2-M-SMS	M	blue	1 set
BT-017-S35B3-L-SMS	L	blue	1 set
BT-017-S35B4-XL-SMS	XL	blue	1 set
BT-017-S35B5-XXL-SMS	XXL	blue	1 set
BT-017-S35B6-XXXL-SMS	XXXL	blue	1 set
BT-017-S35B7-XXXXL-SMS	XXXXL	blue	1 set
BT-017-S35G1-S-SMS	S	green	1 set
BT-017-S35G2-M-SMS	M	green	1 set
BT-017-S35G3-L-SMS	L	green	1 set
BT-017-S35G4-XL-SMS	XL	green	1 set
BT-017-S35G5-XXL-SMS	XXL	green	1 set
BT-017-S35V1-S-SMS	S	purple	1 set
BT-017-S35V2-M-SMS	M	purple	1 set
BT-017-S35V3-L-SMS	L	purple	1 set
BT-017-S35V4-XL-SMS	XL	purple	1 set
BT-017-S35V5-XXL-SMS	XXL	purple	1 set



bulk packaging:  
50 x 1 set



available colours:



## SHIRT

REF	size	colour	packaging unit
BT-018-S35B1-S-SMS	S	blue	1 pc.
BT-018-S35B2-M-SMS	M	blue	1 pc.
BT-018-S35B3-L-SMS	L	blue	1 pc.
BT-018-S35B4-XL-SMS	XL	blue	1 pc.
BT-018-S35B5-XXL-SMS	XXL	blue	1 pc.



bulk packaging:  
50 x 1 pc.



available colours:



## TROUSERS

REF	size	colour	packaging unit
BT-018-T35B1-S-SMS	S	blue	1 pc.
BT-018-T35B2-M-SMS	M	blue	1 pc.
BT-018-T35B3-L-SMS	L	blue	1 pc.
BT-018-T35B4-XL-SMS	XL	blue	1 pc.
BT-018-T35B5-XXL-SMS	XXL	blue	1 pc.



bulk packaging:  
50 x 1 pc.



available colours:



## SURGICAL SHIRT SHORT-SLEEVED

non-woven, non-sterile

### features:

- made of soft polypropylene non-woven 47 g/m<sup>2</sup>
- short sleeves
- 3 big pockets
- **snap fastener at the neck**
- single-use

REF	size	packaging unit
BT-018-S47B0-XS-SOFT2	XS	1 pc.
BT-018-S47B1-S-SOFT2	S	1 pc.
BT-018-S47B2-M-SOFT2	M	1 pc.
BT-018-S47B3-L-SOFT2	L	1 pc.
BT-018-S47B4-XL-SOFT2	XL	1 pc.
BT-018-S47B5-XXL-SOFT2	XXL	1 pc.
BT-018-S47B6-XXXL-SOFT2	XXXL	1 pc.
BT-018-S47B7-XXXXL-SOFT2	XXXXL	1 pc.



bulk packaging:  
50 x 1 pc.



available colours:



snap fastener at the neck



## SURGICAL SHIRT LONG-SLEEVED

non-woven, non-sterile

### features:

- made of soft polypropylene non-woven 47 g/m<sup>2</sup>
- long sleeves with knitted cuffs
- 2 big pockets
- **snap fasteners at the front**
- single-use

REF	size	packaging unit
BT-018-O47B1-S-SOFT3	S	1 pc.
BT-018-O47B2-M-SOFT3	M	1 pc.
BT-018-O47B3-L-SOFT3	L	1 pc.
BT-018-O47B4-XL-SOFT3	XL	1 pc.
BT-018-O47B5-XXL-SOFT3	XXL	1 pc.



bulk packaging:  
50 x 1 pc.



available colours:



# SURGICAL TROUSERS, WITH TIES

non-woven, non-sterile

## features:

- made of soft polypropylene non-woven 47 g/m<sup>2</sup>
- trousers with guiding ties
- 1 big pocket with snap fastener
- single-use

REF	size	packaging unit
BT-018-T47B0-XS-SOFT1	XS	1 pc.
BT-018-T47B1-S-SOFT1	S	1 pc.
BT-018-T47B2-M-SOFT1	M	1 pc.
BT-018-T47B3-L-SOFT1	L	1 pc.
BT-018-T47B4-XL-SOFT1	XL	1 pc.
BT-018-T47B5-XXL-SOFT1	XXL	1 pc.
BT-018-T47B6-XXXL-SOFT1	XXXL	1 pc.
BT-018-T47B7-XXXXL-SOFT1	XXXXL	1 pc.

  
bulk packaging:  
50 x 1 pc.

  
available colours:  





## CAPS AND PROTECTIVE MASKS

[WWW.ZARYS.COM](http://WWW.ZARYS.COM)



# MEDICAL BOUFFANT CAP

## non-woven

### features:

- cap with an elastic rubber band
- diameter: approx. 53 cm
- made of airy polypropylene non-woven
- excellent breathability and wearing comfort
- packaging: ergonomic cardboard box to remove individual pieces
- single-use, non-sterile

REF	colour	packaging unit
BT-008-18G	green	100 pcs
BT-008-18B	blue	100 pcs

 bulk packaging:  
10 x 100 pcs

 available colours:  
 



# DONA

## medical bouffant cap

### features

- cap with an elastic rubber band
- diameter: approx. 47 cm
- made of perforated viscose non-woven
- excellent breathability and wearing comfort
- packaging: ergonomic cardboard box to remove individual pieces
- single-use, non-sterile

REF	colour	packaging unit
BT-008-25G-B1-V	green	100 pcs
BT-008-25B-B1-V	blue	100 pcs
BT-008-25G-B1-V-XL	green	100 pcs

 bulk packaging:  
4 x 100 pcs

 available colours:  
 



# LILI

## medical cap with rubber

### features:

- cap with an elastic rubber band in the back part
- made of perforated viscose non-woven
- excellent breathability and wearing comfort
- packaging: ergonomic cardboard box to remove individual pieces
- single-use, non-sterile

REF	colour	packaging unit
BT-001-25G-R1-V	green	100 pcs
BT-001-25B-R1-V	blue	100 pcs
BT-001-25P-R1-V	pink	100 pcs
BT-001-25Y-R1-V	yellow	100 pcs

 bulk packaging:  
6 x 100 pcs

 available colours:  
 



# POLA

## medical cap with rubber

### features:

- cap with an elastic rubber band in the back part
- made of durable Spunlace and polypropylene non-woven
- the used non-woven is characterized by good absorption properties and durability and additionally it is pleasant to the touch, which increases comfort while using
- excellent breathability and wearing comfort
- packaging: ergonomic cardboard box to remove individual pieces
- single-use, non-sterile

REF	packaging unit
BT-001-45B-SPN	100 pcs



bulk packaging:  
6 x 100 pcs



available colours:



# SOL

## medical cap with ties

### features:

- cap with ties at the back
- made of perforated viscose non-woven
- excellent breathability and wearing comfort
- packaging: ergonomic cardboard box to remove individual pieces
- single-use, non-sterile

REF	colour	packaging unit
BT-007-25G-T1-V	green	100 pcs
BT-007-25B-T1-V	blue	100 pcs



bulk packaging:  
6 x 100 pcs



available colours:



# ABI

## medical cap with ties

### features:

- deep cap with ties at the back
- being folded out, the front part creates an additional layer protecting against sweat
- made of perforated viscose non-woven
- excellent breathability and wearing comfort
- packaging: ergonomic cardboard box to remove individual pieces
- single-use, non-sterile

REF	colour	packaging unit
BT-007-25G-T2-V	green	100 pcs
BT-007-25B-T2-V	blue	100 pcs
BT-007-25P-T2-V	pink	100 pcs
BT-007-25Y-T2-V	yellow	100 pcs



bulk packaging:  
6 x 100 pcs



available colours:



## NINO medical cap

### features:

- cap without rubber or ties, designed for short-haired people
- two layers of non-woven fabric in the side part
- made of perforated viscose non-woven
- excellent breathability and wearing comfort
- packaging: ergonomic cardboard box to remove individual pieces
- single-use, non-sterile

REF	colour	packaging unit
BT-001-25G-D-V	green	100 pcs
BT-001-25B-D-V	blue	100 pcs

 bulk packaging:  
6 x 100 pcs

 available colours:  
 



## KOKO long medical cap with snood

### features:

- cap with snood and elastic rubber band in the back part
- optimal protection for long-haired people
- made of perforated viscose non-woven
- excellent breathability and wearing comfort
- packaging: ergonomic cardboard box to remove individual pieces
- single-use, non-sterile

REF	colour	packaging unit
BT-001-25G-S1-V	green	100 pcs
BT-001-25B-S1-V	blue	100 pcs

 bulk packaging:  
6 x 100 pcs

 for long hair

 available colours:  
 



## DORA long medical cap with snood

### features:

- cap with anti-sweat insert in the forehead area
- special design allows the cap to adjust to the shape of the head and keep one's hair in an excellent manner
- optimal protection for long-haired people
- made of Spunlace and polypropylene non-woven
- excellent breathability and wearing comfort
- packaging: ergonomic cardboard box to remove individual pieces
- single-use, non-sterile

REF	packaging unit
BT-001-45B-S-SPN	50 pcs

 bulk packaging:  
6 x 50 pcs

 anti-sweat insert

 for long hair

 available colours:  



## BEN medical cap with ties

### features:

- forage cap with ties at the back
- made of perforated Spunlace Mesh non-woven
- excellent breathability and comfort of use
- single-use, non-sterile

REF	packaging unit
BT-007-35B-SPNM	100 pcs

 bulk packaging:  
10 x 100 pcs

 available colours:  



## TOM medical cap with ties

### features:

- cap with ties at the back
- anti-sweat insert on the whole circumference
- made of polypropylene non-woven 20 g/m<sup>2</sup>
- packaging: ergonomic cardboard box to remove individual pieces
- single-use, non-sterile

REF	packaging unit
BT-007-P20G	100 pcs

 bulk packaging:  
10 x 100 pcs

 anti-sweat  
insert

 available colours:  



## ROS medical cap with ties

### features:

- cap with ties at the back
- anti-sweat insert in the forehead area
- made of Spunlace and polypropylene non-woven
- packaging: ergonomic cardboard box to remove individual pieces
- latex-free
- single-use, non-sterile

REF	packaging unit
BT-007-P45B	50 pcs

 bulk packaging:  
6 x 50 pcs

 anti-sweat  
insert

 available colours:  





## MEDICAL MASK with ties, non-sterile

### features:

- made of three layers of dust-free and hypoallergenic non-woven
- modelling nose-piece
- protects operative field against exfoliated epidermis, hair and droplet infections
- provides effective protection in patients against infections transmitted from personnel's mouths and noses
- packaging: ergonomic cardboard box to remove individual pieces
- single-use

REF	colour	packaging unit
BT-046-32G	green	50 pcs
BT-046-32B	blue	50 pcs
BT-046-32P	pink	50 pcs
BT-046-32W	white	50 pcs

 bulk packaging:  
20 x 50 pcs

 three layers

 type II  
as per EN 14683

 available colours:  
   



121

## MEDICAL MASK with earloops, non-sterile

### features:

- made of three layers of dust-free and hypoallergenic non-woven
- modelling nose-piece
- splash resistant
- protects operative field against exfoliated epidermis, hair and droplet infections
- provides effective protection in patients against infections transmitted from personnel's mouths and noses
- packaging: ergonomic cardboard box to remove individual pieces
- single-use

REF	colour	type in accordance with the standard EN 14683	packaging unit
BT-046-31G	green	type II	50 pcs
BT-046-31B	blue	type II	50 pcs
BT-046-31P	pink	type II	50 pcs
BT-046-31W	white	type II	50 pcs
BT-046-R31B	blue	type II R	50 pcs

 bulk packaging:  
20 x 50 pcs

 three layers

 available colours:





## PATIENT CLOTHING

[WWW.ZARYS.COM](http://WWW.ZARYS.COM)



## PATIENT'S GOWN

### tied-up, non-woven, non-sterile

#### features:

- made of SMS non-woven
- short sleeves
- white ties at waist and neck
- easy putting on and taking off in bed-ridden patients
- universal size
- single-use

REF	material	size	grammage	packaging unit
BT-0022-33B-SMS	SMS non-woven	universal	33 g/m <sup>2</sup>	10 pcs

 bulk packaging:  
10 x 10 pcs

 available colours:  



## PATIENT'S GOWN

### Y-neck, non-woven, non-sterile

#### features:

- made of polypropylene or SMS non-woven
- short sleeves and Y-neck
- slipover
- single-use

REF	material	size	grammage	colour	packaging unit
BT-0022-40DB-PP	PP non-woven	universal	40 g/m <sup>2</sup>	dark blue	10 pcs

 bulk packaging:  
10 x 10 pcs

 available colours:  



## PATIENT'S GOWN

### V-neck, non-woven, non-sterile

#### features:

- made of Spunlace or SMS non-woven
- the used non-woven is characterized by good absorption properties and durability and additionally it is pleasant to the touch, which increases comfort while wearing
- short sleeves and V-neck
- slipover
- single-use

REF	material	size	grammage	colour	packaging unit
BT-0022-45W-SPN	Spunlace non-woven	universal	45 g/m <sup>2</sup>	white	10 pcs
BT-0022-45B-SPN	Spunlace non-woven	universal	45 g/m <sup>2</sup>	blue	10 pcs

 bulk packaging:  
10 x 10 pcs

 available colours:  
 

 pleasant for the skin



# PATIENT'S GOWN

## for delivery, non-woven, non-sterile

### features:

- made of SMS non-woven
- short sleeves, ties at waist and neck (other models available on request)
- available in 5 sizes: S, M, L, XL, XXL
- single-use

REF	material	size	grammage	packaging unit
BT-0022-35B-SMS-DM-001-S	SMS non-woven	S	35 g/m <sup>2</sup>	10 pcs
BT-0022-35B-SMS-DM-001-M	SMS non-woven	M	35 g/m <sup>2</sup>	10 pcs
BT-0022-35B-SMS-DM-001-L	SMS non-woven	L	35 g/m <sup>2</sup>	10 pcs
BT-0022-35B-SMS-DM-001-XL	SMS non-woven	XL	35 g/m <sup>2</sup>	10 pcs
BT-0022-35B-SMS-DM-001-XXL	SMS non-woven	XXL	35 g/m <sup>2</sup>	10 pcs



bulk packaging:  
10 x 10 pcs



available colours:



# COLONOSCOPY BOXERS

## SMS non-woven, non-sterile

### features:

- made of SMS non-woven 35 g/m<sup>2</sup>
- boxers with a slit in the back part
- completely opaque
- single-use

REF	material	size	grammage	packaging unit
BT-0023-35B-SMS	SMS non-woven	universal	35 g/m <sup>2</sup>	10 pcs
BT-0023-35B-SMS-XL	SMS non-woven	XL	35 g/m <sup>2</sup>	10 pcs



bulk packaging:  
10 x 10 pcs



available colours:



# COLONOSCOPY BOXERS

## PP non-woven, non-sterile

### features:

- made of polypropylene non-woven 40 g/m<sup>2</sup>
- boxers with a slit in the back part
- single-use

REF	material	size	grammage	packaging unit
BT-0023-40DB	PP non-woven	universal	40 g/m <sup>2</sup>	10 pcs



bulk packaging:  
10 x 10 pcs



available colours:



# GYNECOLOGICAL SKIRT

## non-woven, non-sterile

### features:

- made of polypropylene non-woven 40 g/m<sup>2</sup>
- dimensions: 160 cm (at the waist after stretching)
- single-use

REF	material	size	grammage	packaging unit
BT-0025-40DB	PP non-woven	universal	40 g/m <sup>2</sup>	10 pcs

 bulk packaging:  
10 x 10 pcs

 available colours:  



125

# EXAMINATION UNDERPANTS

## single-use, non-sterile

### features:

- made of polypropylene non-woven 40 g/m<sup>2</sup>
- ensure patient's intimacy during medical procedures
- single-use

REF	material	size	grammage	packaging unit
BT-0024-40DB	PP non-woven	universal	40 g/m <sup>2</sup>	10 pcs

 bulk packaging:  
20 x 10 pcs

 available colours:  



# EXAMINATION UNDERPANTS



## single-use, non-sterile

### features:

- made of Spunlace non-woven 45 g/m<sup>2</sup>
- the used non-woven is characterized by good absorption properties and durability and additionally it is pleasant to the touch, which increases comfort while wearing
- ensure patient's intimacy during medical procedures
- single-use

REF	material	size	grammage	packaging unit
BT-0026-45W-SPN	Spunlace non-woven	universal	45 g/m <sup>2</sup>	25 pcs

 bulk packaging:  
20 x 25 pcs

 available colours:  





## SHOE COVERS

[WWW.ZARYS.COM](http://WWW.ZARYS.COM)



## SHOE COVERS

non-sterile

### features:

- made of polyethylene or polypropylene non-woven  
30 g/m<sup>2</sup> or 40 g/m<sup>2</sup> (for shoe covers with anti-skid layer)
- elastic rubber band at the opening
- protection against contaminating rooms where higher cleanliness standards are required
- increased durability
- single-use

REF	material	grammage	size	colour	packaging unit	bulk packaging
BT-010-G	non-woven	30 g/m <sup>2</sup>	38 cm x 17 cm	green	100 pcs	10 x 100 pcs
BT-010-B	non-woven	30 g/m <sup>2</sup>	38 cm x 17 cm	blue	100 pcs	10 x 100 pcs
BT-011-B	non-woven with anti-skid layer	40 g/m <sup>2</sup>	38 cm x 17 cm	blue	100 pcs	10 x 100 pcs
BT-002-PEB	polyethylene		41 cm x 15 cm	blue	100 pcs	20 x 100 pcs



available colours:



## SHOE COVERS

calf-high, non-sterile

### features:

- made of polypropylene non-woven 30 g/m<sup>2</sup>
- elastic rubber band at the opening
- protection against contaminating rooms where higher cleanliness standards are required
- increased durability
- single-use

REF	material	grammage	size	packaging unit
BT-013-B	PP non-woven	30 g/m <sup>2</sup>	47 cm x 38,5 cm	100 pcs
BT-013-G	PP non-woven	30 g/m <sup>2</sup>	47 cm x 38,5 cm	100 pcs



bulk packaging:  
10 x 100 pcs



available colours:





## BEDCLOTHES AND ABSORBENT UNDERPADS



# DISPOSABLE MEDICAL BED SHEET

## non-sterile

### features:

- made of polypropylene non-woven, laminated polypropylene non-woven or SMS non-woven
- dimensions: according to customer's specification
- unit packaging: foil, bulk packaging: cardboard box



REF	material	grammage	dimensions*	colour
BT-030-PP-17-„X” x „Y” - G (X - width, Y - length)	PP non-woven	17 g/m <sup>2</sup>	X cm x Y cm X - width (cm) Y - length (cm)	green
BT-030-PP-25-„X” x „Y” - G (X - width, Y - length)	PP non-woven	25 g/m <sup>2</sup>		green
BT-030-PP-35-„X” x „Y” - G (X - width, Y - length)	PP non-woven	35 g/m <sup>2</sup>		green
BT-030-PF-25-„X” x „Y” - G (X - width, Y - length)	laminated PP non-woven	25 g/m <sup>2</sup>		green
BT-030-PF-45-„X” x „Y” - G (X - width, Y - length)	laminated PP non-woven	45 g/m <sup>2</sup>		green
BT-030-SMS-35-„X” x „Y” - B (X - width, Y - length)	SMS non-woven	35 g/m <sup>2</sup>		blue

\*according to customer's specification



available colours:



# DISPOSABLE MEDICAL PILLOW CASE

## non-sterile

### features:

- made of polypropylene non-woven

REF	grammage	size	packaging unit
BT-PP-25G1	25 g/m <sup>2</sup>	60cm x 80 cm	50 pcs
BT-PP-25G6	25 g/m <sup>2</sup>	80cm x 90 cm	50 pcs



bulk packaging:  
10 x 50 pcs



available colours:



# DISPOSABLE MEDICAL QUILT COVER

## non-sterile

### features:

- made of polypropylene non-woven

REF	grammage	size	packaging unit
BT-PZ-25G1	25 g/m <sup>2</sup>	160cm x 210 cm	10 pcs



bulk packaging:  
10 x 10 pcs



available colours:



## DISPOSABLE MEDICAL BEDDING SET

### non-sterile



#### features:

- made of polypropylene non-woven
- components:
  - bed sheet: 150 cm x 210 cm
  - quilt cover: 160 cm x 210 cm
  - pillow case: 70 cm x 80 cm

REF	grammage	colour	packaging unit
BT-ZES-25G3	25 g/m <sup>2</sup>	green	1 set
BT-ZES-40G3	40 g/m <sup>2</sup>	green	1 set
BT-ZES-40W3	40 g/m <sup>2</sup>	white	1 set

 bulk packaging:  
25 x 1 set

 available colours:  
 

## DISPOSABLE ABSORBENT UNDERPAD

### non-sterile

#### features:

- composed of five layers: laminate + cellulose wadding + cellulose pulp + cellulose wadding + PP nonwoven
- absorbent insert made of cellulose pulp
- impermeable foiled bottom
- single use



REF	dimensions	packaging unit
BT-PC4060	40 cm x 60 cm	25 pcs
BT-PC6060	60 cm x 60 cm	25 pcs
BT-PC6090	60 cm x 90 cm	25 pcs

 bulk packaging:  
4 x 25 pcs

## DISPOSABLE ABSORBENT UNDERPAD

### for operating table, non-sterile

#### features:

- quilted absorbent layer with addition of SAP (superabsorbent)
- composed of five layers: polypropylene non-woven, cellulose wadding, cellulose pulp with superabsorbent SAP, cellulose wadding, PE foil
- impermeable foiled bottom
- single use



REF	dimensions	packaging unit
BT-PC100225	100 cm x 225 cm	10 pcs

 bulk packaging:  
2 x 10 pcs

# DISPOSABLE MEDICAL BED SHEET, REINFORCED

non-sterile

## features:

- made of foil laminated paper
- reinforced with 8 or 48 threads
- grammage 40 g/m<sup>2</sup>
- soft, waterproof, absorbent, tough
- white with blue threads
- product put on mattresses, couches, armchairs and other elements that are the equipment of health care units, ie hospitals, outpatient clinics, clinics, etc.
- the products are designed to protect the patient during medical procedures, to prevent the transmission of contaminants and potentially pathogenic microorganisms located in medical rooms, treatment rooms and equipment that furnish these rooms and that may lead to complications of the patient's treatment process. They are a barrier to contamination
- non-sterile
- single use

REF	type	dimensions	packaging unit
BT-PW101	8 threads	80 cm x 210 cm	25 pcs
BT-PW401	48 threads	80 cm x 210 cm	25 pcs

 bulk packaging:  
4 x 25 pcs

8 threads



48 threads



# THERMAL PATIENT COVER SOFT

non-sterile

## features:

- made of Spunlace non-woven with polyester filling
- ultrasonic seams over the entire surface
- can be heated up in the heating device
- maintaining patient temperature at a stable level
- non-sterile
- single use

REF	dimensions	outer material	packaging unit	 bulk packaging
BT-TOP-21S	110 cm x 120 cm	Spunlace non-woven	1 pc.	50 x 1 pcs
BT-TOP-22S	110 cm x 210 cm	Spunlace non-woven	1 pc.	25 x 1 pcs



# THERMAL PATIENT COVER

non-sterile

## features:

- made of polypropylene non-woven with polyester filling
- ultrasonic seams over the entire surface
- can be heated up in the heating device
- maintaining patient temperature at a stable level
- non-sterile
- single use

REF	dimensions	outer material	packaging unit	 bulk packaging
BT-TOP-11P	110 cm x 120 cm	polypropylene non-woven	1 pc.	50 x 1 pcs
BT-TOP-12P	110 cm x 210 cm	polypropylene non-woven	1 pc.	25 x 1 pcs
BT-TOP-13P	150 cm x 210 cm	polypropylene non-woven	1 pc.	20 x 1 pcs





# PROTECTIVE COVERALL SAFE+ AGAINST CHEMICAL AND INFECTIVE AGENTS TYPE 4b - 5b - 6b

Personal protective equipments (PPE) are products that protect against one or more risks to the user's health or safety. These products must comply with Regulation (EU) 2016/425 of the European Parliament and of the Council. PPE is classified into three categories according to the degree of risk.

**The coverall is a PPE category III in accordance with the Regulation (EU) 2016/425 of the European Parliament and of the Council**



The category III covers products of complex construction, intended to protect health or life against risks that may cause death or irreversible damage to health.

### Standards:



Coverall is personal protective equipment of category III in conformity with Regulation (EU) 2016/425 of the European Parliament and of the Council

EN ISO 13688:2013 Protective clothing. General requirements



EN 14605:2005+A1:2009

EN 14605:2005+A1:2009 Protective clothing against liquid chemicals. Performance requirements for clothing with liquid-tight (Type 3) or spray-tight (Type 4) connections, including items providing protection to parts of the body only (Types PB [3] and PB [4])



EN ISO 13982-1:2004+A1:2010

EN ISO 13982-1:2004+A1:2010 Protective clothing for use against solid particulates. Part 1: Performance requirements for chemical protective clothing providing protection to the full body against airborne solid particulates (type 5 clothing)



EN 13034:2005+A1:2009

EN 13034:2005+A1:2009 Protective clothing against liquid chemicals. Performance requirements for chemical protective clothing offering limited protective performance against liquid chemicals (Type 6 and Type PB [6] equipment)



EN 1073-2:2002

EN 1073-2:2002 Protective clothing against radioactive contamination. Part 2: Requirements and test methods for non-ventilated protective clothing against particulate radioactive contamination



EN 14126:2003+AC:2004

EN 14126:2003 + AC:2004 Protective clothing. Performance requirements and tests methods for protective clothing against infective agents

- class 6 Resistance to penetration of contaminated liquids under the influence of hydrostatic pressure
- class 6 Resistance to penetration by infective agents due to mechanical contact with substances
- class 3 Resistance to penetration of contaminated liquid aerosols
- class 3 Resistance to penetration of contaminated solid particles



EN 1149-5:2018

EN 1149-5:2018 Protective clothing. Electrostatic properties. Part 5: Material performance and design requirements

EN 14325:2004 Protective clothing against chemicals. Test methods and performance classification of chemical protective clothing materials, seams, joins and assemblages

### features:

- made of a laminate (non-woven polypropylene and polyethylene) with a weight of 63 g/m<sup>2</sup>
- polyester seams additionally covered with tape
- equipped with a hood with elastic trim
- equipped with an elastic waist band, wrists and ankles
- zipper covered with a self-adhesive flap
- available in version with boots

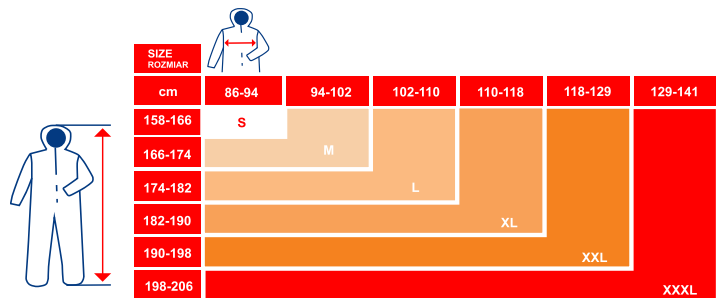

REF	size	version	packaging unit
BS-KCB02-S	S	without boots	1 pc.
BS-KCB02-M	M	without boots	1 pc.
BS-KCB02-L	L	without boots	1 pc.
BS-KCB02-XL	XL	without boots	1 pc.
BS-KCB02-XXL	XXL	without boots	1 pc.
BS-KCB02-XXXL	XXXL	without boots	1 pc.
BS-KCB02-B-S	S	with boots	1 pc.
BS-KCB02-B-M	M	with boots	1 pc.
BS-KCB02-B-L	L	with boots	1 pc.
BS-KCB02-B-XL	XL	with boots	1 pc.
BS-KCB02-B-XXL	XXL	with boots	1 pc.
BS-KCB02-B-XXXL	XXXL	with boots	1 pc.



# Surgical sets, drapes and surgical gowns

Preventing infections in the operating field is a priority for all medicals. Thanks to our complex offer of single-use protective solutions of ALPHAtex STANDARD, STANDARD+, COMFORT, the post-procedural complications and risk of infection in the operating field are minimized while increasing the protection barrier against the potentially pathogenic germs residing in the human skin layers. We offer:

- patient and equipment drapes
- sets of surgical drapes
- incise films
- surgical covers
- adhesive tapes
- accessories such as fluid collection pouches
- surgical gowns

Properly selected features of surgical drapes provide safety and comfort of use to medical staff and patients. A variety of multi-layer non-woven and laminates reinforced in critical areas in lines STANDARD+ and COMFORT allow to adjust our solutions to particular surgical procedures with maximal cost efficiency.

ALPHAtex products are characterized by parameters frequently exceeding the requirements of EN 13795 for 'Surgical drapes, gowns and clean air suits, used as medical devices for patients, clinical staff and equipment'.

Moreover, they provide a successful protection against the risk of infection in the operating field. Practical solutions and composition of our sets enable their quick and simple application while performing medical procedures.

# Prevention of surgical site infection



136

## Surgical site infection (SSI)

is defined as infection occurring up to 30 days after surgery, when there is a possibility of microorganisms penetration into the open surgical wound. Microorganisms could have various sources EXOGENOUS (carried by an external factor as medical staff or medical devices) or ENDOGENOUS (patient's bacterial flora from the closest area surrounding the surgical postoperative wound). The most important routes of infections are airway or contact path. Various type of barriers are used to minimize the surgical site infections: surgical drapes, surgical gowns and medical equipment covers.



### Surgical drapes

(the names are based on the EN 13795 standard)

Surgical drapes are used to ensure clean microbiological surgical wound surrounding, minimize the microorganisms migration from patient skin to surgical wound and to supervise the spreading of body fluids from the wound area. Surgical drapes meet the requirements of medical device in accordance with the Directive 93/42/EEC.

### Surgical gowns

(the names are based on the EN 13795 standard)

Surgical gowns are used to prevent direct microorganisms transmission from medical staff to patient. Moreover, surgical gowns prevent spreading of exfoliated epidermis in the air of the operating room.



The wide range of ALPHAtex products it's an effect of over 30 years of ZARYS International Group existence on medical market. Sharing our experience and knowledge we are convinced that using ALPHAtex products will provide comfort, safety and economic effectiveness during daily work in the operating room.

## Complex offer of ALPHAtex products contains:

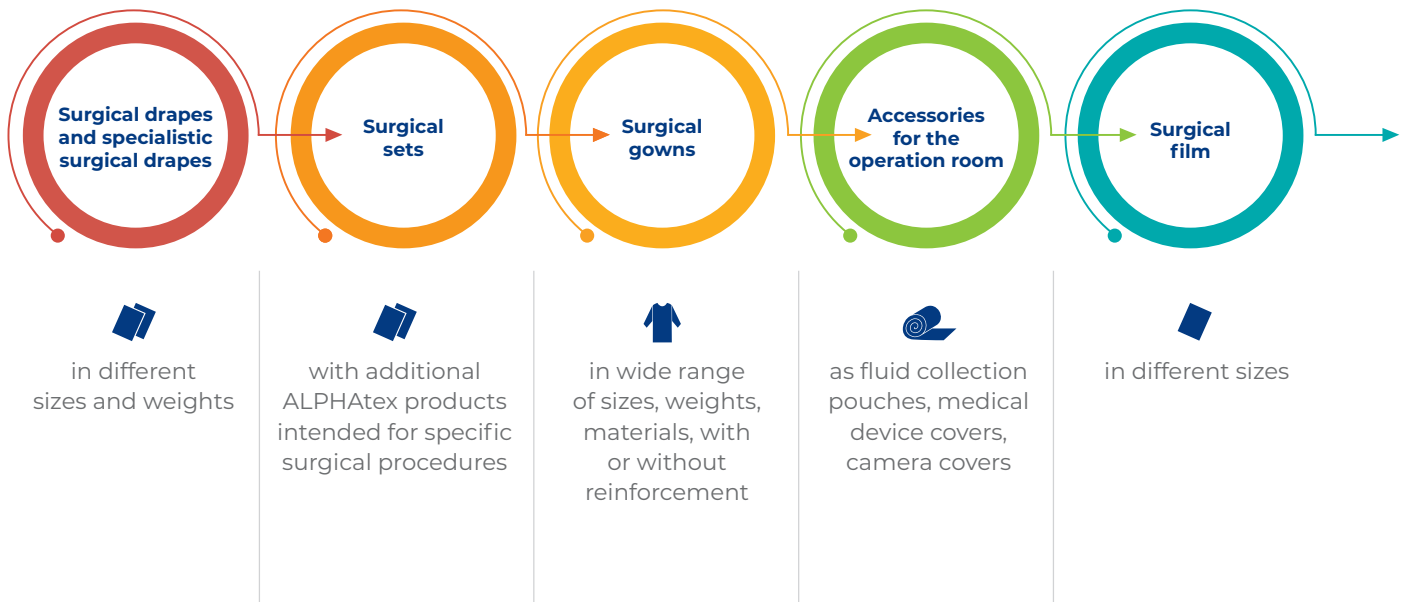

## ZONES OF SURGICAL DRAPES ON PATIENT

on the operating room

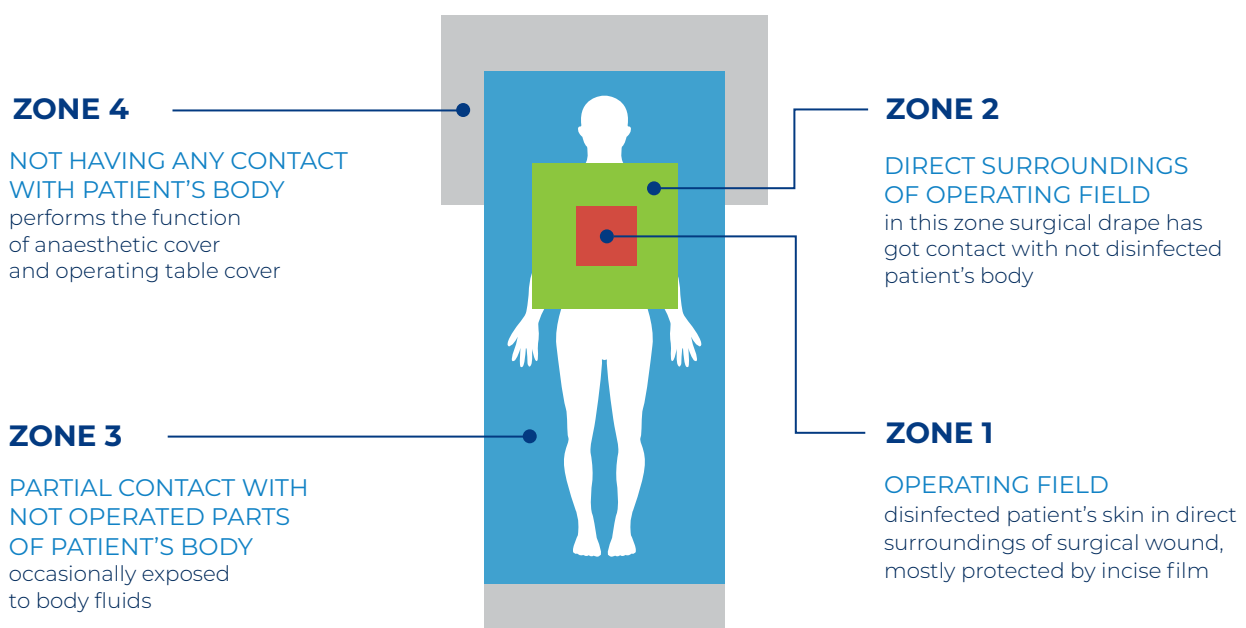



## Features of disposable surgical drapes ALPHAtex used in the operating room





## SURGICAL DRAPES

### **BASIC TYPES OF MATERIALS USED IN SURGICAL DRAPES:**

**PF DRAPE** - two layer material of the drape containing absorbency layer of cellulose on top and PE foil layer of the drape on back

**NF, NFA, NFF, NFFA, NFFAR DRAPE** - two layer material of the drape containing absorbency layer of non-woven material on top and PE foil layer on back of the drape

**NFN, NFNA, NFNF, NFNFA DRAPE** - three layer material on the drape containing absorbency non-woven layer on top, PE foil layer in the middle and non-woven absorbency layer on the back of the drape



## SURGICAL DRAPES 2-LAYER DRAPES

### STERILE DRAPES WITH CELLULOSE LAYER - 2-LAYERED

ref.	dimensions	packaging unit	 bulk packaging
AT-PF-S 1	50cm x 50cm	1 pc.	500 pcs
AT-PF-S 3	50cm x 70cm	1 pc.	400 pcs
AT-PF-S 5	80cm x 80cm	1 pc.	200 pcs
AT-PF-S 6	75cm x 90cm	1 pc.	200 pcs
AT-PF-S 8	90cm x 150cm	1 pc.	100 pcs

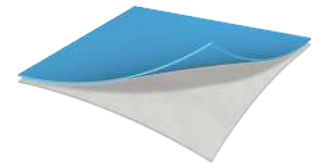

54 g/m<sup>2</sup>

### STERILE SURGICAL DRAPES - 2-LAYERED

ref.	dimensions	packaging unit	 bulk packaging
AT-NF-S 1 E	45cm x 45cm	100 pcs	4 x 100 pcs
AT-NF-S 3 E	45cm x 60cm	100 pcs	4 x 100 pcs
AT-NF-S 4 E	45cm x 75cm	100 pcs	4 x 100 pcs
AT-NF-S 5 E	75cm x 75cm	50 pcs	4 x 50 pcs
AT-NF-S 9 E	75cm x 90cm	50 pcs	4 x 50 pcs
AT-NF-S 13 E	100cm x 150cm	50 pcs	4 x 50 pcs
AT-NF-S 15 E	150cm x 180cm	20 pcs	4 x 20 pcs
AT-NF-S 21 E	37cm x 45cm	100 pcs	4 x 100 pcs

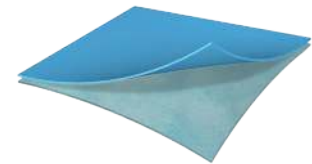

economic version



40 g/m<sup>2</sup>

### STERILE SURGICAL DRAPES - 2-LAYERED

ref.	dimensions	packaging unit	 bulk packaging
AT-NF-S 1	45cm x 45cm	1 pc.	2 x 240 pcs
AT-NF-S 2	50cm x 50cm	1 pc.	2 x 200 pcs
AT-NF-S 3	50cm x 60cm	1 pc.	2 x 280 pcs
AT-NF-S 4	50cm x 70cm	1 pc.	2 x 160 pcs
AT-NF-S 5	75cm x 75cm	1 pc.	2 x 150 pcs
AT-NF-S 8	80cm x 90cm	1 pc.	2 x 150 pcs
AT-NF-S 9	75cm x 90cm	1 pc.	2 x 150 pcs
AT-NF-S 10	90cm x 120cm	1 pc.	2 x 80 pcs
AT-NF-S 13	100cm x 150cm	1 pc.	2 x 50 pcs
AT-NF-S 14	120cm x 150cm	1 pc.	2 x 50 pcs
AT-NF-S 15	150cm x 180cm	1 pc.	2 x 20 pcs
AT-NF-S 16	150cm x 200cm	1 pc.	2 x 20 pcs
AT-NF-S 17	180cm x 180cm	1 pc.	2 x 20 pcs
AT-NF-S 19	160cm x 220cm	1 pc.	2 x 35 pcs
AT-NF-S 20	170cm x 300cm	1 pc.	2 x 20 pcs

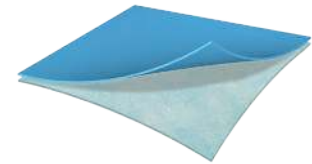

60 g/m<sup>2</sup>

### STERILE SURGICAL DRAPES WITH ADHESIVE EDGE - 2-LAYERED

ref.	dimensions	packaging unit	 bulk packaging
AT-NFA-S 1 E	45cm x 45cm	100 pcs	4 x 100 pcs
AT-NFA-S 4 E	45cm x 75cm	100 pcs	4 x 100 pcs
AT-NFA-S 9 E	75cm x 90cm	50 pcs	4 x 50 pcs
AT-NFA-S 10 E	90cm x 120cm	50 pcs	4 x 50 pcs
AT-NFA-S 13 E	100cm x 150cm	50 pcs	4 x 50 pcs
AT-NFA-S 15 E	150cm x 175cm	20 pcs	4 x 20 pcs
AT-NFA-S 16 E	150cm x 200cm	20 pcs	4 x 20 pcs
AT-NFA-S 20 E	150cm x 240cm	20 pcs	4 x 20 pcs



adhesive tape on the longer side of drape



economic version



40 g/m<sup>2</sup>

## STERILE SURGICAL DRAPES WITH ADHESIVE EDGE - 2-LAYERED

ref.	dimensions	packaging unit	 bulk packaging
AT-NFA-S 1	45cm x 45cm	1 pc.	2 x 230 pcs
AT-NFA-S 2	50cm x 50cm	1 pc.	2 x 200 pcs
AT-NFA-S 3	50cm x 60cm	1 pc.	2 x 100 pcs
AT-NFA-S 4	50cm x 70cm	1 pc.	2 x 210 pcs
AT-NFA-S 5	75cm x 75cm	1 pc.	2 x 135 pcs
AT-NFA-S 9	75cm x 90cm	1 pc.	2 x 125 pcs
AT-NFA-S 10	90cm x 120cm	1 pc.	2 x 80 pcs
AT-NFA-S 13	100cm x 150cm	1 pc.	2 x 50 pcs
AT-NFA-S 15	150cm x 180cm	1 pc.	2 x 20 pcs
AT-NFA-S 16	150cm x 200cm	1 pc.	2 x 20 pcs
AT-NFA-S 20	150cm x 240cm	1 pc.	2 x 20 pcs
AT-NFA-S 22	170cm x 300cm	1 pc.	2 x 20 pcs



  
adhesive tape  
on the longer  
side of drape

  
60 g/m<sup>2</sup>

## STERILE SURGICAL DRAPES WITH CENTRAL FENESTRATION - 2-LAYERED

ref.	dimensions	fenestration	packaging unit	 bulk packaging
AT-NFF-S 2 E	45cm x 75cm	6cm x 8cm	100 pcs	4 x 100 pcs
AT-NFF-S 3 E	45cm x 60cm	ø 6cm	100 pcs	4 x 100 pcs
AT-NFF-S 4 E	75cm x 90cm	ø 7cm	50 pcs	4 x 50 pcs
AT-NFF-S 5 E	75cm x 90cm	6cm x 8cm	50 pcs	4 x 50 pcs

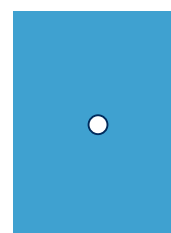

  
economic  
version

  
40 g/m<sup>2</sup>

## STERILE SURGICAL DRAPES WITH CENTRAL FENESTRATION - 2-LAYERED

ref.	dimensions	fenestration	packaging unit	 bulk packaging
AT-NFF-S 1	45cm x 45cm	ø 6cm	1 pc.	2 x 200 pcs
AT-NFF-S 2	50cm x 75cm	6cm x 8cm	1 pc.	2 x 120 pcs
AT-NFF-S 3	50cm x 75cm	ø 7cm	1 pc.	2 x 120 pcs
AT-NFF-S 4	75cm x 90cm	ø 7cm	1 pc.	2 x 120 pcs
AT-NFF-S 5	75cm x 90cm	6cm x 8cm	1 pc.	2 x 120 pcs
AT-NFF-S 6	90cm x 120cm	ø 10cm	1 pc.	2 x 120 pcs
AT-NFF-S 21	50cm x 60cm	ø 7cm	1 pc.	2 x 300 pcs

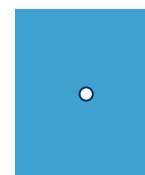

  
60 g/m<sup>2</sup>

## STERILE SURGICAL DRAPES WITH ADHESIVE CENTRAL FENESTRATION - 2-LAYERED

ref.	dimensions	fenestration	packaging unit	 bulk packaging
AT-NFFA-S 1 E	45cm x 45cm	ø 5cm	100 pcs	4 x 100 pcs
AT-NFFA-S 2 E	45cm x 75cm	6cm x 8cm	100 pcs	4 x 100 pcs
AT-NFFA-S 3 E	50cm x 60cm	ø 6cm	100 pcs	4 x 100 pcs
AT-NFFA-S 4 E	75cm x 90cm	ø 7cm	50 pcs	4 x 50 pcs
AT-NFFA-S 5 E	75cm x 90cm	6cm x 8cm	50 pcs	4 x 50 pcs
AT-NFFA-S 6 E	90cm x 120cm	ø 8cm	50 pcs	4 x 50 pcs

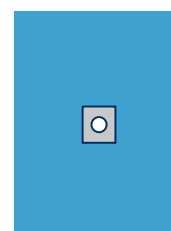

  
economic  
version

  
40 g/m<sup>2</sup>

## STERILE SURGICAL DRAPES WITH ADHESIVE CENTRAL FENESTRATION - 2-LAYERED

ref.	dimensions	fenestration	packaging unit	 bulk packaging
AT-NFFA-S 1	45cm x 45cm	ø 6cm	1 pc.	2 x 200 pcs
AT-NFFA-S 2	50cm x 75cm	6cm x 8cm	1 pc.	2 x 120 pcs
AT-NFFA-S 3	50cm x 75cm	ø 7cm	1 pc.	2 x 120 pcs
AT-NFFA-S 4	75cm x 90cm	ø 7cm	1 pc.	2 x 100 pcs
AT-NFFA-S 5	75cm x 90cm	6cm x 8cm	1 pc.	2 x 100 pcs
AT-NFFA-S 6	90cm x 120cm	ø 8cm	1 pc.	2 x 50 pcs
AT-NFFA-S 7	120cm x 150cm	ø 7cm	1 pc.	2 x 50 pcs
AT-NFFA-S 8	120cm x 150cm	ø 10cm	1 pc.	2 x 50 pcs
AT-NFFA-S 11	50cm x 60cm	6cm x 8cm	1 pc.	2 x 200 pcs

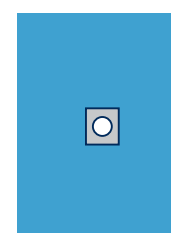

  
60 g/m<sup>2</sup>

## STERILE SURGICAL DRAPES WITH ADHESIVE CENTRAL ADJUSTABLE FENESTRATION - 2-LAYERED

ref.	dimensions	fenestration	packaging unit	 bulk packaging
AT-NFFAR-S 2 E	45cm x 75cm	6cm x 8cm	100 pcs	4 x 100 pcs
AT-NFFAR-S 4 E	75cm x 90cm	ø 7cm	50 pcs	4 x 50 pcs



  
economic version

  
40 g/m<sup>2</sup>

## STERILE SURGICAL DRAPES WITH ADHESIVE CENTRAL ADJUSTABLE FENESTRATION - 2-LAYERED

ref.	dimensions	fenestration	packaging unit	 bulk packaging
AT-NFFAR-S 2	45cm x 75cm	6cm x 8cm	1 pc.	2 x 150 pcs
AT-NFFAR-S 4	75cm x 90cm	ø 7cm	1 pc.	2 x 90 pcs



  
60 g/m<sup>2</sup>

## STERILE ADHESIVE EPIDURAL DRAPES - 2-LAYERED

ref.	dimensions	fenestration	packaging unit	 bulk packaging
AT-NFZRS-S 1	75cm x 80cm	6cm x 15cm	1 pc.	2x60 pcs
AT-NFZRS-S 11	75cm x 90cm	10cm x 15cm	1 pc.	2x60 pcs

indication: epidural anesthesia

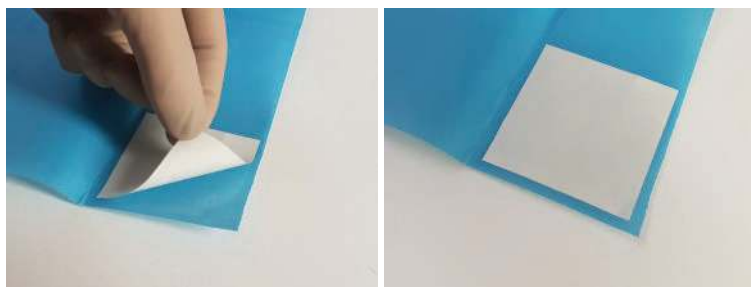

adhesive tape in the corners of drape

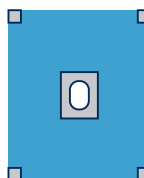

  
56 g/m<sup>2</sup>

## STERILE INSTRUMENT TABLE COVERS

ref.	dimensions	packaging unit	 bulk packaging
AT-SD-S 3	100cm x 150cm	1 pc.	100 pcs
AT-SD-S 4	150cm x 190cm	1 pc.	60 pcs
AT-SD-S 5	150cm x 260cm	1 pc.	45 pcs

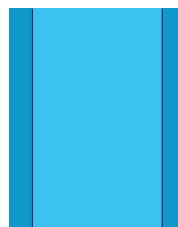

# SURGICAL DRAPES 3-LAYER DRAPES

## STERILE SURGICAL DRAPES - 3-LAYERED

ref.	dimensions	packaging unit	 bulk packaging
*AT-NFN-S 1	45cm x 45cm	1 pc.	300 pcs
AT-NFN-S 2	50cm x 50cm	1 pc.	300 pcs
AT-NFN-S 3	50cm x 60cm	1 pc.	150 pcs
AT-NFN-S 4	50cm x 70cm	1 pc.	160 pcs
AT-NFN-S 5	75cm x 75cm	1 pc.	100 pcs
AT-NFN-S 9	75cm x 90cm	1 pc.	80 pcs
*AT-NFN-S 10	90cm x 120cm	1 pc.	75 pcs
AT-NFN-S 13	100cm x 150cm	1 pc.	50 pcs
AT-NFN-S 15	150cm x 180cm	1 pc.	50 pcs
AT-NFN-S 16	150cm x 210cm	1 pc.	25 pcs
*AT-NFN-S 20	150cm x 240cm	1 pc.	25 pcs



 available on request

 75 g/m<sup>2</sup>

## STERILE SURGICAL DRAPES WITH ADHESIVE EDGE - 3-LAYERED

ref.	dimensions	packaging unit	 bulk packaging
AT-NFNA-S 1	45cm x 45cm	1 pc.	300 pcs
AT-NFNA-S 2	50cm x 50cm	1 pc.	256 pcs
AT-NFNA-S 3	50cm x 60cm	1 pc.	200 pcs
AT-NFNA-S 4	50cm x 70cm	1 pc.	160 pcs
AT-NFNA-S 5	75cm x 75cm	1 pc.	100 pcs
AT-NFNA-S 9	75cm x 90cm	1 pc.	90 pcs
AT-NFNA-S 10	90cm x 120cm	1 pc.	80 pcs
AT-NFNA-S 13	100cm x 150cm	1 pc.	80 pcs
AT-NFNA-S 15	150cm x 180cm	1 pc.	25 pcs
AT-NFNA-S 16	150cm x 210cm	1 pc.	50 pcs
AT-NFNA-S 20	150cm x 240cm	1 pc.	25 pcs



 adhesive tape on the longer side of drape

 75 g/m<sup>2</sup>

## STERILE SURGICAL DRAPES WITH CENTRAL FENESTRATION - 3-LAYERED

ref.	dimensions	fenestration	packaging unit	 bulk packaging
AT-NFNF-S 1	45cm x 45cm	ø 6cm	1 pc.	300 pcs
AT-NFNF-S 2	50cm x 75cm	6cm x 8cm	1 pc.	160 pcs
AT-NFNF-S 3	50cm x 75cm	ø 7cm	1 pc.	200 pcs
AT-NFNF-S 4	75cm x 90cm	ø 7cm	1 pc.	80 pcs
AT-NFNF-S 5	75cm x 90cm	6cm x 8cm	1 pc.	80 pcs
AT-NFNF-S 6	90cm x 120cm	ø 10cm	1 pc.	100 pcs

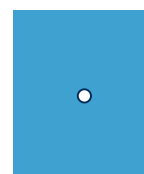

 75 g/m<sup>2</sup>



## STERILE SURGICAL DRAPES WITH ADHESIVE CENTRAL FENESTRATION - 3-LAYERED

ref.	dimensions	fenestration	packaging unit	 bulk packaging
*AT-NFNFA-S 1	45cm x 45cm	ø 6cm	1 pc.	300 pcs
AT-NFNFA-S 2	50cm x 70cm	6cm x 8cm	1 pc.	200 pcs
AT-NFNFA-S 3	50cm x 75cm	ø 7cm	1 pc.	100 pcs
AT-NFNFA-S 4	75cm x 90cm	ø 7cm	1 pc.	100 pcs
AT-NFNFA-S 5	75cm x 90cm	6cm x 8cm	1 pc.	100 pcs
AT-NFNFA-S 6	90cm x 120cm	ø 10cm	1 pc.	63 pcs

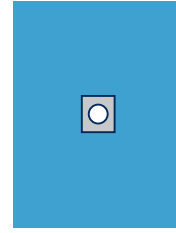

 available on request

 75 g/m<sup>2</sup>

## STERILE SURGICAL DRAPES WITH ADHESIVE FENESTRATION, REINFORCED

ref.	dimensions	fenestration	packaging unit	 bulk packaging
AT-NFZRF-S 1	120cm x 170cm	ø 12cm	1 pc.	50 pcs
AT-NFZRF-S 2	200cm x 280cm	ø 10cm	1 pc.	20 pcs
AT-NFZRF-S 3	200cm x 320cm	ø 15cm	1 pc.	20 pcs

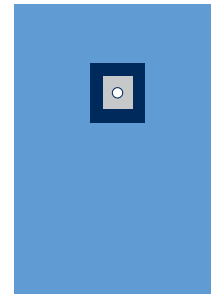

 50 g/m

 hydrophobic SMS material

 highly absorbent material





**GENERAL SURGERY**

**AT-SD-ABD1-IF-C**

**ABDOMINAL DRAPE 1-IF**



ref.	dimensions	quantity	component
AT-SD-ABD1-IF-C	200cm x 320cm	1 pc.	drape with adhesive fenestration 25cm x 30cm filled with an incise film, reinforced
AT-SD-S 4	150cm x 190cm	1 pc.	instrument table cover, reinforced

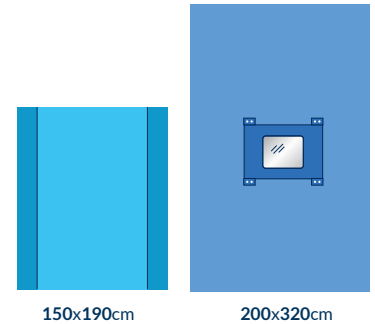

bulk packaging:  
20 pcs

**AT-SD-ABPER1-S**

**ABDO-PERINEAL DRAPE 1**



ref.	dimensions	quantity	component
AT-SD-ABPER1-S	180/280cm x 220cm	1 pc.	drape integrated with limb covers, adhesive trapezium-shaped fenestration 30cm x 20cm x 20cm and perineal fenestration 10cm x 15cm with covering flap
AT-SD-S 4	150cm x 190cm	1 pc.	instrument table cover, reinforced

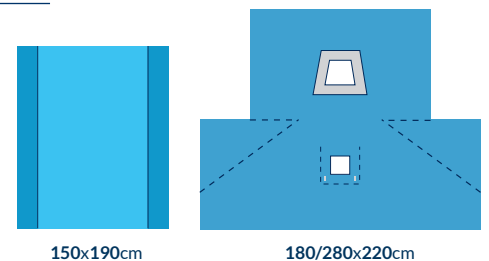

bulk packaging:  
16 pcs

**AT-SD-LAP3-SP**

**LAPAROSCOPY DRAPE 3**



ref.	dimensions	quantity	component
AT-SD-LAP3-SP	200/270cm x 300cm	1 pc.	drape integrated with limb covers, adhesive fenestration 25cm x 30cm, reinforced, with 8 cable holders Velcro type
AT-SD-S 4	150cm x 190cm	1 pc.	instrument table cover, reinforced

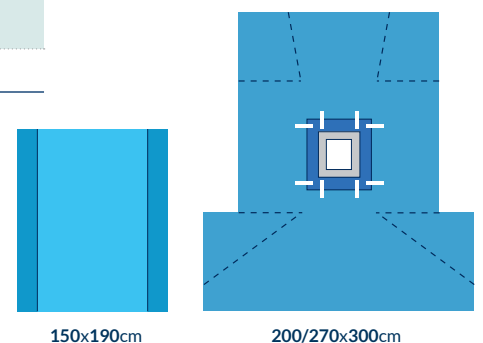

bulk packaging:  
12 pcs



## AT-SD-ORT1-SP

### ORTHOPAEDIC DRAPE 1



ref.	dimensions	quantity	component
AT-SD-ORT1-SP	150cm x 250cm	1 pc.	drape with adhesive U-split 7cm x 70cm, reinforced
AT-SD-S 4	150cm x 190cm	1 pc.	instrument table cover, reinforced



bulk packaging:  
20 pcs

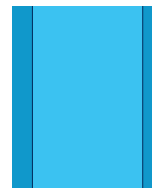

150x190cm

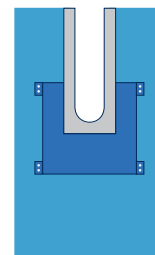

150x250cm

## AT-SD-ORT2-SP

### ORTHOPAEDIC DRAPE 2



ref.	dimensions	quantity	component
AT-SD-ORT2-SP	230cm x 260cm	1 pc.	drape with adhesive U-split 20cm x 100cm, reinforced
AT-SD-S 4	150cm x 190cm	1 pc.	instrument table cover, reinforced



bulk packaging:  
16 pcs

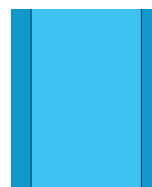

150x190cm

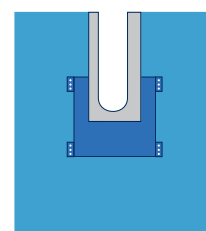

230x260cm

## AT-SD-ORT3-C

### ORTHOPAEDIC DRAPE 3



ref.	dimensions	quantity	component
AT-SD-ORT3-C	150cm x 200cm	1 pc.	drape with adhesive U-split 6cm x 65cm, reinforced
AT-SD-S 4	150cm x 190cm	1 pc.	instrument table cover, reinforced



bulk packaging:  
20 pcs

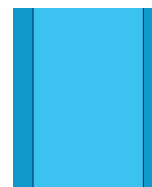

150x190cm

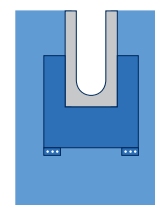

150x200cm

## AT-SD-ORT4-C

### ORTHOPAEDIC DRAPE 4



ref.	dimensions	quantity	component
AT-SD-ORT4-C	200cm x 260cm	1 pc.	drape with adhesive U-split 8.5cm x 85cm, reinforced
AT-SD-S 4	150cm x 190cm	1 pc.	instrument table cover, reinforced



bulk packaging:  
15 pcs

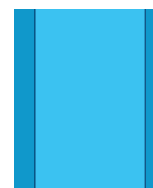

150x190cm

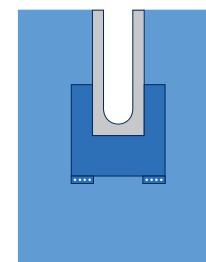

200x260cm

AT-SD-EXT1-SP

**EXTREMITY DRAPE 1**

ref.	dimensions	quantity	component
AT-SD-EXT1-SP	150cm x 180cm	1 pc.	drape with elastic fenestration ø 3,5cm, reinforced
AT-SD-S 4	150cm x 190cm	1 pc.	instrument table cover, reinforced

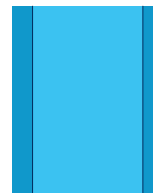

150x190cm

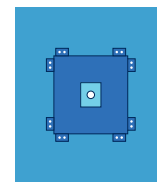

150x180cm

148

bulk packaging:  
24 pcs

AT-SD-EXT2-SP

**EXTREMITY DRAPE 2**

ref.	dimensions	quantity	component
AT-SD-EXT2-SP	230cm x 300cm	1 pc.	drape with elastic fenestration ø 3,5cm, reinforced
AT-SD-S 4	150cm x 190cm	1 pc.	instrument table cover, reinforced

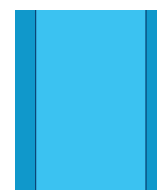

150x190cm

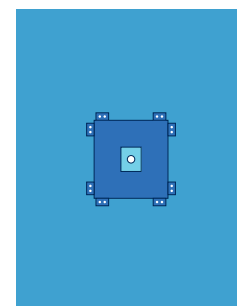

230x300cm

bulk packaging:  
18 pcs

AT-SD-EXT3-SP

**EXTREMITY DRAPE 3**

ref.	dimensions	quantity	component
AT-SD-EXT3-SP	230cm x 300cm	1 pc.	drape with elastic fenestration ø 7cm, reinforced
AT-SD-S 4	150cm x 190cm	1 pc.	instrument table cover, reinforced

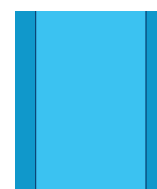

150x190cm

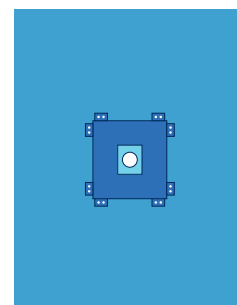

230x300cm

bulk packaging:  
18 pcs

AT-SD-EXT4-C

**EXTREMITY DRAPE 4**

ref.	dimensions	quantity	component
AT-SD-EXT4-C	200cm x 320cm	1 pc.	drape with elastic fenestration 6cm x 8cm, reinforced
AT-SD-S 4	150cm x 190cm	1 pc.	instrument table cover, reinforced

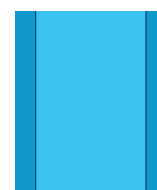

150x190cm

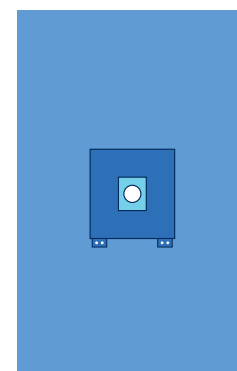

200x320cm

bulk packaging:  
15 pcs

AT-SD-EXT5-C

**EXTREMITY DRAPE 5**

ref.	dimensions	quantity	component
AT-SD-EXT5-C	200cm x 300cm	1 pc.	drape with elastic fenestration ø 3,5cm, reinforced
AT-SD-S 4	150cm x 190cm	1 pc.	instrument table cover, reinforced

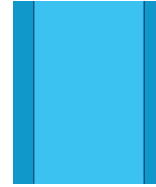
bulk packaging:  
20 pcs

150x190cm

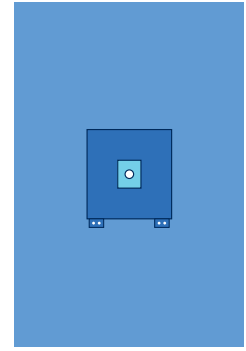

200x300cm

149

**GYNAECOLOGY AND UROLOGY**

AT-SD-GYN1-S

**GYNAECOLOGY DRAPE 1**

ref.	dimensions	quantity	component
AT-SD-GYN1-S	160/240cm x 180cm	1 pc.	drape integrated with limb covers, adhesive perineal fenestration 10cm x 15cm
AT-SD-S 4	150cm x 190cm	1 pc.	instrument table cover, reinforced

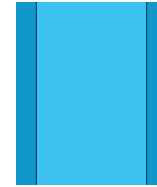
bulk packaging:  
16 pcs

150x190cm

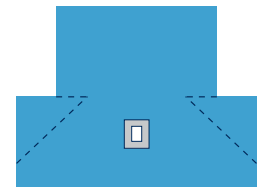

160/240x180cm

AT-SD-GYN2-S

**GYNAECOLOGY DRAPE 2**

ref.	dimensions	quantity	component
AT-SD-GYN2-S	160/240cm x 180cm	1 pc.	drape integrated with limb covers, adhesive perineal fenestration 10cm x 15cm, integrated fluid collection pouch 35cm x 50cm with formable mold, filter and tubing port
AT-SD-S 4	150cm x 190cm	1 pc.	instrument table cover, reinforced

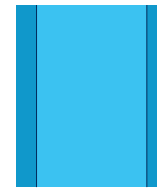
bulk packaging:  
8 pcs

150x190cm

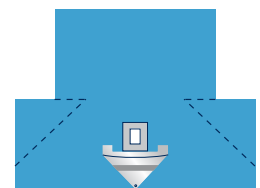

160/240x180cm

AT-SD-DEL1-SP

**DELIVERY DRAPE 1**

ref.	dimensions	quantity	component
AT-SD-DEL1-SP	114cm x 150cm	1 pc.	delivery drape integrated with fluid collection pouch 78cm x 80cm with formable mold, filter and tubing port, reinforced

bulk packaging:  
45 pcswithout  
instrument table  
cover wrapping

114x150cm



## AT-SD-OPHT1-IF-S

### OPHTHALMIC DRAPE 1-IF



ref.	dimensions	quantity	component
AT-SD-OPHT1-IF-S	100cm x 100cm	1 pc.	ophthalmic drape with fenestration 10cm x 10cm filled with an incise film
AT-SD-S 3	100cm x 150cm	1 pc.	instrument table cover, reinforced

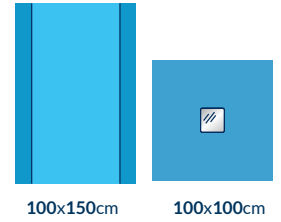

bulk packaging:  
50 sets

## AT-SD-OPHT2-IF-C

### OPHTHALMIC DRAPE 2-IF

ref.	dimensions	quantity	component
AT-SD-OPHT2-IF-C	100cm x 100cm	1 pc.	ophthalmic drape with fenestration 10cm x 10cm filled with an incise film, integrated with fluid collection pouch and with 2 formable molders, reinforced
AT-SD-S 3	100cm x 150cm	1 pc.	instrument table cover, reinforced

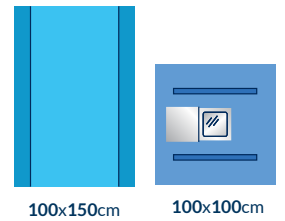

bulk packaging:  
60 sets



hydrophobic  
SMS material

## AT-SD-OPHT3-IF-C

### OPHTHALMIC DRAPE 3-IF

ref.	dimensions	quantity	component
AT-SD-OPHT3-IF-C	120cm x 170cm	1 pc.	ophthalmic drape with fenestration 10cm x 10cm filled with an incise film, integrated with 2 fluid collection pouches and with 1 formable molder, reinforced
AT-SD-S 3	100cm x 150cm	1 pc.	instrument table cover, reinforced

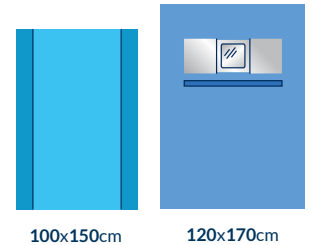

bulk packaging:  
40 sets



hydrophobic  
SMS material



formable molder to fit the patient's face

## AT-SD-OPHT4-IF-C

### OPHTHALMIC DRAPE 4-IF

ref.	dimensions	quantity	component
AT-SD-OPHT4-IF-C	140cm x 240cm	1 pc.	reinforced ophthalmic drape with a fenestration of 10cm x 10cm filled with an incise film, integrated with 2 fluid collection pouches and 1 formable molder
AT-SD-S 4	150cm x 190cm	1 pc.	instrument table cover, reinforced

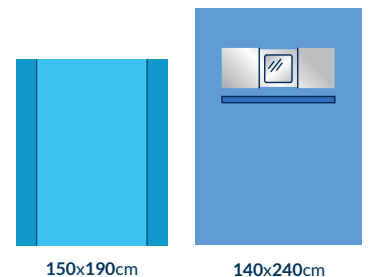

bulk packaging:  
25 sets



hydrophobic  
SMS material



## SURGICAL COVERS AND ACCESSORIES



# SURGICAL COVERS

## STERILE MAYO STAND COVER, REINFORCED - RED

ref.	dimensions	packaging unit
AT-SD-S 2 RED	80cm x 140cm	1 pc.

 bulk packaging:  
80 pcs

 **BESTSELLER**

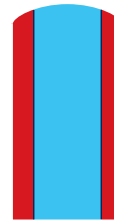

80x140cm

## STERILE SET OF LIMB COVERS

ref.	dimensions	packaging unit
AT-SD-S 9	70cm x 120cm	2 pcs

 bulk packaging:  
20 sets



2x

70x120cm

## STERILE LIMB COVERS

ref.	dimensions	packaging unit	 bulk packaging
AT-SD-S 6	30cm x 60cm	1 pc. + OP tape 10cm x 50cm	200 pcs
AT-SD-S 7	30cm x 80cm	1 pc. + OP tape 10cm x 50cm	120 pcs
AT-SD-S 8	35cm x 120cm	1 pc. + OP tape 10cm x 50cm	100 pcs



## STERILE CAMERA CABLE COVERS - PERFORATED, WITH 2 ADHESIVE TAPES

ref.	dimensions	packaging unit	 bulk packaging
AT-SP-S 3	14cm x 250cm	1 pc.	160 pcs
AT-SP-S 4	16cm x 200cm	1 pc.	200 pcs
AT-SP-S 5	16cm x 250cm	1 pc.	160 pcs
AT-SP-S 6	16cm x 300cm	1 pc.	200 pcs



sterile camera cover

 **BESTSELLER**

## STERILE CAMERA CABLE COVER - UNPERFORATED, WITHOUT ADHESIVE TAPE

ref.	dimensions	packaging unit
AT-SP-S 7	7cm x 120cm	1 pc.

 bulk packaging:  
200 pcs



7x120cm



## STERILE CAMERA CABLE COVER - UNPERFORATED, WITH AN ADHESIVE TAPE

ref.	dimensions	packaging unit
AT-SP-S 8	7cm x 170cm	1 pc.



bulk packaging:  
200 pcs



7x170cm

## STERILE CIRCULAR BANDED COVERS FOR MEDICAL DEVICES

ref.	dimensions in stretched state	maximum size of covered device	packaging unit	 bulk packaging
AT-SP-S 9	65cm x 85cm	35cm x 45cm	1 pc.	200 pcs
AT-SP-S 10	85cm x 85cm	50cm x 50cm	1 pc.	100 pcs
AT-SP-S 11	105cm x 105cm	60cm x 60cm	1 pc.	100 pcs
AT-SP-S 12	120cm x 120cm	70cm x 70cm	1 pc.	100 pcs
AT-SP-S 13	140cm x 140cm	80cm x 80cm	1 pc.	50 pcs

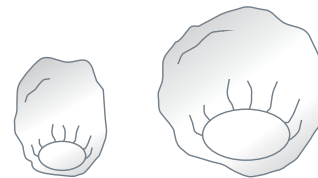

## STERILE RECTANGULAR BANDED COVERS FOR MEDICAL DEVICES

ref.	dimensions	packaging unit	 bulk packaging
AT-SP-S 14	70cm x 80cm	1 pc.	100 pcs
AT-SP-S 15	90cm x 100cm	1 pc.	50 pcs
AT-SP-S 16	80cm x 150cm	1 pc.	50 pcs

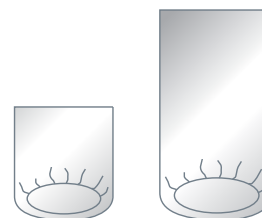

strong PE film  
65 µm

## STERILE C-ARM COVER SET

ref.	dimensions	packaging unit
AT-SP-S 17	100cm x 160cm 80cm x 150cm 3cm x 100cm	1 set



bulk packaging:  
32 sets



strong PE film  
65 µm

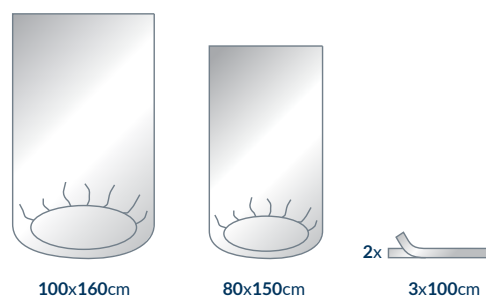

## STERILE ARMBOARD COVER SET

ref.	dimensions	packaging unit
AT-AC	35cm x 75cm	2 pcs



bulk packaging:  
80 sets



2x

35x75cm

**STERILE SURGICAL TAPES**

ref.	dimensions	description	packaging unit	 bulk packaging
AT-SP-S 1	10cm x 50cm	surgical tape, OP tape	1 pc.	1100 pcs
AT-SP-S 2	2cm x 22cm	surgical tape, Velcro type	1 pc.	100 pcs

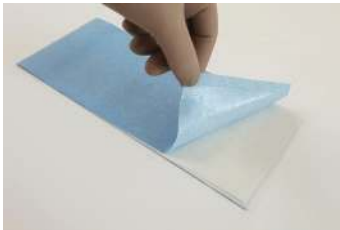
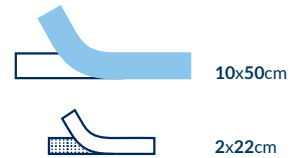

OP tape



Velcro surgical tape

**STERILE ADHESIVE POUCHES**

ref.	dimensions	description	packaging unit	 bulk packaging
AT-SP-S 20	30cm x 40cm	adhesive pouch, one-chamber	1 pc.	180 pcs
AT-SP-S 21	50cm x 60cm	adhesive pouch, one-chamber	1 pc.	180 pcs
AT-SP-S 22	40cm x 30cm	adhesive pouch, two-chamber 15cm x 30cm left chamber 25cm x 30cm right chamber	1 pc.	250 pcs

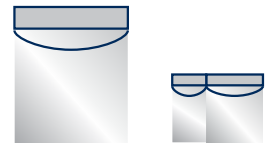
**STERILE ADHESIVE FLUID COLLECTION POUCH**

ref.	dimensions	packaging unit	description
AT-SP-S 19	50cm x 50cm	1 pc.	cone-shaped pouch with filter and tubing port

 bulk packaging:  
65 pcs

**STERILE ABSORBENT DRAPE**

ref.	dimensions	packaging unit
AT-HT	40cm x 40cm	1 pc.

 bulk packaging:  
500 pcs

made of cellulose

## STERILE ABSORBENT DRAPE

ref.	dimensions	packaging unit
AT-BT	75cm x 80cm	1 pc.



75x80cm



bulk packaging:  
80 pcs



made of highly  
absorbent spunlace



highly absorbent  
material

## STERILE INCISE FILM elastoFILM

ref.	total dimensions	adhesive filed dimensions	packaging unit	 bulk packaging
808067	56cm x 84cm	56cm x 78cm	1 pc.	6 pcs
808066	40cm x 42cm	40cm x 36cm	1 pc.	20 pcs
808065	45cm x 55cm	45cm x 49cm	1 pc.	20 pcs
808064	45cm x 28cm	45cm x 22cm	1 pc.	20 pcs
808063	30cm x 28cm	30cm x 22cm	1 pc.	20 pcs
808062	15cm x 28cm	15cm x 22cm	1 pc.	40 pcs
808061	14cm x 25cm	14cm x 21cm	1 pc.	40 pcs
805018	55cm x 55cm	55cm x 51cm	1 pc.	20 pcs
805025	30cm x 40cm	30cm x 36cm	1 pc.	20 pcs
805016	20cm x 30cm	20cm x 26cm	1 pc.	30 pcs



do not cut  
the incise film

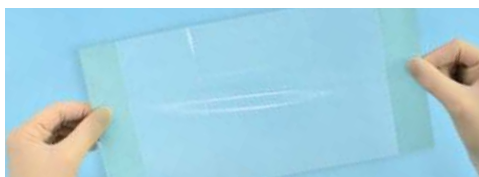

- thin incise film made of polyurethane
- flexible
- perfectly fits the patient's body
- double packed: externally paper-foil, internally paper



## CELLULOSE

Cellulose is a solid with typically fiber structure. Two-step process is used for industrial manufacturing of cellulose fibers, which was developed in 1892. Cellulose raw material is used in different industries as textiles and paper as well as in production of explosives.



## SURGICAL SETS

[WWW.ZARYS.COM](http://WWW.ZARYS.COM)





## AT-S-BASIC1-S BASIC SET 1

quantity	dimensions	component
1 pc.	75cm x 90cm	drape with central adhesive fenestration
1 pc.	10cm x 17cm	tray
10 pcs	10cm x 10cm	gauze swab
5 pcs	30cm x 30cm	gauze ball
1 pc.	100cm x 150cm	instrument table cover, reinforced

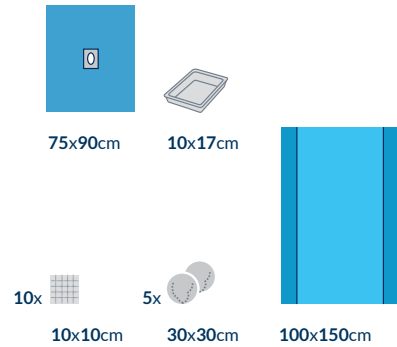

bulk packaging:  
28 sets

## AT-S-UNI1-S UNIVERSAL SET 1

quantity	dimensions	component
4 pcs	75cm x 90cm	drape with adhesive edge
1 pc.	150cm x 190cm	instrument table cover, reinforced



bulk packaging:  
50 sets

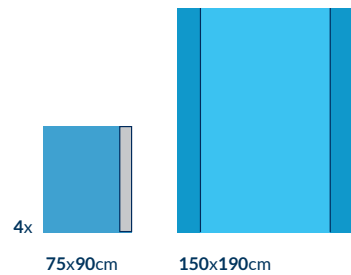

## AT-S-UNI2-S UNIVERSAL SET 2

quantity	dimensions	component
2 pcs	150cm x 180cm	drape with adhesive edge
2 pcs	75cm x 90cm	drape with adhesive edge
4 pcs	30cm x 30cm	absorbent towel
1 pc.	150cm x 190cm	instrument table cover, reinforced



bulk packaging:  
20 sets

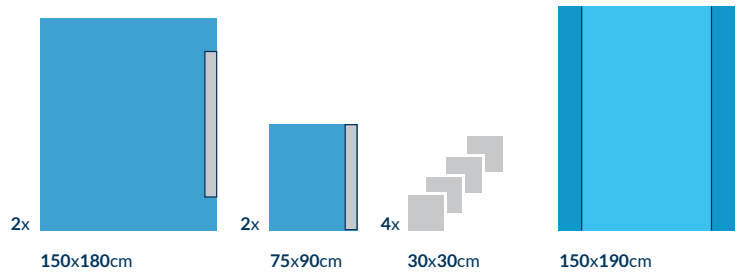

## AT-S-UNI4-C UNIVERSAL SET 4

quantity	dimensions	component
1 pc.	170cm x 240cm	drape with adhesive edge, reinforced
1 pc.	170cm x 180cm	drape with adhesive edge, reinforced
2 pcs	75cm x 90cm	highly absorbent drape with adhesive edge
4 pcs	30cm x 30cm	absorbent towel
1 pc.	10cm x 50cm	OP tape
1 pc.	80cm x 140cm	Mayo stand cover, reinforced - red
1 pc.	150cm x 190cm	instrument table cover, reinforced



bulk packaging:  
10 sets



hydrophobic  
SMS material



highly absorbent  
material



**BESTSELLER**

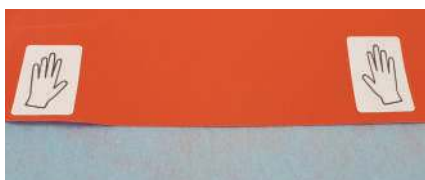
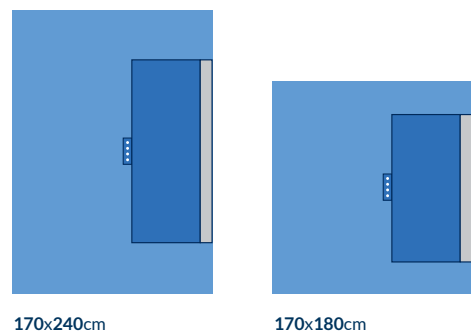

Mayo stand cover, reinforced - red

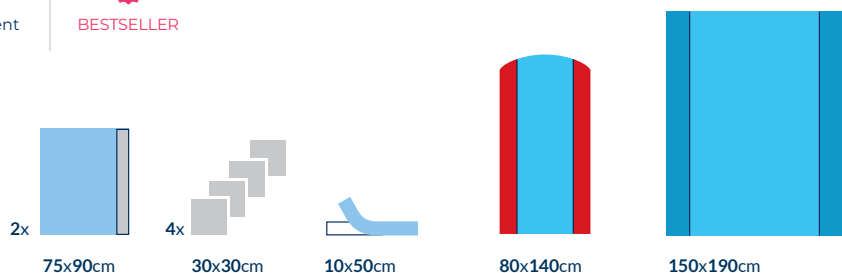

## AT-S-UNI5-S UNIVERSAL SET 5

quantity	dimensions	component
1 pc.	150cm x 240cm	drape with adhesive edge
1 pc.	180cm x 180cm	drape with adhesive edge
2 pcs	75cm x 90cm	drape with adhesive edge
4 pcs	30 cmx30 cm	absorbent towel
1 pc.	10cm x 50cm	OP tape
1 pc.	80cm x 145cm	Mayo stand cover, reinforced
1 pc.	150cm x 190cm	instrument table cover, reinforced

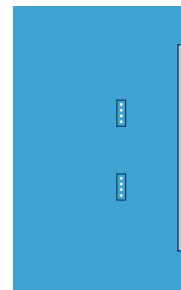

150x240cm

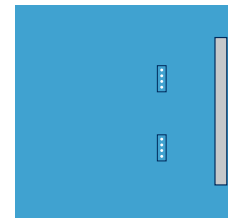

180x180cm



bulk packaging:  
10 sets



BESTSELLER

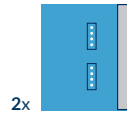

2x  
75x90cm

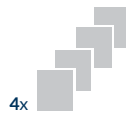

4x  
30x30cm



10x50cm

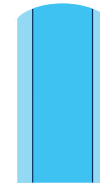

80x145cm

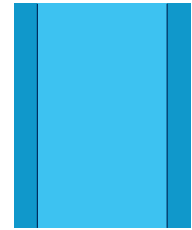

150x190cm

## AT-S-UNI6-SP UNIVERSAL SET 6

quantity	dimensions	component
1 pc.	150cm x 240cm	drape with adhesive edge, reinforced
1 pc.	180cm x 180cm	drape with adhesive edge, reinforced
2 pcs	75cm x 90cm	drape with adhesive edge, reinforced
4 pcs	30,5cm x 34cm	absorbent towel
1 pc.	10cm x 50cm	OP tape
1 pc.	80cm x 145cm	Mayo stand cover, reinforced
1 pc.	150cm x 190cm	instrument table cover, reinforced

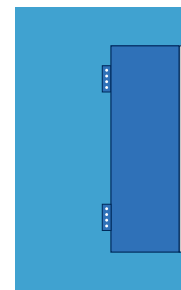

150x240cm

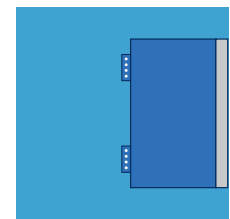

180x180cm



bulk packaging:  
9 sets



highly absorbent  
material

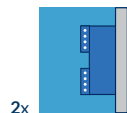

2x  
75x90cm

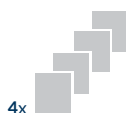

4x  
30,5x34cm



10x50cm

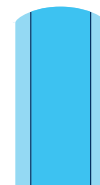

80x145cm

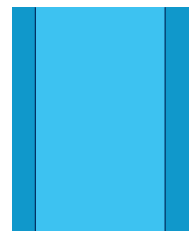

150x190cm

## AT-S-UNI7-C UNIVERSAL SET 7

quantity	dimensions	component
1 pc.	150cm x 240cm	drape with adhesive edge
1 pc.	180cm x 180cm	drape with adhesive edge
2 pcs	75cm x 90cm	drape with adhesive edge
4 pcs	30cm x 30cm	absorbent towel
1 pc.	10cm x 50cm	OP tape
1 pc.	80cm x 145cm	Mayo stand cover, reinforced
1 pc.	150cm x 190cm	instrument table cover, reinforced

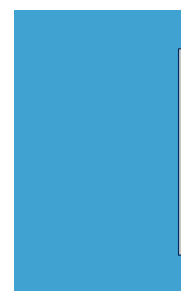

150x240cm

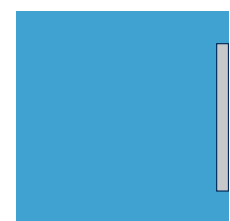

180x180cm



bulk packaging:  
8 sets



3-layer drapes  
PREMIUM

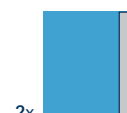

2x  
75x90cm



4x  
30x30cm



10x50cm

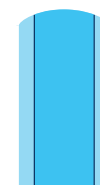

80x145cm

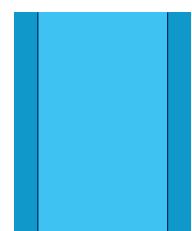

150x190cm

## AT-S-UNI8-C UNIVERSAL SET 8

quantity	dimensions	component
1 pc.	150cm x 240cm	drape with adhesive edge, reinforced
1 pc.	180cm x 180cm	drape with adhesive edge, reinforced
2 pcs	75cm x 90cm	drape with adhesive edge, reinforced
4 pcs	30cm x 30cm	absorbent towel
1 pc.	10cm x 50cm	OP tape
1 pc.	80cm x 145cm	Mayo stand cover, reinforced
1 pc.	150cm x 190cm	instrument table cover, reinforced

 bulk packaging:  
7 sets

 3-layer drapes  
PREMIUM

 highly absorbent  
material

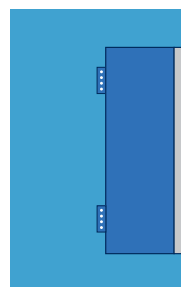
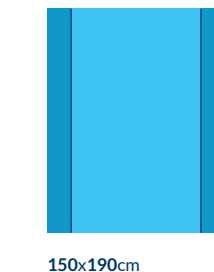
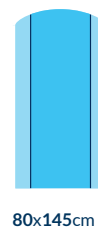
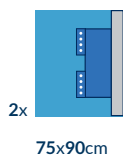

150x240cm

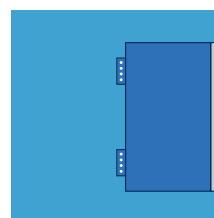

180x180cm

## AT-S-UNI9-SP PEDIATRIC UNIVERSAL SET 9

quantity	dimensions	component
1 pc.	150cm x 240cm	drape with adhesive edge
1 pc.	180cm x 180cm	drape with adhesive edge
2 pcs	75cm x 75cm	drape with adhesive edge, reinforced
4 pcs	30cm x 30cm	absorbent towel
1 pc.	10cm x 50cm	OP tape
1 pc.	80cm x 145cm	Mayo stand cover, reinforced
1 pc.	150cm x 190cm	instrument table cover, reinforced

 bulk packaging:  
10 sets

 pediatric set

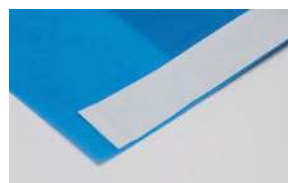

thinner tape in drapes - 2,5cm

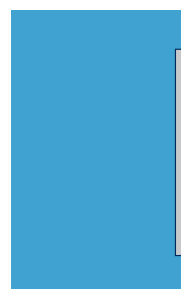
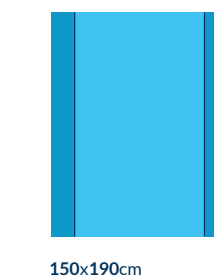
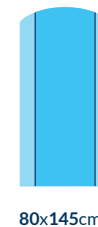
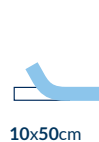
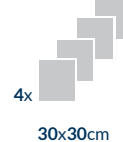
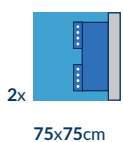

150x240cm



180x180cm

## AT-S-UNI10-S UNIVERSAL SET 10

quantity	dimensions	component
1 pc.	150cm x 230cm	drape with adhesive edge
1 pc.	150cm x 180cm	drape with adhesive edge
2 pcs	75cm x 90cm	drape with adhesive edge
4 pcs	30cm x 30cm	absorbent towel
1 pc.	10cm x 50cm	OP tape
1 pc.	80cm x 145cm	Mayo stand cover, reinforced
1 pc.	150cm x 190cm	instrument table cover, reinforced

 bulk packaging:  
10 sets

 economic  
version

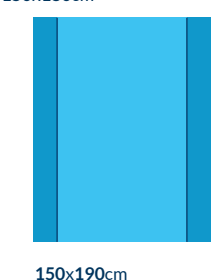
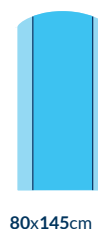
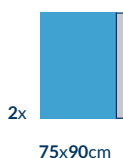

150x230cm



150x180cm

## AT-S-UNI5-G-S UNIVERSAL SET 5-G

quantity	dimensions	component
1 pc.	150cm x 240cm	drape with adhesive edge
1 pc.	180cm x 180cm	drape with adhesive edge
2 pcs	75cm x 90cm	drape with adhesive edge
4 pcs	30cm x 30cm	absorbent towel
1 pc.	10cm x 50cm	OP tape
1 pc.	80cm x 145cm	Mayo stand cover, reinforced
1 pc.	150cm x 190cm	instrument table cover, reinforced
1 pc.	L	surgical gown STANDARD
2 pcs	XL	surgical gown STANDARD



bulk packaging:  
5 sets

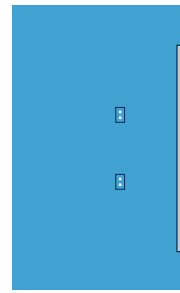

150x240cm

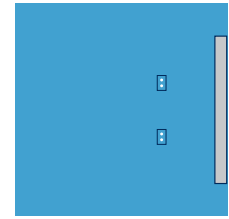

180x180cm

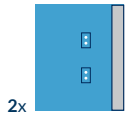

2x  
75x90cm



4x  
30x30cm



10x50cm

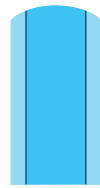

80x145cm

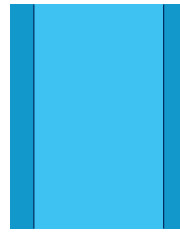

150x190cm

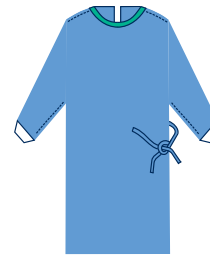

L



2x  
XL

## AT-S-UNI5-GP-S UNIVERSAL SET 5-GP

quantity	dimensions	component
1 pc.	150cm x 240cm	drape with adhesive edge
1 pc.	180cm x 180cm	drape with adhesive edge
2 pcs	75cm x 90cm	drape with adhesive edge
4 pcs	30cm x 30cm	absorbent towel
1 pc.	10cm x 50cm	OP tape
1 pc.	80cm x 145cm	Mayo stand cover, reinforced
1 pc.	150cm x 190cm	instrument table cover, reinforced
1 pc.	XL	surgical gown STANDARD
1 pc.	XXL	surgical gown, reinforced STANDARD PLUS
1 pc.	30cm x 40cm	adhesive pouch, one-chamber



bulk packaging:  
6 sets

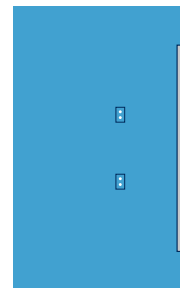

150x240cm

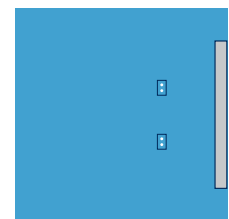

180x180cm

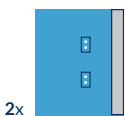

2x  
75x90cm

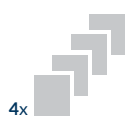

4x  
30x30cm



10x50cm



30x40cm

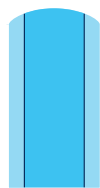

80x145cm

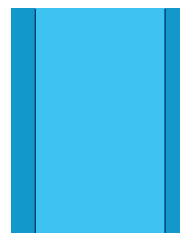

150x190cm

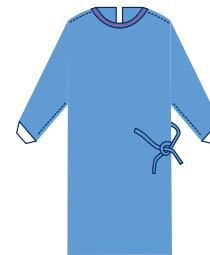

XL



XXL





# GENERAL SURGERY

## AT-S-ABD1-IF-C ABDOMINAL SET 1-IF

quantity	dimensions	component
1 pc.	200cm x 320cm	drape with adhesive fenestration 25cm x 30cm filled with an incise film, reinforced
4 pcs	30cm x 30cm	absorbent towel
1 pc.	10cm x 50cm	OP tape
1 pc.	80cm x 140cm	Mayo stand cover, reinforced - red
1 pc.	150cm x 190cm	instrument table cover, reinforced

 bulk packaging:  
10 sets

 hydrophobic  
SMS material

 highly absorbent  
material

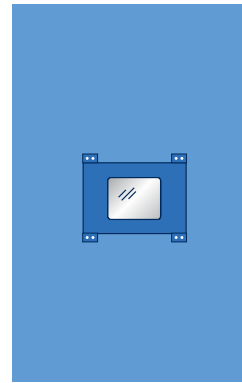

200x320cm



30x30cm

10x50cm

4x

30x30cm



10x50cm



80x140cm

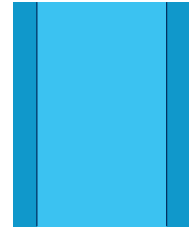

150x190cm

## AT-S-ABPER1-S ABDO-PERINEAL SET 1

quantity	dimensions	component
1 pc.	180/270cm x 220cm	drape integrated with limb covers, adhesive trapezium-shaped fenestration 30cm x 20cm x 20cm and perineal fenestration 10cm x 15cm with covering flap
4 pcs	30cm x 30cm	absorbent towel
1 pc.	10cm x 50cm	OP tape
1 pc.	2cm x 22cm	surgical tape, Velcro type
1 pc.	14cm x 250cm	camera cable cover
1 pc.	80cm x 140cm	Mayo stand cover, reinforced - red
1 pc.	150cm x 190cm	instrument table cover, reinforced

 bulk packaging:  
10 sets

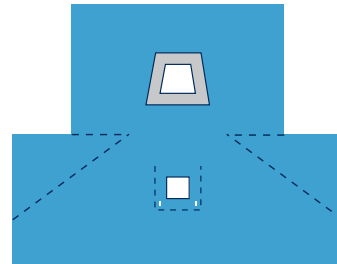

180/270x220cm

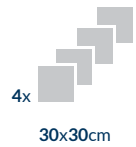

30x30cm

4x



10x50cm



2x22cm



14x250cm



80x140cm

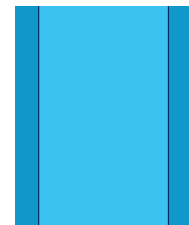

150x190cm

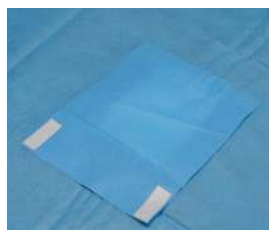

flap to secure the fenestration

## AT-S-LAP1-IF-C LAPAROSCOPY SET 1-IF

quantity	dimensions	component
1 pc.	200cm x 260cm	drape T-shaped with adhesive fenestration 30cm x 30cm filled with an incise film
4 pcs	30cm x 30cm	absorbent towel
1 pc.	10cm x 50cm	OP tape
1 pc.	14cm x 250cm	camera cable cover
2 pcs	70cm x 120cm	limb cover
1 pc.	80cm x 140cm	Mayo stand cover, reinforced - red
1 pc.	150cm x 190cm	instrument table cover, reinforced



bulk packaging:  
12 sets



hydrophobic  
SMS material

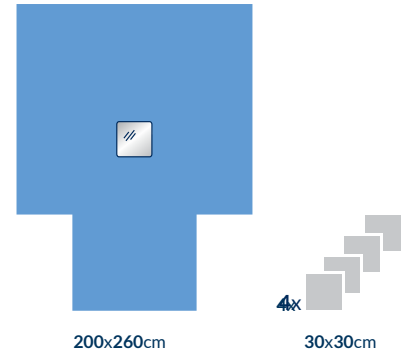

4x



10x50cm



14x250cm

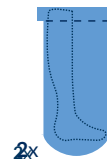

2x

70x120cm



80x140cm

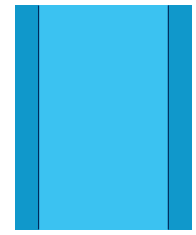

150x190cm

## AT-S-LAP2-SP LAPAROSCOPY SET 2

quantity	dimensions	component
1 pc.	200/270cm x 300cm	drape integrated with limb covers, adhesive fenestration 25cm x 30cm, reinforced, with 8 cable holders Velcro type
4 pcs	30cm x 30cm	absorbent towel
1 pc.	10cm x 50cm	OP tape
1 pc.	2cm x 22cm	surgical tape, Velcro type
1 pc.	14cm x 250cm	camera cable cover
1 pc.	80cm x 140cm	Mayo stand cover, reinforced - red
1 pc.	150cm x 190cm	instrument table cover, reinforced



bulk packaging:  
10 sets



highly absorbent  
material



**BESTSELLER**

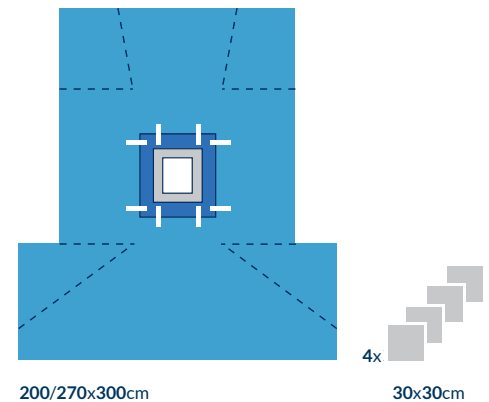

200/270x300cm

4x

30x30cm



cable holders, Velcro type

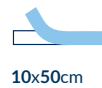

10x50cm



2x22cm



14x250cm



80x140cm

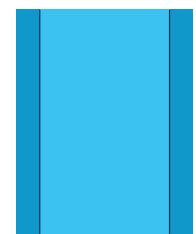

150x190cm

**AT-S-LAP3-C**
**LAPAROSCOPY SET 3**

quantity	dimensions	component
1 pc.	200/270cm x 300cm	drape integrated with limb covers, adhesive fenestration 25cm x 30cm, reinforced, with 8 cable holders Velcro type
4 pcs	30cm x 30cm	absorbent towel
1 pc.	10cm x 50cm	OP tape
1 pc.	2cm x 22cm	surgical tape, Velcro type
1 pc.	14cm x 250cm	camera cable cover
1 pc.	30cm x 40cm	adhesive pouch, one-chamber
1 pc.	80cm x 140cm	Mayo stand cover, reinforced - red
1 pc.	150cm x 190cm	instrument table cover, reinforced

 bulk packaging: 8 sets  
 hydrophobic SMS material

 highly absorbent material

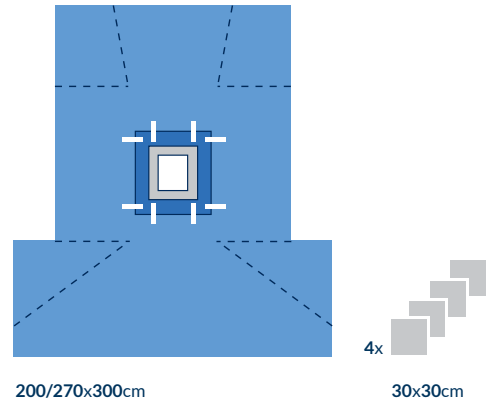
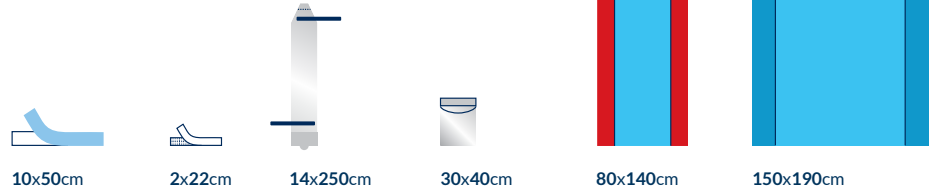
**AT-S-VAR1-S**
**VARICOSE VEIN SET 1**

quantity	dimensions	component
1 pc.	200cm x 260cm	drape with adhesive U-split 8,5cm x 85cm
1 pc.	160cm x 180cm	drape with adhesive edge
4 pcs	30cm x 30cm	absorbent towel
1 pc.	80cm x 140cm	Mayo stand cover, reinforced - red
1 pc.	150cm x 190cm	instrument table cover, reinforced

 bulk packaging: 10 sets  
 drape with U-split

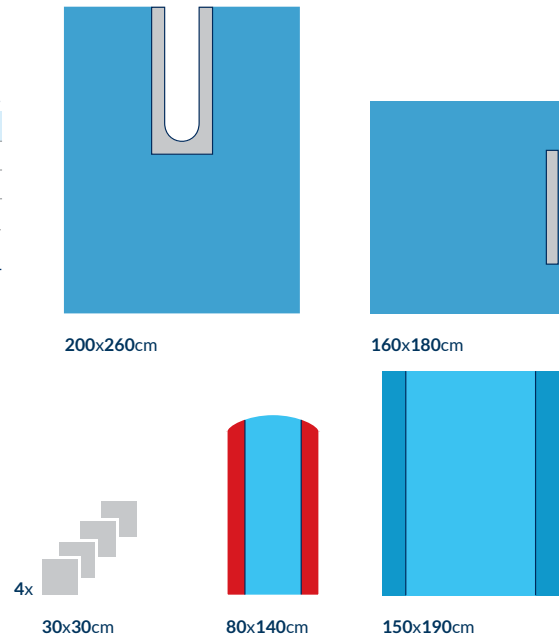
**AT-S-VAR2-C**
**VARICOSE VEIN SET 2**

quantity	dimensions	component
1 pc.	200cm x 260cm	drape with adhesive U-split 8,5cm x 95cm, integrated genital area cover, reinforced
1 pc.	170cm x 180cm	drape with adhesive edge, reinforced
4 pcs	30cm x 30cm	absorbent towel
1 pc.	80cm x 140cm	Mayo stand cover, reinforced - red
1 pc.	150cm x 190cm	instrument table cover, reinforced

 bulk packaging: 10 sets  
 hydrophobic SMS material  
 integrated genital area cover

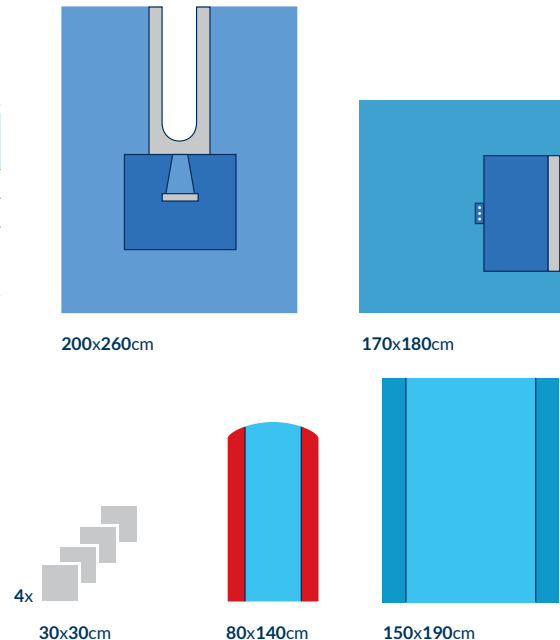

 drape with U-split  
 highly absorbent material



# ORTHOPAEDICS AND TRAUMATOLOGY

## AT-S-EXT1-C EXTREMITY SET 1

quantity	dimensions	component
1 pc.	200cm x 300cm	drape with elastic fenestration ø 3,5cm, reinforced
1 pc.	80cm x 140cm	Mayo stand cover, reinforced - red
1 pc.	150cm x 190cm	instrument table cover, reinforced

 bulk packaging: 12 sets

 highly absorbent material

 hydrophobic SMS material

 limb surgery

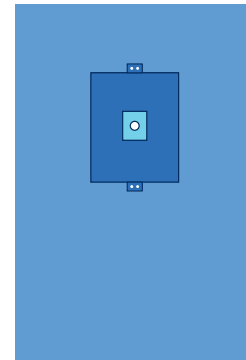

200x300cm



80x140cm

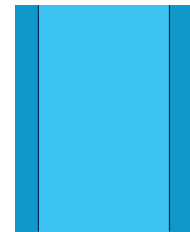

150x190cm

## AT-S-EXT2-C EXTREMITY SET 2

quantity	dimensions	component
1 pc.	200cm x 300cm	drape with elastic fenestration ø 3,5cm, reinforced
1 pc.	160cm x 180cm	drape with adhesive edge
4 pcs	30cm x 30cm	absorbent towel
1 pc.	10cm x 50cm	OP tape
1 pc.	80cm x 140cm	Mayo stand cover, reinforced - red
1 pc.	150cm x 190cm	instrument table cover, reinforced

 bulk packaging: 8 sets

 highly absorbent material

 hydrophobic SMS material

 limb surgery

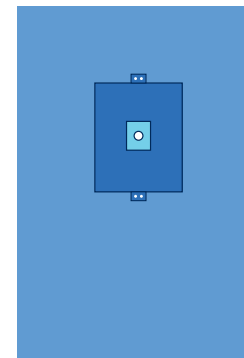

200x300cm



160x180cm

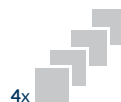

4x 30x30cm



10x50cm



80x140cm

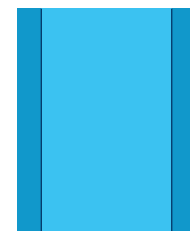

150x190cm

## AT-S-ART1-C ARTHROSCOPY SET 1

quantity	dimensions	component
1 pc.	200cm x 320cm	drape with elastic fenestration 6cm x 8cm, reinforced
4 pcs	30cm x 30cm	absorbent towel
1 pc.	10cm x 50cm	OP tape
1 pc.	30cm x 60cm	elastic limb cover
1 pc.	80cm x 140cm	Mayo stand cover, reinforced - red
1 pc.	150cm x 190cm	instrument table cover, reinforced

 bulk packaging:  
14 sets

 hydrophobic  
SMS material

 highly absorbent  
material

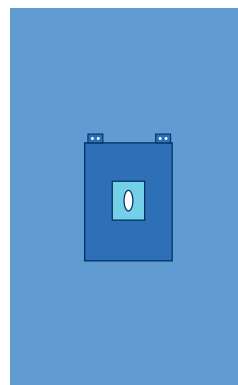

200x320cm

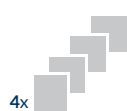

4x  
30x30cm



10x50cm



30x60cm

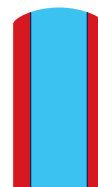

80x140cm

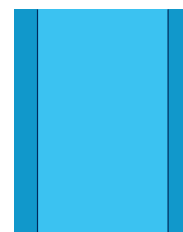

150x190cm

## AT-S-ART2-C ARTHROSCOPY SET 2

quantity	dimensions	component
1 pc.	200cm x 320cm	drape with elastic fenestration 6cm x 8cm, reinforced
2 pcs	30cm x 30cm	absorbent towel
2 pcs	10cm x 50cm	OP tape
1 pc.	14cm x 250cm	camera cable cover
1 pc.	30cm x 60cm	elastic limb cover
1 pc.	60cm x 100cm	fluid collection pouch with elastic fenestration, formable molder and tubing port
1 pc.	80cm x 140cm	Mayo stand cover, reinforced - red
1 pc.	150cm x 190cm	instrument table cover, reinforced

 bulk packaging:  
14 sets

 hydrophobic  
SMS material

 highly absorbent  
material

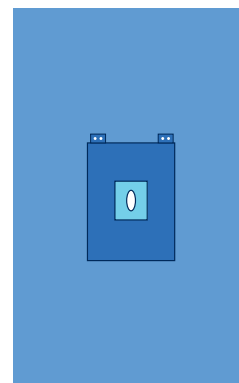

200x320cm

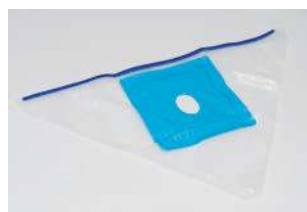

arthroscopy pouch



2x  
30x30cm



2x  
10x50cm



14x250cm



30x60cm

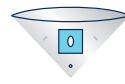

60x100cm

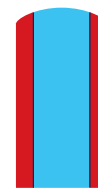

80x140cm

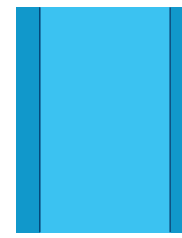

150x190cm

## AT-S-ART2-IP-C ARTHROSCOPY SET 2-IP

quantity	dimensions	component
1 pc.	200cm x 320cm	drape with elastic fenestration 6cm x 8cm, integrated fluid collection pouch, reinforced
2 pcs	30cm x 30cm	absorbent towel
3 pcs	10cm x 50cm	OP tape
1 pc.	14cm x 250cm	camera cable cover
1 pc.	30cm x 60cm	elastic limb cover
1 pc.	80cm x 140cm	Mayo stand cover, reinforced - red
1 pc.	150cm x 190cm	instrument table cover, reinforced

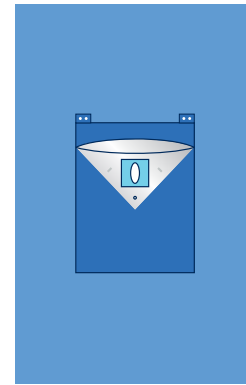

200x320cm

-  bulk packaging: 10 sets
-  hydrophobic SMS material
-  highly absorbent material

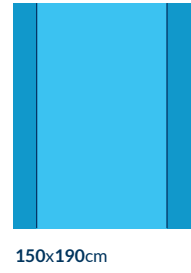
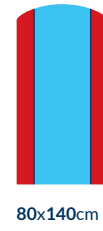
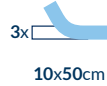

## AT-S-ART3-C ARTHROSCOPY SET 3

quantity	dimensions	component
1 pc.	200cm x 320cm	drape with elastic fenestration 6cm x 8cm, reinforced
2 pcs	30cm x 30cm	absorbent towel
3 pcs	10cm x 50cm	OP tape
1 pc.	14cm x 250cm	camera cable cover
1 pc.	30cm x 60cm	elastic limb cover
1 pc.	80cm x 140cm	Mayo stand cover, reinforced - red
1 pc.	150cm x 190cm	instrument table cover, reinforced

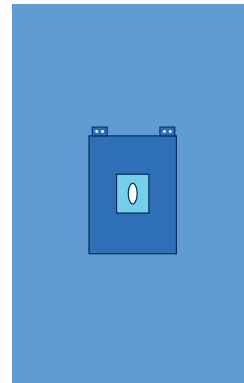

200x320cm

-  bulk packaging: 12 sets
-  hydrophobic SMS material
-  highly absorbent material

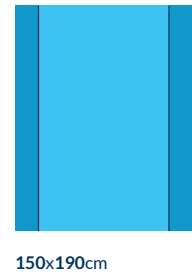
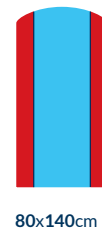
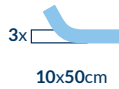
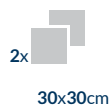

## AT-S-ART4-S ARTHROSCOPY SET 4

quantity	dimensions	component
1 pc.	230cm x 320cm	drape with elastic fenestration $\varnothing$ 7cm, integrated fluid collection pouch
4 pcs	30cm x 30cm	absorbent towel
3 pcs	10cm x 50cm	OP tape
1 pc.	22cm x 75cm	elastic limb cover
1 pc.	80cm x 145cm	Mayo stand cover, reinforced
2 pcs	150cm x 190cm	instrument table cover, reinforced

 bulk packaging:  
7 sets

**2x**  
double instrument  
table cover

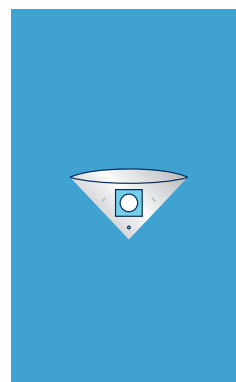

230x320cm

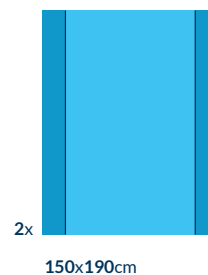
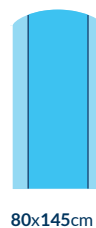
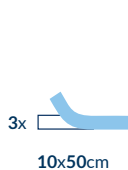
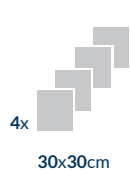

## AT-S-ART5-SP ARTHROSCOPY SET 5

quantity	dimensions	component
1 pc.	230cm x 300cm	drape with elastic fenestration $\varnothing$ 7cm, reinforced
4 pcs	30cm x 30cm	absorbent towel
3 pcs	10cm x 50cm	OP tape
1 pc.	22cm x 75cm	elastic limb cover
1 pc.	80cm x 145cm	Mayo stand cover, reinforced
2 pcs	150cm x 190cm	instrument table cover, reinforced

 bulk packaging:  
7 sets

 highly absorbent  
material

**2x**  
double instrument  
table cover

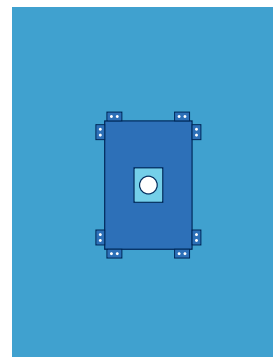

230x300cm

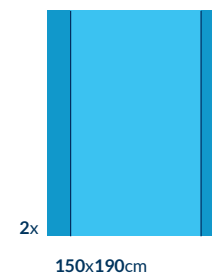
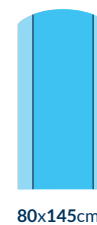
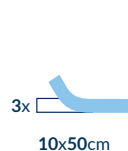
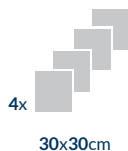

## AT-S-HIP1-C HIP SET 1

quantity	dimensions	component
1 pc.	200cm x 260cm	drape with adhesive U-split 8,5cm x 85cm, reinforced
1 pc.	170cm x 240cm	drape with adhesive edge, reinforced
4 pcs	30cm x 30cm	absorbent towel
2 pcs	10cm x 50cm	OP tape
1 pc.	35cm x 120cm	elastic limb cover
1 pc.	80cm x 140cm	Mayo stand cover, reinforced - red
1 pc.	150cm x 190cm	instrument table cover, reinforced

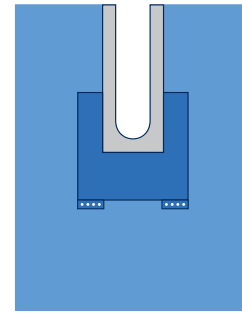

200x260cm

- bulk packaging:  
8 sets
- hydrophobic  
SMS material
- highly absorbent  
material
- drape with  
U-split

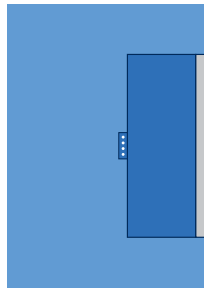

170x240cm



4x 30x30cm



2x 10x50cm



35x120cm

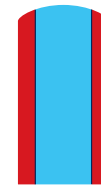

80x140cm

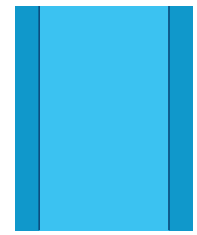

150x190cm

## AT-S-HIP2-C HIP SET 2

quantity	dimensions	component
1 pc.	200cm x 260cm	drape with adhesive U-split 8,5cm x 85cm, reinforced
1 pc.	170cm x 300cm	drape with adhesive edge, reinforced
1 pc.	160cm x 180cm	drape with adhesive edge
4 pcs	30cm x 30cm	absorbent towel
2 pcs	10cm x 50cm	OP tape
1 pc.	35cm x 120cm	elastic limb cover
1 pc.	80cm x 140cm	Mayo stand cover, reinforced - red
1 pc.	150cm x 190cm	instrument table cover, reinforced

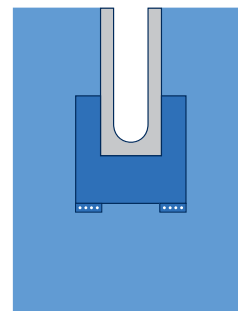

200x260cm

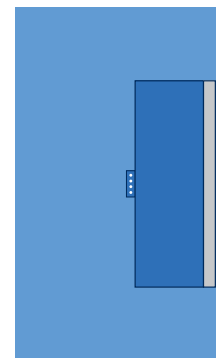

170x300cm

- bulk packaging:  
8 sets
- hydrophobic  
SMS material
- highly absorbent  
material
- drape with  
U-split

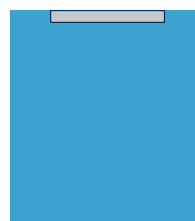

160x180cm



4x 30x30cm



2x 10x50cm



35x120cm

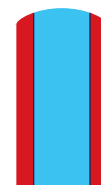

80x140cm

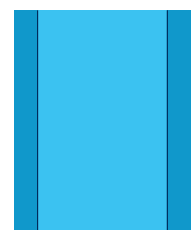

150x190cm



## AT-S-HIP3-SP

## HIP SET 3

quantity	dimensions	component
1 pc.	230cm x 260cm	drape with adhesive U-split 20cm x 100cm, reinforced
1 pc.	150cm x 240cm	drape with adhesive edge, reinforced
1 pc.	180cm x 180cm	drape with adhesive edge, reinforced
2 pcs	75cm x 90cm	drape with adhesive edge, reinforced
4 pcs	30cm x 30cm	absorbent towel
3 pcs	10cm x 50cm	OP tape
1 pc.	30cm x 120cm	elastic limb cover
1 pc.	10cm x 450cm	elastic bandage
1 pc.	80cm x 145cm	Mayo stand cover, reinforced
1 pc.	150cm x 190cm	instrument table cover, reinforced

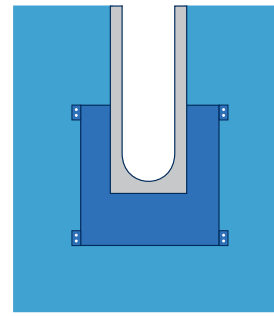

230x260cm

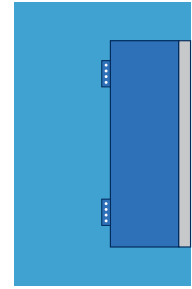

150x240cm



bulk packaging:  
5 sets



highly absorbent  
material



drape with  
U-split



elastic bandage

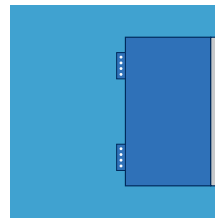

180x180cm

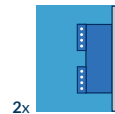

2x  
75x90cm

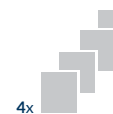

4x  
30x30cm



3x  
10x50cm



30x120cm



10x450cm

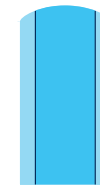

80x145cm

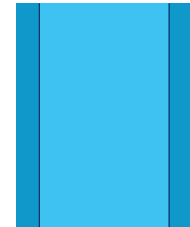

150x190cm

## AT-S-SHLR1-C

## SHOULDER SET 1

quantity	dimensions	component
1 pc.	200cm x 260cm	drape with adhesive U-split 8,5cm x 85cm, reinforced
1 pc.	170cm x 180cm	drape with adhesive edge, reinforced
1 pc.	150cm x 180cm	drape with adhesive edge
4 pcs	30cm x 30cm	absorbent towel
1 pc.	10cm x 50cm	OP tape
1 pc.	30cm x 60cm	elastic limb cover
1 pc.	80cm x 140cm	Mayo stand cover, reinforced - red
1 pc.	150cm x 190cm	instrument table cover, reinforced

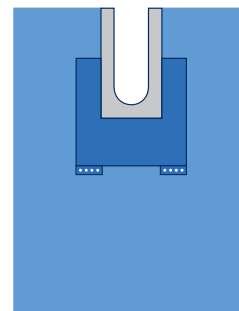

200x260cm

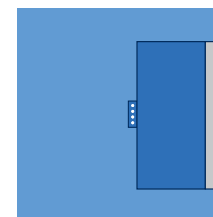

170x180cm



bulk packaging:  
8 sets



hydrophobic  
SMS material



highly absorbent  
material



drape with  
U-split



150x180cm



4x  
30x30cm



10x50cm



30x60cm



80x140cm

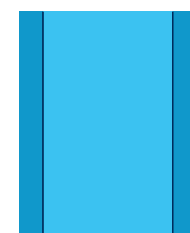

150x190cm

## AT-S-SHLR2-S SHOULDERS SET 2

quantity	dimensions	component
1 pc.	263cm x 406cm	drape with elastic fenestration 13cm x 14cm, integrated fluid collection pouch
4 pcs	30cm x 30cm	absorbent towel
2 pcs	10cm x 50cm	OP tape
1 pc.	22cm x 75cm	elastic limb cover
1 pc.	80cm x 145cm	Mayo stand cover, reinforced
1 pc.	150cm x 190cm	instrument table cover, reinforced

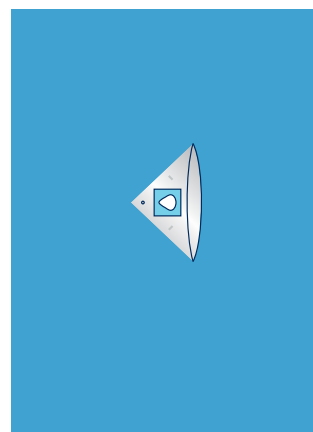

263x406cm



bulk packaging:  
8 sets



chair position

### TRUE OR FALSE?

**"I am too young / too old for hip replacement."**

**NOTHING COULD BE MORE WRONG!**

Hip endoprosthesis is performed in patients from a wide age range. Very important is patient condition, however this is only one factor which classifies patient for procedure.

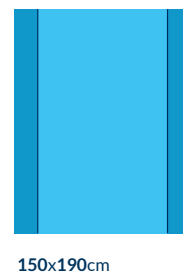
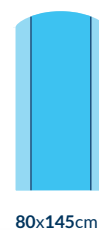
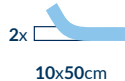



# GYNAECOLOGY AND UROLOGY

## AT-S-GYN1-S GYNAECOLOGY SET 1

quantity	dimensions	component
1 pc.	160/240cm x 180cm	drape integrated with limb covers, adhesive perineal fenestration 10cm x 15cm, integrated fluid collection pouch 35cm x 50cm with formable molder, filter and tubing port
1 pc.	75cm x 90cm	drape without adhesive edge
4 pcs	30cm x 30cm	absorbent towel
1 pc.	10cm x 50cm	OP tape
1 pc.	150cm x 190cm	instrument table cover, reinforced



bulk packaging:  
6 sets



fluid collection pouch with filter and tubing port

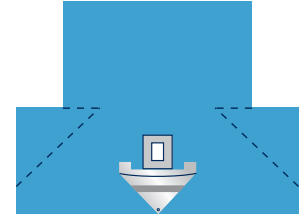

160/240x180cm



75x90cm

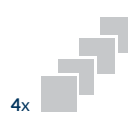

4x

30x30cm



10x50cm

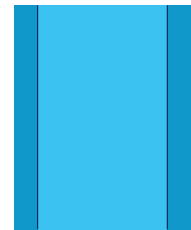

150x190cm

## AT-S-GYN2-C GYNAECOLOGY SET 2

quantity	dimensions	component
1 pc.	160/240cm x 180cm	drape integrated with limb covers, adhesive perineal fenestration 10cm x 15cm, integrated fluid collection pouch 35cm x 50cm with formable molder, filter and tubing port, reinforced
1 pc.	75cm x 90cm	drape without adhesive edge
4 pcs	30cm x 30cm	absorbent towel
1 pc.	10cm x 50cm	OP tape
1 pc.	80cm x 140cm	Mayo stand cover, reinforced - red
1 pc.	150cm x 190cm	instrument table cover, reinforced



bulk packaging:  
6 sets



hydrophobic  
SMS material



highly absorbent  
material



BESTSELLER



fluid collection pouch with filter and tubing port

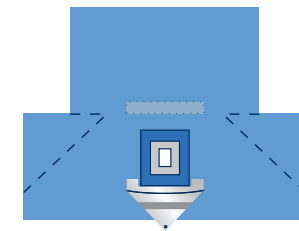

160/240x180cm



75x90cm



4x

30x30cm



10x50cm



80x140cm

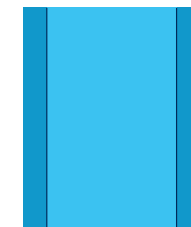

150x190cm

## AT-S-GYN3-C GYNAECOLOGY SET 3

quantity	dimensions	component
1 pc.	170cm x 180cm	drape with adhesive edge, reinforced
2 pcs	100cm x 150cm	drape with adhesive edge
1 pc.	75cm x 90cm	drape with adhesive edge
1 pc.	100cm x 150cm	drape without adhesive edge
4 pcs	30cm x 30cm	absorbent towel
1 pc.	10cm x 50cm	OP tape
2 pcs	70cm x 120cm	limb cover
1 pc.	80cm x 140cm	Mayo stand cover, reinforced - red
1 pc.	150cm x 190cm	instrument table cover, reinforced

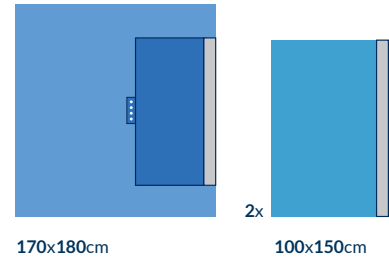

 bulk packaging:  
6 sets

 hydrophobic  
SMS material

 highly absorbent  
material

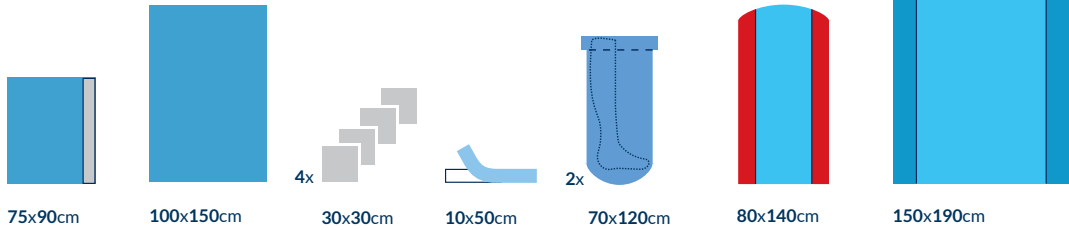

## AT-S-CYST1-S CYSTOSCOPY SET 1

quantity	dimensions	component
1 pc.	75cm x 90cm	drape with adhesive fenestration 6cm x 8cm
2 pcs	70cm x 120cm	limb cover
1 pc.	100cm x 150cm	instrument table cover, reinforced

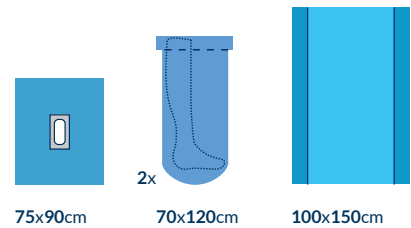

 bulk packaging:  
20 sets

## AT-S-UROG2-S URO/GYNAECOLOGY SET 2

quantity	dimensions	component
1 pc.	160cm x 180cm	drape with adhesive edge
1 pc.	75cm x 100cm	drape with adhesive fenestration 6cm x 14cm
1 pc.	10cm x 50cm	OP tape
2 pcs	70cm x 120cm	limb cover
1 pc.	80cm x 140cm	Mayo stand cover, reinforced - red
1 pc.	150cm x 190cm	instrument table cover, reinforced

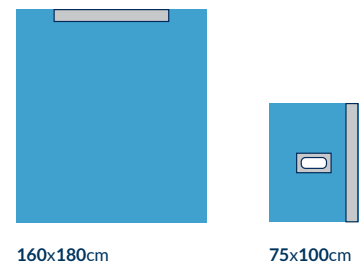

 bulk packaging:  
10 sets

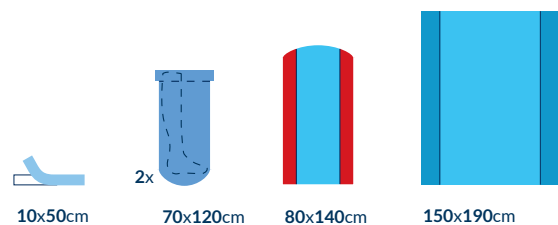

## AT-S-UROG3-S URO/GYNAECOLOGY SET 3

quantity	dimensions	component
1 pc.	75cm x 200cm	drape with adhesive diamond-shaped fenestration 8cm x 12cm
4 pcs	30cm x 30cm	absorbent towel
2 pcs	70cm x 120cm	limb cover
1 pc.	100cm x 150cm	instrument table cover, reinforced



bulk packaging:  
20 sets

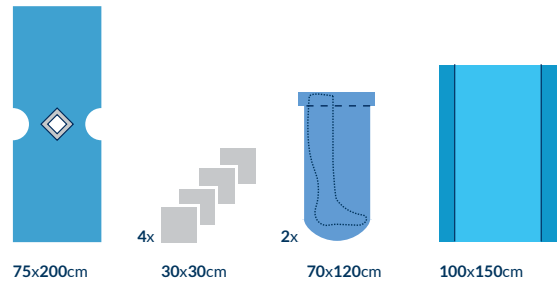

## AT-S-TUR1-S TUR SET 1

quantity	dimensions	component
1 pc.	190cm x 230cm	drape integrated with limb covers, adhesive abdominal fenestration $\varnothing$ 6cm and adhesive perineal fenestration $\varnothing$ 6cm, finger coat, fluid collection pouch with formable mold, filter and tubing port
4 pcs	30cm x 30cm	absorbent towel
1 pc.	10cm x 50cm	OP tape
1 pc.	150cm x 190cm	instrument table cover, reinforced



bulk packaging:  
12 sets



hydrophobic  
SMS material



made of two  
different materials

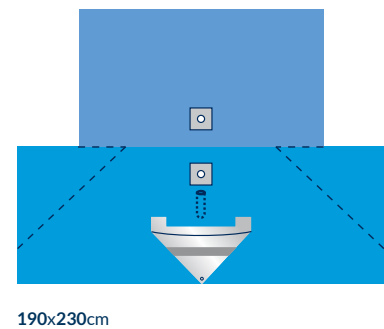

190x230cm

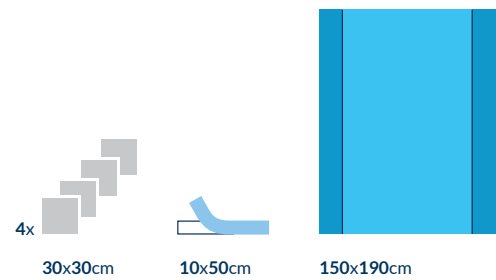

## AT-S-TUR1-S-P1 TUR SET 1

quantity	dimensions	component
1 pc.	175cm x 240cm	drape with integrated leggings, abdominal fenestration, perineal fenestration with finger coat and fluid collection pouch. Drape made of hydrophobic 2 layer non-woven material PP and PE foil
2 pcs	30cm x 30cm	absorbent towel
1 pc.	2cm x 22cm	surgical tape, Velcro type
1 pc.	150cm x 190cm	instrument table cover, reinforced



bulk packaging:  
12 sets

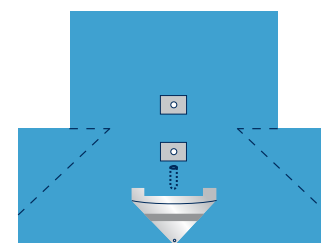

175x240cm

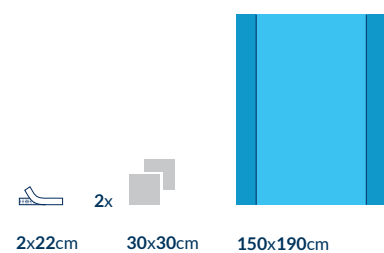

## AT-S-PCNL1-IP-S PERCUTANEOUS LITHOTRIPSY SET 1-IP

quantity	dimensions	component
1 pc.	180cm x 300cm	drape with adhesive fenestration 21,5cm x 24cm, integrated with long fluid collection pouch
1 pc.	150cm x 190cm	instrument table cover, reinforced



bulk packaging:  
12 sets



kidney stone  
removal set

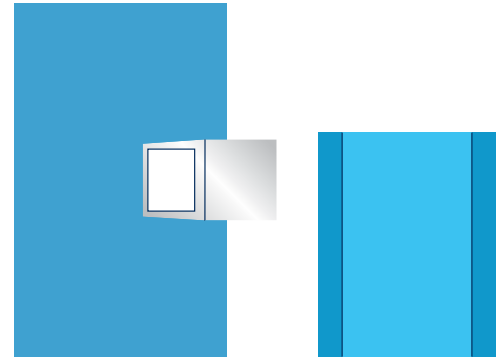

180x300cm

150x190cm



## OBSTETRICS

## AT-S-CSEC1-C C-SECTION SET 1

quantity	dimensions	component
1 pc.	200cm x 320cm	drape with adhesive fenestration 25cm x 30cm, integrated with fluid collection pouch 75cm x 85cm with tubing ports
4 pcs	30cm x 30cm	absorbent towel
1 pc.	10cm x 50cm	OP tape
1 pc.	75cm x 80cm	absorbent baby towel
1 pc.	80cm x 140cm	Mayo stand cover, reinforced - red
1 pc.	150cm x 190cm	instrument table cover, reinforced



bulk packaging:  
10 sets



hydrophobic  
SMS material



fluid collection  
pouch 360°

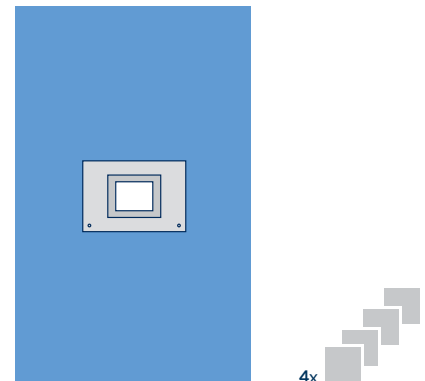

200x320cm

4x  
30x30cm



10x50cm



75x80cm



80x140cm

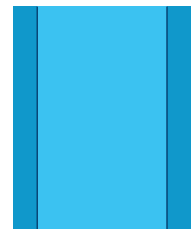

150x190cm

**AT-S-CSEC1-IF-C C-SECTION SET 1-IF**

quantity	dimensions	component
1 pc.	200cm x 320cm	drape with adhesive fenestration 25cm x 30cm filled with an incise film, integrated with fluid collection pouch 75cm x 85cm with tubing ports
4 pcs	30cm x 30cm	absorbent towel
1 pc.	10cm x 50cm	OP tape
1 pc.	75cm x 80cm	absorbent baby towel
1 pc.	80cm x 140cm	Mayo stand cover, reinforced - red
1 pc.	150cm x 190cm	instrument table cover, reinforced

 bulk packaging: 10 sets  
 hydrophobic SMS material  
 fluid collection pouch 360°

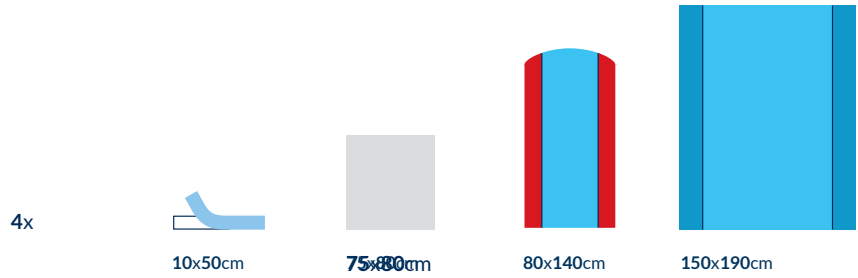
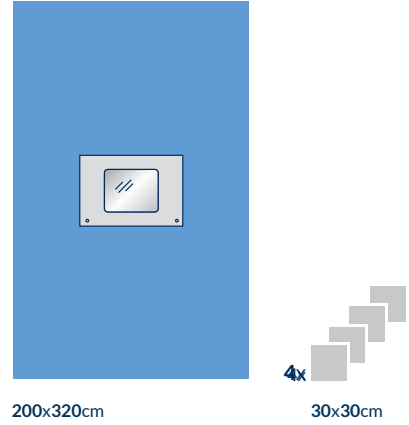

**AT-S-CSEC2-IF-C C-SECTION SET 2-IF**

quantity	dimensions	component
1 pc.	200cm x 320cm	drape with adhesive fenestration 25cm x 30cm filled with an incise film, integrated with fluid collection pouch 75cm x 85cm with tubing ports
4 pcs	30cm x 30cm	absorbent towel
1 pc.	10cm x 50cm	OP tape
1 pc.	2cm x 22cm	surgical tape, Velcro type
1 pc.	75cm x 80cm	absorbent baby towel
10 pcs	40cm x 40cm	gauze lap sponge with X-ray thread and belt
20 pcs	30cm x 30cm	gauze ball
1 pc.	L	surgical gown STANDARD
3 pcs	XL	surgical gown STANDARD
1 pc.	80cm x 140cm	Mayo stand cover, reinforced - red
1 pc.	150cm x 190cm	instrument table cover, reinforced

 bulk packaging: 6 sets  
 hydrophobic SMS material  
 fluid collection pouch 360°  
 PREMIUM set

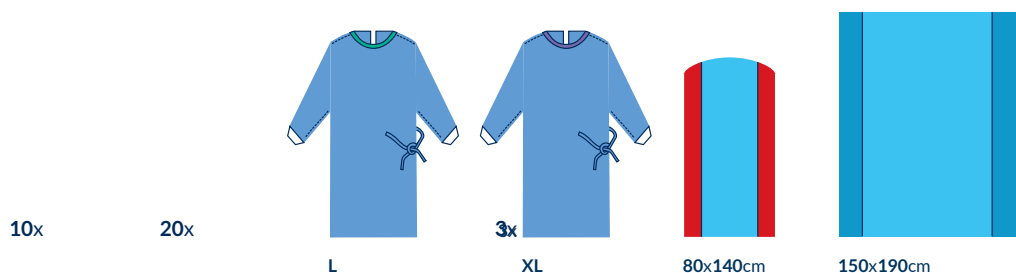
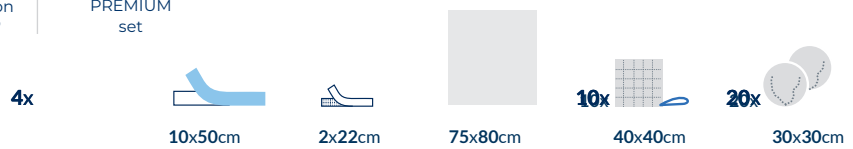
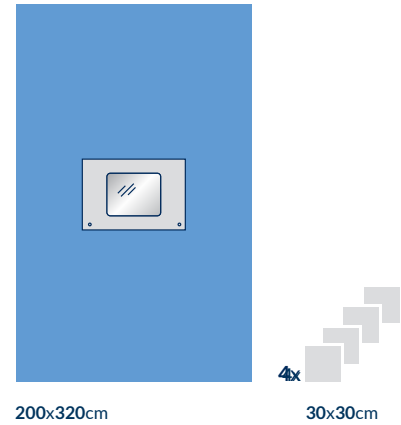

quantity	dimensions	component
1 pc.	180/240cm x 215cm	drape integrated with limb covers, adhesive fenestration 23,5cm x 23,5cm x 22,5cm x 33cm filled with an incise film, integrated with fluid collection pouch 56cm x 80cm with tubing port, reinforced
4 pcs	30cm x 30cm	absorbent towel
1 pc.	10cm x 50cm	OP tape
1 pc.	75cm x 80cm	absorbent baby towel
1 pc.	80cm x 140cm	Mayo stand cover, reinforced - red
1 pc.	150cm x 190cm	instrument table cover, reinforced

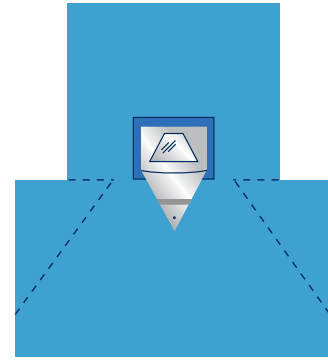

180/240x215cm

 bulk packaging:  
10 sets

 highly absorbent  
material

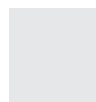

75x80cm



4x  
30x30cm



10x50cm



80x140cm

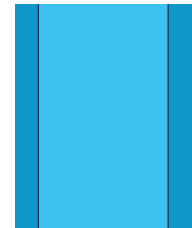

150x190cm

AT-S-DEL1-S

DELIVERY SET 1

quantity	dimensions	component
1 pc.	90cm x 120cm	drape without adhesive edge
2 pcs	30cm x 30cm	absorbent towel
3 pcs	75cm x 80cm	absorbent baby towel
1 pc.	60cm x 90cm	absorbent underpad
1 pc.	80cm x 130cm	foil apron
2 pcs	-	umbilical cord clamp

 bulk packaging:  
20 sets



90x120cm



2x  
30x30cm



3x  
75x80cm



60x90cm

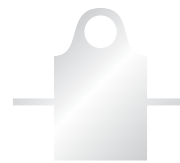

80x130cm



2x

AT-S-DEL2-S

DELIVERY SET 2

quantity	dimensions	component
2 pcs	90cm x 120cm	drape without adhesive edge
6 pcs	30cm x 30cm	absorbent towel
1 pc.	75cm x 80cm	absorbent baby towel
2 pcs	60cm x 90cm	absorbent underpad

 bulk packaging:  
20 sets



2x  
90x120cm



6x  
30x30cm



75x80cm



2x

60x90cm



## AT-S-DEL3-S DELIVERY SET 3

quantity	dimensions	component
1 pc.	90cm x 120cm	drape without adhesive edge
2 pcs	30cm x 30cm	absorbent towel
3 pcs	75cm x 80cm	absorbent baby towel
1 pc.	60cm x 90cm	absorbent underpad
1 pc.	80cm x 130cm	foil apron
2 pcs	-	umbilical cord clamp
10 pcs	30cm x 30cm	gauze ball



bulk packaging:  
15 sets

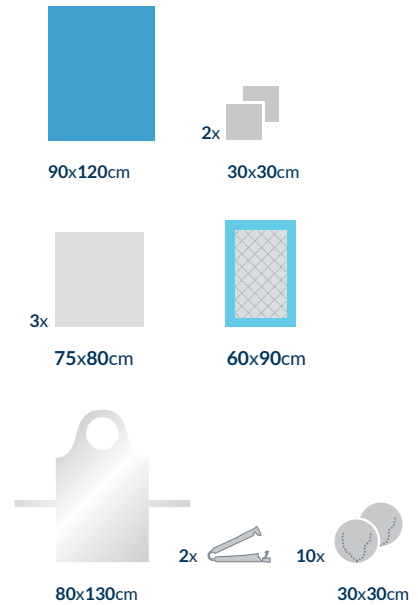

## AT-S-DEL4-S DELIVERY SET 4

quantity	dimensions	component
2 pcs	90cm x 120cm	drape without adhesive edge
6 pcs	30cm x 30cm	absorbent towel
1 pc.	75cm x 80cm	absorbent baby towel
1 pc.	60cm x 90cm	absorbent underpad
1 pc.	80cm x 130cm	foil apron
2 pcs	-	umbilical cord clamp



bulk packaging:  
22 sets

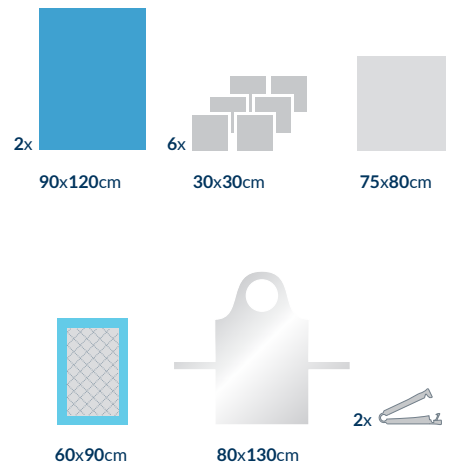

## AT-S-DEL5-SP DELIVERY SET 5

quantity	dimensions	component
1 pc.	114cm x 150cm	delivery drape integrated with fluid collection pouch 78cm x 80cm with formable mold, filter and tubing port, reinforced
2 pcs	30cm x 30cm	absorbent towel
1 pc.	75cm x 80cm	absorbent baby towel
1 pc.	150cm x 190cm	instrument table cover, reinforced



bulk packaging:  
18 sets

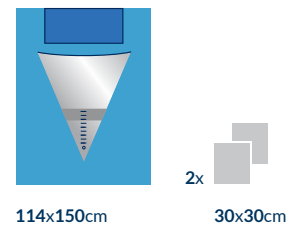

pouch with a very large scale

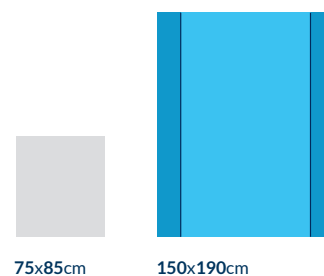

**AT-S-OPHT2-IF-C OPTHALMIC SET 2-IF**

quantity	dimensions	component
1 pc.	120cm x 170cm	ophthalmic drape with fenestration 10cm x 10cm filled with an incise film, integrated with 2 fluid collection pouches and with 1 formable mold, reinforced
2 pcs	30cm x 30cm	absorbent towel
1 pc.	40cm x 65cm	Phaco tray cover
2 pcs	35cm x 75cm	armboard cover
1 pc.	80cm x 140cm	Mayo stand cover, reinforced - red
1 pc.	150cm x 190cm	instrument table cover, reinforced

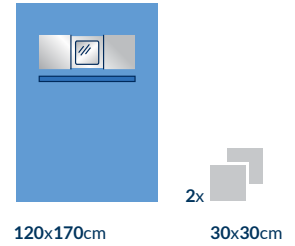

 bulk packaging:  
12 sets

 hydrophobic  
SMS material

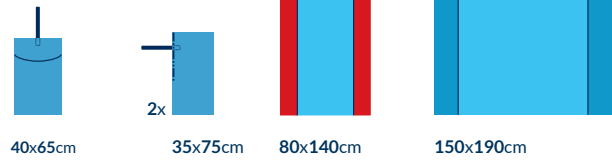

**AT-S-OPHT3-IF-C OPTHALMIC SET 3-IF**

quantity	dimensions	component
1 pc.	140cm x 240cm	ophthalmic drape with fenestration 10cm x 10cm filled with an incise film, integrated with 2 fluid collection pouches and with 1 formable mold, reinforced
4 pcs	30cm x 30cm	absorbent towel
1 pc.	40cm x 65cm	Phaco tray cover
2 pcs	35cm x 75cm	armboard cover
1 pc.	L	surgical gown STANDARD
1 pc.	XL	surgical gown STANDARD
1 pc.	80cm x 140cm	Mayo stand cover, reinforced - red
1 pc.	150cm x 190cm	instrument table cover, reinforced

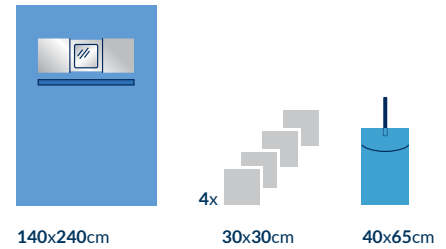

 bulk packaging:  
10 sets

 hydrophobic  
SMS material

☆☆☆  
PREMIUM  
set

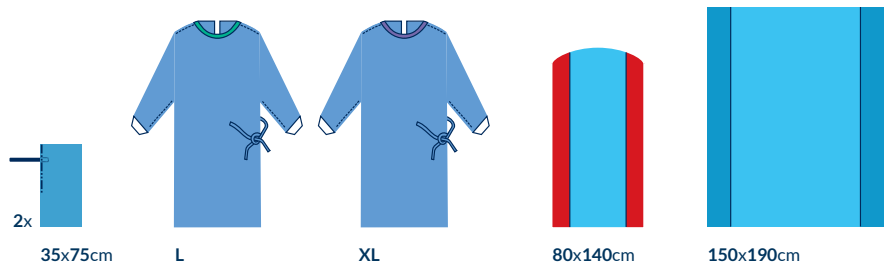



# NEUROSURGERY AND OTOLARYNGOLOGY

## AT-S-OTOL1-C OTOLARYNGOLOGY SET 1

quantity	dimensions	component
1 pc.	200cm x 280cm	drape with adhesive fenestration ø 10cm, reinforced
2 pcs	30cm x 30cm	absorbent towel
1 pc.	10cm x 50cm	OP tape
1 pc.	150cm x 190cm	instrument table cover, reinforced

 bulk packaging:  
20 sets

 hydrophobic  
SMS material

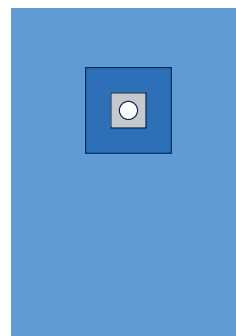
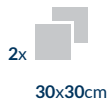

200x280cm

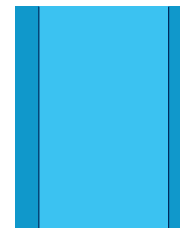

150x190cm

 highly absorbent  
material

## AT-S-OTOL2-C OTOLARYNGOLOGY SET 2

quantity	dimensions	component
1 pc.	150cm x 200cm	drape with adhesive U-split 6cm x 65cm, reinforced
1 pc.	150cm x 180cm	drape with adhesive edge
1 pc.	75cm x 90cm	drape with adhesive edge
4 pcs	30cm x 30cm	absorbent towel
1 pc.	10cm x 50cm	OP tape
1 pc.	80cm x 140cm	Mayo stand cover, reinforced - red
1 pc.	150cm x 190cm	instrument table cover, reinforced

 bulk packaging:  
12 sets

 hydrophobic  
SMS material

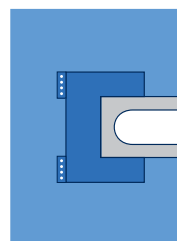
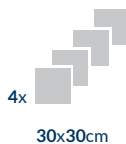

150x200cm



150x180cm

 highly absorbent  
material

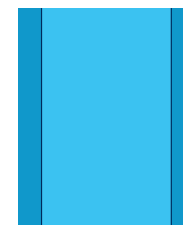

150x190cm

## AT-S-CRA1-IF-SP CRANIOTOMY SET 1-IF

quantity	dimensions	component
1 pc.	230cm x 300cm	drape with adhesive fenestration 20cm x 30cm filled with anicise film, with fluid collection pouch, reinforced
4 pcs	50cm x 50cm	drape with adhesive edge
2 pcs	30cm x 34cm	absorbent towel
1 pc.	10cm x 50cm	OP tape
1 pc.	2cm x 25cm	surgical tape, velcro type
1 pc.	80cm x 145cm	Mayo stand cover, reinforced
1 pc.	150cm x 190cm	instrument table cover, reinforced

 bulk packaging:  
12 sets

 head surgery

 highly absorbent  
material

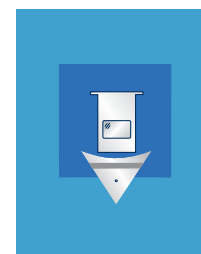
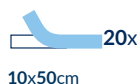

230x300cm

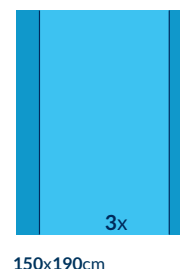
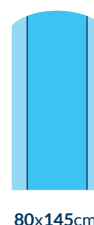
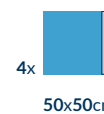



# CARDIOSURGERY AND ANGIOGRAPHY

## AT-S-ABL1-IF-SP ABLATION SET 1-IF

quantity	dimensions	component
1 pc.	180cm x 305cm	drape with 2 adhesive fenestrations 12cm x 15cm filled with an incise film, reinforced
2 pcs	30cm x 30cm	absorbent towel
1 pc.	ø 80cm	circular banded cover for medical equipment
1 pc.	XL	surgical gown STANDARD
1 pc.	150cm x 190cm	instrument table cover, reinforced

 bulk packaging:  
12 sets

 highly absorbent  
material

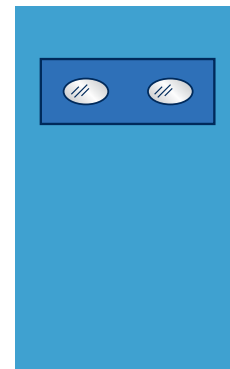

180x305cm



2x

30x30cm



80x80cm

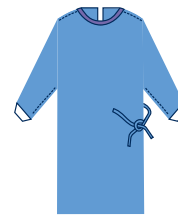

XL

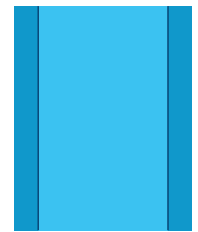

150x190cm

## AT-S-ANG2-C ANGIOGRAPHY SET 2

quantity	dimensions	component
1 pc.	220cm x 320cm	drape with 2 adhesive fenestrations ø 10cm, integrated with transparent foil inserts protecting the control panel reinforced
1 pc.	10cm x 50cm	OP tape
1 pc.	XL	surgical gown STANDARD
1 pc.	100cm x 150cm	drape without adhesive edge
1 pc.	100cm x 150cm	instrument table cover, reinforced

 bulk packaging:  
10 sets

 hydrophobic  
SMS material

 highly absorbent  
material

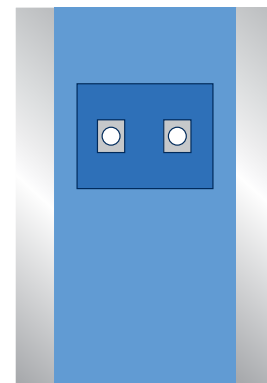

220x320cm



10x50cm

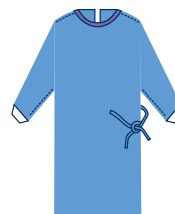

XL



100x150cm

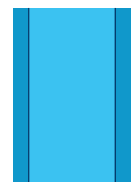



100x150cm



## SURGICAL GOWNS



## STERILE GOWN NORMAL

ref.	size	trimming	packaging unit
AT-SGN-L	L		1 pc.
AT-SGN-XL	XL		1 pc.

  
bulk packaging:  
25 pcs



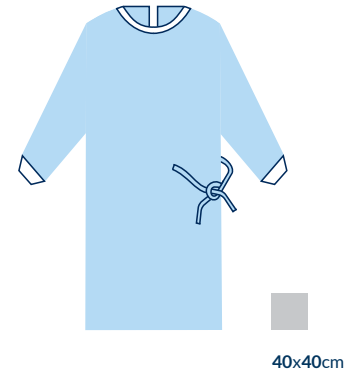

  
includes  
**1 absorbent towel**  
40cm x 40cm

  
22 g/m<sup>2</sup>



40x40cm

## STERILE SURGICAL GOWN STANDARD

ref.	size	trimming	packaging unit
AT-SGS-M 1	M		1 pc.
AT-SGS-L 1	L		1 pc.
AT-SGS-XL 1	XL		1 pc.
AT-SGS-XXL 1	XXL		1 pc.
AT-SGS-XXXL 1	XXXL		1 pc.

  
bulk packaging:  
25 pcs

  
includes  
**2 absorbent towels**  
30cm x 30cm

  
35 g/m<sup>2</sup>

 **BESTSELLER**

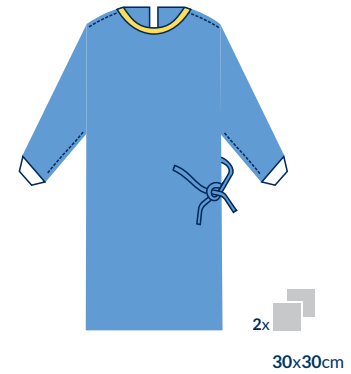

2x 30x30cm

## STERILE SURGICAL GOWN STANDARD

ref.	size	trimming	packaging unit
AT-SGS-M 1E	M		1 pc.
AT-SGS-L 1E	L		1 pc.
AT-SGS-XL 1E	XL		1 pc.
AT-SGS-XXL 1E	XXL		1 pc.

  
bulk packaging:  
25 pcs

  
without  
**2 absorbent towels**  
30cm x 30cm

  
economic  
version

  
35 g/m<sup>2</sup>

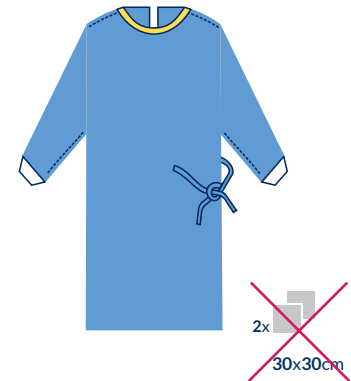

2x ~~30x30cm~~

## STERILE SURGICAL GOWN STANDARD

ref.	size	trimming	packaging unit
AT-SGS-M 1A	M		1 pc.
AT-SGS-L 1A	L		1 pc.
AT-SGS-XL 1A	XL		1 pc.
AT-SGS-XXL 1A	XXL		1 pc.

  
bulk packaging:  
50 pcs

  
includes  
**2 absorbent towels**  
30cm x 40cm

  
without  
colorful trimming

  
35 g/m<sup>2</sup>

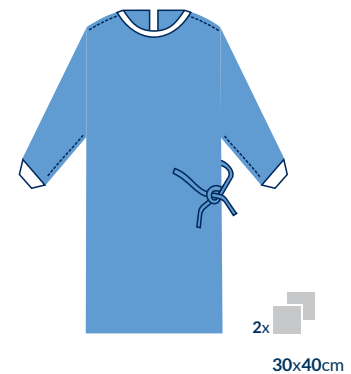

2x 30x40cm

## STERILE SURGICAL GOWN STANDARD

ref.	size	trimming	packaging unit
AT-SGS-M	M		1 pc.
AT-SGS-L	L		1 pc.
AT-SGS-XL	XL		1 pc.
AT-SGS-XXL	XXL		1 pc.

bulk packaging:  
25 pcs

includes  
**2 absorbent towels**  
30cm x 30cm

45 g/m<sup>2</sup>

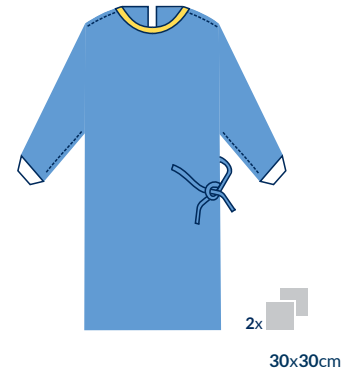

## STERILE SURGICAL GOWN SOFT

ref.	size	trimming	packaging unit
35SSG-M	M		1 pc.
35SSG-L	L		1 pc.
35SSG-XL	XL		1 pc.
35SSG-XXL	XXL		1 pc.

bulk packaging:  
50 pcs

includes  
**2 absorbent towels**  
30cm x 40cm

soft SMS  
material

35 g/m<sup>2</sup>



## STERILE SURGICAL GOWN STANDARD PLUS

ref.	size	trimming	packaging unit
AT-SGSP-M 1	M		1 pc.
AT-SGSP-L 1	L		1 pc.
AT-SGSP-XL 1	XL		1 pc.
AT-SGSP-XXL 1	XXL		1 pc.
AT-SGSP-XXXL 1	XXXL		1 pc.

bulk packaging:  
25 pcs

includes  
**2 absorbent towels**  
30cm x 30cm

35 g/m<sup>2</sup>

**BESTSELLER**

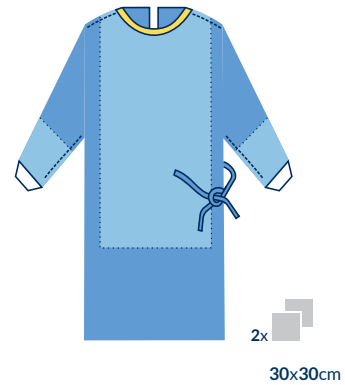

## STERILE SURGICAL GOWN STANDARD PLUS

ref.	size	trimming	packaging unit
AT-SGSP-M 1E	M		1 pc.
AT-SGSP-L 1E	L		1 pc.
AT-SGSP-XL 1E	XL		1 pc.
AT-SGSP-XXL 1E	XXL		1 pc.

bulk packaging:  
25 pcs

without  
**2 absorbent towels**  
30cm x 30cm

economic  
version

35 g/m<sup>2</sup>

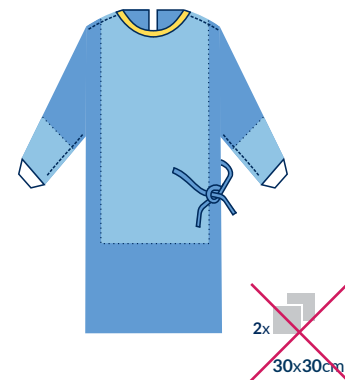

## STERILE SURGICAL GOWN STANDARD PLUS

ref.	size	trimming	packaging unit
AT-SGSP-M 1A	M		1 pc.
AT-SGSP-L 1A	L		1 pc.
AT-SGSP-XL 1A	XL		1 pc.
AT-SGSP-XXL 1A	XXL		1 pc.

bulk packaging:  
50 pcs

includes  
**2 absorbent towels**  
30cm x 40cm

without  
colorful trimming

35 g/m<sup>2</sup>

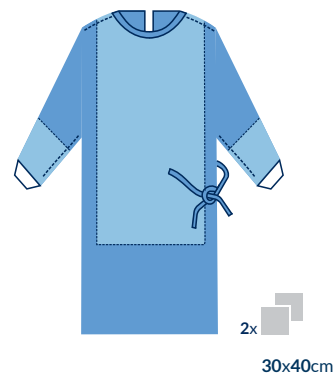

## STERILE SURGICAL GOWN STANDARD PLUS

ref.	size	trimming	packaging unit
AT-SGSP-M	M		1 pc.
AT-SGSP-L	L		1 pc.
AT-SGSP-XL	XL		1 pc.
AT-SGSP-XXL	XXL		1 pc.

bulk packaging:  
25 pcs

includes  
**2 absorbent towels**  
30cm x 30cm

45 g/m<sup>2</sup>

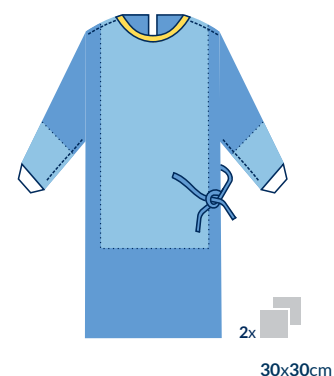

## STERILE SURGICAL GOWN EXTRA SAFE

AT-SGES-XXL 1	XXL		1 pc.
---------------	-----	--	-------

bulk packaging:  
25 pcs

includes  
**2 absorbent towels**  
30cm x 30cm

extended  
style

35 g/m<sup>2</sup>



## STERILE SURGICAL GOWN COMFORT

AT-SGC-M	M		1 pc.
AT-SGC-L	L		1 pc.
AT-SGC-XL	XL		1 pc.
AT-SGC-XXL	XXL		1 pc.

bulk packaging:  
25 pcs

includes  
**2 absorbent towels**  
30cm x 30cm

68 g/m<sup>2</sup>

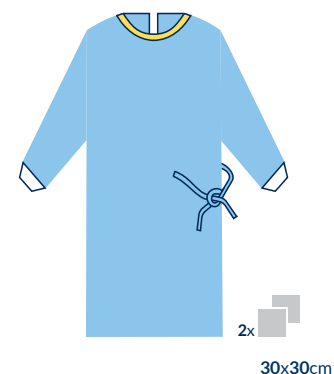



## STERILE SURGICAL GOWN COMFORT PLUS

AT-SGCP-M	M		1 pc.
AT-SGCP-L	L		1 pc.
AT-SGCP-XL	XL		1 pc.
AT-SGCP-XXL	XXL		1 pc.

bulk packaging:  
25 pcs

includes  
**2 absorbent towels**  
30cm x 30cm

68 g/m<sup>2</sup>

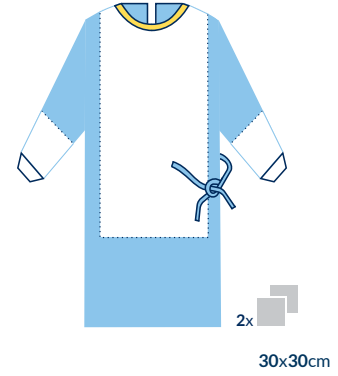

## NON-STERILE SURGICAL GOWNS

### NON-STERILE SURGICAL GOWN STANDARD

ref.	size	trimming	packaging unit
AT-NS-SGS-M 1E	M		1 pc.
AT-NS-SGS-L 1E	L		1 pc.
AT-NS-SGS-XL 1E	XL		1 pc.
AT-NS-SGS-XXL 1E	XXL		1 pc.

bulk packaging:  
50 pcs

35 g/m

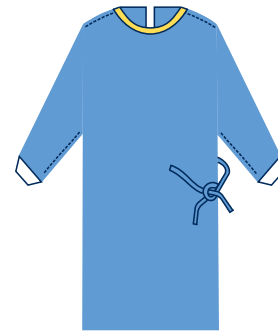

### NON-STERILE SURGICAL GOWN PREMIUM

ref.	size	trimming	packaging unit
AT-NS-SGP-L 1E	L		10 pcs
AT-NS-SGP-XL 1E	XL		10 pcs

bulk packaging:  
10 x 10 pcs

fully reinforced  
PP+PE





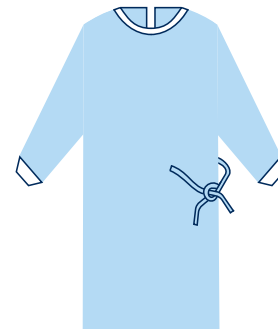







meet the standards  
of EN 14126

35 g/m<sup>2</sup>



## Material legends:

detailed information and material structures available in  
**material templet ALPHAtex**

	2-ply surgical drape with non-woven (PP+PE)		polypropylene
	table cover		neoprene
	SMS surgical drape		adhesive tape
	2-ply surgical drape with spunlace non-woven		PE foil
	Mayo stand cover red		PE foil blue
	Mayo stand cover blue		incise film
	reinforcement in the critical area		

## STANDARDS GUIDE

### SURGICAL GOWNS

CHARACTERISTICS	STANDARD	UNIT	REQUIREMENT			
			STANDARD REQUIREMENT		HIGH REQUIREMENT	
			CRITICAL PRODUCT AREA	LESS CRITICAL PRODUCT AREA	CRITICAL PRODUCT AREA	LESS CRITICAL PRODUCT AREA
microbial penetration - dry	EN ISO 22612	CFU	not required	≤ 300 <sup>a</sup>	not required	≤ 300 <sup>a</sup>
microbial penetration - wet	EN ISO 22610	I <sub>B</sub>	≥ 2,8 <sup>b</sup>	not required	6,0 <sup>bc</sup>	not required
cleanliness - microbial bioburden	EN ISO 11737-1	CFU/100 cm <sup>2</sup>	≤ 300	≤ 300	≤ 300	≤ 300
particulate release	EN ISO 9073-10	IPM	≤ 4,0	≤ 4,0	≤ 4,0	≤ 4,0
linting	EN ISO 9073-10	log <sub>10</sub> (lint count)	≥ 40	≥ 40	≥ 40	≥ 40
liquid penetration	EN ISO 811	cm H <sub>2</sub> O	≥ 30	≥ 10	≥ 100	≥ 10
bursting strength - dry	EN ISO 13938-1	kPa	≥ 40	≥ 40	≥ 40	≥ 40
bursting strength - wet	EN ISO 13938-1	kPa	≥ 40	not required	≥ 40	not required
tensile strength - dry	EN 29073-3	N	≥ 20	≥ 20	≥ 20	≥ 20
tensile strength - wet	EN 29073-3	N	≥ 20	not required	≥ 20	not required

CHARACTERISTICS	STANDARD	UNIT	REQUIREMENT			
			STANDARD REQUIREMENT		HIGH REQUIREMENT	
			CRITICAL PRODUCT AREA	LESS CRITICAL PRODUCT AREA	CRITICAL PRODUCT AREA	LESS CRITICAL PRODUCT AREA
microbial penetration - dry	EN ISO 22612	CFU	not required	≤ 300 <sup>a</sup>	not required	≤ 300 <sup>a</sup>
microbial penetration - wet	EN ISO 22610	I <sub>B</sub>	≥2,8 <sup>b</sup>	not required	6,0 <sup>bc</sup>	not required
cleanliness - microbial bioburden	EN ISO 11737-1	CFU/100 cm <sup>2</sup>	≤ 300	≤ 300	≤ 300	≤ 300
particulate release	EN ISO 9073-10	IPM	≤ 4,0	≤ 4,0	≤ 4,0	≤ 4,0
linting	EN ISO 9073-10	log <sub>10</sub> (lint count)	≥40	≥40	≥40	≥40
liquid penetration	EN ISO 811	cm H <sub>2</sub> O	≥30	≥10	≥100	≥10
bursting strength - dry	EN ISO 13938-1	kPa	≥40	≥40	≥40	≥40
bursting strength - wet	EN ISO 13938-1	kPa	≥40	not required	≥40	not required
tensile strength - dry	EN 29073-3	N	≥15	≥15	≥15	≥20
tensile strength - wet	EN 29073-3	N	≥15	not required	≥20	not required

### Standard EN 13795-1:2019

Essential requirements for surgical drapes and surgical gowns results from directive 93/42/EEC and have been included in EN 13795 standard "Surgical drapes, gowns and clean air suits, used as medical devices for patients, clinical staff and equipment". The purpose of EN 13795 standard is to maintain stable level of surgical drapes and surgical gowns safety for whole using period as well as minimalization of direct microorganisms transmission from medical staff to patient during surgical procedures.





# Cohesive bandages, kinesiotapes and others...

**yellowSPORT** is a brand offering comprehensive solutions in the field of sports medicine - according to the best practices that have been developed during physical activity tests. Based on the knowledge and experience of experts, the product line is dedicated not only to sportswomen and sportsmen but also to people taking their first steps to improve their physical activity (recreation).

**yellowSPORT** is primarily a tribute to, among others, physiotherapists, personal trainers, medical staff, sports clubs and owners of rehabilitation clinics. It creates an excellent base and product base while maintaining the expected ratio between cost and required quality.

The offer of products from the **yellowSPORT** family was prepared by specialists in the field of medical devices and physiotherapy. Therefore, from the very first day of its presence on the market, the „yellow brand” is a concrete response to the real needs of users, regardless of the level of advancement in the field of physical activity or just recreation.

**don't be shy, be yellow**



# yellowBAND

## COHESIVE BANDAGE

### USE:

- fixation of all types of non-adhesive dressings, especially where the elastic band slides
- fixation of splinting rails
- in compression therapy
- reducing joints mobility after an injury

### FEATURES:

- 1-layer, breathable, made of non-woven
- cohesive - it coheres to itself, does not adhere to skin, hair or other materials
- latex-free



### AVAILABLE SIZES AND COLOURS:



2,5cm x 4,5m	—	—	—	YCB-2545-X	—	YCB-2545-B	—	—	—	—	—	—	—	—
5cm x 4,5m	YCB-545-S	YCB-545-Y	YCB-545-G	YCB-545-X	YCB-545-R	YCB-545-B	YCB-545-W	YCB-545-BC	YCB-545-IO	YCB-545-IG	YCB-545-GP	YCB-545-VP	YCB-545-XP	YCB-545-PH
7,5cm x 4,5m	YCB-7545-S	YCB-7545-Y	YCB-7545-G	YCB-7545-X	YCB-7545-R	YCB-7545-B	YCB-7545-W	YCB-7545-BC	YCB-7545-IO	YCB-7545-IG	YCB-7545-GP	YCB-7545-VP	YCB-7545-XP	YCB-7545-PH
10cm x 4,5m	YCB-1045-S	YCB-1045-Y	YCB-1045-G	YCB-1045-X	YCB-1045-R	YCB-1045-B	YCB-1045-W	YCB-1045-BC	YCB-1045-IO	YCB-1045-IG	YCB-1045-GP	YCB-1045-VP	YCB-1045-XP	YCB-1045-PH
15cm x 4,5m	—	—	—	YCB-1545-X	—	—	—	—	—	—	—	—	—	—

# yellowTAPE

## KINESIOTAPE

### USE:

- kinesiotaping (dynamic taping)
- ensures nutrition of tissues and accelerates their recovery
- improves the biomechanics of movement without restraining joint's mobility
- reduces pain by affecting sensory receptors

### FEATURES:

- elastic, breathable tape made of cotton
- wave-like acrylic coating



### AVAILABLE SIZES AND COLOURS:



5cm x 5m	YT-55-S	YT-55-Y	YT-55-X	YT-55-B	YT-55-P	YT-55-RZ	YT-55-4
7,5cm x 5m	YT-755-S	—	YT-755-X	—	—	—	—



don't be shy, be yellow

CHECK THE PRODUCT

# yellow RIGID TAPE

## SPORTS TAPE, LINE GLUE COATING

### USE:

- athletic (rigid) taping
- sports injuries prevention
- protecting the joints from excessive mobility after the injury, which allows for activity continuation
- protection of the areas exposed to abrasions

### FEATURES:

- non-elastic, breathable tape made of cotton
- acrylic coating
- serrated edges - no need for scissors
- alternate arrangement of the stripes covered with glue and those without it form grooves that allow free sweat and water flow that reduces the tape's sensitivity and increases its resistance to environmental conditions

### AVAILABLE SIZES AND COLOURS:

	YRT-2591-W	YRT-3891-W	YRT-591-W
	2,5cm x 9,1m	3,8cm x 9,1m	5cm x 9,1m



191

# yellow SPORTS TAPE

## SPORTS TAPE

### USE:

- athletic (rigid) taping
- sports injuries prevention
- protecting the joints from excessive mobility after the injury, which allows for activity continuation
- protection of the areas exposed to abrasions

### FEATURES:

- non-elastic, breathable tape made of cotton
- acrylic coating
- serrated edges - no need for scissors

### AVAILABLE SIZES AND COLOURS:

	YST-2591-W	YST-3891-W	YST-591-W
	2,5cm x 9,1m	3,8cm x 9,1m	5cm x 9,1m



# yellow WRAP

## FOAM UNDERWRAP

### USE:

- skin protection during athletic taping
- ensuring correct base for athletic taping in hairy areas
- protecting from abrasions caused by orthoses or sport equipment

### FEATURES:

- made of polyurethane foam
- porous structure allows for air flow and moisture drainage

### AVAILABLE SIZES AND COLOURS:

	YW-07-S
	7cm x 27m



# yellowFOAM

## FOAM TAPE

### USE:

- ✦ stabilization, protection and fixation of non-adhesive primary dressings put directly on wounds or injured skin
- ✦ protection of the areas exposed to abrasions when the epidermis is undamaged e.g. while wearing new shoes or another equipment

### FEATURES:

- ✦ waterproof tape made of polyethylene foam
- ✦ acrylic coating

### AVAILABLE SIZES AND COLOURS:



# scissors

## FOR SPORTS TAPES

### USE:

- ✦ for cutting sports tapes or other adhesive tapes

### FEATURES:

- ✦ sharp blades ensure precision of the cut
- ✦ covered with teflon preventing the tapes from adhering to the blade
- ✦ ergonomic shape fits perfectly in hand ensuring comfort of using
- ✦ length of the blade: 21 cm

REF number: YC-X



# yellowBOX

## DISPENSER FOR KINESIOTAPES

### USE:

- ✦ storing and transporting of tapes
- ✦ protects from contamination and damage
- ✦ "rolling" core makes it easy to cut the desired length of tape

### FEATURES:

- ✦ made of hard PVC
- ✦ suitable for tapes of 5 cm width

REF number: YB







let us introduce you  
to the new sport line

...AND IT WAS ALL **yellow...**



ANY QUESTIONS?

**Contact us!**

ESPORT@ZARYS.PL  
[www.yellowsport.pl/en/](http://www.yellowsport.pl/en/)





## PROCEDURE SETS

Operating theatre is a specific environment where time is the most valuable factor influencing the success of the operation. It is a place where every minute - or even a second - counts, because it can affect the patient's life. To meet the expectations of medicine, ZARYS introduces operating sets to its offer that meet the highest standards, helping to improve the preparation of the operating theatre before the procedure

### ADVANTAGES of using omegapack operating sets

 <p><b>TIME</b></p> <p>unpacking the set and preparing the operating theatre takes about</p> <p><b>30%</b></p> <p>less time than selecting individual products and improving work at operating block</p> <p><b>REDUCING COST</b></p> 	 <p><b>QUALITY</b></p> <p>properly selected composition of the set according to individual needs for a specific medical procedure in line with the Customer's order</p>
 <p><b>EFFECTIVENESS</b></p> <p>increasing work productivity, so that you can perform more surgical procedures in one day, improvement of work of medical staff</p>	 <p><b>EPIDEMIOLOGICAL SAFETY</b></p> <p>reduced risk of patient infection by minimizing the time of contact of medical staff with devices during the preparation of the theatre and the patient</p>
 <p><b>REDUCTION OF ERRORS</b></p> <p>the complete set contains all disposable medical devices necessary for the surgical operation, which eliminates the possibility of errors during the selection of individual products</p>	<div style="display: flex; justify-content: space-around;"> <div data-bbox="528 1312 1023 1624">  <p><b>ENVIRONMENT</b></p> <p>the amount of generated waste is reduced to a minimum</p> <p><b>- one packaging</b></p> </div> <div data-bbox="1023 1312 1509 1624">  <p><b>SAVING THE STOCKS</b></p> <p>reduced number of supplies, saving space in the warehouse</p> </div> </div>
<div style="display: flex; justify-content: space-between;"> <div data-bbox="528 1624 1023 1809">  <p><b>STANDARDIZATION OF PROCEDURES</b></p> <p>correct and schematic conduct during the procedure,</p> <p><b>one package - one treatment</b></p> </div> <div data-bbox="1023 1624 1509 1809">  <p><b>EASY RECORD KEEPING</b></p> <p>optimization of record keeping - one self-adhesive label with the identification of the used set, instead of each used product separately</p> </div> </div>	 <p><b>WIDE RANGE OF PRODUCTS</b></p> <p>a wide range of medical devices selected individually in accordance with the Customer's preferences</p>

The sets are assembled on the basis of individual requirements and preferences of Customers



Medical devices under the omegapack brand by ZARYS are operating sets containing complete equipment with all disposable products necessary to perform a given medical procedure to which the set is dedicated. The operating set contains carefully selected disposable components, such as:

- surgical drapes, pads
- accessories, e.g. fluid collection bags, tapes
- surgical gowns
- surgical gloves
- covers for equipment
- shoe covers, masks, caps
- gauze balls
- gauze and non-woven swabs
- bandages, dressings
- catheters, urine collection bags
- trays, bowls
- taps, three-way stopcocks
- manifolds, connectors
- infusion sets
- suction sets
- disposable surgical instruments
- injection needles and syringes
- disposable electrosurgical electrodes and accessories
- and many more...

# vitahealth

by ZARYS

vitahealth line of adhesive plasters sets are designed to provide optimum protection in every situation and to satisfy the needs of the most demanding users. They are an indispensable element of everyday life.

**Always with you and your loved ones.**

## NONVIplast

NEW on the market - plaster with scissors

non-woven adhesive plaster for cutting

**Adhesive plaster for cutting is by far the most often chosen form of dressings.**



## FABRIplast

NEW on the market - plaster with scissors

fabric adhesive plaster for cutting





# since 1989...

## We create good solutions

WWW.ZARYS.COM

**ZARYS International Group sp. z o.o. sp.k.**

**Please contact us if you require further details:**

 <b>Area</b>	<b>Speaking Language</b>	<b>Direct Line</b>	<b>Mobile</b>
Baltics, CIS, Central Europe, Finland, Denmark, Spain	English	+48 32 376 08 00	+48 518 130 314
UK, Benelux, France, Sweden, Norway, North America, Australia, Portugal, Central & South America, East Asia	English, French	+48 32 797 05 71	+48 532 085 454
Germany, Balcans, South Europe	English, Spanish	+48 32 376 07 02	+48 531 743 734
Middle East, Africa , Italy	English	+48 32 376 07 06	+48 533 331 695

 Pod Borem 18  
41-808 Zabrze, Poland

 e-mail: [export@zarys.pl](mailto:export@zarys.pl)