

LuxOR® REVALIA™ & NGENUITY® SKU Catalogue



Index



LUXOR® REVALIA™
MICROSCOPE



LUXOR® REVALIA™
UPGRADE KITS



LUXOR® LX3 + LUXOR® REVALIA™
ACCESSORIES



OCULUS BIOM



NGENUITY® 3D
VISUALIZATION SYSTEM



ACCESSORIES



Pictograms Legend

Equipment



LuxOR® REVALIA™



LuxOR® LX3



NGENUITY®



Usage

Reusable /
Sterilizable



Units included in the package

1 - 2 - 3 - 4 - 5 - 6 - 10 - 12 - 20 -
25 - 36 - 100



LUXOR® REVALIA™

UPGRADE KITS

ACCESSORIES

OCULUS BIOM



LuxOR® REVALIA™ Ophthalmic Microscope



Dimensions - Microscope with Stand

- > **Width Across Base:**
 - No greater than 92 cm (36 in)
 - No greater than 83.5 cm (33 in) with casters turned inside base
- > **Height:** No greater than 183 cm (72 inches)
- > **Depth:** No greater than 125 cm (50 in) with the arm folded and overall reach of minimum 125 cm (50 in) from the center of the stand

Weight - Microscope with Stand and Accessories

- > **Unpackaged:** No greater than 304 kg (675 lb)
- > **Packaged:** No greater than 409 kg (900 lb)



8065753150	LuxOR® Revalia™ 175/200 with 10x Binoculars includes:	8065000419	LuxOR® Revalia™ 175/200 with 12.5x Binoculars includes:	
8065753073	LuxOR® Revalia™ 175/200 mm optics	8065753073	LuxOR® Revalia™ 175/200 mm optics	①
8065752566	Wireless Foot Control	8065752566	Wireless Foot Control	①
8065753095	LuxOR® Revalia™ Stand	8065753095	LuxOR® Revalia™ Stand	①
8065752391	Lens, Objective, WD175 and WD200	8065752391	Lens, Objective, WD175 and WD200	①
8065752306	10x Reclinable binoculars (0-215)	8065000324	12.5x Reclinable binoculars (0-215)	①
8065753082	Small parts kits., LED (See page 6 for more information)	8065753082	Small parts kits., LED (See page 6 for more information)	



LED modules are not included in the microscope order. Choose the specific LED module reference [here](#)



LUXOR® REVALIA™



UPGRADE KITS

ACCESSORIES

OCULUS BIOM



LuxOR® REVALIA™ Ophthalmic Microscope

8065753151	LuxOR® Revalia™ QVUE 175 with 10x Binoculars includes:	8065000420	LuxOR® Revalia™ QVUE 175 with 12.5x Binoculars includes:		
8065753072	LuxOR® Revalia™ QVUE 175mm optics	8065753072	LuxOR® Revalia™ QVUE 175mm optics	①	
8065752566	Wireless Foot Control	8065752566	Wireless Foot Control	①	
8065753095	LuxOR® Revalia™ Stand	8065753095	LuxOR® Revalia™ Stand	①	
8065752306	10x Reclinable binoculars (0-215)	8065000324	12.5x Reclinable binoculars (0-215)	②	
8065753082	Small parts kits., LED (See page 6 for more information)	8065753082	Small parts kits., LED (See page 6 for more information)		
8065754030	LuxOR® Revalia™ 175/200 with 10x Binoculars and integrated camera	8065000422	LuxOR® Revalia™ 175/200 with 12.5x Binoculars and integrated camera		
8065753073	LuxOR® Revalia™ QVUE 175/200 mm optics	8065753073	LuxOR® Revalia™ QVUE 175/200 mm optics	①	
8065752566	Wireless Foot Control	8065752566	Wireless Foot Control	①	
8065753095	LuxOR® Revalia™ Stand	8065753095	LuxOR® Revalia™ Stand	①	
8065752306	10x Reclinable binoculars (0-215)	8065000324	12.5x Reclinable binoculars (0-215)	①	
8065752391	Lens, Objective, WD175 and WD200	8065752391	Lens, Objective, WD175 and WD200	①	
8065752906	Integrated 1 MOS Camera Package	8065752906	Integrated 1 MOS Camera Package	①	
8065753082	Small parts kits., LED (See page 6 for more information)	8065753082	Small parts kits., LED (See page 6 for more information)		
8065753062	LuxOR® LX3 Revalia™ QVUE 200 with 10x Binoculars	8065000421	LuxOR® Revalia™ QVUE 200 with 12.5x Binoculars		
8065753071	LuxOR® Revalia™ QVUE 200 mm optics	8065753071	LuxOR® Revalia™ QVUE 200 mm optics	①	
8065752566	Wireless Foot Control	8065752566	Wireless Foot Control	①	
8065753095	LuxOR® Revalia™ Stand	8065753095	LuxOR® Revalia™ Stand	①	
8065752306	10x Reclinable binoculars (0-215)	8065000324	12.5x Reclinable binoculars (0-215)	①	
8065753082	Small parts kits., LED (See page 6 for more information)	8065753082	Small parts kits., LED (See page 6 for more information)		

LED modules are not included in the microscope order.
Choose the specific LED module reference [here](#)



LUXOR® REVALIA™

UPGRADE KITS

ACCESSORIES

OCULUS BIOM



LuxOR® REVALIA™ Ophthalmic Microscope

> Small parts kits

	LuxOR® Revalia™ small parts kit includes:		
Small parts kit are included in the microscope (see page 2 and 3)	KNOB, COVER, SMALL	2x	
	KNOB, COVER, LARGE	3	
	KNOB COVERS ENHANCED	6	

Small Parts Kit, LuxOR® Revalia™ Configuration Standard

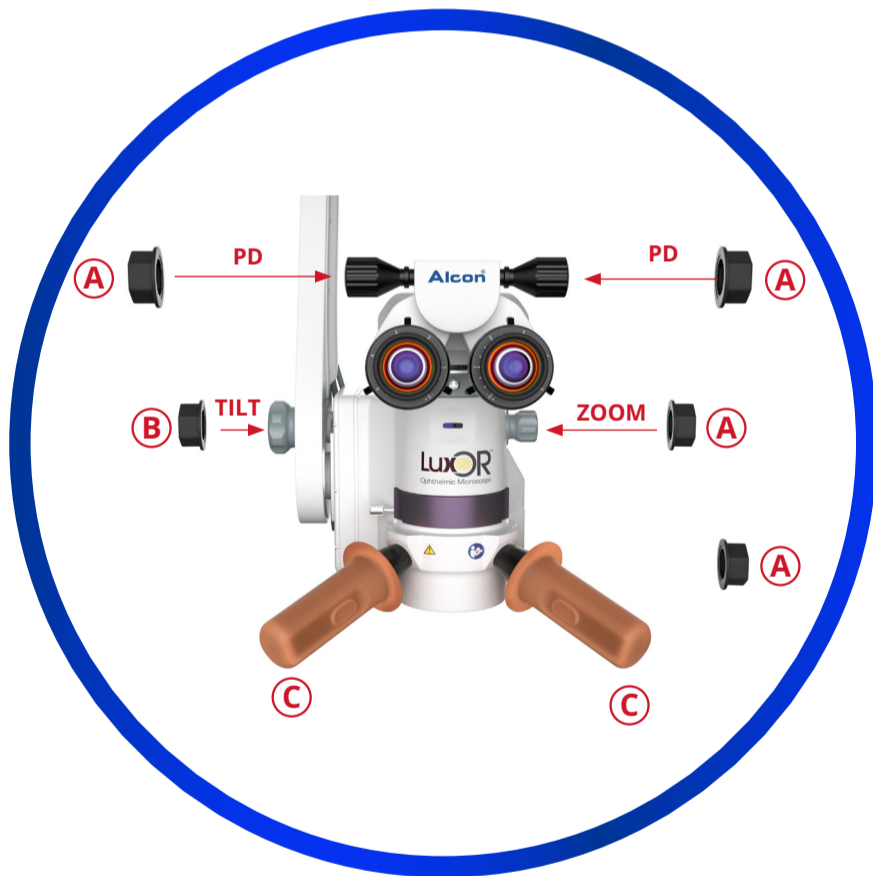

Small Parts Kit, LuxOR® Revalia™ Configuration Q-Vue



- (A)** 8065752311 - KNOB, COVER, SMALL
- (B)** 8065752312 - KNOB, COVER, LARGE
- (C)** 8065753021 - KNOB COVERS ENHANCED



LUXOR® REVALIA™

UPGRADE KITS

ACCESSORIES

OCULUS BIOM



LuxOR® REVALIA™ Accessories



8065752566



8065752311



8065752312

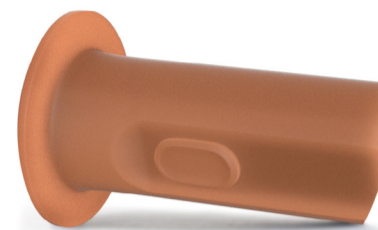

8065753021

> LED modules

8065753085	LED Module Cool White	1	REVALIA
8065753086	LED Module Mixed White	1	REVALIA
8065753084	LED Module Warm White	1	REVALIA
8065754031	LuxOR® 3 LED Module pack:	1	REVALIA
8065753085	LED Module Cool White		
8065753086	LED Module Mixed White		
8065753084	LED Module Warm White		

> Knob covers

8065753077	Complete LuxOR® Revalia™ Knob Cover Kit:*	4 1 6	2	REVALIA
	Knob Cover, Small			
	Knob Cover, Large			
	Enhanced Orange Knob Cover			
8065753079	Complete LuxOR® Revalia™ QVUE Knob Cover Kit:*	9 1 6	2	REVALIA
	Knob cover, Small			
	Knob cover, Large			
	Enhanced Orange Knob Cover			
8065753021	Enhanced Orange Knob set	6	2	REVALIA
8065752311	Knob cover, Small	1	2	REVALIA
8065752312	Knob cover, Large	1	2	REVALIA

> Foot control

8065752566	Wireless foot control	1	REVALIA & LX3
8065752337	Cable for pedal charger LuxOR®	1	REVALIA & LX3

* Compatible with Revalia™ and Enhanced LX3 Microscopes. Knob sets provide all covers necessary for 3 procedures under a single catalogue number.



LUXOR® REVALIA™

UPGRADE KITS

ACCESSORIES

OCULUS BIOM



Upgrade kits

HANDLES



Original LX3 Knobs



LuxOR® REVALIA™ and Enhanced LX3 knobs



Open & Close LED Carrying case



LED upgrade kits non-enh LX3



LuxOR® REVALIA™ branded skins (plastic covers that attach on LuxOR® REVALIA™ stand)



LED upgrade kits non-enh LX3

8065753154 Non-Enh to LED Upgrade Kit:

8065753092	LED upgrade kits non-enh LX3	①
8065753096	Upgrade kit libero LED	①
8065752564	Handles set, LuxOR® Upgrade kit	②
8065753021	Knob Covers Enh	⑥
8065753094	LED Ops Manual	①
8065754022	LED carrying case	①
8065000005	LuxOR® REVALIA™ branded skin	①

8065753153 Enhanced to LED Upgrade Kit:

8065753092	LED upgrade kits non-enh LX3	①
8065753096	Upgrade kit libero LED	①
8065753094	LED Ops Manual	①
8065754022	LED carrying case	①
8065000005	LuxOR® REVALIA™ branded skin	①

LED modules are not included in the microscope order. Choose the specific LED module reference [here](#)

The LuxOR® Revalia™ Upgrade Kits do not include the fine focus upgrade for QVUE microscopes. In case of requiring a fine focus upgrade, utilize 8065752988 for Q-VUE™ 175 mm and 8065753020 for Q-VUE™ 200mm.



LUXOR® REVALIA™

UPGRADE KITS

ACCESSORIES

OCULUS BIOM



Accessories Co-observation



› Assistant co-observation and beam splitters

8065752296	Complete Binocular Assitant Kit, includes 50/50 Beam splitter, Co-Observation Tube and Straight Binoculars	①	REVALIA & LX3
8065752306	Reclinining 10x Binocular	①	REVALIA & LX3
8065000324	Reclinining 12.5x Binocular	①	REVALIA & LX3
8065000427	Ergo Binoculars 10x	①	REVALIA & LX3
8065000428	Ergo Binoculars 12.5x	①	REVALIA & LX3
8065752315	Binocular Co-Observation Tube	①	REVALIA & LX3
8065752314	Beam splitter, 80/20	①	REVALIA & LX3
8065752317	Beam splitter, 50/50	①	REVALIA & LX3



Accessories

Video and Laser Filters



8065752318



8065752391

> Video recording

8065751495	Video Overlay HD	①	REVALIA & LX3
8065752318	Video Adapter, PRO, F=50 mm SD	①	REVALIA & LX3
8065752387	Video Adapter, PRO, F=50 mm HD	①	REVALIA & LX3
8065752906	1 MOS Integrated camera, elbow, 80/20 beam splitter and integration kit	①	REVALIA & LX3
8065752907	3 MOS Integrated camera, elbow, 80/20 beam splitter and integration kit	①	REVALIA & LX3

> Laser filters

8065750448	Active Laser filter (532 nm)	①	REVALIA & LX3
8065751051	Passive Laser filter (532 nm)	①	REVALIA & LX3



LUXOR® REVALIA™

UPGRADE KITS

ACCESSORIES

OCULUS BIOM



Accessories LuxOR® LX3



8065752308

> Optical Head

8065752304	Optical head kit	1	LX3
8065752321	Accessories kit	1	LX3
8065752323	Optical head kit 200 mm LuxOR®	1	LX3
8065752332	Optical head kit 175 mm LuxOR® Q-Vue®	1	LX3
8065752333	Optical head kit 200 mm LuxOR® Q-Vue®	1	LX3
8065752308	12V 100W Halogen bulb w/Cartridge	1	LX3

> Knob covers

Complete LuxOR® LX3 Knob Cover kit**			2	
8065752311	Knob cover, Small	4	LX3	
8065752312	Knob cover, Large	1		
8065752563	Non-enhanced Orange Knob Cover	6		
Complete LuxOR® LX3 QVUE Knob Cover kit**			2	
8065752311	Knob cover, Small	4	LX3	
8065752312	Knob cover, Large	1		
8065752563	Non-enhanced Orange Knob Cover	6		

** Compatible with original LX3 Microscopes. Knob sets provide all covers necessary for 3 procedures under a single catalogue number.



LUXOR® REVALIA™

UPGRADE KITS

ACCESSORIES

OCULUS BIOM



Accessories OCULUS BIOM

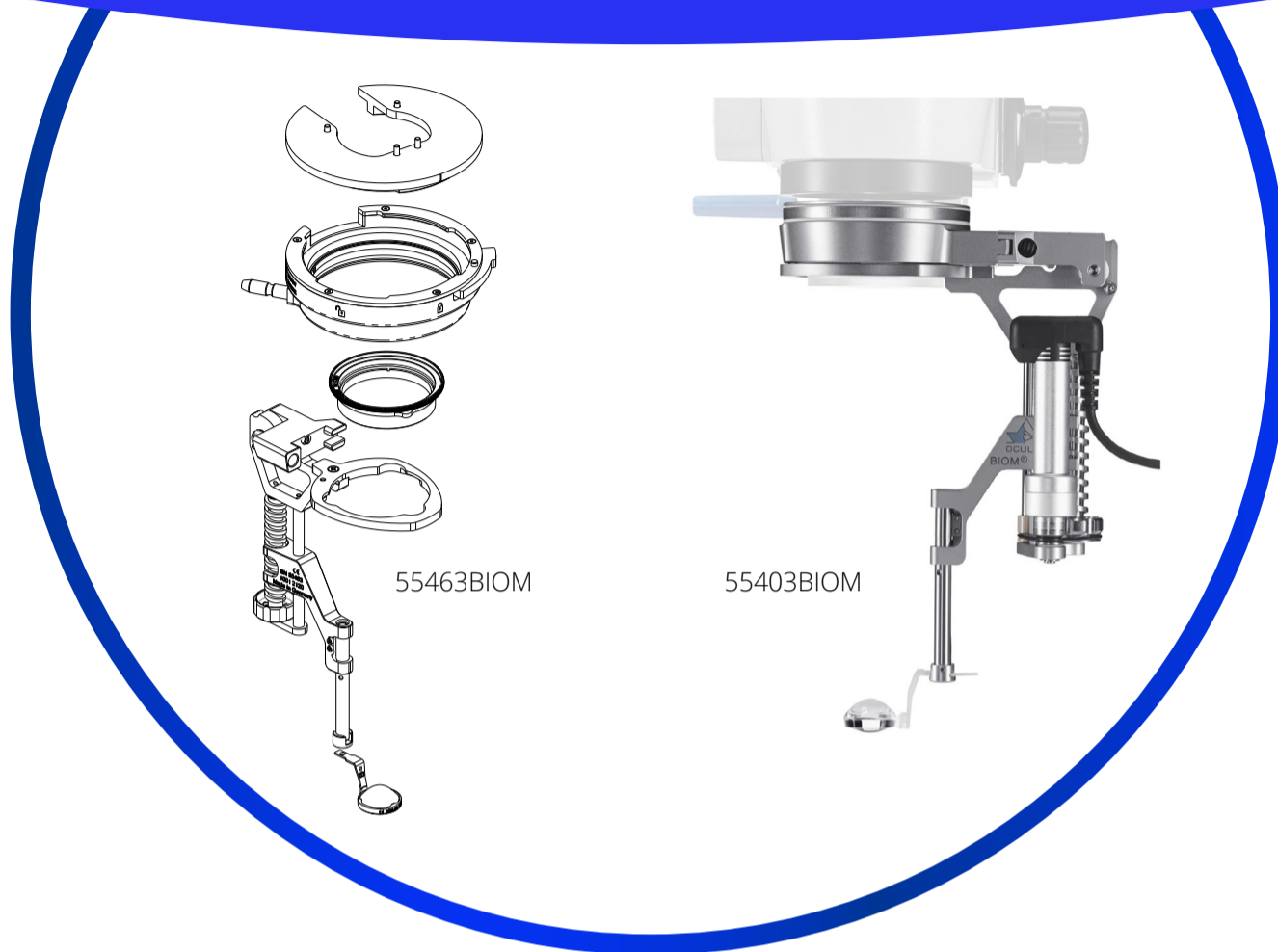

> Wide Angle Viewing System (BIOM)

55429	Adapter plate for Oculus BIOM5/BIOM Ready AND LuxOR® Revalia™	①	REVALIA
55462BIOM	BIOM® 5m, mechanically focused	①	REVALIA & LX3
55463BIOM	BIOM® 5ml, long version, mechanically focused	①	REVALIA & LX3
55400BIOM	BIOM® 5c, motorized focus	①	REVALIA & LX3
55403BIOM	BIOM® 5cl, long version, motorized focus	①	REVALIA & LX3
54841	BIOM® connecting spacer for Zeiss type microscope - Required to be able to drive the BIOM® through the Revalia™ without the SDI inverter	①	REVALIA & LX3



LUXOR® REVALIA™

UPGRADE KITS

ACCESSORIES

OCULUS BIOM



Accessories OCULUS BIOM



54300I

> Inverter (SDI)

54302SDI	SDI® 4m, Stereo Diagonal Inverter, mechanically switched	①	REVALIA & LX3
54300I	SDI® 4e, Stereo Diagonal Inverter, electrically switched	①	REVALIA & LX3
54320SDI	SDI® 4c, Stereo Diagonal Inverter, electrically focused, for motorized focus of BIOM® 5c	①	REVALIA & LX3



LUXOR® REVALIA™

UPGRADE KITS

ACCESSORIES

OCULUS BIOM



Accessories OCULUS BIOM



53602

53603

53604

53606

> Surgical ophthalmoscopy lenses for BIOM® 5

53602	WFE lens for BIOM® 3/4/5	①	②	REVALIA & LX3
53603	WiFi HD lens for BIOM® 3/4/5	①	②	REVALIA & LX3
53604	90D lens for BIOM® 3/4/5	①	②	REVALIA & LX3
53606	HiRes lens for BIOM® 3/4/5	①	②	REVALIA & LX3



LUXOR® REVALIA™

UPGRADE KITS

ACCESSORIES

OCULUS BIOM



Accessories OCULUS BIOM



55404BIOM



54580BIOM

> Reduction lenses

55401BIOM	Reduction lens for BIOM® 5m/5c for f = 175 mm	①	②	REVALIA & LX3
55404BIOM	Reduction lens for BIOM® 5ml/5cl for f = 200 mm	①	②	REVALIA & LX3

> Accessories

54580BIOM	Sterilizable rubber cap for knurled screw	⑤	②	REVALIA & LX3
54335SDI	Sterilizable rubber cap for SDI® 4	⑤	②	REVALIA & LX3



LUXOR® REVALIA™

UPGRADE KITS

ACCESSORIES

OCULUS BIOM



Accessories OCULUS BIOM



55180BIOM

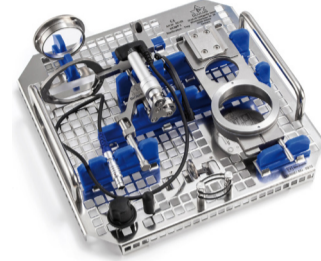

55185BIOM



55423BIOM

55180BIOM	Sterilization container incl. Sterilization inset for 1 set of BIOM® 5	①	②	REVALIA & LX3
55185BIOM	Inset for sterilization container for 1 set of BIOM® 5	①	②	REVALIA & LX3
55190BIOM	Single use paper filters for sterilization container	①00	②	REVALIA & LX3
8065752357	Support de fixation BIOM® pour LuxOR® (déjà fourni avec le Q-vue®)	①	②	REVALIA & LX3
55423BIOM	Adapter plate for BIOM® 5/BIOM® ready for LuxOR® LX3	①	②	REVALIA & LX3
54406BIOM	Adapter plug for use of BIOM® c/cl with SDI® 3c	①	②	REVALIA & LX3



Accessories OCULUS BIOM



54176BIOM



54178BIOM

> Accessories

54405BIOM	Motor unit for BIOM® 5c/cl, exchange part	①	②	REVALIA & LX3
54176BIOM	Drive belt for BIOM® c/cl	⑩	②	REVALIA & LX3
54178BIOM	Cable support for BIOM® c/cl,	⑤	②	REVALIA & LX3
54878	Dual switch adapter for two SDI® 4c	①	②	REVALIA & LX3
54881	Combination foot switch for SDI® c/ BIOM® c/cl	①	②	REVALIA & LX3
54883SDI	Foot switch for SDI® 4e	①	②	REVALIA & LX3
54885	Extension cable to SDI® e/c foot switch	①	②	REVALIA & LX3
54889	2-pin to 5-pin adapter	①	②	REVALIA & LX3
54898	Extension cable for voltage power supply plug, for SDI® e/c, 3-pin, cable length approx. 5 m	①	②	REVALIA & LX3



LUXOR® REVALIA™

UPGRADE KITS

ACCESSORIES

OCULUS BIOM



NGENUITY® 3D Visualization System



> NGENUITY® 3D Visualization System

8065000113	NGENUITY® 1.4 version 3D Visualization System with DATAFUSION™	①
8065000399	NGENUITY® 1.5 version 3D Visualization System with DATAFUSION™	①

NGENUITY® 3D Visualization System BOM Components:

- > Medical Grade Console
 - > Gen5 3D Surgical Camera
 - > Wireless Keyboard
 - > Wired Keyboard
 - > 55 in 3D 4K Display
 - > Screen Protector
 - > Glidepoint 4 Button Touchpad
 - > White Balance Card (Qty 3)
 - > 3D Glasses - Clip on (Qty 2)
 - > 3D Glasses - Standard (Qty 10)
 - > 3D Glasses - Premium (Qty 2)
 - > USB Cord Extension for Keyboard
 - > NGENUITY® Operators Manual
 - > Display and required cables
 - > Display remote
 - > Misc Assesory Kit:
 - Leica microscope ring
 - Leica microscope thumb screw (Qty:1)
 - Target Fabric (colors, texture, etc.)
 - Power Cable (United States)
 - Quick Start Guide
- Not included: Wireless Adapter, In country Power Adapter

Accessories



> NGENUITY® Accessories and replacement parts

8065830003	NGENUITY® Gen5 3D Surgical Camera	①
8065830004	NGENUITY® Wired Keyboard	①
8065830006	NGENUITY® Screen Protector	①
8065830007	NGENUITY® Glidepoint 4 Button Touch Pad	①
8065830008	NGENUITY® White Balance Card	①
8065830009	NGENUITY® 3D Glasses - Clip On	①
8065830010	NGENUITY® 3D Glasses - Standard	①
8065830011	NGENUITY® 3D Glasses - Premium	①
8065830012	NGENUITY® Hard Drive (2TB) - External	①
8065830014	NGENUITY® USB Extension Cord for Keyboard	①
8065830017	NGENUITY® Wireless Keyboard	①

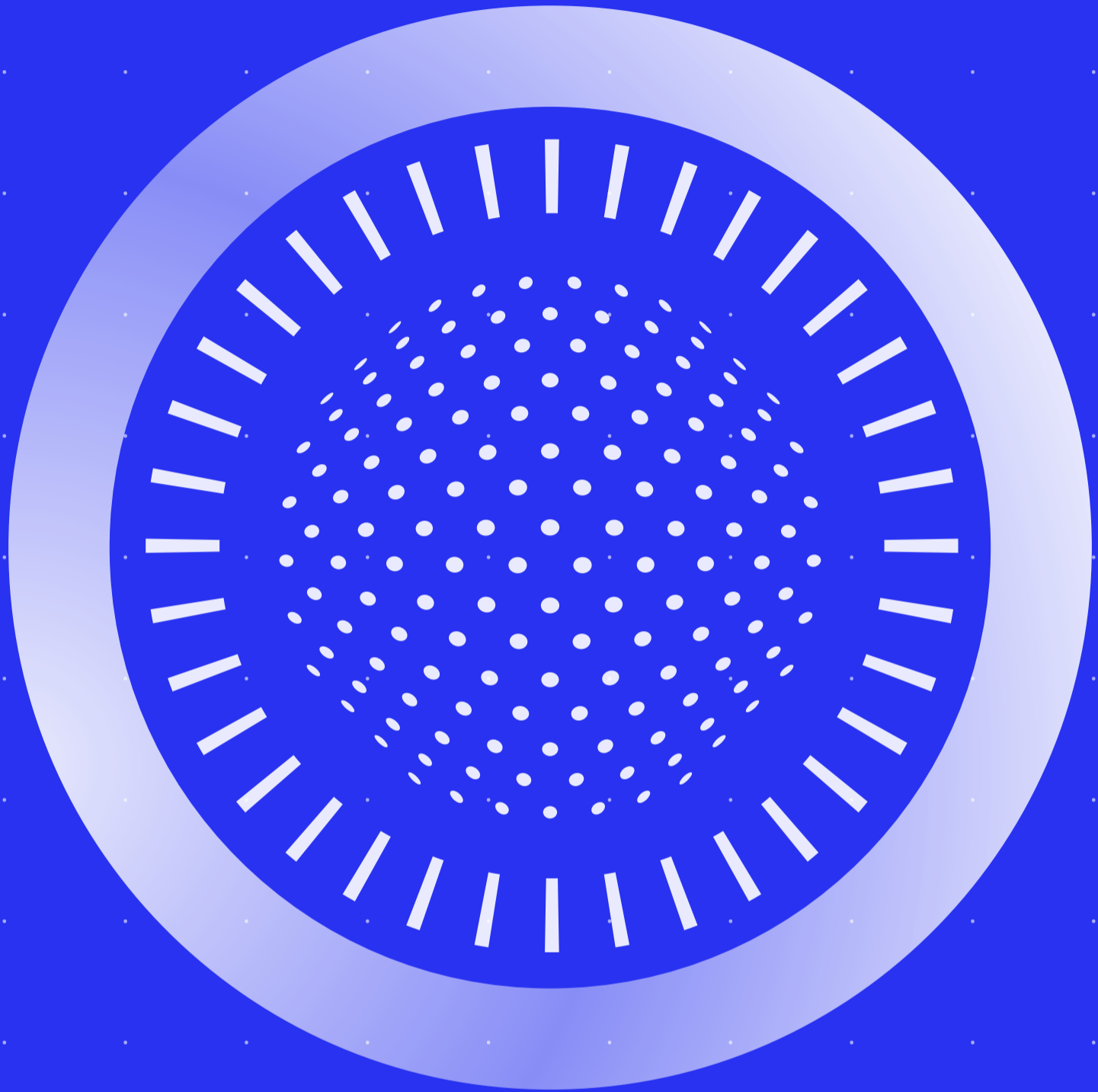

Alcon Vision Suite

www.alcon.com

Medical Devices manufactured by Alcon comply with all applicable laws and regulations.
For indications, contraindications and warnings please refer to the relevant product's instructions for use.

©2024 Alcon Inc. 05/24 IMG-LUX-2400003