

ALLGEMEINCHIRURGIE  
GENERAL SURGERY  
CIRUGÍA GENERAL  
CHIRURGIA GENERALE



**Reda** Instrumente GmbH  
Gänsäcker 34 · P.O. Box 131  
D-78532 Tuttlingen

Telefon +49 / 74 62 / 94 45-0  
Telefax +49 / 74 62 / 94 45-20  
E-mail: [info@Reda-Instrumente.de](mailto:info@Reda-Instrumente.de)  
<http://www.Reda-Instrumente.de>

Ausgabe Nr. 8  
Datum: 06/2022



Charrière (Ch) French (F)	Durchmesser in mm	Inches
1	0,33	0,013
2	0,67	0,025
3	1,00	0,039
4	1,33	0,051
5	1,67	0,065
6	2,00	0,0787
7	2,33	0,092
8	2,67	0,105
9	3,00	0,1181
10	3,33	0,131
11	3,67	0,144
12	4,00	0,1575
13	4,33	0,170
14	4,67	0,184
15	5,00	0,1968
16	5,33	0,210
17	5,67	0,223
18	6,00	0,2362
19	6,33	0,249
20	6,67	0,263
21	7,00	0,2756
22	7,33	0,288
23	7,67	0,302
24	8,00	0,3150
25	8,33	0,328
26	8,67	0,341
27	9,00	0,3543
28	9,33	0,367
29	9,67	0,380
30	10,00	0,3973
31	10,33	0,407
32	10,67	0,420
34	11,33	0,446
36	12,00	0,4724
38	12,67	0,494
40	13,33	0,5199
45	15,00	0,5905

Gauge (G)	Durchmesser in mm	Inches
35	0,13	0,005
34	0,18	0,007
33	0,20	0,008
32	0,23	0,009
31	0,25	0,010
30	0,30	0,012
29	0,33	0,013
28	0,36	0,014
27	0,41	0,016
26	0,46	0,018
25	0,51	0,020
	0,53	0,021
24	0,56	0,022
23	0,64	0,025
22	0,71	0,028
21	0,81	0,032
20	0,89	0,035
	0,97	0,038
19	1,07	0,042
18	1,27	0,050
17	1,50	0,059
16	1,65	0,065
15	1,83	0,072
14	2,11	0,083
13	2,41	0,095
12	2,77	0,109
11	3,05	0,120
10	3,40	0,134
9	3,76	0,148
8	4,19	0,165
7	4,57	0,180
6	5,16	0,203

1 OZ	0,028 ml
5 OZ	0,140 ml
16 OZ	0,450 ml

35 OZ	1,0 l
128 OZ	3,7 l



---

## GARANTIE / WARRANTY / GARANTIA / GARANZIA

### GARANTIE

Wir gewähren auf alle **Reda**-Instrumente 5 Jahre Garantie. Voraussetzung ist der sach- und fachgerechte Einsatz der Instrumente. Von der Garantie sind Verschleißerscheinungen ausgeschlossen.

---

### WARRANTY

Our **Reda** products are free from manufacturing defects in material and workmanship. We therefore give on all instruments a guarantee of five years provided that the instruments are maintained and cleaned properly and used normally for their intended purpose.

---

### GARANTIA

Estamos convencidos de nuestra calidad y concedemos a todos los instrumentos de **Reda** 5 años de garantía contra cualquier defecto de fabricación, siempre y cuando se usen adecuadamente. De la garantía excluimos la manifestación de desgaste.

---

### GARANZIA

Siamo convinti della nostra qualità e concediamo cinque anni di garanzia sulla funzione dei tutti gli strumenti **Reda** sotto la presupposizione che l'utilizzo è da esperto. Escluso della garanzia sono tracce di consumo.

Kathetereinführzangen, Saugrohre  
 Catheter Introducing Forceps, Suction tubes  
 Pinzas para catéteres, Tubos de aspiración  
 Pinze per introdurre le sonde, Cannule per aspirazione

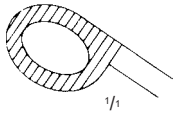

05190-25  
 25 cm, 10"

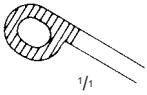

05190-20  
 20 cm, 8"



05190-17  
 17 cm, 6 3/4"

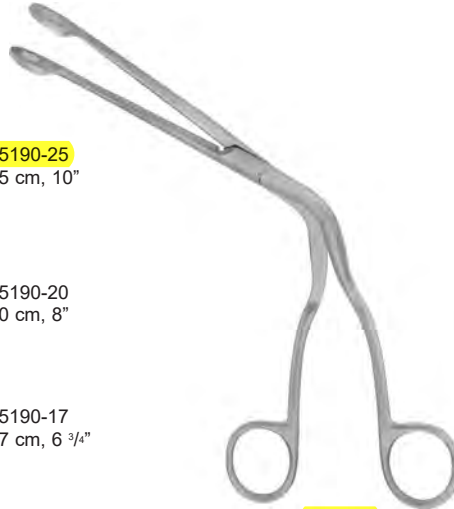

MAGILL



ANDREW-PYNCHON  
 05170-24  
 6 mm  $\varnothing$ , 1/2"  
 24 cm, 9 1/2"



COOLEY  
 05160-02  
 8 mm  $\varnothing$ , 0.3"  
 36 cm, 14 1/4"



COOLEY  
 05160-03  
 8 mm  $\varnothing$ , 0.3"  
 30 cm, 11 3/4"



DE BAKEY  
 05160-04  
 3 mm  $\varnothing$ , 0.1"  
 27 cm, 10 1/2"

$\varnothing$  15 mm



$\varnothing$  9 - 13 mm

FINSTERER  
 05180-32  
 32 cm, 12 3/4"

Chirurgische Scheren  
 Operating Scissors  
 Tijeras para cirugía  
 Forbici per chirurgia



STANDARD  
 09102-11 11,5 cm, 4½"  
 09102-13 13,0 cm, 5"  
 09102-14 14,5 cm, 5¾"  
**09104-14 TC**  
 09102-15 15,5 cm, 6"  
 09102-16 16,5 cm, 6½"  
 09102-18 18,5 cm, 7¼"  
 09102-20 20,0 cm, 8"



STANDARD  
 09110-11 11,5 cm, 4½"  
 09110-13 13,0 cm, 5"  
**09110-14 14,5 cm, 5¾"**  
**09114-14 TC**  
 09110-15 15,5 cm, 6"  
 09110-16 16,5 cm, 6½"  
**09110-18 18,5 cm, 7¼"**  
 09110-20 20,0 cm, 8"



STANDARD  
 09120-11 11,5 cm, 4½"  
 09120-13 13,0 cm, 5"  
 09120-14 14,5 cm, 5¾"  
**09124-14 TC**  
 09120-15 15,5 cm, 6"  
 09120-16 16,5 cm, 6½"  
 09120-18 18,5 cm, 7¼"  
**09120-20 20,0 cm, 8"**



STANDARD  
 09103-11 11,5 cm, 4½"  
 09103-13 13,0 cm, 5"  
 09103-14 14,5 cm, 5¾"  
**09105-14 TC**  
 09103-15 15,5 cm, 6"  
 09103-16 16,5 cm, 6½"  
 09103-18 18,5 cm, 7¼"  
 09103-20 20,0 cm, 8"



STANDARD  
 09111-11 11,5 cm, 4½"  
 09111-13 13,0 cm, 5"  
 09111-14 14,5 cm, 5¾"  
**09115-14 TC**  
 09111-15 15,5 cm, 6"  
 09111-16 16,5 cm, 6½"  
 09111-18 18,5 cm, 7¼"  
 09111-20 20,0 cm, 8"



STANDARD  
 09121-11 11,5 cm, 4½"  
 09121-13 13,0 cm, 5"  
 09121-14 14,5 cm, 5¾"  
**09125-14 TC**  
 09121-15 15,5 cm, 6"  
 09121-16 16,5 cm, 6½"  
 09121-18 18,5 cm, 7¼"  
 09121-20 20,0 cm, 8"

Präparierscheren  
 Dissecting Scissors  
 Tijeras de disección  
 Forbici per dissezione

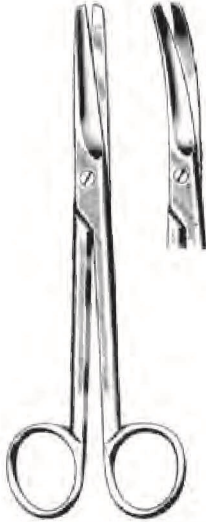

		<b>MAYO</b>		
09160-14	14,5 cm, 5¾"	09161-14		
09164-14	14,5 cm, 5¾"	09165-14		
09164-14 TC	14,5 cm, 5¾"	09165-14 TC		
09160-15	15,0 cm, 6"	09161-15		
09160-17	17,0 cm, 6¾"	09161-17		
09164-17	17,0 cm, 6¾"	09165-17		
09164-17 TC	17,0 cm, 6¾"	09165-17 TC		
09160-19	19,0 cm, 7½"	09161-19		
09160-23	23,0 cm, 9"	09161-23		
09164-23	23,0 cm, 9"	09165-23		
09164-23 TC	23,0 cm, 9"	09165-23 TC		
09160-28	28,0 cm, 11"	09161-28		



		<b>MAYO-STILLE</b>		
09170-15	15,0 cm, 6"	09171-15		
09174-15	15,0 cm, 6"	09175-15		
09174-15 TC	15,0 cm, 6"	09175-15 TC		
09170-17	17,0 cm, 6¾"	09171-17		
09174-17	17,0 cm, 6¾"	09175-17		
09174-17 TC	17,0 cm, 6¾"	09175-17 TC		
09170-21	21,0 cm, 8¼"	09171-21		
09174-21	21,0 cm, 8¼"	09175-21		
09174-21 TC	21,0 cm, 8¼"	09175-21 TC		



		<b>MAYO-NOBLE</b>		
09180-17	17,0 cm, 6¾"	09181-17		

Präparierscheren  
Dissecting Scissors  
Tijeras de disección  
Forbici per dissezione



METZENBAUM	
09280-12	09284-12 TC
12 cm, 4¾"	
09280-15	09284-15 TC
15 cm, 6"	
09280-18	09284-18 TC
18 cm, 7"	
09280-20	09284-20 TC
20 cm, 8"	
09280-23	09284-23 TC
23 cm, 9"	
09280-25	09284-25 TC
25 cm, 10"	
09280-28	09284-28 TC
28 cm, 11"	
09280-30	09284-30 TC
30 cm, 12"	



METZENBAUM	
09281-12	09285-12 TC
12 cm, 4¾"	
09281-15	09285-15 TC
15 cm, 6"	
09281-18	09285-18 TC
18 cm, 7"	
09281-20	09285-20 TC
20 cm, 8"	
09281-23	09285-23 TC
23 cm, 9"	
09281-25	09285-25 TC
25 cm, 10"	
09281-28	09285-28 TC
28 cm, 11"	
09281-30	09285-30 TC
30 cm, 12"	



METZENBAUM FINO	
09282-15	09286-15 TC
15 cm, 6"	
09282-18	09286-18 TC
18 cm, 7"	
09282-20	09286-20 TC
20 cm, 8"	
09282-23	09286-23 TC
23 cm, 9"	
09282-25	09286-25 TC
25 cm, 10"	
09282-28	09286-28 TC
28 cm, 11"	



METZENBAUM FINO	
09283-15	09287-15 TC
15 cm, 6"	
09283-18	09287-18 TC
18 cm, 7"	
09283-20	09287-20 TC
20 cm, 8"	
09283-23	09287-23 TC
23 cm, 9"	
09283-25	09287-25 TC
25 cm, 10"	
09283-28	09287-28 TC
28 cm, 11"	

Präparierscheren  
Dissecting Scissors  
Tijeras de disección  
Forbici per dissezione

**NOIR**

Wellenschliff  
**Wave cut**  
Corte de onda  
Taglio a onda

**METZENBAUM**

09285-15W  
14,5 cm, 5¾"



**09285-18W**  
**18 cm, 7"**



09285-20W  
20 cm, 8"

Chirurgische Scheren, fein  
 Operating Scissors, fine  
 Tijeras para cirugía, finas  
 Forbici per chirurgia, fine



IRIS



09340-09 9 cm 09341-09

09340-10 10 cm 09341-10

09340-11 11 cm 09341-11

09344-11 TC

09345-11 TC

gerade  
 straight  
 rectas  
 rette

gebogen  
 curved  
 curvas  
 curve

abgewinkelt  
 angled  
 angulada  
 angolata

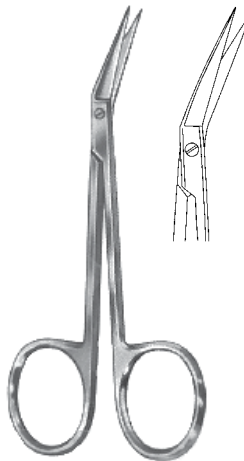

IRIS  
 09346-11  
 11 cm, 4 $\frac{3}{8}$ "

Tonsillen-, Gefäßscheren  
**Tonsil**, Vascular Scissors  
 Tijeras amígdalas y vasculares  
 Forbici per tonsilli e vascolari



COTTLE  
 09405-16  
**09406-16 TC**  
 16 cm, 6¼"

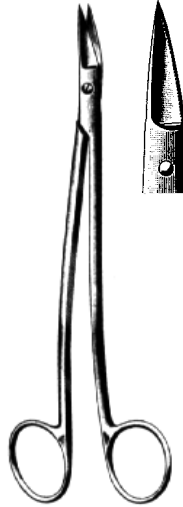

DEAN  
 09425-17 09427-17  
 17 cm, 6¾"

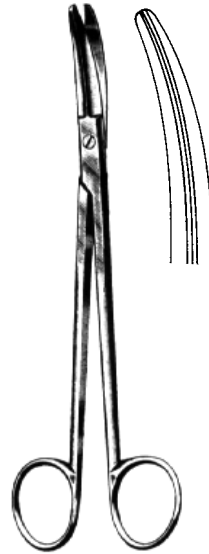

**BOETTCHER**  
 09435-18  
 18 cm, 7"

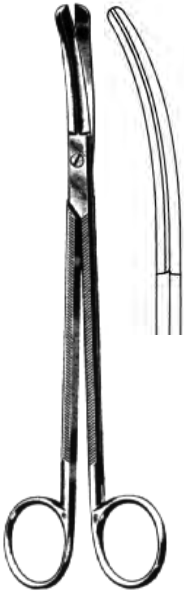

GOOD  
 09437-19  
 19 cm, 7½"

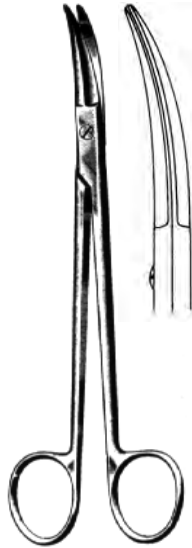

PRINCE  
 09439-17  
 17 cm, 6¾"



09470-11  
 11 cm, 4¾"

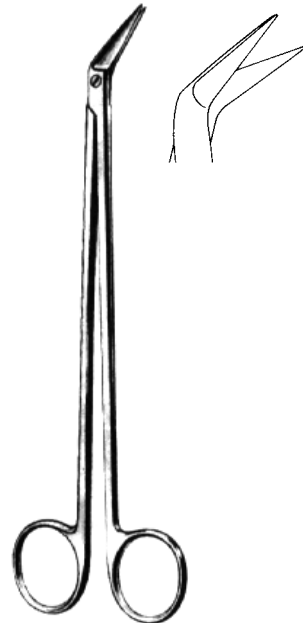

POTTS-DE MARTEL  
 09473-21  
 21 cm, 8¼"

Gefäßscheren  
 Vascular Scissors  
 Tijeras vasculares  
 Forbici vascolari

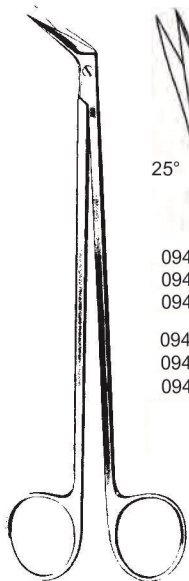

**POTTS-SMITH**  
 19 cm, 7½"

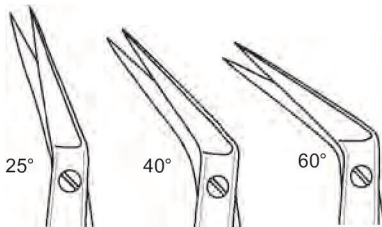

- |             |             |                    |
|-------------|-------------|--------------------|
| 09480-25    | 09480-40    | 09480-60           |
| 09480-25 TC | 09480-40 TC | 09480-60 TC        |
| 09480-25 SC | 09480-40 SC | <u>09480-60 SC</u> |
| 09481-25    | 09481-40    | 09481-60           |
| 09481-25 TC | 09481-40 TC | 09481-60 TC        |
| 09481-25 SC | 09481-40 SC | 09481-60 SC        |

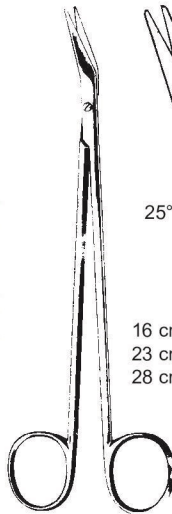

DE BAKEY

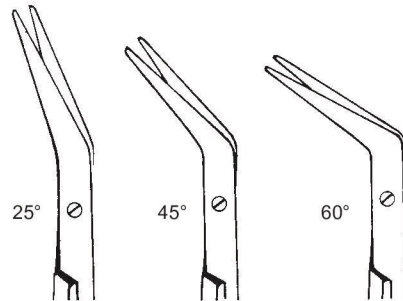

- |       |          |          |          |
|-------|----------|----------|----------|
| 16 cm | 09490-16 | 09491-16 | 09492-16 |
| 23 cm | 09490-23 | 09491-23 | 09492-23 |
| 28 cm | 09490-28 | 09491-28 | 09492-28 |

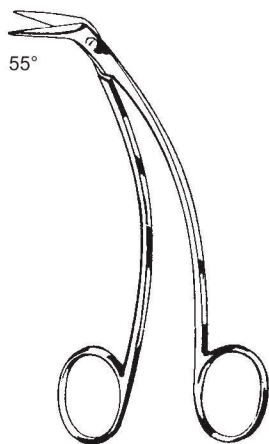

**FAVALORO**  
 09496-15 15 cm, 6"

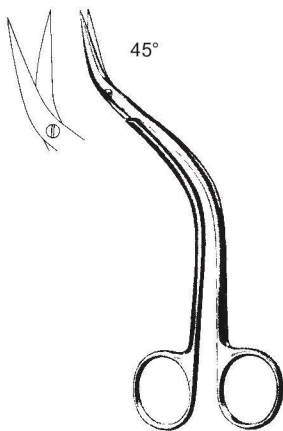

**DE BAKEY**  
 09497-15 15,5 cm, 6"



**KELLY**  
 09540-16 09541-16  
09542-16 TC 09543-16 TC  
 16 cm, 6¼"

Knorpelscheren, Nasenschere, Gefäßscheren  
 Cartilage Scissors, Nasel Scissors, Vascular Scissors  
 Tijeras para cartilago, Tijeras nasales, Tijeras vasculares  
 Forbici per cartilagine, Forbici nasali, Forbici vascolari



gezahnt  
 saw edge  
 dentadas  
 dentellata

MARTIN  
 09613-20  
 18 cm, 7"



McINDOE  
 09614-19  
 19 cm, 7½"



FOMON  
 09617-13  
 13 cm, 5½"



SCHMIEDEN-TAYLOR  
 09619-17  
 17 cm, 6¾"

Darmscheren, Nagelspaltschere, Fadenscheren

**Enterotomy Scissors,** Nail Splitting Scissors, Stitch Scissors

Tijeras para intestino, Tijeras para hender uña, Tijeras para hilos

Forbici per enterotomia, Forbici per staccare unghie, Forbici per legature



FERGUSSON  
09770-18  
18 cm, 7"

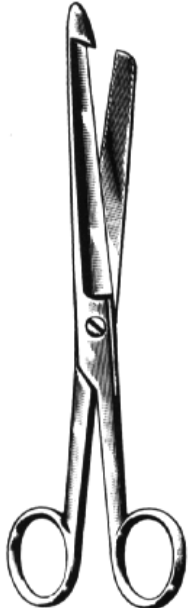

**09772-21**  
21 cm, 8¼"



09774-21  
21 cm, 8¼"

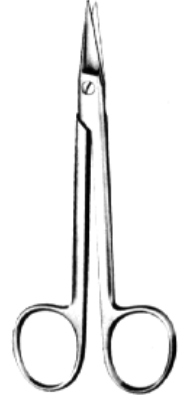

— SYSTRUNK —  
09775-13 09777-13  
13 cm, 5½"



SPENCER  
09802-09  
9 cm, 3½"



SPENCER  
09802-11  
11 cm, 4¾"



NORTHBENT  
09803-09 9 cm, 3½"  
09803-13 13 cm, 5½"



LITTAUER  
09804-14  
14 cm, 5½"



HEATH  
09809-15  
15 cm, 6"

Verbandscheren, Gipsschere  
 Bandage Scissors, Plaster Scissors  
 Tijeras para vendajes, Tijeras para yeso  
 Forbici per bendaggi, Forbici per gesso

Gaze  
 Gauze  
 Gaza  
 Garza



SMITH US ARMY  
 09898-20  
 18 cm, 7"



LISTER  
 9 cm, 3½" 09901-09  
 11 cm, 4¾" 09901-11  
 14 cm, 5½" 09901-14 09905-14 TC  
 18 cm, 7" 09901-18 09905-18 TC  
 18 cm, 7" 09901-20



LISTER  
 09906-18 18 cm, 7"  
 09906-20 18 cm, 7"



BERGMANN  
 09911-23  
 23 cm, 9"

Ultra-Light-Pinzetten

Ultra-Light-Forceps

Pinzas-Ultra-Ligera

Pinza-ultra-leggera

1,5 mm



1,5 mm



1,5 mm



1,2 mm

 $1/1$ 12110-15  
15 cm, 6" $1/1$ 12110-20  
20 cm, 8" $1/1$ 12110-24  
24 cm, 9½" $1/1$ 12110-30  
30 cm, 11¼"

Atraumatische Pinzetten  
Atraumatic Tissue Forceps  
Pinzas atraumáticas  
Pinze atraumatiche



DE BAKEY  
12302-16 16 cm, 6¼"  
12302-20 18 cm, 7"  
12302-24 24 cm, 9½"



DE BAKEY  
12306-16 16 cm, 6¼"  
12306-20 18 cm, 7"  
12306-24 24 cm, 9½"  
12306-30 30 cm, 11¼"



DE BAKEY  
12308-16 16 cm, 6¼"  
12308-20 18 cm, 7"  
12308-24 24 cm, 9½"  
12308-30 30 cm, 11¼"

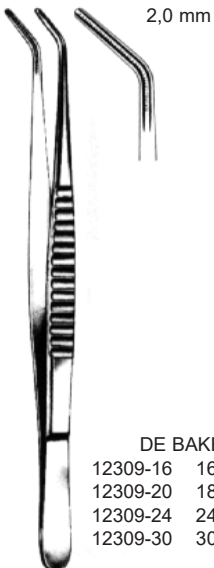

DE BAKEY  
12309-16 16 cm, 6¼"  
12309-20 18 cm, 7"  
12309-24 24 cm, 9½"  
12309-30 30 cm, 11¼"



DE BAKEY  
12304-16 16 cm, 6¼"  
12304-20 18 cm, 7"  
12304-24 24 cm, 9½"  
12304-30 30 cm, 11¼"

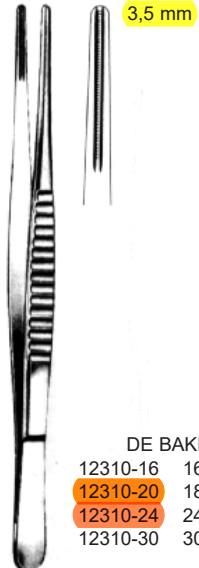

DE BAKEY  
12310-16 16 cm, 6¼"  
12310-20 18 cm, 7"  
12310-24 24 cm, 9½"  
12310-30 30 cm, 11¼"

Gefäßklemmen, Bulldogklemmen, Arterienklemmen  
 Hemostatic Forceps  
 Pinzas hemostáticas  
 Pinze serraфина, Pinze emostatiche



DIEFFENBACH  
 13102-04 3,5 cm, 1.4"  
 13102-05 5,5 cm, 2.2"



gerade  
 straight  
 recta  
 rette

gebogen  
 curved  
 curva  
 curve



DIEFFENBACH  
 13103-04 3,5 cm, 1.4"  
 13103-05 5,5 cm, 2.2"

JOHNS-HOPKINS

13110-50	5,0 cm, 2"	13111-50
13110-55	5,5 cm, 2.2"	13111-55
13110-65	6,5 cm, 2.6"	13111-65
13110-70	7,0 cm, 2 3/4"	13111-70
13110-75	7,5 cm, 3"	13111-75
13110-90	9,0 cm, 3 1/2"	13111-90

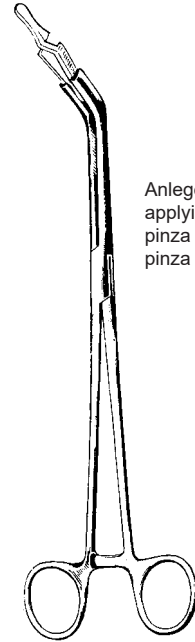

Anlegezange  
 applying forceps  
 pinza para poner  
 pinza applicatrice

13115-00  
 23 cm, 9"

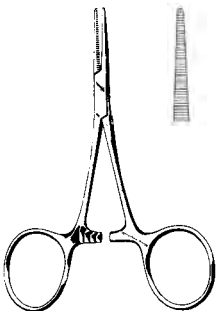

HARTMANN  
 13210-10  
 10 cm, 4"

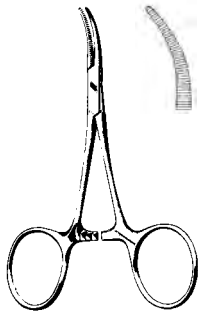

HARTMANN  
 13211-10  
 10 cm, 4"

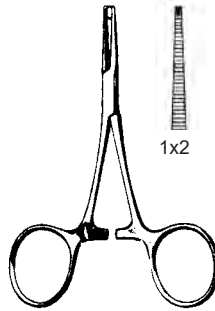

HARTMANN  
 13212-10  
 10 cm, 4"

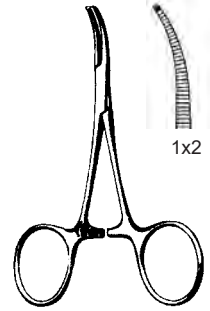

HARTMANN  
 13213-10  
 10 cm, 4"

Micro-HARTMANN  
 13214-10  
 10 cm, 4"

Micro-HARTMANN  
 13215-10  
 10 cm, 4"

Arterienklemmen  
Hemostatic Forceps  
Pinzas hemostáticas  
Pinze emostatiche



TITAN — HALSTED-MOSQUITO — TITAN

13224-12	13220-12	12,5 cm, 5"	13221-12	13225-12
	13220-14	14,0 cm, 5 1/2"	13221-14	
	13220-18	18,0 cm, 7"	13221-18	
	13220-21	21,0 cm, 8 1/4"	13221-21	



— HALSTED-MOSQUITO micro —

13222-12	12,5 cm, 5"	13223-12
----------	-------------	----------

JACOBSON micro

13226-12	12,5 cm, 5"	13227-12
----------	-------------	----------

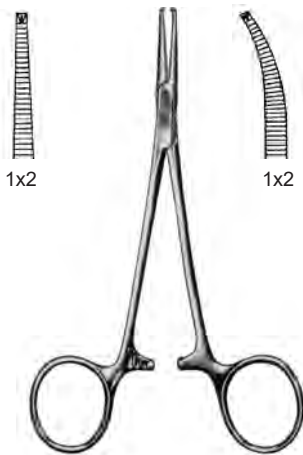

— HALSTED-MOSQUITO —

13230-12	12,5 cm, 5"	13231-12
13230-14	14,0 cm, 5 1/2"	13231-14
13230-18	18,0 cm, 7"	13231-18
13230-21	21,0 cm, 8 1/4"	13231-21

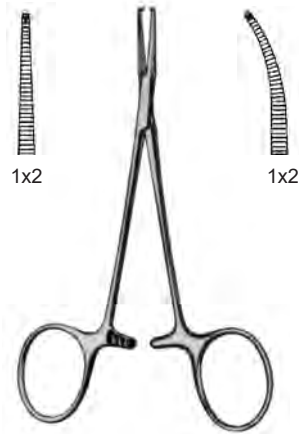

— HALSTED-MOSQUITO micro —

13232-12	12,5 cm, 5"	13233-12
----------	-------------	----------

Arterienklemmen  
Hemostatic Forceps  
Pinzas hemostáticas  
Pinze emostatiche

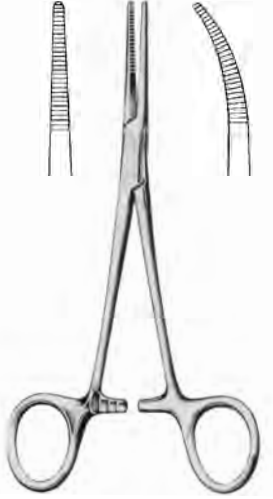

KELLY

13240-14 14 cm, 5 1/2" 13241-14  
13240-18 18 cm, 7" 13241-18  
13244-14 14 cm, 5 1/2" 13245-14  
TITAN TITAN



KELLY-RANKIN

13242-16 16 cm, 6 1/4" 13243-16



TERRIER

13228-13  
13 cm, 5 1/8"

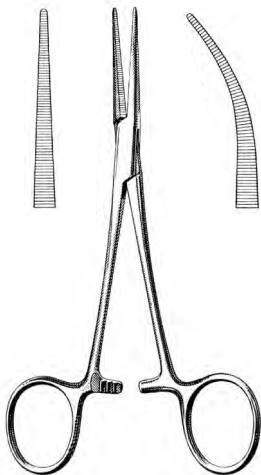

COLLER-CRILE

13256-14 14 cm, 5 1/2" 13257-14  
13258-16 16 cm, 6 1/4" 13259-16

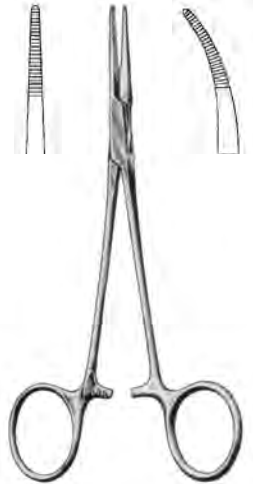

PROVIDENCE-HOSPITAL

13270-14 14 cm, 5 1/2" 13271-14

Arterienklemmen  
Hemostatic Forceps  
Pinzas hemostáticas  
Pinze emostatiche

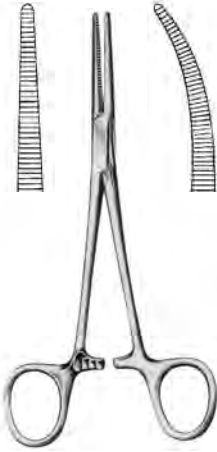

CRILE  
13250-14 14 cm, 5 1/2"  
13250-18 18 cm, 7"  
13254-14 14 cm, 5 1/2"  
TITAN



CRILE  
13260-14 14 cm, 5 1/2" 13261-14



CHRISTOPHE  
16 cm, 6 1/4"

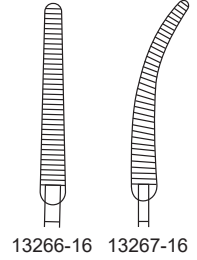

13266-16 13267-16

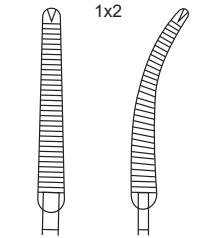

13268-16 13269-16

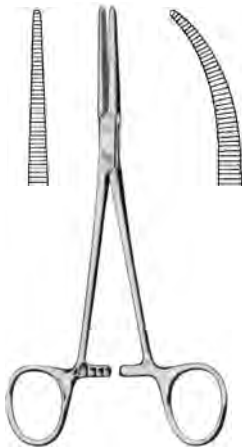

CRILE-RANKIN  
13262-16 16 cm, 6 1/4" 13263-16



CRILE-RANKIN  
13264-16 16 cm, 6 1/4" 13265-16

Arterienklemmen  
Hemostatic Forceps  
Pinzas hemostáticas  
Pinze emostatiche

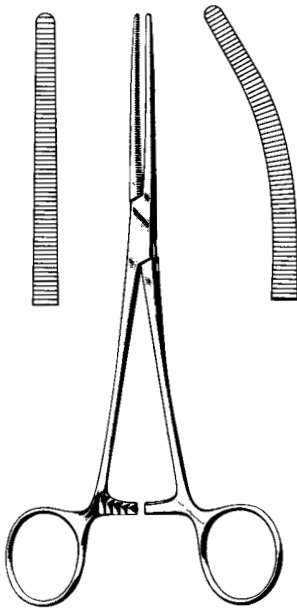

ROCHESTER-PEAN

13310-13	13 cm, 5 1/8"	13311-13
13310-14	14 cm, 5 1/2"	13311-14
13310-16	16 cm, 6 1/4"	13311-16
13310-18	18 cm, 7"	13311-18
13310-20	20 cm, 8"	13311-20
13310-22	22 cm, 8 3/4"	13311-22
13310-24	24 cm, 9 1/2"	13311-24
13310-26	26 cm, 10 1/4"	13311-26
13310-30	30 cm, 11 3/4"	13311-30

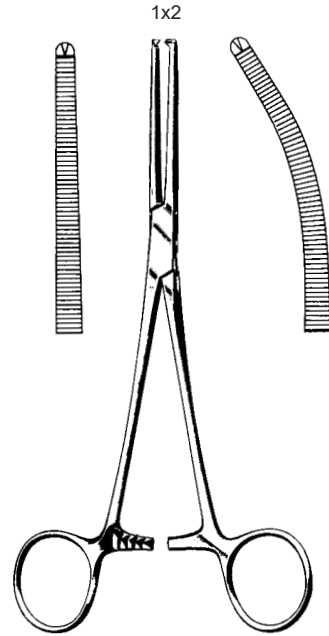

ROCHESTER-OCHSNER

13320-13	13 cm, 5 1/8"	13321-13
13320-14	14 cm, 5 1/2"	13321-14
13320-16	16 cm, 6 1/4"	13321-16
13320-18	18 cm, 7"	13321-18
13320-20	20 cm, 8"	13321-20
13320-22	22 cm, 8 3/4"	13321-22
13320-24	24 cm, 9 1/2"	13321-24
13320-26	26 cm, 10 1/4"	13321-26
13320-30	30 cm, 11 3/4"	13321-30

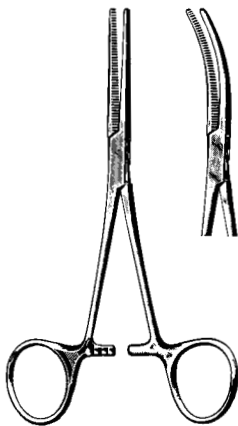

Fein  
Delicate  
Delicada  
Fina

PEAN

13312-14	14 cm, 5 1/2"	13313-14
13312-16	16 cm, 6 1/4"	13313-16

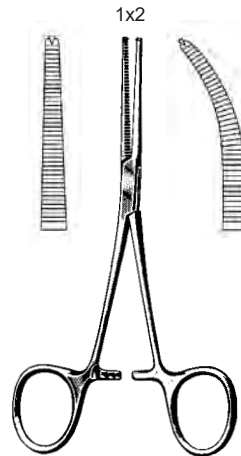

Fein  
Delicate  
Delicada  
Fina

KOCHER

13322-14	14 cm, 5 1/2"	13323-14
13322-16	16 cm, 6 1/4"	13323-16

Arterienklemmen  
Hemostatic Forceps  
Pinzas hemostáticas  
Pinze emostatiche



OVERHOLT-BABY  
13420-14  
14 cm, 5 1/2"



OVERHOLT-GEISSENDOERFER  
21 cm, 8 1/4"

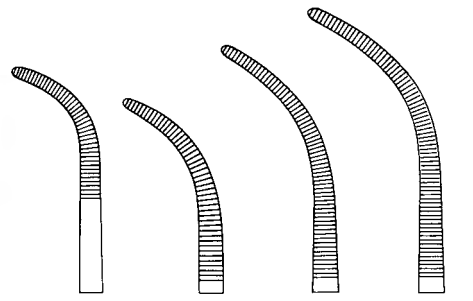

Fig. 1 13421-01  
Fig. 2 13421-02 13425-02 26 cm 10 1/4"  
Fig. 3 13421-03 13425-03 27 cm 10 1/2"  
Fig. 4 13421-04 13425-04 27,5 cm 10,8"

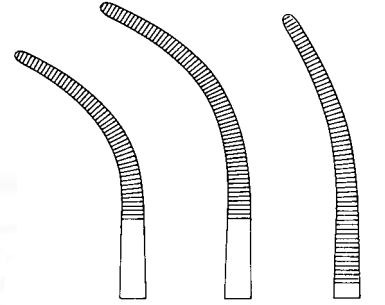
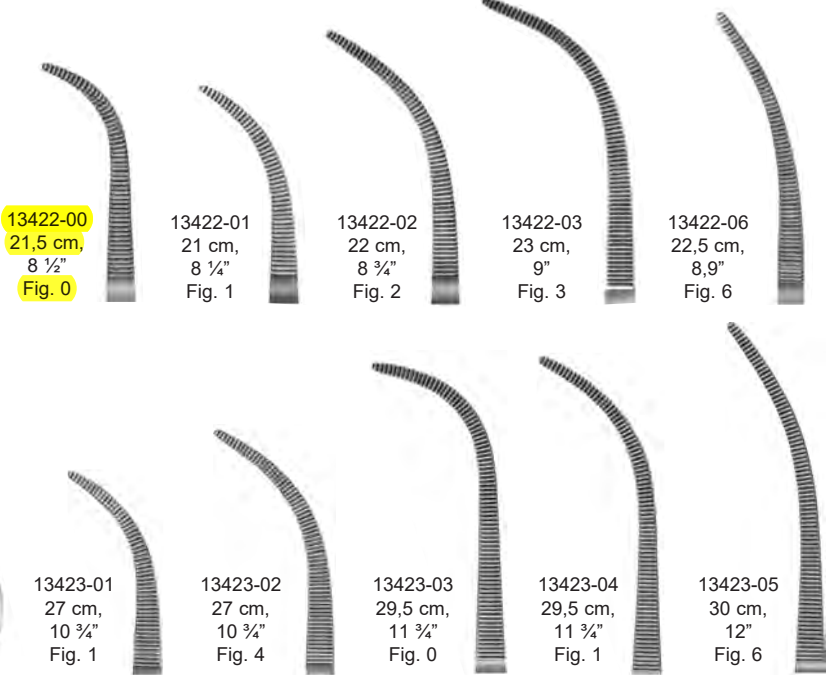

Fig. 5 13421-05 13425-05 27 cm 10 1/2"  
Fig. 6 13421-06 13425-06 28 cm 11"  
Fig. 7 13421-07



OVERHOLT



13422-00  
21,5 cm,  
8 1/2"  
Fig. 0

13422-01  
21 cm,  
8 1/4"  
Fig. 1

13422-02  
22 cm,  
8 3/4"  
Fig. 2

13422-03  
23 cm,  
9"  
Fig. 3

13422-06  
22,5 cm,  
8,9"  
Fig. 6

13423-01  
27 cm,  
10 3/4"  
Fig. 1

13423-02  
27 cm,  
10 3/4"  
Fig. 4

13423-03  
29,5 cm,  
11 3/4"  
Fig. 0

13423-04  
29,5 cm,  
11 3/4"  
Fig. 1

13423-05  
30 cm,  
12"  
Fig. 6

Arterienklemmen  
Hemostatic Forceps  
Pinzas hemostáticas  
Pinze emostatiche

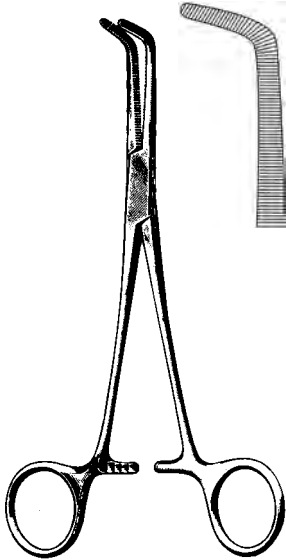

MIXTER  
13471-14 14 cm, 5 ½"  
13471-16 16 cm, 6 ¼"  
13471-18 18 cm, 7"  
13471-23 23 cm, 9"

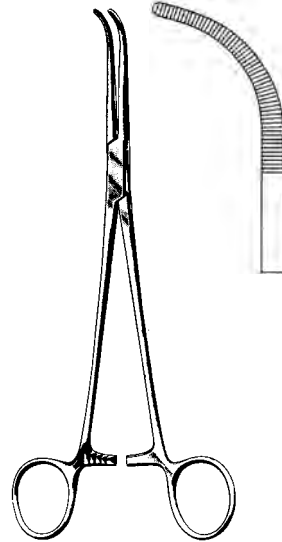

MIXTER  
13473-22  
22 cm, 8 ¾"



KANTROWITZ  
13474-19 19 cm, 7 ½"  
13474-24 24 cm, 9 ½"  
13474-26 26 cm, 10 ¼"



MIXTER BABY  
13475-14  
14 cm, 5 ½"



MIXTER BABY  
13475-18  
18 cm, 7"

Wundhaken  
Retractors  
Separadores  
Divaricatori

Satz, set, juego, serie

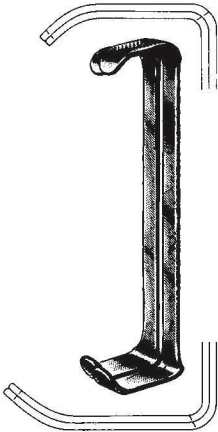

FARABEUF  
19102-12  
12 cm, 4 3/4"

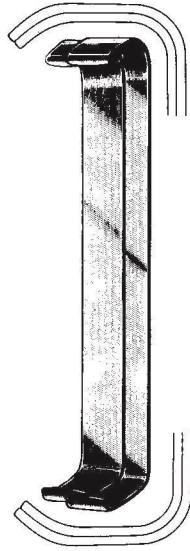

FARABEUF  
19102-15 15 cm, 6"  
19102-20 20 cm, 8"



COLLIN  
19104-15  
15 cm, 6"

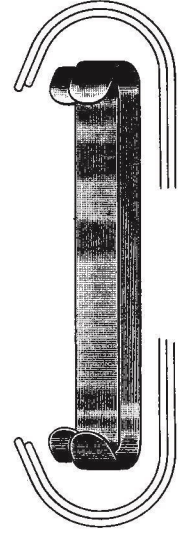

PARKER  
19110-13  
13,5 cm, 5 1/4"

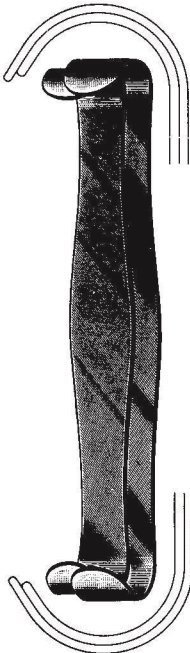

PARKER  
19110-18 18 cm, 7"

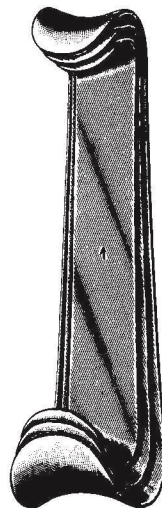

ROUX  
19120-00

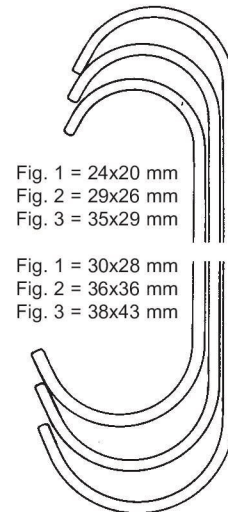

Fig. 1 = 24x20 mm  
Fig. 2 = 29x26 mm  
Fig. 3 = 35x29 mm

Fig. 1 = 30x28 mm  
Fig. 2 = 36x36 mm  
Fig. 3 = 38x43 mm

19120-14 Fig. 1 14 cm, 5 1/2"  
19120-15 Fig. 2 15 cm, 6"  
19120-17 Fig. 3 17 cm, 6 3/4"

Wundhaken  
**Retractors**  
 Separadores  
 Divaricatori



19388-40 70x40 mm  
 19388-50 70x50 mm  
 19388-65 70x65 mm



MORRIS  
 24,5 cm  
 9 3/4"

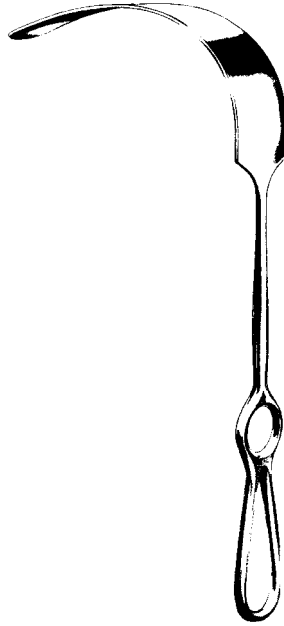

KELLY  
 19385-38 160x38 mm  
 19385-57 160x57 mm  
 27 cm, 10 1/2"



SIMON  
 19480-22 115x22 mm  
 19480-27 115x27 mm  
 28 cm, 11"



19482-45 45x25 mm  
 19482-73 73x28 mm  
 19482-82 82x28 mm

HEANEY  
 27 cm, 10 1/2"

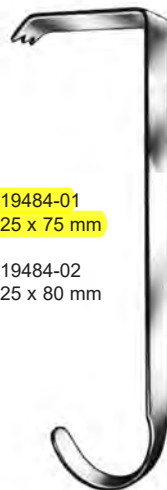

19484-01  
 25 x 75 mm

19484-02  
 25 x 80 mm

HIBBS  
 24 cm, 9 1/2"



125x37 mm

SAUERBRUCH  
 19492-25  
 25 cm, 10"

Wundsperrer  
Retractors  
Separadores  
Divaricatori

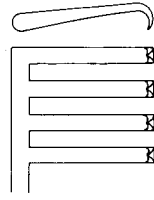
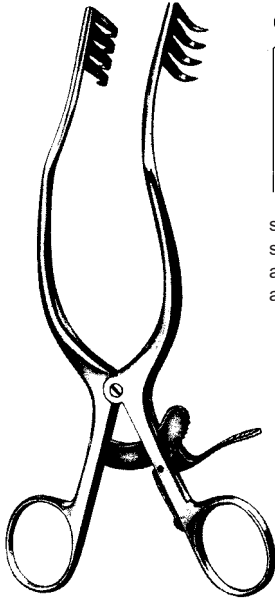

spitz  
sharp  
agudo  
acuto

ANDERSON ADSON  
19679-20 19,5 cm, 7 <sup>3</sup>/<sub>4</sub>"



stumpf  
blunt  
romo  
smusso

NORFOLK / NORWICH  
19679-22 22 cm, 8 <sup>3</sup>/<sub>4</sub>"

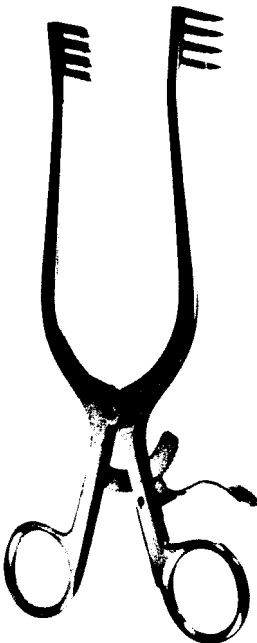

spitz  
sharp  
agudo  
acuto

ADSON  
19680-19 19 cm, 7 <sup>1</sup>/<sub>2</sub>" 19681-19

stumpf  
blunt  
romo  
smusso



stumpf  
blunt  
romo  
smusso

TRAVERS  
19681-21 21,5 cm, 8 <sup>1</sup>/<sub>2</sub>"

Sonden  
 Probes, Directors  
 Sondas, estiletos  
 Sonde, specilli



2 mm ø

- 11,5 cm, 4 1/2" 21102-11
- 13,0 cm, 5 1/8" 21102-13
- 14,5 cm, 5 3/4" 21102-14
- 16,0 cm, 6 1/4" 21102-16
- 18,0 cm, 7" 21102-18
- 20,0 cm, 8" 21102-20
- 25,0 cm, 10" 21102-25



1 mm ø

- 21104-11
- 21104-13
- 21104-14
- 21104-16
- 21104-18
- 21104-20
- 21104-25



2 mm ø

- 21106-11
- 21106-13
- 21106-14
- 21106-16
- 21106-18
- 21106-20
- 21106-25



21108-14  
 14,5 cm, 5 3/4"



BRODIE  
 21109-18  
 18 cm  
 7"



- 13,0 cm, 5 1/8" 21110-13
- 14,5 cm, 5 3/4" 21110-14
- 16,0 cm, 6 1/4" 21110-16
- 18,0 cm, 7" 21110-18
- 20,0 cm, 8" 21110-20



DOYEN  
 21111-14  
 14 cm  
 5 1/2"



21112-14  
 14,5 cm  
 5 3/4"



NELATON  
 21120-16  
 16 cm  
 6 1/4"



FISH  
 21121-14  
 14 cm, 5 1/2"  
 21121-18  
 18 cm, 7"



WATSON-CHEYNE  
 21122-13  
 13 cm, 5 1/8"  
 21122-18  
 18 cm, 7"

Krampfader-Besteck in Metalletui  
 Varicose vein probe set in metal case  
 Juego para várices en estuche de metal  
 Astuccio per varici in scatola di metallo



**NABATOFF**  
**21150-00**  
 135x100x25 mm  
 compl.

**21150-02**  
 Sondenspitze  
 Probe Tip  
 Puntas sueltas  
 Punte

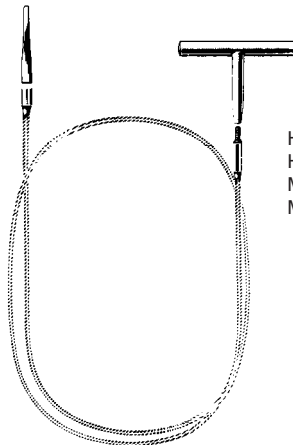

21150-80  
 Handgriff  
 Handle only  
 Mango suelto  
 Manico solo

21150-90

Zugseil  
 cable flexible  
 cable de traccion flex.  
 Corda di trazione fless.

Oliven  
 Olives  
 Olivas  
 Olivas

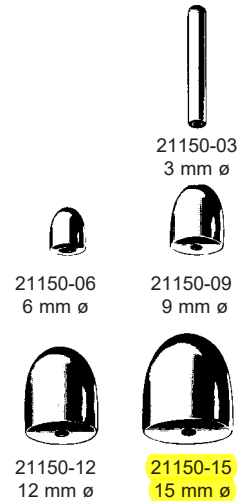

**21150-15**  
**15 mm ø**

Hohlmeißelzangen  
 Bone Rongeurs  
 Pinzas-gubias  
 Pinze sgorbie

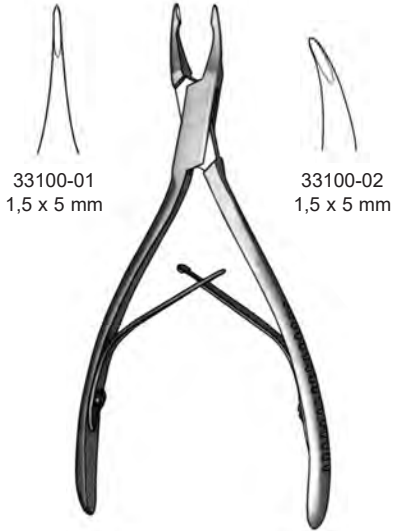

33100-01  
1,5 x 5 mm

33100-02  
1,5 x 5 mm

MICRO FRIEDMAN  
14 cm, 5/2"



2 mm

FRIEDMAN Mini  
33101-12 12 cm, 4 3/4"



3,5 mm

FRIEDMAN  
33101-14 14 cm, 5 1/2"

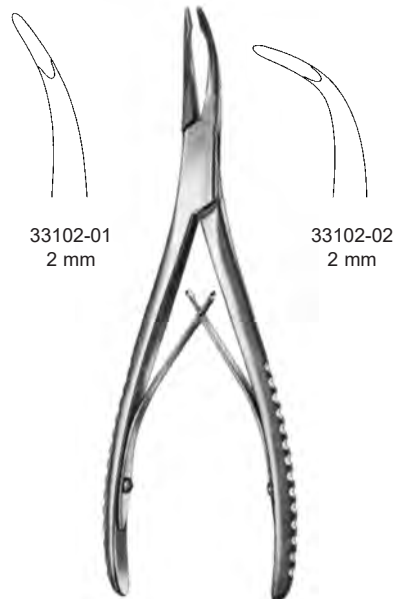

33102-01  
2 mm

33102-02  
2 mm

STELLBRINK  
17 cm, 6 3/4"

Hohlmeißelzangen  
 Bone Rongeurs  
 Pinzas-gubias  
 Pinze sgorbie



**OLIVECRONA**  
 33147-20  
 20 cm, 7.9"

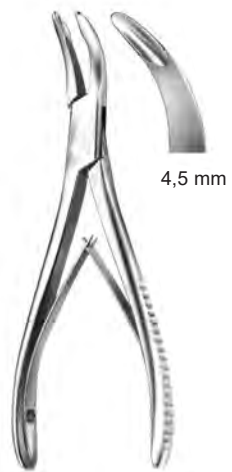

**BANE-HARTMANN**  
 33148-18  
 17,5 cm, 7"



**LEMPERT**  
 33150-16 33151-16  
 16 cm, 6 1/4"



**JANSEN**  
 17 cm, 6 3/4"



**LEMPERT**  
 33154-18 33155-18  
 18,5 cm, 7 1/4"



**BEYER**  
 33156-18  
 18 cm, 7"

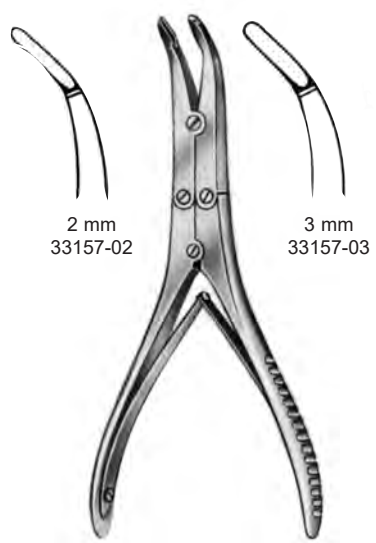

**KLEINERT-KUTZ**  
 15 cm, 6"

Scharfe Löffel  
Bone Currettes  
Cucharillas cortantes  
Curette taglianti



33485-21 21 cm, 8 1/4"  
oval/rund  
ovale/ronde  
ovalado/redondo  
ovale/rotonda



WILLIGER  
17,5 cm, 7"

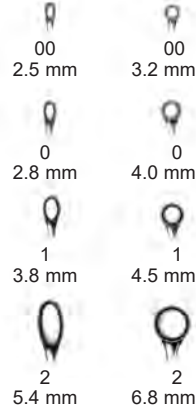
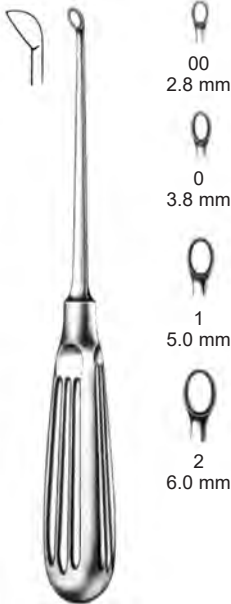
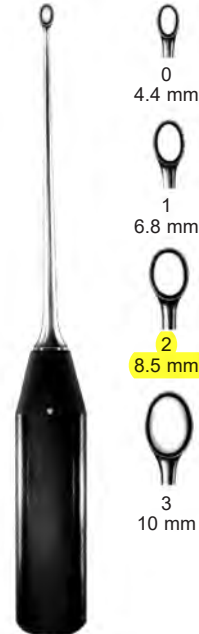

Fig. 00	33485-99	33486-99
0	33486-00	33487-00
1	33486-01	33487-01
2	33486-02	33487-02



DAUBENSPECK	Fig. 00	33487-99
20 cm, 8"	0	33488-00
	1	33488-01
	2	33488-02



27 cm, 10 1/2"	Fig. 0	33489-00
	1	33489-01
	2	33489-02
	3	33489-03

Osteotome, Hohlmeißel  
 Osteotome, Gouges  
 Osteótomo, Gubias  
 Osteotomia, sgorbie

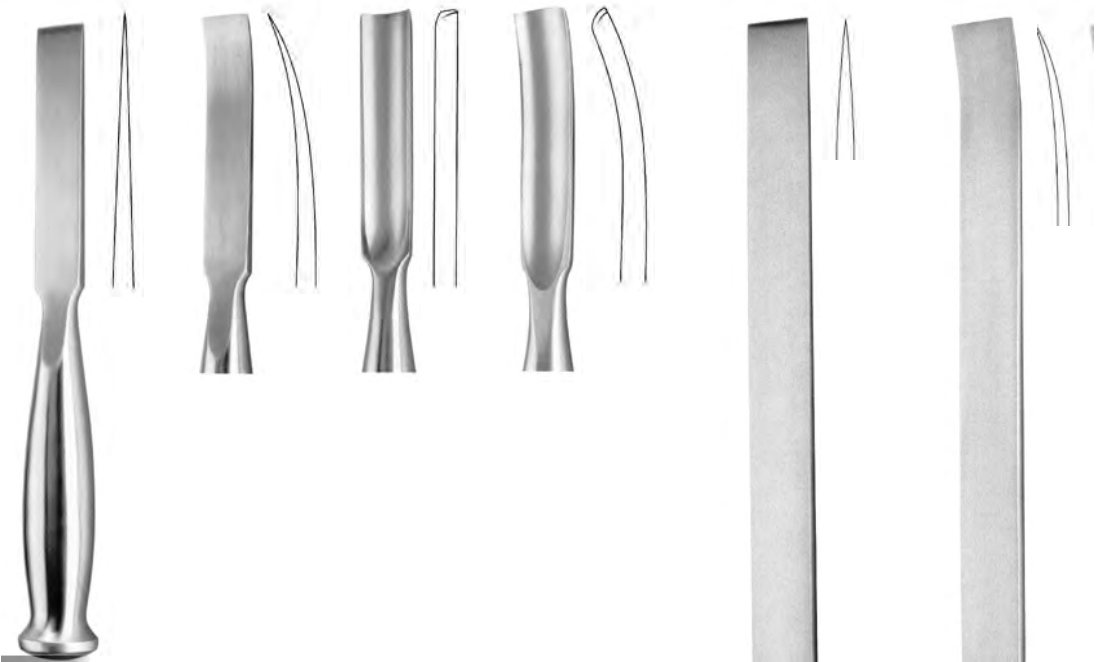

SMITH-PETERSEN  
 20 cm, 8"

6 mm	33644-06	33645-06	33647-06	
9 mm	33644-09	33645-09	33647-09	33649-09
13 mm	33644-13	33645-13		
14 mm			33647-14	33649-14
16 mm	33644-16	33645-16	33647-16	33649-16
19 mm	33644-19	33645-19	33647-19	33649-19
25 mm	33644-25	33645-25	33647-25	33649-25
32 mm	33644-32	33645-32	33647-32	33649-32

LAMBOTTE

24 cm, 9 1/2"

24 cm, 9 1/2"

33650-04	4 mm	33651-04
33650-06	6 mm	33651-06
33650-08	8 mm	33651-08
33650-10	10 mm	33651-10
33650-13	13 mm	33651-13
33650-16	16 mm	33651-16
33650-18	18 mm	33651-18
33650-20	20 mm	33651-20
33650-25	25 mm	33651-25
33650-30	30 mm	33651-30
33650-38	38 mm	33651-38
33650-44	44 mm	33651-44
33650-50	50 mm	33651-50

Osteotome, Flachmeißel, Hohlmeißel  
 Osteotome, Chisels, Gouges  
 Osteótomo, Cinceles, Gubias  
 Osteotomia, Scalpelli, Sgorbie



HOKE

14 cm, 5 1/2"

33668-03	3 mm
33668-05	5 mm
33668-06	6 mm
33668-08	8 mm
33668-09	9 mm
33668-13	13 mm
33668-16	16 mm
33668-19	19 mm



HIBBS

24 cm, 9 1/2"

33670-06	6 mm
33670-09	9 mm
33670-13	13 mm
33670-16	16 mm
33670-19	19 mm
33670-25	25 mm
33670-32	32 mm



HIBBS

24 cm, 9 1/2"

33671-06	6 mm
33671-09	9 mm
33671-13	13 mm
33671-16	16 mm
33671-19	19 mm
33671-25	25 mm
33671-32	32 mm



HIBBS

24 cm, 9 1/2"

33672-06	6 mm
33672-09	9 mm
33672-13	13 mm
33672-16	16 mm
33672-19	19 mm
33672-25	25 mm
33672-32	32 mm



HIBBS

24 cm, 9 1/2"

33673-06	6 mm
33673-09	9 mm
33673-13	13 mm
33673-16	16 mm
33673-19	19 mm
33673-25	25 mm
33673-32	32 mm



HIBBS

24 cm, 9 1/2"

33675-06	6 mm
33675-09	9 mm
33675-13	13 mm
33675-16	16 mm
33675-19	19 mm
33675-25	25 mm
33675-32	32 mm

Meißel  
Chisels  
Cinceles  
Scalpelli



**33676-02**  
9 cm, 3 1/2"  
Spannschlüssel  
Key  
Llave  
Clé  
Chiave

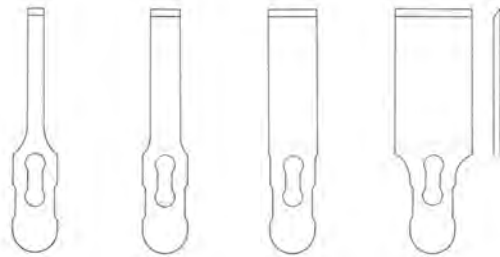

5 mm	10 mm	16 mm	25 mm
33676-05	33676-10	33676-16	33676-25
8,5 mm, 3,4"	8,5 mm, 3,4"	8,5 mm, 3,4"	8,5 mm, 3,4"

Meißelklingen  
auswechselbar  
Chisel blades  
interchangeable  
Hojas de cincel  
intercambiables  
Lame intercambiabili

**33676-01**  
18,5 cm, 7 1/4"  
Griff allein  
Handle only  
Mango suelto  
Manico solo

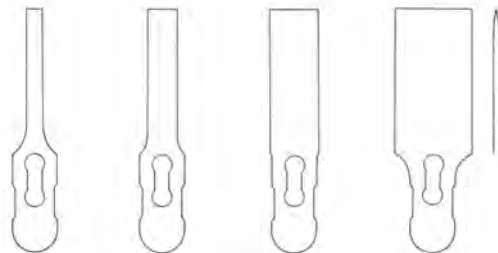

5 mm	<b>10 mm</b>	16 mm	<b>25 mm</b>
33677-05	<b>33677-10</b>	33677-16	<b>33677-25</b>
8,5 mm, 3,4"	8,5 mm, 3,4"	8,5 mm, 3,4"	8,5 mm, 3,4"

Osteotomklingen  
auswechselbar  
Osteotome blades  
interchangeable  
Hojas de osteótomo  
intercambiables  
Lame per osteotomia  
intercambiabili

Elevatoren, Raspatoren  
 Elevators, Raspatories  
 Elevadores, Periostótomos  
 Elevatori, Periostotomi

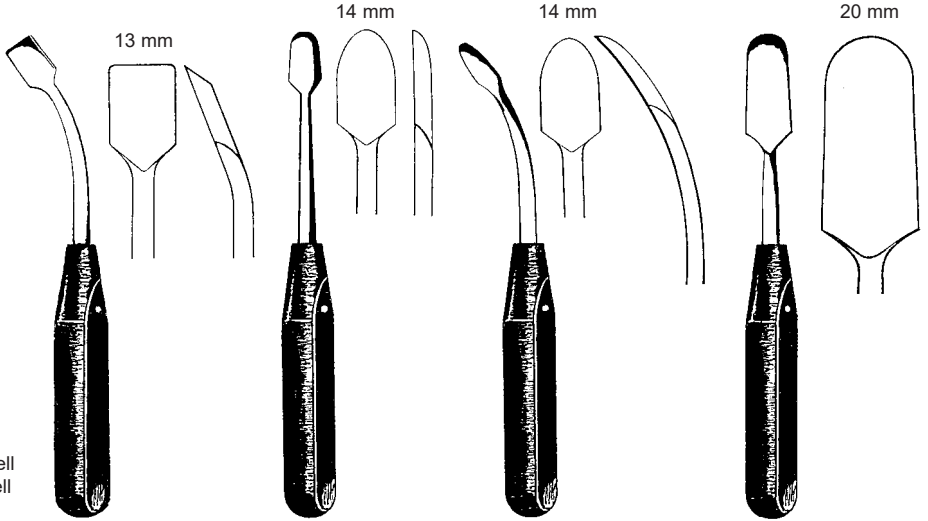

mit Ferrozellgriff  
 with Ferrozell-Handle  
 con mango de Ferrozell  
 con manico di Ferrozell

33745-19  
 18,5 cm, 7 1/4"

33746-19  
 19,5 cm, 7 3/4"

33747-18  
 18,5 cm, 7 1/4"

33748-20  
 20 cm, 8"

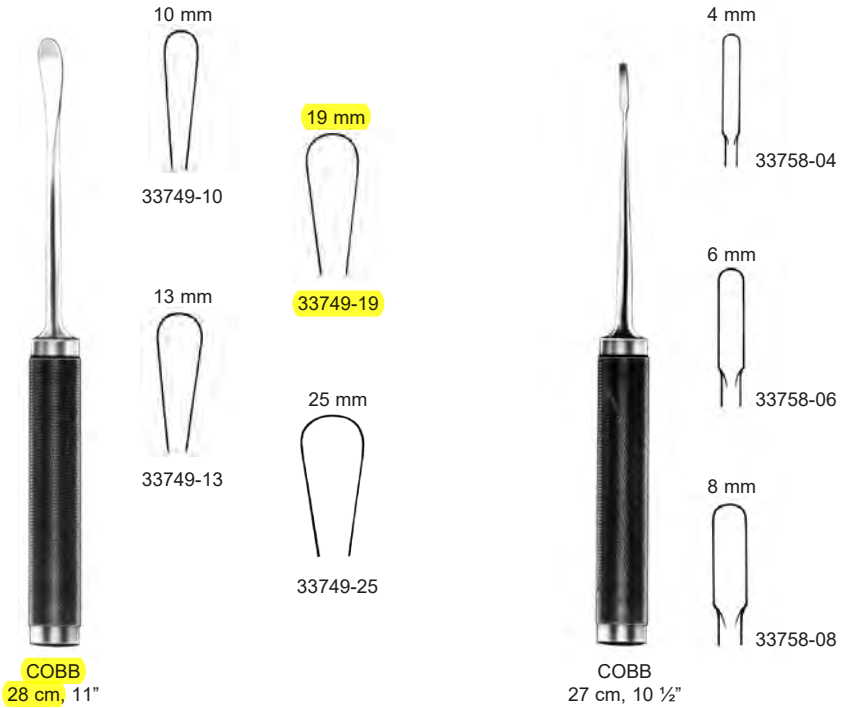

**COBB**  
 28 cm, 11"

**COBB**  
 27 cm, 10 1/2"

10 mm  
 33749-10

**19 mm**  
**33749-19**

13 mm  
 33749-13

25 mm  
 33749-25

4 mm  
 33758-04

6 mm  
 33758-06

8 mm  
 33758-08

Knochenhebel  
Bone Levers  
Elevadores para huesos  
Elevatori per ossa

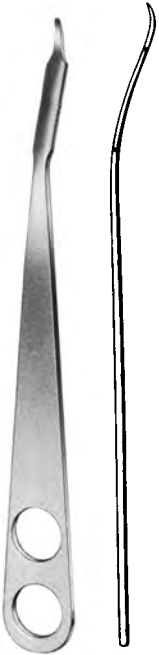

HOHMANN  
23,5 cm, 9 1/4"  
33801-08 8 mm  
33801-10 10 mm  
33801-12 12 mm

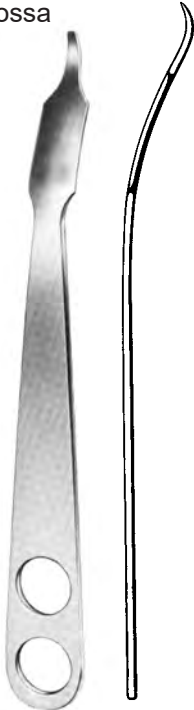

HOHMANN  
**33801-18**  
18 mm, 3/4"  
23,5 cm, 9 1/4"

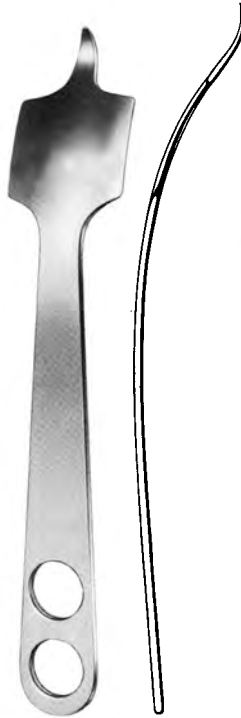

HOHMANN  
33801-43  
43 mm, 1 3/4"  
26 cm, 10 1/4"



HOHMANN  
**33801-70**  
70 mm, 2 3/4"  
25 cm, 10"



KÖNIG  
33802-01  
15 cm, 6"



KÖNIG  
33802-02  
15 cm, 6"



33802-14  
14 cm, 5 1/2"



HAYES  
33803-05  
15 cm, 6"



33803-07  
15 cm, 6"

Knochenhebel  
Bone Levers  
Elevadores para huesos  
Elevatori per ossa



HOHMANN  
25 cm, 10"  
33803-43 43 mm

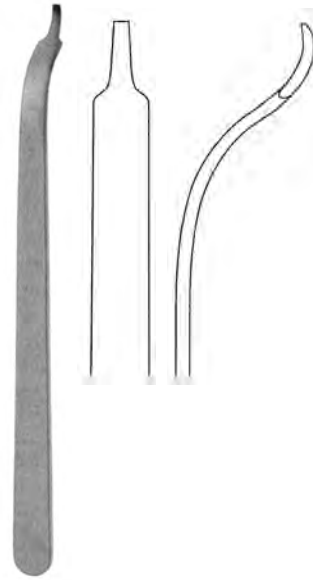

BUCK-GRAMCKO  
33804-15 7,5 mm



HOHMANN  
25 cm, 10"  
33805-22 22 mm



HOHMANN  
29 cm, 11 1/2"  
33805-33 33 mm



HOHMANN  
27,5 cm, 10 3/4"  
33807-24 24 mm



HOHMANN  
25 cm, 10"  
33809-22 22 mm

Retraktor, Knochenhebel, Meniskushaken  
 Retractor, Bone Levers, Meniscus Retractors  
 Separador, Elevadores p. huesos, Separadores para menisco  
 Divaricatori, Elevatori per ossa, Divaricatori per il menisco

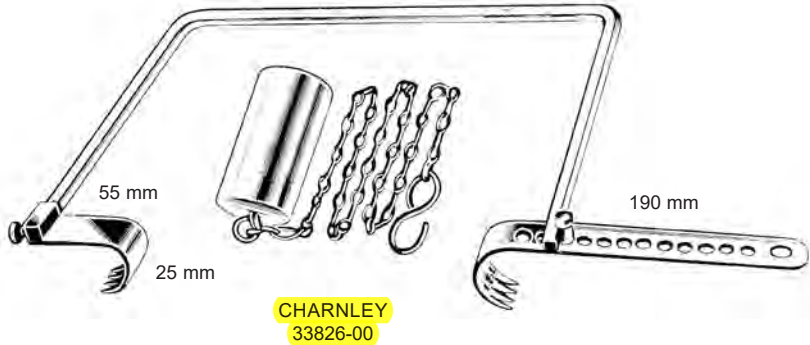

33826-01 spitz, gerieft  
 pointed tip, serrated  
 punta aguda, dentada  
 punta acuta, zigrinata

33826-02 stumpf, gerieft  
 blunt tip, serrated  
 punta roma, dentada  
 punta smussa, zigrinata

33826-03 stumpf, glatt  
 blunt tip, smooth  
 punta roma, lisa  
 punta smussa, liscia

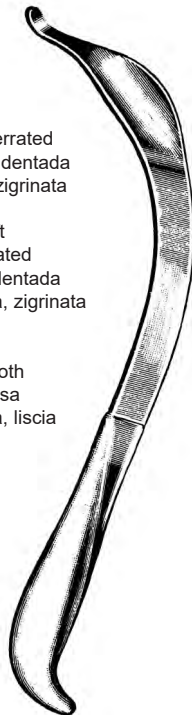

AUFRANC-COBRA  
 26 cm, 10 1/4"



BLOUNT  
 33827-17  
 17,5 cm, 7"

Dura Dissektoren  
Dura Dissectors  
Elevadores  
Scollatori

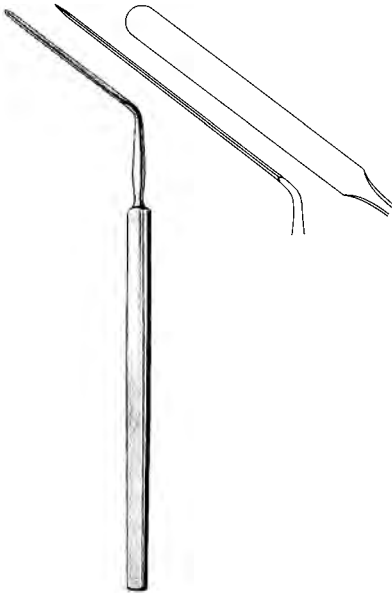

HORSLEY  
41155-20  
20 cm, 8"



WOODSON  
41156-18  
18 cm, 7"



FRAZIER  
41158-01  
15 cm, 6"



HOEN  
41158-02  
15 cm, 6"

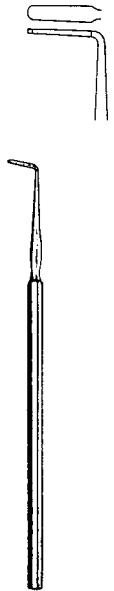

HOEN  
41158-03  
15 cm, 6"



PENFIELD  
41161-01  
17,5 cm, 6,9"



PENFIELD  
41161-02  
19,5 cm, 7 3/4"



PENFIELD  
41161-03  
19,5 cm, 7 3/4"



PENFIELD  
41161-04  
21,5 cm, 8 1/2"



PENFIELD  
41161-05  
29 cm, 11,4"

Hirnspatel, Saugrohre, Punktionskanüle  
 Brain Spatulas, Suction Tubes, Puncture Cannulas  
 Espatulas cerebrales, Tubos de aspiración, Tubo de punción  
 Spatole cerebrali, Tubi aspirazioni, cannula per punzione



biegsam  
 malleable  
 maleable  
 malleabile

DAVIS	18 cm, 7"
41254-06	6 mm, ¼"
41254-10	9 mm, ⅜"
41254-13	13 mm, ½"
41254-16	16 mm, ⅝"
41254-19	19 mm, ¾"
41254-25	25 mm, 1"
41254-32	32 mm, 1 ¼"
41254-38	38 mm, 1 ½"



ADSON  
 41290-21  
 21 cm, 8 ¼"  
 ø 4 mm



isoliert  
 isolated  
 isolada  
 isolato

FERGUSSON  
 41294-40  
 18 cm, 7"  
 ø 4 mm, 90°

mm	Charr.	F.G.	30°	75°
Ø 1,7	5	41295-05		
Ø 2,0	6	41295-06		41297-06
Ø 2,3	7	41295-07		41297-07
Ø 2,7	8	41295-08		41297-08
Ø 3,0	9	41295-09		41297-09
Ø 3,3	10	41295-10		41297-10
Ø 3,7	11	41295-11		41297-11
Ø 4,0	12	41295-12		41297-12
Ø 5,0	15	41295-15		

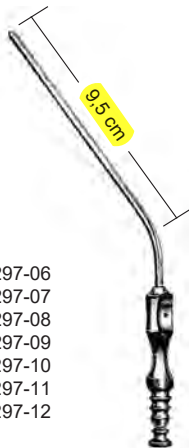

FRAZIER /FERGUSSON  
 41295-06 – 41297-12  
 19 cm, 7 ½"



FRAZIER /FERGUSSON  
 41298-12  
 12 cm, 4 ¾" / 3 mm

Wirbelkörperspreizer  
 Lamina Spreaders  
 Separadores para cuerpos vertebrales  
 Divaricatori per corpi vertebrali



CLOWARD  
 41401-16  
 16 cm, 6 ¼"



INGE  
 41405-17  
 17 cm, 6 ¾"

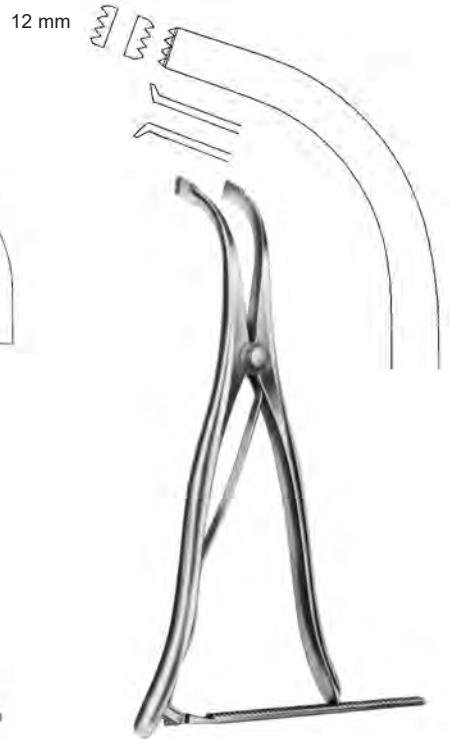

INGE  
 41405-27  
 27 cm, 10 ½"



CLOWARD  
 41406-01  
 12,5 cm, 5"

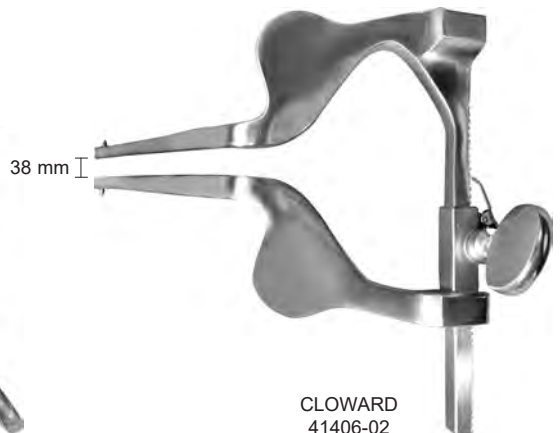

CLOWARD  
 41406-02  
 7,6 cm, 3"

Löffel, Schlingen, Häkchen  
 Ear spoons, Loops, **Hooklets**  
 Cucharas, Asas, Ganchitos  
 Cucchiai, Anse, Uncinetti



**GROSS**  
 45171-12  
 12 cm, 4 3/4"



**BILLEAU**  
 45180-01  
 16 cm, 6 1/4"



45180-01



45180-02



45180-03



**LANGENBECK**  
 45181-13  
 13 cm, 5 1/8"



**ZAUFAL**  
 45184-16  
 16 cm, 6 1/4"



**ZAUFAL-JANSEN**  
 45185-15  
 15 cm, 6"



**DAY**  
 45190-01  
 16 cm, 6 1/4"



45190-01



45190-02



**WAGENER**  
 45192-01  
 14 cm, 5 1/2"



4 mm  
 45192-01



3,5 mm  
 45192-02



3 mm  
 45192-03



2,5 mm  
 45192-04



2 mm  
 45192-05



45192-06



**LUCAE**  
 45193-01  
 14 cm, 5 1/2"



45193-01  
 2 mm



45193-02  
 3 mm



45193-03  
 4 mm

Polypenschnürer, Ohrzängchen  
Snares, Ear Forceps  
Cierra-nudos, Pinzas auriculares  
Serranodi, Pinze auricolari



KRAUSE  
45220-16  
16 cm, 6 1/4"

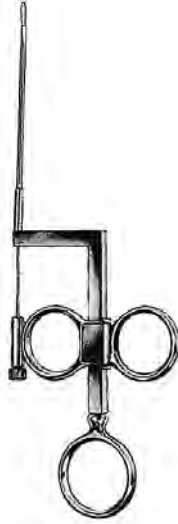

WILDE  
45222-17  
17 cm, 6 3/4"



45225-02  
doz./doc./dozz.  
0,2 mm

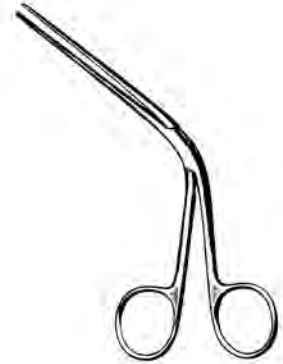

TILLEY  
45243-14  
14 cm, 5 1/2"



LITTAUER  
45245-12  
12 cm, 4 3/4"

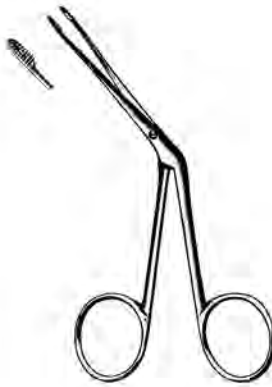

HARTMANN  
45246-12  
12 cm, 4 3/4"



HARTMANN  
45246-14  
14 cm, 5 1/2"

Mikro-Ohrscheren, Mikro-Ohrzängchen  
**Micro Ear Scissors, Micro Ear Forceps**  
 Tijeras auriculares micro, Pinzas auriculares micro  
 Forbici auricolari micro, Pinze auricolari micro

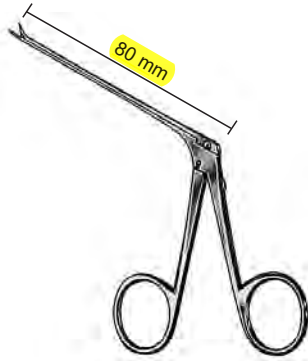

45310-40 - 45322-70

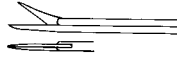

**A**  
 BELLUCCI  
 45310-40  
 micro mini  
 4 mm



**A**  
 BELLUCCI  
 45312-55  
 micro standard  
 5,5 mm

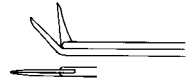

**D**  
 BELLUCCI  
 45313-55  
 micro standard  
 5,5 mm



**B**  
 BELLUCCI  
 45315-55  
 micro standard  
 5,5 mm



**C**  
 BELLUCCI  
 45317-55  
 micro standard  
 5,5 mm



**A**  
 SHEA  
**45320-70**  
 7,0 mm

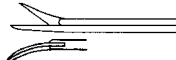

**C**  
 SHEA  
 45321-70  
 7,0 mm



**B**  
 SHEA  
 45322-70  
 7,0 mm

- A:** gerade / **straight** / recta / retta  
**B:** rechts / right / derecha / destra  
**C:** links / left / izquierda / sinistra  
**D:** aufgebogen / curved up / curva in alto / curva hacia arriba  
**E:** nach unten gebogen / curved down / curva in basso / curva hacia abajo

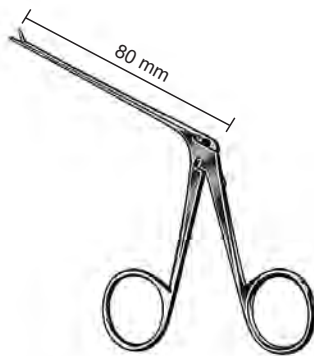

45350-40 - 45360-35



**A**  
 45350-40  
 4 mm



**A**  
 45350-70  
 7 mm



**A**  
 45352-40  
 4 mm



**C**  
 45353-60  
 6 mm



**B**  
 45355-60  
 6 mm



**D**  
 45357-40  
 4 mm



**E**  
 45359-40  
 4 mm



**A**  
 45360-35  
 3,5 mm

Mikro-Ohrzängchen, Hammerkopfstanze

Micro Ear Forceps, Malleus punch

Pinzas auriculares micro, Pinza saca-bocadas para cabeza de martillo

Pinze auricolari micro, Pinze taglianti per testa del martelletto taglio a scalpello

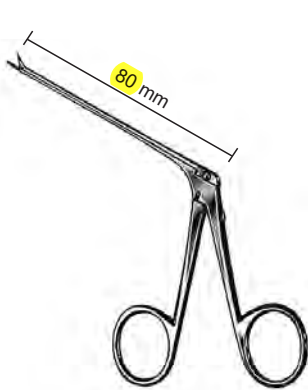

45362-45 - 45383-30



**A**  
45362-45  
4,5 mm



**C**  
45363-45  
4,5 mm

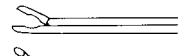

**B**  
45365-45  
4,5 mm

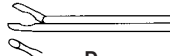

**D**  
45367-50  
5,0 mm



**E**  
45369-50  
5,0 mm



**A**  
GREVEN  
45370-50  
5,0 mm

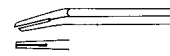

McGEE  
45371-40  
0,8x4,0 mm



COS  
45373-30  
1,8x0,8x3,0 mm



JUERS  
45375-60  
6,0 mm

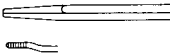

JUERS  
45377-60  
6,0 mm



**B**  
HAUGH  
45383-30  
45° 3 mm

- A:** gerade / straight / recta / retta  
**B:** rechts / right / derecha / destra  
**C:** links / left / izquierda / sinistra  
**D:** aufgebogen / curved up / curva in alto / curva hacia arriba  
**E:** nach unten gebogen / curved down / curva in basso / curva hacia abajo

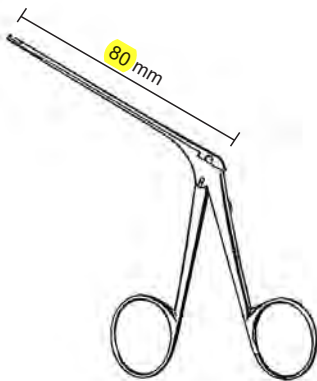

**DIETER**  
45385-01 - 45387-02

micro ø 1,3 mm



45385-01

aufwärts  
upward  
arriba  
in alto

mini ø 1,8 mm

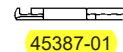

45387-01



45385-02

abwärts  
downward  
abajo  
in basso

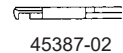

45387-02

Mikro-Ohrzängchen  
 Micro Ear Forceps  
 Pinzas auriculares micro  
 Pinze auricolari micro



WULLSTEIN

45400-01  
0,9 x 1 mm45400-02  
0,8 x 1,3 mm45400-03  
1 mm45401-25  
1,7 x 2,5 mm45402-10  
0,9 x 1 mm45403-13  
0,8 x 1,3 mm45404-13  
0,8 x 1,3 mm

Dissektoren, Küretten, Elevatoren, Mikro-Meßsonde  
 Dissectors, Curettes, Elevators, Micro measuring rod  
 Dissectores, Curetas, Elevadores, Sonda para medir  
 Dissettori, Curette, Elevatori, Sonda auricolare per misurare

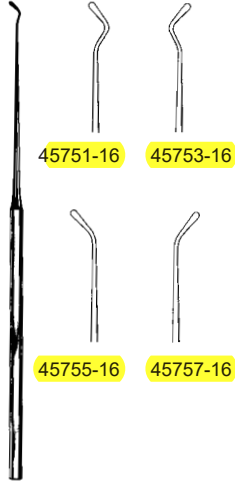

45751-16

45753-16

45755-16

45757-16

**FISCH**

45751-16 - 45757-16

16 cm, 6 1/4"

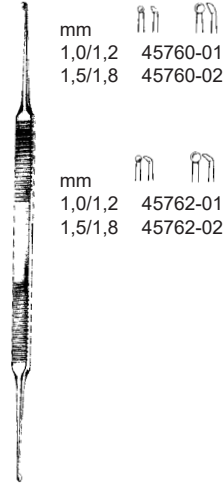

mm  
 1,0/1,2 45760-01  
 1,5/1,8 45760-02

mm  
 1,0/1,2 45762-01  
 1,5/1,8 45762-02

**HOUSE**

45760-01 - 45762-02

15 cm, 6"

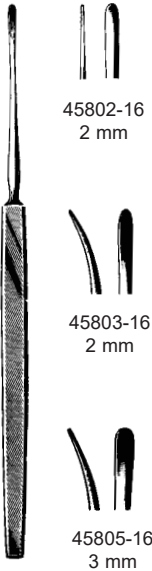

45802-16  
 2 mm

45803-16  
 2 mm

45805-16  
 3 mm

**LEMPERT**

45802-16 - 45805-16

16 cm, 6 1/4"

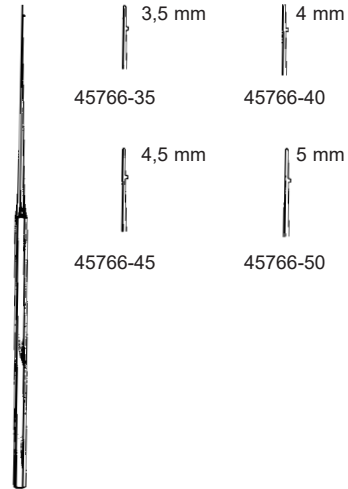

3,5 mm  
 45766-35

4 mm  
 45766-40

4,5 mm  
 45766-45

5 mm  
 45766-50

**HOUSE**

45766-35 - 45766-50

16 cm, 6 1/4"

Nasenspekula  
Nasal Specula  
Especulos nasales  
Specoli nasali



THUDICHUM  
47050-01 - 47050-07

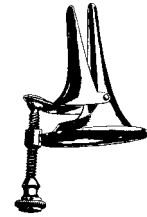
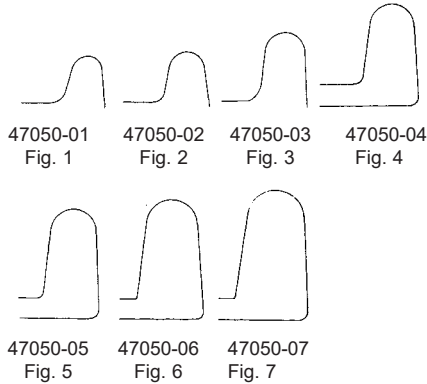

VOLTOLINI  
47060-01 - 47060-03



**HARTMANN-HALLE**  
47102-01 - 47102-03  
15 cm, 6"

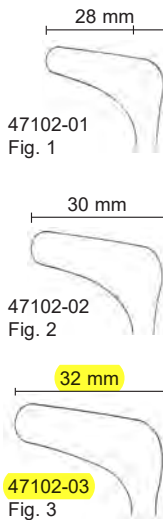

Baby, bebé  
Kind, child, niño, bamb.  
Erwachs., Adult, adulto

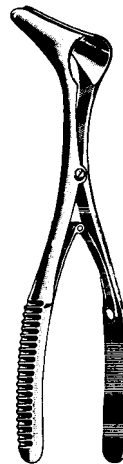

Mod. WIEN  
47112-01 25 mm  
47112-02 30 mm  
47112-03 35 mm



leichtes Modell  
lightweight  
mod. ligero  
mod. leggero

Mod. WIEN  
47113-03

Nasenspekula, Kehlkopfspiegel  
 Nasal Specula, Laryngeal Mirrors  
 Espéculos nasales, espejos laríngeos  
 Specoli nasali, Specchi laringei

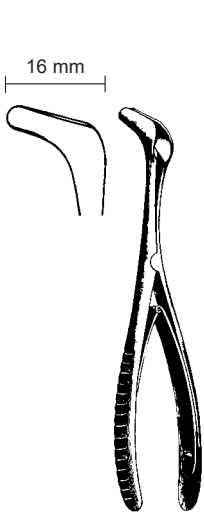

TIECK-HALLE  
 47116-13  
 13,5 cm, 5 1/4"



REDA  
 47118-13  
 12,5 cm, 5"



KILLIAN  
 47120-35 - 47120-90  
 13 cm, 5 1/8"

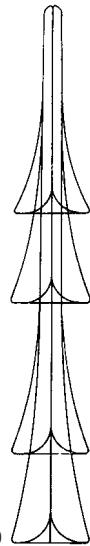

47120-35  
 35 mm  
 47120-50  
 50 mm  
 47120-75  
 75 mm  
 47120-90  
 90 mm

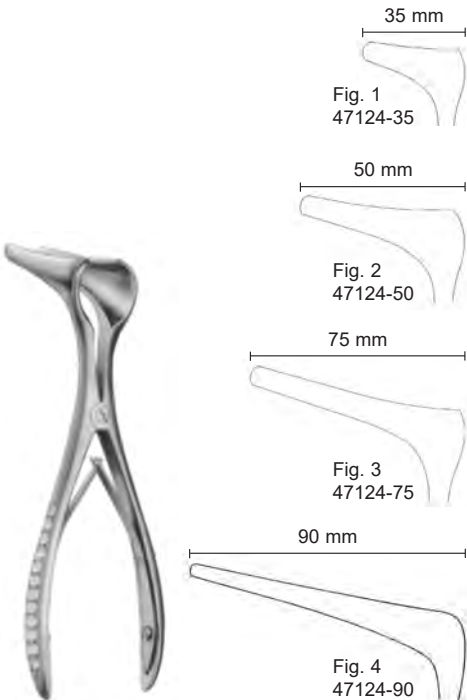

COTTLE  
 14 cm, 5 1/2"

Fig. 1  
 47124-35

Fig. 2  
 47124-50

Fig. 3  
 47124-75

Fig. 4  
 47124-90



MICHEL  
 47139-12 - 47139-18  
 25 cm, 10"

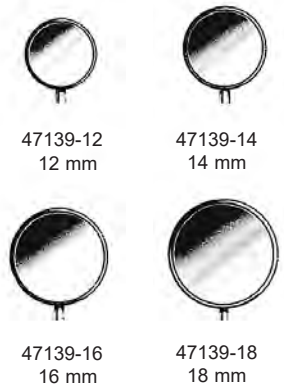

47139-12  
 12 mm

47139-14  
 14 mm

47139-16  
 16 mm

47139-18  
 18 mm

Nasenpinzetten, Polypenzange  
 Ear Dressing Forceps, Ear Polypus Forceps  
 Pinzas auriculares, Pinzas para pólipos  
 Pinze auricolari, Pinze per polipi

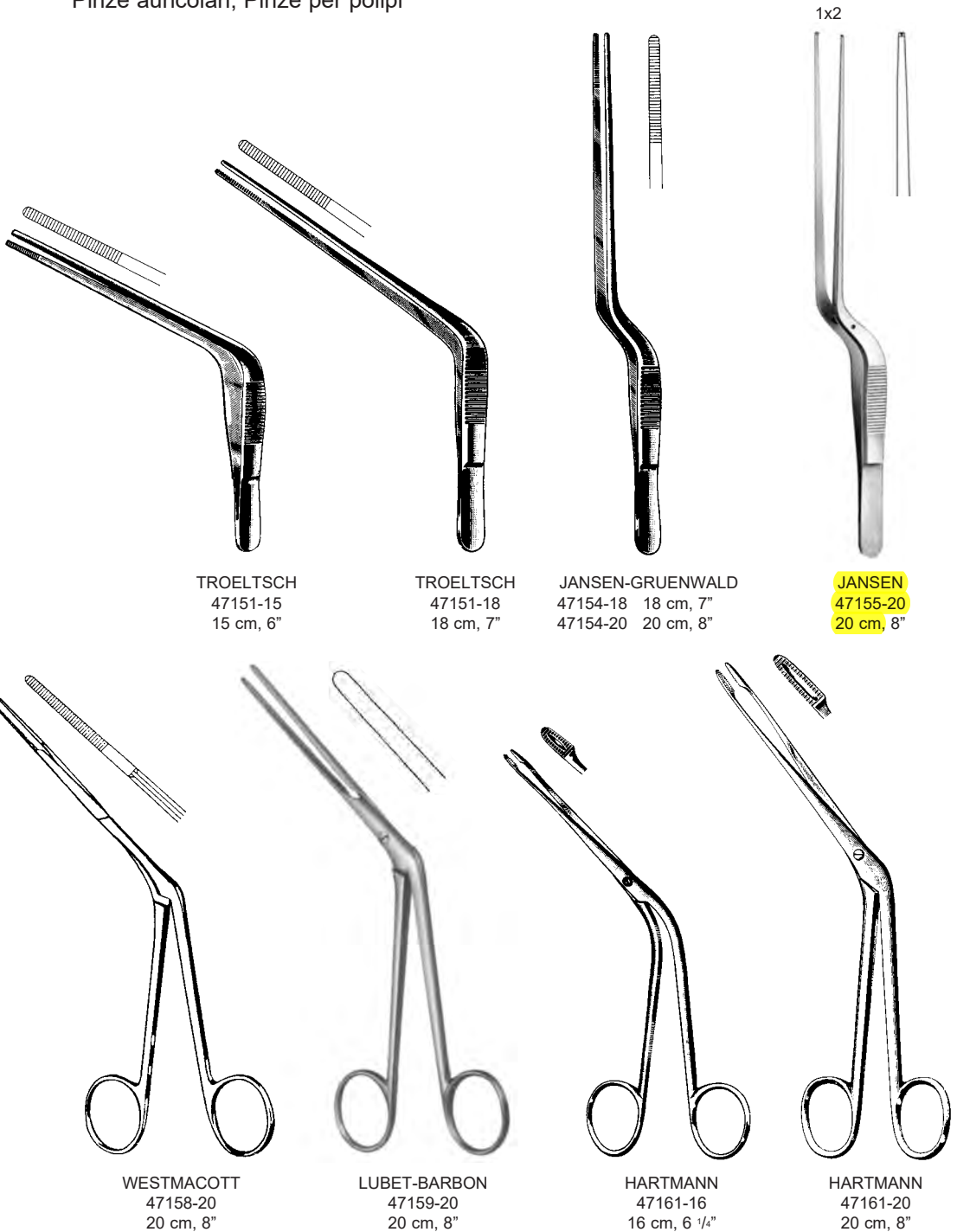

Scharfe Nasenzangen, Septumzangen  
 Nasal Cutting Forceps, Septum Forceps  
 Pinzas cortantes nasales y para el tabique nasal  
 Pinze taglianti nasali, Pinze per il setto nasale



CRAIG  
 47192-18  
 18 cm, 7"

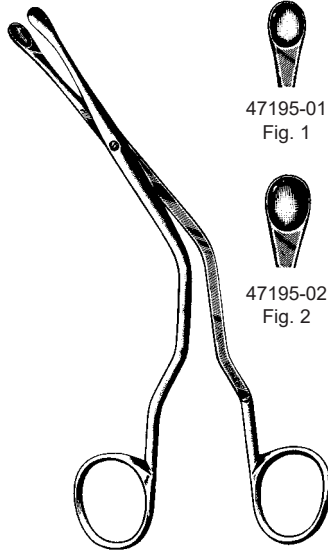

LUC  
 47195-01 - 47195-02  
 19 cm, 7 1/2"

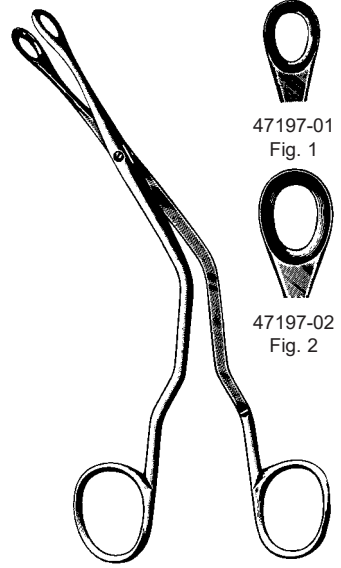

LUC  
 47197-01 - 47197-02  
 19 cm, 7 1/2"

Fig. 1	Fig. 2
47223-01	47223-02
3,0 mm	3,6 mm

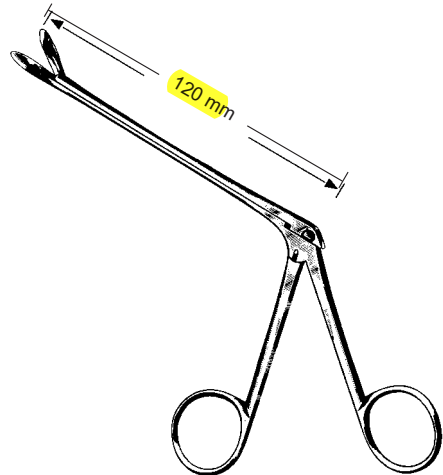
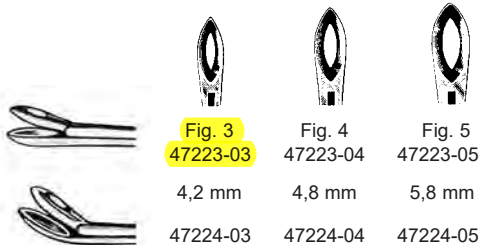
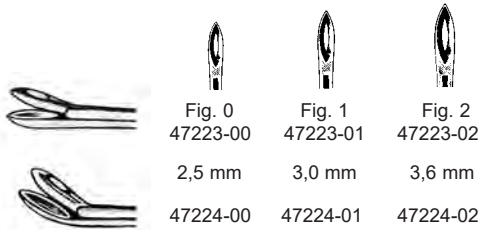

WEIL-BLAKESLEY  
 47223-01 - 47224-05

Scharfe Nasenzangen  
 Nasal Cutting Forceps  
 Pinzas cortantes nasales  
 Pinze taglianti nasali

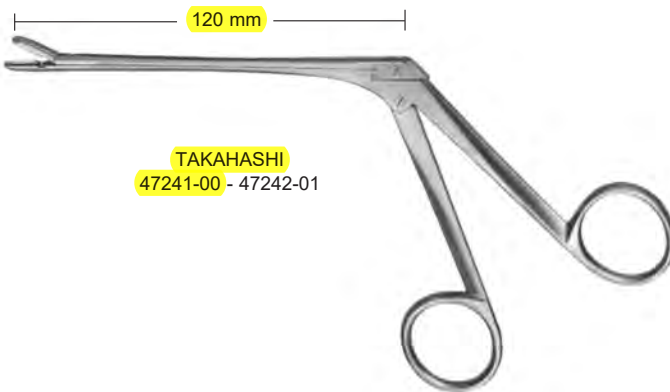
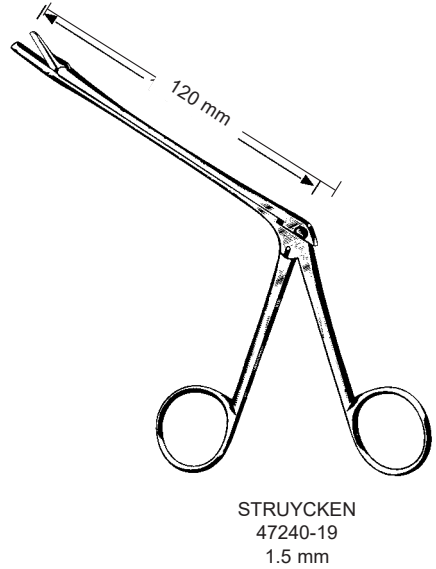
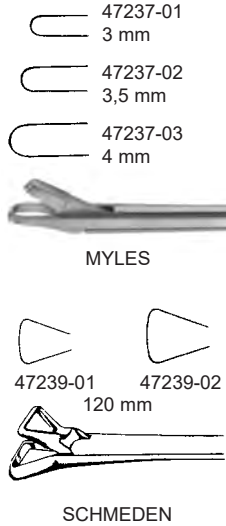
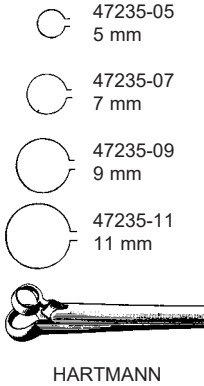

Kieferhöhlenstanze, Nasenschere  
 Antrum Punch Forceps, nasal scissors  
 Pinzas cortantes para maxilares, tijera nasal  
 Pinze sfenoidali, forbici nasali



47304-01 5x3,5 mm

47304-03 5x4 mm



47304-02 5x3,5 mm

47304-04 5x4 mm



HAJEK-KOFLER  
 47304-01 - 47304-04

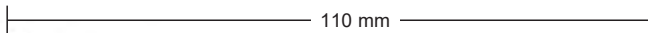

47305-02  
 rechts gebogen  
 right curved  
 curva a la derecha  
 curva a destra



47305-03  
 links gebogen  
 left curved  
 curva a la izquierda  
 curva a sinistra



47305-01  
 gerade  
 straight  
 recta  
 retta

Nasennmesser  
 Nasal Knives  
 Bisturies nasales  
 Coltelli nasali

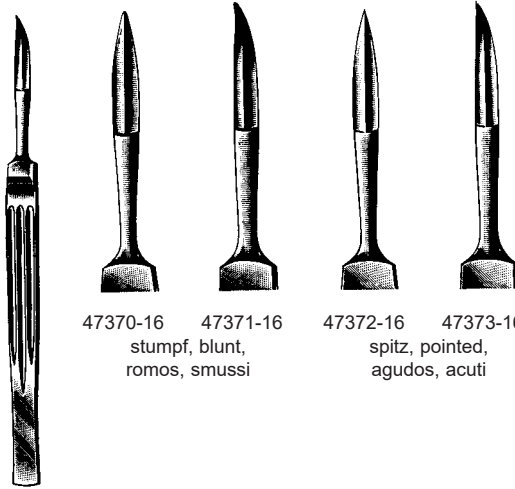

47370-16 47371-16  
 stumpf, blunt,  
 romos, smussi

47372-16 47373-16  
 spitz, pointed,  
 agudos, acuti

JOSEPH  
 47370-16 - 47373-16  
 16 cm, 6 1/4"



FREER  
 47374-16  
 16,5 cm, 6 1/2"



FREER  
 47375-19  
 19 cm, 7 1/2"

Zungendrucker, Wangen- und Lippenhalter, Zungenzangen  
 Tongue Depressor, Cheek and Lip Retractor, Tongue Holding Forceps  
 Baja-lenguas, Separadores para labios y mejillas, Pinza tira-lenguas  
 Abassalingua, Divaricatori per guance e labbra, Pinza tiralingua

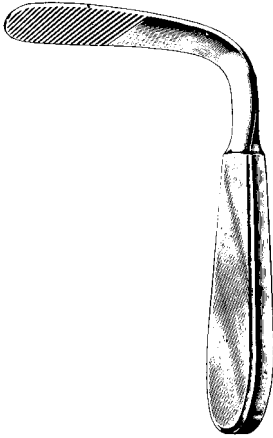

TOBOLD  
 49119-14  
 14,5 cm, 5 3/4"

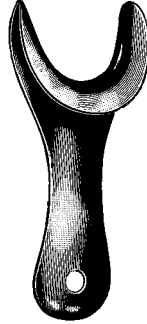

49230-11  
 11 cm, 4 3/8"

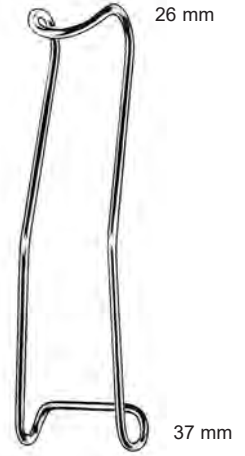

26 mm  
 37 mm  
 STERNBERG  
 49231-12 12 cm, 4 3/4"  
 49231-14 14 cm, 5 1/2"  
 49231-16 16 cm, 6 1/4"



49235-19  
 19 cm, 7 1/2"

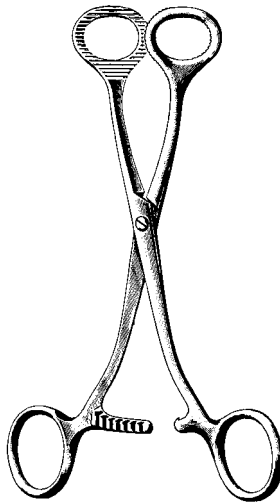

**COLLIN**  
 49250-16 16 cm, 6 1/4"  
 49250-18 18 cm, 7"

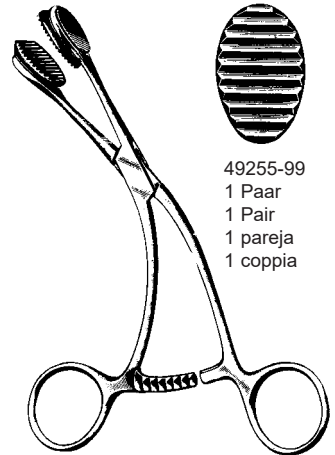

49255-99  
 1 Paar  
 1 Pair  
 1 pareja  
 1 coppia  
 YOUNG  
 49255-16  
 16 cm, 6 1/4"

Ligaturklemmen  
Ligature clamps  
Pinzas clamps para ligaduras  
Pinze per legature

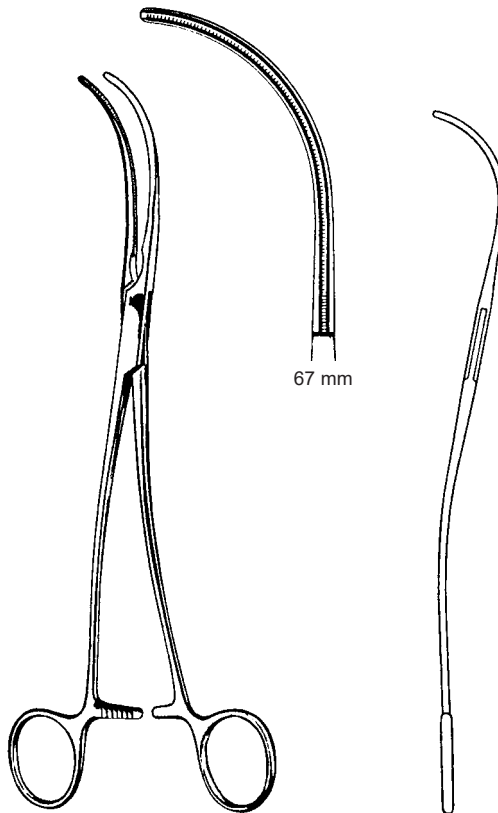

67 mm

DE BAKEY  
61022-24  
24 cm, 9 1/2"

Ligaturklemme  
Ligature clamp  
Pinzas clamps para ligaduras  
Pinze per legature

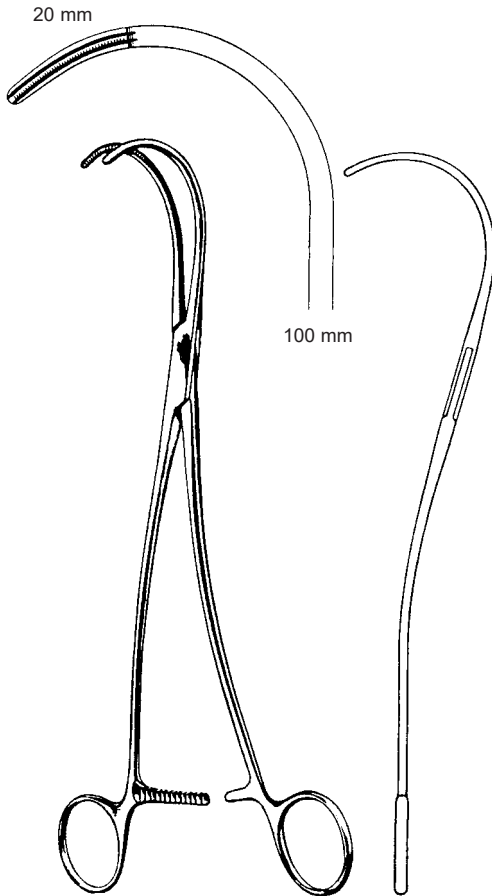

DE BAKEY  
61023-25  
25 cm, 10"

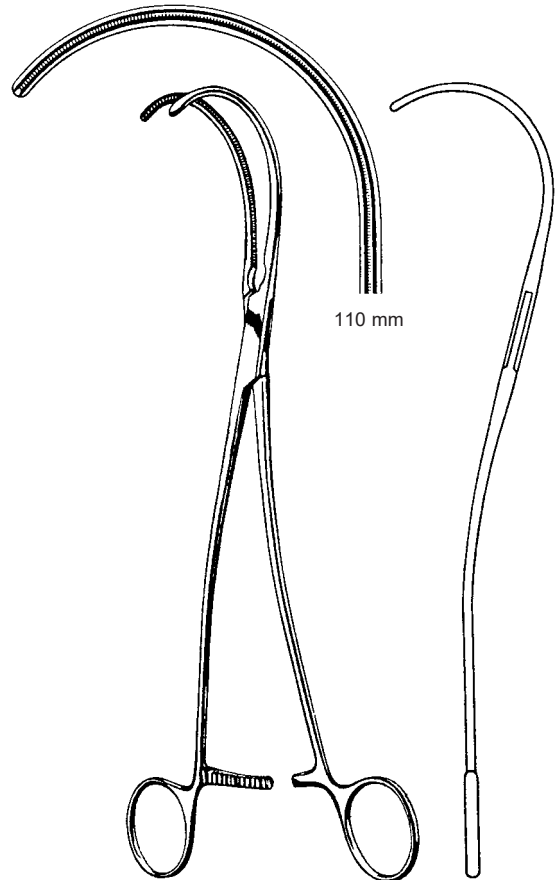

DE BAKEY  
61023-26  
26 cm, 10 1/4"

Aorta- und Aneurysmaklemme  
 Aortic- and Aneurysm Clamps  
 Pinzas aórticas y para aneurisma  
 Pinze per aorta e per aneurisma

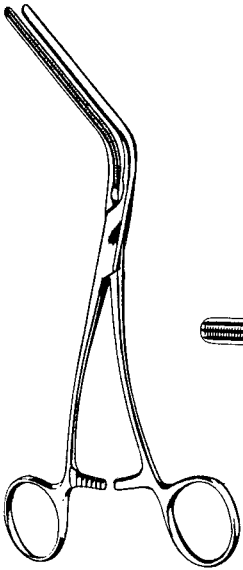

**MORRIS-DE BAKEY**  
 61032-18 - 61032-25

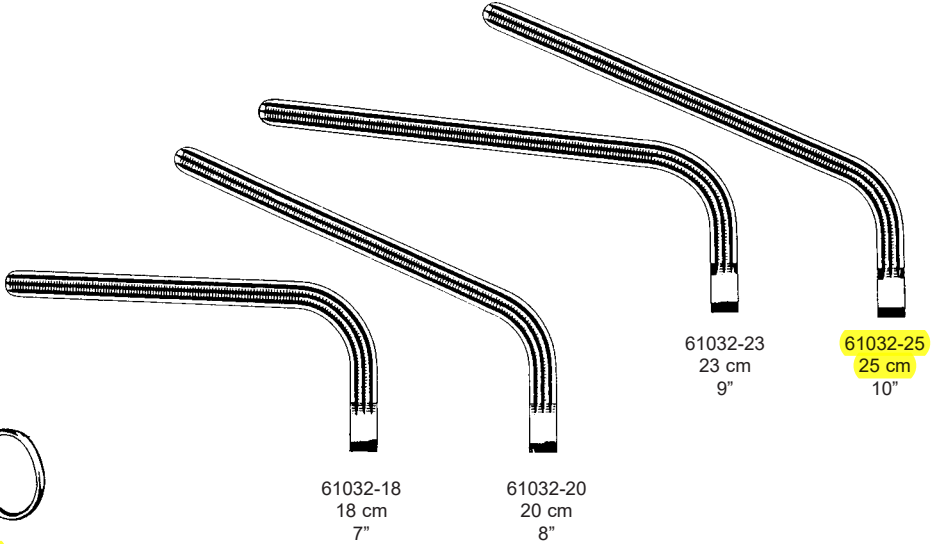

61032-18  
 18 cm  
 7"

61032-20  
 20 cm  
 8"

61032-23  
 23 cm  
 9"

61032-25  
 25 cm  
 10"

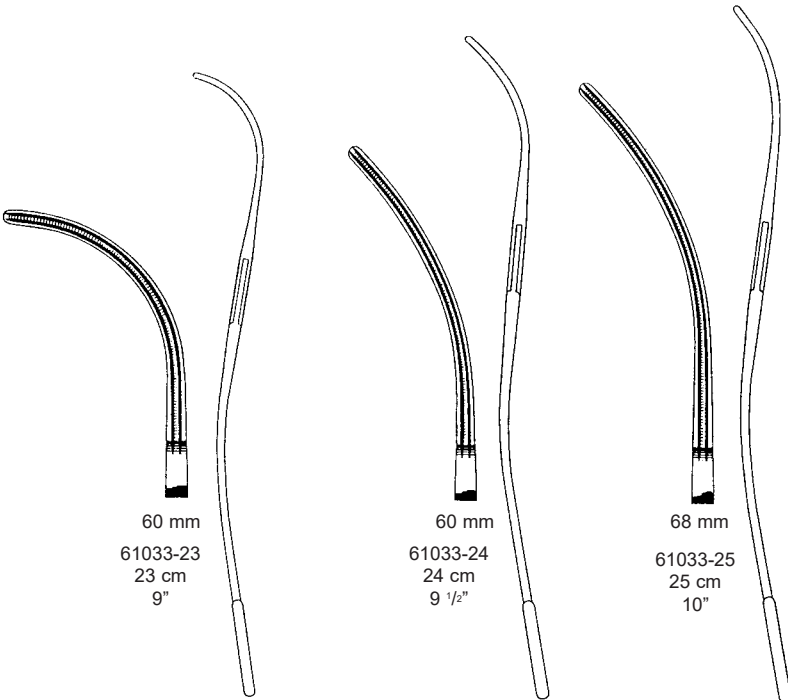

60 mm  
 61033-23  
 23 cm  
 9"

60 mm  
 61033-24  
 24 cm  
 9 1/2"

68 mm  
 61033-25  
 25 cm  
 10"

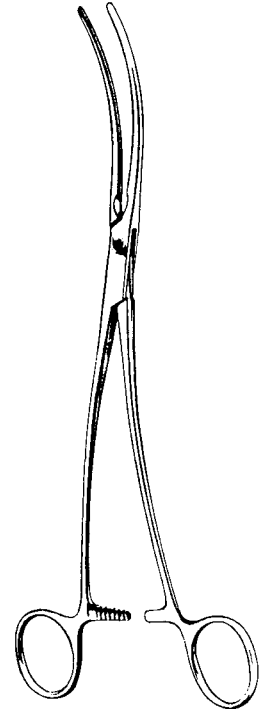

**DE BAKEY-BAHNSON**  
 61033-23 - 61033-25

## Atrauma

Mehrzweck-Gefäßklemmen, Anastomosenklemmen  
 Multi purpose Vascular Clamps, Anastomosis Clamps  
 Pinzas vasculares de usos múltiples, Pinzas para anastomosis  
 Pinze vascolari universali, Pinze per anastomosi

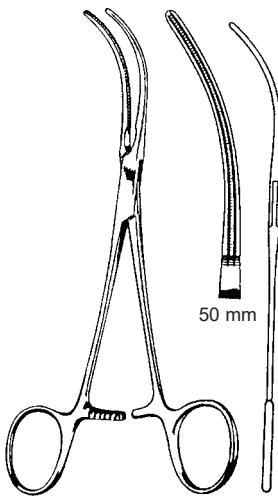

GLOVER  
 61149-17  
 17 cm, 6 <sup>3</sup>/<sub>4</sub>"

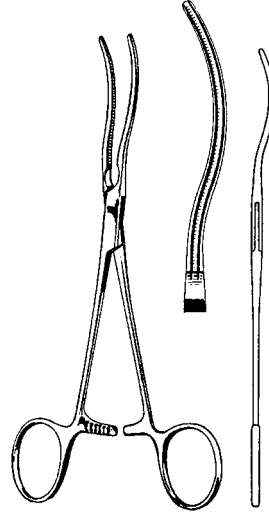

GLOVER  
 61151-17  
 17 cm, 6 <sup>3</sup>/<sub>4</sub>"

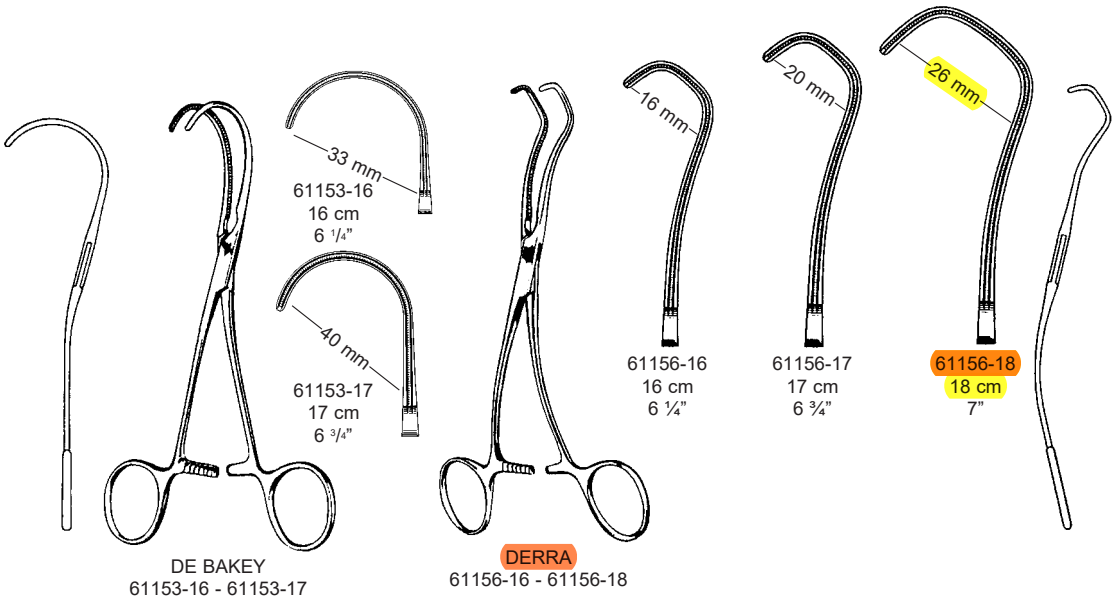

DE BAKEY  
 61153-16 - 61153-17

**DERRA**  
 61156-16 - 61156-18

Anastomosenklemmen, Kinder-Gefäßklemmen  
 Anastomosis Clamps, Pediatric Vascular Clamps  
 Pinzas para anastomosis, Pinzas vasculares pediátricas  
 Pinze per anastomosi, Pinze vascolari pediatriche

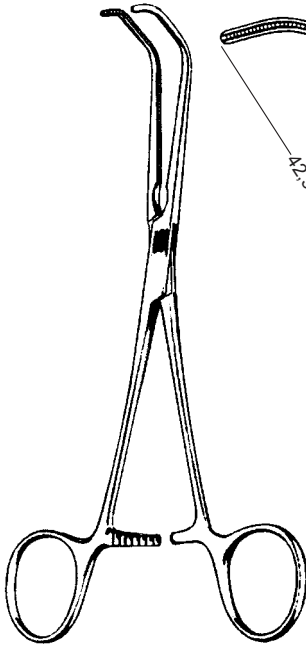

DE BAKEY-BECK  
 61157-17 17 cm, 6 <sup>3</sup>/<sub>4</sub>"

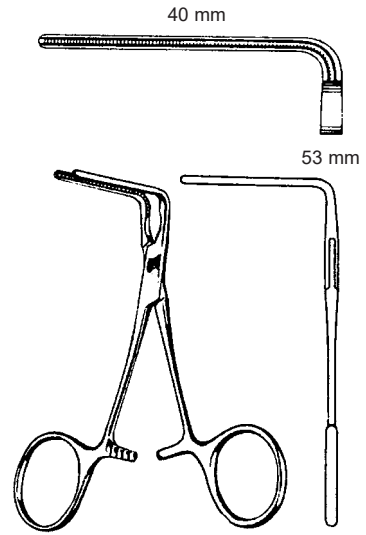

DE BAKEY  
 61158-10 10 cm, 4"

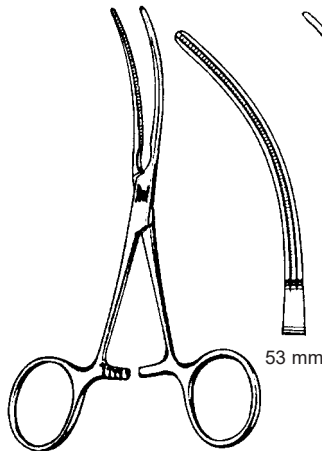

DE BAKEY  
 61158-11 11 cm, 4 <sup>3</sup>/<sub>8</sub>"

Gallensteinsonden, Gallengangdilatoren

Gall Stone Probes, **Bile duct dilators**

Exploradores para cálculos biliares, Dilatadores para conductos biliares

Sonde per calcoli biliari, Dilatatori per condotti biliari

biegsam  
malleable  
maleable  
malleabile

255 mm

Ø 1mm 63150-01	Ø 2mm 63150-02	Ø 3mm 63150-03	Ø 4mm 63150-04	Ø 5mm 63150-05	Ø 6mm 63150-06	Ø 7mm 63150-07
Ø 8mm 63150-08	Ø 9mm 63150-09	Ø 10mm 63150-10	Ø 11mm 63150-11	Ø 12mm 63150-12	Ø 13mm 63150-13	

63150-00 = Satz à 9 St. / set of 9 size 3 to 11  
juego de 9 fig. 3-11 / serie di 9 pezzi

**BAKES**  
63150-01 - 63150-13  
30 cm, 11 3/4"

Uterus Biopsiezangen  
 Biopsy Specimen Forceps  
 Pinzas sacabocado p. biopsia  
 Pinze per biopsia

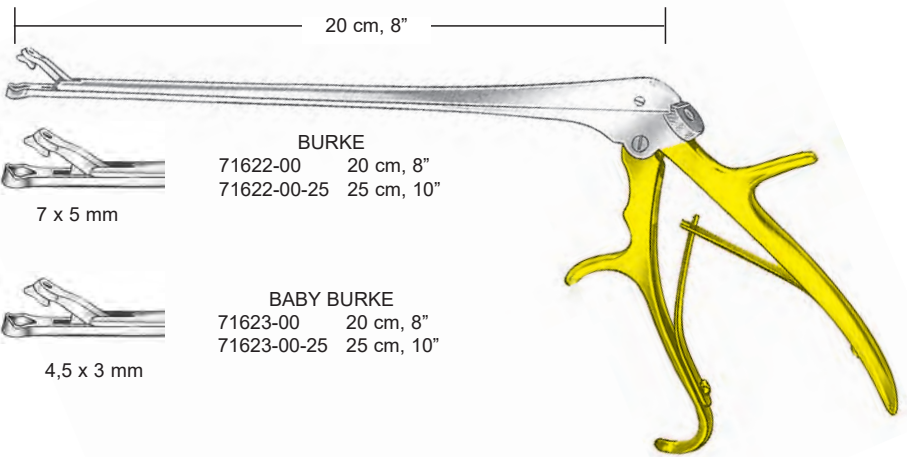
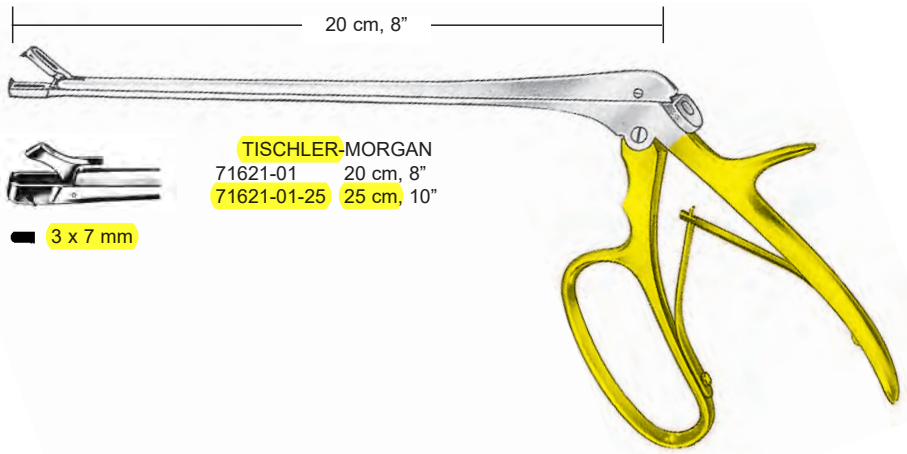
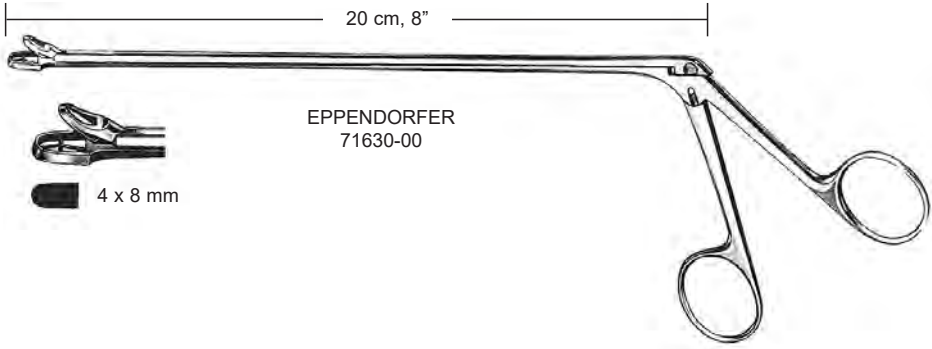

Kappenzangen, Nadel-Sterilisierkästen  
 Sterilizing Forceps, Needle Sterilizing cases  
 Combinacion tapa-pinza, Estuches para esterilizar agujas  
 Pinza coperchio, Scatole per sterilizzare aghi

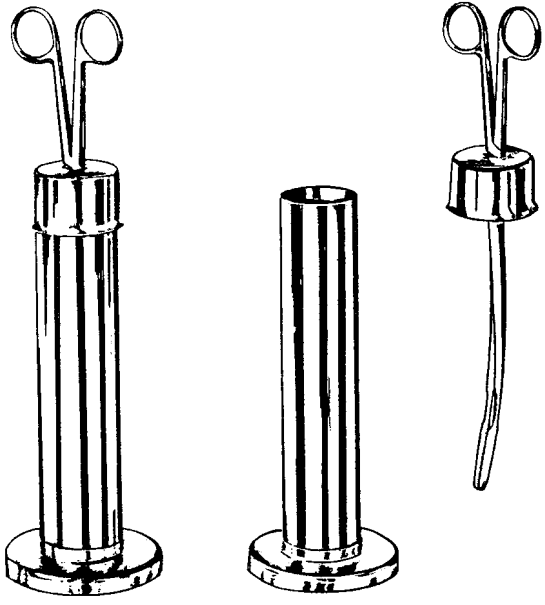

89111-25 25 cm, 10"  
 89111-32 32 cm, 12<sup>3/4</sup>"



89112-65  
 65 x 15 mm



89113-65



89114-00  
 150 x 95 x 13 mm

Schüsseln  
Bowls  
Cubetas  
Scodelle



18/10  
Stainless Steel  
Acero inoxidable  
Acciaio inossidabile

matt  
satin finish  
pulidas mate  
opaco



Abmessungen in mm sizes in mm Tamaños en mm misura in mm		Inhalt capacity capacidad capacità	
Ø x h	oz	l	
40 x 19	2	0,05	89127-04
61 x 30	3	0,07	89127-06
80 x 40	5	0,14	89127-08
116 x 50	12	0,35	89127-11
128 x 55	16	0,45	89127-12
147 x 65	25	0,70	89127-14
167 x 75	39	1,10	89127-16
187 x 85	57	1,60	89127-18

Abmessungen in mm sizes in mm Tamaños en mm misura in mm		Inhalt capacity capacidad capacità	
Ø x h	l		
100x30	0,15	89129-11	



	mm x mm	l
89133-16	165 x 60	0,75
89133-17	175 x 70	1,00
89133-22	220 x 80	2,00
89133-24	240 x 110	3,00
89133-31	310 x 120	6,00
89133-34	345 x 125	8,50
89133-38	380 x 130	11,00



89139-17	170 mm	0,25 l
89139-20	200 mm	0,35 l
89139-25	250 mm	0,5 l
89139-27	275 mm	0,75 l

Monopolare Pinzetten  
 Monopolar Forceps  
 Pinzas monopolares  
 Pinze monopolare



ohne Buchse  
 without socket  
 sin casquillo  
 senza presa



91800-18 18 cm, 7"  
 91800-21 21 cm, 8 1/4"  
 91800-25 25 cm, 10"

1 x 2 teeth



91900-18 18 cm, 7"  
 91900-21 21 cm, 8 1/4"  
 91900-25 25 cm, 10"



91801-18 18 cm, 7"  
 91801-21 21 cm, 8 1/4"  
 91801-25 25 cm, 10"

mit Buchse  
 with socket  
 con casquillo  
 con presa



Knochenhebel  
 Bone Levers  
 Elevadores para huesos  
 Elevatori per ossa

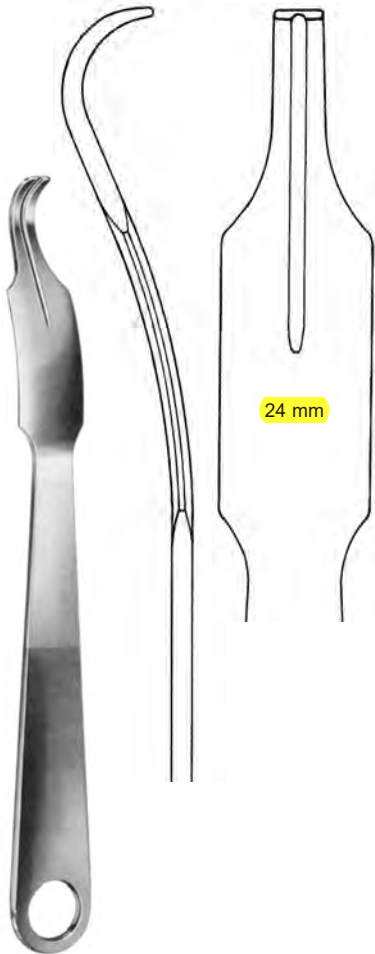

LANGE-HOHMANN  
 33810-24  
 25 cm, 10"

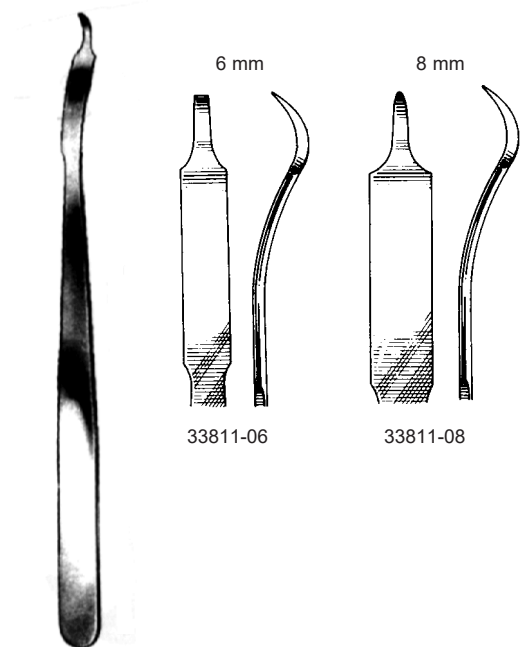

HOHMANN mini  
 16 cm, 6 1/4"

Septum Elevatoren  
Septum Elevators  
Elevadores para el tabique  
Elevatori per setto

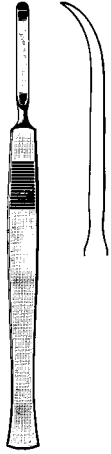

47410-04  
4 mm



47410-05  
5 mm



HALLE  
47410-16  
16.5 cm, 6 1/2"



JOSEPH  
47411-16  
16 cm, 6 1/4"

McKENY  
47410-04 - 47410-05  
15 cm, 6"

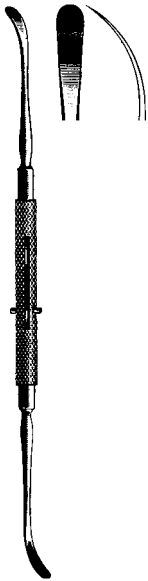

ROGER  
47413-19  
19 cm, 7 1/2"



MASING  
47414-21  
22 cm, 8 3/4"

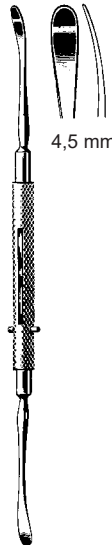

FREER  
47415-18  
18 cm, 7"

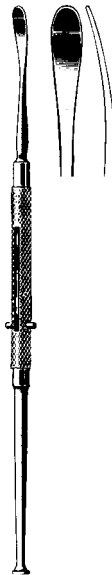

FREER  
47417-19  
19 cm, 7 1/2"

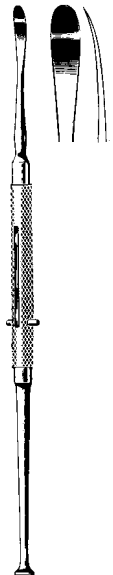

FREER  
47419-19  
19 cm, 7 1/2"

Wundsperrer  
Retractors  
Separadores  
Divaricatori



ADSON  
19682-26 - 19683-26  
26,5 cm, 10 1/2"

spitz  
sharp  
agudo  
acuto

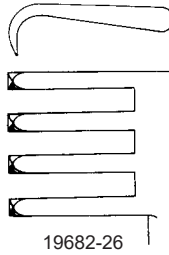

19682-26

stumpf  
blunt  
romo  
smusso

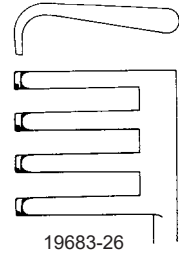

19683-26

- 19684-14 14 cm, 5 1/2"
- 19684-16 16 cm, 6 1/4"
- 19684-20 20 cm, 8"
- 19684-26 26 cm, 10 1/4"

spitz  
sharp  
agudo  
acuto

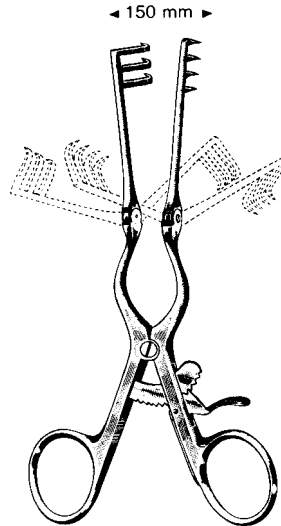

ADSON

- 19685-14 14 cm, 5 1/2"
- 19685-16 16 cm, 6 1/4"
- 19685-20 20 cm, 8"
- 19685-26 26 cm, 10 1/4"

stumpf  
blunt  
romo  
smusso

Nadelhalter  
Needle Holders  
Porta-agujas  
Port'aghi



JACOBSEN

25667-18	18 cm, 7"
25668-18 TC	18 cm, 7"
25667-21	21 cm, 8 1/4"
25668-21 TC	21 cm, 8 1/4"



CASTROVIEJO

14 cm, 5 1/2"



25670-14  
glatt  
smooth  
lisa  
liscia



25672-14  
gerieft  
serrated  
estriada  
zigrinato



25676-14 TC



25671-14  
glatt  
smooth  
lisa  
liscia



25673-14  
gerieft  
serrated  
estriada  
zigrinato



25677-14 TC



25678-09



25679-09



CASTROVIEJO-MICRO

9 cm, 3 1/2"



CASTROVIEJO

25680-13	13 cm, 5 1/8"
25684-13 TC	13 cm, 5 1/8"

Nadelhalter  
Needle Holders  
Porta-agujas  
Port'aghi



DE BAKEY

25214-16 TC	16 cm, 6 <sup>1</sup> / <sub>4</sub> "
25214-18 TC	18 cm, 7"
25214-20 TC	20 cm, 8"
25214-23 TC	23 cm, 9"
25214-26 TC	26 cm, 10 <sup>1</sup> / <sub>4</sub> "
25214-31 TC	31 cm, 12 <sup>1</sup> / <sub>4</sub> "



RYDER 1 mm

25224-13 TC	13 cm, 5 <sup>1</sup> / <sub>8</sub> "
25224-15 TC	15 cm, 6"
25224-18 TC	18 cm, 7"
25224-20 TC	20 cm, 8"
25224-23 TC	23 cm, 9"
25224-26 TC	26 cm, 10 <sup>1</sup> / <sub>4</sub> "

RYDER 2 mm

25225-13 TC	
25225-15 TC	
25225-18 TC	
25225-20 TC	
25225-23 TC	
25225-26 TC	

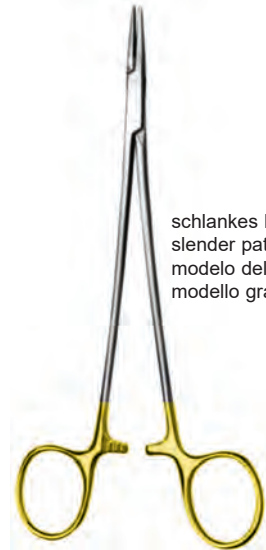

schlankes Modell  
slender pattern  
modelo delgado  
modello gracile

MICROVASCULAR

25230-18 TC	18 cm, 7"
25230-20 TC	20 cm, 8"
25230-23 TC	23 cm, 9"

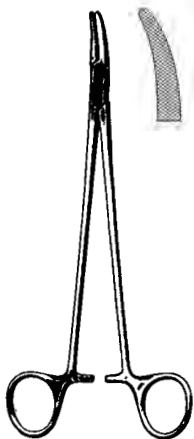

HEANEY

25241-21	21 cm, 8 <sup>1</sup> / <sub>4</sub> "
25241-26	26 cm, 10 <sup>1</sup> / <sub>4</sub> "
25245-21 TC	21 cm, 8 <sup>1</sup> / <sub>4</sub> "
25245-26 TC	26 cm, 10 <sup>1</sup> / <sub>4</sub> "

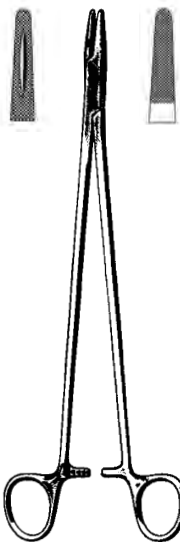

MASSON

25250-27	27 cm, 10 <sup>1</sup> / <sub>2</sub> "
25254-27 TC	27 cm, 10 <sup>1</sup> / <sub>2</sub> "

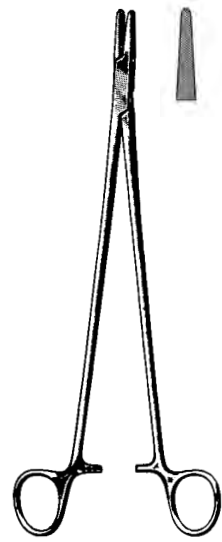

WANGENSTEEN

25260-27	27 cm, 10 <sup>1</sup> / <sub>2</sub> "
25264-27 TC	27 cm, 10 <sup>1</sup> / <sub>2</sub> "

Wundsperrer, Kieferhöhlensperrer  
 Retractors, Antrum Retractor  
 Separadores, Separadores para seno maxilar  
 Divaricatori, Divaricatori per seno mascellare

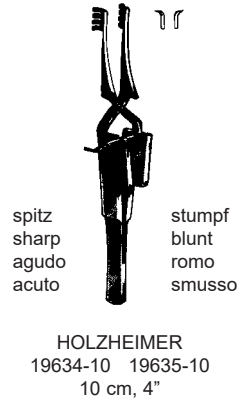
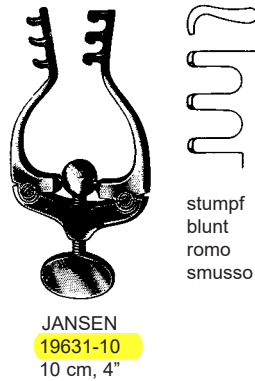
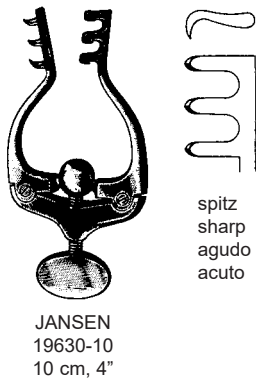
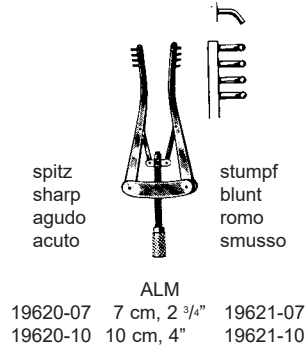
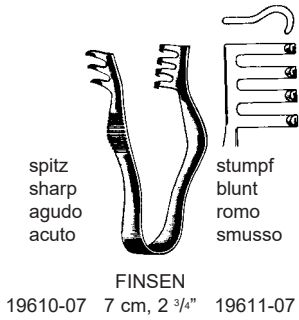

Gynäkologische Scheren  
Gynecological Scissors  
Tijeras ginecológicas  
Forbici ginecologiche

Parametriumscheren - Parametrium scissors - Tijeras para parametrio - Forbici per parametrio



REDA

09505-23 TC	23 cm, 9"
09505-26 TC	26 cm, 10¼"
09505-30 TC	30 cm, 12"



09507-23 TC	23 cm, 9"
09507-26 TC	26 cm, 10¼"
09507-30 TC	30 cm, 12"



WERTHEIM

09525-22 22,5 cm, 8,9"



DOYEN

09530-17 09531-17  
17,5 cm, 6,9"



DUBOIS

09536-27 09537-27  
27 cm, 10½"

Nierensteinzange  
Kidney Stone Forceps  
Pinzas para cálculos renales  
Pinze per calcoli renali



**HEIMING**

für Kinder  
for children  
para niños  
per bambini



**63232-01**  
17 cm, 6 3/4"



**63232-02**  
16 cm, 6 1/4"

Präparierscheren  
Dissecting Scissors  
Tijeras de disección  
Forbici per dissezione

**NOIR**



METZENBAUM



09281-15B  
14,5 cm, 5¾"



09281-18B  
18 cm, 7"



09281-20B  
20 cm, 8"



09283-18B  
18 cm, 7"

fein  
delicate  
fina  
delicate

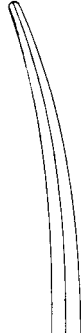





09283-20B  
20 cm, 8"

fein  
delicate  
fina  
delicate

Scheren, Thorax und GefäÙe  
 Scissors, thorax and vascular  
 Tijeras, torácicas y vasculares  
 Forbici vascolari e toraciche



DIETRICH  
 09475-25 – 09475-00







		
09475-25 09476-25 TC 18 cm, 7"	09475-45 09476-45 TC 18 cm, 7"	09475-60 09476-60 TC 17,5 cm, 6,9"
		
09475-90 09476-90 TC 17 cm, 6¾"	09475-00 09476-00 TC 17 cm, 6¾"	



DIETRICH  
 09477-01  
 17 cm, 6¾"



DE BAKEY  
 (POTTS-SMITH)

		
09478-25 19 cm 7½"	09478-45 19 cm 7½"	09478-60 19 cm 7½"
		
09479-25 23 cm 9"	09479-45 23 cm 9"	09479-60 23 cm 9"

Gefäßscheren  
Vascular Scissors  
Tijeras vasculares  
Forbici vascolari

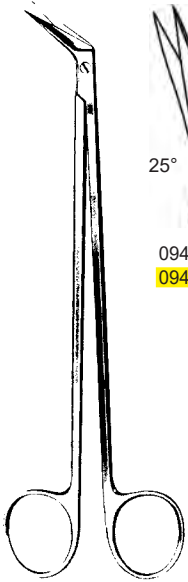

POTTS-SMITH  
19 cm, 7½"

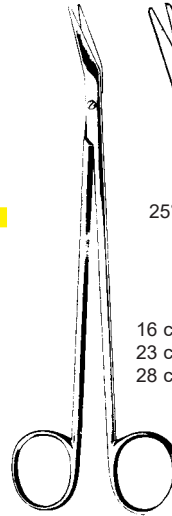
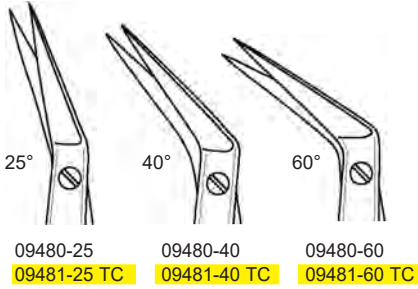

DE BAKEY

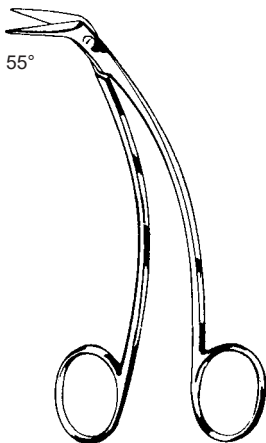
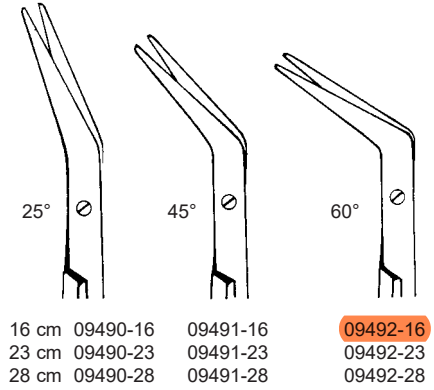

FAVALORO  
09496-15    15 cm, 6"

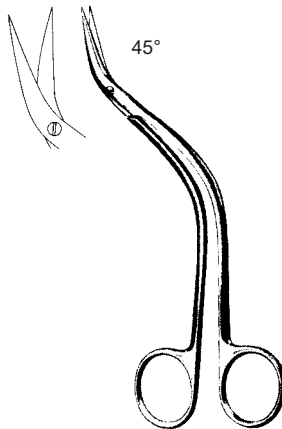

DE BAKEY  
09497-15    15,5 cm, 6"



KELLY  
09540-16    09541-16  
**09542-16 TC**    **09543-16 TC**  
 16 cm, 6¼"

Atrauma-Bulldogklemmen  
**Atrauma Bulldog Clamps**  
 Clamps Atrauma Bulldog  
 Pinze Atrauma Bulldog



DE BAKEY

13092-07  
7,5 cm  
3"

**13092-08**  
**8,5 cm**  
**3.4"**

13092-10  
10,5 cm  
4"

13092-12  
12 cm  
4 ¾"

**13093-07**  
**7 cm**  
**2 ¾"**

**13093-08**  
**8 cm**  
**8 ⅛"**

**13093-10**  
**10 cm**  
**4"**

13093-12  
11,5 cm  
4 ½"

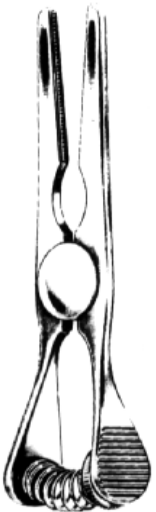

GLOVER

13096-06  
6 cm  
2 ¼"

13096-07  
7 cm  
2 ¾"

13096-09  
9 cm  
3 ½"

13096-11  
11 cm  
4 ¾"

13097-06  
5,5 cm  
2"

13097-07  
6,5 cm  
2 ½"

13097-09  
8,5 cm  
3 ¼"

13097-11  
10,5 cm  
4"

Aorta-Aneurysmaklemmen  
 Aortic aneurysm clamps  
 Pinzas-clamps para aneurisma de la aorta  
 Pinze per aneurisma aorta

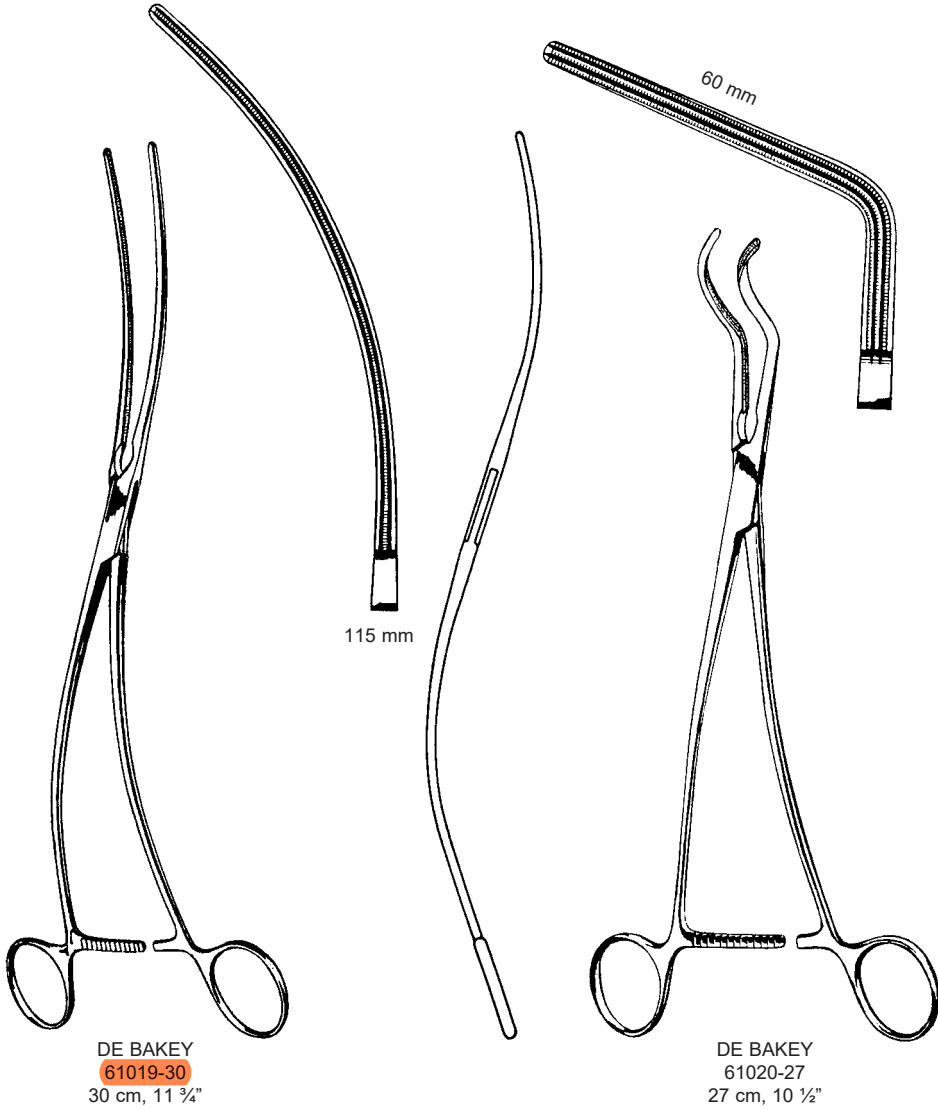

Mini-Bulldogklemmen  
 Mini Bulldog Clamps  
 Clamps Bulldog Mini  
 Pinze Bulldog Mini

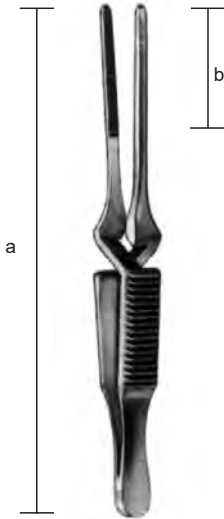

DIETHRICH

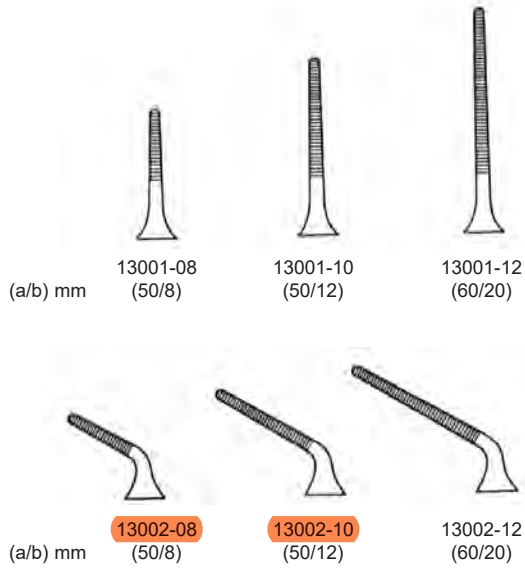

**Atrauma**

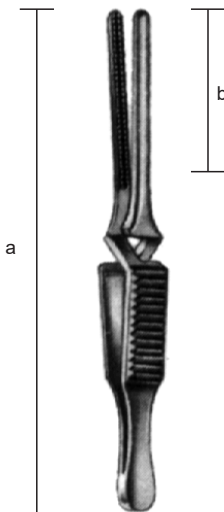

DEBAKEY-DIETHRICH

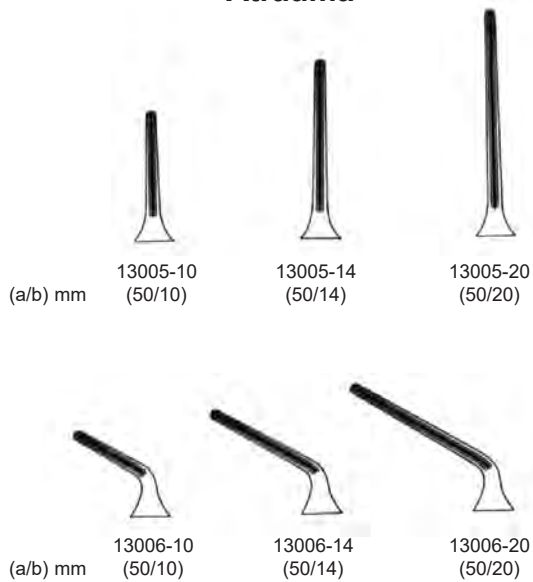

Ultra-Light-Pinzetten  
 Ultra-Light-Forceps  
 Pinzas-Ultra-Ligera  
 Pinza-ultra-leggera

1,5 mm



1,5 mm



1,5 mm



1,2 mm

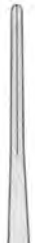

1/1



1/1



1/1



1/1

**12110-15**  
 15 cm, 6"

12110-20  
 18 cm, 7"

12110-24  
 24 cm, 9½"

12110-30  
 30 cm, 11¼"



Weitere Kataloge und Prospekte  
Other catalogues and prospects

HNO / Sinuskopie  
ENT / Sinuscopy

Sterilisations Behälter  
Sterilization Container System

Endoskopie  
Endoscopy

Urologie / Arthroskopie  
Urology / Arthroscopy

Plastische Chirurgie  
Plastic surgery

Orthopädie  
Orthopedic

Titan Instrumente  
Titanium Instruments

Neurochirurgie  
Neurosurgery

REDA Instrumente GmbH  
Gänsäcker 34, D-78532 Tuttlingen  
Tel: 0049 (0) 7462 9445 0  
Email: [info@reda-instrumente.de](mailto:info@reda-instrumente.de)  
Web: [www.reda-instrument.de](http://www.reda-instrument.de)