

General Purpose Electrical Hospital Beds

REF: WANS 4040



Schröder™

INSTRUCTION FOR USE



General Purpose Hospital Bed

REF : WANS 4040

Instructions for use and Technical

Document Number: KK-27

Revision: 01 /03.01.2020



PROMA MEDİKAL LİMİTED ŞİRKETİ
BAŞPINAR ORGANİZE OSB MAH.OSB 5. BÖLGE 83548
CAD.NO:6 ŞEHİTKAMİL GAZİANTEP/TURKEY

Web: www.schroderhealth.de / www.schroder.com.tr















E-mail: info@schroder.com.tr

Tel : +90 850 202 77 50

Fax : +90 850 202 77 50

All commercial rights and trademarks are property of the manufacturing firm. The manufacturer reserves its right to make modifications in the contents of this manual referring to any revisions and arrangements of the bed.

1. SYMBOLS AND DEFINITIONS

	Refer to instruction manual / booklet
	Operating instruction
	CE Mark
	General Warning Sign
	Caution
	Safe Working Load
	Max. Patient Weight
	In accordance with European Directive 2002/96/EC on Waste Electrical and Electronic Equipment, this symbol indicates that the product must not be disposed of as unsorted municipal waste, but should be collected separately. Refer to the collection systems available in your country.
	Manufacturer
	Alternating Current
	Direct Current
	Type B Applied Part
	Warning Crushing of Hands
	Protective Earth









	Equipotentiality
	Serial Number
	Catalogue Number / Model name
	Atmospheric Pressure Limitation
	Temperature Limit
	Humidity Limitation
IPX4	Protected against splashing of waters
	Fragile ,Handle With Care
	Keep Dry
	Medical – General Medical Equipment Classified by ELDAŞ Laboratories Inc. with Respect to Electrical Shock, Fire and Mechanical Hazards Only in accordance with : IEC 60601-1:2005 3rd edition, ANSI/AAMI ES60601-1:2005, CAN/CSA C22.2 No. 60601.1:08, IEC60601-1-2:2007 3 rd edition, IEC 60601-2-52:2009, *For WANS 4040 option , Associated Equipment of X-Ray Equipment IEC 60601-2-54 CCN: E4664217
	Recyclable Material

TABLE OF CONTENTS

1. SYMBOLS AND DEFINITIONS	3
2. INTRODUCTION	7
2.1 PRODUCT DESCRIPTION	7
2.2 INTENDED USE OF PRODUCT	8
2.2.1 Intended Medical Indications	8
2.2.2 Intended Patient Population	8
2.2.3 Intended Part of the Body	8
2.2.4 Intended User Profile	8
2.2.5 Intended Condition of Use	8
2.2.6 Operating Principle	8
2.3 EXPECTED SERVICE LIFE	9
2.4 CONTRAINDICATIONS	9
2.5 SPECIFICATIONS	10
2.5.1 Features	10
2.5.2 Control Box Features	11
2.5.3 Battery Features	11
2.5.4 Actuator Features	12
2.5.5 Standards Applied	12
2.5.6 Environmental Conditions of Bed for Usage, Storage and Transportation	12
2.6 PRODUCT ILLUSTRATION	13
2.6.1 General Parts of Product	13
2.6.2 Type B Applied Parts	14
3. SUMMARY OF SAFETY PRECAUTIONS	15
3.1 WARNING / CAUTION / NOTE DEFINITIONS	15
3.2 WARNINGS	15
3.3 CAUTIONS	16
3.4 PINCH POINTS	17
4. OPERATION GUIDE	18
4.1 INSTALLATION OF THE BED	18
4.2 CONNECTION OF THE BED TO MAINS	18
4.3 CHARGE OF THE BATTERY BED AND BATTERY LIFE	18
4.4 HOW TO OPERATE THE BED	19
4.4.1 Nurse and Patient Hand Control Pendant	19
4.4.2 Side rail Control Pendant	19
4.4.3 Nurse Control Pendant	20
4.4.4 Manual Control Systems	21
4.4.4.1 Manual Control of CPR Release Mechanism on Backrest	21
4.4.4.2 Manual Control of Foot Section Height Adjustment	21
4.4.4.3 Manual Control of Side rails	22
4.4.4.4 Manual Mounting of Bed Head Board & Foot Board	22
4.4.4.5 Manual Bed Extension Kit (Optional)	23

4.4.4.6 Bed Platform Extensions	23
4.4.4.7 Castors Locking Mechanism	24
5. ACCESSORIES AND OPTIONS	25
5.1 ACCESSORIES	25
5.1.1 IV Pole	25
5.1.2 Patient Lifting Pole	25
5.1.3 Urine Bottle Basket	26
5.1.4 Traction Set	26
5.1.5 Oxygen Cylinder Holder	26
5.1.6 Fastening Belt for Chest	27
5.1.7 Fastening Belt for Arm /Foot	27
5.1.8 File Holder	27
5.2 OPTIONS	28
5.2.1 Mattress	28
5.2.2 Radiolucent Backrest /Cassette Holder	28
5.2.3 Under Bed Light	29
5.2.4 Bed Extension Kit	29
5.2.5 SLS Brake Alarm System	29
5.2.6 Castors	29
5.2.7 Hand Control Pendant	30
5.2.8 Side rail Control Pendant	30
5.2.9 Shelf for Bed Linen	30
6. BED CLEANING	31
6.1 PRE-CLEANING REQUIREMENTS	31
6.2 APPROVED CLEANERS	31
6.3 APPROVED CLEANING PROCESS	31
6.4 SIDE RAIL CLEANING	32
7. PREVENTATIVE MAINTENANCE AND CHECKLIST	32
7.1 CHECKLIST	33
8. ELECTRICAL FEATURES (EMC/EMI INFORMATION)	35
8.1 GUIDANCE AND MANUFACTURER'S DECLARATION – ELECTROMAGNETIC EMISSION	35
8.2 GUIDANCE AND MANUFACTURER'S DECLARATION – ELECTROMAGNETIC IMMUNITY	36
9. WARRANTY AND SERVICE	39
9.1 WARRANTY	39
9.2 TECHNICAL SERVICE	39
10. TROUBLESHOOTING	40
11. ENVIRONMENTAL PROTECTION	41
12. SERVICE MAINTENANCE REPAIR CHART	42

2. INTRODUCTION

This Instruction for Use is designed to assist the user with the operation of Schroder WANS Model General Purpose Hospital Bed. The user is required to read and understand this Instruction for Use thoroughly before starting to operate the product. The product is to be used strictly according to this Instruction for Use. Any use of the product that does not comply with the recommendations or requirements of this Instruction for Use may cause a risk to the user or patient. In such cases, the manufacturer does not accept responsibility or liability for any resulting risk.

2.1 PRODUCT DESCRIPTION

The Schroder General Purpose Hospital Bed, Model WANS, is designed for patients to receive treatment for extended periods of time at hospitals and care centers. The product has four electrical actuators that allow it to adjust to numerous positions including CPR, trend, reverse trend and chair positions. The product is equipped with retractable side rails, removable head board and foot board, as well as various options and accessories that assist with the care of the patient.

The Schroder WANS and its accessories, henceforth referred as the bed, or the product is designed and manufactured as per the international norms TS-EN-60601-2-52, TS-EN-60601-1 3rd Edition, standard 93/42/EEC and 89/336/EEC. The manufacturer manufactures according to the quality management system standards ISO 9001:2008, ISO 13485:2004 and FDA 21 CFR 820.

Available Options Include The Following:

- Electronic Scale system
- Bed Extension Kid
- Radiolucent Backrest / Cassette Holder
- Mattress
- Hand Control Pendant *
- Side rail Control Pendant *
- Under Bed Light
- Shelf for Bed Linen
- Castors (Single or Twin)
- SLS Brake Alarm System

*At a minimum, each bed must have at least one of these control pendants

Available Accessories Include The Following:

- IV Pole(s)
- Lifting Pole
- Urine Bottle Basket
- Stainless Steel Orthopedic Extension System
- Oxygen Cylinder Holder
- Fastening Belt for Chest
- Fastening Belt for Arm / Foot
- File Holder

2.2 INTENDED USE OF PRODUCT

2.2.1 Intended Medical Indications:

The Schroder WANS 4040 bed is an AC-powered adjustable hospital bed designed to position human patients for procedures, therapy, and recovery in a healthcare environment; as well as transport patients between bays and procedural rooms. The bed offers various positions including Trendelenburg, Reverse Trendelenburg, chair position and CPR position. There is also an optional radiolucent backrest to aid with x-ray imaging. An optional bed extension increases the litter length from 220 to 238 cm to accommodate taller patients. Additional options and accessories include IV pole, lifting pole, bed extension kit, radiolucent backrest/cassette holder, mattresses, , hand control pendant, side rail control pendant, urine bottle basket, orthopedic bed extension system, oxygen cylinder holder, fastening belt for chest, fastening belt for arm/foot, under bed light, shelf for bed linen, file holder, castors and SLS brake alarm system.

2.2.2 Intended Patient Population:

The Schroder WANS 4040 bed is intended for use by patients in a MedSurg and ICU setting requiring the support of a hospital bed. The safe working load (i.e. the sum of the patient, mattress, and accessory weights) for WANS 4040 is 270 kg (595 lbs). The patient shall be over the age of 2, taller than 90 cm (35 in) and weigh more than 9 kg (20 lbs).

2.2.3 Intended Part of the Body:

The Schroder WANS 4040 bed frame, litter mounted accessories and mattresses can come in contact with human skin. The bed frame should never be used without the specified mattress. The Schroder WANS 4040 bed is intended to support a human patient.

2.2.4 Intended User Profile:

The intended users for Bed are - Health Care Providers (HCPs: nurses, nurses' aides, and medical doctors) which can use all bed operations (e.g., bed movements, motion functions, nurse call and other options), and patient lift pole, service/maintenance personal who are professionally trained to carry out routine cleaning/maintenance/ repairs for bed and bystanders who can use bed motion functions.

2.2.5 Intended Condition of Use:

Bed is intended to be used in a medical, surgical, and critical care healthcare environment, including hospitals, institutions and clinics. The Intended environmental conditions are; 5 to 40 degrees Celsius for temperature, 20 to 90% RH @ 30 degrees Celsius for relative humidity and 800 hPa to 1060 hPa for atmospheric pressure. The bed is intended to be used in Application Environments 1, 2, 3 and 5 (ref. IEC 60601-2-52). Bed surfaces to be cleaned in accordance with instructions in the Information for Use. Bed is compatible with Schroder approved support surfaces only (mattress dimension (900 x 2000 mm) (35.4 x 78.7 in)). Bed is intended for a 10 year expected service life under normal use, conditions, and with appropriate periodic maintenance.

2.2.6 Operating Principle:

The Schroder WANS 4040 bed is an electromechanical MedSurg bed with DC-powered actuators and controls to adjust the patient sleep surface. The patient sleeping surface consists of 4 sections (back rest, seat, upper leg rest, foot rest section). Electromechanical functions can be actuated by pendant controls and controls on front side rails. The bed is equipped with 2 pairs of actuators (4 actuators total). The first pair is located below the litter surface for back section down function, back section up function, leg down function, leg up function. The second pair of actuators is present at undercarriage which is used for mattress support platform down, mattress support platform up, trendelenburg and reverse trendelenburg functions. The bed has arrangement for manual CPR, knee Gatch motion, and bed length extension. The control box which consists of power supply and logic controls gives power and control signals to all 4 actuators via a distribution box. Side rail controls and pendant controls are also controlled by control box via distribution box. Side rails are split with two side rails on the head-end and two side rails on the foot-end. The side rails are secured in the up position via a latching mechanism. When unlatched, side rails open outside and go to the full down position. The bed is equipped with brake and steer control for the castors. Castors help in emergency or non-emergency intra-hospital transport of patient on bed by manual push.

2.3 EXPECTED SERVICE LIFE

The expected service life of the bed is 10 years only under normal use conditions and when appropriate periodic maintenance of bed is performed in accordance with the requirements and recommendations in this Instruction for Use.

2.4 CONTRAINDICATIONS

- This product is not intended for use in a home healthcare environment.
- This product is not intended for use without a specified mattress.
- This product is not intended for use with an oxygen tent.
- This product is not intended for use in the presence of flammable anesthetics.
- This product is not intended to support more than one individual at a time.

2.5 SPECIFICATIONS

2.5.1 Features

Features	WANS 4040
Total Length	2200mm
Patient Surface Length	1950mm
Extended Length (Bed extension kit is option)	2400mm
Total Width	1000mm
Patient Surface Width	850mm
Bed Height (Without Mattress)	390mm – 800mm
Trendelenburg / Reverse Trendelenburg Angle	0 – 17°
Backrest Maximum Angle	70°
Leg Rest Maximum Angle	40°
Clearance Under The Bed	150mm
Castors Diameter	150mm
Bed Weight (kg)	≤100 kg
Max Patient Weight (kg)	215 kg
Safe Working Load (kg) (Safe working load indicates the sum of the patient, mattress and accessory weight)	270 kg
Battery	Optional
Nurse Control pendant	Optional
Manual CPR	Optional
Mattress Dimensions (Optional)	1) 120 mmx900 mmx2000 mm ,32 density, slotted 2) 120 mmx900 mmx2000 mm, 32 density, fire retardant, slotted 3) 140 mmx900 mmx2000 mm, 55-60 density 4 cm height memory foam,32 density 8 cm height foam
Radiolucent Backrest And X-Ray Cassette Carrier 40*55cm	Optional
Shelf for bed linen	Optional
IV Pole	Optional accessories
Lifting Pole	Optional accessories
Bed Extension Kit	Optional
Urine Bottle Basket	Optional accessories
Orthopedic Extension System	Optional accessories
Oxygen Cylinder Holder	Optional accessories
Fastening Belt For Chest	Optional accessories
Fastening Belt For Arm / Foot	Optional accessories
Under Bed Light	Optional
File Holder	Optional accessories
Castors (optional)	Single Castors/Twin Castors
SLS Brake Alarm System	Optional
Side Rail Control Pendant	Optional
Hand Control Pendant	Optional
Ingress Protection Rating of Product	IPX4 , IPX6

SPECIFICATIONS (CONTINUED)



WARNING

In order to minimize risk of any electromagnetic interference, the bed is designed as per the standard IEC 60601-1-2. To avoid such problems, the bed should be used in accordance with the EMC/EMI requirements in section 8 of this "instructions of use".

Noise level must not exceed 80 db while electrical components of the bed are in motion.

WANS 4040 bed power in 330 VA , 5 A , in put voltage 100 V AC– 240 V AC , frequency : 50/60 Hz , WANS 4040 can only be connected to a supply network with protective earthing .

2.5.2 Control Box Features

Manufacturing Firm	LINAK
Model	CB6
Input voltage	210 V AC– 220 V AC
Frequency	50/60 Hz
Power	330 VA
Input Current max:	5 A
Output Current max:	8 A
Output Voltage	24 V DC
Fuse	1.5 A max
Class	II
Applied Part Type	B

2.5.3 Battery Features (OPTIONAL)

Manufacturing Firm	LINAK
Model	BA1812
Class	II
Output Voltage – Output Max. Current	24 V DC - 10 A
Rated Capacity	1,2 Ah 24VDC
Charging Current	Max 0,3 A
Charging time	10 ~ 12 hours
Safe operating temperature	+5 ⁰ C +40 ⁰ C



WARNING

- The battery must be replaced after it completes its lifetime. Battery has a 2 year expected life under normal use conditions.
- Dead battery must not be opened.
- Do not throw the battery into fire.
- Do not spill liquid on battery or submerge battery in liquid.
- Battery replacement must be done only by authorized and trained technical service personnel.
- Only the SCHRÖDER authorized or specified battery may be installed upon battery replacement.



2.5.4 Actuator Features

	Manufacturer	P / N	Class	Max. Force (Push)	Voltage
Backrest Actuator	LINAK	LA 40	II	6000 N	24 V DC
Leg rest Actuator	LINAK	LA 40	II	4000 N	24 V DC
Height Lift	LINAK	LA 40	II	6000 N	24 V DC

2.5.5 Standards Applied

Standard ID	Standard Name
IEC 60601-1	Medical electrical equipment – Part 1 : General requirements for basic safety and essential performance
IEC 60601-1-2	Medical electrical equipment – Part 1-2: General requirements for basic safety and essential performance – Collateral standard: Electromagnetic compatibility – Requirements and tests
IEC 60601-2-52	Medical electrical equipment – Part 2 -52: Particular requirements for the basic safety and essential performance of medical beds
IEC 60601-2-54	Medical electrical equipment – Part 2 -54: Particular requirements for the basic safety and essential performance of X-ray equipment for radiography and radioscopy

2.5.6 Environmental Conditions of Bed for Usage, Storage and Transportation

ENVIRONMENTAL CONDITIONS	OPERATION	STORAGE AND TRANSPORTATION
 Temperature	Temperature range for use is +5 °C to +40°C.	Temperature range for storage and transportation is -10 to +50°C
 Relative Humidity	Approximate percent moisture range for use is 20% to 90% @ 30 °C – not condensing.	Approximate percent moisture range for storage and transportation is 20% to 90 % @ 30 °C – not condensing.
 Atmospheric Pressure	Atmosphere pressure range for use is 800 hpa - 1060 hpa.	Atmosphere pressure range for storage and transportation is 800 hpa - 1060 hpa.

2.6 PRODUCT ILLUSTRATION

2.6.1 General Parts of Product

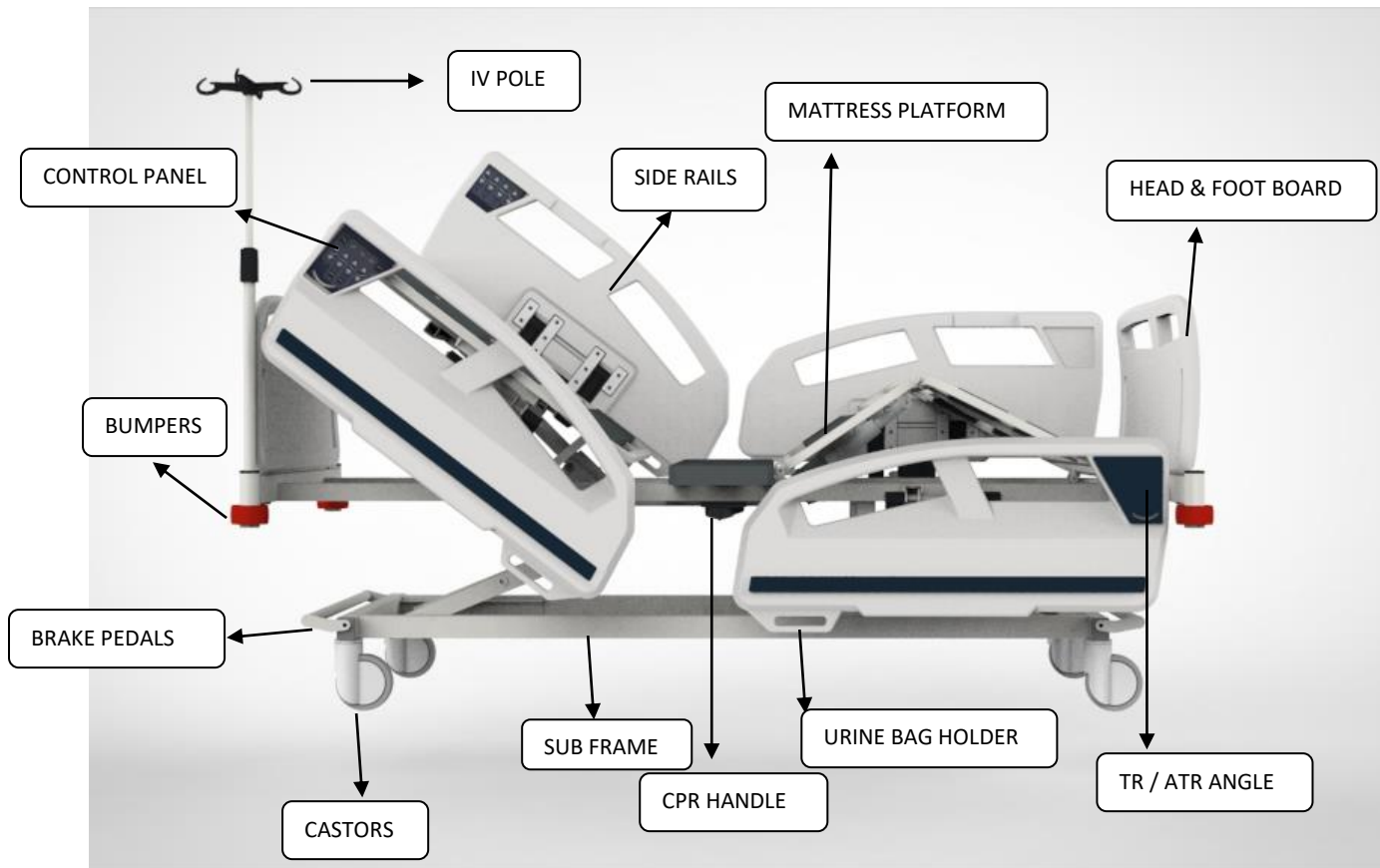

Figure 1: General Parts of Product

NOTE

Product serial number can be found on the product label (nameplate)

Please have the serial number of your Schroder product available when calling Schroder technical service. Include the serial number in all written communications.

2.6.2 Type B Applied Parts



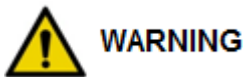

Figure 2: Type B Applied Parts

3. SUMMARY OF SAFETY PRECAUTIONS

Carefully read and strictly follow the warnings and cautions listed in this manual. Service can be applied only by qualified personnel. See the service manual for additional information.

3.1 WARNING / CAUTION / NOTE DEFINITIONS



WARNING

“Warning” alerts the reader about a situation which, if not avoided, could result in death or serious injury. It may also describe potential serious adverse reactions and safety hazards.



CAUTION

“Caution” alerts the reader of potentially hazardous situation which, if not avoided, may result in minor or moderate injury to the user or patient or damage to the equipment or other property. This includes special care necessary for the safe and effective use of the device and the care necessary to avoid damage to a device that may occur as a result of use or misuse.

NOTE

“Note” provides special information to make maintenance easier or important instructions clearer.

3.2 WARNINGS



WARNING

- The user must read and comprehend these Instructions for Use in order to ensure that they are using and maintaining the bed properly.
- The bed should be used only by authorized personnel who are properly trained, experienced, and acquainted with its functions.
- The bed shall only be used with input voltage and frequency as rated on the product label and in these Instructions for Use.
- Do not use the bed if it is identified to have any failure/defect/malfunction/damage.
- Do not use the bed particularly under any conditions that may cause injury to the patient, personnel or 3rd Parties.
- The user must adhere to the safe working load limit specified in this Instruction for Use and on the Product Label while using the bed. Safe working load is based on load distribution of 45% on the back rest, 25% for the seat section and 30% for the leg rest

- The health care provider is responsible for ensuring that the patient is capable of operating the control functions on the side rail.
- In order to reduce the risk of injury resulting from a fall, ensure that the bed is in the lowest possible position when the patient is unattended.
- If a patient's condition could result in a greater risk of patient entrapment, the mattress support surface should be left in the flat position when the patient is unattended.
- Before and during bed operation, the user must ensure that there are no obstacles, obstructions, bystanders, or equipment around the bed that may result in damage or injury.
- The bed should always be used on a flat and clean surface.
- The bed should always be positioned in the lowest height position while it is not in use.
- After raising the side rails, pull firmly on the side rail to ensure that it is securely locked into the up position.
- Keep hands/fingers clear of the area around the backrest or footrest when backrest or footrest are lowered automatically or manually. Injury could result if care is not taken when lowering backrest or footrest.
- In order to reduce the risk of patient fall during egress/ingress, the castors must remain locked when the patient is on or attempting to get on/off the bed. Otherwise injury could result.
- Make sure that the brakes are completely released before attempting to move the bed. Attempting to move the bed with the brakes engaged could result in injury to the user and/or patient.
- Never put any part of the body such as hand, head, foot, leg, torso etc. into any gap that is present on the bed or any of its components. Otherwise, severe injury or impairment may result.
- Never sit on the backrest or side rail of the bed.
- No person other than the patient should sit on the bed.
- The bed should never be used by more than one patient at a time.
- Unplug the bed when the power cable or plug is damaged. Damage includes but is not limited to damaged insulation, frayed wires, and bent prong(s).
- WANS 4040 bed that without radiolucent backrest option must not be used for X-Ray.
- Do not use the IV Pole to steer the bed or to support any patient limb or body part.
- Do not attempt to surmount obstacles or obstructions while moving bed, especially while transporting a patient.
- Only authorized and trained service personnel can conduct maintenance or service activities on the bed.
- To ensure safe function of the bed, cleaning and maintenance must be performed according to the recommendations and requirements of these Instructions for Use.
- Always unplug the power cable from the mains electrical socket and stow it before transporting, cleaning or servicing the bed. To unplug, grasp the mold near the outlet and pull the cord in a direction parallel to the floor (not at an angle).
- The bed must be unplugged from main electrical power and battery disconnected when service is performed on the bed.
- Only Schroder service parts are approved for service of the bed. If non Schroder spare parts are used, Schroder does not assume any responsibility in case of any damage, harm or injury.
- For any cleaning, repair or other operations to be performed in any gap on the bed or between any moving parts, the bed functions must be locked by using the Nurse Control Pendant. Instructions on locking bed functions can be found in section 5.4.3

3.3 CAUTION



CAUTION

- Do not modify this bed. Modifying the bed can cause unpredictable operation resulting in injury to the patient or operator. Modifying the bed also voids its warranty.
- This bed is intended to use by trained hospital personnel only.
- Before use of the bed, make sure that all functions of the bed operate properly and the bed has no damage/defect/malfunction/failure.
- Do not use the bed under conditions that may result in damage to the bed or other equipment or property.
- The user shall not dismantle any part of the bed during use.
- Only Schroder mattresses may be used with bed. Use of non-schroder mattress may pose entrapment risk to patient.

- The bed shall only be used with input voltage and frequency as rated on the product label and in these Instructions for Use.
- When any accessory is added to the bed, make sure they do not restrict movements of the bed.
- Never put any object into any gap that is present on the bed or any of its components.
- Only move/transport bed on flat, smooth, and clean surface.
- If large fluid spills occur in the area of control box, battery or motors unplug the power cord from the power source and push the “on-off” switch to the off position. Remove the patient from the bed and clean up the fluid. Have maintenance completely check the bed. Do not put the bed back into service until it is completely clean and dry.
- For long storage time of the bed, reset all settings, make sure that castor on a flat surface and make sure that no other bed or heavy object is put on bed.

3.4 PINCH POINTS

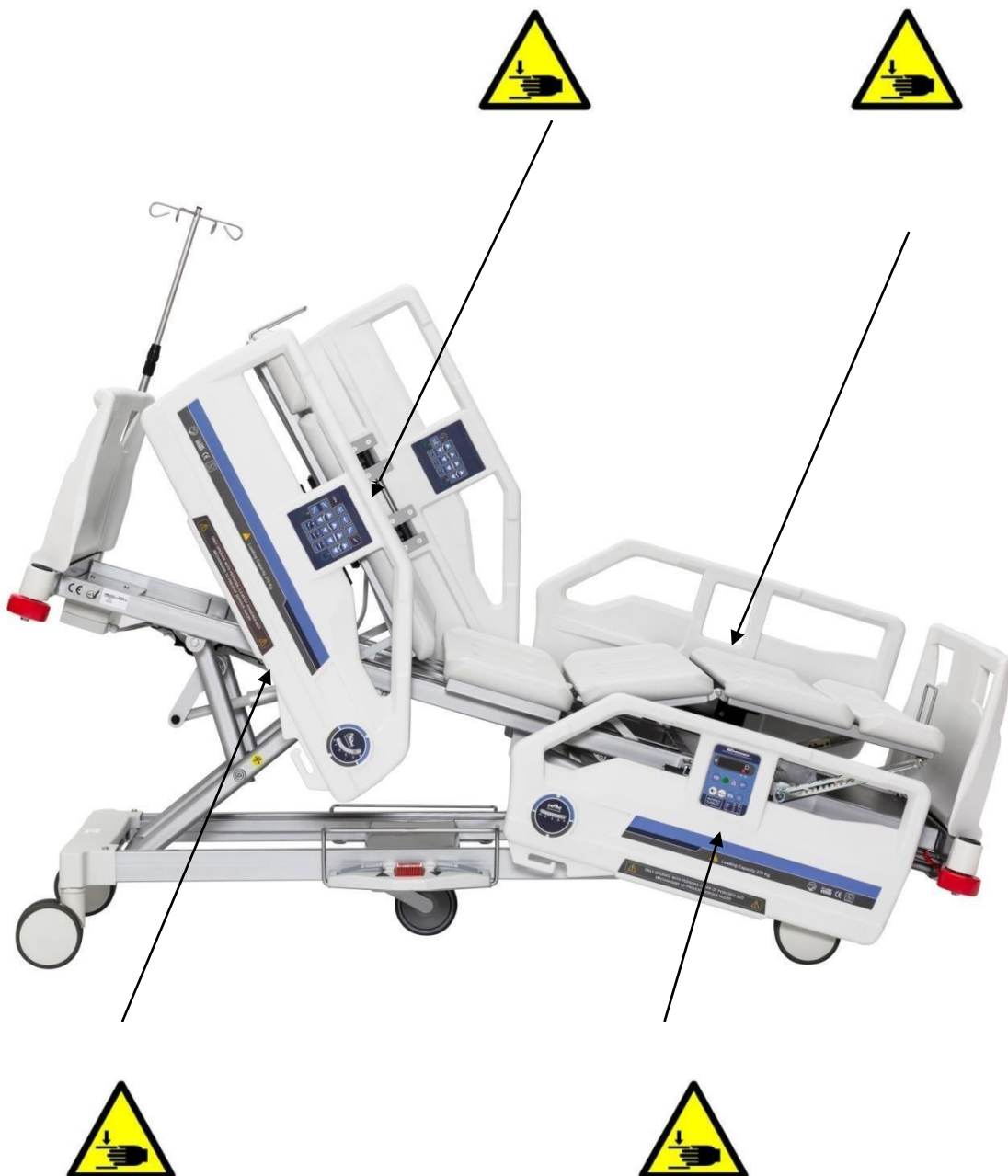

Figure 3: Pinch Points

4. OPERATION GUIDE

4.1 INSTALLATION OF THE BED

The following steps should be taken during unpacking and installation of the bed:

- Remove the beds from its packaging carefully.
- Inspect the bed for any damage that may have occurred during shipping/transportation.
- Verify that the bed and its components/accessories are present and intact.
- Read the Instructions for Use carefully before attempting to use the bed.
- Assemble the accessories as shown in this manual.
- Make sure the bed is connected to the mains electrical socket before attempting to operate the bed.
- Test all electronic functions of the bed (backrest movement, leg rest movement, auto contour movement, bed height adjustment, trendelenburg movement) and make sure all actuators and all control buttons function as they should.
- Test operation of the mechanical systems. (CPR release lever, knee gatch adjustment mechanism, side rail latching mechanism, castors locking mechanism, brake function)

4.2 CONNECTION OF THE BED TO MAINS

Input power may vary from country to country. Ensure that the mains power with which the bed will be used is within the specifications on the product label. Inspect the power cable and plug to ensure that it is not damaged and that there are no frayed wires or bent prongs.

4.3 CHARGE OF THE BATTERY BED AND BATTERY LIFE

If your bed comes with a battery backup system, you should charge the battery first before use of the bed. A charged battery allows for use of the bed while there is no AC power. Battery life is approximately 2 years under normal use conditions and if properly maintained. The battery function should be checked periodically using the preventative maintenance checklist and replaced upon failure or detection of malfunction during preventative maintenance activities. The battery is under manufacturer warranty for 1 (one) year unless otherwise stipulated in purchase order or contract.



WARNING

If any overheating of the battery or control cables/pendants is detected, disconnect the power plug from the power source and do not use the bed again until it has been inspected, serviced, and confirmed to be working to specification by an authorized and trained service technician.

4.4 HOW TO OPERATE THE BED

4.4.1 Nurse and Patient Hand Control Pendant

Hand control pendant has function buttons. The functions are shown below. The supply voltage is 8 V DC for hand control pendant.

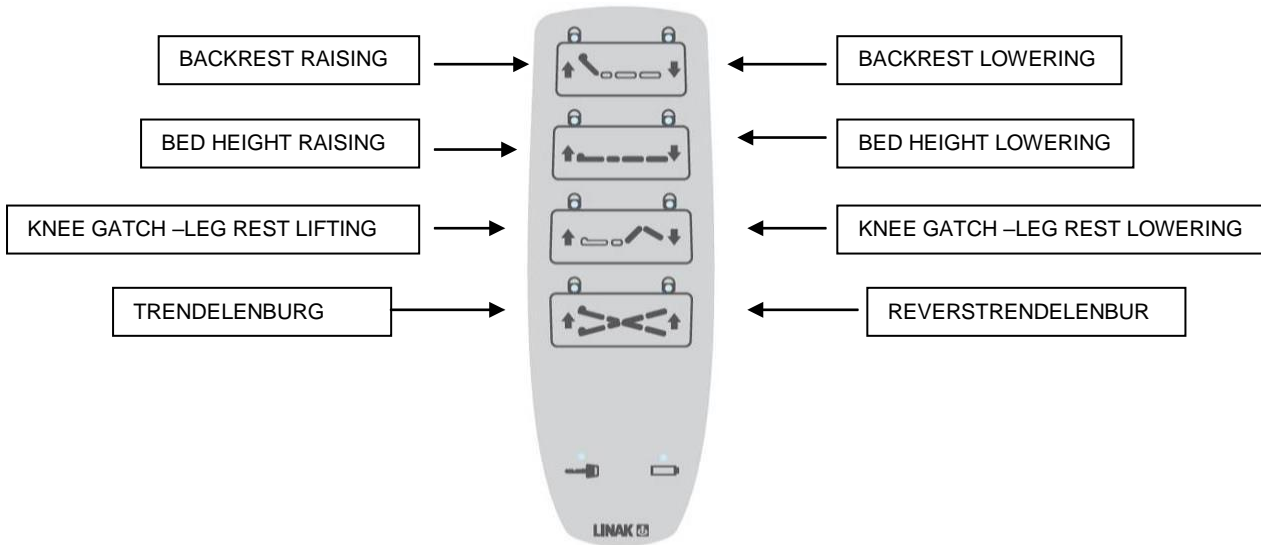

Figure 4: Nurse and Patient Hand Control Pendant

4.4.2 Side rail Control Pendant

Side rail control pendant has function buttons. The functions are shown below. The supply voltage is 8 V DC for hand control pendant.

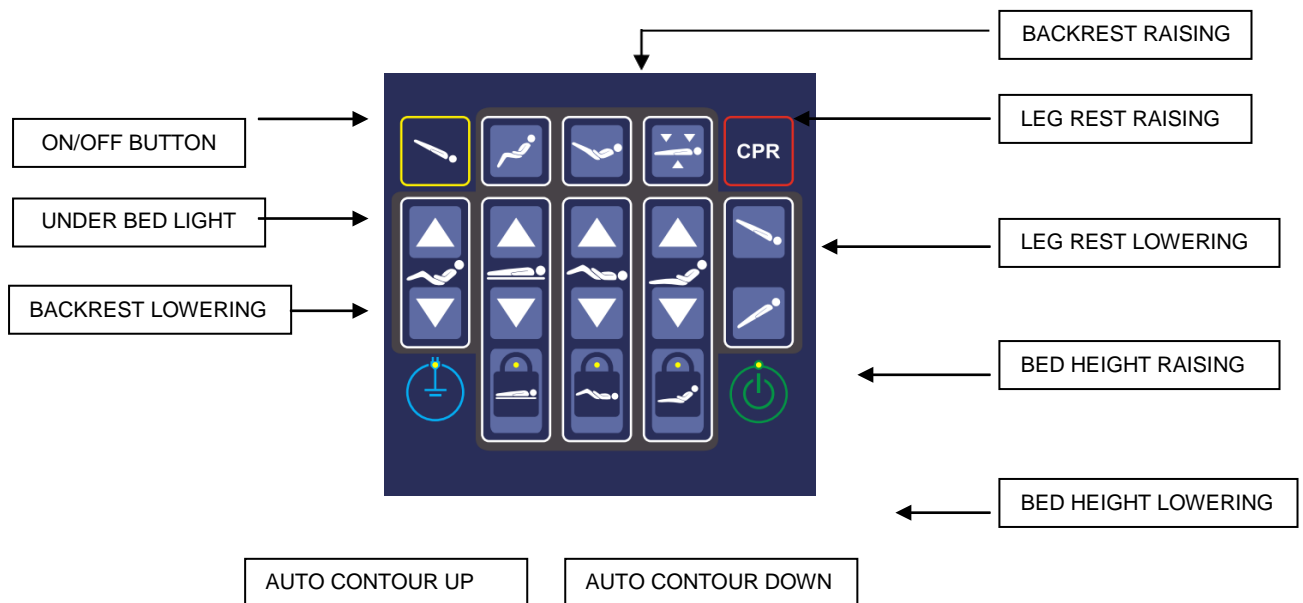

Figure 5: Side rail Control Pendant

4.4.3 Nurse Control Pendant

Side rail control pendant has function buttons. The functions are shown below. The supply voltage is 8 V DC for nurse control pendant.

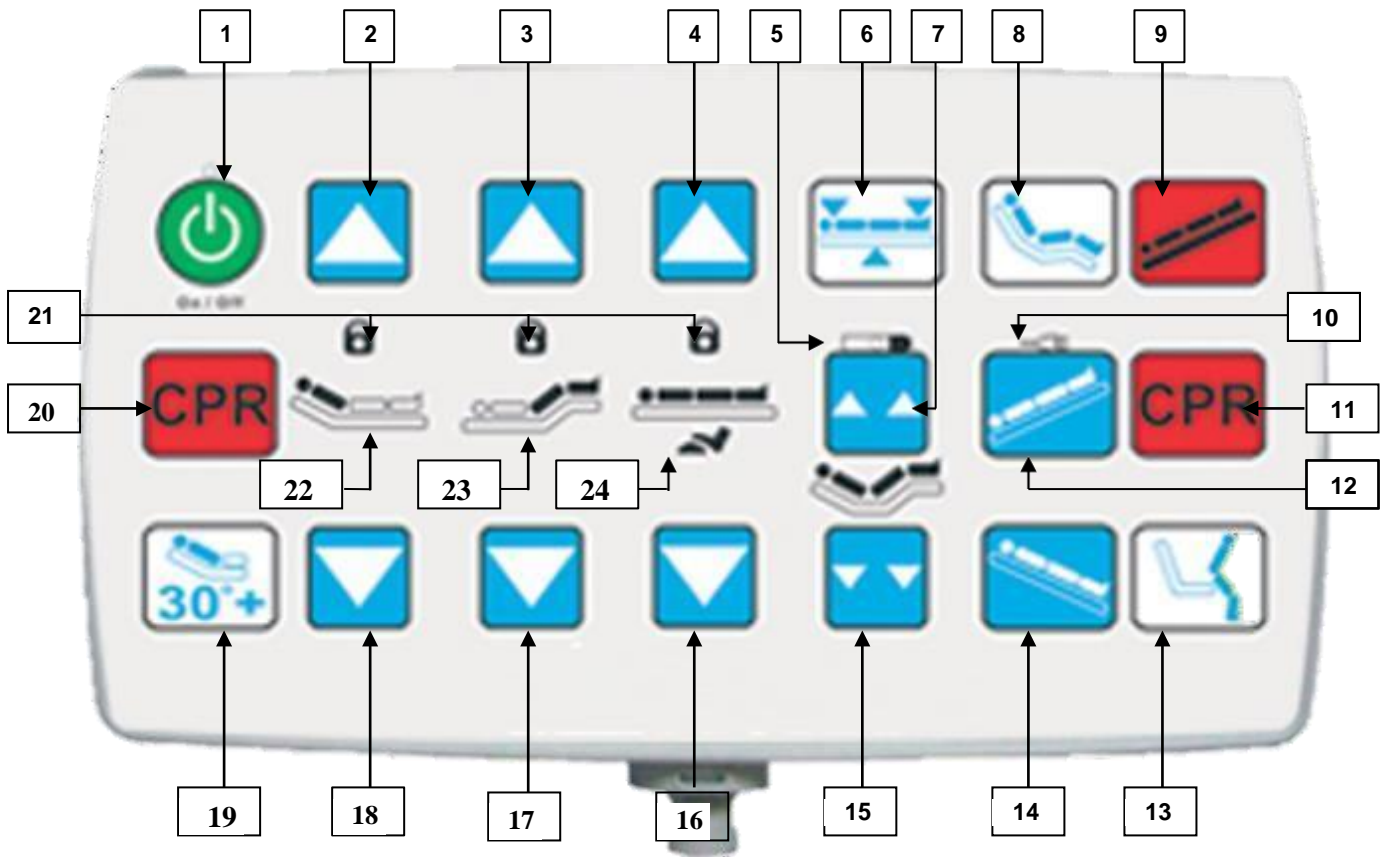

Figure 6: Nurse Control Pendant

1	On/Off Button	13	Bed Exit Position
2	Backrest Raising	14	Reverse Trendelenburg Position
3	Leg Rest Raising	15	Auto Contour (Down)
4	Bed Height Raising	16	Bed Height Lowering
5	Battery Charge Status	17	Leg Rest Lowering
6	Examination Position	18	Backrest Lowering
7	Auto Contour (Up)	19	+30° Semi Fowler Position
8	Sitting Position	20	CPR Position
9	Shock Position	21	Nurse Control Pendant Position Locking LEDs
10	Energy Cable Status	22	Backrest Locking Button
11	CPR Position	23	Leg Rest Locking Button
12	Trendelenburg Position	24	Height Locking Button

- If the bed is unplugged from the main power supply and the battery is not charged, the Nurse Control Pendant will be inoperable.

- If the bed is unplugged from the main power supply and battery has power, Nurse Control Pendant will function.
- Nurse control pendant position locking system: When the operator presses an individual lock button (22, 23 or 24) the respective function will be locked from all controllers and the respective LED will be lit. When the operator presses all three lock buttons, all functions except CPR (buttons 11 and 20), are locked and each LED will be lit.

4.4.4 Manual Control Systems

4.4.4.1 Manual Control of CPR Release Mechanism for Backrest



Figure 7: Manual Control of CPR Release Mechanism on Backrest

The bed is equipped with a manual CPR release mechanism. This can be used if the bed is required to be placed in the CPR position quickly or in the event of failure of the electrical CPR button on the Nurse Control Pendant. CPR release handles are present on each side of the bed below the backrest. Only one lever is required to be pulled in order to place the bed in the CPR position.



WARNING

When using the manual CPR release, ensure that there is no object under the backrest that may obstruct it.

4.4.4.2 Manual Control of Foot Section Height Adjustment

The upper leg rest is controlled electronically by the control buttons on the pendants and side rails. The lower leg rest (foot rest) can be adjusted manually by lifting on the lower leg rest section as shown below in Figure 1. In order to lower it again, simply pull the mechanism up to release the leg rest.

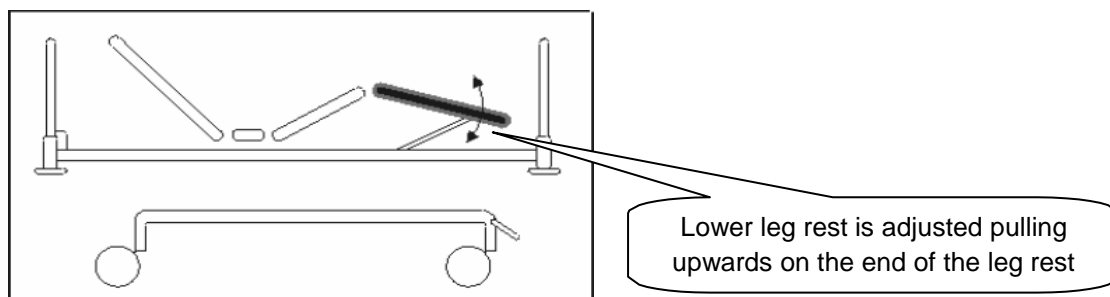

Figure 8: Manual Control of Foot Section Height Adjustment

4.4.4.3 Manual Control of Side rails

The WANS 4040 is equipped with 4 side rails for safety of the patients. When the side rails are latched in the up position they help ensure that the patient will remain in the bed and help reduce the likelihood of a patient fall.

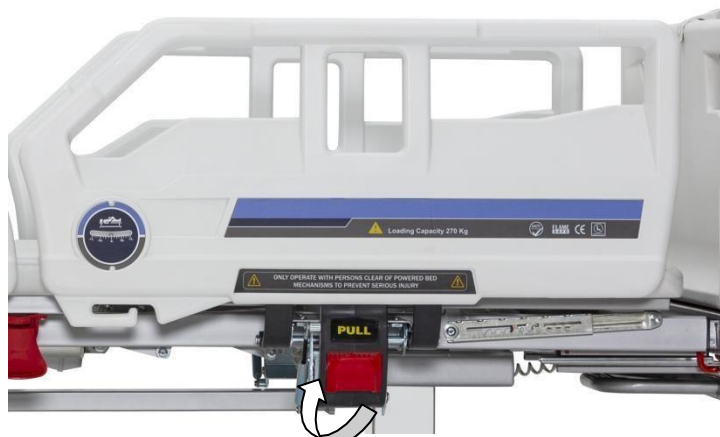

Figure 9: Manual Control of Side rails

Side rail operation is as follows:

To release a side rail latched in the up position, place one hand on the top of the side rail using the other hand to lift up on the red handle at the base of the side rail. Guide the side rail down with your hands to the lowest position. The side rails are equipped with gas springs that assist in the lowering and raising of side rails. To raise and latch a side rail to the up position simply lift the side rail up from the top of the side rail.



WARNING

Do not place your hand or fingers near the side rail latch when raising the side rail as this could result in pinching or injury to hand or fingers.

4.4.4.4 Manual Mounting of Bed Head Board & Foot Board

The WANS 4040 bed is equipped with removable head board and foot board. To remove the head board or foot board, simply lift up the head board or foot board from the upper part as shown in the figure below. To reinstall the head board or foot board, simply lift them from the top and align the 2 locating pins in the locators on the bed litter.

Figure 10: Manual Disassemble and Assemble of Bed Head Board & Foot Board



4.4.4.5 Manual Bed Extension Kit (Optional)

The WANS 4040 is equipped with optional bed extension system. This allows the user to extend the bed from the foot end by 18 cm as needed for taller patients. To utilize the bed extension, simply unlock the two brass locking mechanisms on both sides of the foot end of the bed (see figure below) and pull the bed extension to the desired position. Be sure to re-engage the lock mechanism after extending to ensure that the foot end length is fixed.

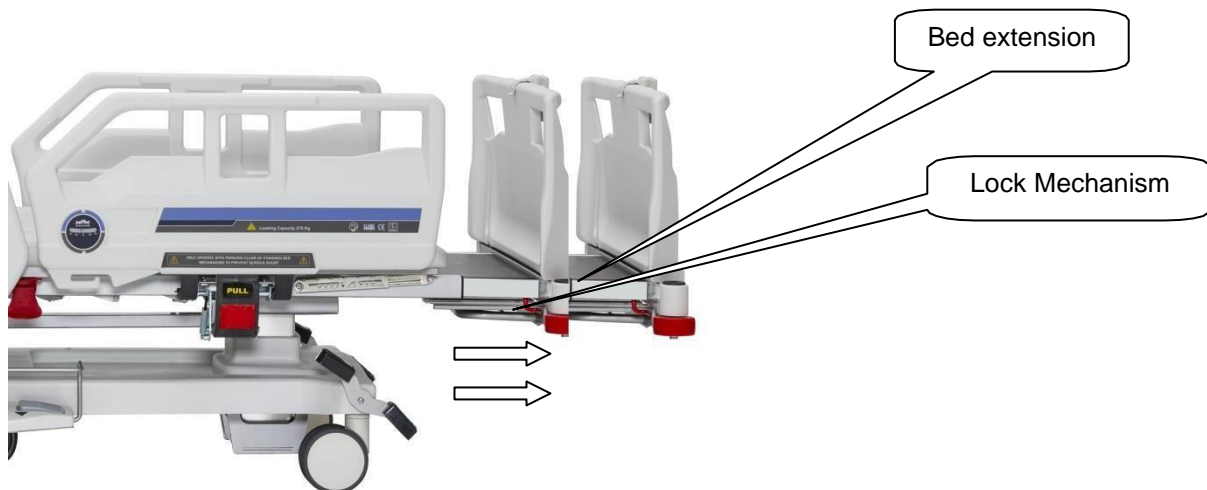

Figure 11: Manual Bed Extension Kit

4.4.4.6 Bed Platform Extension

After setting the bed extension to the desired position the lower leg rest plastic cover should also be extended. This plastic cover is secured by 3 fasteners.

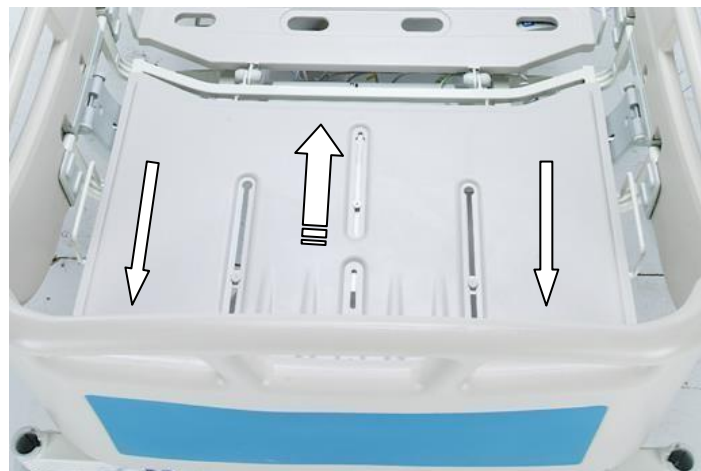
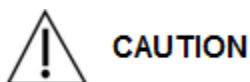

Figure 12: Bed Platform Extension



Do not attempt to pull the lower leg rest plastic directly. This can damage the plastic or fasteners. To remove the lower leg plastic cover for cleaning or maintenance; first pull the plastic part on the extended side until the 3 fasteners are aligned with the large holes and then put it out.

4.4.4.7 Castors Locking Mechanism

Castor system shown in the figure below is of the central lockable castor system. Brake can perform free and directional locking functions. Control of the central castor ensures easy use. With the central castor system, a single person can transport it by help of directional lock without any problem. 4040 bed

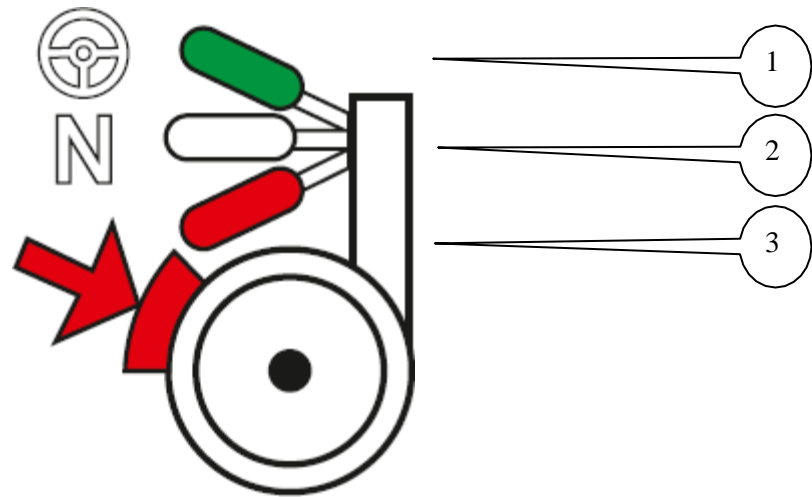

In the figure, the arrow 1 shows the directional lock. The directional lock acts on castors located at the right backrest of the bed. Assuming that the bed shall be moved from the leg rest, it makes the front right castor directionally locked in the position 1 and when the bed starts, it ensures patient safety and easy transportation by single person. If the bed is equipped with a 5th castor, when the 5th castor is activated, it locks in forward direction, and thus it again ensures easy use of the bed without exposing the patient to any risk.

The sign 2 in the figure indicates the lock pedal is at the center and all castors are free in this position.

The sign 3 in the figure designates that all castors are locked.

1. Directional lock
2. Castors free
3. All castors locked



WARNING!

You should disconnect the power cable from the socket and suspend it when moving the bed.

5. ACCESSORIES AND OPTIONS

The accessories and options of WANS 4040 beds are stated with their explanations and specifications in this section.

5.1 ACCESSORIES

5.1.1 IV Pole

IV poles consist of 4 hooks, each bearing maximum 2 kg, (recommended maximum total weight capacity is also 2 kg). There are four IV pole installation locators at each of the four corners of the bed. It is only designed to hang IV bags. The IV pole is extendable by using the adjustment knob on the pole. Diameter of upper part of IV pole 18 mm and of lower part of IV pole is 25 mm.



Specifications:

Part Number : MM0017
Part Weight : 1.4 Kg
Safe Working Load : 4 x 2 Kg (8 kg total)

Figure 14: IV Pole



CAUTION

Make sure the adjustment knob is secured tightly after installation and adjustment to prevent any unwanted movement of the IV Pole.

5.1.2 Patient Lifting Pole

There are 2 patient lifting pole installation locators on the backrest (head end) of the bed. It is used to assist the patient when attempting to exit the bed on his/her own.



Specifications:

Part Number : MM003
Part Weight : 4.6 Kg
Safe Working Load : 78 Kg

Figure 15: Patient Lifting Pole



WARNING

- When changing bed position, ensure that the IV pole and/or lifting pole are not obstructed and do not interfere with the patient, oxygen holder, or any other equipment or people in the vicinity.
- Do not hang any other device or object on IV pole or lifting pole.

5.1.3 Urine Bottle Basket

The WANS 4040 is available with a foley basket for urine bottles/bags. Foley hooks are on both sides of the bed. To install the urine bottle basket, simply hook the basket on the foley hooks on either side of the bed. Ensure that the basket is completely hooked to each hook on the bed litter before using.



Figure 16: Urine Bottle Basket

Specifications:

Part Number : M009
Part Weight : 0.3 Kg
Safe Working Load: 2 L or 5 Kg

5.1.4 Traction Set

The WANS 4040 Traction Set accessory provides the user the ability to support limbs that require elevation. The traction set is installed into 4 locator holes at each corner of the bed. The traction set is manufactured by stainless steel.



Figure 18: Traction Set

Specifications:

Part Number : MM031
Part Weight : 30 Kg
Safe Working Load : 75 Kg

5.1.5 Oxygen Cylinder Holder

The WANS 4040 bed has an Oxygen Cylinder Holder accessory. It is installed in the locator hole on the head end of the bed as shown in the below photograph. Make sure it is fully installed before inserting an oxygen bottle.



Figure 19: Oxygen CylinderHolder

Specifications:

Part Number : MM006
Part Weight : 1.1 Kg
Safe Working Load : 2 L or 7.5 Kg



WARNING

- Turn the oxygen cylinder holder to the end of the bed while moving the bed.
- Do not hit the oxygen cylinder holder to the doors or walls while moving the bed.

5.1.6 Fastening Belt for Chest



Figure 20: Fastening Belt for Chest

The belt can be used to limit the undesired movement of patients who are unconscious or otherwise require movement limits according to healthcare provider needs.

Specifications:

Part Number : MM024

The belt is made by fiber covered by antibacterial, non-ignition, waterproof, breathable PU coated fabric. Straps are narrow woven webbing with snap fasteners. Belt can be adjusted by the velcro fasteners. User easily release the belt by pull out the velcros

5.1.7 Fastening Belt for Arm / Foot



Figure 21: Fastening Belt for Arm / Foot

The belt can be used to limit the undesired movement of patients who are unconscious or otherwise require movement limits according to healthcare provider needs.

Specifications:

Part Number : MM025

Belt is made by polar fleece. Straps are narrow woven webbing with snap fasteners.

5.1.8 File Holder

File holder can be attached to the board (foot/head board). This folder can be used to store patient related documents as needed by healthcare provider.



Specifications:

Part Number : MM007

Part Weight : 1.1 Kg

Safe Working Load : 2 L or 7.5 Kg

Figure 22: File Holder

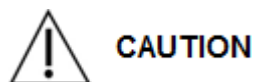

Only accessories designed by SCHRÖDER for use with the WANS 4040 are permissible for use with the 4040. The use of non-SCHRÖDER WANS 4040 accessories may result in damage to the product or injury to the user or patient. schröder is not responsible for any damage or injury that may result for the misuse of the product or the use of unauthorized accessories.

5.2 OPTIONS

5.2.1 Mattress

The WANS 4040 bed comes with a SCHRÖDER designed mattress. Three optional mattress models can be used with 4040 bed. They are listed below.



- 1) Part Number : MA-202 FT
Specifications: 120 x 900 x 2000 mm
32 density slotted foam.
- 2) Part Number : MA-203 FT
Specifications: 140 x 900 x 2000 mm,
32 density slotted foam,
fire retardant.
- 3) Part Number : MA-204 FT
Specifications: 120 x 900 x 2000 mm
55-60 density 40 mm thicknesses viscoelastic
32 density 80 mm thicknesses foam.

Figure 23: Mattress

Specifications:

- Mattress cover is designed to ISO 20645, ISO 1421, ISO 6330, BS EN 20811, ASTM E-96, BS 7175
- Antibacterial activity of the mattress cover is conformant to ISO 20645.
- Strength and elongation of cover is conformant to ISO 1421.
- Washing and drying properties of cover is conformant to ISO 6330.
- Water penetration of mattress cover is conformant to BS EN 20811.
- Water vapor permeability of mattress cover is conformant to ASTM E-96.
- The mattress cover is non-ignition according to BS 7175 Section 3.
- The mattress cover is waterproof and breathable.
- It can be washable in 95 degree water.
- The mattress cover has a three-sided zipper for easy removal.
- Mattress is orthopedic, designed to provide ergonomic comfort.
- Ignitability of foam is conformant to BS 5852.
- Mattress has expected life of three (3) years.



CAUTION

- Do not use the bed without mattress. Only Schroder designed mattress can be used with the 4040. Use of a non-schröder authorized mattress may result in damage to the product or present entrapment risks to the patient. Schroder is not responsible for any damage or injury that may result from using a non-schröder authorized mattress.
- Do not position the mattress on bed improperly. The user must ensure that the mattress is properly positioned on the litter.

5.2.2 Radiolucent Backrest and X-ray Cassette Holder



Figure 24: Radiolucent Backrest

The WANS 4040 comes equipped with an optional radiolucent backrest allowing for x-ray images to be taken while the patient is on the bed. The radiolucent backrest weight is 7 Kg and fastened to backrest frame with screws.

X-ray images can be taken by inserting an X-ray cassette into the housing that located behind the backrest. It is not necessary to move the patient in order to insert an X-ray cassette.

X-ray guide dimensions: 390 mm x 660 mm x 16 mm

X-ray cassette dimensions (recommended):

- 1) 385 mm x 385 mm x 15 mm
- 2) 460 mm x 383 mm x 15 mm

5.2.3 Under Bed Light



Figure 25: Under Bed Light

The Under Bed light (UBL) can be used to increase patient visibility in dark room. The UBL makes it easier for the patient to find their way back to the bed at night. The UBL has two LEDs and the supply voltage of the UBL is 8 V DC.

5.2.4 Bed Extension Kit



Figure 26: Bed Extension Kit

The WANS 4040 can be equipped with optional bed extension system. This allows the user to extend the bed from the foot end by 18 cm as needed for taller patients. The extension has two brass locking mechanisms on both sides of the foot end of the bed. User can simply unlock the locking mechanism and pull the bed extension to the desired position.

5.2.5 SLS Brake Alarm System



Figure 27: SLS Brake Alarm System

The WANS 4040 can be equipped with optional SLS brake alarm system. This option alerts the user to not move the bed when the castors are not locked and the bed main power cord is plugged in to electrical mains. This option helps prevent damage to the power plug by moving the bed when the power cord is plugged in. The supply voltage of the SLS brake alarm system is 24 V DC.

5.2.6 Castors



Figure 28: Castors

The WANS 4040 has the standard centrally directionally locked castors.

Twin Castor
Specifications:

Part Weight : 1,121 Kg
Diameter : 150 mm

5.2.7 Hand Control Pendant

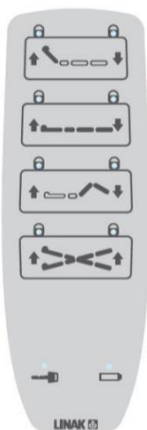

Figure 29: Hand Control Pendant

This optional control pendant is designed for usage by patient/nurse/caregiver to operate the bed. Operation details are stated in section 4.4.1

5.2.8 Side rail Control Pendant



This optional pendant control is designed for usage by patient/nurse/caregiver to operate the bed. Operation details are stated in section 4.4.2

Figure 30: Side rail Control Pendant

NOTE

For the options “6.2.7 Hand Control Pendant” and “6.2.8 Side rail Control Pendant” at least one of them must be placed in the product.

5.2.9. Shelf for Bed Linen



This shelf can be used as a place for,
1) Clothes and laundry of patient
2) Bed laundry
3) Nurse control unit

Safety work load of shelf: max. 15 Kg

Figure 31: Shelf for Bed Linen

6. BED CLEANING

6.1 PRE-CLEANING REQUIREMENTS

- Unplug the power cord before cleaning the bed.
- Inspect the bed and mattress for damage. If damage is present that may result in fluid ingress, remove the bed or mattress from use and have the bed repaired by an authorized service person prior to placing back in use.
- Avoid of use of corrosive chemicals that may give damage to the finishing or material.
- Avoid of use of steel wool and any other material that may damage the bed's surface during cleaning.
- Do not use acid-based chemicals.
- Do not use flammable chemicals such as gasoline, diesel, acetone, etc. for cleaning purposes.
- Wipe by using a damp cloth.
- Beds are not designed for automatic wash.
- Beds are not suitable for cleaning by shower, steam or spray.



WARNING

Only use approved cleaners and the approved cleaning process. Schröder is not responsible for any damage or injury that may occur as a result of improper cleaning/disinfection and cleaning with unapproved substances.



CAUTION

Do not steam wash, clean with compressed water or place bed in and automatic wash. These cleaning processes may result in damage to the product. schröder is not responsible for any damage or injury that may occur as a result of improper cleaning/disinfection.

6.2 APPROVED CLEANERS

Suggested cleaners for hospital bed (see below for mattress cleaning):

- Quaternary cleaners (active ingredient - ammonium chloride)
- Phenolic cleaners (active ingredient - o-phenyl phenol)
- Chlorinated bleach solution (1 part bleach (5.25% sodium hypochlorite) to 100 parts water which equals 520 ppm available chlorine (40 ml of a 5.25% bleach solution per 4000ml water)



CAUTION

- Do not use Virex TB to clean this product as damage may result.
- Avoid over saturation and ensure that the product does not stay wet longer than recommended by the chemical manufacturer's guidelines for proper disinfecting.

6.3 APPROVED CLEANING PROCESS

- Ensure all castors are in the lock position and the bed cannot be moved.
- The bed should be cleaned when there is no patient on the bed.
- Disconnect the power cable of the bed from the mains electrical outlet and stow it
- Lock all control functions on the bed by using the nurse control pendant. Verify that all controls are locked by attempting to adjust the bed from the nurse control pendant.
- Raise the bed to the highest height to clean under the bed.
- Lift the backrest and leg rest up to the highest height to clean under each mechanism.
- After completion of all these actions, you may begin cleaning the bed.

6.4 SIDE RAIL CLEANING

Side rails are manufactured of plastic PP material with the legs made of aluminum. Side rail is suitable for daily cleaning. Cleaning should be performed while the side rails latched. You should be careful when cleaning the color label area of side rail. If the side rail has control unit, wipe a damp cloth, never with a wet one; otherwise, you may give damage to the electronics.

7. PREVENTATIVE MAINTENANCE AND CHECKLIST

Preventative maintenance is recommended to be performed in 3 month intervals. Use the preventative maintenance checklist to document preventative maintenance performed. Only authorized service personnel should perform maintenance and service activities on the bed.



WARNING

If any failure, defect, damage, or malfunction is identified during service or maintenance, do not use the bed. In such case, contact schröder or your local dealer/distributor.



WARNING

Electrical safety testing must be performed by trained personnel that are certified in electrical safety testing and applying the test in a safe and controlled manner.

7.1 CHECKLIST

CHECKBOX	CHECKPOINTS	FINDINGS OR EXPLANATIONS
<input type="checkbox"/>	All fasteners are secured	
<input type="checkbox"/>	All side rails move and latch properly	
<input type="checkbox"/>	All green pedals operate the directional lock (position 1 in section 4.4.4.7)	
<input type="checkbox"/>	All castors are free when pedals are center position (position 2 in section 4.4.4.7)	
<input type="checkbox"/>	All castors are locked with brake pedal engaged. (position 3 in section 4.4.4.7)	
<input type="checkbox"/>	All castors are secure and swivel properly	
<input type="checkbox"/>	Inspect each castor and remove any wax or debris which may have collected on the castor and brake mechanism	
<input type="checkbox"/>	Check bed metal and plastic parts for cracks, breaks and sharp edges.	
<input type="checkbox"/>	Ensure no damage to the frame covers (backrest, seat, upper leg and foot rest)	
<input type="checkbox"/>	No damage to the head and foot boards	
<input type="checkbox"/>	Manual CPR mechanism functions properly	
<input type="checkbox"/>	Trendelenburg / reverse Trendelenburg operates properly from all controllers.	
<input type="checkbox"/>	Manual knee Gatch adjusts properly	
<input type="checkbox"/>	Radiolucent backrest and cassette holder are clean and in good condition (Optional equipment)	
<input type="checkbox"/>	Side rail control pendant operating the functions properly (optional equipment)	
<input type="checkbox"/>	Hand control pendant operating the functions properly (optional equipment)	
<input type="checkbox"/>	Nurse control pendant operating the functions properly	
<input type="checkbox"/>	No abnormal noises during the functional check.	
<input type="checkbox"/>	No rips or crack in mattress cover (optional equipment)	
<input type="checkbox"/>	Mattress is placed in the correct position.	
<input type="checkbox"/>	Bed platform extension is clean and working properly.	
<input type="checkbox"/>	Accessories and mounting equipment in good condition and work properly	
<input type="checkbox"/>	IV pole intact and operates properly (Accessory)	
<input type="checkbox"/>	Oxygen cylinder holder intact and operates properly (Accessory)	
<input type="checkbox"/>	Urine bottle basket intact and operates properly (Accessory)	

<input type="checkbox"/>	Patient lifting pole intact and operates properly.(Accessory)	
<input type="checkbox"/>	Traction set intact and operates properly. (Accessory)	
<input type="checkbox"/>	Fastening belt for chest working properly. (Accessory)	
<input type="checkbox"/>	Fastening belt for arm/foot working properly. (Accessory)	
<input type="checkbox"/>	Under bed light working properly. (Optional equipment)	
<input type="checkbox"/>	Bed extension working properly. (Optional equipment)	
<input type="checkbox"/>	SLS break alarm switch working properly. (Optional equipment)	
<input type="checkbox"/>	Confirm battery powered functionality	
<input type="checkbox"/>	No cover cracks or leakages on the battery	
<input type="checkbox"/>	Battery sufficiently charged	
<input type="checkbox"/>	No cables are worn, pinched or frayed	
<input type="checkbox"/>	Power cord and plug are free to damage	
<input type="checkbox"/>	All ground cables are secure to the frame	
<input type="checkbox"/>	All electrical connections are tight and secure	
<input type="checkbox"/>	No damage to the control box cover and sockets	
<input type="checkbox"/>	Hi-Lo actuators fastened properly	
<input type="checkbox"/>	Backrest actuator fastened properly	
<input type="checkbox"/>	Footrest actuator fastened properly	
<input type="checkbox"/>	Ground Impedance Check (≤ 0.2 Ohm)	
<input type="checkbox"/>	Leakage Current Check: Normal Polarity, No Ground, L2 Active (≤ 300 μ A) Normal Polarity, No Ground, No L2 (≤ 600 μ A) Reverse Polarity, No Ground, L2 Active (≤ 300 μ A) Reverse Polarity, no Ground, No L2 (≤ 600 μ A)	
<input type="checkbox"/>	High-Potential Test 1500Vac (Trip Current ≤ 10 mA)	
<input type="checkbox"/>	All labels are legible and are not damaged or peeling	

Product Serial Number:

Date:

Completed By:

Signature:

8. ELECTRICAL FEATURES (EMC/EMI INFORMATION)

8.1 GUIDANCE AND MANUFACTURER'S DECLARATION - ELECTROMAGNETIC EMISSIONS

Guidance and Manufacturer's Declaration - Electromagnetic Emissions		
The Model WANS 4040 Bed is intended for use in an electromagnetic environment specified below. The customer or the user of the WANS 4040 Bed should assure that it is used in such an environment.		
Emissions Test	Compliance	Electromagnetic Environment
RF Emissions CISPR 11	Group 1	The Model WANS 4040 Bed uses RF energy only for its internal function. Therefore, its RF emissions are very low and are not likely to cause any interference in nearby electronic equipment.
RF Emissions CISPR 11	Class A	The Model WANS 4040 Bed is suitable for use in all establishments other than domestic and those directly connected to the public low voltage power supply network that supplies buildings used for domestic purposes.
Harmonic Emissions IEC 61000-3-2	Class A	
Voltage Fluctuations Flicker Emissions IEC 61000-3-3	Complies	

8.2 GUIDANCE AND MANUFACTURER'S DECLARATION - ELECTROMAGNETIC IMMUNITY

Guidance and Manufacturer's Declaration - Electromagnetic Immunity			
The Model WANS 4040 Bed is suitable for use in the electromagnetic environment specified below. The customer or the user of the Model WANS 4040 Bed should assure that it is used in such an environment.			
Immunity Test	IEC 60601 Test Level	Compliance Level	Electromagnetic Environment Guidance
Electrostatic Discharge (ESD) IEC 61000-4-2	± 6 kV contact ± 8 kV air	± 6 kV contact ± 8 kV air	Floors should be wood, concrete, or ceramic tile. If floors are covered with synthetic material, the relative humidity should be at least 30%.
Electrostatic fast Transient/burst IEC 61000-4-4	± 2 kV for power supply lines ± 1 kV for input/output lines	± 2 kV for power supply lines ± 1 kV for input/output lines	Main power quality should be that of a typical commercial or hospital environment.
Surge IEC 61000-4-5	± 1 kV differential mode ± 2 kV common mode	± 1 kV differential mode ± 2 kV common mode	Main power quality is that of a typical commercial and/or hospital environment.
Voltage dips, voltage variations and short interruptions on power supply input lines IEC 61000-4-11	$< 5\%U_T$ (95% dip in U_T) for 0.5 cycle $40\%U_T$ (60% dip in U_T) for 5 cycles $70\%U_T$ (30% dip in U_T) for 25 cycles. $< 5\% U_T$ ($> 95\%$ dip in U_T) for 5 sec.	$< 5\%U_T$ (95% dip in U_T) for 0.5 cycle $40\%U_T$ (60% dip in U_T) for 5 cycles $70\%U_T$ (30% dip in U_T) for 25 cycles. $< 5\% U_T$ ($> 95\%$ dip in U_T) for 5 sec.	Main power quality should be that of a typical commercial and/or hospital environment. If the user of the Model WANS 4040 Bed requires continued operation during power main interruptions, it is recommended that the device be powered from an uninterrupted power supply or a battery.
Power frequency (50/60 Hz) magnetic field IEC 61000-4-8	3 A/m	3 A/m	Power frequency magnetic fields should be at levels characteristic of a typical location in a typical commercial and/or hospital environment.
Note: U_T is the a.c. mains voltage prior to applications of the test level.			

Guidance and Manufacturer's Declaration - Electromagnetic Immunity

The Model WANS 4040 Bed is suited for use in the electromagnetic environment specified below. The customer or the user of the Model WANS 4040 Bed should assure that it is used in such an environment.

Immunity Test	IEC 60601 Test Level	Compliance Level	Electromagnetic Environment - Guidance
<p style="text-align: center;">Conducted RF IEC 61000-4-6</p> <p style="text-align: center;">Radiated RF IEC 61000-4-3</p>	<p style="text-align: center;">3 Vrms 150 kHz to 80 MHz</p> <p style="text-align: center;">3 V/m 80 MHz to 2.5 GHz</p>	<p style="text-align: center;">3 Vrms</p> <p style="text-align: center;">3 V/m</p>	<p>Portable and mobile RF communications equipment should be used no closer to any part of the WANS 4040 Bed, including cables, than the recommended separation distance calculated from the equation appropriate for the frequency of the transmitter.</p> <p style="text-align: center;">Recommended Separation Distance</p> <p style="text-align: center;">$d=1.2 \sqrt{P}$</p> <p style="text-align: center;">$d=1.2 \sqrt{P}$ 80 MHz to 800 MHz</p> <p style="text-align: center;">$d=2.3 \sqrt{P}$ 800 MHz to 2.5 GHz</p> <p>Where P is the maximum output power rating of the transmitter in watts (W) according to the transmitter manufacturer and d is the recommended separation distance in meters (m).</p> <p>Field strengths from fixed RF transmitters, as determined by an electromagnetic site survey,^a should be less than the compliance level in each frequency range.^b</p> <p>Interference may occur in the vicinity of equipment marked with the following symbol:</p> <div style="text-align: center;">  </div>

Note 1

At 80 MHz and 800 MHz, the higher frequency range applies.

Note 2

These guidelines may not apply in all situations. Electromagnetic propagation is affected by absorption and reflection from structures, objects and people.

^aField strengths from fixed transmitters, such as base stations for radio (cellular/cordless) telephones and land mobile radios, amateur radio, AM and FM radio broadcast, and TV broadcast cannot be predicted theoretically with accuracy. To assess the electromagnetic environment due to fixed RF transmitters, an electromagnetic site survey should be considered. If the measured field strength in the location in which the Model WANS 4040 Bed is used exceeds the applicable RF compliance level above, the Model WANS 4040 Bed should be observed to verify normal operation. If abnormal performance is observed, additional measures may be necessary, such as reorienting or

Guidance and Manufacturer's Declaration - Electromagnetic Immunity

The Model WANS 4040 Bed is suited for use in the electromagnetic environment specified below. The customer or the user of the Model WANS 4040 Bed should assure that it is used in such an environment.

relocating the Model WANS 4040 Bed.
Over the frequency range 150 kHz to 80 MHz, field strengths are less than 3 V/m.

Recommended separation distances between portable and mobile RF communications equipment and the Model WANS 4040 Bed.

The Model WANS 4040 Bed is intended for use in an electromagnetic environment in which radiated RF disturbances are controlled. The customer or the user of the Model WANS 4040 Bed can help prevent electromagnetic interferences by maintaining a minimum distance between portable and mobile RF communications equipment (transmitters) and the Model WANS 4040 Bed as recommended below, according to the maximum output power of the communications equipment.

Rated maximum output power of transmitter W	Separation distance according to frequency of transmitter m		
	150 kHz to 80 MHz $d=1.2 \sqrt{P}$	80 MHz to 800 MHz $d=1.2 \sqrt{P}$	8000 MHz to 2.5 GHz $d=2.3 \sqrt{P}$
0.01	1.12	0.12	0.23
0.1	0.38	0.38	0.73
1	1.2	1.2	2.3
10	3.8	3.8	7.3
100	12	12	23

For transmitters rated at a maximum output power not listed above, the recommended separation distance d in meters (m) can be estimated using the equation applicable to the frequency of the transmitter, where P is the maximum output power rating of the transmitter in watts (W) according to the transmitter manufacturer.

Note 1

At 80 MHz and 800 MHz, the separation distance for the higher frequency range applies.

Note 2

These guidelines may not apply in all situations. Electromagnetic propagation is affected by absorption and reflection from structures, objects and people.

9. WARRANTY AND SERVICE

9.1 WARRANTY

The warranty term of the WANS 4040 General Purpose Hospital Bed, is two (2) years after date of delivery for the defects in material and workmanship. SCHRÖDER's obligation under this warranty is expressly limited to supplying replacement parts and labor for, or replacing, at its option, any product which is, in the sole discretion of schröder, found to be defective. If requested by SCHRÖDER, products or parts for which a warranty claim is made shall be returned to the factory. Any improper use or any alteration or repair by others in such manner as in schröder's judgment affects the product materially and adversely shall void this warranty. Any repair of schröder products using parts not provided or authorized by SCHRODER shall void this warranty. Removal of the product serial number label and any damage on the product serial number label voids this warranty. The warranty does not cover damages resulting from transporting or delivering of the product to the place of purchase. No employee or representative of SCHRODER is authorized to change this warranty in any way.

Warranty does not include any disposable items, I.V. poles (except for SCHRODER permanently attached poles), mattresses, batteries, or damage resulting from abuse.

9.2 TECHNICAL SERVICE

SCHRODER products are supported by dedicated Technical Service. Technical Service employees are factory trained and experienced personnel who are providing excellent service to minimize repair times. Simply call SCHRODER Technical Service at +90 850 202 77 50 or email to info@schroderhealth.de

10. TROUBLESHOOTING

PROBLEM	CAUSE	REMEDY
Bed does not operate;	<ol style="list-style-type: none"> 1. Power cable does not plug to the mains. 2. Power cable is damaged. 3. Nurse control unit or hand control unit may be locked. 4. Control box does not operate. 	<ol style="list-style-type: none"> 1. Ensure power cable and plugs are not damaged and then plug the power cable to the mains. 2. Replace the power cable by the authorized service personnel. 3. Nurse control Unit activation button should be checked. (On-off). Inspect the nurse control unit or hand control unit and make sure they are not locked. 4. Control box should be replaced, call the technical service.
When the system operates, <u>one of the actuators does not operate</u> and control box gives a “click” sound:	<ol style="list-style-type: none"> 1. Actuator cable may be out of the control box socket. 2. Actuator cable is damaged. 3. Actuator is damaged; 4. CPR wire remains stuck; 5. Control box is damaged. 	<ol style="list-style-type: none"> 1. Check socket connections of the control box. 2. Actuator cable should be replaced, call the service center. 3. Actuator should be replaced, call the service center. 4. Inspect CPR wire and nut adjustment. 5. Control box should be replaced, call the service center.
When the system operates, <u>one of the actuators does not operate</u> and control box does not give a “click” sound	<ol style="list-style-type: none"> 1. Nurse control unit or hand control unit may be partly locked. 2. Control unit is damaged, 3. Control box is damaged. 	<ol style="list-style-type: none"> 1. Inspect nurse control unit or hand control and make sure they are not locked. 2. Unplug side rail control unit from the socket and check for function with the nurse control unit. If function is restored, there may be a problem with one of the control units. Call technical service. 3. Control box should be replaced, call the service center.
Battery expire and does not give “click” sound:	<ol style="list-style-type: none"> 1. Battery completely discharged 2. Battery is damaged or expired. 	<ol style="list-style-type: none"> 1. Recharge the battery. 2. Battery should be replaced, call the service center.
System does not operate and actuators move slowly:	Power disconnection of the bed with the mains and it operates by battery.	<ol style="list-style-type: none"> 1. Power cable might have come out of the control panel; check it. 2. Check the connections of the power cable. 3. Check the socket. 4. Recharge the battery, call the service center.

<p>Failure Mode :</p> <p>Bed does not operate; E.g. due to actuator failure or power request error.</p> <p>When a failure mode occurs and a key is activated the system will beep fast, and if LED's are used for locking functions on "Nurse Control Pendant", these will blink quickly, except when powering down on battery.</p> <p>Failure indications:</p> <p>1) All Nurse Control Pendant LED's are blinking.</p> <p>2) The CB6 buzzer beeps shortly if a handset is activated.</p>	<p>1) Cable of controls pendants are plugged out.</p> <p>2) Cable of actuators are plugged out.</p> <p>3) Short circuit of any cables (cable of control pendants or actuators)</p> <p>4) If a function is specified but not all the actuators that are included in the function are present then a failure mode may occur.</p>	<p>1) Failure mode must be deleted deliberately. This is done by pressing the specified "failure mode keys" at the same time for 5 second.</p> <p>2) The error can be reset by activating the "Backrest Raising" button and "Backrest Lowering button from "Hand Control Pendant" or "Auto Contour (Up)" button and "trendelenburg Position" button from "Nurse Control Pendant"</p> <p>3) Pressing at the same time is important. If you press the buttons at the same time, you will hear buzzer you must keep pressing buttons until buzzer off app. 5 seconds</p> <div style="text-align: center;">  <p>a) Hand Control Pendant Buttons b) Nurse Control Pendant Buttons</p> </div> <p>4) Blinking will be stop. After this procedure you must Press CPR button in order to get all the actuators to their zero stroke position.</p> <p>5) Failure mode does not result in a position lost. It is up to the person who resets the fatal error that the system is in a safe position.</p>
---	--	--

11. ENVIRONMENTAL PROTECTION

Schröder is an environmentally conscious company. Environment-friendly materials are used to build the schröder WANS 4040 bed. Schröder does not use materials such as mercury, cadmium, polychlorinated biphenyls (PCB) or chlorofluorocarbon (CFC) that may cause damage to the environment. Schröder has already advise for recycling the material to be contacted with authorized recycling authority.



WARNING

The WANS 4040 General Purpose Hospital Bed has electrical and electronic equipment such as battery, actuators, control box, control boards, control pendant and cables. These equipments must not be disposed of as unsorted municipal waste, but should be collected separately. Refer to your local distributor or for return and/or collection systems available in your country. Do not dispose of the electrical and electronic equipment into a dustbin or garbage container.





Schröder™



PROMA MEDİKAL LİMİTED ŞİRKETİ
BAŞPINAR ORGANİZE OSB MAH.OSB 5.BÖLGE 83548 CAD.NO:6
ŞEHİTKAMİL GAZİANTEP/TURKEY

Web: www.schroderhealth.de / www.schroder.com.tr

E-mail: info@schroder.com.tr

Tel : +90 850 202 77 50

Fax : +90 850 202 77 50

All commercial rights and trademarks are property of the manufacturing firm. The manufacturer reserves its right to make modifications in the contents of this manual referring to any revisions and arrangements of the bed.