

User Manual



www.indesit.com/register



USER MANUAL



THANK YOU FOR BUYING A INDESIT PRODUCT.

In order to receive a more complete assistance,
please register your appliance on www.indesit.com/register

INDEX

HEALTH & SAFETY GUIDE.....	3
Safety Instructions.....	3
USER MANUAL.....	5
Product description.....	5
Detergent dispenser drawer.....	5
Technical data for water connection.....	5
Control panel.....	6
Wash cycles.....	6
Options.....	7
Push & Wash.....	8
Functions.....	9
Wash cycle table.....	10
Accessories.....	10
How to use the appliance.....	11
First time use.....	11
Daily use.....	11
Hints and tips.....	12
Cleaning & maintenance.....	13
Disconnect the water and power supplies.....	13
Clean the washing machine.....	13
Cleaning the detergent dispenser drawer.....	13
Care for the door and drum.....	13
Clean the pump.....	13
Check the water inlet hose.....	13
Troubleshooting.....	14
Manual door opening.....	15
Transport and handling.....	15
Service.....	16
INSTALLATION GUIDE.....	17

SAFETY INSTRUCTIONS

IMPORTANT TO BE READ AND OBSERVED

Before using the appliance, read these safety instructions. Keep them nearby for future reference. These instructions and the appliance itself provide important safety warnings, to be observed at all times. The manufacturer declines any liability for failure to observe these safety instructions, for inappropriate use of the appliance or incorrect setting of controls.

⚠ Very young children (0-3 years) should be kept away from the appliance. Young children (3-8 years) should be kept away from the appliance unless continuously supervised. Children from 8 years old and above and persons with reduced physical, sensory or mental capabilities or lack of experience and knowledge can use this appliance only if they are supervised or have been given instructions on safe use and understand the hazards involved. Children must not play with the appliance. Cleaning and user maintenance must not be carried out by children without supervision.

Never open the door forcibly or use it as a step.

PERMITTED USE

⚠ CAUTION: The appliance is not intended to be operated by means of an external switching device, such as a timer, or separate remote controlled system.

⚠ This appliance is intended to be used in household and similar applications such as: staff kitchen areas in shops, offices and other working environments; farm houses; by clients in hotels, motels, bed & breakfast and other residential environments.

⚠ Do not load the machine above the maximum capacity (kg of dry cloth) indicated in the programme table.

⚠ This appliance is not for professional use. Do not use the appliance outdoors.

⚠ Do not use any solvents (e.g. turpentine, benzene), detergents containing solvents, scouring powder, glass or general purpose cleaners, or flammable fluids; do not machine wash fabrics that have been treated with solvents or flammable liquids.

INSTALLATION

⚠ The appliance must be handled and installed by two or more persons - risk of injury. Use protective gloves to unpack and install - risk of cuts.

If you want to stack a dryer on top of your washing machine, first contact our After-Sales Service or your specialist dealer to verify whether this is possible. This is only possible if the dryer is attached to the washing machine by means of appropriate stacking kit available through our After-Sales Service or your specialist dealer.

⚠ Move the appliance without lifting it by the worktop or top lid.

⚠ Installation, including water supply (if any) and electrical connections and repairs must be carried out by a qualified technician. Do not repair or replace any part of the appliance unless specifically stated in the user manual. Keep children away from the installation site. After unpacking the appliance, make sure that it has not been damaged during transport. In the event of problems, contact the dealer or your nearest After-sales Service. Once installed, packaging waste (plastic, styrofoam parts etc.) must be stored out of reach of children - risk of suffocation. The appliance must be disconnected from the power supply before any installation operation - risk of electric shock. During installation, make sure the appliance does not damage the power cable - risk of fire or electric shock. Only activate the appliance when the installation has been completed.

⚠ Do not install your appliance where it may be exposed to extreme conditions, such as: poor ventilation, temperatures below 5 °C or above 35 °C.

⚠ When installing the appliance make sure that the four feet are stable and resting on the floor, adjusting them as required, and check that the appliance is perfectly to level using a spirit level.

⚠ If the appliance is being installed on wood or "floating" floors (certain parquet and laminate materials), secure a 60 x 60 x 3 cm (at least) sheet of plywood to the floor then place the appliance on top of this.

⚠ Connect the water inlet hose(s) to the water supply in accordance with the regulations of your local water company.

⚠ For cold fill only models: do not connect to the hot water supply.

⚠ For models with hot fill: the hot water inlet temperature must not exceed 60 °C.

⚠ The washing machine is fitted with transport bolts to prevent any possible damage to the interior during transport. Before using the machine, it is imperative that the transport bolts are removed. After their removal, cover the openings with the 4 enclosed plastic caps.

⚠ After installation of the device, wait a few hours before starting it so that it acclimates to the environmental conditions of the room.

⚠ Make sure that the ventilation openings in the base of your washing machine (if available on your model) are not obstructed by a carpet or other material.

⚠ Use only new hoses to connect the appliance to the water supply. The old hose-sets should not be reused.

⚠ The supply water pressure must be in the 01-1 Mpa range.

ELECTRICAL WARNINGS

⚠ It must be possible to disconnect the appliance from the power supply by unplugging it if plug is accessible, or by a multi-pole switch installed upstream of the socket in accordance with the wiring rules and the appliance must be earthed in conformity with national electrical safety standards.

⚠ Do not use extension leads, multiple sockets or adapters. The electrical components must not be accessible to the user after installation. Do not use the appliance when you are wet or barefoot. Do not operate this appliance if it has a damaged power cable or plug, if it is not working properly, or if it has been damaged or dropped.

⚠ If the supply cord is damaged, it must be replaced with an identical one by the manufacturer, its service agent or similarly qualified persons in order to avoid a hazard - risk of electric shock.

CLEANING AND MAINTENANCE

⚠ **WARNING:** Ensure that the appliance is switched off and disconnected from the power supply before performing any maintenance operation; never use steam cleaning equipment - risk of electric shock.

DISPOSAL OF PACKAGING MATERIALS

The packaging material is 100% recyclable and is marked with the recycle symbol .

The various parts of the packaging must therefore be disposed of responsibly and in full compliance with local authority regulations governing waste disposal.

DISPOSAL OF HOUSEHOLD APPLIANCES

This appliance is manufactured with recyclable or reusable materials. Dispose of it in accordance with local waste disposal regulations. For further information on the treatment, recovery and recycling of household electrical appliances, contact your local authority, the collection service for household waste or the store where you purchased the appliance. This appliance is marked in compliance with European Directive 2012/19/EU, Waste Electrical and Electronic Equipment (WEEE). By ensuring this product is disposed of correctly, you will help prevent negative consequences for the environment and human health.

The symbol  on the product or on the accompanying documentation indicates that it should not be treated as domestic waste but must be taken to an appropriate collection center for the recycling of electrical and electronic equipment.

PRODUCT DESCRIPTION

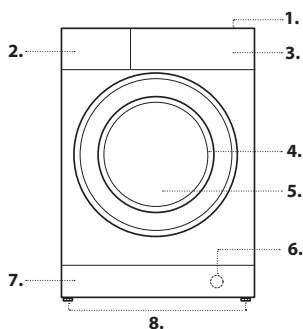

1. Worktop
2. Detergent dispenser
3. Control panel
4. Door handle
5. Door
6. Water filter - behind plinth
7. Plinth (removable)
8. Adjustable feet (4)

DETERGENT DISPENSER DRAWER

Successful washing results also depend on the correct dose of detergent: adding too much detergent will not necessarily result in a more efficient wash, and may in fact cause build up on the inside of your appliance and contribute to environmental pollution.

! Do not use hand washing detergents because these create too much foam.

! Use powder detergent for white cotton garments, for prewashing, and for washing at temperatures over 60°C.

! Follow the instructions given on the detergent packaging. Open the detergent dispenser drawer and pour in the detergent or washing additive, as follows.

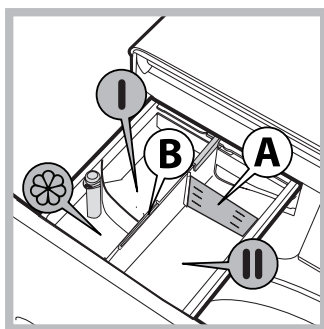

1. Compartment **II**: Washing detergent (powder or liquid)
 - If liquid detergent is used, the removable plastic partition **A** (supplied) should be used for proper dosage.
 - If powder detergent is used, insert the partition into slot **B**.
2. Compartment **I**
 - Do not insert detergent in this compartment.
3. Compartment : Additives (fabric softener, etc.)
 - The fabric softener must never exceed the "max" level indicated on the central pin.

TECHNICAL DATA FOR WATER CONNECTION

Water connection	
Water supply	Cold
Water tap	3/4" threaded hose connector
Minimum water supply pressure	100 kPa (1 bar)
Maximum water supply pressure	1000 kPa (10 bar)

CONTROL PANEL

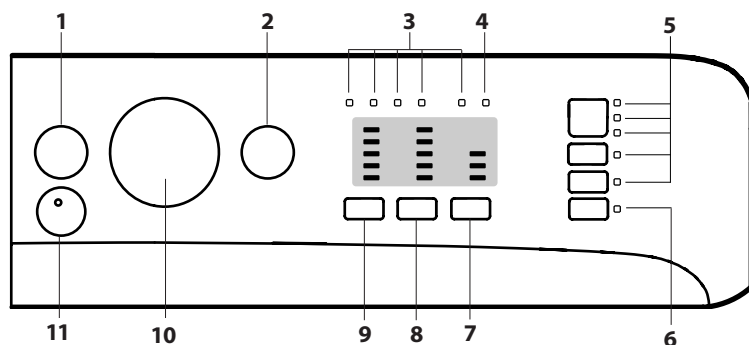

- 1 ON/OFF button
- 2 START/PAUSE button and indicator light
- 3 WASH CYCLE PHASE indicator lights
- 4 DOOR LOCKED indicator light
- 5 OPTION buttons and indicator lights
- 6 CHILDLOCK button and indicator light
- 7 DELAY START button
- 8 SPIN button
- 9 TEMPERATURE button
- 10 WASH CYCLE SELECTOR KNOB
- 11 PUSH & WASH button

WASH CYCLES

Follow the instructions on the symbols of the garment's wash care label. The value indicated in the symbol is the maximum recommended temperature for washing the garment.

DAILY COTTON

A 30°C cycle for cotton garments. It allows for reducing electricity consumption for heating the water while guaranteeing good washing performance. Suitable for lightly soiled garments.



DAILY SYNTHETICS

A 30°C cycle for synthetic garments. It allows for reducing electricity consumption for heating the water while guaranteeing good washing results. Suitable for lightly soiled garments.

COLOURED

A 30°C cycle that helps to preserve colours, suitable for cotton or synthetic coloured garments. It allows for reducing electricity consumption for heating the water while guaranteeing good washing results. Suitable for lightly soiled garments.

DELICATES

Suitable for washing very delicate garments. It is advisable to turn the garments inside out before washing them. For best results, use liquid detergent on delicate garments. For washing silk items and curtains, select cycle 4 and activate the  option; the machine will end the cycle with the laundry soaked and the indicator light will flash. To drain the water so that the laundry can be removed, press the START/PAUSE  button or the  button.

RAPID 30MIN

For washing lightly soiled garments in a short time. Not suitable for wool, silk and garments to be washed by hand.

COTTON

Suitable for washing towels, underwear, table cloths, etc. made of resistant linen and cotton that are moderately to heavily soiled.

SYNTHETICS

Suitable for washing moderately soiled garments made of synthetic fibres (e.g. polyester, polyacrylic, viscose, etc.) or mixed synthetic-cotton fibres.

Mixed

A 40°C cycle for washing cotton and synthetic garments together. Suitable for lightly soiled underwear.

ECO COTTON

Suitable for washing moderately soiled cotton garments. At 40°C and 60°C it is the standard cycle for washing cotton garments, and is the most efficient in terms of combined water and electricity consumption.

WHITE COTTON'

For heavily soiled whites and resistant colours.

SPORT

A cycle designed for washing lightly soiled sports clothing (tracksuits, shorts, etc.); for best results, we recommend not exceeding the maximum load indicated in the "Wash Cycle Table". We recommend using liquid detergent and adding the amount suitable for a half-load.

DUVET

For washing clothing padded with goose down, such as double or single duvets (weighing under 3.5 kg), cushions or down jackets. Duvets should be loaded into the drum with their edges folded inwards and no more than $\frac{3}{4}$ of the total drum volume should be used up. For best results, it is advisable to use liquid detergent to be poured into the detergent drawer.

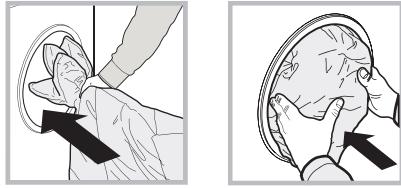
**WOOL - WOOLMARK APPAREL CARE - BLUE:**

The "Wool" wash cycle is approved by the Woolmark Company for washing wool garments classified as "hand-washable", provided that the wash complies with the instructions appearing on the garment's label and with those provided by the manufacturer of this washing machine. (M1127)

ANTI ODOUR

Use this cycle (for synthetic fabrics) to wash garments with bad odours (e.g. smoke, sweat, fried food). The cycle is designed to remove bad odours while preserving the fabric fibres.

RINSE + SPIN

Designed for rinsing and spinning.

SPIN + DRAIN

Designed to spin and drain the water.

OPTIONS

! If the selected option is not compatible with the set wash cycle, the indicator light will flash and the option will not be activated.
! If the selected option is not compatible with another previously selected option, the indicator light will flash accompanied by a buzzer (3 beeps), and only the latter option will be activated; the indicator light corresponding to the activated option will turn on.

 **ANTI-STAIN**

This option allows for selecting the type of dirt so as to optimally adjust the cycle for removing the stains. The following types of dirt can be selected:

 **Food**: for stains caused by foodstuffs and beverages, for example.

 **Work**: for grease and ink stains, for example.



 **Outdoor**: for mud and grass stains, for example.

! The wash cycle duration varies according to the type of selected dirt.

 **EXTRA RINSE**

By selecting this option, the efficiency of the rinse is increased and optimal detergent removal is guaranteed. It is particularly useful for sensitive skin.

 **EASY IRON**

By selecting this function, the wash and spin cycles will be modified in order to limit the formation of creases. At the end of the cycle the washing machine's drum will rotate slowly; the EASY IRON and START/PAUSE  indicator lights will flash and the  phase will remain lit steady. To end the cycle, press the START/PAUSE  button or the EASY IRON button.

 **DELAY START**

To set a delayed start for the selected cycle, press the corresponding button repeatedly until the desired delay period has been reached (3h-6h-9h). When the button is pressed for the fourth time, the option will deactivate. Once the START/PAUSE  button has been pressed, the delay time can only be modified by decreasing it until the set cycle is launched.

 **TEMPERATURE**

Each wash cycle has a pre-defined temperature. To modify the temperature, press the  button.

 **SPIN**



Each wash cycle has a pre-defined spin speed. To modify the spin speed, press the  button.

PUSH & WASH

This function allows for starting a wash cycle even when the machine is switched off without having to press the ON/OFF  button in advance or, after switching the machine on, without having activated any other button and/or selector knob (otherwise the Push & Wash cycle will be deactivated). To start the Push & Wash cycle press and hold the relative button for 2 seconds. The lit indicator light indicates that the cycle has started. This wash cycle is ideal for cotton or synthetic fabrics, as it washes at a temperature of 30°C and a maximum spin speed of 1,000 rpm. Max load 4 kg (cycle duration 45').

How does it work?

1. Load the laundry (cotton and/or synthetic garments) and close the door.
2. Pour the detergent and additives.
3. Start the cycle by pressing and holding the Push & Wash button for 2 seconds. The relevant indicator light will turn green and the door will lock (the  symbol lights up).

N.B.: starting the wash cycle through the Push & Wash button activates an automatic non-customisable cycle recommended for cotton and synthetic fabrics. This cycle does not allow for setting any additional options. To open the door while an automatic cycle is under way, press the START/PAUSE  button; if the locked door symbol  is off, the door may be opened. Press the START/PAUSE  button again to restart the cycle from the point at which it was interrupted.

4. Once the programme is finished, the  indicator light turns on.

FUNCTIONS



ON/OFF

button: switches the washing machine on and off.

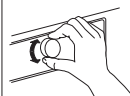

WASH CYCLE SELECTOR KNOB:

Used to set the desired wash cycle (see "Table of wash cycles").





START/PAUSE

Button with indicator light: starts or temporarily interrupts the wash cycles.

N.B.: To pause the wash cycle in progress, press this button; the corresponding indicator light will flash orange, while the indicator light for the current wash cycle phase will remain lit in a fixed manner. If the DOOR LOCKED  indicator light is switched off, the door may be opened (wait approximately 3 minutes). To start the wash cycle from the point at which it was interrupted, press this button again.



CHILD LOCK

To activate the control panel lock, press and hold the button for approximately 2 seconds. The lit  symbol signals that the control panel is locked. This prevents wash cycles from being modified accidentally (except for the ON/OFF  button), especially if there are children in the home. To deactivate the control panel lock, press and hold the button for approximately 2 seconds.

INDICATOR LIGHTS

The indicator lights provide important information. This is what they can tell you:

Delayed start

If the DELAY TIMER function has been activated (see "Personalisation"), after the wash cycle has been started the indicator light corresponding to the selected delay period will begin to flash:







As time passes, the remaining delay will be displayed and the corresponding indicator light will flash:



The set programme will start once the selected time delay has expired.

Wash cycle phase indicator lights

Once the desired wash cycle has been selected and has begun, the indicator lights switch on one-by-one to indicate which phase of the cycle is currently in progress.





-  Wash
-  Rinse
-  Spin
-  Drain
-  End of Wash Cycle

Door locked indicator

When lit, the symbol indicates that the door is locked. To prevent any damage, wait until the symbol turns off before opening the door.

To open the door while a cycle is in progress, press the START/PAUSE  button; if the indicator light is off, the door can be opened.

WASH CYCLE TABLE

Maximum load 8 kg Power input in off mode 0.5 W / in left-on mode 8 W							Detergents and Additives		Recommended detergent		Residual dampness %	Energy consumption kWh	Total water l
Wash cycle		Temperature		Maximum spin (r.p.m.)	Maximum load (kg)	Duration (minutes)	Wash	Fabric softener	Powder	Liquid			
		Default	Range				II						
1	Daily cotton	30°C	❄ - 30°C	1000	4.0	100	●	○	-	✓	-	-	-
2	Daily synthetics	30°C	❄ - 30°C	1000	4.0	90	●	○	-	✓	-	-	-
3	Coloureds	30°C	❄ - 30°C	1000	4.0	95	●	○	-	✓	-	-	-
4	Delicates	30°C	❄ - 30°C	0	1.0	80	●	○	-	✓	-	-	-
5	Rapid 30min	30°C	❄ - 30°C	800	4.0	30	●	○	-	✓	70	0.18	42
6	Cotton (2)	40°C	❄ - 60°C	1400	8.0	220	●	○	✓	✓	53	1.03	92
7	Synthetics (3)	40°C	❄ - 60°C	1000	4.0	200	●	○	✓	✓	32	0.80	78
8	Mixed	40°C	❄ - 40°C	1400	8.0	105	●	○	-	✓	-	-	-
9	Eco cotton  (1)	60°C	60°C	1400	8.0	225	●	○	✓	✓	53	1.04	55
			40°C	1400	8.0	220	●	○	✓	✓	53	1.03	92
10	White cotton	60°C	❄ - 90°C	1400	8.0	175	●	○	✓	✓	-	-	-
11	Sport	30°C	❄ - 30°C	600	4.0	60	●	○	-	✓	-	-	-
12	Duvet	30°C	❄ - 30°C	1000	3.5	115	●	○	-	✓	-	-	-
13	Wool	40°C	❄ - 40°C	800	2.0	85	●	○	-	✓	-	-	-
14	Anti odour	40°C	❄ - 40°C	1000	3.5	105	●	○	-	✓	-	-	-
	Rinse + Spin	-	-	1400	8.0	55	-	○	-	-	-	-	-
	Spin + Drain *	-	-	1400	8.0	10	-	-	-	-	-	-	-

● Required dosage ○ Optional dosage

The cycle duration indicated on the display or instruction manual is an estimate based on standard conditions. The actual duration may vary in relation to several factors, such as the temperature and pressure of the incoming water, ambient temperature, amount of detergent, load quantity and type, load balancing and any additional options selected.

Test wash cycle in compliance with regulation 1061/2010:

1) This cycle is designed for normally soiled cotton loads and is the most efficient in terms of both electricity and water consumption; it should be used for garments washable at 60°C or at 40°C. The actual washing temperature may differ from the indicated value.

For all testing institutes:

- 2) Long cotton cycle: set cycle 6 at a temperature of 40°C.
- 3) Long synthetics cycle: set cycle 7 at a temperature of 40°C.

* By selecting the  cycle and excluding the spin cycle, the washing machine will drain only.

ACCESSORIES

Contact our Technical Assistance Service to check whether the following accessories are available for this washing machine model.

Stacking kit

With this accessory you can secure the tumble dryer to the upper part of your washing machine to save space and facilitate loading and unloading of the tumble dryer.

HOW TO USE THE APPLIANCE

FIRST TIME USE

Once the appliance has been installed, and before it is used for the first time, run a wash cycle with detergent and no laundry, by setting the "Auto-Clean" cycle.

DAILY USE

PREPARING THE LAUNDRY



Empty the pockets

- Objects such as coins or lighters can damage the washing machine and the drum. Check all buttons.





Divide the laundry according to

- Type of fabric (cotton, mixed fibres, synthetics, wool,

garments to be hand-washed). Colour (separate coloured garments from whites, wash new coloured garments separately). Delicates (small garments – such as nylon stockings – and items with hooks – such as bras: insert them in a fabric bag).

RUNNING A WASH CYCLE









Rapid programming



1. Open the door. Load the laundry while making sure not to exceed the maximum load quantity indicated in the cycle table. 
2. Pull out the detergent dispenser drawer and pour the detergent into the relevant compartments as described in "DETERGENT DISPENSER DRAWER" section. 
3. Close the door. 
4. Press the PUSH & WASH button to start the wash cycle. 

7. Select the desired options.



- If the selected option is not compatible with the set wash cycle, the indicator light will flash and the option will not be activated.
- If the selected option is not compatible with another previously selected option, the indicator light will flash accompanied by a buzzer (3 beeps), and only the latter option will be activated; the indicator light corresponding to the activated option will turn on.

Traditional programming





1. Turn the washing machine on by pressing the ON/OFF  button. All the indicator lights will light up for a few seconds, then only the lights corresponding to the settings for the selected wash cycle will remain lit; the START/PAUSE  indicator light will also flash.
2. Open the door. Load the laundry while making sure not to exceed the maximum load quantity indicated in the Wash Cycle Table. 
3. Pull out the detergent dispenser drawer and pour the detergent into the relevant compartments as described in "DETERGENT DISPENSER DRAWER" section. 
4. Close the door. 
5. Set the WASH CYCLE knob to the desired cycle. 
6. Modify the temperature and/or spin: pressing the °C  button allows for gradually reducing the temperature down to the cold wash level (20°C). The spin speed may be progressively reduced by pressing the  button, until it is completely excluded (the "0" setting). If these buttons are pressed again, the maximum values are restored.

8. Press the START/PAUSE  button to start the wash cycle; the relative indicator light will light up steady green and the door will lock ( symbol on).



PAUSING A CYCLE

To pause the wash cycle, press the START/PAUSE  button again; the indicator light will flash amber. If the  symbol is not lit, the door may be opened. To start the wash cycle from the point at which it was interrupted, press the START/PAUSE  button again.

OPENING THE DOOR, IF NECESSARY



Once a cycle starts, the  symbol turns on to signal that the door cannot be opened. While a wash cycle is running, the door remains locked. To open the door while a cycle is under way, for example, to add or remove garments, press the START/PAUSE  button to pause the cycle; the indicator light will flash amber. If the  symbol is not lit, the door may be opened. Press the START/PAUSE  button again to continue the cycle.

CHANGING A RUNNING WASH CYCLE

To change a wash cycle while it is in progress, pause the washing machine using the START/PAUSE  button (the relative indicator light will flash amber), then select the desired cycle and press the START/PAUSE  button again.

! To cancel a cycle that has already begun, press and hold the ON/OFF  button. The cycle will be stopped and the machine will switch off.

END OF THE CYCLE

Once the cycle terminates the  indicator light will light up; when the  indicator light switches off, the door may be opened. Open the door, unload the laundry and switch off the machine. If you do not press "ON/OFF"  button, the washing machine will switch off automatically after about a half of an hour. Close the water tap, open the door and unload the washing machine. Leave the door ajar to allow the drum to dry.





! If you wish to cancel a cycle which has already begun, press and hold the "ON/OFF"  button. The cycle will be stopped and the machine will switch off.

HINTS AND TIPS**RULES FOR SEPARATING LAUNDRY**

- Fabric type / indications on label (cotton, mixed fibres, synthetic, wool, handwash items)
- Colour (separate coloured garments from whites, wash new coloured items separately)
- Size (wash items of different sizes in the same load to improve washing efficacy and weight distribution in the drum)
- Delicates (place small items – such as nylon stockings – and garments with clasps – such as braziers – in a laundry bag or in a pillow case with a zip).

WASH SYMBOLS ON GARMENT LABELS

The value given in the tub symbol is the maximum temperature possible for washing the garment.

-  Normal mechanical action
-  Reduced mechanical action
-  Much reduced mechanical action
-  Hand wash only
-  Do not wash

Load balancing system

Before every spin cycle, to avoid excessive vibrations before every spin and to distribute the load in a uniform manner, the drum rotates continuously at a speed which is slightly greater than the washing rotation speed. If, after several attempts, the load is not balanced correctly, the machine spins at a reduced spin speed. If the load is excessively unbalanced, the washing machine performs the distribution process instead of spinning. To encourage improved load distribution and balance, we recommend small and large garments are mixed in the load.

CLEAN THE WATER FILTER REGULARLY

- This is needed to prevent the filter from blocking and preventing the water from draining correctly.

HOW MUCH DOES YOUR LAUNDRY WEIGH?

- 1 sheet 400-500 g
- 1 pillow case 150-200 g
- 1 tablecloth 400-500 g
- 1 bathrobe 900-1.200 g
- 1 towel 150-250 g

CLEANING & MAINTENANCE

Before performing cleaning and maintenance, switch the washing machine off and disconnect it from the mains power. Do not use flammable liquids to clean the washing machine.



DISCONNECT THE WATER AND POWER SUPPLIES

Close the water tap after every wash. This will limit wear on the hydraulic system inside the washing machine and help to prevent leaks.

Unplug the washing machine when cleaning it and during all maintenance work.

CLEAN THE WASHING MACHINE

The outer parts and rubber components of the appliance can be cleaned using a soft cloth soaked in lukewarm soapy water. Do not use solvents or abrasives.

The washing machine has a "Auto-cleaning" cycle for its internal parts; it must be run without any load in the drum. To optimise this cycle, it is possible to use either detergent (10% of the quantity specified for lightly soiled garments) or special additives to clean the washing machine. We recommend running a cleaning cycle every 40 wash cycles. To start the cycle press buttons  and  simultaneously for 5 seconds.

The cycle will start automatically and will run for about 70 minutes. To stop the cycle, press the START/PAUSE  button.

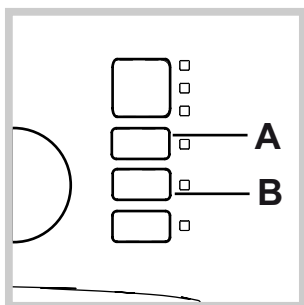

CLEANING THE DETERGENT DISPENSER DRAWER

To remove the drawer, press lever (1) and pull the drawer outwards (2) (see figure). Wash it under running water; this procedure should be repeated frequently.

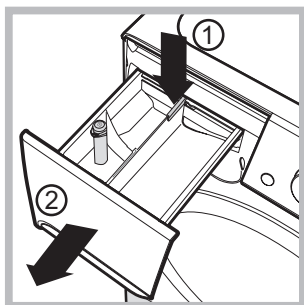

CARE FOR THE DOOR AND DRUM

Always leave the porthole door ajar in order to prevent unpleasant odours from forming.

CLEAN THE PUMP

The washing machine is fitted with a auto-cleaning pump that does not require any maintenance. Small items (such as coins or buttons) may sometimes fall into the protective pre-chamber situated at the base of the pump.

! Make sure the wash cycle has ended and unplug the appliance.

To access the pre-chamber:

1. Remove the cover panel on the front of the machine by first pressing it in the centre then pushing downwards on both sides to extract it;

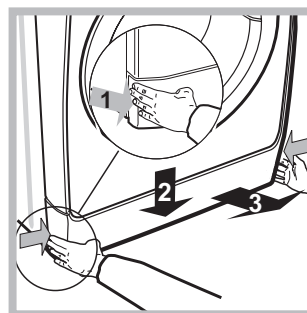

2. Loosen the drainage pump cover by turning it anti-clockwise: it is normal for some water to leak out;

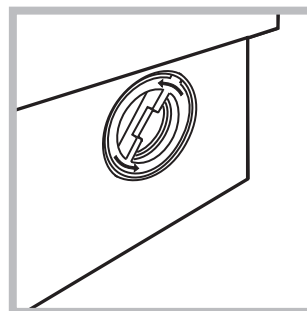

3. Clean the inside thoroughly;
4. Screw the cover back on;
5. Put the panel back in place, making sure the hooks slot in place before pushing the panel onto the appliance.





CHECK THE WATER INLET HOSE

Check the water inlet hose at least once a year. If it is cracked or broken, it must be replaced: during wash cycles, the high pressure of the water could suddenly split the hose open.

! Never use hoses that have already been used.

TROUBLESHOOTING

The washing machine may occasionally fail to work. Before contacting the Technical Assistance Service, make sure that the problem cannot be easily solved using the following list.

Anomalies	Possible causes / Solution
The washing machine does not start.	The appliance is not plugged into the socket, or not sufficiently to make contact.
	There is no power in the house.
The wash cycle does not start.	The washing machine door is not closed properly.
	The ON/OFF  button has not been pressed.
	The START/PAUSE  button has not been pressed.
	The water tap has not been opened.
	A delay has been set for the start time.
The machine does not fill with water or the indicator light for the first wash cycle stage flashes rapidly.	The water inlet hose is not connected to the tap.
	The hose is bent.
	The water tap has not been opened.
	There is no water supply in the house.
	The pressure is too low.
	The START/PAUSE  button has not been pressed.
The washing machine continuously loads and unloads water.	The drain hose is not fitted between 65 and 100 cm from the floor.
	The free end of the hose is immersed in water.
	The wall drainage system does not have a breather pipe.
	If the problem persists even after these checks, turn off the water tap, switch the appliance off and contact the Technical Assistance Service. If the home is on one of the upper floors of a building, there may be problems relating to back-siphonage, causing the washing machine to fill with water and drain continuously. Special anti-siphon valves are available in shops and help to prevent this inconvenience.
	The cycle does not include drainage: with certain cycles it must be started manually.
The washing machine does not drain or spin.	The drain hose is bent.
	The  option is enabled: to complete the wash cycle, press the START/PAUSE  button.
	The drainage duct is clogged.
	The drum was not unlocked correctly during installation.
The washing machine vibrates a lot during the spin cycle.	The washing machine is not level.
	The washing machine is tucked between furniture cabinets and the wall.
	The water inlet hose is not screwed on properly.
The washing machine leaks.	The detergent dispenser drawer is obstructed.
	The drain hose is not properly attached.
	Switch off the machine and unplug it, wait for approximately 1 minute and then switch it back on again. If the problem persists, contact the Technical Assistance Service .
The "Options" lights and the START/PAUSE indicator light flash while one of the wash cycle progress and DOOR LOCKED lights are lit in a fixed manner.	
There is too much foam.	The detergent is not suitable for machine washing (it should be marked with "for washing machine use" or "hand wash and machine wash" or similar).
	Too much detergent was used.
The Push & Wash function does not activate.	After switching on the machine, a control other than Push & Wash was activated. Switch the machine off and press the Push & Wash button.

TRANSPORT AND HANDLING

Do not lift the washing machine by gripping it from the upper section.

1. Unplug the appliance and close the water tap.
 2. Check that the door and detergent dispenser drawer are tightly closed.
 3. Detach the filling hose from the water tap then detach the drain hose.
 4. Empty all the water remaining in the hoses and secure the latter so that they do not get damaged during transport.
 5. Apply the transport bolts back on. Repeat, in reverse order, the transport bolt removal procedure described in the "Health & Safety and Installation Guides".
- Important:** Do not transport the washing machine without having fixed the transport bolts.

ELECTRICAL CONNECTION

FOR GREAT BRITAIN ONLY

Warning - this appliance must be earthed.

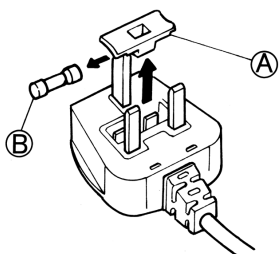

Fuse replacement

If the mains lead of this appliance is fitted with a BS 1363A 13amp fused plug, to change a fuse in this type of plug use an A.S.T.A. approved fuse to BS 1362 type and proceed as follows:

1. Remove the fuse cover (A) and fuse (B).
2. Fit replacement 13A fuse into fuse cover.
3. Refit both into plug.

Important:

The fuse cover must be refitted when changing a fuse and if the fuse cover is lost the plug must not be used until a correct replacement is fitted. Correct replacement are identified by the colour insert or the colour embossed in words on the base of the plug. Replacement fuse covers are available from your local electrical store.

For the Republic of Ireland only

The information given in respect of Great Britain will frequently apply, but a third type of plug and socket is also used, the 2-pin, side earth type.

Socket outlet / plug (valid for both countries)

If the fitted plug is not suitable for your socket outlet, Please contact After-Sales service for further instruction. Please do not attempt to change plug yourself. This procedure needs to be carried out by a qualified technician in compliance with the manufactures instructions and current standard safety regulations.

SERVICE

BEFORE CONTACTING THE TECHNICAL ASSISTANCE SERVICE

- Check whether you can solve the problem alone (see "Troubleshooting").
 - Restart the wash cycle to check whether the problem has been solved.
 - If this is not the case, contact an authorised Technical Assistance Centre.
- ! Always request the assistance of authorised technicians.

CONTACT OUR TECHNICAL ASSISTANCE SERVICE

If after the above checks the fault still occurs, get in touch with the nearest Technical Assistance Service (See phone number in the warranty booklet)

Have the following information to hand:

- the type of problem;
- the appliance model (Mod.);
- the serial number (S/N).

This information can be found on the data plate applied to the rear of the washing machine, and can also be found on the front of the appliance by opening the door.

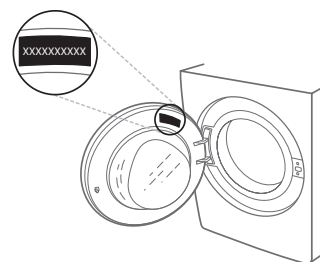

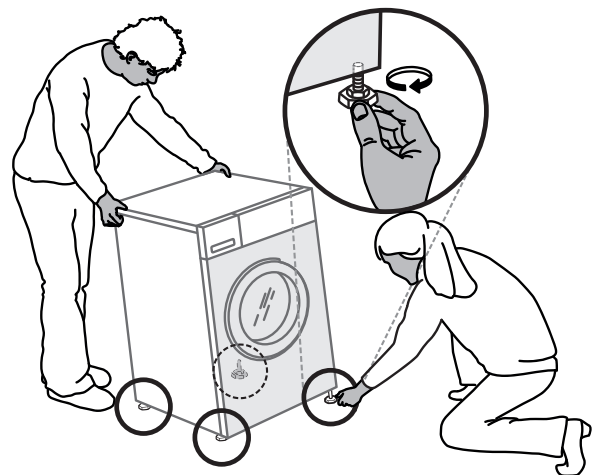
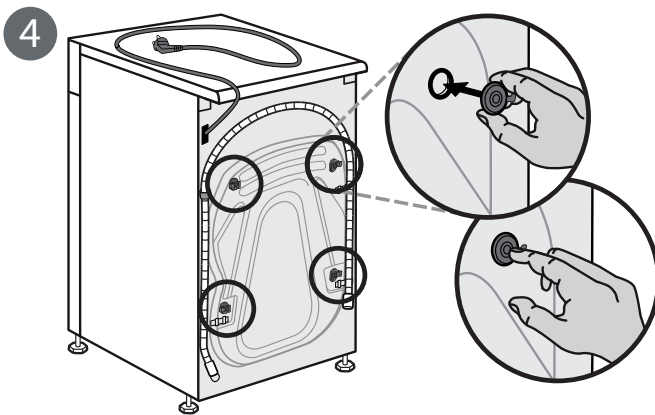
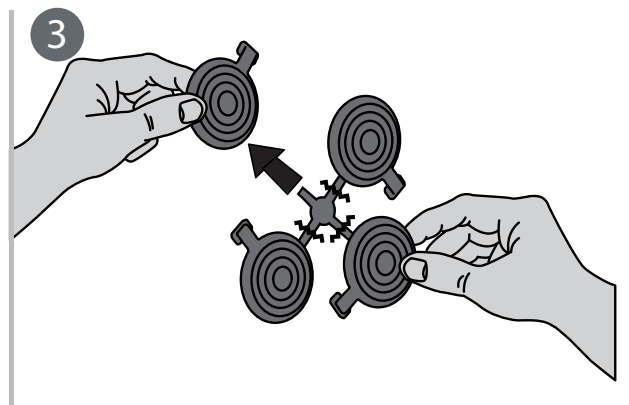
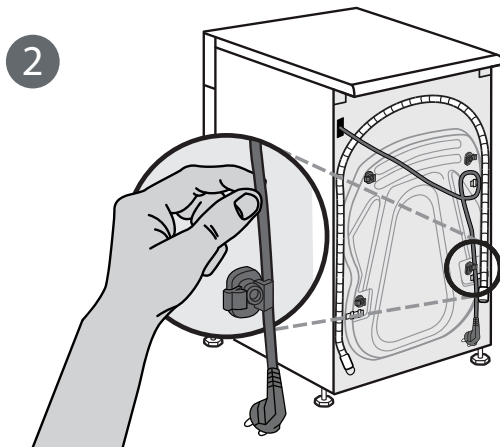
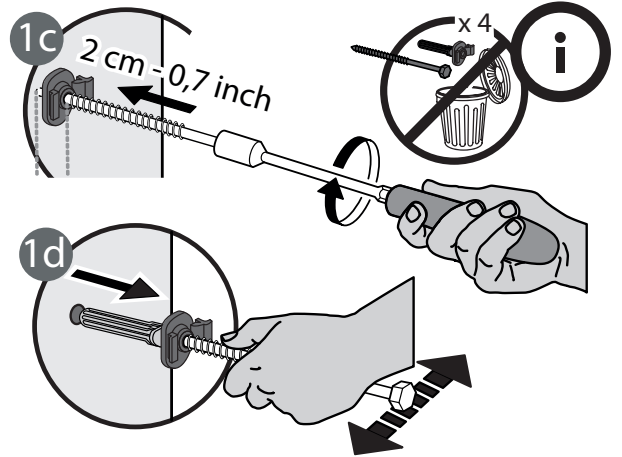
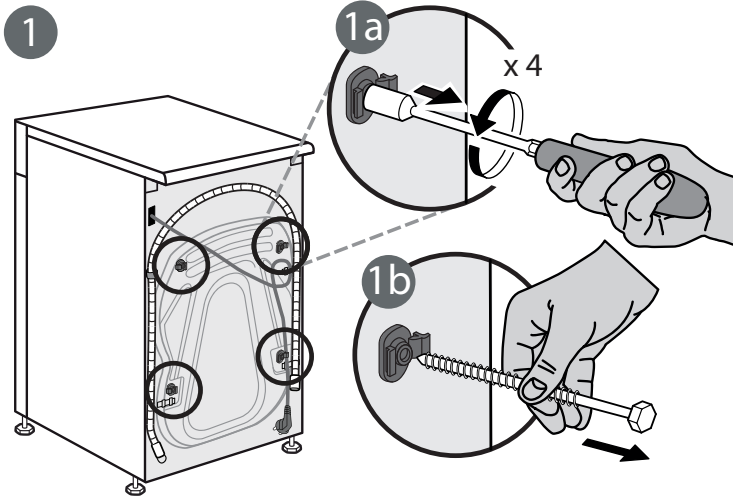
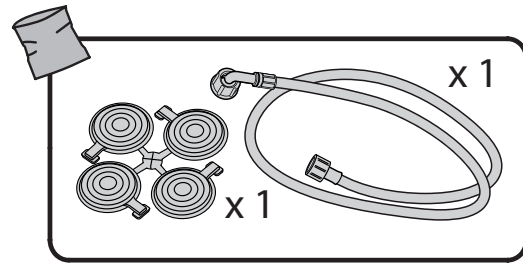
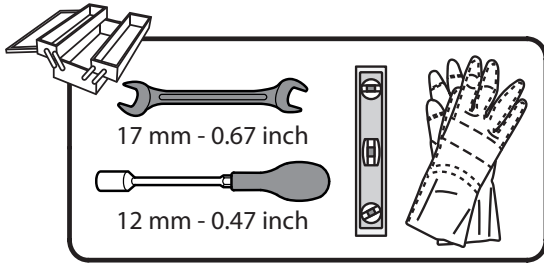

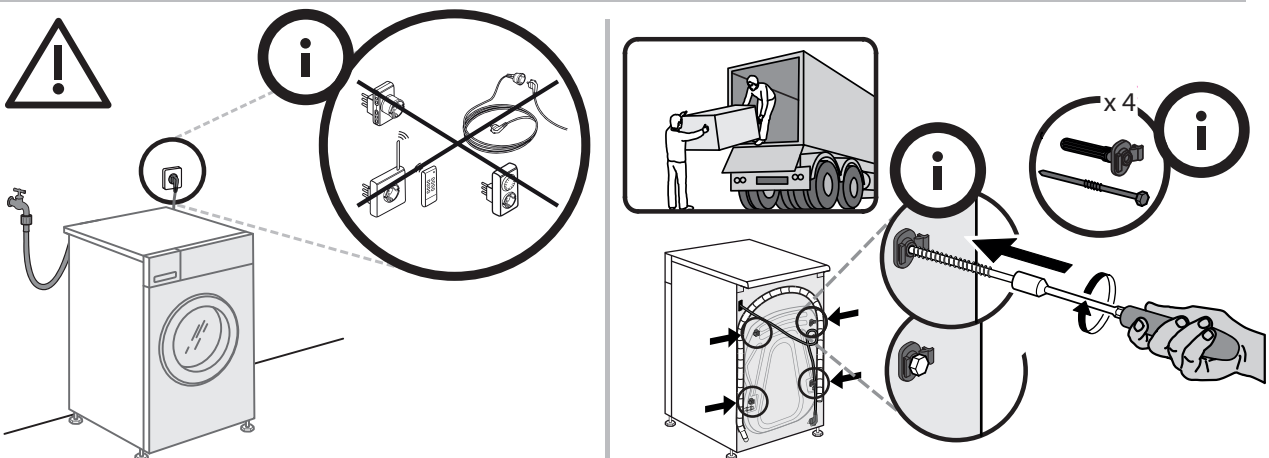
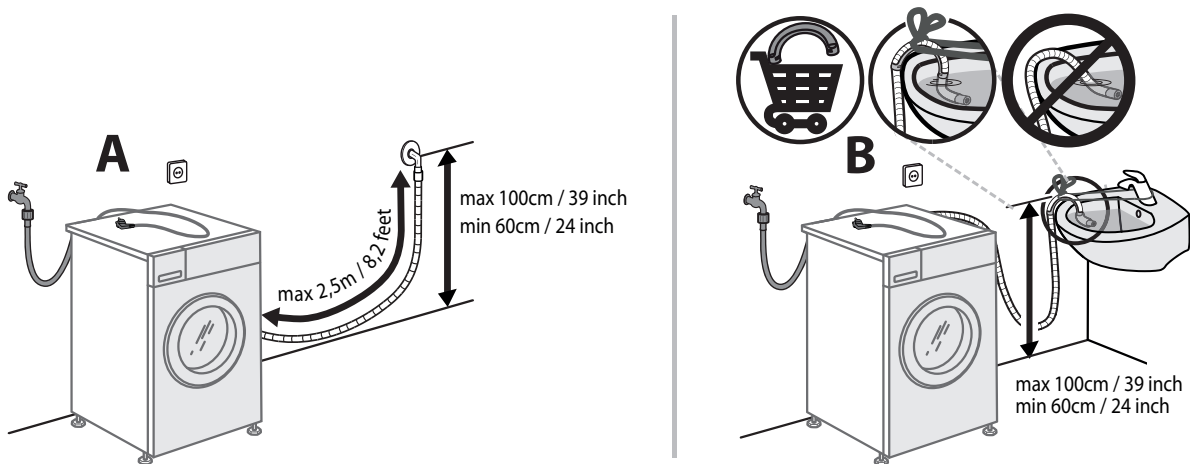
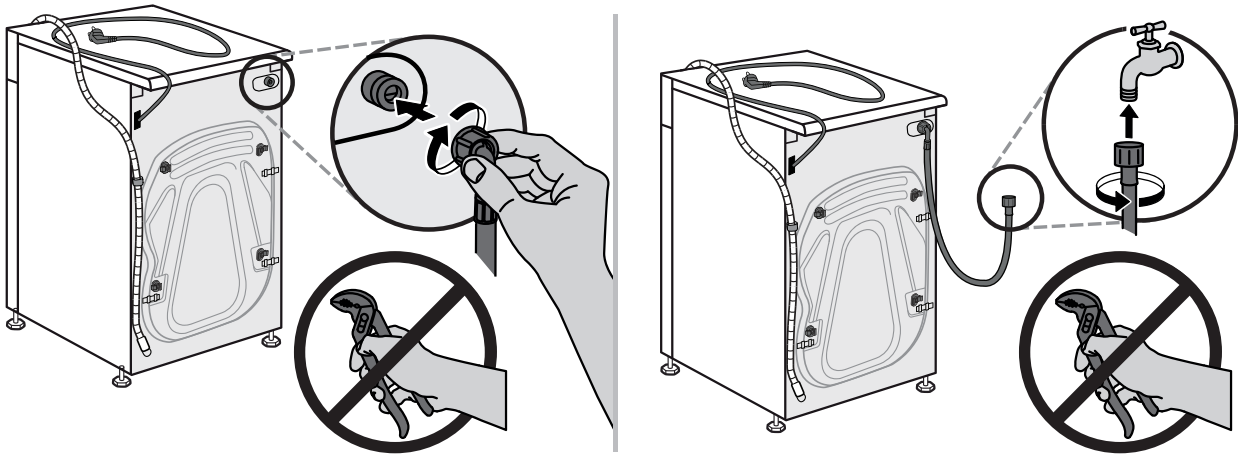
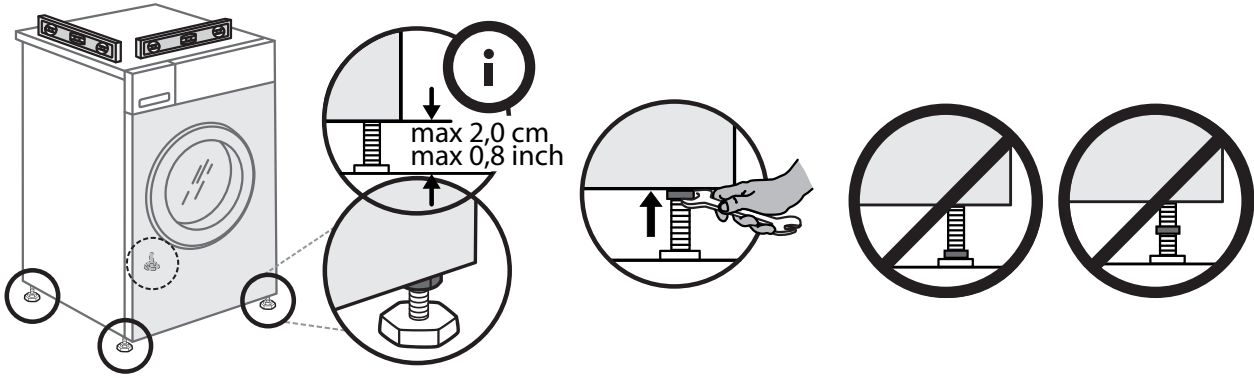

859991534360EN