

**Easy KIT** 

## **Sistem de canalizare interioară**

PP drainage system in buildings

Система внутренней канализации



**VALROM**  
INDUSTRIE

instalații pentru apă, gaz și canalizare



## **Sistem de canalizare interioară**

PP drainage system in buildings

Система внутренней канализации

## **Cuprins**

Content / Содержание

### **Tubulatură PP pentru canalizări interioare**

PP Pipes for interior sewage / ПП Трубы для внутренней канализации

### **Fitinguri PP pentru canalizări interioare**

PP Fittings for interior sewage / ПП Фитинги для внутренней канализации

### **Tubulatura și fittinguri pentru canalizări interioare PP alb**

Pipes and fittings for interior sewage PP white

Трубы и фитинги для внутренней канализации белый ПП

### **Accesorii**

Accessories / Аксессуары

### **Sifoane pentru obiecte sanitare**

Plumbing traps / Сифоны для сантехники

### **Sifoane pentru aer condiționat și de ventilație**

Traps for air condition and ventilation /

Сифоны для кондиционирования воздуха и вентиляции

### **Sifoane baie**

Bath traps / Сифоны для ванн

### **Sifoane pardoseală circulabile**

Circulated-floor drains / Напольный сифон

### **Receptori pentru acoperișuri**

Roof drains / Кровельные воронки

### **Receptori pentru balcoane și terase**

Balcony and terrace drains / Трап для балконов и террас

### **Receptori mari pentru parcări și terase**

Major drains for with car parkings and terraces / Напольные трапы для парковок и террас

### **Piesă de trecere prin fundațiile clădirilor**

Pipe sleeve through building foundations /

Переходник для прокладки трубопроводов через фундаменты зданий

### **Sistem fonoabsorbant pentru canalizare interioară Valsir - TRIPLUS**

Valsir – TRIPLUS soundproof sewage system / Канализационная система Valsir – TRIPLUS

### **Sistem fonoabsorbant pentru canalizare interioară Valsir - SILERE**

Valsir- SILERE soundproof sewage system / Канализационная система Valsir – SILERE

### **Scheme tip pentru canalizare interioară**

Scheme for interior sewage / Стандартные схемы для внутренней канализации





## Tubulatură PP canalizări interioare

PP pipes for interior sewage / ПП Трубы для внутренней канализации

### Tub PP cu 1 mufă

PP single socket pipe  
Труба ПП с 1 раструбом

DN	S	L			HxLxL palet		Cod code/код
					[mm]		
32	1,8	250	36	2160	800 x 1200		11032025000
		500	36	2160	1600 x 1200		11032050000
		750	36	1440	1200 x 1200		11032075000
		1000	36	720	800 x 1200		11032100000
		1500	36	720	1200 x 1200		11032150000
		2000	36	720	1600 x 1200		11032200000
40	1,8	250	25	1500	800 x 1200		11040025000
		500	25	1500	1600 x 1200		11040050000
		750	25	1000	1200 x 1200		11040075000
		1000	25	500	800 x 1200		11040100000
		1500	15	525	1200 x 1200		11040150000
		2000	15	525	1600 x 1200		11040200000
50	1,8	250	30	1080	800 x 1200		11050025000
		500	30	1080	1600 x 1200		11050050000
		750	30	720	1200 x 1200		11050075000
		1000	30	360	800 x 1200		11050100000
		1500	15	360	1200 x 1200		11050150000
		2000	15	360	1600 x 1200		11050200000
75	1,9	250	30	540	800 x 1200		11075025000
		500	30	540	1600 x 1200		11075050000
		1000	15	180	800 x 1200		11075100000
		1500	15	180	1200 x 1200		11075150000
		2000	15	180	1600 x 1200		11075200000
		3000	15	180	2600 x 1200		11075300000
110	2,7	250	10	240	800 x 1200		11110025000
		500	10	240	1600 x 1200		11110050000
		750	10	160	1200 x 1200		11110075000
		1000	10	80	800 x 1200		11110100000
		1500	10	80	1200 x 1200		11110150000
		2000	10	80	1600 x 1200		11110200000
125	3,1	250	8	192	800 x 1200		11125025000
		500	8	192	1600 x 1200		11125050000
		1000	8	64	800 x 1200		11125100000
		1500	8	64	1200 x 1200		11125150000
		2000	8	64	1600 x 1200		11125200000
		3000	8	64	2600 x 1200		11125300000
160	3,9	500	6	108	1600 x 1200		11160050000
		1000	6	36	800 x 1200		11160100000
		1500	6	36	1200 x 1200		11160150000
		2000	6	36	1600 x 1200		11160200000
		3000	6	36	2600 x 1200		11160300000

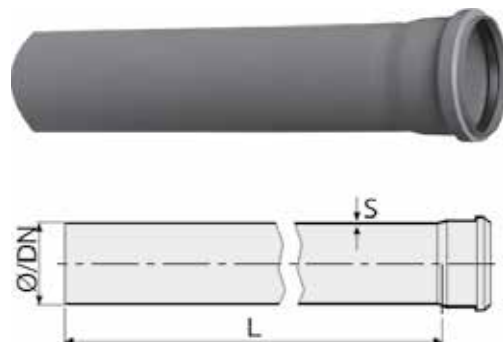

Material: polipropilenă  
Culoare gri: RAL 7037  
Temperatura maximă de lucru:  
80°C (curgere continuă),  
95°C (curgere intermitentă)

Material: polypropylene  
Colour gray: RAL 7037  
Maximum working temperature:  
80°C (continuous discharge),  
95°C (intermittent discharge)

Материал: полипропилен  
Цвет серый: RAL 7037  
Максимальная рабочая температура:  
80°C (постоянный поток),  
95°C (непостоянный поток)

## Fitinguri PP pentru canalizări interioare

PP fittings for interior sewage / ПП Фитинги для внутренней канализации

### Cot PP 15°

15° PP bend

Колено ПП 15°

DN [mm]			HxLxI palet	Cod code/код
			[mm]	
32	80	3840	970x1200x800	15040103215
40	50	1600	850x1200x800	15041304015
50	30	960	850x1200x800	15042505015
75	20	640	1010x1200x800	15044107515*
110	20	240	970x1200x800	15044911015



### Cot PP 30°

30° PP bend

Колено ПП 30°

DN [mm]			HxLxI palet	Cod code/код
			[mm]	
32	80	3840	970x1200x800	15040303230
40	50	1600	850x1200x800	15041504030
50	30	960	850x1200x800	15042705030
75	20	640	1010x1200x800	15044107530*
110	20	240	970x1200x800	15045111030



### Cot PP 45°

45° PP bend

Колено ПП 45°

DN [mm]			HxLxI palet	Cod code/код
			[mm]	
32	85	6800	2260x1200x800	15040603245
40	100	10800	2280x1200x800	15041804045
50	70	7560	2280x1200x800	15043005045
75	20	480	1015x1200x800	15044107545
110	38	648	2050x1200x800	15045411045
125	20	120	940x1200x800	15046512545
160	10	80	940x1200x800	15047716045









**Cot PP 67°30'**

67°30' PP bend

Колено ПП 67°30'

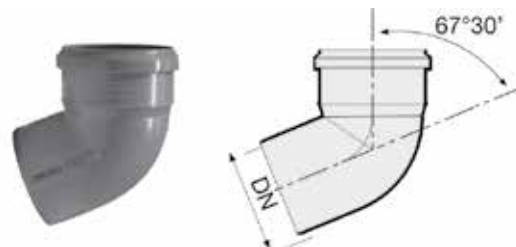

DN [mm]			HxLxI palet	Cod code/код
			[mm]	
32	60	6800	2260x1200x800	15040803267
40	55	12420	2280x1200x800	15042004067
50	70	7560	2280x1200x800	15043205067
75	20	480	1015x1200x800	15044307567
110	35	480	2050x1200x800	15045611067
125	15	120	940x1200x800	15046712567



**Cot PP 87°30'**

87°30' PP bend

Колено ПП 87°30'

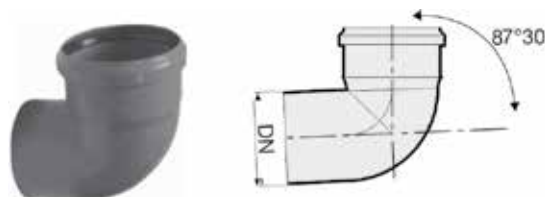

DN [mm]			HxLxI palet	Cod code/код
			[mm]	
32	70	5600	2260x1200x800	15041203287
40	90	9720	2280x1200x800	15042404087
50	70	6480	2280x1200x800	15043605087
75	20	480	1015x1200x800	15044707587
110	30	480	2050x1200x800	15046011087
125	10	120	1039x1200x800	15047112587
160	10	80	1300x1200x800	15048316087



**Ramificație egală PP 45°**

45° PP branch

Прямое разветвление ПП 45°

DN	L			HxLxI palet	Cod code/код
				[mm]	
32	128	50	5600	2260x1200x800	15080203245
40	170	55	2970	2280x1200x800	15080804045
50	180	55	1760	2280x1200x800	15081405045
75	220	20	240	970x1200x800	15081907545
110	286	16	240	2050x1200x800	15082611045
125	318	20	80	1300x1200x800	15083112545
160	410	10	40	930x1200x800	15083716045

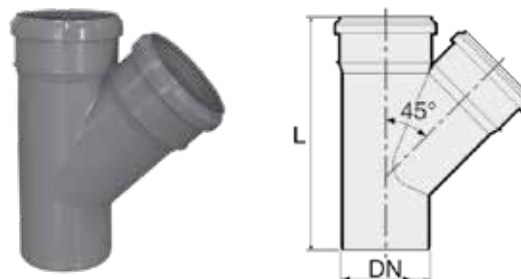

### Ramificație egală PP 67° 30'

67°30' PP branch

Прямое разветвление ПП 67°30'

DN	L			HxLxI palet	Cod
[mm]				[mm]	code/код
32	137	40	1280	2260x1200x800	15080303267
40	171	20	640	850x1200x800	15080904067
50	164	50	1800	2470x1200x800	15081605067
75	198	20	240	970x1200x800	15082107567
110	243	20	240	2050x1200x800	15082811067
125	332	5	60	1039x1200x800	15083312567*
160	421	1	32	930x1200x800	15083916067*

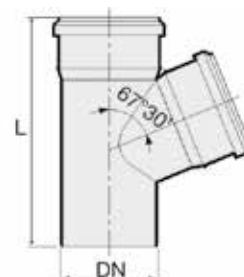

### Ramificație egală PP 87° 30'

87°30' PP branch

Прямое разветвление ПП 87°30'

DN	L			HxLxI palet	Cod
[mm]				[mm]	code/код
32	120	50	5600	2260x1200x800	15080603287
40	171	60	3240	2280x1200x800	15081204087
50	161	40	2160	2280x1200x800	15081805087
75	197	20	240	853x1200x800	15082307587
110	234	18	360	2050x1200x800	15083011087
125	271	20	80	940x1200x800	15083512587
160	419	10	40	940x1200x800	15084116087

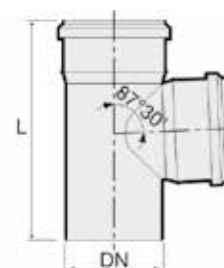

### Ramificație redusă PP 45°

45° PP reduced branch

Тройник редуционный ПП 45°

DN <sub>1</sub>	DN <sub>2</sub>	L			HxLxI palet	Cod
[mm]					[mm]	code/код
40	32	146	40	1280	1010x1200x800	15100104045
50	40	152	40	2160	2280x1200x800	15100805045
75	40	181	25	300	853x1200x800	15101307545
	50	185	25	300	970x1200x800	15101907545
110	40	202	20	160	940x1200x800	15102511045
	50	179	26	432	2050x1200x800	15103211045
125	75	238	15	120	940x1200x800	15103711045
	50	251	10	120	970x1200x800	15104312545
160	110	317	8	64	940x1200x800	15104912545
	110	341	10	60	940x1200x800	15106116045
	125	371	10	40	940x1200x800	15106716045

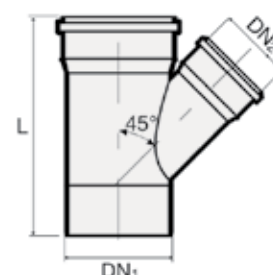





**Ramificație redusă PP 67°30'**

67°30' PP reduced branch

Тройник редуцирующий ПП 67°30'



DN <sub>1</sub>	DN <sub>2</sub>	L			HxLxI palet	Cod
[mm]	[mm]	[mm]			[mm]	code/код
40	32	140	40	1280	1010x1200x800	15100304067
50	40	151	25	800	1010x1200x800	15100905067
75	40	155	25	300	843x1200x800	15101507567*
	50	172	25	300	970x1200x800	15102107567
110	40	195	20	160	940x1200x800	15102711067
	50	174	40	480	2050x1200x800	15103411067
125	75	223	15	120	940x1200x800	15103911067
	50	225	10	120	1039x1200x800	15104512567*
160	110	280	8	64	940x1200x800	15105112567*
160	110	313	5	40	940x1200x800	15106316067*



**Ramificație redusă PP 87°30'**

87°30' PP reduced branch

Тройник редуцирующий ПП 87°30'

DN <sub>1</sub>	DN <sub>2</sub>	L			HxLxI palet	Cod
[mm]	[mm]	[mm]			[mm]	code/код
40	32	132	40	1280	1010x1200x800	15100504087
50	40	152	25	800	1010x1200x800	15101105087
75	40	154	25	300	853x1200x800	15101707587
	50	170	25	300	853x1200x800	15102307587
110	40	175	20	240	1039x1200x800	15102911087
	50	184	34	540	2050x1200x800	15103611087
125	75	205	35	420	940x1200x800	15104211087
	50	223	10	120	1039x1200x800	15104712587*
160	110	272	8	96	1039x1200x800	15105312587
160	110	305	10	60	940x1200x800	15106516087

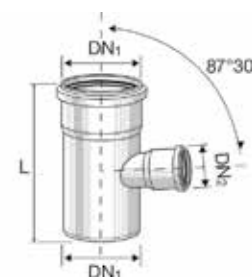



Easy

**Ramificație dublă PP**

PP double branch

Двойное разветвление ПП

DN <sub>1</sub>	DN <sub>2</sub>	L	α			HxLxI palet	Cod
[mm]	[mm]	[mm]				[mm]	code/код
50	50	172	67°30'	20	480	1015x1200x800	15060105067
75	75	206	67°30'	10	120	853x1200x800	15060507567
110	40	197	45°	10	120	853x1200x800	15060711045*
	50	197	45°	10	120	853x1200x800	15060911045
110	50	189	67°30'	10	120	853x1200x800	15060911067
	50	184	87°30'	10	120	853x1200x800	15061111087
110	110	254	67°30'	5	60	970x1200x800	15061311067
110	110	254	87°30'	5	60	970x1200x800	15061511087

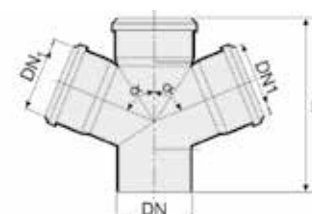

### Ramificație de colț PP

PP corner branch

Угловое разветвление ПП

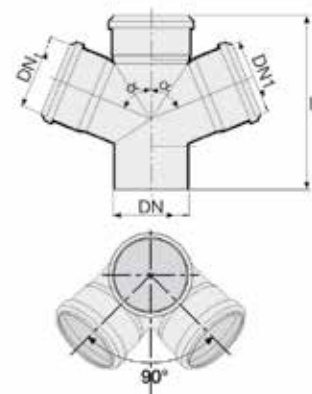

DN	DN <sub>1</sub>	L	$\alpha$			HxLxl palet	Cod
[mm]						[mm]	code/код
110	110	248	67°30'	5	60	1039x1200x800	15062511067

### Manșon PP

PP slip coupling

Муфта ПП

DN	L			HxLxl palet	Cod
[mm]				[mm]	code/код
32	78	100	11200	2260x1200x800	15260103200
40	89	50	5600	2260x1200x800	15260204000
50	92	30	3360	2260x1200x800	15260405000
75	120	20	640	1010x1200x800	15260507500
110	115	25	900	2470x1200x800	15260811000
125	147	20	160	940x1200x800	15260912500
160	204	10	80	940x1200x800	15261116000

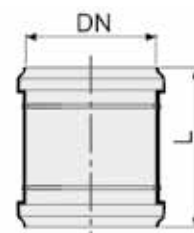

### Reducție excentrică PP

PP eccentric reducer

Эксцентрическая редукция ПП

Tip	DN	DN <sub>1</sub>	L			HxLxl palet	Cod
	[mm]					[mm]	code/код
a	40	32	98	80	8960	2260x1200x800	15140114032
a	50	32	98	50	5600	2260x1200x800	15140215032
a	50	40	125	90	4860	2280x1200x800	15140315040
b	75	40	75	20	960	850x1200x800	15140507540
b	75	50	75	30	1440	850x1200x800	15140707550
b	110	50	74	40	2160	2280x1200x800	15141011050
b	110	75	82	20	640	1010x1200x800	15141111075
b	125	75	85	20	480	1015x1200x800	15141312575
b	125	110	86	30	360	853x1200x800	15141512511
a	160	110	173	20	240	940x1200x800	15141716011
a	160	125	160	20	240	940x1200x800	15141916012

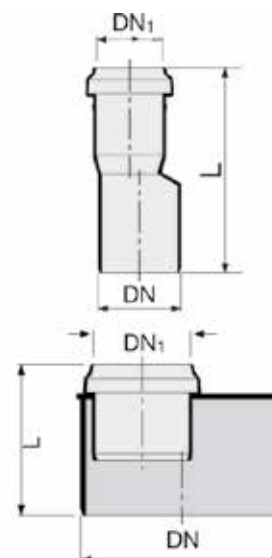





### Conector redus PP

PP connector reducer

Уменьшительный переходник ПП

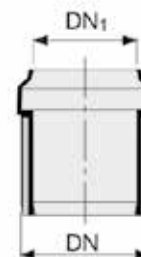

DN	DN <sub>1</sub>			HxLxI palet	Cod
[mm]	[mm]			[mm]	code/код
40	32	130	14560	2260x1200x800	15130104032
50	40	70	7840	2260x1200x800	15130205040
110	90	20	320	1200x1010x800	15130111090



### Conector dilatație PP

PP extension socket

Расширительный переходник ПП

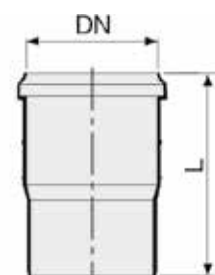

DN	L			HxLxI palet	Cod
[mm]	[mm]			[mm]	code/код
75	169				15300707501
110	170	20	240	970x1200x800	15300711000
110	205	20			15300711001



### Adaptor excentric PP

PP eccentric reducer

Эксцентрическая втулка ПП

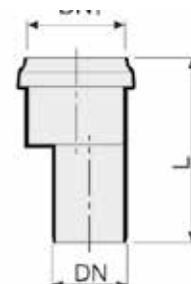

DN	DN <sub>2</sub>	L			HxLxI palet	Cod
[mm]	[mm]	[mm]			[mm]	code/код
32	40	95	80	8960	2260x1200x800	17003413240
40	50	99	30	1680	970x1200x800	17003304050
50	75	101	20	1120	970x1200x800	17003905075



### Dop închidere PP

PP plug

Заглушка - ПП

DN	L			HxLxI palet	Cod
[mm]	[mm]			[mm]	code/код
32	32	700	19600	970x1200x800	15240103200
40	30	200	22400		15240204000
50	25	250	13500	970x1200x800	15240405000
75	32	15			15240507500
110	38	60	3240		15240811000
125	51	10			15240912500
160	57	20	400	853x1200x800	15241116000

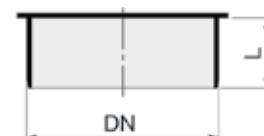

Easy

### Conector PP de trecere la fontă cu inel și garnitură dublă

PP adaptor for cast iron pipes with o-ring and washer  
Переходная муфта ПП-чугун с прокладкой

DN	DN <sub>1</sub>	L			HxLxI palet	Cod
[mm]					[mm]	code/код
50	72	151	20	960	970x1200x800	15690105000
75	92	148	20	640	1010x1200x800	15690307500
110	124	160	20	240	859x1200x800	15690511000
125	151	184	10	120	853x1200x800	15690712500



### Piesă curățire PP cu dop filetat

PP access pipe with cap  
Ревизия с крышкой - ПП

DN	Dc	L			HxLxI palet	Cod
[mm]					[mm]	code/код
50	90	194	30	1620	2280x1200x800	15160405000
75	88	195	20	240	853x1200x800	15160507500
110	115	247	25	360	2050x1200x800	15160811000
125	148	257	10	80	940x1200x800	15160912500
160	130	298	5	40	940x1200x800	15161116000



### Dop PP pentru piesă curățire

PP cap for PP access pipe  
Крышка для чистящей части ПП

Dc			HxLxI palet	Cod
[mm]			[mm]	code/код
90				15160805005
115	35			15160811005



Piesă de schimb pentru produsele cod:  
15160405000 și 15160811000

Parts products code:15160405000 and  
15160811000

Запасные части продукты с кодом:  
15160405000 и 15160811000



### Clapetă PP antiretur

Non return PP valve  
Обратный клапан - ПП

DN	L	I	H			HxLxI palet	Cod
[mm]						[mm]	code/код
50	175	103	102	30	480	970x1200x800	13980000050

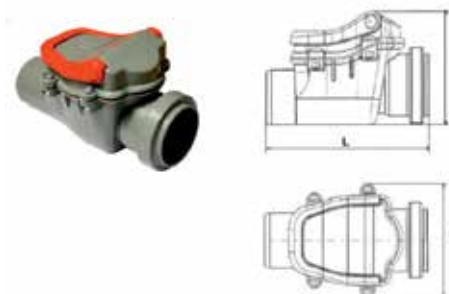

### Sifon "Firenze"

Trap "Firenze"  
Сифон "Firenze"

DN	L	H	H <sub>1</sub>			Cod
[mm]						code/код
110	500	260	151	6	120	15331101000

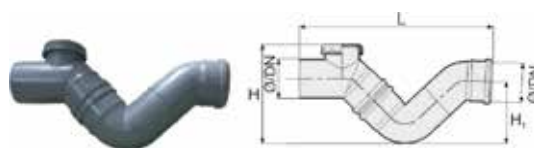

Utilizat pentru a evita pătrunderea mirosului neplăcut din canalizarea publică în instalația interioară.

Used to prevent odor penetration of the public sewerage drainage installation.

Использованный для предотвращения проникновения неприятного запаха из общественной канализации во внутреннюю систему.

### Piesă capăt pentru coloană ventilare

Connector for vent  
Выпуск вентиляционной трубы

DN			HxLxI palet	Cod
[mm]			[mm]	code/код
50	50	700	940x1200x800	13940105000
75	5	75	940x1200x800	13940307500
110	10	140	940x1200x800	13940511000
160	1			13940516000



### Aerator "ARIO"

Aerator "ARIO"  
Воздушный клапан "ARIO"

DN	Culoare	Flux aer		HxLxI palet	Cod
[mm]	colour/цвет	[l/s]		[mm]	code/код
75-110	alb white/ белый	14	9	940x1200x800	17040107511



Pentru montaj în băi, casa scărilor, mansarde.  
Utilizat pentru îmbunătățirea capacității de descărcare a apelor uzate.

For installation in bathrooms, stairwells, attics.  
Used to improve wastewater discharge capacity.



Для установки в ваннных комнатах, на лестничных клетках, чердаках.  
Используется для повышения потенциала сброс сточных вод.



**Aerator PP cu membrană**

Aerator admittance valve

Аэратор с мембраной- ПП

Tip	DN [mm]			HxLxI palet	Cod code/код
				[mm]	
A	32/40/50	10			17040003250
B	110	10	160	1010x1200x800	17040005011

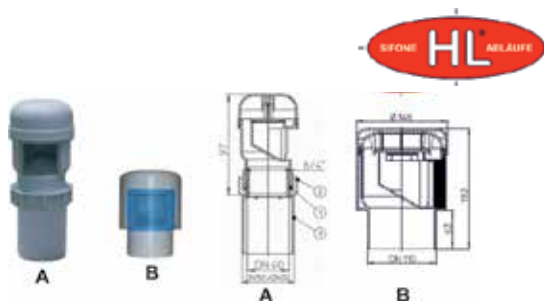

**Reducție PP pentru aerator tip B**

PP adapter for aerator type B

Редукция из ПП для аэратора тип B

DN [mm]	Cod code/код
50/75	17040005012



**Curbă tehnică fără garnitură pentru racordare obiecte sanitare - PP**

PP bend for trap conection, without grommet

Колено техническое ПП с заглушкой без уплотнения для подключения сантехники

D/DN	D/D <sub>1</sub>	DN	Z <sub>1</sub>	L	L <sub>1</sub>	L <sub>2</sub>		Cod code/код
[mm]								
32	32/46	32	25	48	43	26	60	15181810032
40	40/46	40	25	50	45	26	55	15181810040

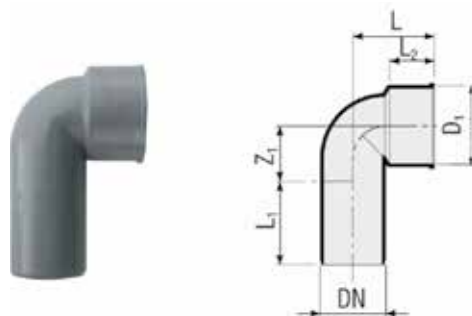

**Conector tehnic PP cu dop fără garnitură**

PP - straight fitting wit cap, without grommet

Переходник ПП с заглушкой без уплотнения

D/DN	D/D <sub>1</sub>	DN	L	L <sub>1</sub>	L <sub>2</sub>		Cod code/код
[mm]							
40	40/46,0	40	88	54	26	40	15181720040
50	50/53,6	50	88	54	26	20	15181720050

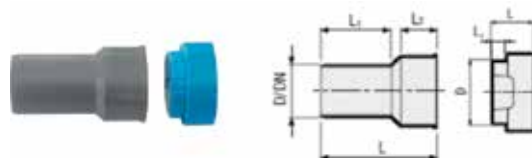



### Garnitură cauciuc

Rubber grommet

Резиновое уплотнение

De [mm]	Di [mm]	Cod code/код
46	24 - 32	46092004632
46	36 - 40	46092004640
53	24 - 32	46092005332

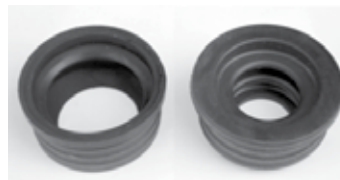

### Cot alb WC prelungit cu garnitură și dop

Extension WC white bend, with seal and plug

Белое колено для унитаза с уплотнением

DN	L [mm]	L <sub>1</sub>	α		Cod code/код
110	230	180	90°	10	15430111090

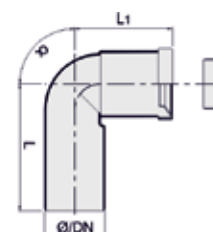

### Cot alb WC cu garnitură și dop - HTSB

HTSB white bend WC with washer and plug

Белый отвод для унитаза с уплотнителем - HTSB

DN	L [mm]	α		Cod code/код
110	230	45°	15	15340311045*
110	230	90°		15340111090

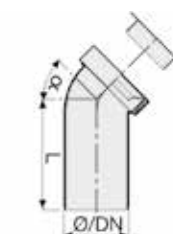

### Racord alb WC cu garnitură - HTSK

HTSK WC white ring seal coupling

Белый патрубок для унитаза с уплотнением - HTSK

DN	DN <sub>2</sub>	L		Cod code/код
110	100	230	20	15360111023
110	100	400		15360311040

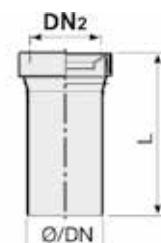

### Cot PP atac frontal 87°30'

87°30' PP bend with front inlet

Колено ПП фронтальный подход 87°30'

DN	DN <sub>1</sub>	Cod code/код
[mm]		
110	50	15501105087*

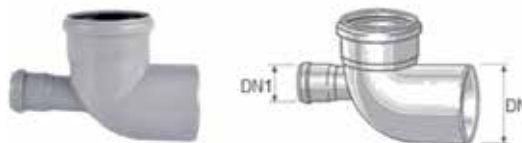

### Cot PP atac stanga 87°30'

87°30' PP bend with left inlet

Колено ПП левый подход 87°30'

DN	DN <sub>1</sub>	Cod code/код
[mm]		
110	40	15511104087*
110	50	15511105087*



### Cot PP atac dreapta 87°30'

87°30' PP bend with right inlet

Колено ПП правый подход 87°30'

DN	DN <sub>1</sub>	Cod code/код
[mm]		
110	40	15521104087*
110	50	15521105087*



## Accesorii

Accessories / Аксессуары

### Bridă fixare cu diblu OL/ZN

Galvanized iron pipe clip with anchor for attachment to walls

Хомут с винтом из оцинкованной стали с дюбилем

Tip type/тип	D	L		Cod code/код
[mm]				
M 8	32	80	200	66800026000
M 8	40	80	50	13950104000
M 8	50	80	50	13950305000
M 8	63	80	50	13950506300
M10	75	100	25	13950707500
M10	90	100	100	13950709000*
M10	110	100	25	13951111000
M10	125	100	25	13951312500
M10	160	100	10	13951516000





## **TEAVA PP-R, PP-R/AL**

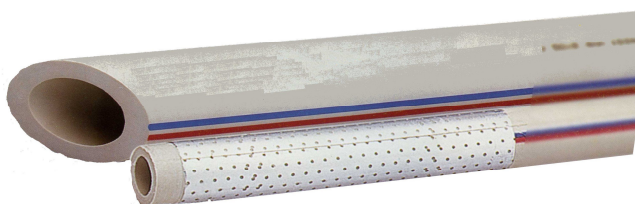

### ***MANUAL TEHNIC***

Revizia nr 3 / iunie 2012

## 1. Obiect si domeniu de aplicare

### PP-R - Polipropilena RANDOM

### PP-R/Al - Polipropilena RANDOM cu insertie de aluminiu

Țevile din **PP-R** si **PP-R/Al** se utilizează în instalațiile de alimentare cu apă rece, caldă si de încălzire.

### Caracteristici tevi din PP-R si PP-R/Al

- Sunt rezistente la agenti chimici.
- Sunt rezistente la coroziune (nu ruginesc).
- Nu favorizeaza proliferarea bacteriilor sau algelor, deoarece nu permit patrunderea razelor ultraviolete.
- Nu modifica mirosul si gustul apei.
- Nu se diminueaza diametrul tevi in punctele de sudare.
- Se realizeaza economii de 70% in faza de montaj, datorita efectuarii operatiunii fara nici un fel de rebuturi.
- Se recomanda utilizarea tevilor la temperaturi cuprinse intre -20°C si +95°C, luand masurile necesare astfel incat fluidul din teava sa nu inghete.
- Daca sunt utilizate la o temperatura de +20°C si o presiune de 25 bar, durata de viata a tevilor din PP-R este de 50 ani.

#### Dimensiuni tevi din PP-R

Diametrul exterior	Diametrul interior	Grosimea peretelui
20	13.2	3.4
25	16.6	4.2
32	21.2	5.4
40	26.6	6.7
50	33.2	8.4
63	42	10.5
75	50	12.5

#### Dimensiuni tevi din PP-R/Al

Diametrul exterior	Diametrul interior	Grosimea peretelui
20	11	4.5
25	14.3	5.35
32	18.9	6.55
40	23.9	8.05
50	29.9	10.05
63	38.7	12.15
75	46.7	14.15

### Caracteristici tehnice

Caracteristici	Conditii	UM	Metoda de testare	Valoarea
Densitatea	+23°C	g/cm <sup>3</sup>	ISO 1183	0,909
Fuziune	MFR 190/5	g/10 min	ISO 1183	0,55
	MFR 230/2,16	g/10 min	ISO 1183	0,30
	MFR 230/5	g/10 min	ISO 1183	1,20
Debit volumic	MVR 230/2,16	cm <sup>3</sup> /10 min	ISO 1133	0,40
Coeficient de dilatare PP-R		mm/mK	DIN 53752	0,15
Coeficient de dilatare PP-R/Al		mm/mK	DIN 53752	0,03
Conductivitatea termica		W/mK	DIN 52612	0,24

## Diagrama Temperatura – Presiune – Durata de viata

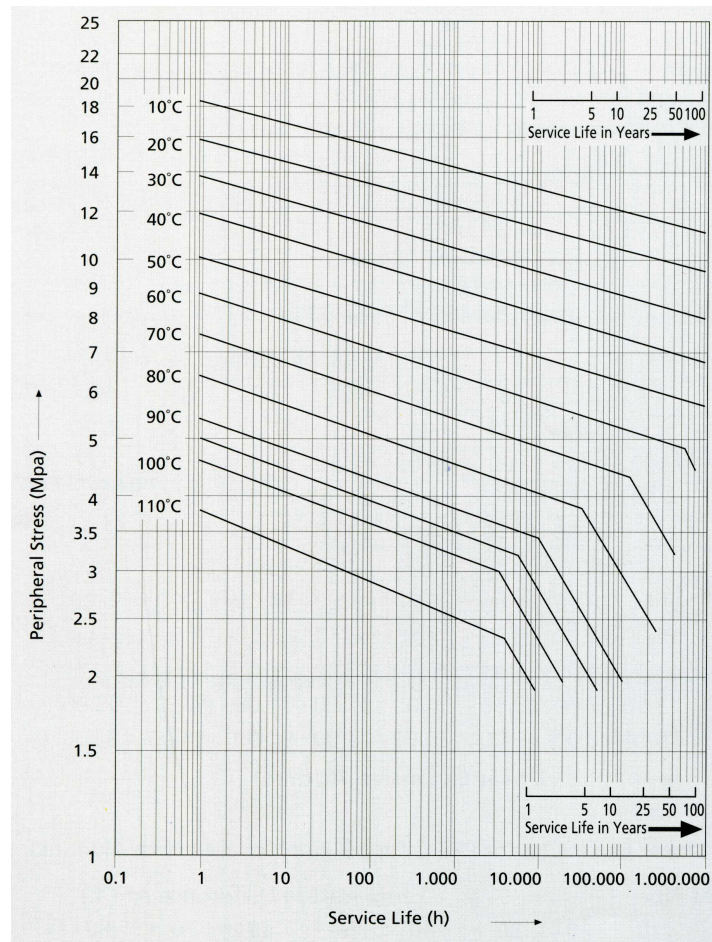

### Modificarea duratei de viata in functie de temperatura

Temp. °C	10	20	30	40	50	60	70	80	95
Durata de viata(ani)									
<b>1</b>	35.2	29.9	25.6	21.6	18.3	15.5	13.1	10.9	7.7
<b>5</b>	33.1	28.3	24.0	20.3	17.1	14.4	12.0	9.6	5.2
<b>10</b>	32.3	27.5	23.2	19.7	16.5	13.9	11.6	8.0	4.3
<b>25</b>	31.2	26.7	22.4	18.9	16.0	13.3	9.9	6.4	-
<b>50</b>	30.4	25.9	21.9	18.4	15.5	12.9	8.5	-	-
<b>100</b>	29.6	25.1	-	-	-	-	-	-	-
	Presiunea de lucru (bar)								

### Coeficientul de dilatare liniara pentru tevi din PP-R, PP-R/Al

Datorita structurii lor fizice, tevile din polipropilena se alungesc cand sunt incalzite si se contracta cand sunt expuse la temperaturi joase.

In cazul unui montaj pe distanta mai mare de 5 m, trebuie tinut cont de dilatarea liniara, calculata prin urmatoarea formula:

$$\Delta L = a \times L \times \Delta t \quad \text{unde:}$$

$\Delta L$  = Dilatarea (mm)

$a$  = Coeficientul de dilatare liniara ( $a = 0,15$  mm/mK la PP-R si  $0,03$  la PP-R/Al)

$L$  = Lungime teava (m)

$\Delta t$  = Diferenta de temperatura ( $^{\circ}\text{C}$ )

### Tabel dilatare liniara tevi din PP-R

Lungimea tevi L (m)	Diferenta de temperatura ( $\Delta t$ ) ( $^{\circ}\text{C}$ )							
	10	20	30	40	50	60	70	80
1	1.5	3.0	4.5	6.0	7.5	9.0	10.5	12.0
2	3.0	6.0	9.0	12.0	15.0	18.0	21.0	24.0
3	4.5	9.0	13.5	18.0	22.5	27.0	31.5	36.0
4	6.0	12.0	18.0	24.0	30.0	36.0	42.0	48.0
5	7.0	15.0	22.5	30.0	37.5	45.0	52.5	60.0
6	9.0	18.0	27.0	36.0	45.0	54.0	63.0	72.5
7	10.5	21.0	31.5	42.0	52.5	63.0	73.5	84.0
8	12.0	24.0	36.0	48.0	60.0	72.0	84.0	96.0
9	13.5	27.0	40.5	54.0	67.5	81.0	94.5	108.0
10	15.0	30.0	45.0	60.0	75.0	90.0	105.0	120.0

Dilatarea liniara  $\Delta L$  (mm)

### Tabel dilatare liniara tevi din PP-R/Al

Lungimea tevi L (m)	Diferenta de temperatura ( $\Delta t$ ) ( $^{\circ}\text{C}$ )							
	10	20	30	40	50	60	70	80
1	0.30	0.60	0.90	1.20	1.50	1.80	2.10	2.40
2	0.60	1.20	1.80	2.40	3.00	3.60	4.20	4.80
3	0.90	1.80	2.70	3.60	4.50	5.40	6.30	7.20
4	1.20	2.40	3.60	4.80	6.00	7.20	8.40	9.60
5	1.50	3.00	4.50	6.00	7.50	9.00	10.50	12.00
6	1.80	3.60	5.40	7.40	9.00	10.80	12.80	14.40
7	2.10	4.20	6.30	8.40	10.50	12.60	14.70	16.80
8	2.40	4.80	7.20	9.60	12.00	14.40	16.80	19.20
9	2.70	5.40	8.10	10.80	13.50	16.20	18.90	21.60
10	3.00	6.00	9.00	12.0	15.0	18.0	21.0	24.0

Dilatarea liniara  $\Delta L$  (mm)



## Diagrama de dilatare tevi din PP-R, PP-R/Al

La montaj se prevad lire de dilatare, astfel incat instalatia sa nu fie afectata de diferentele de temperatura.

### Lungime compensator de dilatare



FP=punct  
fix  
SP=punct  
mobil

Lungimea LF a compensatorului de dilatare se calculeaza utilizand urmatoarea formula:

$$LF = C \times (D \times AL)^{1/2}$$

in care:

- LF: Lungime compensator tip „L” (mm)
- C: Coeficient specific materialului (C=30)
- D: Diametrul exterior al tevii
- AL: Dilatarea

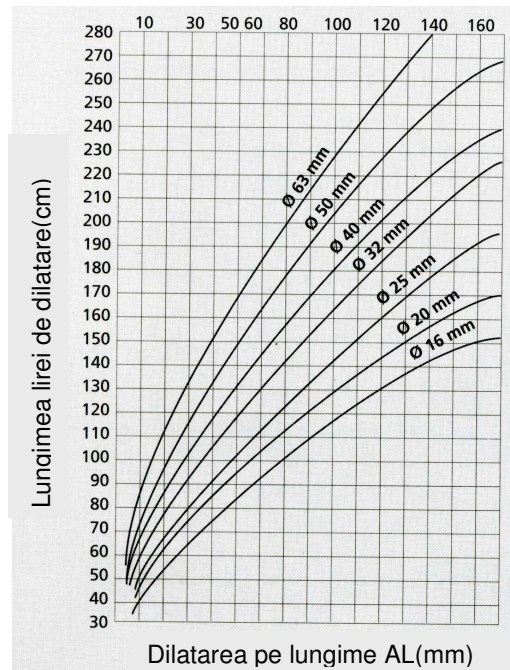

## Spatiu maxim de dilatare

In cazul in care dilatarea liniara nu poate fi compensata de schimbarea directiei, atunci se realizeaza o lira de dilatare ca in figura:

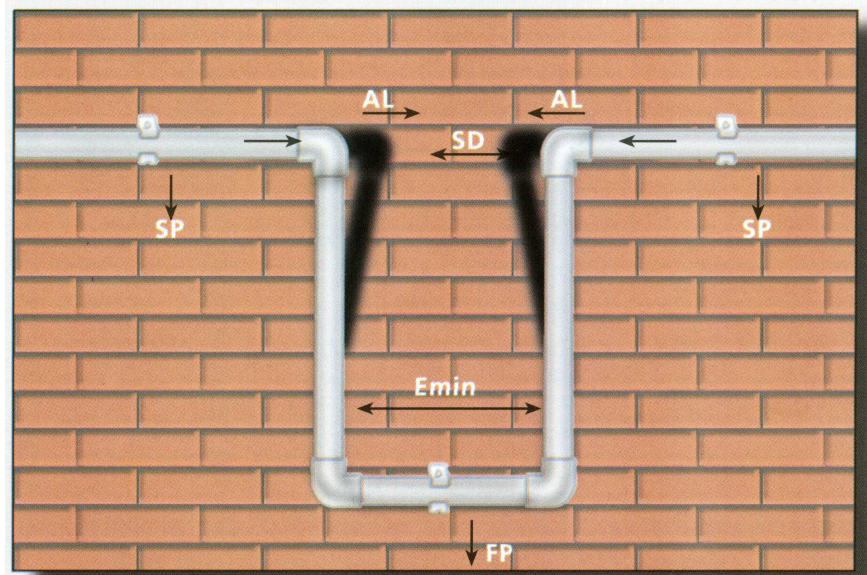

Calcularea spatiului minim de dilatare:

In functie de diferentele de temperatura si lungimea tevii, puteti gasi valoarea alungirii  $\Delta L$  din tabelele anterioare.

Atunci cand instalatia va fi expusa la caldura, aceasta se va dilata cu  $\Delta L$  la fiecare capat (alungirea totala  $2 \times \Delta L$ ). Considerand ca alungirea poate creste datorita diferentelor de temperatura, se asigura o distanta de siguranta (SD) de 150 mm.

Astfel, latimea minima a spatiului de amplasare va fi  $E_{min} = 150 + 2 \times \Delta L$ . Unde:

SD: Distanța de siguranță (mm)

$E_{min}$ : Latimea minima a spatiului de dilatare (mm)

SP: Punct mobil

FP: Punct fix

## Montaj lire de dilatare pentru tevi din PP-R, PP-R/Al

Lirele de dilatare pentru traseul orizontal se stabilesc cu ajutorul diagramei de mai jos.

Se recomanda utilizarea aceluiasi tip de lira de dilatare, atat pentru **instalatiile orizontale, cat si pentru cele verticale.**

**Puncte fixe:** Punctele fixe previn deplasari necontrolate din instalatie si in acelasi timp vor imparti intreaga instalatie in sectiuni mai mici de dilatare. In locurile selectate pentru punctele fixe, factorii de care se tine cont sunt: dilatarea liniara a tevii, greutatea sa, tipul lichidului din interiorul tevii si alti coeficienti referitori la incarcare, daca exista.

**Punctele fixe:** trebuie sa fie destul de puternice pentru a rezista la piesele indoite liber. Acestea trebuie sa fie amplasate astfel incat sa permita dilatarea la orice schimbare de directie.

Punctele fixe trebuie sa fie executate prin fixarea etansa a tevilor in orice punct al instalatiei. In acest scop, trebuie utilizate racorduri sau un sistem de fixare cu doua capete. In aplicatii cu sisteme de fixare cu 2 capete se utilizeaza mufe si racorduri sudate.

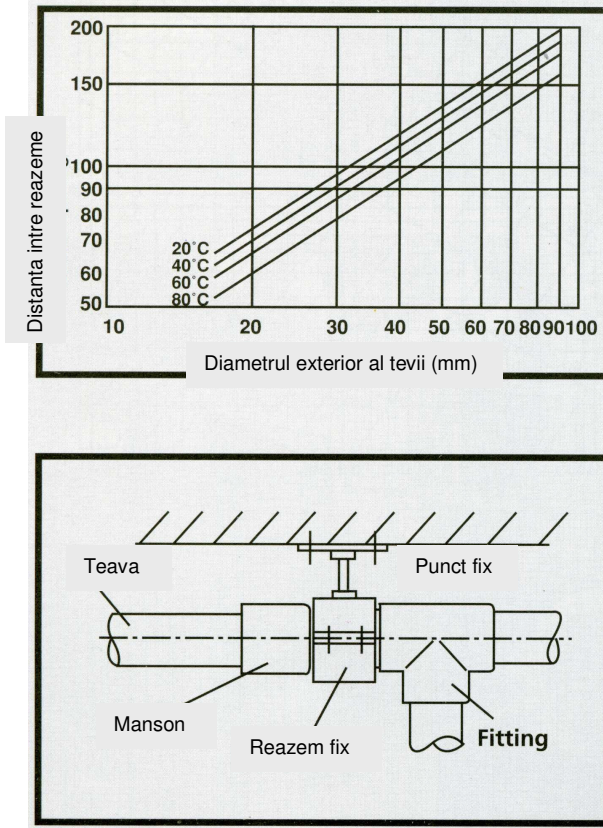

### Alegerea diametrului la tevilor din PP-R, PP-R/Al

In instalatiile cu apa, diametrul tevilor se stabileste in functie de debitul, viteza si pierderea de presiune. In diagrama de mai jos este prezentata pierderea de presiune pe metru pentru tevi PP-R, PP-R/Al.



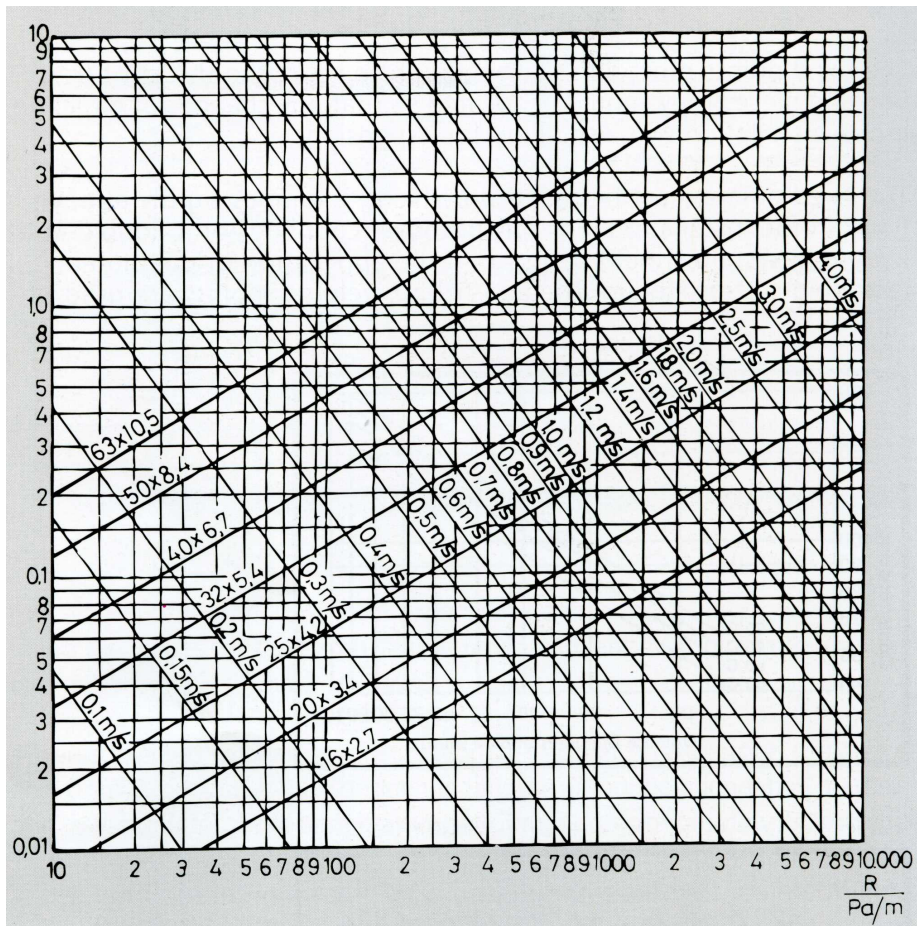

## INSTRUCTIUNI PENTRU SUDURA TEAVA PP-R, PP-R/Al

### Instructiuni pentru sudura teava PP-R



Se taie teava din PP-R pe directia perpendicular pe axa, cu ajutorul unei foarfece speciale. Sudura se realizeaza cu aparatul de polifuziune. Sudura trebuie sa se execute la 260°C. In functie de diametrul tevii care trebuie prelucrata, se alege si se monteaza matrita corespunzatoare pe aparatul de lipire. Matrita de sudura se curata inainte de utilizare.

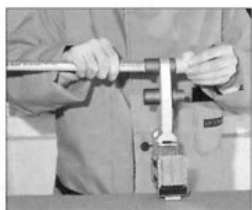

Teava si fittingul se introduc coaxial in matrita (teava in partea interioara a matritei, iar fittingul in partea exterioara a acesteia), apoi se scot si se trece la operatia de imbinare.



Piesele se tin fixe, fara a se roti. Este important sa respectati timpii de incalzire, sudura si racire prezentati in tabelul de mai jos.

### Instructiuni pentru sudura teava cu insertie de aluminiu PP-R/Al



Se taie teava din PP-R pe directia perpendicular pe axa, cu ajutorul unei foarfece speciale. Sudura se realizeaza cu aparatul de polifuziune. Sudura trebuie sa se execute la 260°C. In functie de diametrul tevii care trebuie prelucrata, se alege si se monteaza matrita corespunzatoare pe aparatul de lipire. Matrita de sudura se curata inainte de utilizare



Se foloseste calibratorul, cu ajutorul caruia se indeparteaza primul strat de PP-R si folia de aluminiu.



Se utilizeaza calibratorul pentru a indeparta surplusul de aluminiu de la capetele de sudare.



Daca la incheierea procesului mai exista un surplus de aluminiu, indepartati-l complet.



Teava si fittingul se introduc coaxial in matrita (teava in partea interioara a matritei, iar fittingul in partea exterioara a acesteia), apoi se scot si se trece la operatia de imbinare.



Piesele se tin fixe, fara a se roti. Este important sa respectati timpii de incalzire, sudura si racire prezentati in tabelul de mai jos.

Este recomandabil sa asteptati cel putin doua ore de la efectuarea ultimei suduri, dupa care se poate incepe proba de presiune.

## Program de sudura

Diametrul exterior al tevii (mm)	Timp de incalzire (secunde)		Timp de sudura (secunde)	Timp de racire (minute)
	PP-R	PP-R/ Al		
20	5	8	4	2
25	7	11	4	2
32	8	12	6	4
40	12	18	6	4
50	18	27	6	4
63	24	36	8	6

## Indicatii de montaj

1. Temperatura minima pentru montajul conductelor din PP-R, PP-R/Al este **de +5°C**.
2. Pe intreaga perioada a montajului si transportului trebuie ca elementele sistemului sa fie ferite de socuri, lovituri
3. Incovoierea conductelor fara incalzire se efectueaza la o temperatura de **minimum +15°C**. La conducte cu diametrul de pana la 32mm, se admite raza minima de indoire de 8 x diametrul conductei.
4. Nu este permis ca materialul sa intre in contact cu flacara deschisa.
5. Incrucisarea conductelor(trecerea) se face numai prin intermediul pieselor speciale
6. Imbinarea conductelor si fittingurilor se face prin polifuziune, sudare cap la cap.
7. Pentru imbinarile cu filet se vor folosi fittinguri speciale cu filet. Este interzisa taierea filetelor pe santier. Filetele se etansaza cu banda de teflon sau cu alte chituri speciale de etansare.
8. Daca dupa un fitting combinat urmeaza o conducta metalica, in apropierea fittingului nu se vor face suduri pe teava metalica. Prin incalzirea acesteia, se poate deforma fittingul din plastic.

Colectivul de redactare a cartii tehnice:

Verificare tehnica:

**ing. Stefan LAZAR**

Tehnoredactare:

**ing. Stefan LAZAR**

BUCURESTI - ROMANIA - Sos. Vitan-Barzesti nr. 11A, sector 4; Tel/Fax: 021-332.09.01, 334.94.63;  
Reg. Com. J/40/14205/1994 - Cod fiscal R 5990324 - Cont RO74RNCB501000000130001 B.C.R.  
Sector 1, BUCURESTI - RO43BACX0000000030565310 HVB sucursala Grigore Mora  
BUCURESTI; Capital Social: 139.400.000.000 ROL (13.940.000 RON)









PLASTIK, KAUCUK SAN. ve TIC. A.S.

**To whom it may concern.**

**To the attention of the authorities in Romania.**

Türkoba Mah. Fırat Plastik Cad. No: 23  
34537 Büyükçekmece  
İstanbul / TURKEY  
Tel.: 0090 212 859 04 04  
Tel.: 0090 212 859 05 05  
Fax: 0090 212 859 04 00  
Fax: 0090 212 859 04 08  
E-mail: [export@firat.com](mailto:export@firat.com)  
[www.firat.com](http://www.firat.com)

**Ref: 014/ 15.01.2019**

## **DECLARATION OF CONFORMITY**

We, **FIRAT PLASTIK, KAUCUK SAN. ve TIC. A.S.** – Turkoba mah. Fırat Plastik cad. P.K. 34537, Buyukcekmece / Istanbul / TURKEY declare under our sole responsibility that the products; **PP-RC pipes and fittings from polypropylene random copolymer**, to which this declaration relates are in conformity with the following European standards;

**DIN 8077, DIN 8078, DVGW, ISO 15874-2, ISO 15874-3, ISO 9001 and PP-RC/GFR Composite pipe TSE K 28**, are intended for civilian purposes only, not for military, not for nuclear, not for chemical or not for biological user.

The goods are in suitable packets and are not dangerous for the people or the environment.

We undersigned, declare that above statement is true and correct.

Fırat Plastik Kaucuk San. Ve Tic. A.S.  
İstanbul / TURKEY



## TUBURI DIN PP <Easykit>

### Domeniu de utilizare

Tuburile din PP <EasyKIT> se utilizeaza la:

- instalatia de canalizare interioara la evacuarea apelor menajere la temperaturi joase sau ridicate (maxim 90 °C);
- conductele de ventilatie naturala a instalatiei interioare de canalizare;

### Material

Tuburile <EasyKIT> sunt fabricate din polipropilena (PP) homopolimer sau copolimer.

Tuburile si fittingurile din PP se realizeaza din material PP neignifugat iar in baza unor comenzi ferme se pot produce din material PP ignifugat.

### Aspect si culoare

Tuburile din PP sunt de culoare gri (RAL 7037) cu luciu superficial, stabilizat la UV si au suprafata interna si externa neteda, fara defecte (fisuri, ciupituri).

### Marcare

Marcarea tuburilor din PP se face cu jet de cerneala de culoare neagra.

Continutul marcajului imprimat cu jet de cerneala este urmatorul:

data	- ziua si luna (xx, yy);
ora	- ora si minutul la care s-a produs – pentru identificarea schimbului;
producatorul	- Valrom;
marca	- EasyKIT;
dimensiunile	- diametrul x grosimea nominale;
codul ariei de aplicare	- "B";
seria tubului	- S 20;
lotul	- LOT xxyy (xx – ultimile doua cifre ale anului, yy – numarul de ordine al lotului) sau LOT xyy - daca prima cifra este zero (aceasta nu se va marca);
referire la nr. standardului	- EN 1451;
materialul	- PP;
lungimea tubului	- lungimea nominala a tubului L= xxxx mm;

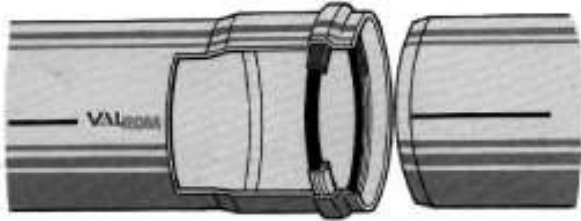

Exemplu marcaj

**VALROM EasyKIT Ø110 x 2,7 L=1000 mm LOT 401 B S20 EN1451 PP 12/08 15:45**

### Garantie:

Tuburile din PP beneficiaza de 5 ani garantie, in baza facturii de achizitie, cu conditia respectarii instructiunilor de depozitare, transport si montaj prezentate in "Cartea Tehnica EasyKIT".

### Dimensiuni:

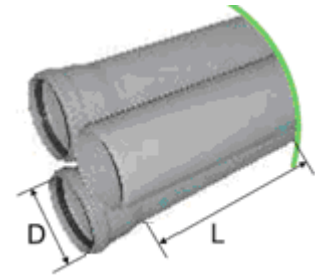
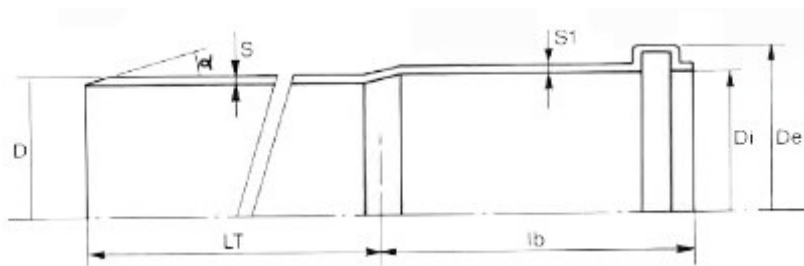

D (mm)	S (mm)	LT (mm)	De (mm)	Di min (mm)	S1 min (mm)	Lb (mm)	Cod produs
32	1,8	250	43	32,3	1,6	46,5	11032025000
32	1,8	500	43	32,3	1,6	46,5	11032050000
32	1,8	750	43	32,3	1,6	46,5	11032075000
32	1,8	1000	43	32,3	1,6	46,5	11032100000
32	1,8	1500	43	32,3	1,6	46,5	11032150000
32	1,8	2000	43	32,3	1,6	46,5	11032200000
32	1,8	3000	43	32,3	1,6	46,5	11032300000
40	1,8	250	54	40,3	1,6	52	11040025000

Valrom Industrie isi rezerva dreptul de a face modificari in prezenta fara notificare prealabila.  
 Versiunea 1.2/11.08.2015

<b>D (mm)</b>	<b>S (mm)</b>	<b>LT (mm)</b>	<b>De (mm)</b>	<b>Di min (mm)</b>	<b>S1 min (mm)</b>	<b>Lb (mm)</b>	<b>Cod produs</b>
40	1,8	500	54	40,3	1,6	52	11040050000
40	1,8	750	54	40,3	1,6	52	11040075000
40	1,8	1000	54	40,3	1,6	52	11040100000
40	1,8	1500	54	40,3	1,6	52	11040150000
40	1,8	2000	54	40,3	1,6	52	11040200000
40	1,8	3000	54	40,3	1,6	52	11040300000
50	1,8	250	64	50,3	1,6	52	11050025000
50	1,8	500	64	50,3	1,6	52	11050050000
50	1,8	750	64	50,3	1,6	52	11050075000
50	1,8	1000	64	50,3	1,6	52	11050100000
50	1,8	1500	64	50,3	1,6	52	11050150000
50	1,8	2000	64	50,3	1,6	52	11050200000
50	1,8	3000	64	50,3	1,6	52	11050300000
75	1,9	250	89	75,4	1,7	54	11075025000
75	1,9	500	89	75,4	1,7	54	11075050000
75	1,9	1000	89	75,4	1,7	54	11075100000
75	1,9	1500	89	75,4	1,7	54	11075150000
75	1,9	2000	89	75,4	1,7	54	11075200000
75	1,9	3000	89	75,4	1,7	54	11075300000
110	2,7	250	128	110,4	2,4	65	11110025000
110	2,7	500	128	110,4	2,4	65	11110050000
110	2,7	750	128	110,4	2,4	65	11110075000
110	2,7	1000	128	110,4	2,4	65	11110100000
110	2,7	1500	128	110,4	2,4	65	11110150000
110	2,7	2000	128	110,4	2,4	65	11110200000
110	2,7	3000	128	110,4	2,4	65	11110300000
125	3,1	250	145	125,4	2,8	67	11125025000
125	3,1	500	145	125,4	2,8	67	11125050000

Valrom Industrie isi rezerva dreptul de a face modificari in prezenta fara notificare prealabila.  
 Versiunea 1.2/11.08.2015

<b>D (mm)</b>	<b>S (mm)</b>	<b>LT (mm)</b>	<b>De (mm)</b>	<b>Di min (mm)</b>	<b>S1 min (mm)</b>	<b>Lb (mm)</b>	<b>Cod produs</b>
125	3,1	1000	145	125,4	2,8	67	11125100000
125	3,1	1500	145	125,4	2,8	67	11125150000
125	3,1	2000	145	125,4	2,8	67	11125200000
125	3,1	3000	145	125,4	2,8	67	11125300000
160	3,9	500	174,3	160,5	3,5	100	11160050000
160	3,9	1000	174,3	160,5	3,5	100	11160100000
160	3,9	1500	174,3	160,5	3,5	100	11160150000
160	3,9	2000	174,3	160,5	3,5	100	11160200000
160	3,9	3000	174,3	160,5	3,5	100	11160300000

### **Ambalare:**

Tuburile din PP <EasyKIT> cu lungime si diametru mic sunt ambalate in cutii de carton iar restul in rame de lemn intarite cu banda de plastic.

Prin ambalare se urmareste simplificarea operatiilor de depozitare si transport si sunt evitate posibilele deteriorari (zgariere, ovalizare).

### **Transport si depozitare**

Incarcare si eventualele mutari pe santier sau in locurile de depozitare se va face cu mare atentie de catre personal instruit. Se vor folosi motostivuitoare sau alte utilaje avand in vedere evitarea eventualelor deteriorari, loviri sau deformari. Tuburile nu se vor tranti, lovi sau arunca. Pentru transport pachetele cu tuburi se aseaza ordonat si se asigura cu chingi impotriva miscarii in timpul transportului, astfel incat sa se evite contactul tuburilor cu diverse parti ale camionului carea ar putea zgaria sau taia tubul.

Depozitarea se face in spatii special amenajate protejate de intemperii, de temperaturi scazute si de radiatie solara directa. In cazul depozitarii cu expunere la lumina solara directa nu se vor depasi 18 luni. Pachetele de teava se aseaza pe suprafete orizontale si uniforme pentru a evita orice posibilitate de deformatie. In cazul depozitarii pe termen lung se va evita formarea stivelor cu o inaltime mai mare de 1.70m, indiferent de diametrele tuburilor.

# DECLARATIE DE CONFORMITATE

Nr. VLR 003.3 / Data: 07.06.2018



Atât de simplu.

Valrom Industrie SRL  
Bd. Preciziei nr. 28, sector 6,  
cod 062204, București  
Tel: + 4 021 317 38 00;  
Fax: + 4 037 289 94 45;  
www.valrom.ro; office@valrom.ro

REG COM J40/4810/1996  
CIF RO8529679  
Capital social: 6.706.000 lei

## 1. Cod unic de identificare al produsului-tip:

TEVI SI FITINGURI DIN POLIPROPILENA <EasyKIT>

## 2. Tipul, lotul sau numarul de serie sau orice alt element care permite identificarea produsului pentru constructii:

Tevi si fittinguri VALROM EasyKIT DN 32 + 160 mm seria S 20 si sifoane de pardoseala „V”.

Tevi si fittinguri VALROM EasyKIT FONO DN 32 + 160 mm fonoizolante.

## 3. Utilizarea preconizata a produsului pentru constructii:

Tevile si fittingurile sunt utilizate la instalatiile interioare/incinte de canalizare aferente constructiilor civile (pentru retele ape uzate). Tevile și fittingurile fonoizolante din PP se utilizează pentru amortizarea sunetului produs de curgerea apei prin coloane.

## 4. Numele, denumirea sociala sau marca inregistrata si adresa de contact a fabricantului:

SC VALROM INDUSTRIE SRL,

Adresa: B-dul Preciziei, Nr. 28, Sector 6, Bucuresti, Romania

Contact: Telefon - 021 / 317.38.00, Fax – 0372.89.94.45, mail: [office@valrom.ro](mailto:office@valrom.ro), web: [www.valrom.ro](http://www.valrom.ro)

## 5. Numele si adresa de contact a reprezentantului autorizat:

Nu este cazul

## 6. Conformitatea este demonstrata avand ca referinta:

AGREMENTUL TEHNIC IN CONSTRUCTII Nr. 017-05/2903-2018

## 7. Performantele produsului:

CARACTERISTICI	STANDARDUL DE INCERCARI	PREVEDERI DIN STANDARD	VALORI DECLARATE (rezultate Incercari)
Aspect	EN 1451	Suprafete interioare si exterioare netede, curate si fara bavuri, pori si alte defecte de suprafata	CORESPUNDE
Dimensiuni si tolerante	EN ISO 3126	Dimensiuni si tolerante (diametru exterior, grosime, ovalitate) trebuie sa corespunda valorilor prevazute in standardul de produs	CORESPUNDE
Contractie longitudinala la cald	EN ISO 2505	Lichid 150 °C/30 min. ≤ 2%	CORESPUNDE
Aspectul fittingurilor dupa incalzire	EN ISO 580	Etuva cu circulatie de aer la o temperatura de 150°C timp de 30 min. Nu trebuie sa prezinte fisuri, exfolieri sau ruperi cu adancimea mai mare de 20% din grosimea peretelui	CORESPUNDE
Etanseitate la apa	EN 1053	Presiune apa 0.5 bar ≥ 1 minut	CORESPUNDE
Rezistenta la soc (metoda cadranului)	EN 744	TIR ≤ 10%	CORESPUNDE

Denumirea si adresa laboratorului care a efectuat incercarile: Incercari Sisteme si Echipamente Termice - INSIST, B-dul Pache Protopopescu nr.66, sector 2, Bucuresti, acreditat RENAR LI 205; LABORATORUL DE INCERCARI VALROM INDUSTRIE, B-dul Preciziei, nr. 28, Sector 6, Bucuresti, Romania.

Aceasta declaratie de conformitate este emisa pe raspunderea exclusiva a fabricantului identificat la punctul 4.

Semnata pentru si in numele fabricantului de catre:

Silvia DRACEA - Sef Serviciu Consultanta Tehnica si Documentatii

Bucuresti,  
07.06.2018



Agrementele si avizele tehnice sunt disponibile pe site-ul [www.valrom.ro](http://www.valrom.ro), sectiunea download.

Editia: octombrie, 2013



MINISTERUL SĂNĂȚĂII  
INSTITUTUL NAȚIONAL DE SĂNĂȚATE PUBLICĂ  
NATIONAL INSTITUTE OF PUBLIC HEALTH



Str. Dr.A. Leonte, Nr. 1 - 3, 050463 Bucuresti, ROMANIA  
Tel: \*(+40 21) 318 36 20, Director: (+40 21) 318 36 00, (+40 21) 318 36 02, Fax: (+40 21) 312 3426

**CENTRUL REGIONAL DE SĂNĂȚATE PUBLICĂ BUCUREȘTI**  
**Comisia pentru produse, materiale, substante chimice/ amestecuri si echipamente**  
**utilizate in contact cu apa potabila**

**Solicitant: SC ROMSTAL IMEX S.R.L**  
Sos. Vitan-Barzesti, Nr. 11A, Sector 4, Bucuresti  
Nr. Inregistrare la Registrul Comertului: J40/14205/1994

**AVIZ SANITAR**  
**Nr. 09 CRSPB / 05.06.2013**

Comisia pentru produse materiale, substante chimice/ amestecuri si echipamente utilizate in contact cu apa potabila din Institutul National de Sanatate Publica/ Centrul Regional de Sanatate Publica Bucuresti, in baza Referatului tehnic de evaluare nr. 09CRSPB/05.06.2013 decide ca urmatoarele produse utilizate in contact cu apa potabila pot fi utilizate in Romania, conform prevederilor legale in vigoare.

Produsele utilizate in contact cu apa potabila:

1.1 Denumirea comerciala a produselor utilizate in contact cu apa potabila:

**TEVI PP-R si Fitinguri PP-R**

1.2 Domeniul de utilizare:

Produsele vor fi utilizate pentru instalatii sanitare ce vin in contact cu apa potabila

1.3 Conditii de utilizare: La comercializare trebuie anexate informati despre utilizarea produselor.

Producatorul: **FIRAT PLASTICK KAUCIUK SAN VE TIC AS**

2.1 Adresa: Turkobakoyu PK 12, 34907, Buyukcekmece, Istanbul

2.2 Tara: Turcia

Avizarea Sanitara a produselor utilizate in contact cu apa potabila se face in conformitate cu Ordinul ministrului sanatatii nr. 275/2012 privind aprobarea procedurii de reglementare sanitara pentru punerea pe piata a produselor, materialelor, substantelor chimice/ amestecurilor si echipamentelor utilizate in contact cu apa potabila, in baza art. 10 din Legea nr 458/2002 privind calitatea apei potabile, republicata.

Avizul Sanitar este valabil pe perioada in care nu se face nicio modificare in compozitia si calitatea produselor. Orice modificare a compozitiei si calitatii produselor duce in mod automat la anulara avizului.

**MEDIC SEF C.R.S.P.B.**  
**Dr. Florin POPOVICI**



**Presedinte Comisie,**  
**Dr. Doina LUPULESCU**

*Lupulescu*





MINISTERUL SĂNĂȚĂII  
INSTITUTUL NAȚIONAL DE SĂNĂȚATE PUBLICĂ  
NATIONAL INSTITUTE OF PUBLIC HEALTH



Str. Dr.A. Leonte, Nr. 1 - 3, 050463 Bucuresti, ROMANIA  
Tel: \*(+40 21) 318 36 20, Director: (+40 21) 318 36 00, (+40 21) 318 36 02, Fax: (+40 21) 312 3426

**CENTRUL REGIONAL DE SĂNĂȚATE PUBLICĂ BUCUREȘTI**  
**Comisia pentru produse, materiale, substante chimice/ amestecuri si echipamente  
utilizate in contact cu apa potabila**

**Solicitant: SC ROMSTAL IMEX S.R.L**  
Sos. Vitan-Barzesti, Nr. 11A, Sector 4, Bucuresti  
Nr. Inregistrare la Registrul Comertului: J40/14205/1994

**AVIZ SANITAR**  
**Nr. 09 CRSPB / 05.06.2013**

Comisia pentru produse materiale, substante chimice/ amestecuri si echipamente utilizate in contact cu apa potabila din Institutul National de Sanatate Publica/ Centrul Regional de Sanatate Publica Bucuresti, in baza Referatului tehnic de evaluare nr. 09CRSPB/05.06.2013 decide ca urmatoarele produse utilizate in contact cu apa potabila pot fi utilizate in Romania, conform prevederilor legale in vigoare.

Produsele utilizate in contact cu apa potabila:

1.1 Denumirea comerciala a produselor utilizate in contact cu apa potabila:

**TEVI PP-R si Fitinguri PP-R**

1.2 Domeniul de utilizare:

Produsele vor fi utilizate pentru instalatii sanitare ce vin in contact cu apa potabila

1.3 Conditii de utilizare: La comercializare trebuie anexate informatii despre utilizarea produselor.

Producatorul: **FIRAT PLASTICK KAUCIUK SAN VE TIC AS**

2.1 Adresa: Turkobakoyu PK 12, 34907, Buyukcekmece, Istanbul

2.2 Tara: Turcia

Avizarea Sanitara a produselor utilizate in contact cu apa potabila se face in conformitate cu Ordinul ministrului sanatatii nr. 275/2012 privind aprobarea procedurii de reglementare sanitara pentru punerea pe piata a produselor, materialelor, substantelor chimice/ amestecurilor si echipamentelor utilizate in contact cu apa potabila, in baza art. 10 din Legea nr 458/2002 privind calitatea apei potabile, republicata.

Avizul Sanitar este valabil pe perioada in care nu se face nicio modificare in compozitia si calitatea produselor. Orice modificare a compozitiei si calitatii produselor duce in mod automat la anulara avizului.

**MEDIC SEF - C.R.S.P.B.**  
**Dr. Florin POPOVICI**



**Presedinte Comisie,**  
**Dr. Doina LUPULESCU**

*Lupulescu*