

Accesories for Operating Tables

FENIX OT-01

VIVAX OT-02

ACCESORIES FOR OPERATING TABLES

This catalogue presents the wide range of accessories available for INFIMED operating table.

They were created basing on long experience in designing of medical equipment, hours spent on consultation with medical staff and functional and ergonomy testing.

The accessories haven been sorted according to practical use and surgical disciplines.

Table of contents:

GENERAL BASIC ACCESORIES	3
GYNAECOLOGY UROLOGY PROCTOLOGY ACCESORIES	12
NEUROSURGERY LARYNGOLOGY OPHTHALMOLOGY ACCESORIES	14
ORTHOPAEDICS TRAUMATOLOGY ACCESORIES	17
ANGIOGRAPHY ACCESORIES	22
POSITIONING PADS	24

General surgery positions



SUPINE POSITION



BEACH CHAIR POSITION

LATERAL POSITION AND FLEX



EB-01 One position clamp

TECHNICAL INFORMATION:

For fixation of the various accesories with rods of 16 mm diameter to the side rail

Made of stainless steel, with a matt finish



EB-02 Multi position clamp

TECHNICAL INFORMATION:

For fixation of the various accesories with rods of 16 mm diameter to the side rail

Allows radial adjustment of the accesories

Made of stainless steel, with a matt finish



EB-04 Angle arm support

TECHNICAL INFORMATION:

Height adjustment: 300mm

Distance from table top adjustment: 200mm

Tilting adjustment by ball joint

Made of stainless steel with matt finish and polyurethane foam, with two fixing velcro straps

To be fixed with EB-02 clamp



EB-05 Arm support

TECHNICAL INFORMATION:

Height adjustment: 100mm

Made of stainless steel with matt finish and polyurethane foam, with two fixing velcro straps

To be fixed with EB-01 clamp

General Basic Accesories



EB-06 Thigh holder

TECHNICAL INFORMATION:

Height adjustment: 300mm

Made of stainless steel with matt finish and polyurethane foam

To be fixed with EB-01 clamp



EB-07 Side-shoulder support (side support position)

TECHNICAL INFORMATION:

Height adjustment: 230mm

Distance from table top adjustment: 150mm

Made of stainless steel with matt finish and polyurethane foam

To be fixed with EB-01 clamp



EB-07 Side-shoulder support (shoulder support position)

TECHNICAL INFORMATION:

Height adjustment: 230mm

Distance from table top adjustment: 150mm

Made of stainless steel with matt finish and polyurethane foam

To be fixed with EB-01 clamp



EB-08 Side support

TECHNICAL INFORMATION:

Height adjustment: 150mm

Distance from table top adjustment: 150mm

Made of stainless steel with matt finish and polyurethane foam

To be fixed with EB-01 clamp

**EB-09 Anesthetic frame**

TECHNICAL INFORMATION:

Height adjustment: 600mm

Made of stainless steel with matt finish

To be fixed with EB-01 clamp

**EB-10 Anesthetic frame with adjustable width**

TECHNICAL INFORMATION:

Height adjustment: 500mm

Both side width adjustment 200mm
Made of stainless steel with matt finish

To be fixed with EB-01 clamp

**EB-11 Infusion holder**

TECHNICAL INFORMATION:

Height adjustment: 200mm

Made of stainless steel with matt finish

To be fixed with EB-01 clamp

**EB-12 Hand (shank holder)**

TECHNICAL INFORMATION:

Height adjustment: 300mm

Made of stainless steel with matt finish and polyurethane foam

To be fixed with EB-01 clamp

General Basic Accesories

EB-13 Support for meniscus operation

TECHNICAL INFORMATION:

Height adjustment: 600mm

Made of stainless steel with matt finish and polyurethane foam

To be fixed with EB-02 clamp



EB-14 Arm support, with horizontal movement

TECHNICAL INFORMATION:

Height adjustment: 300mm

Distance from tabletop adjustment: 200mm

Tilting adjustment by ball joint

Made of stainless steel with matt finish, HPL, foam mattress covered with antistatic artificial leather, fixing velcro straps
To be used with EB-01 clamp



ES-01 Leg strap ES-02 Thigh strap

TECHNICAL INFORMATION:

Adjustment by velcro: 400mm

Strap width: 100mm

Made of stainless steel with matt finish and polyamide strap

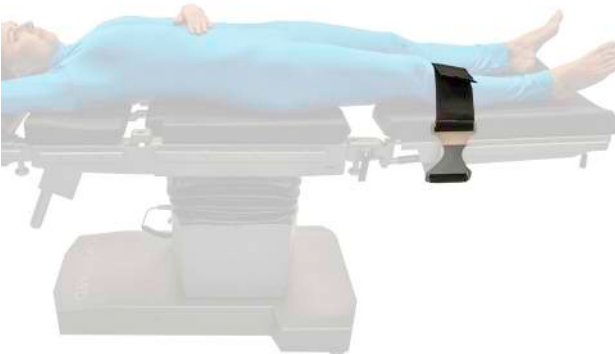

ES-03 Abdominal strap

TECHNICAL INFORMATION:

Adjustment by velcro: 400mm

Strap width: 100mm

Made of stainless steel with matt finish and polyamide strap





ES-04 Hand strap

TECHNICAL INFORMATION:

Adjustment by velcro: 400mm

Strap width: 100mm

Made of stainless steel with matt finish and polyamide strap



ES-07 Holder for additional equipment, mobile

TECHNICAL INFORMATION:

Non-marking wheels with brakes

Hooks and rails for assembly of accessories on rack

Basket in basis

Made of stainless steel with matt finish



ES-08 Holder for arm operations

TECHNICAL INFORMATION:

Fixed to side rails of operating table

Vertical adjustment of angle against tabletop
Distance from tabletop adjustment: 100mm

Height adjustable feet

X-Ray permeable tabletop, dimensions 800x400mm

Made of stainless steel with matt finish, foam mattress covered with antistatic artificial leather



ES-09 Holder for tubes

TECHNICAL INFORMATION:

Height adjustment: 200mm

Distance from tabletop adjustment: 200mm

Made of stainless steel with matt finish and HPL

To be fixed with EB-01 clamp

General Basic Accesories



ES-10 Tray for additional accessories

TECHNICAL INFORMATION:

Height adjustment: 400mm

Tray dimensions: 450x250mm

Made of stainless steel with matt finish

To be used with EB-01 clamp



ES-11 X-ray tray

TECHNICAL INFORMATION:

Height adjustment: 400mm

To be used with X-Ray cassette of width381mm

Installation from head or side

Made of stainless steel with matt finish



ES-12 Chest support

TECHNICAL INFORMATION:

Height adjustment: 150mm

Distance from tabletop adjustment: 150mm

Made of stainless steel with matt finish and polyurethane foam

To be fixed with EB-01 clamp



ES-13 Attachement for knee operation

TECHNICAL INFORMATION:

Height adjustment: 200 mm

Knee holder adjustment

Made of stainless steel with matt finish and polyurethane foam

To be fixed with EB-01 clamp



ES-14 Pubic support

TECHNICAL INFORMATION:

Height adjustment: 150 mm

Distance from tabletop adjustment: 150 mm

Made of stainless steel with matt finish and polyurethane foam

To be fixed with EB-01 clamp



ES-15 Leg support, not-divided

TECHNICAL INFORMATION:

To be fixed to siderails

Made of stainless steel with matt finish and foam mattress covered with antistatic artificial leather



ES-17 Side rail extension

TECHNICAL INFORMATION:

Extension for side rail for mounting side rail accessories

Made of stainless steel with matt finish



ES-18 Tabletop extension

TECHNICAL INFORMATION:

To be fixed to siderails

Made of stainless steel with matt finish, HPL and polyurethane foam

General Basic Accesories



ES-19 Strap for anesthetic frame

TECHNICAL INFORMATION:

To be fixed to anesthetic frame EB-09 or EB-10

Made of polymide strap



ES-20 Side extension for bariatric table-top

TECHNICAL INFORMATION:

To be fixed to siderails

Made of stainless steel with matt finish, HPL and polyurethane foam with artificial leather



ES-21 Leg support, divided

TECHNICAL INFORMATION:

To be fixed to siderails

Made of stainless steel with matt finish and polyurethane foam



GYNEACOLOGICAL SURGERY



PROCTOLOGICAL (KNEEL) SURGERY

Gynaecology Urology Proctology Accesories



EB-03 Knee support

TECHNICAL INFORMATION:

Height adjustment: 100mm

Made of stainless steel with matt finish and polyurethane foam

To be fixed with EB-02 clamp



ES-05 Gyneacological bowl

TECHNICAL INFORMATION:

Fixed instead of the leg supports

Adjustable horizontal position and rotation

Bowl capacity: 4 litres

Made of stainless steel with matt finish



ES-06 Urological bowl

TECHNICAL INFORMATION:

Fixed instead of the leg supports

Adjustable horizontal position and rotation

Bowl capacity:4 litres, with rubber outflow

Made of stainless steel with matt finish



ES-16 Proctological attachment

TECHNICAL INFORMATION:

Height adjustment: 200mm

Kneeling chair, without clamp, fixed to side rails

Abdominal support to be used with 2 pcs of EB-02 clamps

Made of stainless steel with matt finish, HPL and polyurethane foam



NEUROSURGICAL SURGERY - SUPINE POSITION (WITH DORO NEUROSURGICAL ATTACHEMENT)



NEUROSURGICAL SURGERY - SITTING POSITION (WITH DORO NEUROSURGICAL ATTACHEMENT)

Neurosurgery Laryngology Ophthalmology Accesories



EA-01 Adapter for specialistic head rest

TECHNICAL INFORMATION:

Neccessary to fix to the operating table to use DORO neurosurgical attachment or any of specialistic head rest

Made of stainless steel with matt finish



EN-01 Specialistic head rest with adjustable track

TECHNICAL INFORMATION:

Fixed to the adapter EA-01

Height adjustment 150mm, angle adjustment to the table top

Adjustment of the distance from the tabletop: 250mm

Made of stainless steel with matt finish and polyurethane foam



EN-02 Specialistic head rest, horseshoe

TECHNICAL INFORMATION:

Fixed to the adapter EA-01

Height adjustment 150mm, angle adjustment to the table top

Adjustment of the distance from the tabletop: 250mm

Made of stainless steel with matt finish and polyurethane foam



EN-05 Arm support

TECHNICAL INFORMATION:

Height adjustment: 300mm

Distance from tabletop adjustment: 200mm

Tilting adjustment by ball joint

Made of stainless steel with matt finish, HPL, foam mattress covered with antistatic artificial leather, fixing velcro straps
To be used with EB-01 clamp



DORO neurosurgical attachment for laying position

TECHNICAL INFORMATION:

To be fixed to adapter EA-01

Including:

- Adjustable Base Unit 3001-00
- Swivel Adaptor 3002-00
- QR3 Skull Clamp 1001.001
- Reusable Skull Pins Pediatric 3004-00 (3 pcs)
- Reusable Skull Pins Adult 3005-00 (3 pcs)



DORO neurosurgical attachment for sitting position

TECHNICAL INFORMATION:

To be fixed to side rails using EB-02 multiposition clamps

Including:

- Adjustable Base Unit 3001-00
- Swivel Adaptor 3002-00
- QR3 Skull Clamp 1001.001
- Reusable Skull Pins Pediatric 3004-00 (3 pcs)
- Reusable Skull Pins Adult 3005-00 (3 pcs)
- Crossbar Adaptor

Orthopaedics Traumatology Positions

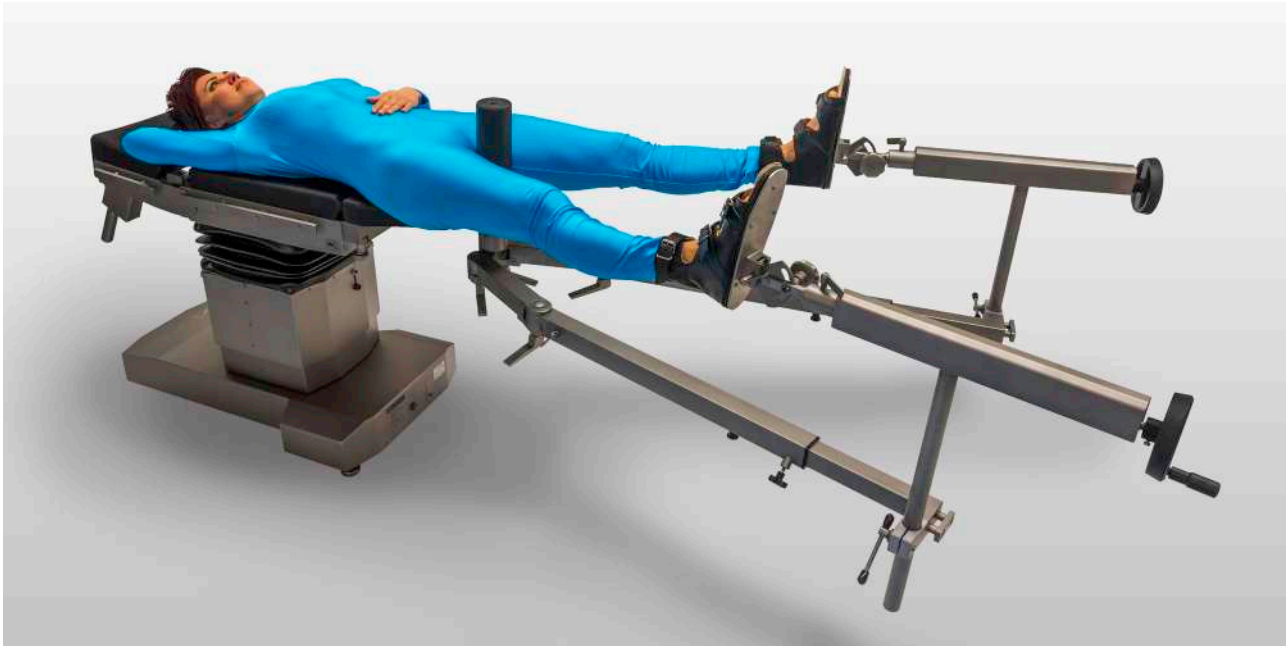

ORTHOPAEDIC SURGERY - SUPINE POSITION (ORTHOPAEDIC ATTACHEMENT EO-01)



**ORTHOPAEDIC SURGERY - SUPINE POSITION
(ORTHOPAEDIC ATTACHEMENT EA-01 WITH SUPPORTS EO-10 AND BAR SUPPORT EO-02)**



**ORTHOPAEDIC SURGERY - LATERAL DECUBITUS POSITION
(ORTHOPAEDIC ATTACHEMNT EA-01 WITH SUPPORTS EO-10 AND HIP SUPPORT EO-09)**



Ortopaedic attachemnt EO-01 (with EO-01 supports)

TECHNICAL INFORMATION:

- Includes 2 extension devices with foot plates and straps
- Additional accessories (EO-02...EO-11) are to be ordered seperately
- Fixed to leg rests sockets
- Adjustment of extensions devices height: 350mm
- Distance between support roll and extensions devices: 300-1300mm
- Adjustment of rotation arms position: 0-180
- Adjstment of length of ortropaedic attachemnts arms: 600mm
- Support roll X-Ray permeable
- Made of stainless steel with matt finish, foam mattress covered with artificial leather, polyurethane

Orthopaedics Traumatology Accessories



EO-02 Bar support

TECHNICAL INFORMATION:

To be fixed to the arms of the orthopaedic attachment EO-01 with EO-07 clamp

Height adjustment 400mm

Made of stainless steel with matt finish and leather strap



EO-03 Leg support

TECHNICAL INFORMATION:

To be fixed to the arms of the orthopaedic attachment EO-01 with EO-07 clamp

Height adjustment 400mm

Made of stainless steel with matt finish and leather strap / polyurethane foam



EO-04 Support for plastering

TECHNICAL INFORMATION:

To be fixed to the socket of the orthopaedic attachment EO-01

Made of stainless steel with matt finish and leather strap / polyurethane foam



EO-05 Heel holder

TECHNICAL INFORMATION:

To be fixed to orthopaedic attachment EO-01 instead of plate supports

Made of stainless steel with matt finish



EO-06 foot support

TECHNICAL INFORMATION:

To be fixed to the orthopaedic attachment EO-01 instead of plate supports

Made of stainless steel with matt finish and leather straps



EO-07 Clamp for orthopaedic attachment supports

TECHNICAL INFORMATION:

Used to fix the following accessories: EO-02, EO-03, EO-08, EO-11, to the orthopaedic attachment EO-01

Made of stainless steel with matt finish



EO-08 Knee operation attachment for orthopaedic attachment

TECHNICAL INFORMATION:

Without extension device

To be fixed to the arms of the orthopaedic attachment EO-01 with EO-07 clamp Height adjustment: 200mm

Adjustment of distance between support roll and extension device: 800mm

Angle adjustment against tabletop

Made of stainless steel with matt finish and polyurethane foam



EO-09 Hip support for lateral decubitus position

TECHNICAL INFORMATION:

To be fixed to the socket of the orthopaedic attachment EO-01

Adjustment left/right

Adjustment of support roll rotation

Made of stainless steel with matt finish and polyurethane foam

Orthopaedics Traumatology Accessories



EO-10 Support for orthopedic attachment arms

TECHNICAL INFORMATION:

To be fixed to the arms of the orthopaedic attachment EO-01

Height adjustment: 400 mm

Made of stainless steel with matt finish



EO-11 Knee support for side positions

TECHNICAL INFORMATION:

To be fixed to the arms of the orthopaedic attachment EO-01 with EO-07 clamp

Made of stainless steel with matt finish and polyurethane foam



EO-12 Trolley for installation of orthopaedic attachment

TECHNICAL INFORMATION:

Used to transport and assembly the orthopaedic attachment EO-01 to the operating table

Non-marking castors with individual brakes

Basket for accessories in the base

Made of stainless steel with matt finish



EO-13 Mobile stand for additional equipment of orthopaedic attachment

TECHNICAL INFORMATION:

Non-marking castors with individual brakes

Hooks and rails for storage of orthopaedic accessories

Basket in the basi

Made of stainless steel with matt finish and HPL



EO-14 Leather shoes for orthopedic attachment

TECHNICAL INFORMATION:

To be fixed to the orthopedic attachment EO-01 instead of plate supports

Made of stainless steel with matt finish and leather



EO-20 Attachment for hand operating

TECHNICAL INFORMATION:

To be fixed with 2 pcs of clamp EB-01

Height adjustment: 200mm

Adjustment of extension device length: 350mm

Adjustment of tilt and rotation of hand fixing

Made of stainless steel with matt finish and polyurethane foam



EO-30 Attachement for shoulder operations head rest EN-02

TECHNICAL INFORMATION:

To be fixed to legrests sockets

Includes EN-02 head rest

Removable right and left shoulder sections

Made of stainless steel with matt finish, polyurethane foam and HPL

Angiography table



VIEW FROM THE SIDE, WITH MAX LONGITUDINAL SLIDE



VIEW FROM THE BACKSIDE, WITH MAX LATERAL SLIDE

ER-01.0

TECHNICAL INFORMATION:

To be fixed on carbo fibre tabletop

Allows to fix heavier additional accesories on the side rails

Made of stainless steel with matt finish.



ER-01.1

TECHNICAL INFORMATION:

To be fixed on carbo fibre tabletop

Allows to fix lighter additional accesories on the side rails

Made of stainless steel with matt finish.



ER-02.0

TECHNICAL INFORMATION:

To be fixed on carbo fibre tabletop

Allows to fix heavier additional accesories on the side rails

X-ray permeable

Made of carbon fibre and stainless steel with matt finish.



ER-02.1

TECHNICAL INFORMATION:

To be fixed on carbo fibre tabletop

llows to fix lighter additional accesories on the side rails

X-ray permeable

Made of carbon fibre and stainless steel with matt finish.



Positioning pads

EM-01 Mattress for spine surgeries

TECHNICAL INFORMATION:

For positioning the patient, especially during surgical procedures on the spine

Made of polyurethane foam with artificial letter



EM-02 Mattress for sitting position

TECHNICAL INFORMATION:

For positioning the patient, especially during procedures requiring sitting position

Made of polyurethane foam with artificial letter



Gel patient body positioners

TECHNICAL INFORMATION:

Thick layered gel patient body positioners for patient on operation table: arm, chest, heel, head positioners and table pads

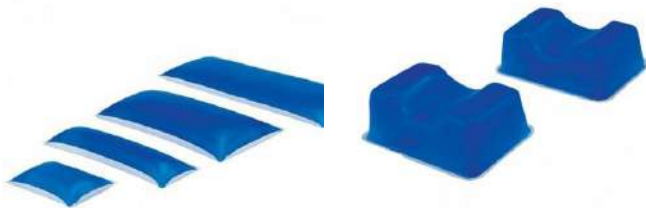



European Union
European Regional
Development Fund



For special requirement of the customer it is possible to produce the product with changed technical parameters which do not diminish its safety.

The details given in this catalogue are correct at the time of going to press. Infimed Sp. z o.o., however, reserves the right to improve shown equipment.

adres INFIMED Sp. z o.o.
ul. Kabaty 1,
34-300 Żywiec,
Polska
tel/fax +48 33 861 40 96
email office@infimed.pl
www www.infimed.pl

NIP 553-251-29-67
REGON 243274947
KRS 0000463933

Sąd Rejonowy w Bielsku-Białej, VIII Wydział
Gospodarczy Krajowego Rejestru Sądowego.
Wysokość Kapitału Zakładowego: 500 000 PLN

bank Bank Spółdzielczy
w Węgierskiej Górcie
SWIFT POLUPLPR

78 8131 0005 0016 2492 2000 0010 PLN
PL02 8131 0005 0016 2492 2000 0020 EUR
PL23 8131 0005 0016 2492 2000 0030 USD



www.infimed.pl



Operating and Treatment Lights

NEXUS OL-01/OL-02

PROXY OL-03

ONYX TL-01

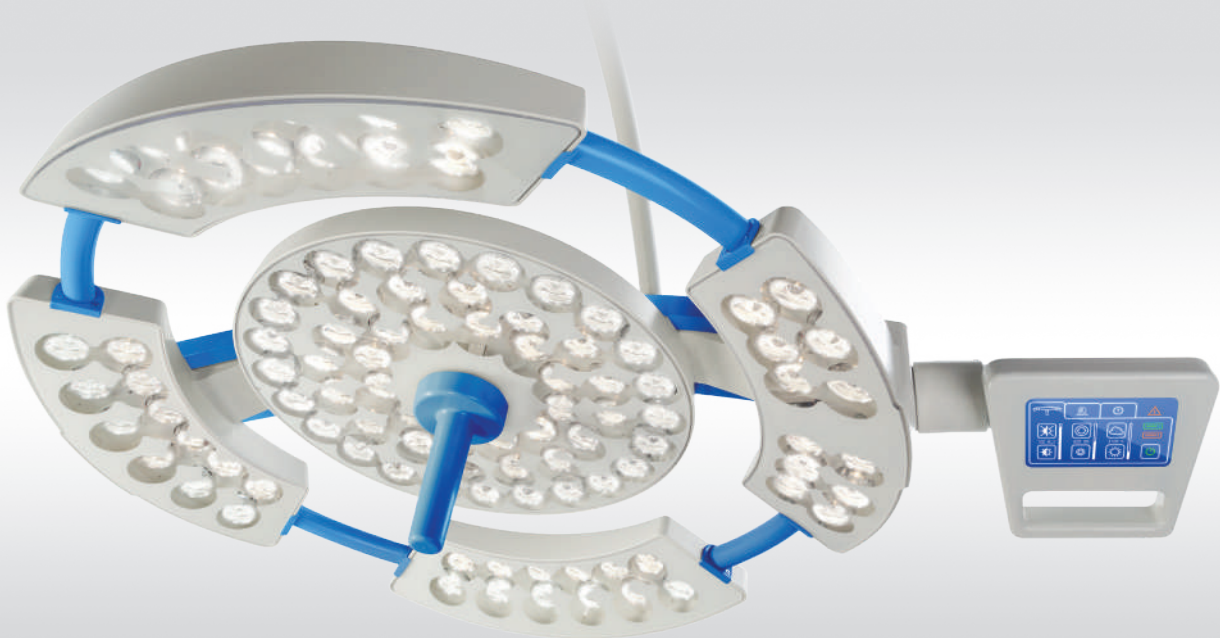
NEXUS Operating light head

Modern Design

Operating lights INFIMED NEXUS, PROXY and treatment lights INFIMED ONYX with LED light source are distinguished by innovative technology and modern design.

The little weight, ergonomic light heads as well as comfortable handles enable **easy and precise** set up and positioning of the operating light during surgery.

Waterproof, resistant to environmental factors design and smooth surfaces guarantees **ease of disinfection** and maintenance for perfect hygiene.

Ergonomic shape of the light minimizes disruption of **laminar airflow** in the operating theatre. The light heads are closed construction, composed of solid, permanently assembled elements.

Flow-optimised light head

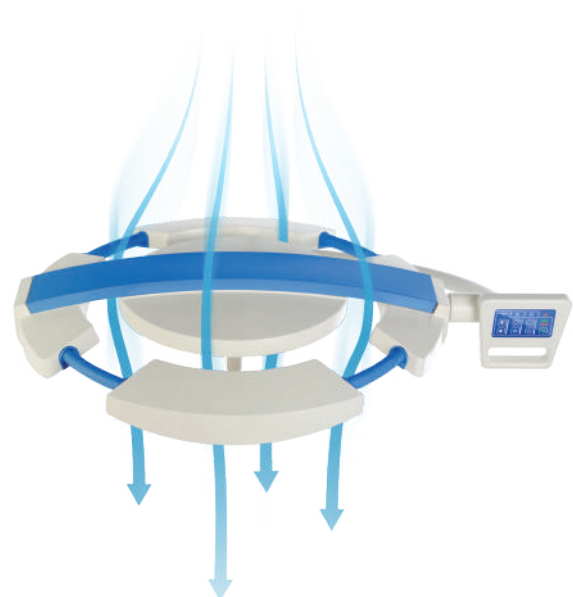

OL-01 / OL-02 / OL-03 / TL-01

Nexus / Proxy / Onyx

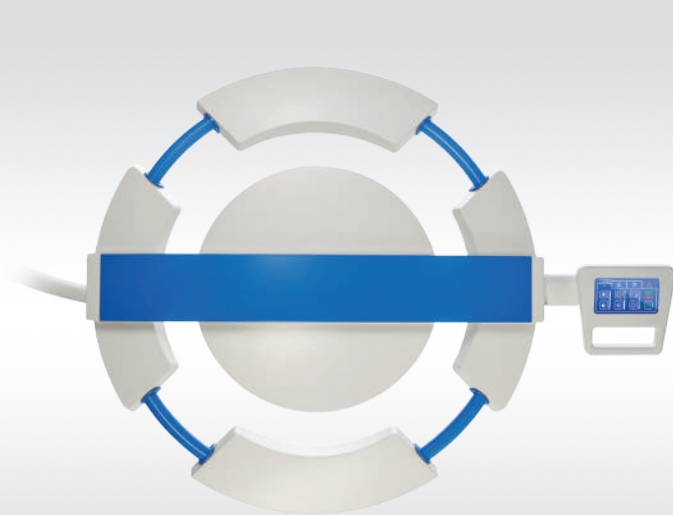

NEXUS Backside view

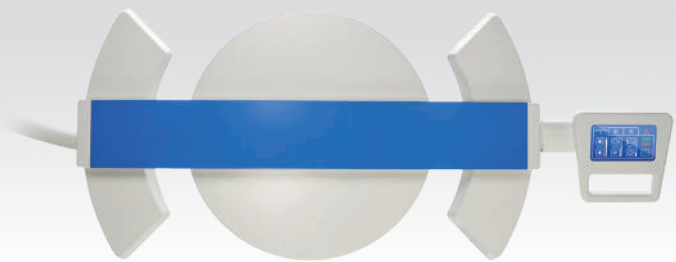

NEXUS Backside view

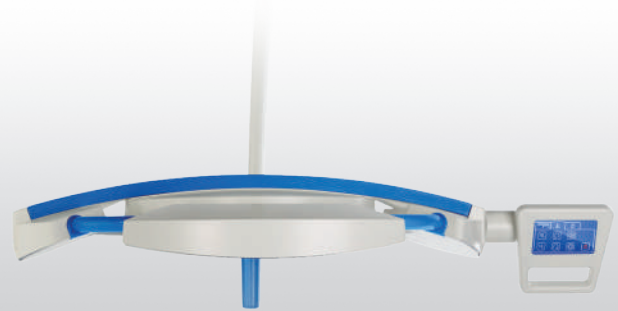

NEXUS Side view

Economy

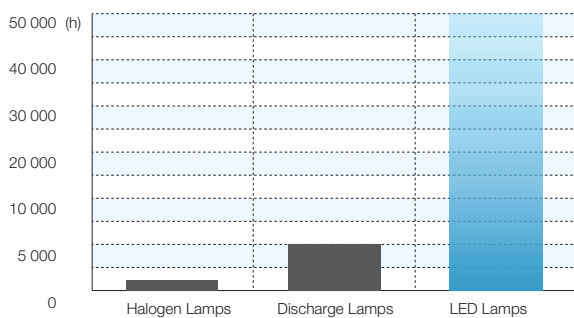

Low power consumption and high efficiency of LED light sources, provide measurable economic benefits by reducing maintenance costs of the operating theater.

Long lifetime of LED technology light sources, estimated at over 60,000 hours, several times exceeds conventional light sources. There is no frequent replacement of the light sources, significantly reducing maintenance and replacement costs.

Environmental Protection



LED light sources do not contain any heavy metals like lead or mercury which facilitate their future utilization. Aluminium, the main material of LED's can be efficiently recycled. LED light sources does not produce harmful UV radiation.

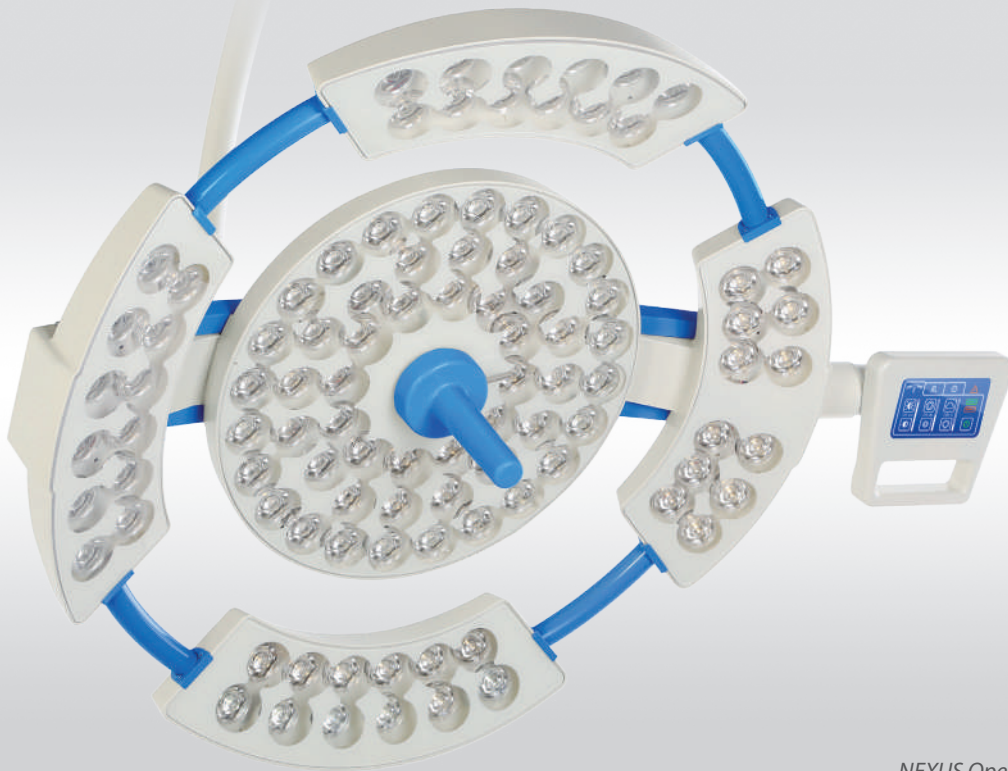

NEXUS Operating light head

Efficiency

LED technology ensures **consistent light distribution** and enables almost shadow-free conditions.

Low heat radiation minimize the temperature increase in the surgeon's head area to imperceptible level.

High light intensity and color rendering index facilities surgeries of especially narrow and deep wounds. The illumination is electronically dimmed to provide optimum illumination of operating field. Together with wide range of **operating field size adjustment** optimal visual conditions are ensured.

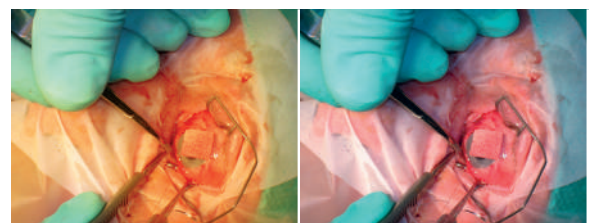
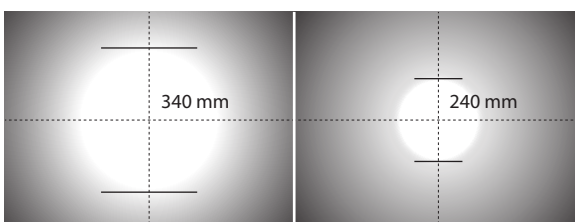

Colour temperature adjustment enables changing the contrast of the observed tissue and reduces fatigue of operating surgeon, which affects the comfort and ergonomics of the medical staff.



Adjustable **endo light** function reduces eye fatigue in case of endoscopic procedures and reflections on the monitors.

OL-01 / OL-02 / OL-03



NEXUS Operating light head

Parameter of operating light NEXUS	NEXUS OL-01	NEXUS OL-02
Light intensity E_c	160 000 lx	130 000 lx
Light intensity adjustment	5 – 100%	5 – 100%
Color temperature T_c (without adjustment)	4300K (4800 K)*	4300K (4800K)*
Color temperature T_c (with adjustment)	3800-4800 K (3700 – 5000 K)*	3800-4800 K (3700 – 5000K)*
Light field diameter d_{10} at E_c	240 – 340mm (200 - 360 mm)*	240 – 340mm (200 - 360 mm)*
Working range	600 – 1500 mm	600 – 1500 mm
Illumination depth (L1+L2)	1300 mm	1300 mm
Color rendering index [Ra(1-8)]	> 95 (> 97)*	> 95 (> 97)*
Red color rendering index [R9]	> 94	> 94
Endo lighting with adjustable intensity	1 000-20 000 lx Green light (white)*	1 000-20 000 lx Green light (white)*
Temperature of light surface after 60 min	< 40,00 ° C	< 40,00 ° C
Increase of temperature near doctor's head	< 1,00 ° C	< 1,00 ° C
Power supply	90 – 250 V AC	90 – 250 V AC
Power consumption	110W	80W
Luminary head voltage	24 – 28V DC	24 – 28V DC
Average service life of the LEDs (h)	> 60 000	> 60 000
Class of protection of light head	IP54	IP54

* additional options

Values are subject to a general industry tolerance of +/- 5%



PROXY Operating light head

Operating light PROXY

Is the smart solution of the modern operating light. The light head ensures perfect light parameters and full functionality, providing adjustments of light intensity, light field diameter and color temperature.

The light head can be equipped with the additional functions (as per page 10) as well as the video camera fixed in the center (as per page 11).

All configurations mentioned on pages 8-9 are possible to implement.



OL-03 / Operating light head with camera

OL-03



PROXY Backside view

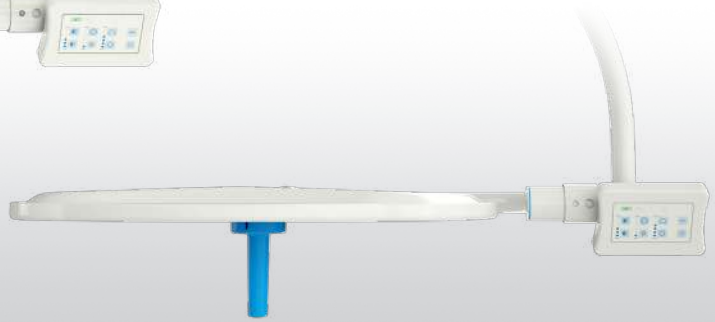

PROXY Side view

Parameter of operating light PROXY	PROXY OL-03
Light intensity E_c	160 000 lx
Light intensity adjustment	5 – 100%
Color temperature T_c (with adjustment)	3800 – 4800 K (3700-5000 K)*
Light field diameter d_{10} at E_c	240 – 340mm (200 - 360 mm)*
Working range	700 – 1400 mm
Illumination depth (L1+L2)	1200 mm
Color rendering index [Ra(1-8)]	>95 (>97)*
Red color rendering index [R9]	>93 (>95) *
Endo lighting with adjustable intensity	1 000-20 000 lx Green light (white)*
Temperature of light surface after 60 min	< 40,00 ° C
Increase of temperature near doctor's head	< 1,00 ° C
Power supply	90 – 250 V AC
Power consumption	80 W
Luminary head voltage	24 – 28V DC
Average service life of the LEDs (h)	> 60 000
Class of protection of light head	IP54

* Additional options

Values are subject to a general industry tolerance of +/- 5%

Configurations

Operating lights INFIMED are available in ceiling suspensions (single, double, triple), single wall suspension and the mobile version equipped with the battery.

Examples of suspension configurations for operating lights:

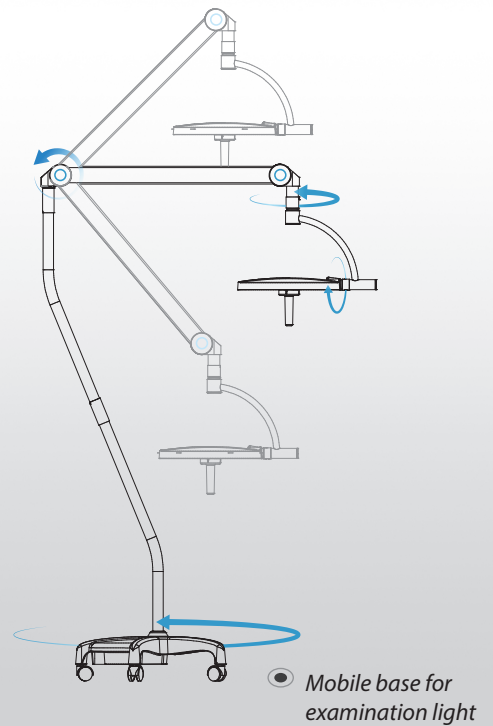
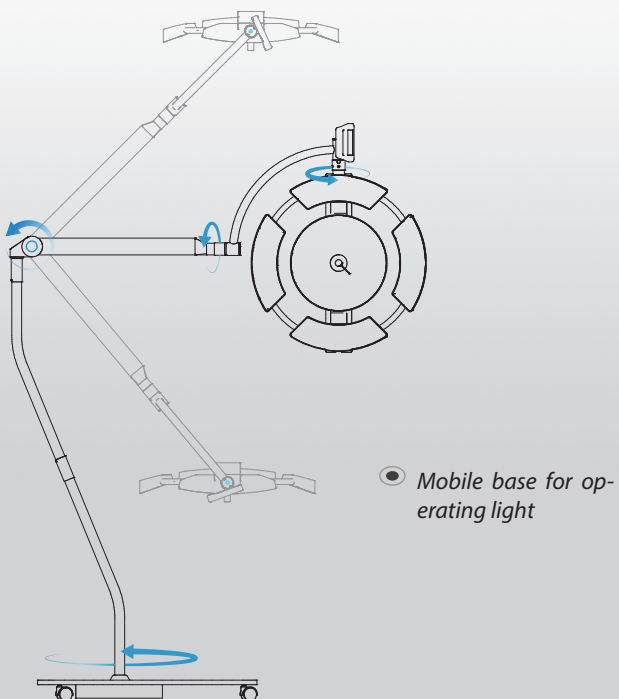
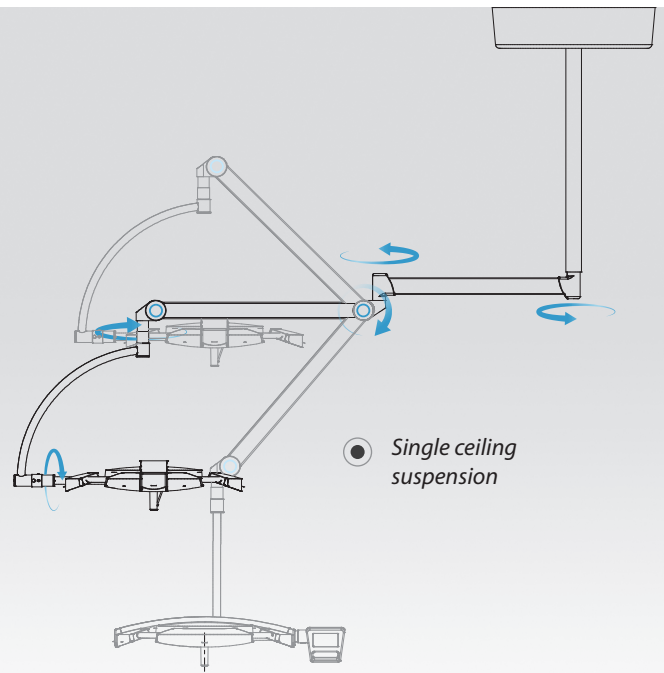
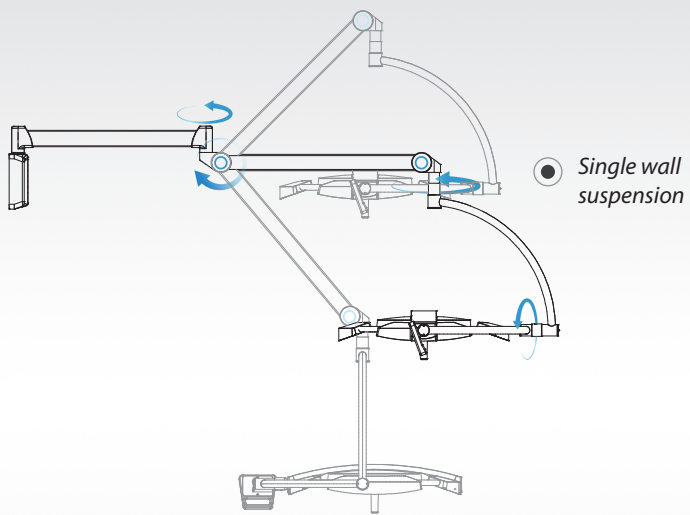

Configurations

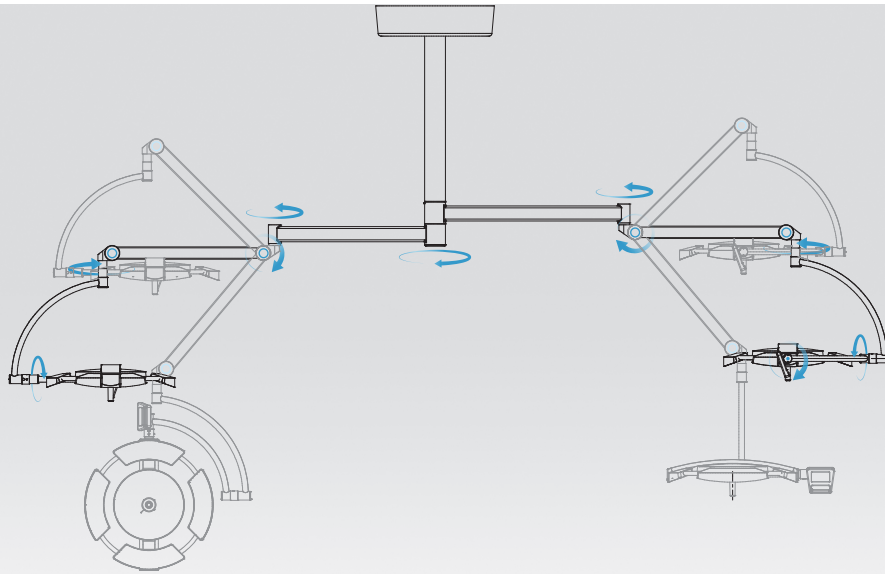

● Double ceiling suspension (>2700 mm) nx360°

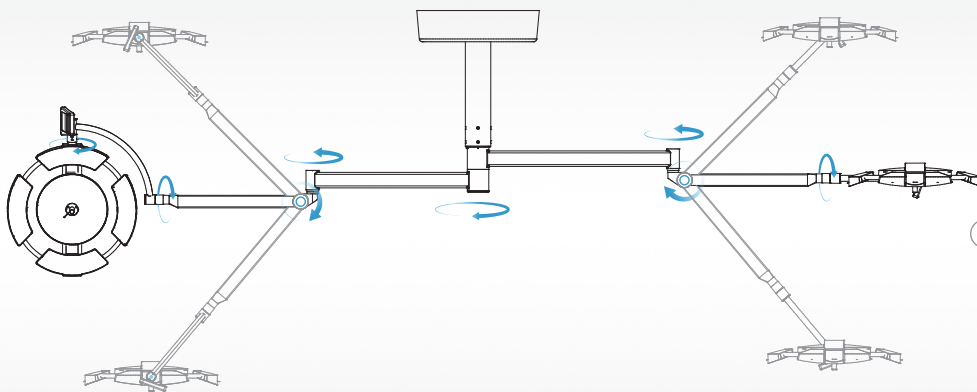

● Double ceiling suspension for low height rooms (<2700 mm) nx360°

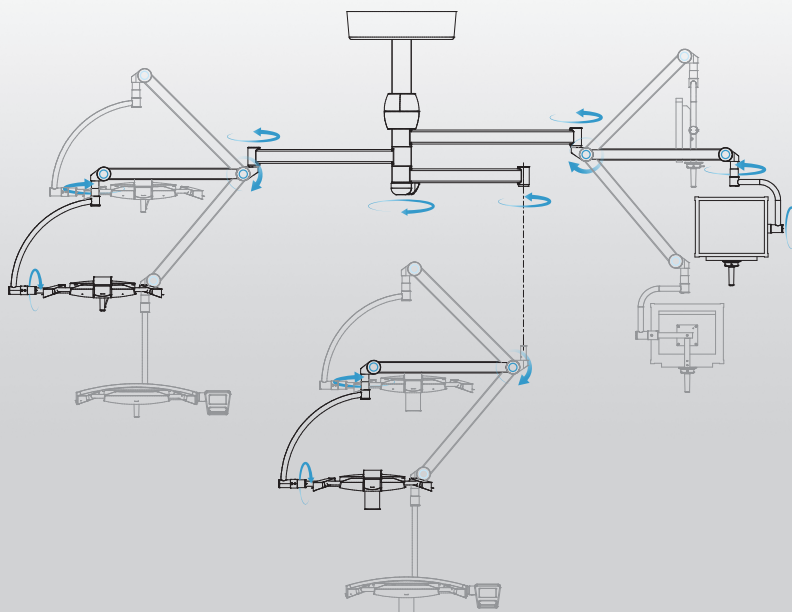

● Triple ceiling suspension, two arms n<360°, one arm nx360°

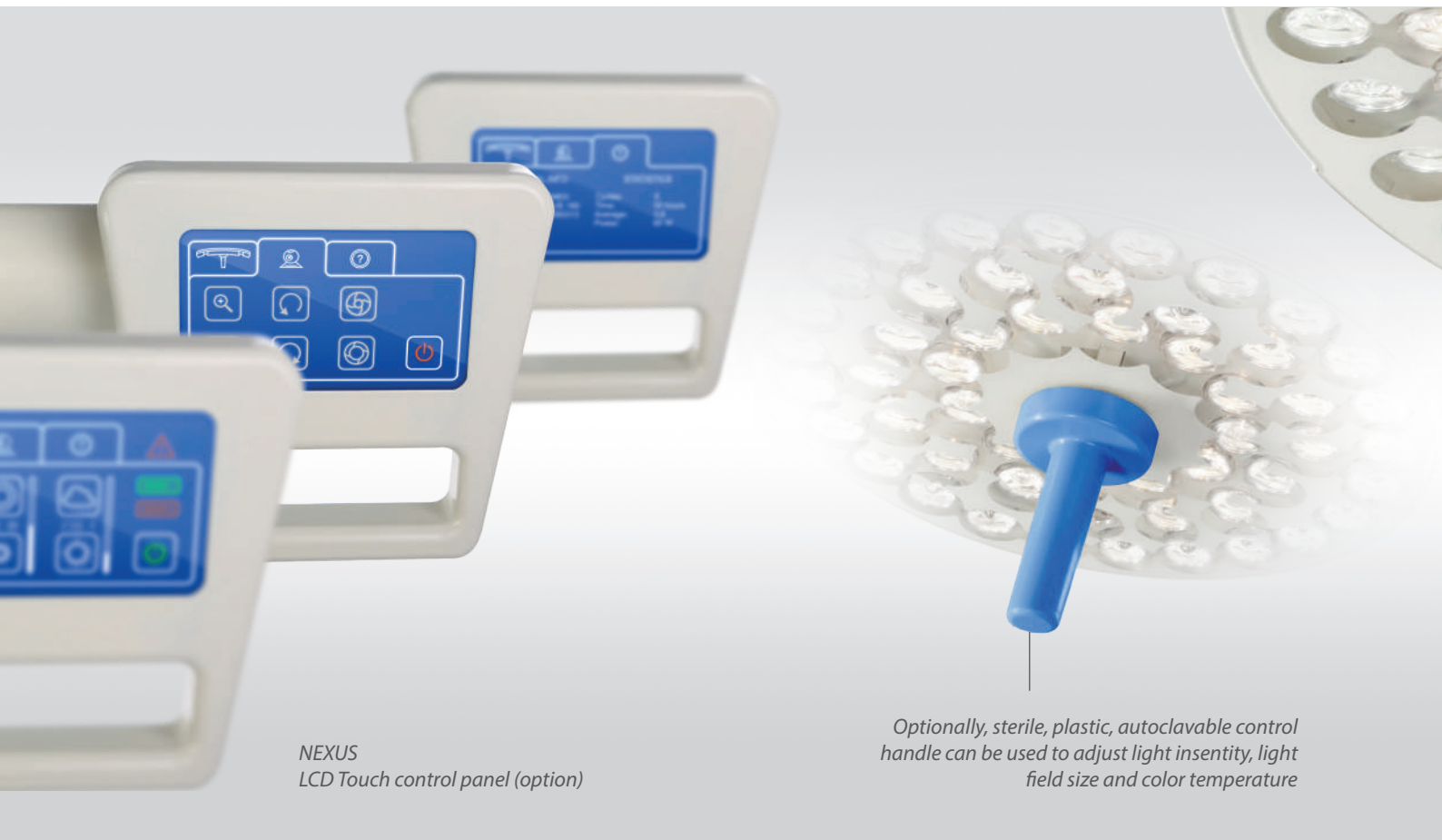

NEXUS
LCD Touch control panel (option)

Optionally, sterile, plastic, autoclavable control handle can be used to adjust light insentity, light field size and color temperature

Controls And Communication

The sensor type control panel (standard) enables adjustment of:

- illumination intensity
- endoscopic illumination intensity
- switching ON/OFF
- light field size (option)
- color temperature adjustment (option)



The LCD type control panel (option) additionally enables adjustment of camera functions (zoom, iris manual, auto, focus manual and auto, stop image, rotation with lock >360 deg.)

Additional functions

Measurement of the distance from operating area

The sensor in the light recognises the distance from the operating field and adjust the illumination intensity accordingly.

Intelligent shadow management

The sensor in the light perceives the surgeon head when it is directly under the light beam and brighten or dim specific LED's, in order to eliminate the shadows in the operating field.

Functions adjustment with sterile handle

Sterile, plastic, autoclavable control handle can be used to adjust 1-3 of following functions: light insentity, light field diameter and color temperature.

Synchronic adjustment of more light heads

Light heads adjustments can be synchronised: when adjusting any function of any light head, other light head (s) are adjusted simultaneously.

Infrared pointer

Infrared pointer shows the center of light beam.

Additional Equipment and Functions



Medical monitor



Integrated video system

Operating lights NEXUS OL-01, OL-02 and PROXY OL-03 can be equipped with video camera, fixed in the center of the light. Optionally the lights can be delivered with standard sterile, plastic handle, to be exchanged into handle with camera in the future.

Sony camera, Full 1920 x 1080/30p High Definition, adjustable from keyboard.

Camera Specifications	Details
Image Device	1/2.8 type Exmor™ CMOS sensor
Effective Pixels	Approx. 2 million
Digital Zoom	20x (200x with optical zoom)
Horizontal Viewing Angle	54.1° (wide end) to 2.9° (tele end)
Sync System	Internal
Electronic Shutter	1/2 to 1/10,000 s, 21 steps
White Balance	Auto
Focus System	Auto
Exposure Control	AE Control: Auto, Manual, Priority (shutter priority and iris priority)
Video Output	Details
Lens Value	20x Optical Zoom, f=4.7 mm (wide) ~ 94.0 mm (tele), f1.6 to f3.5
S/N Ratio More	More than 50 dB
Signal System	Signal System HD: 1080p/29.97, 1080p/25, 1080i/59.94, 1080i/50, 720p/50, 720p/29.97, 720p/25 SD: NTSC/PAL

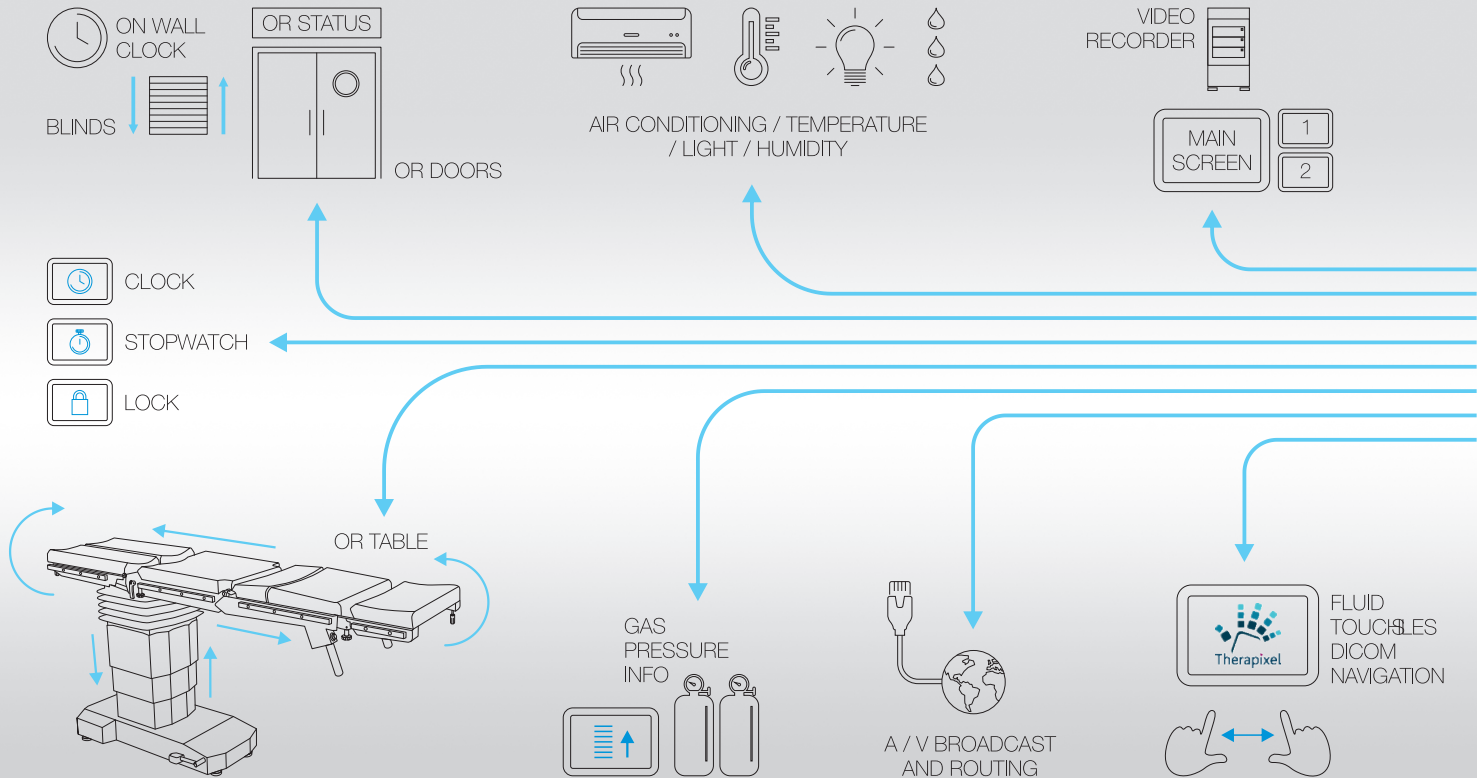

Opera control system

Provides better and easier control of the devices in the operating room from a single location. The system is very flexible, open, modular, can be adjusted to comply the client's expectations and requirements, accordingly to the above shown solutions. Can be operated from wall mounted control panel or wirelessly from mobile device.

The product is safe and secure and it is a certified Class I Medical Device manufactured in accordance with the ISO 9001, 13485 and other European standards. It provides a fully intuitive operation thanks to a simple and user-friendly interface, thereby minimizing the possibility of misuse and avoiding improper treatment operations.



Control System OPERA





Treatment light ONYX, 60 000 lx

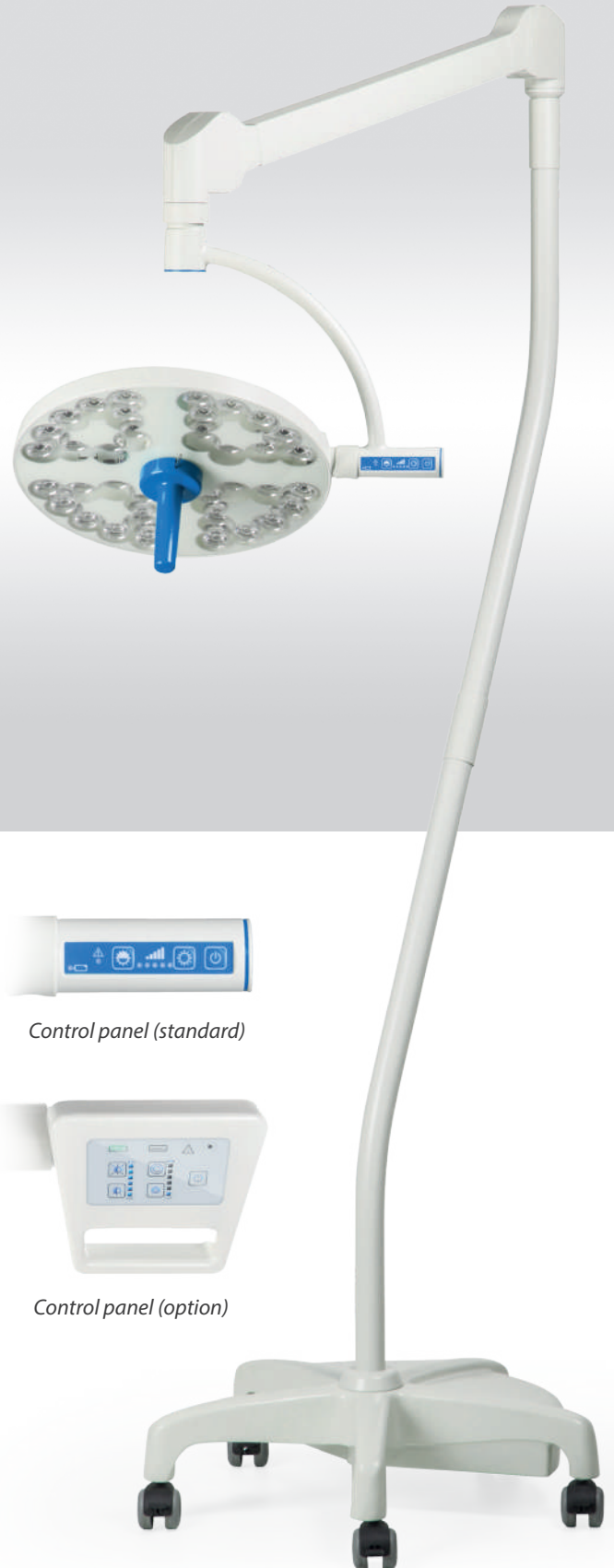

Lights ONYX TL-01

Lights ONYX are usually used in operating and procedures rooms, intensive care, neonatology units, induction rooms, dentist, dermatology, gynecology cabinets, veterinary cabinets, dissection rooms.

They are available with different levels of maximum illumination intensity: 30 000, 60 000, 100 000 up to 130 000 lx (for the lights having 100 000 and 110 000 lx it is possible to add field diameter adjustment). Light head ONYX can be also used as minor operating light.

Light intensity and optional light field diameter adjustment are set up by control panel.

All configurations mentioned on pages 8-9 are possible to implement. Lights ONYX can be also used in double ceiling system as satellite with NEXUS or PROXY operating lights.



Control panel (standard)



Control panel (option)

TL-01



Minor operating light ONYX, 100 000, 110 000, 120 000 lx with field size adjustment.



Treatment light ONYX, 30 000 lx

Parameter	ONYX TL-01 60 000/100 00 lx	ONYX TL-01 30 000 lx
Light intensity Ec	60 000 lx / (100 000 - 120 000 lx)	30 000 lx
Dimming range	10 – 100%	10 – 100%
Color temperature Tc	4300K (4800K)*	4300K (4800K)*
Light field size d10 at Ec	260 mm / (240 – 340 mm)*	240 mm
Color rendering index [Ra(1-8)]	> 92 (> 95)*	>92 (>95)*
Red color rendering index [R9]	(>90) (> 92)*	(>90)*
Temperature of light surface after 60 min	< 40,00° C	< 40,00° C
Increase of temperature near doctor's head	< 1,00° C	< 1,00° C
Power supply	90 – 250 V AC	90 – 250 V AC
Power consumption (± 10%)	50W	20W
Luminary heads voltage	24 – 28V DC	24 – 28V DC
Life cycle of the lights	> 50 000	> 50 000
Class of protection of light head	IP54	IPX2

* additional options

Values are subject to a general industry tolerance of +/- 5%



European Union
European Regional
Development Fund



For special requirement of the customer it is possible to produce the product with changed technical parameters which do not diminish its safety.

The details given in this catalogue are correct at the time of going to press. Infimed Sp. z o.o., however, reserves the right to improve shown equipment.

adres INFIMED Sp. z o.o.
ul. Kabaty 1,
34-300 Żywiec,
Polska
tel/fax +48 33 861 40 96
email office@infimed.pl
www www.infimed.pl

NIP 553-251-29-67
REGON 243274947
KRS 0000463933

Sąd Rejonowy w Bielsku-Białej, VIII Wydział
Gospodarczy Krajowego Rejestru Sądowego.
Wysokość Kapitału Zakładowego: 500 000 PLN

bank Bank Spółdzielczy
w Węgierskiej Górze
SWIFT POLUPLPR

78 8131 0005 0016 2492 2000 0010 PLN
PL02 8131 0005 0016 2492 2000 0020 EUR
PL23 8131 0005 0016 2492 2000 0030 USD



www.infimed.pl





Operating Tables

FENIX OT-01

VIVAX OT-02

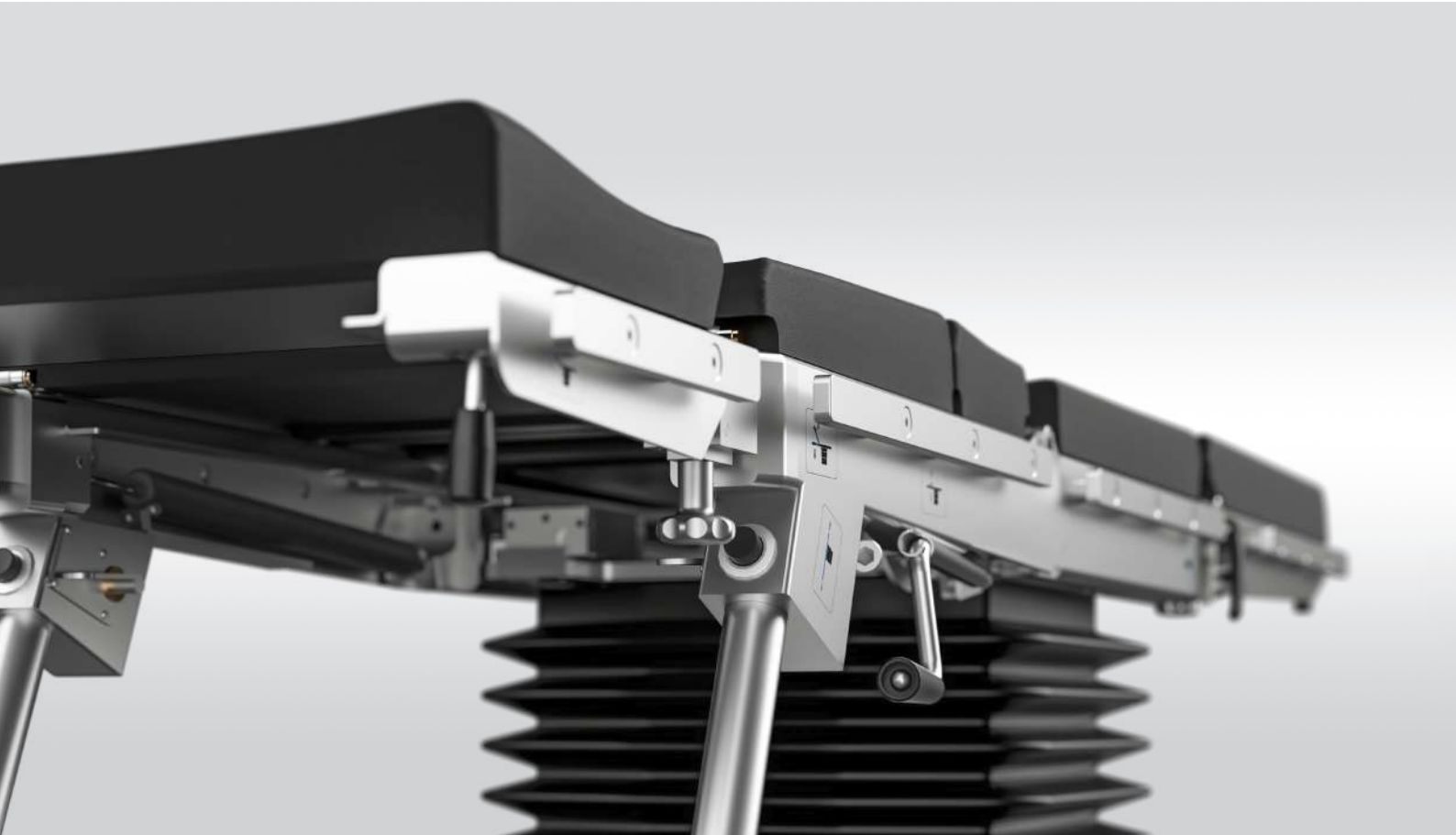

Quality
Cost Effectiveness
Versatility

Outstanding quality for reasonable price, versatility and functionality ensure operational comfort for everyday surgical work. Optional table tops and bases, together with wide range of additional accessories make it suitable for general and specialist surgical procedures.

Adjustment possibilities and ranges meets the requirements demanded by a modern universal operating tables.

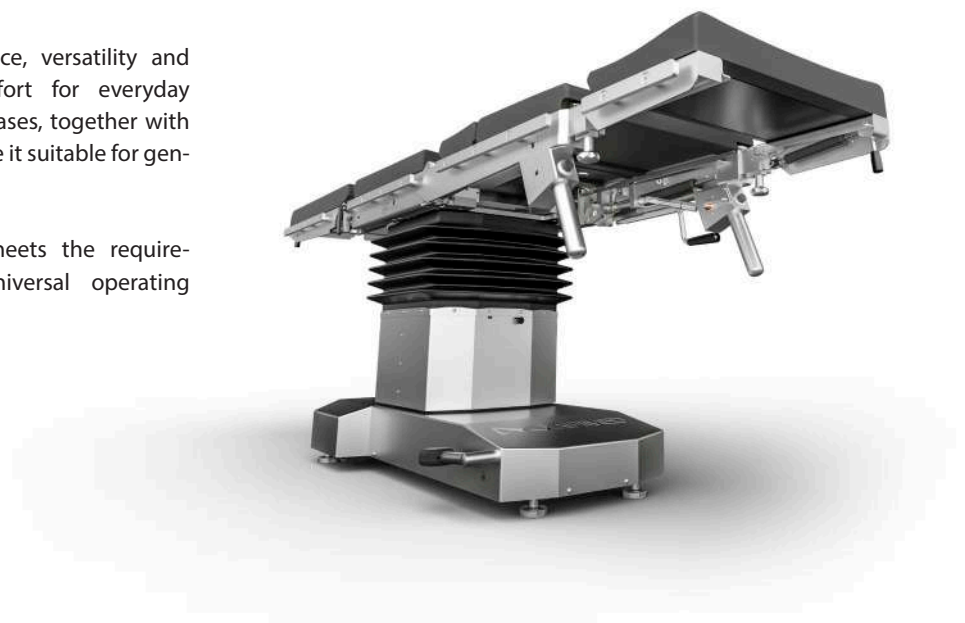

OT-01 / OT-02



Operating table VIVAX with optional "Super mobile" base



Operating table VIVAX with standard "T" base

Design

Standard "T" base with 5 antistatic castors, (4 rear castors in 2 pairs and directional one in the front), with foot operated central brake.

Optionally available base "Super mobile" for enhanced manoeuvrability and better access to the operating field, thanks to 4 antistatic castors diam. 125 mm. Driving system with foot operated central brake and directional castor.

The elements of the table top, base and column covers are made of matt polished stainless steel, which makes the surfaces smooth and hygienic. The covers are impact resistant, easy to clean, prevent fluid ingress, minimizing infection risk.

High quality, ergonomically profiled, antistatic mattresses made of polyurethane foam of thickness 50 mm. Easy removable, with antibacterial protection, seamless, ensure maximum hygiene and prevent against cross contamination.

Table tops for general surgeries:



Modular table top



5 section table top



4 section table top

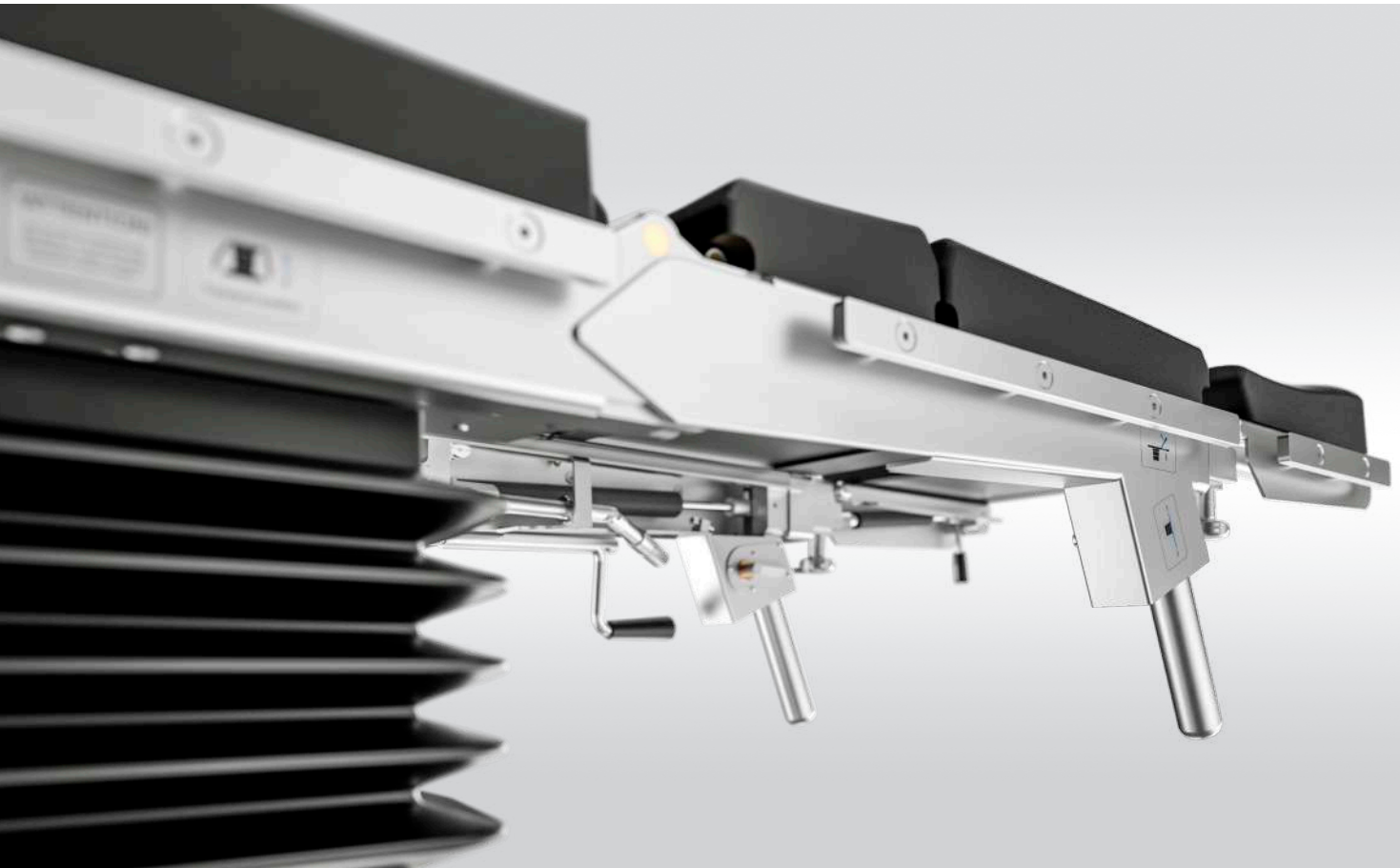



Imaging Flexibility

Multisectional (4,5 or 6 sectioned) table tops, full-length C-Arm radio translucent.

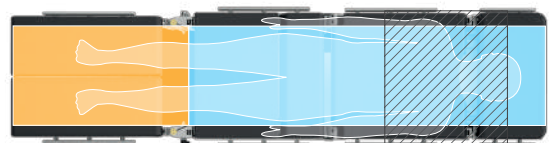
Superior imaging is ensured by full length X-ray cassette tunnel (except foot sections), with possibility of inserting the cassette from both sides, head rest and foot rests interchange and longitudinal slide (350 mm).



-  X-ray cassette tunnel and access to C-arm
-  Access to C-arm only
-  Table column - no access to C-arm

Schemes description

Table top moved to the head side, interchanged head and foot sections

OT-01 / OT-02

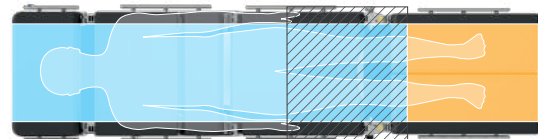
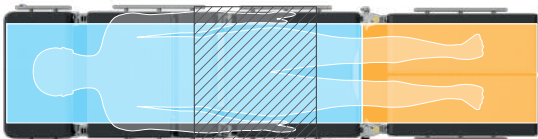

Table top moved to the foot side

Table top moved to the head side



Trendelenburg position



Elevated backrest, lowered footrests position

Features

- Battery powered, with charger built-in the base.
- Unique software providing smooth and precise table movements.
- Superior electro- hydraulic system, with technical solutions of the world leading micro-hydraulics provider.



INFIMED OPERA Control System

Controls

- Robust wire controller with visual battery level indication, ideal for simple, intuitive control (standard)
- Wire controller with LCD screen (option)
- Wireless controller (option)
- Sensor side control panel on the table column (option)
- LCD side control panel on the table column (option)
- Foot controller.
- Wall control panel (OPERA system).



Wire controller



Wire controller with LCD screen

OT-02



Kidney bridge position



Beach chair position

- Optional override control system, mechanic-hydraulic, used in case of corded hand control damage, failure of drive or main control system.
- Range of table movements controlled via electro-hydraulic drive:
 - Height adjustment,
 - Table top tilts: lateral and longitudinal (Trendelenburg and Rev- Trendelenburg),
 - Back rest section and kidney bridge (option),
 - Longitudinal slide (option)
 - Central brake (option).
- Adjustment angles of 40° Trendelenburg/ Rev Trendelenburg and and 30° tilt make it ideal solution for minimally invasive procedures.
- Range of table movements controlled mechanically or gas spring supported:
 - Backrest section and kidney bridge,
 - Footrest sections,
 - Headrest sections,
 - Longitudinal slide.



Sensor side control panel



LCD side control panel



Specialized angiography operating table VIVAX OT-02

Application:

Operations with simultaneous radiolucency of the operating field: intraoperative radiology and angiography, heart and vascular surgery.

Main Features:

- Standard "T" base with central brake.
- Carbon fibre table top, ensuring maximum X-ray transparency and unrestricted access for C-arm
- Range of table movements controlled via electro-hydraulic drive:
 - Height adjustment
 - Table top tilts: lateral and longitudinal (Trendelenburg and Rev-Trendelenburg)
 - Longitudinal slide (option)
 - Lateral slide (option)

- Range of table movements controlled mechanically or gas spring supported:

- Central brake

Controls

- standard wire controller
- joystick (option)



Joystick

OT-02



Specialized bariatric operating table VIVAX OT-02

Application: Bariatric operations of patients weighing up to 450 kg.

Main Features:

- Standard "T" base with central brake.
- Table-top with increased width, using special extensions, in order to support heavy patients.
- Range of table movements controlled via electro-hydraulic drive:
 - Height adjustment
 - Table top tilts: lateral and longitudinal (Trendelenburg and Rev-Trendelenburg)
 - Back rest section
 - Longitudinal slide
 - Kidney bridge (for 5,6 sections table-tops),
 - Central brake

- Range of table movements controlled mechanically or gas spring supported:
 - Foot rest sections
 - Head rest section





Specialized orthopaedic operating table VIVAX OT-02

Application: Orthopaedic, traumatology, shoulder surgeries.

Main Features:

- Standard "T" base with central brake.
- Table-top with fully detachable shoulder sections for unrestricted surgical access, with horseshoe headrest.
- Orthopaedic attachment fixed in place of the foot rest sections.
- Range of table movements controlled via electro-hydraulic drive:
 - Height adjustment
 - Table top tilts: lateral and longitudinal (Trendelenburg and Rev-Trendelenburg)
 - Back rest section and longitudinal slide (options)

- Range of table movements controlled mechanically or gas spring supported:
 - Back rest section
 - Headrest section
 - Central brake



















Features

- Powered by hydraulic system, operated via foot position selector and foot levers,
- Height and table top tilts adjustment available from head end enabling easy operation by the hospital staff

















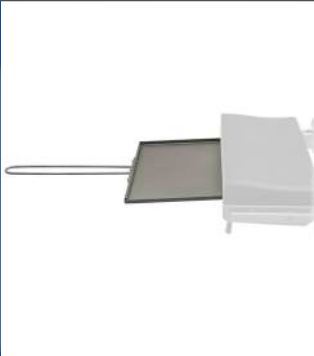

















Controls

- Range of table movements controlled hydraulically:
 - Height adjustment,
 - Table top tilts: lateral and longitudinal (Trendelenburg and Rev-Trendelenburg).
- Range of table movements controlled mechanically or gas spring supported:
 - Back rest section and kidney bridge,
 - Footrest sections,
 - Headrest sections,
 - Longitudinal slide (option).

Examples of additional accesories for opearating tables *			
			
EB-01 One position clamp	EB-02 Multi position clamp	EB-03 Knee support	EB-04 Angle arm support
			
EB-05 Arm support	EB-06 Thigh holder	EB-07 Side-shoulder support	EB-08 Side support
			
EB-09 Anesthetic frame	EB-10 Anesthetic frame with adjustable width	EB-11 Infusion holder	EB-12 Hand/shank holder
			
EB-13 Support for meniscus operation	ES-01 Leg strap ES-02 Thigh strap	ES-03 Abdominal strap	ES-04 Hand/wrist strap

Additional Accesories

Examples of additional accesories for opearating tables *			
			
ES-05 Gyneacological bowl	ES-06 Urological bowl	ES-07 Holder for additional equip- ment	ES-08 Holder for arm operations
			
ES-09 Holder for tubes	ES-10 Tray for additional accessories	ES-11 X-ray tray	ES-12 Chest support
			
ES-13 Attachment for knee oper- ations	ES-14 Pubic support	ES-15 Leg support, not-divided ES-21 Leg support, divided	ES-16 Proctological attachment
			
ES-20 Side extension for bariatric tabletop	EN-01 Specialistic head rest with adjustable track	EN-02 Specialistic head rest, horseshoe	DORO neurosurgical attachment

Examples of additional accesories for opearating tables *			
			
EO-01 Orthopaedic attachment with two extension devices and support roll		EO-02 Bar suport	EO-03 Leg support
	 		
EO-04 Support for plastering	EO-05 Heel holder EO-06 Foot support	EO-07 Clamp for orthopaedic attachment supports	EO-08 Knee operation attachment for orthopedic attachment
			
EO-09 Hip support for lateral decubitus position	EO-10 Support for orthopedic attachment arms	EO-11 Knee support for side positions	EO-12 Trolley for installation of orthopedic attachment
			
EO-13 Mobile stand for orthopedic accesories	EO-14 Leather shoes for orthopedic attachment	EO-20 Attachment for hand operating	EO-30 Attachement for shoulder operations with head rest EN-02

Technical parameters

Technical parameters of operating tables INFIMED VIVAX	OT-02 standard	OT-02 angiography version	OT-02 bariatric version
Total length of the table with 4, 5 sections, modular, orthopedic and bariatric table tops	2100 mm	----	2100 mm
Total length of the table with 6 sections table top	2300 mm	----	2300 mm
Total length of the table carbon fibre table top	----	2200 mm	----
Table top width (without / with side rails)	500 mm / 560 mm	600 mm	800 mm/ 860 mm **
Standard height adjustment, with mattress 50 mm (electro-hydraulic)	730 mm – 1080 mm	----	730 mm – 1080 mm
Extended height adjustment, with mattress 50 mm (electro-hydraulic)	700 mm – 1150 mm	----	700 mm – 1150 mm
Height adjustment, without mattress (electro-hydraulic), with longitudinal and lateral slide	----	800 mm – 1150 mm	----
Height adjustment, without mattress (electro-hydraulic), with longitudinal slide	----	730 mm – 1080 mm	----
Height adjustment, without mattress (electro-hydraulic), fixed	----	660 mm – 1010 mm	----
Lateral tilts adjustment (electro-hydraulic)	± 30°	± 20°	± 30°
Trendelenburg / reverse-Trendelenburg adjustment (electro-hydraulic)	± 40°	± 20°	± 40°
Backrest adjustment (pneumatic)	- 45° ; +85°	----	----
Optional backrest adjustment (electro-hydraulic)*	- 35° ; +85°	----	- 35° ; +85°
Footrest adjustment (pneumatic)	- 90° ; +25°	----	- 90° ; +25°
Footrest abduction (mechanic)	180°	----	180°
Headrest adjustment (pneumatic)	± 45°	----	± 45°
Kidney bridge adjustment (mechanic) Optional kidney bridge adjustment (electro-hydraulic)*	~120 mm	----	~120 mm
Longitudinal slide (mechanic) Optional longitudinal slide (electro-hydraulic)*	350 mm	350 mm	350 mm
Lateral slide (electro-hydraulic)*	----	210 mm	----
Table mass	280 kg +/- 10%	280 kg +/- 10%	2.... kg +/- 10%
Maximum dynamic / static working load	250 / 300 kg	250 kg	450 / 540 kg
Built in battery power Built in charger power	24 V 230V ~ 50/60Hz	24 V 230V ~ 50/60Hz	24 V 230V ~ 50/60Hz
Working time between battery charging	Up to 65 operations	Up to 65 operations	Up to 65 operations
Lifetime	10 years	10 years	10 years
Degree, class of protection, application part type	IP-X4 / I / B	IP-X4 / I / B	IP-X4 / I / B
Technical parameters of operating tables INFIMED FENIX		OT-01	
Total length of the table with 4 and 5 sections tabletop	2100 mm		
Total length of the table with 6 sections tabletop	2300 mm		
Table top width (without / with side rails)	500 mm / 560 mm		
Standard height adjustment (hydraulic), with mattress 50 mm	680 mm – 1030 mm		
Height adjustment (hydraulic), longitudinal slide, with mattress 50 mm	730 mm – 1080 mm		
Lateral tilts adjustment (hydraulic)	± 30°		
Trendelenburg / reverse-Trendelenburg adjustment (hydraulic)	± 40°		
Backrest adjustment (pneumatic)	- 45° ; +85°		
Footrest adjustment (pneumatic)	- 90° ; +25°		
Footrest abduction (mechanic)	max 180°		
Headrest adjustment (pneumatic)	± 45°		
Kidney bridge adjustment (mechanic), available in 5 or 6 section tabletop	~120 mm		
Optional longitudinal slide (mechanic)	350 mm		
Table mass	250 kg		
Maximum dynamic / static working load	200 /250 kg		

* additional options

** width including side extension for bariatric tabletop ES-20



European Union
European Regional
Development Fund



For special requirement of the customer it is possible to produce the product with changed technical parameters which do not diminish its safety.

The details given in this catalogue are correct at the time of going to press. Infimed Sp. z o.o., however, reserves the right to improve shown equipment.

adres INFIMED Sp. z o.o.
ul. Kabaty 1,
34-300 Żywiec,
Polska
tel/fax +48 33 861 40 96
email office@infimed.pl
www www.infimed.pl

NIP 553-251-29-67
REGON 243274947
KRS 0000463933

Sąd Rejonowy w Bielsku-Białej, VIII Wydział
Gospodarczy Krajowego Rejestru Sądowego.
Wysokość Kapitału Zakładowego: 500 000 PLN

bank Bank Spółdzielczy
w Węgierskiej Górcie
SWIFT POLUPLPR

78 8131 0005 0016 2492 2000 0010 PLN
PL02 8131 0005 0016 2492 2000 0020 EUR
PL23 8131 0005 0016 2492 2000 0030 USD



www.infimed.pl

Declaration of conformityCompany: **INFIMED Spółka z ograniczoną odpowiedzialnością**

34-300 Żywiec, ul. Kabaty 1, Poland,

Tel/fax +48 33 861 40 96

e-mail: office@infimed.pl

SRN: PL-MF-000015633

We hereby declare for our own responsibility, thatMedical device: **Operating light**Name: **PROXY**Type: **OL-03**Class: **I, according to rule 13 in conformity with annex VIII of the EU Regulation 2017/745**

Serial number:

covered by Technical file no 1.1, date 08.2021r.

Inspection documentation of device: Report of final inspection no 17.3.1.10

fulfills all the requirements of Regulation (EU) 2017/745 of the European Parliament and the Council that applies to this device.

List of all harmonized standards is indicated in Technical File.

Procedure of conformity assessment:

Annex VIII Of the EU Regulation 2017/745

INFIMED Sp. z o.o.

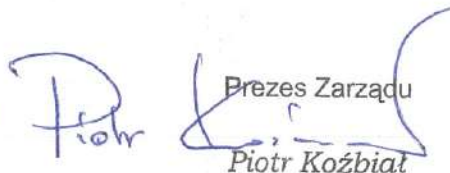
34-300 Żywiec, ul. Kabaty 1
tel./fax 33 861 40 96NIP: 5532512967 REGON: 243274947
(4)
Prezes Zarządu
Piotr Koźbiat

Place and date: Żywiec

Name and surname:

Basic UDI-DI-PI Code

INFIMED Sp. z o.o.
ul. Kabaty 1,
34-300 Żywiec, Polskatel/fax +48 33 861 40 96
office@infimed.pl
www.infimed.plNIP 553-251-29-67
REGON 243274947
KRS 0000463933Sąd Rejonowy w Bielsku-Białej, VIII Wydział
Gospodarczy Krajowego Rejestru Sądowego.
Wysokość Kapitału Zakładowego: 500 000 PLNbank Bank Spółdzielczy
w Węgierskiej Górze
SWIFT POLUPLPR78 8131 0005 0016 2492 2000 0010 PL23
PL02 8131 0005 0016 2492 2000 0020
PL23 8131 0005 0016 2492 2000 0030

Declaration of conformityCompany: **INFIMED Spółka z ograniczoną odpowiedzialnością**

34-300 Żywiec, ul. Kabaty 1, Polska,

Tel/fax +48 33 861 40 96

e-mail: office@infimed.pl

SRN: PL-MF-000015633

We hereby declare for our own responsibility, thatMedical device: **Operating table**Name: **VIVAX**Type: **OT-02**Class: **I, according to rule 13 in conformity with annex VIII of the EU Regulation 2017/745**

Serial number:

covered by Technical file no 1.1, date 08.2021r.

Inspection documentation of device: Report of final inspection no 17.3.1.02

fulfills all the requirements of Regulation (EU) 2017/745 of the European Parliament and the Council that applies to this device.

List of all harmonized standards is indicated in Technical File.

Procedure of conformity assessment:

Annex VIII Of the EU Regulation 2017/745

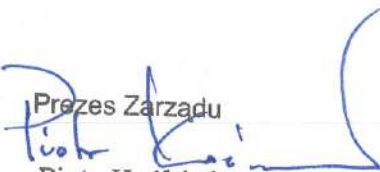
INFIMED Sp. z o.o.
34-300 Żywiec, ul. Kabaty 1
tel./fax 33 861 40 96
NIP: 5532512967 REGON: 243274947
(4)
Prezes Zarządu
Piotr Koźbiał

Place and date: Żywiec

Name and surname:

Basic UDI-DI-PI Code

INFIMED Sp. z o.o.
adres ul. Kabaty 1,
34-300 Żywiec, Polska
tel/fax +48 33 861 40 96
email office@infimed.pl
www www.infimed.plNIP 553-251-29-67
REGON 243274947
KRS 0000463933Sąd Rejonowy w Bielsku-Białej, VIII Wydział
Gospodarczy Krajowego Rejestru Sądowego.
Wysokość Kapitału Zakładowego: 500 000 PLNbank Bank Spółdzielczy
w Węgierskiej Górze
SWIFT POLUPLPR78 8131 0005 0016 2492 2000 0010 PLN
PL02 8131 0005 0016 2492 2000 0020 EUR
PL23 8131 0005 0016 2492 2000 0030 USD

Declaration of conformityCompany: **INFIMED Spółka z ograniczoną odpowiedzialnością**

34-300 Żywiec, ul. Kabaty 1, Polska,

Tel/fax +48 33 861 40 96

e-mail: office@infimed.pl

SRN: PL-MF-000015633

We hereby declare for our own responsibility, that

Medical device: Operating table

Name: FENIX

Type: OT-01

Class: I, according to rule 1 in conformity with annex VIII of the EU Regulation 2017/745

Serial number:

covered by Technical file no 1.1, date 08.2021r.

Inspection documentation of device: Report of final inspection no 17.3.1.01

fulfills all the requirements of Regulation (EU) 2017/745 of the European Parliament and the Council that applies to this device.

List of all harmonized standards is indicated in Technical File.

Procedure of conformity assessment:

Annex VIII Of the EU Regulation 2017/745



INFIMED Sp. z o.o.

34-300 Żywiec, ul. Kabaty 1

tel./fax 33 861 40 96

NIP: 5532512967 REGON: 243274947
(4)

Prezes Zarządu

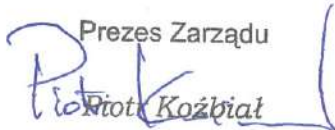

Place and date: Żywiec

Name and surname:

Basic UDI-DI-PI Code

adres INFIMED Sp. z o.o.
ul. Kabaty 1,
34-300 Żywiec, Polskatel/fax +48 33 861 40 96
email office@infimed.pl
www www.infimed.plNIP 553-251-29-67
REGON 243274947
KRS 0000463933Sąd Rejonowy w Bielsku-Białej, VIII Wydział
Gospodarczy Krajowego Rejestru Sądowego.
Wysokość Kapitału Zakładowego: 500 000 PLNbank Bank Spółdzielczy
w Węgierskiej Górze
SWIFT POLUPLPR78 8131 0005 0016 2492 2000 0010 PLN
PL02 8131 0005 0016 2492 2000 0020 EUR
PL23 8131 0005 0016 2492 2000 0030 USD

Declaration of conformityCompany: **INFIMED Spółka z ograniczoną odpowiedzialnością**

34-300 Żywiec, ul. Kabaty 1, Poland,

Tel/fax +48 33 861 40 96

e-mail: office@infimed.pl

SRN: PL-MF-000015633

We hereby declare for our own responsibility, that

Medical device: Operating Light

Name: NEXUS

Type: OL-01 and OL-02

Class: I, according to rule 13 in conformity with annex VIII of the EU Regulation 2017/745

Serial number:

covered by Technical file no 1.1, date 08.2021r.

Inspection documentation of device: Report of final inspection no 17.3.1.10

fulfills all the requirements of Regulation (EU) 2017/745 of the European Parliament and the Council that applies to this device.

List of all harmonized standards is indicated in Technical File.

Procedure of conformity assessment:

Annex VIII Of the EU Regulation 2017/745

INFIMED Sp. z o. o.
34-300 Żywiec, ul. Kabaty 1
tel./fax 33 861 40 96
NIP: 5532512967 REGON: 243274947
(4)
Prezes Zarządu
Piotr Kozbiat

Place and date: Żywiec

Name and surname:

Basic UDI-DI-PI Code

adres INFIMED Sp. z o.o.
ul. Kabaty 1,
34-300 Żywiec, Polskatel/fax +48 33 861 40 96
email office@infimed.pl
www www.infimed.plNIP 553-251-29-67
REGON 243274947
KRS 0000463933Sąd Rejonowy w Bielsku-Białej, VIII Wydział
Gospodarczy Krajowego Rejestru Sądowego.
Wysokość Kapitału Zakładowego: 500 000 PLNbank Bank Spółdzielczy
w Węgierskiej Górcie
SWIFT POLUPLPR78 8131 0005 0016 2492 2000 0010 PLN
PL02 8131 0005 0016 2492 2000 0020 EUR
PL23 8131 0005 0016 2492 2000 0030 USD



Declaration of conformity

Company: **INFIMED Spółka z ograniczoną odpowiedzialnością**
 34-300 Żywiec, ul. Kabaty 1, Poland,
 Tel/fax +48 33 861 40 96
 e-mail: office@infimed.pl
 SRN: PL-MF-000015633

We hereby declare for our own responsibility, that

Medical device: Treatment Light
 Name: ONYX
 Type: TL-01
 Class: I, according to rule 13 in conformity with annex VIII of the EU Regulation 2017/745
 Serial number:

covered by Technical file no 1.1, date 08.2021r.
 Inspection documentation of device: Report of final inspection no 17.3.1.11

fulfills all the requirements of Regulation (EU) 2017/745 of the European Parliament and the Council that applies to this device.

List of all harmonized standards is indicated in Technical File.

Procedure of conformity assessment:

Annex VIII Of the EU Regulation 2017/745



INFIMED Sp. z o. o.
 34-300 Żywiec, ul. Kabaty 1
 tel./fax 33 861 40 96
 NIP: 5532512967 REGON: 243274947
 (4)

Piotr Kozbiat
 Prezes Zarządu
Piotr Kozbiat

Place and date: Żywiec

Name and surname:

Basic UDI-DI-PI Code



adres INFIMED Sp. z o.o.
 ul. Kabaty 1,
 34-300 Żywiec, Polska
 tel/fax +48 33 861 40 96
 email office@infimed.pl
 www www.infimed.pl

NIP 553-251-29-67
 REGON 243274947
 KRS 0000463933
 Sąd Rejonowy w Bielsku-Białej, VIII Wydział
 Gospodarczy Krajowego Rejestru Sądowego.
 Wysokość Kapitału Zakładowego: 500 000 PLN

bank Bank Spółdzielczy
 w Węgierskiej Górze
 SWIFT POLUPLPR

78 8131 0005 0016 2492 2000 0010 PLN
 PL02 8131 0005 0016 2492 2000 0020 EUR
 PL23 8131 0005 0016 2492 2000 0030 USD

Certificate

Standard **ISO 9001:2015**

Certificate Registr. No. 0198 100 13761



Certificate Holder: **INFIMED Sp. z o. o.**
ul. Kabaty 1
34-300 Żywiec
Poland



Scope:

Design and development, production, distribution, installation and servicing of surgical and treatment luminaires, luminaires for diagnosis, devices for patient positioning and transport with related equipment, medical furniture and metal products, modular rooms systems for operating theatre, control systems of operating theatre equipment

Proof has been furnished by means of an audit that the requirements of ISO 9001:2015 are met.

Validity:

The certificate is valid from 2019-10-20 until 2022-10-19.

2019-10-09

Grzegorz Guabka

TÜV Rheinland Polska Sp. z o.o.
ul. 17 Stycznia 56 · 02-146 Warszawa

Certificate

Quality Management System EN ISO 13485:2016

Registration No.: SX 1436359-1

Organization: INFIMED Sp. z o.o.
ul. Kabaty 1
34-300 Żywiec
Poland

Scope: Design and development, production, distribution, installation and servicing of surgical and treatment luminaires, luminaires for diagnosis, devices for patient positioning and transport with related equipment, medical furniture, modular room systems for operating theatre as well as software working in combination with related infrastructure for managing and integration of equipment and medical devices in operating room.

The Certification Body of TÜV Rheinland LGA Products GmbH certifies that the organization has established and applies a quality management system for medical devices. Proof has been furnished that the requirements specified in the abovementioned standard are fulfilled. The quality management system is subject to yearly surveillance.

Report No.: 84956996-20
Effective date: 2022-02-18
Expiry date: 2025-01-30
Issue date: 2022-02-18



Jarosław Pyclik
TÜV Rheinland LGA Products GmbH
Tillystraße 2 · 90431 Nürnberg · Germany