



LOGIQ Fortis™

A powerfully streamlined,
next-generation ultrasound solution



Always ready. Always by your side.

LOGIQ Fortis is a trademark of GE.

Our core beliefs



- Ultrasound – safe, real-time, and easy – will **permeate** every aspect of healthcare around the globe
- Ultrasound is at an **inflection point**: volumetric, tissue characterization, screening & guidance, machine learning
- Ultrasound leaders of tomorrow are **investing heavily today in R&D**
- **Clinical partnerships** are key to driving innovation



Color Flow with Radiantflow™ in Renal, C2-9-D

LOGIQ Fortis™

Powerfully streamlined



STRONG | SLEEK | POWERFUL

The GE LOGIQ Fortis ultrasound is built to help users deliver on the promise of confident care in multiple clinical settings. Small and sleek enough to move to patients across departments and equipped with our most powerful technology, it is GE's affordable all-in-one solution.

LOGIQ Fortis™

Powerfully streamlined



Exceeding your expectations
Optimizing your productivity
Maximizing your investment

NEXT GENERATION, MULTI-PURPOSE
ULTRASOUND SOLUTION



LOGIQ Fortis™ ultrasound pillars



Exceeding your expectations

From diagnosing more patients in a day to increased use across clinical care areas, GE Healthcare understands that how you rely on ultrasound is changing. The LOGIQ Fortis was created to accommodate your changing needs in multiple clinical settings, going beyond what you've come to expect from an ultrasound system. Designed to be powerful inside and out, it is outfitted with probes for whole body imaging and equipped with our most advanced clinical tools. LOGIQ Fortis is the streamlined system your hospital needs to advance the ultrasound capabilities now and into the future.

Optimizing your productivity

The LOGIQ Fortis is powerfully streamlined to optimize your daily workflow. Outfitted with advanced productivity tools that help facilitate diagnosis and improve treatment, it is the system you can count on for consistent whole-body imaging. Ergonomically, it has maintained the LOGIQ™ family key layout proven to cut down on keystrokes and time. Intuitive to learn and integrate into your day, the LOGIQ Fortis gives you a level of clinical confidence that comes from comprehensive decision support.

Maximizing your investment

Make the most out of your ultrasound investment with the GE LOGIQ Fortis. Powered by GE Healthcare's next generation architecture and platform, the cSound™ Architecture and the A to A Digital platform, and sleek enough to move to patients, it's the system needed across your facility. New users can count on the LOGIQ Club to ensure quick training and ongoing support while hospital administrators can monitor utilization and performance through expert digital tools such as the probe health check and on-demand support. With constant coverage for the life of the system and access to technology updates, the LOGIQ Fortis maximizes your ultrasound investment today and into the future.

LOGIQ Fortis™ ultrasound pillars



Exceeding your expectations

- Next Generation cSound™ Architecture with Advanced SRI
- Auto-Optimized Images (CTO)
- Wide range of clinical applications (obese to thin/neonate to geriatric)
- Extended XDclear™ probes
- Radiant*flow*™
- Micro Vascular Imaging (MVI)
- Contrast enhanced ultrasound
- Volume Navigation
- B-Flow, Hybrid B-Flow
- B-Steer+
- 2D Shear Wave Elastography
- Ultrasound-Guided Attenuation Parameter (UGAP)
- OmniView
- 3D GPS
- Compare Assistant
- SonoRender Live
- AI-based diagnosis support
 - Breast Assistant, powered by Koios DS™

Optimizing your productivity

- LOGIQ™ apps
 - Photo app
 - Remote Control app
- AI-Based Productivity Tools
 - Auto Lesion Segmentation
 - Auto Doppler Assistant
 - OB Measure Assistant
 - Volume Navigation Image Based Registration (IBR)
- Productivity & Measurement Packages: Scan Assistant, Breast/Thyroid, Semi-Quant Analysis, OB, Breast
- SonoNT & SonoIT
- Optimized ergonomics
- Portable system
- Scan on battery
- Start Assistant
- EZ Imaging
- Hepatic assistant
- Raw Data

Maximizing your investment

- A to A Digital Platform... future-focused
- SonoDefense
- Fully featured and scalable options
- Multi-purpose ultrasound
- Migrated leadership features
- Life cycle solutions

GI ultrasound

Continued innovation



LOGIQ P Series



LOGIQ™ P10 XDclear/
LOGIQ P9 XDclear
LOGIQ P8



LOGIQ Fortis™

LOGIQ E10 Series



LOGIQ E10s



LOGIQ E10



Key Trends

Key trend impacting ultrasound – The digital future



How does ultrasound fit into the digital world?

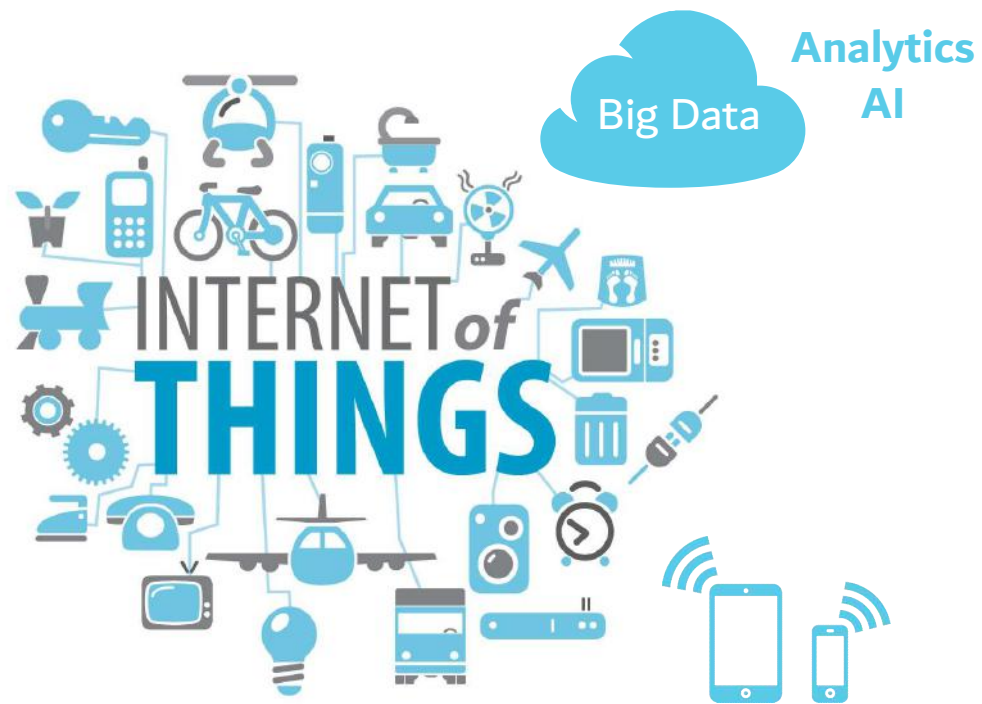

How can we harness the power and make it useful?

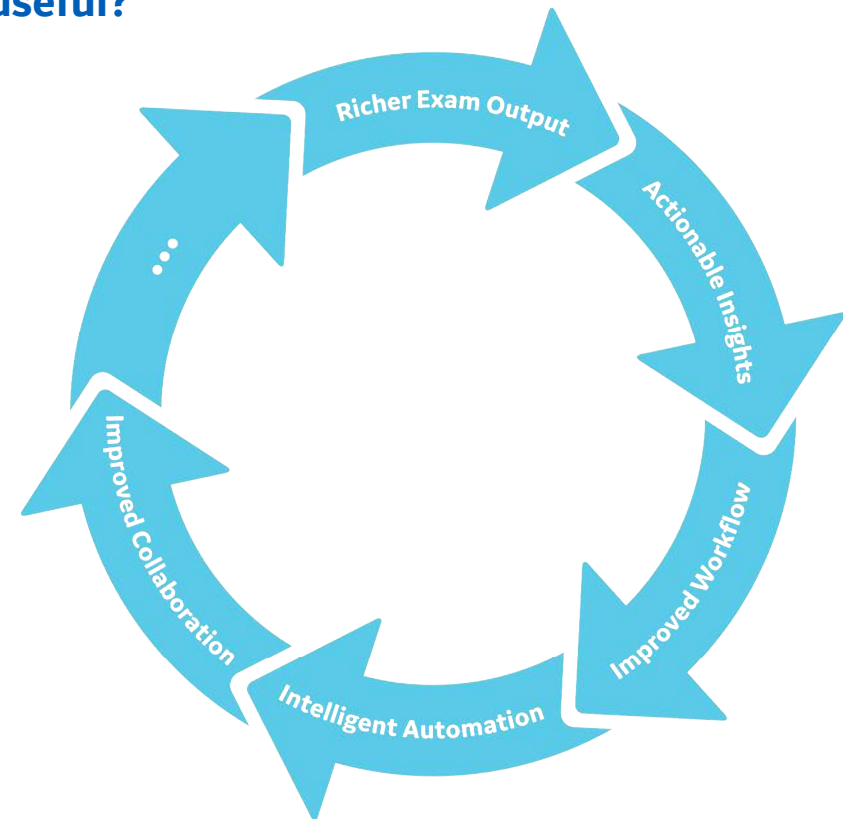

Key trends in ultrasound



- **Patients:** Harder to scan
- **Tissue:** New characterization methods
- **Workflow:** Automation and integration



Higher rates of obesity and advanced disease



2D Shear Wave Elastography with Quality Indicator, Liver, C1-6-D



Ergonomic and Productivity Improvements

Key trends in ultrasound



- **Precision medicine:** Multi-modality fusion
- **Portability:** Moving to the patient
- **Future readiness:** Ultrasound is continuously evolving

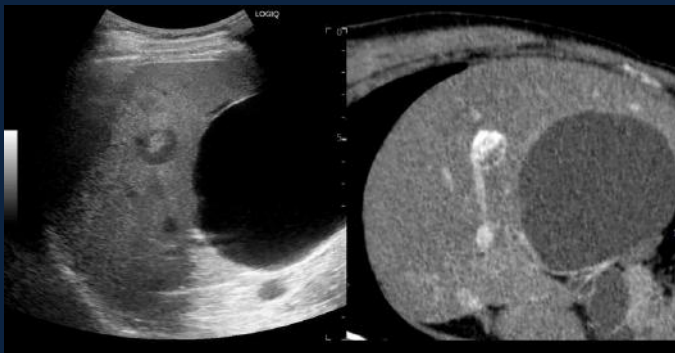

Ultrasound Fusion, Volume Navigation, C1-6-D



Ultrasound at the bedside

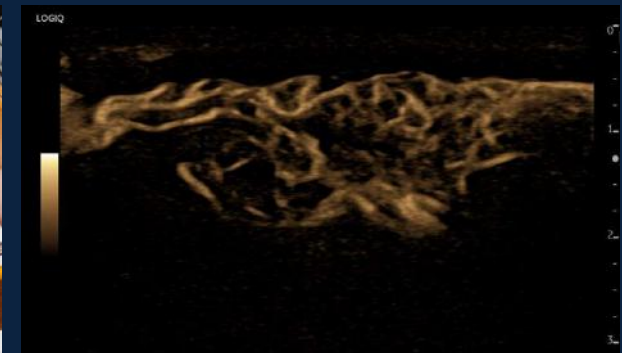

Flow Visualization, B-Flow in Thyroid, ML6-15-D

Trends

1. Harder to scan patients
2. Tissue characterization
3. Workflow
4. Ultrasound fusion
5. Portability
6. Automation
7. Increasing connectedness



Digital Thread



Big Data



Cloud Computing



Smart Device Apps

Technology innovation example

Google™ car = car + sensors + ecosystem



Car + sensors

Enabled by:

- Big data
- Enormous real-time processing capabilities (GPUs)

Onboard now:

- Collision detection
- Lane drift notification
- Rear camera
- Self-parking
- Speed/fuel control



Digital ecosystem

- Weather reports
- Maps
- Construction alerts
- Remote support



Google self-driving car

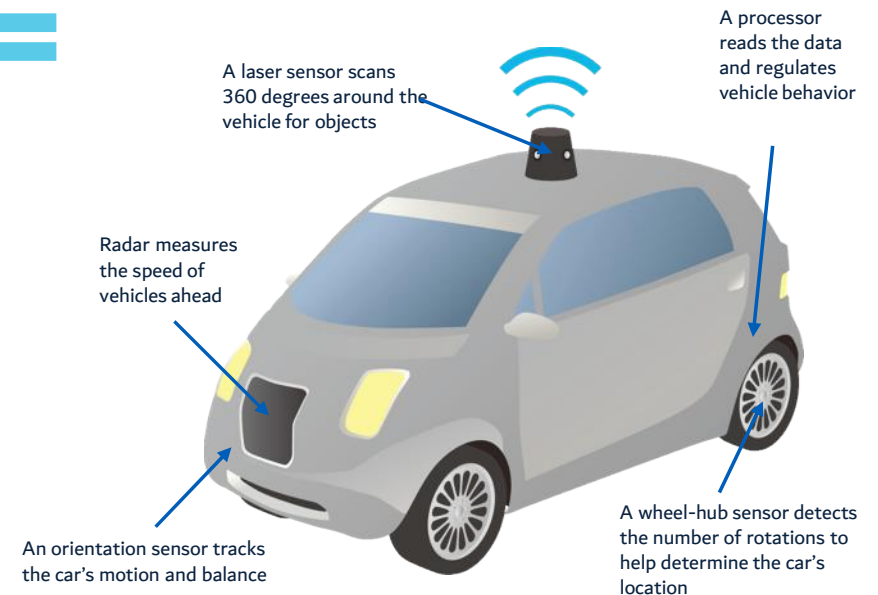

AUTOMOTIVE PLATFORM FOR TECHNOLOGICAL INNOVATION



Next Generation Technology

The transformation of ultrasound

Parallel Processing
Analog → Digital
2D → 3D

Next Gen Imaging System

DICOM® Imaging
DICOM SR

Next Gen Digital Platform

- Huge data throughput
- Massive compute power
- Real-time deep learning inference engine
- Cloud connected
- Smart device compatibility
- Big data enabled

B-Mode, Color Mode, PDI & Doppler – Powered by the cSound™ Imageformer

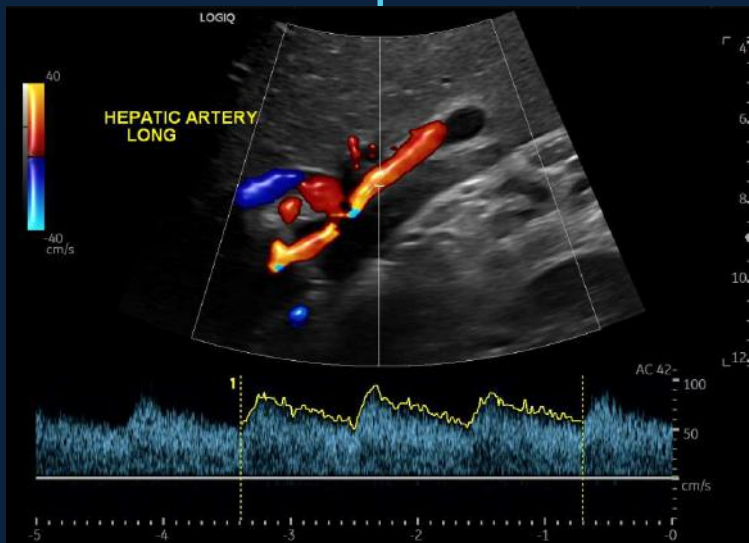

cSound B-Mode CF with Radiantflow™ PW

Every pixel
in focus

*Uniformity throughout the image
No focal zone required*

Fast frame
rates

Scan quickly without blurring

Great
simultaneous

*Triplex
B-Flow + PW
CW Simultaneous*

Hybrid B-Flow – Powered by the cSound™ Imageformer



Flow sensitivity

Visualizes flow regardless of direction

True flow characteristics

*Eliminates wall overwriting
Shows hemodynamics*

Wide availability

C1-6-D, L2-9-D, C2-9-D, L8-18i-D, C2-7-D, C3-10-D, L3-12-D, L6-24-D, ML6-15-D and M5Sc-D



Hybrid B-Flow Liver, C1-6-D

Elastography mode – Powered by the cSound™ Imageformer



Better strain

*Easy to get good quality
Minimal compression needed
Increased frame rate*

SWE consistency

*Same cutoff charts as
LOGIQ™ E10 Series*

SWE speed

*Breast and MSK Sup
Frame rates >1 Hz
Penetration up to 4 cm*

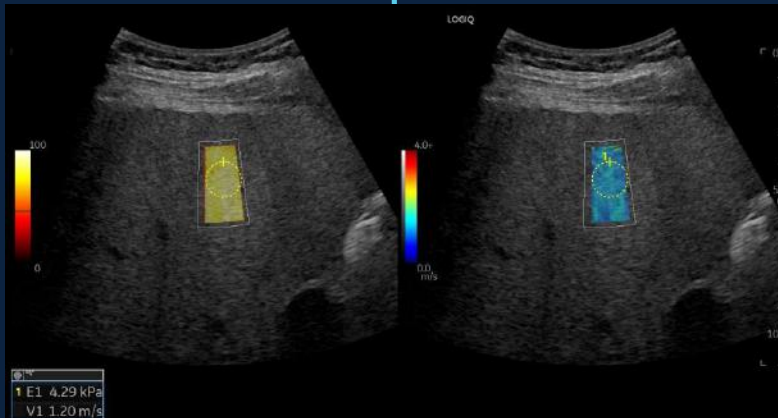

2D Shear Wave Elastography with Quality Indicator, Liver, C1-6-D



Hepatic Assistant: 2D Shear Wave Elastography & Ultrasound-Guided Attenuation Parameters (UGAP) combined

Fast workflow

Combines workflow for 2D Shear Wave Elastography & UGAP

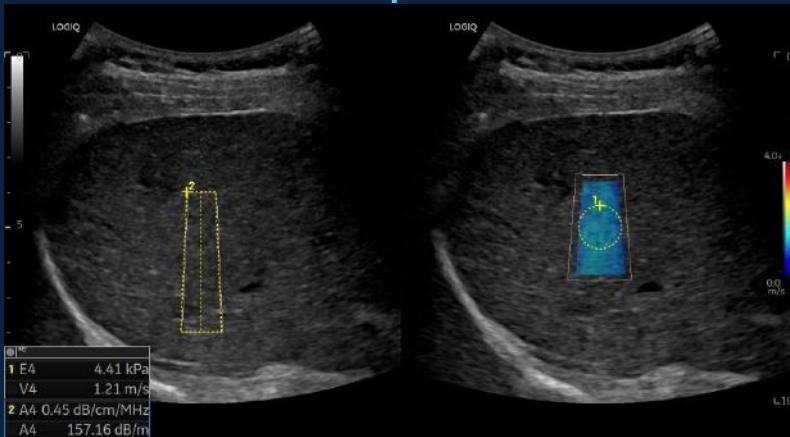

Hepatic Assistant: Combining 2D Shear Wave Elastography and UGAP, C1-6-D

Consistency

Same cutoff charts as LOGIQ™ E10 Series

Liver

Optimized for liver diagnosis and follow-up

Contrast Imaging – Powered by the cSound™ Imageformer



Image quality

*Improved sensitivity
Improved spatial resolution
Faster frame rate*

Easy to use

*No focus control...focus everywhere
Target MI control*

Wide availability

*C1-6-D, C2-9-D, C2-7-D, C3-10-D, IC5-9-D, RIC5-9-D,
RAB6-D, L2-9-D, L3-12-D, ML6-15-D, M5Sc-D*

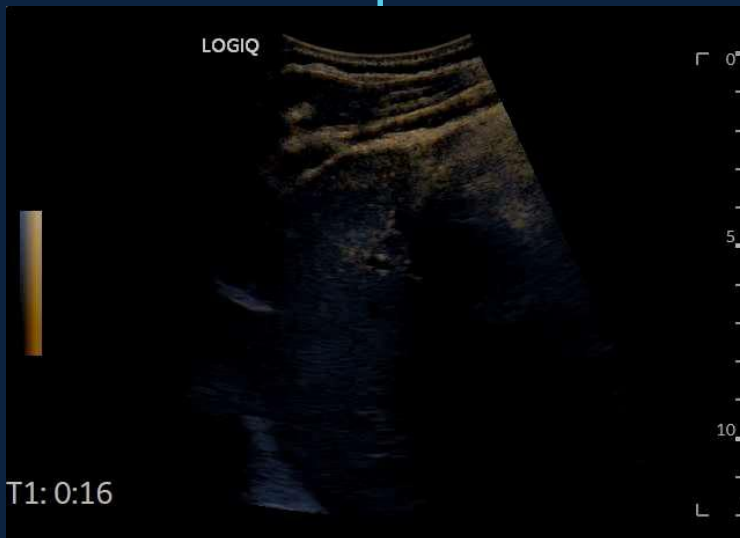

Contrast Enhanced Hybrid
View of Liver Lesion, C1-
6-D

LOGIQ Fortis™



Pivot to next generation GPU electronics

The technology enabling driverless cars

Generation XDclear™ probes

The future of ultrasound transducers

Hyper-connected internet device of the future

The smart phone of the ultrasound department

Next generation ergonomics
>250,000 LOGIQ™ Install Base users will appreciate the easy transition

Next Gen Imaging System



10x processing power

Same **technology** used for driverless cars and next gen gaming

48x data throughput

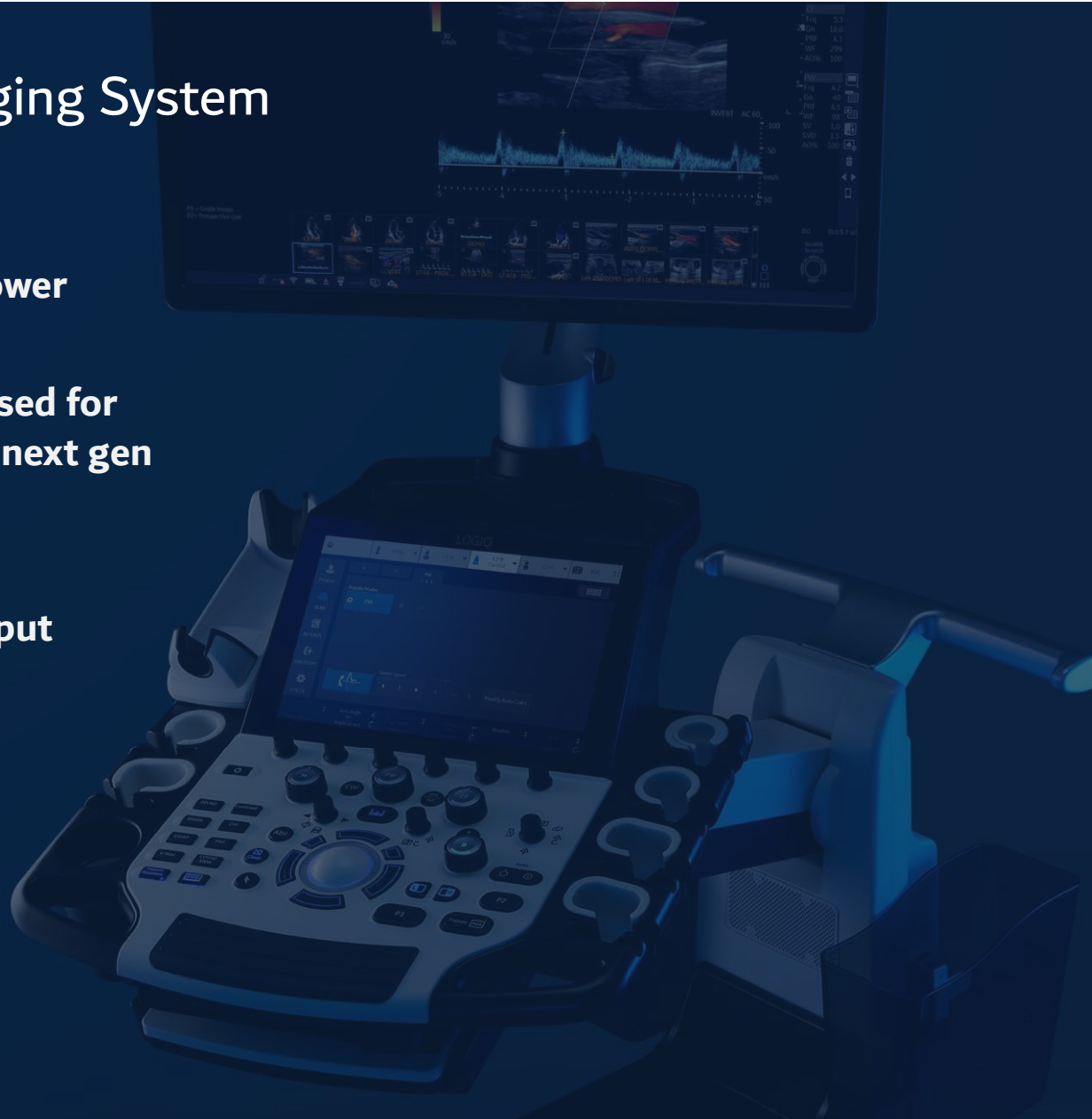

Next Gen Imaging System

10x processing power

Same **technology** used for driverless cars and next gen gaming

48x data throughput

Next Gen Digital Platform

Smart device compatibility

Cloud connectivity

Generate **big data** and deploy deep learning



An ultrasound system for today...
...a platform for tomorrow

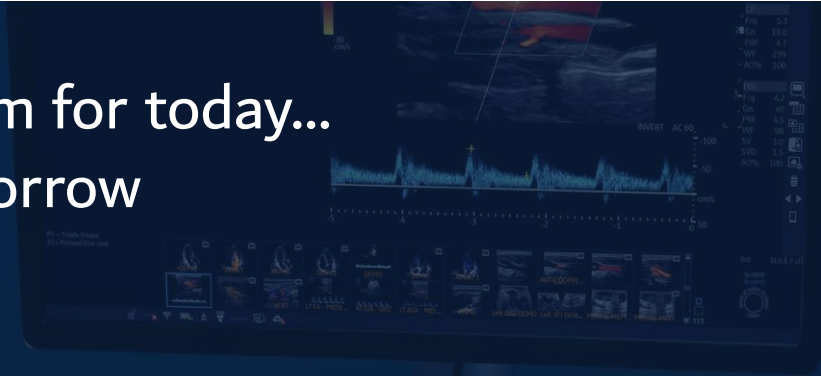

**Next Gen
Imaging
System**

**Next Gen
Digital
Platform**





Clinical Image Gallery

Radiology



B-Mode with Advanced SRI Liver with TIPS, C1-6-D



B-Mode with Advanced SRI Spleen, C2-9-D

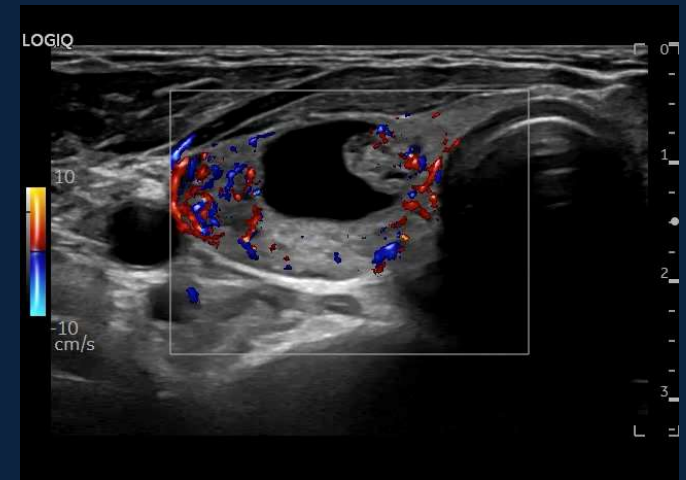

Radiantflow™ Color Flow in Thyroid, ML6-15-D

Pediatrics

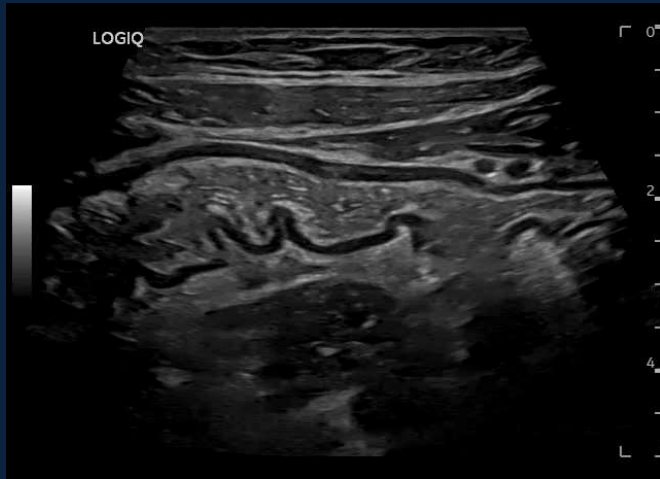

B-Mode with Advanced SRI in Bowel, L2-9-D



MVI with Radiant*flow*™ Neonatal Brain, L6-24-D

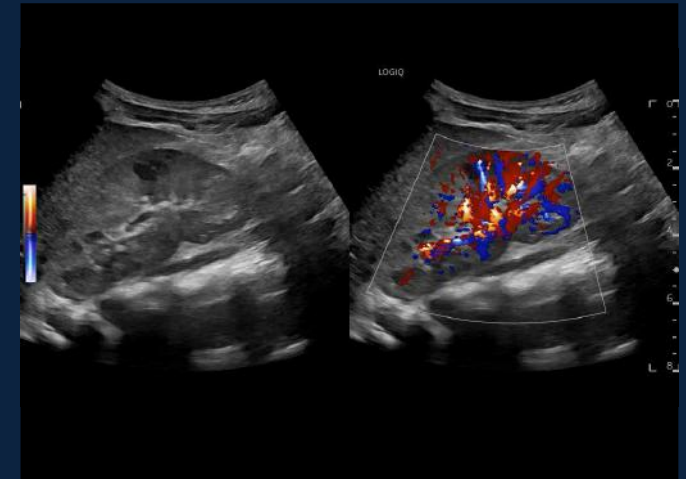

PDI with Radiant*flow* Pediatric Kidney, C2-9-D

Breast

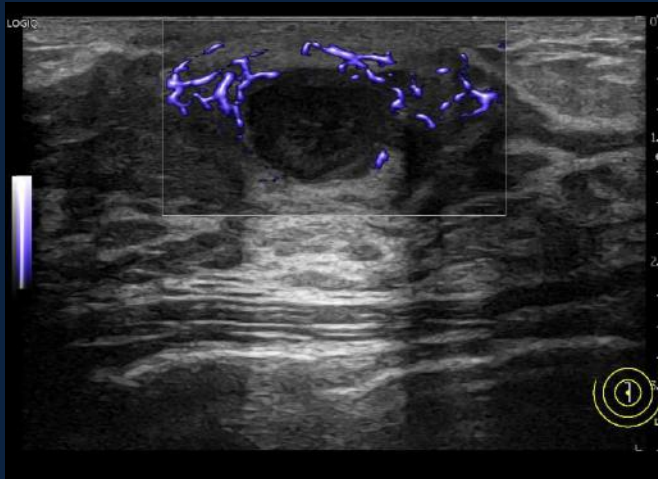

MVI Breast, ML6-15-D

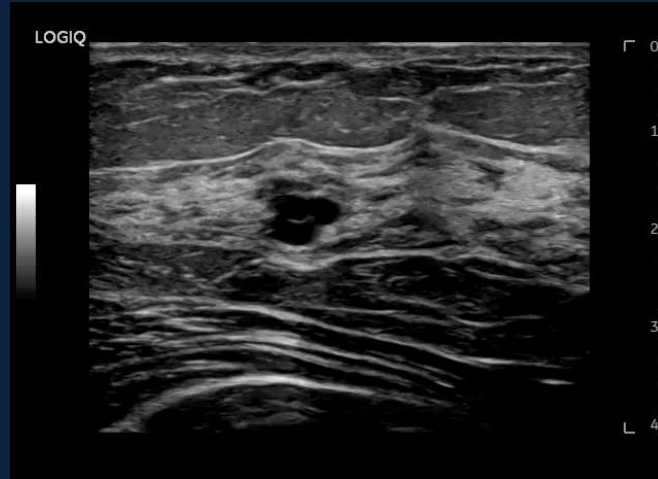

B-Mode with Advanced SRI in Breast, L3-12-D

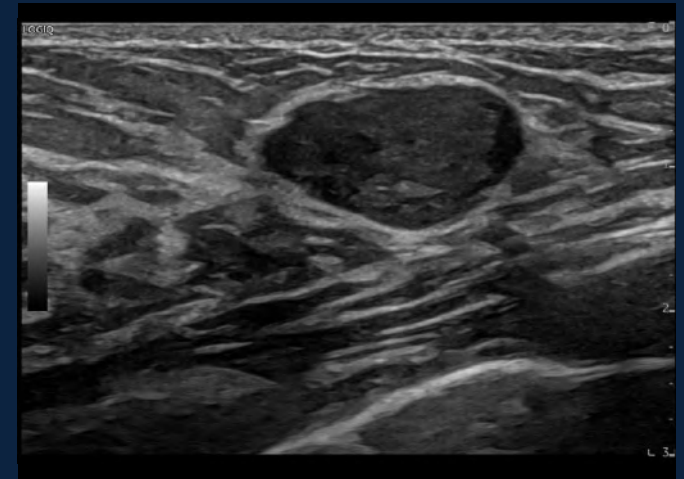

B-Mode with Advanced SRI in Breast, ML6-15-D

OB/GYN

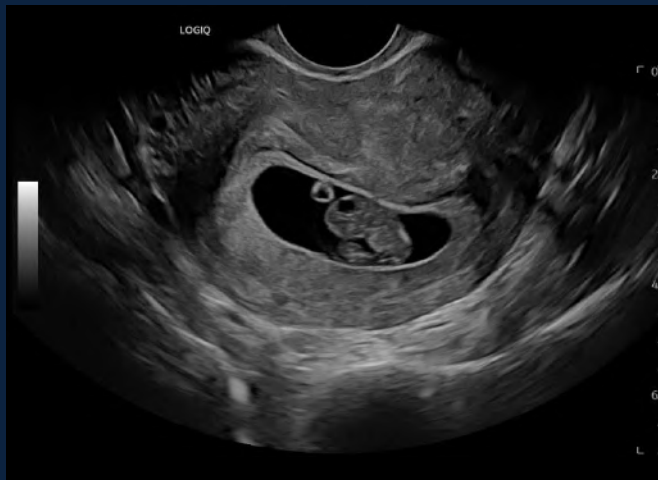

B-Mode with Advanced SRI Early Fetus and Yolk Sac, IC5-9-D



PDI with Radiantflow™ in Umbilical Cord, C1-6-D



PDI of Ovary, IC5-9-D

Cardiac

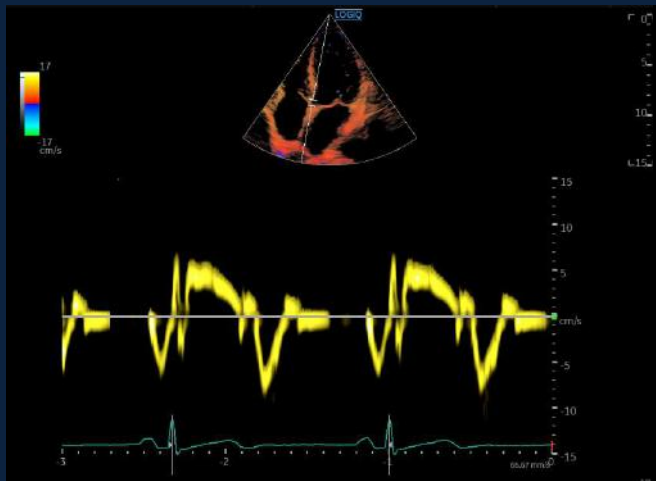

TVI and TVD Apical 4 Chamber View, M5Sc-D

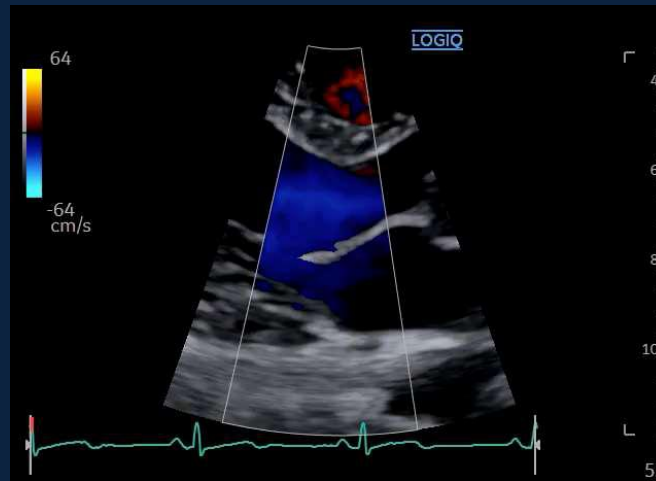

Color Flow in Cardiac Parasternal Long Axis View, M5Sc-D

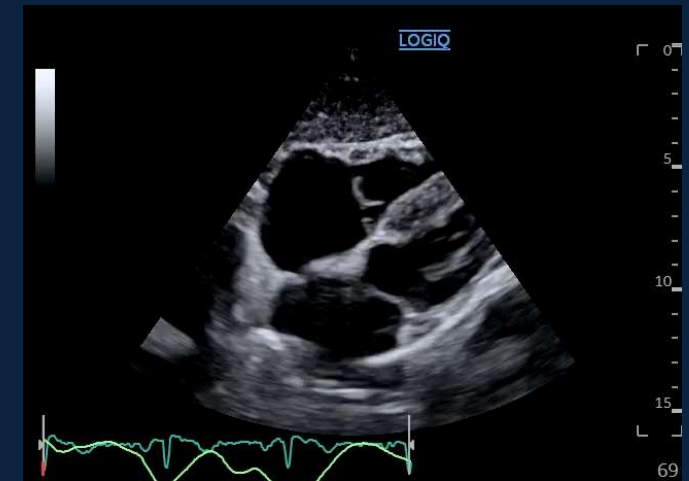

B-Mode with Advanced SRI ECG and Respirometer Display, M5Sc-D

Cardiac



Color Flow Apical 4 Chamber View, M5Sc-D

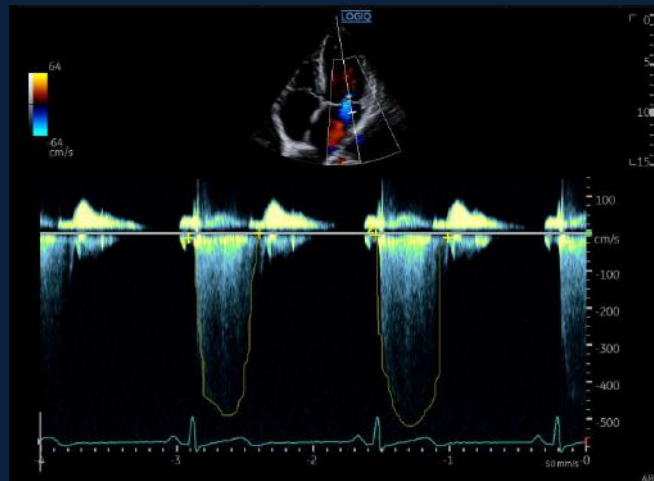

Color Flow and CW Doppler Mitral Valve, M5Sc-D

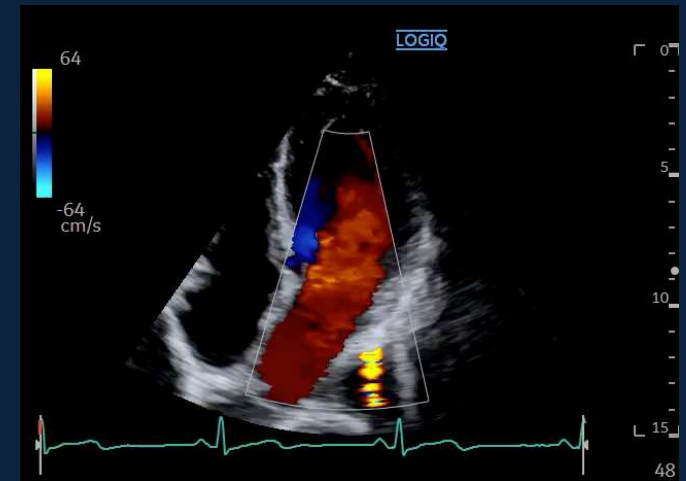

Color Flow Apical 4 Chamber View Mitral Valve, M5Sc-D

Vascular

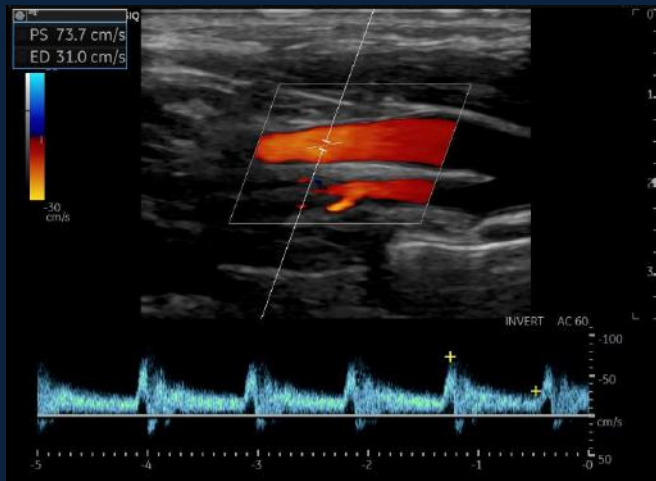

Color Flow and PW Doppler in Internal Carotid Artery, L2-9-D

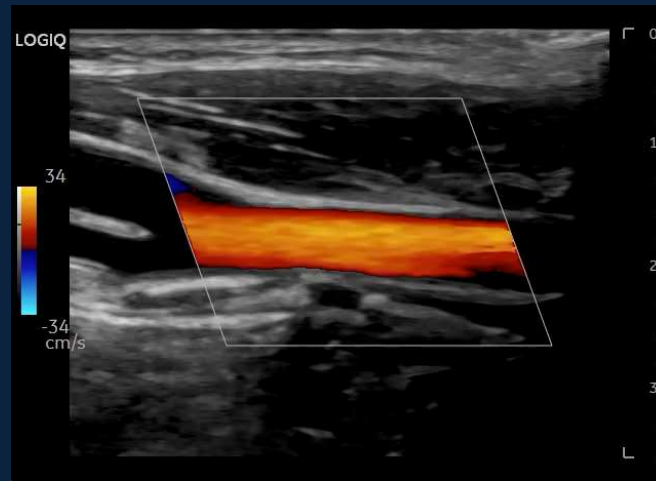

Color Flow Carotid, L2-9-D

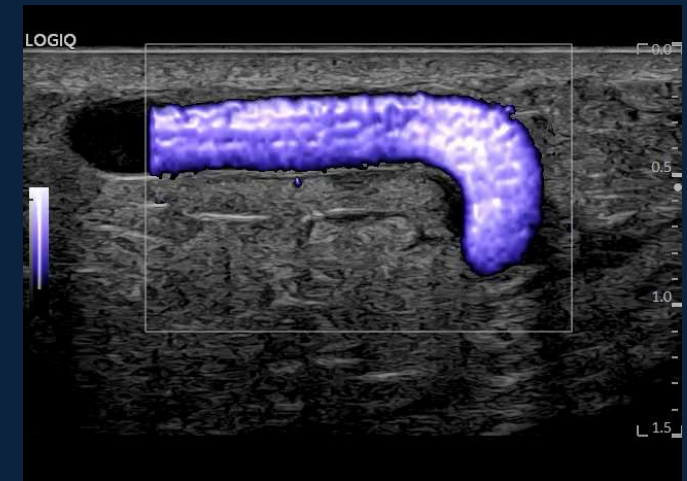

MVI Superficial Vein, L6-24-D

MSK

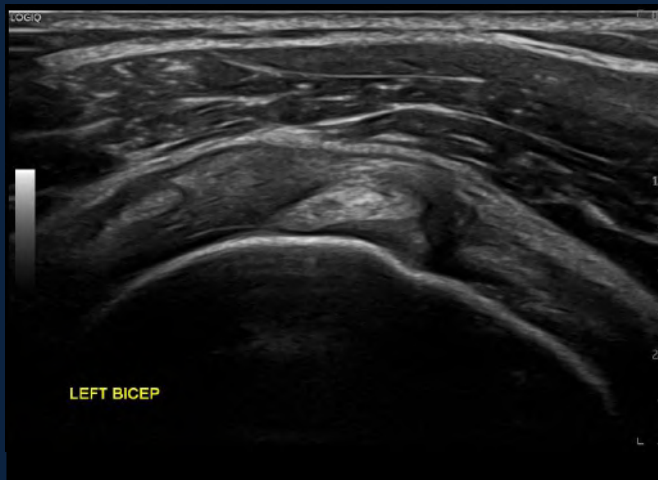

B-Mode with Advanced SRI Shoulder, ML6-15-D

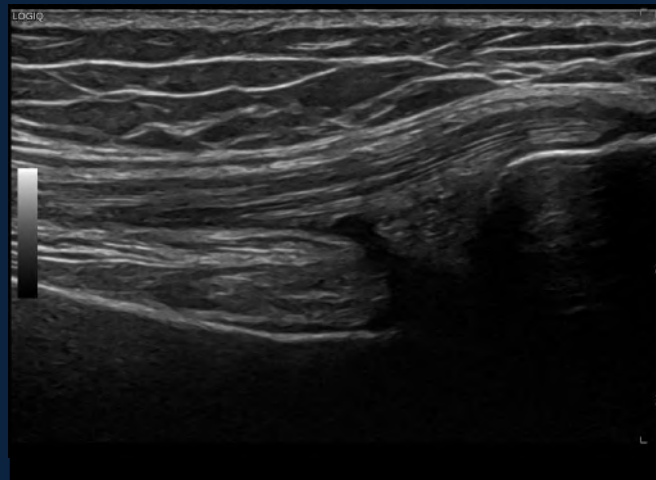

B-Mode with Advanced SRI Knee Tendon, ML6-15-D



MVI with Radiant*flow*[™] Groin Lymph Node, ML6-15-D



— EXCEEDING Your Expectations

Exceeding your expectations



From diagnosing more patients in a day to increased use across clinical care areas, GE Healthcare understands that how you rely on ultrasound is changing. The LOGIQ Fortis™ was created to accommodate your changing needs in multiple clinical settings, going beyond what you've come to expect from an ultrasound system. Designed to be powerful inside and out, it is outfitted with probes for whole-body imaging and equipped with our most advanced clinical tools. LOGIQ Fortis is the streamlined system your hospital needs to advance the ultrasound capabilities now and into the future.



cSound™ Architecture

LOGIQ Fortis™ features cSound Architecture, which combines versatile **XDclear™ probes**, **cSound Imageformer**, and new, advanced **Advanced Raw Data Post Processor technology**. The result is increased processing power that delivers enhanced data throughput for exceptional image quality, clarity and confidence.



ENABLES FOCUS AT EVERY PIXEL, AS WELL AS IMPROVED SPATIAL AND CONTRAST RESOLUTION

cSound™ Architecture

LOGIQ Fortis™ features cSound Architecture, which combines versatile **XDclear™ probes**, **cSound ImageFormer**, and new, advanced **Advanced Raw Data Post Processor technology**. The result is increased processing power that delivers enhanced data throughput for exceptional image quality, clarity and confidence.

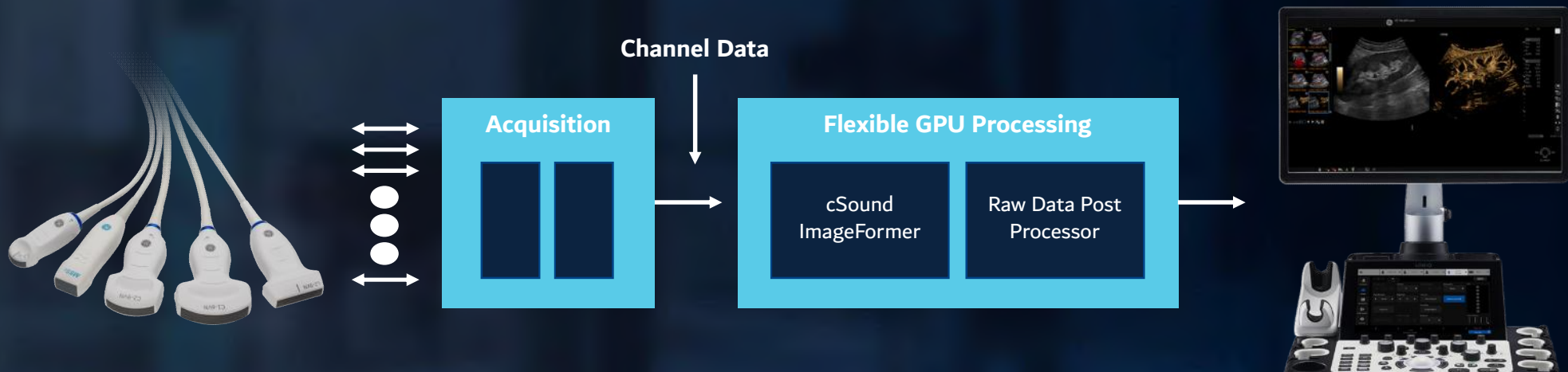

ENABLES FOCUS AT EVERY PIXEL, AS WELL AS IMPROVED SPATIAL AND CONTRAST RESOLUTION

cSound™ Architecture

LOGIQ Fortis™ features cSound Architecture, which combines versatile **XDclear™ probes**, **cSound Imageformer**, and new, advanced **Advanced Raw Data Post Processor technology**. The result is increased processing power that delivers enhanced data throughput for exceptional image quality, clarity and confidence.



ENABLES FOCUS AT EVERY PIXEL, AS WELL AS IMPROVED SPATIAL AND CONTRAST RESOLUTION

Advanced SRI on cSound™ Architecture



Acquire extraordinary images across a broad range of patients, with incredible uniformity from near- to far-field and the penetration power to manage high-BMI patients efficiently.

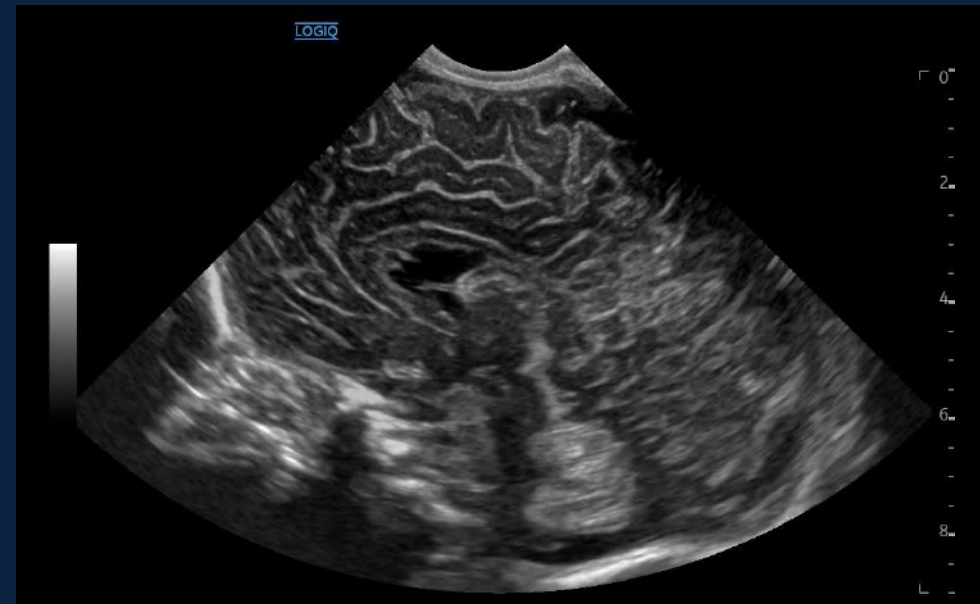

Neonatal Brain with Advanced SRI, C3-10-D

Advanced Raw Data Post Processor



The improved imaging that results from the cSound™ Imageformer flows into the Advanced Raw Data Post Processor where additional image enhancement is performed by functions such as spatial compounding, frame averaging and advanced speckle reduction imaging. The post processed image data is then mapped to gray scale levels and scan converted for display to the operator.

While speckle reduction imaging has been a feature of ultrasound systems for many years, advanced SRI is GE's most sophisticated algorithm to date. It employs proprietary processing steps at multiple resolutions of the raw image data to smooth speckle-based artifacts while simultaneously enhancing structures of all sizes within the image. The level of smoothing and enhancement is adjustable by the user.

The “Raw Data” aspect of the Advanced Raw Data Post Processor comes from that fact that image data is saved prior to the processing steps which means that the processing can continue to be adjusted long after the images have been saved.



Without Advanced SRI



With Advanced SRI

cSound™ Imageformer... How it works

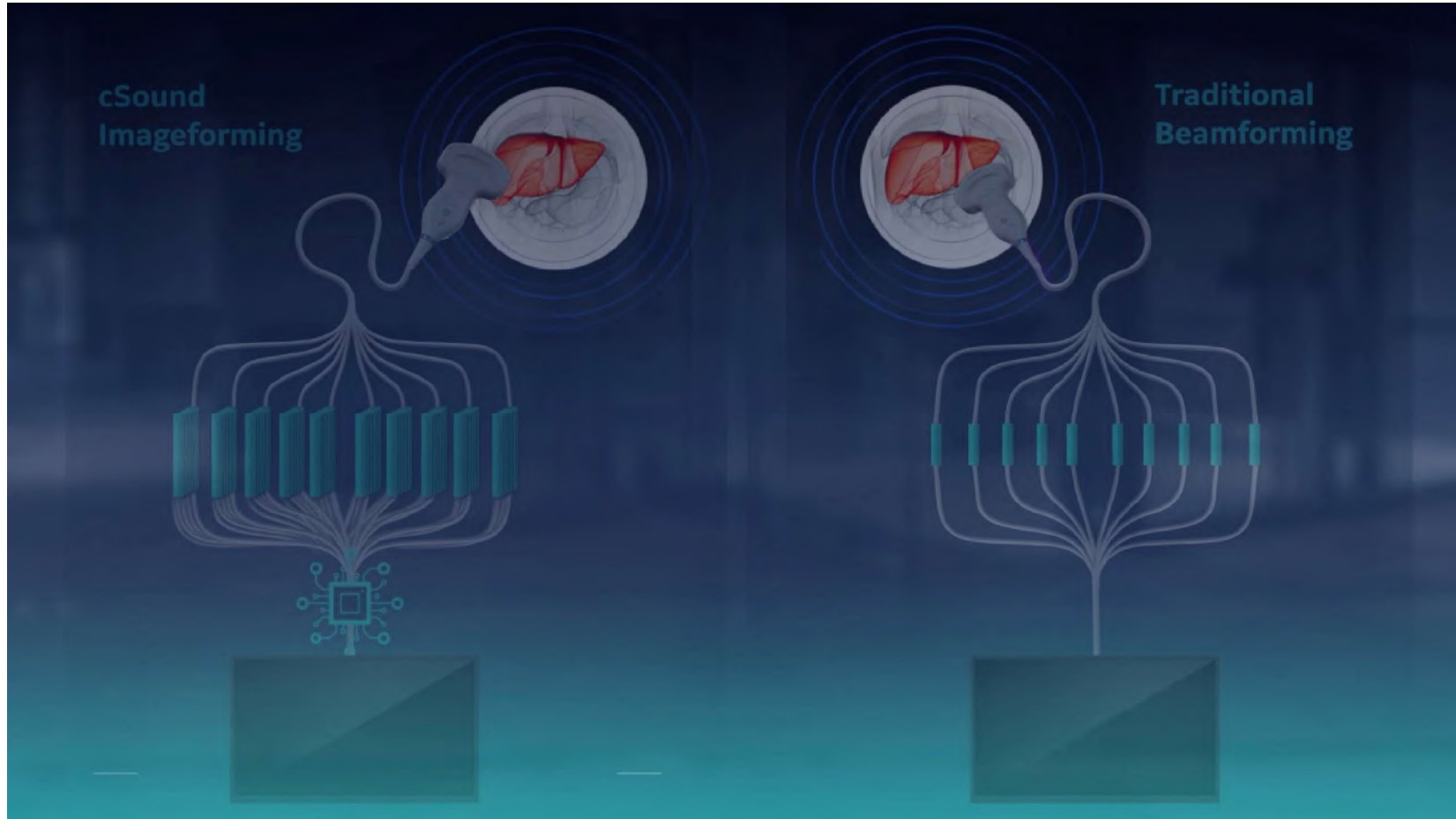

cSound™ Imageformer... Benefits



Traditional Beamformer

Limited by data throughput and processing power

- Reduced spatial and contrast resolution
- Less image uniformity
- Requires multiple focal zones → lower frame rates

cSound Imageformer

Enabled by incredible data throughput **48x** and **10x** processing power

- Better focusing for improved spatial and contrast resolution.
- Increased uniformity throughout image
- Fewer transmits, no focal zones → higher frame rates

cSound™ Imageformer



Clinical benefits

- Improved spatial and contrast resolution
- Every pixel in focus
- Increased uniformity
- Higher frame rates

Technical basis

- More like CT & MR with acquisition and then reconstruction... but in real time
- The cSound Imageformer runs on advanced GPU hardware technology
- Image formation algorithms are software-based, allowing for future flexibility

ENABLED BY **48X** DATA THROUGHPUT AND **10X** PROCESSING POWER

Focusing technology

Traditional beamforming

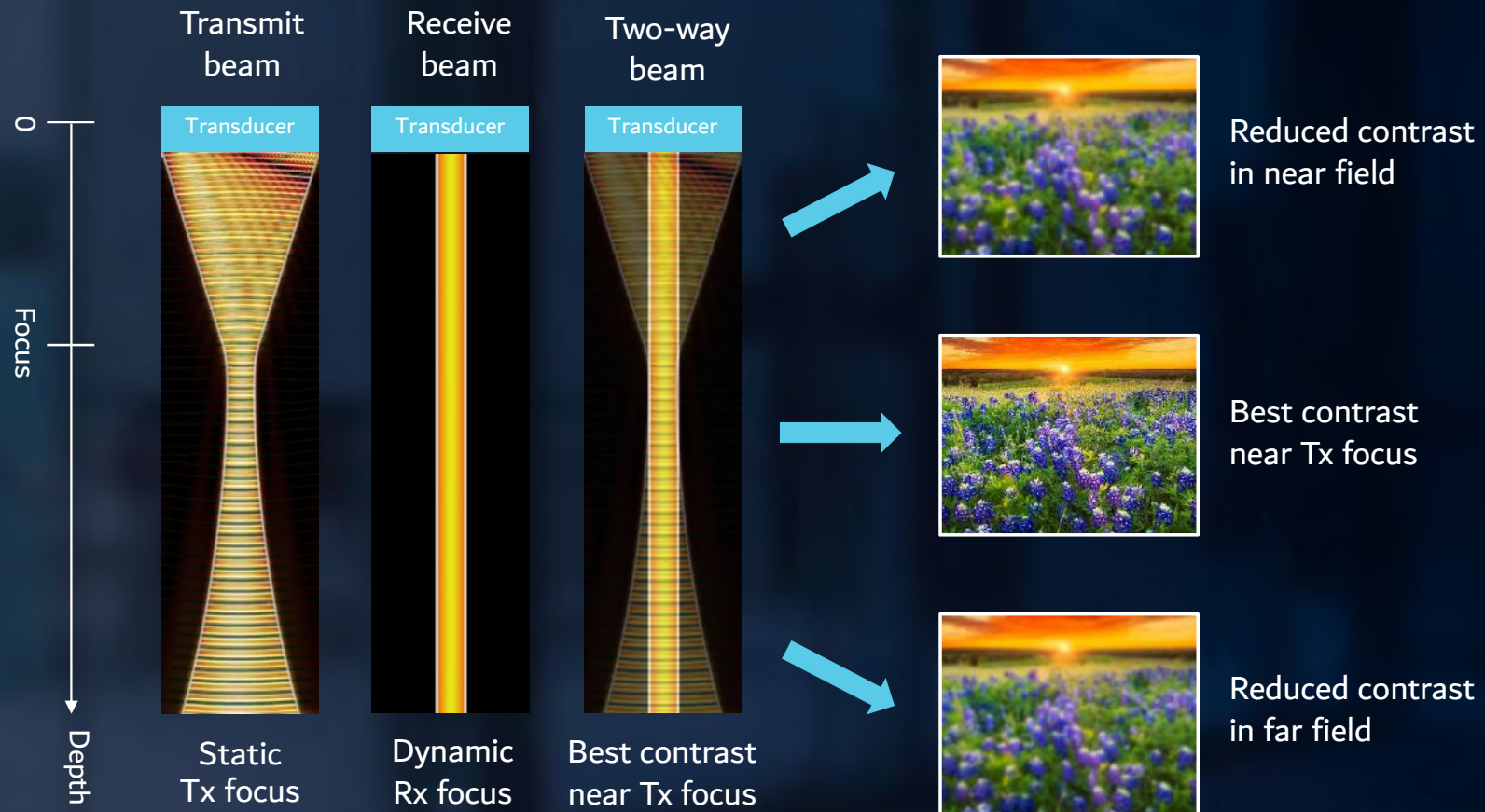

Next gen focusing technology

cSound™ Imageformer

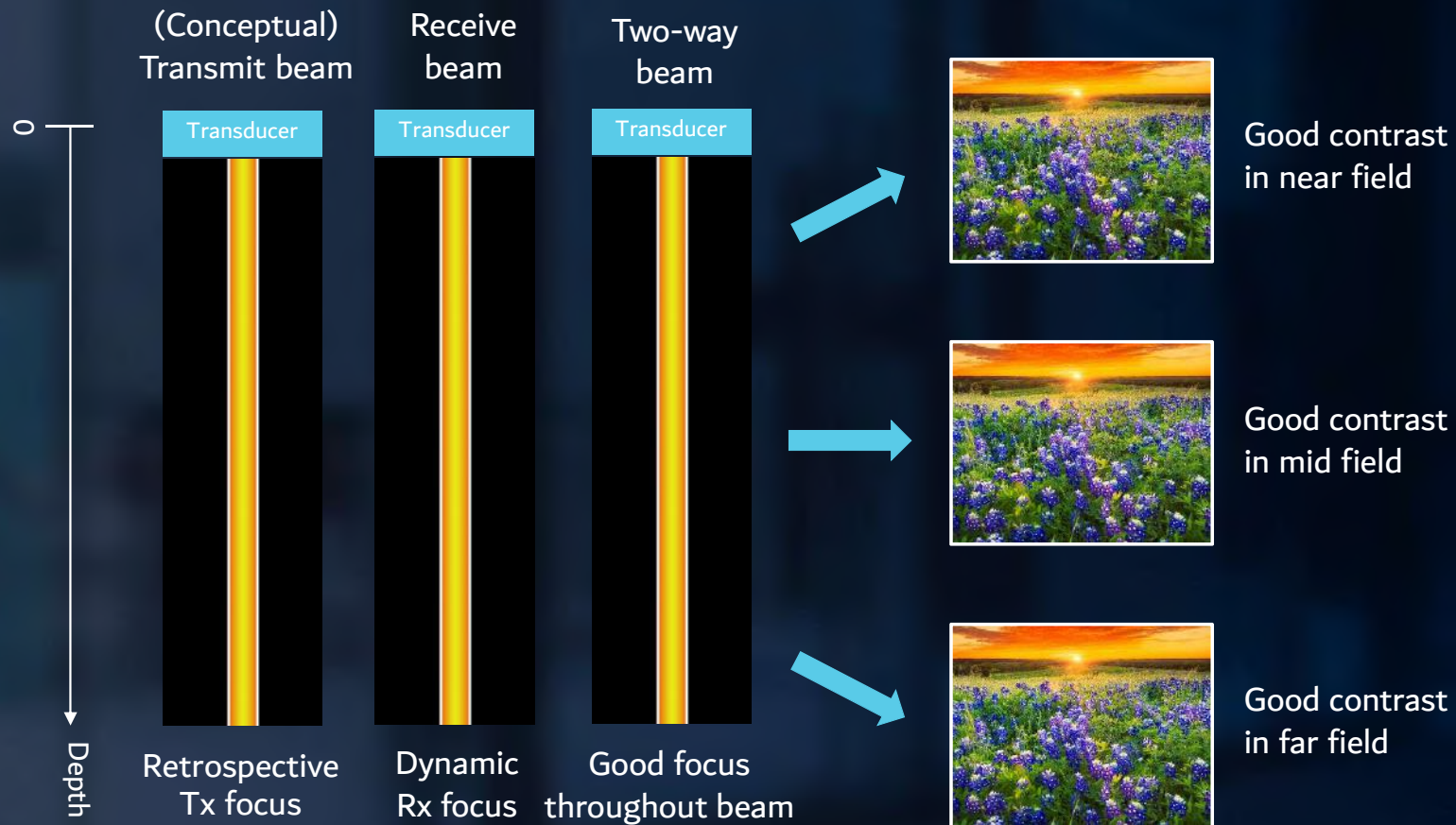

XDclear™

Extended to more probes

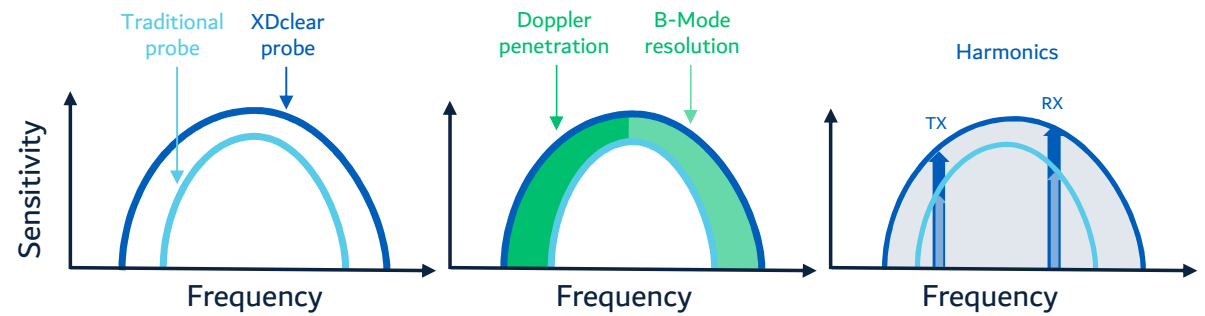
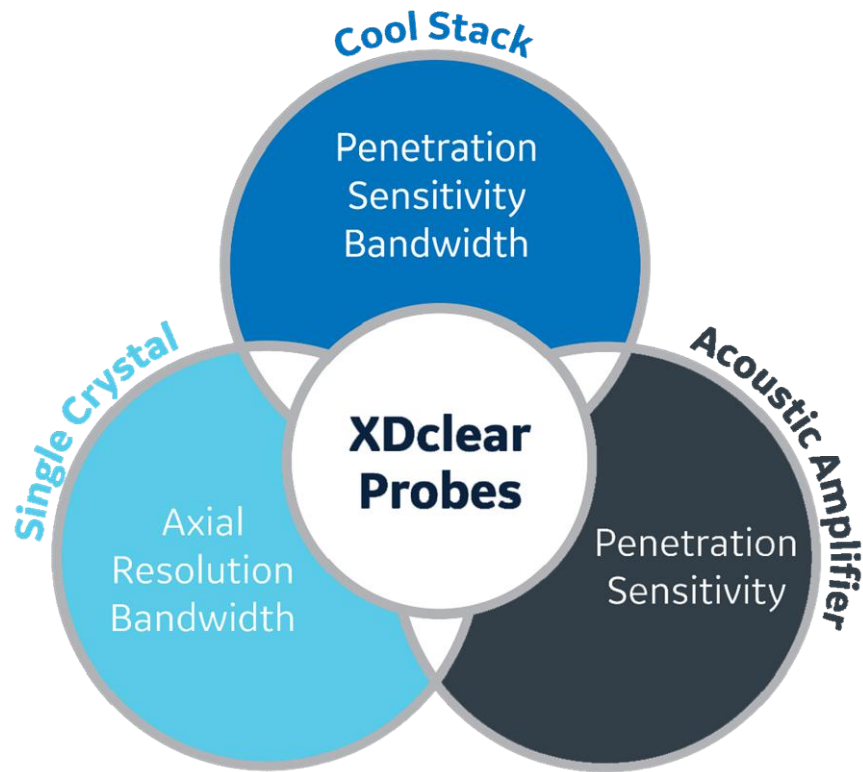

XDclear™ probes

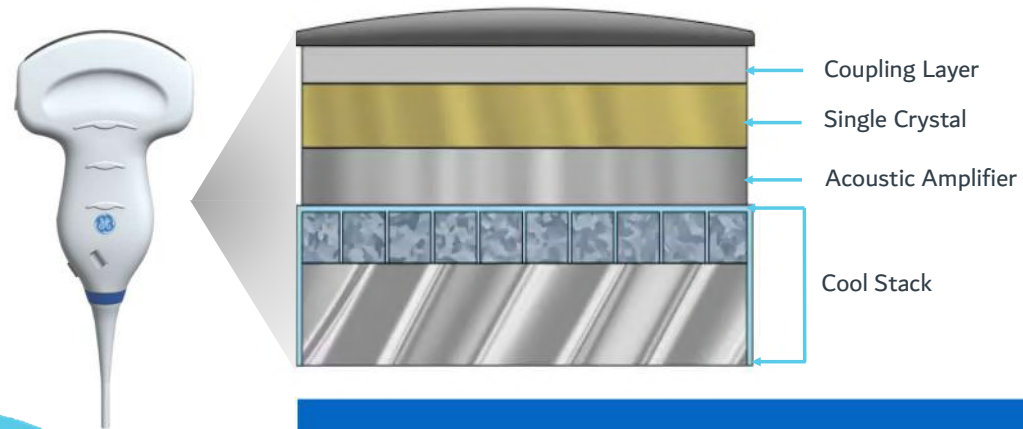

Cool Stack
Penetration,
sensitivity, bandwidth

Single Crystal
Axial Resolution,
bandwidth

Acoustic Amplifier

Single Crystal: Advanced piezoelectric material that delivers high quality acoustic signal

Acoustic Amplifier: Innovative design that captures and redirects the unused energy that passes through the crystal

Cool Stack: Patented technology integrated into the transducer's internal architecture that relieves inherent heat generation that can otherwise reduce sensitivity and penetration

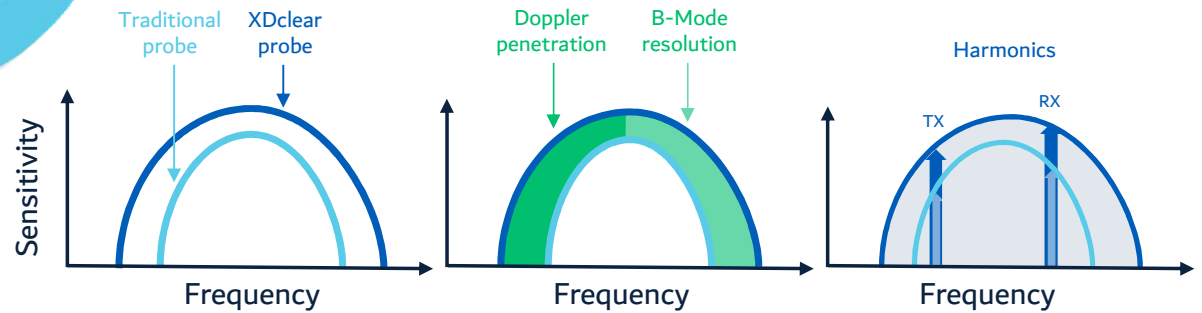

LOGIQ Fortis™ transducers



WIDE RANGE OF TRANSDUCERS TO ACCOMMODATE YOUR VARIED CLINICAL CASELOAD

LOGIQ Fortis™ XDclear™ transducers



GE'S HIGHEST PERFORMING XDCLEAR TECHNOLOGY AVAILABLE ON LOGIQ FORTIS ULTRASOUND SYSTEMS

LOGIQ Fortis™ – Probe line up

Addressing a wide range of patients

- Abdominal
 - C1-6-D, C2-9-D, C2-7-D, M5Sc-D, L2-9-D
- Small Parts
 - ML6-15-D, L2-9-D, L6-24-D, L8-18i-D, L3-12-D
- Vascular
 - L2-9-D, L3-12-D, ML6-15-D, C1-6-D, C3-10-D, M5Sc-D, P6D
- OB/GYN
 - L2-9-D, C1-6-D, C2-9-D, RAB6-D, IC5-9-D, RIC5-9-D
- Pediatric
 - C3-10-D, C2-9-D, ML6-15-D, L2-9-D, L3-12-D, L6-24-D
- Cardiac
 - M5Sc-D, P2D, 6S-D



Volume Navigation & Verza™ 5-Angle Needle Guide

Available on:

- C1-6-D/C1-6VN-D
- L2-9-D/L2-9VN-D



LOGIQ Fortis™ – Probe line up

Confident diagnosis



XDclear™

- L2-9-D/L2-9VN-D
- M5Sc-D
- C1-6-D/C1-6VN-D
- C2-9-D/C2-9VN-D
- C3-10-D

Convex

- C1-6-D/C1-6VN-D
- C2-9-D/C2-9VN-D
- C3-10-D
- IC5-9-D
- C2-7-D/C2-7VN-D

Linear

- ML6-15-D
- L2-9-D/L2-9VN-D
- L3-12-D
- L8-18i-D
- L6-24-D

Sector

- M5Sc-D
- 6S-D

Real-time 4D

- RAB6-D
- RIC5-9-D

Specialty

- P2D
- P6D

Select probes with Embedded Volume Navigation Sensors

E-series probes

Acoustic Amplifier



Traditional technology

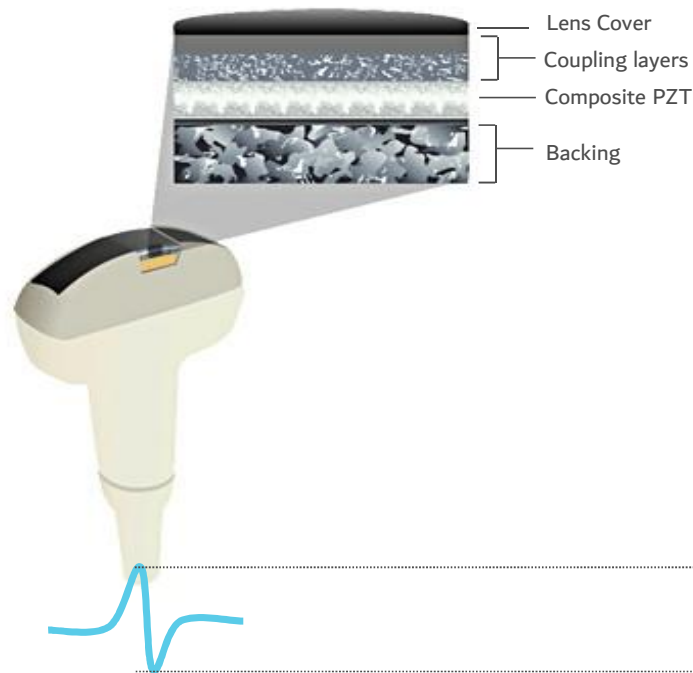

Acoustic Amplifier technology

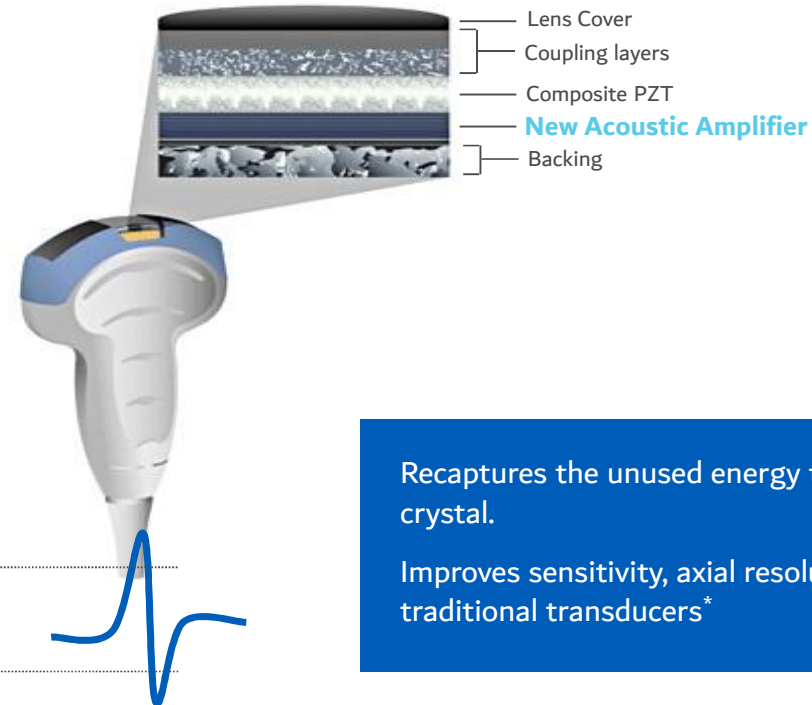

Recaptures the unused energy that passes through the crystal.

Improves sensitivity, axial resolution & penetration over traditional transducers*

E-series probes

Single Crystal



Traditional PZT technology

The variations of polarization in PZT affect its piezoelectric properties and signal to noise ratio

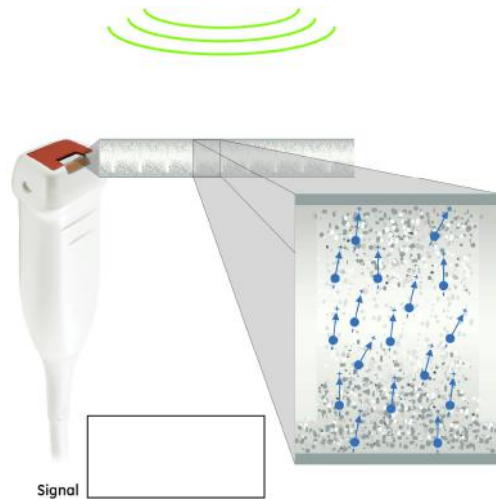

The electric dipoles of PZT are randomly oriented introducing signal noise

Increased bandwidth
Better signal to noise ratio
Improved axial resolution and penetration

Single Crystal technology

Single crystal material exhibits fewer poling variations

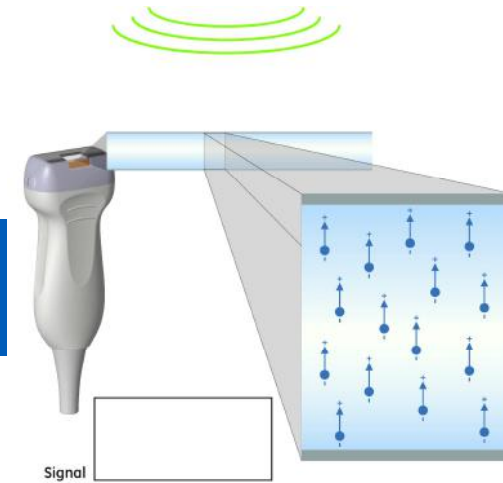

Single Crystal exhibits improved dipole alignment

XDclear™ probes



GE Healthcare's highest performing transducers featuring new advances in Acoustic Engineering

Synergetic combination of innovative technologies

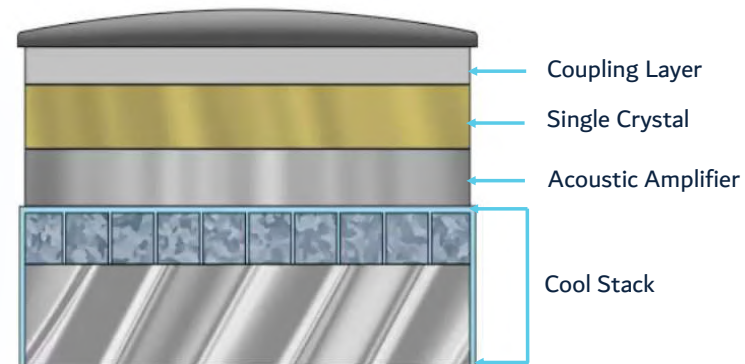

Single Crystal: Advanced piezoelectric material that delivers high quality acoustic signal

Acoustic Amplifier: Innovative design that captures and redirects the unused energy that passes through the crystal

Cool Stack: Patented technology integrated into the transducer's internal architecture that relieves inherent heat generation that can otherwise reduce sensitivity and penetration

XDclear™ probes



XDclear helps increase penetration and simultaneously delivers high-definition resolution throughout the image.

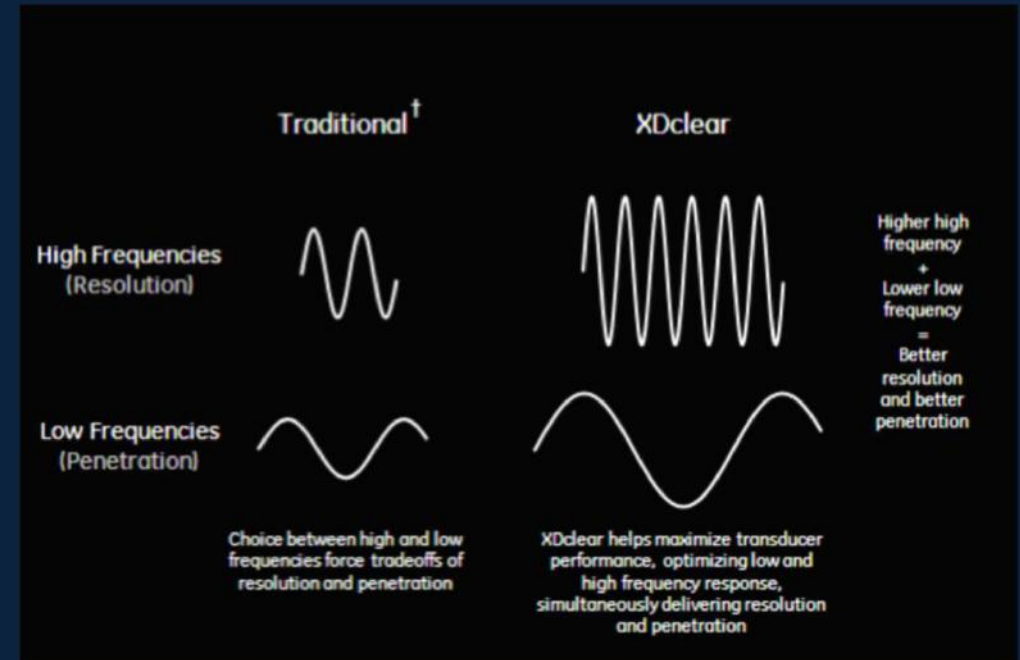

Extreme definition at extended depth

Radiant $flow$ TM



Supports detailed vascular imaging

- Optimized for small vessel imaging
- Provides a near-3D look
- Excellent when combined with Micro Vascular Imaging (MVI)

Available on most probes



Color Flow with Radiant $flow$ Fetal Heart, C1-6-D



Color Flow with Radiant $flow$ Kidney, C2-9-D

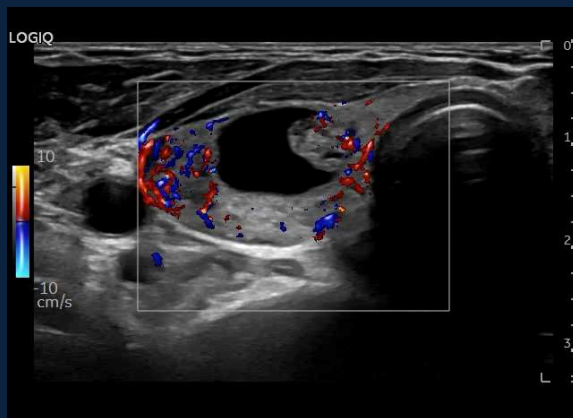

Radiant $flow$ Color Flow in Thyroid, ML6-15-D

Micro Vascular Imaging



High-definition flow

- Help assess blood flow with ease in the joints, lymph nodes, and other small structures
- Further enhanced when used with Radiant*flow*[™]

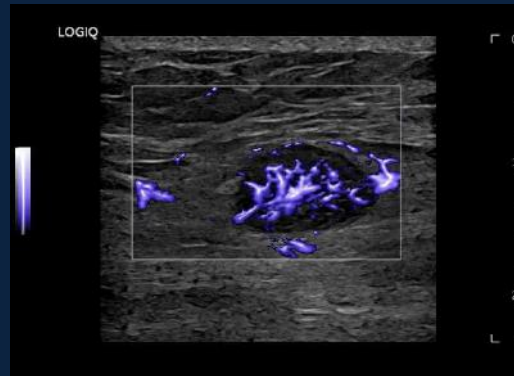

MVI with Radiant*flow* in Lymph Node, L8-18i-D

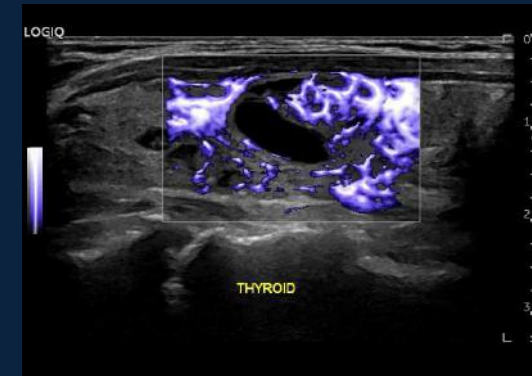

MVI with Radiant*flow* in Thyroid, ML6-15-D

Available on:

- C1-6-D
- L2-9-D
- L3-12-D
- L6-24-D
- L8-18i-D
- ML6-15-D



MVI with Radiant*flow* Neonatal Brain, L6-24-D

LOGIQ Fortis™ – Microvascular Imaging Technology



Fundamentals of MVI

- Continuous scan sequence
- Achieve high framerate
- Detect slow flow vessels

Advantages of GE Coded Excitation

- Fine lateral and axial resolution
- Reduce over bleeding
- Increases SNR



Transmit & Receive

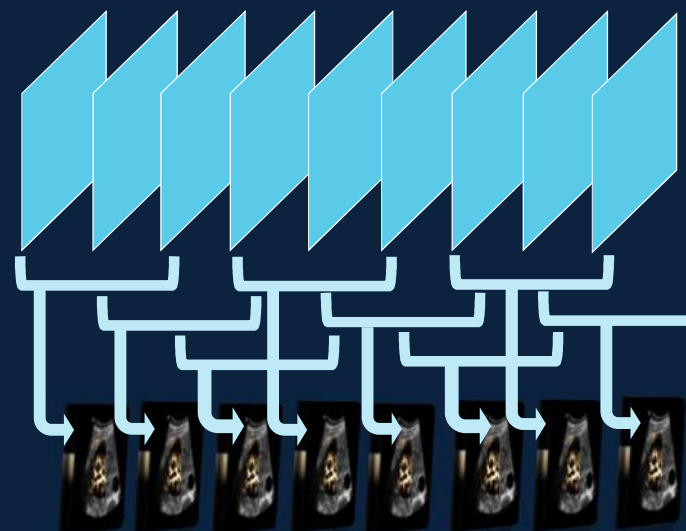

LOGIQ Fortis™ – MVI imaging, new clutter filtering



New clutter filter

- Separate slow flow from the clutter and provide new clinical opportunities
- Superb continuity and vessel presentation

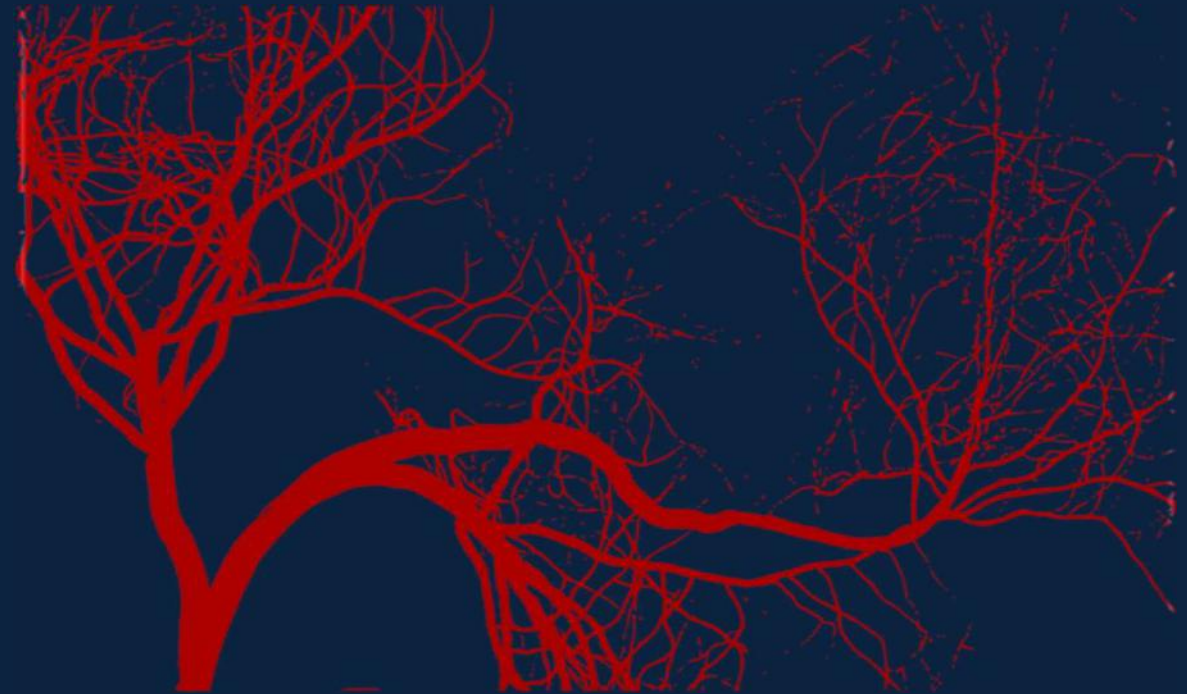
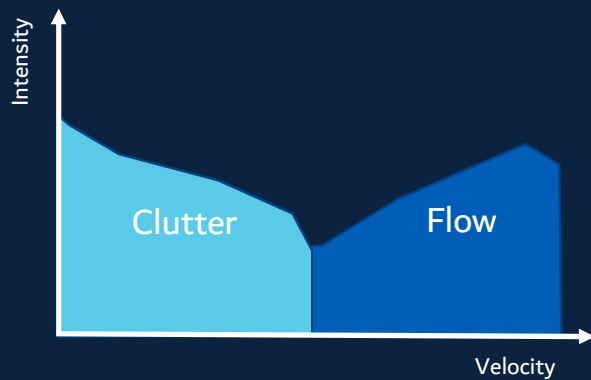

LOGIQ Fortis™ – Microvascular imaging



MVI with RadiantFlow™ in Thyroid, ML6-15-D

Remarkable sensitivity with high resolution

Detects slow flow and small vessels with new clutter filtering

High frame rate

Show hemodynamics

Supported probes

C1-6-D, L2-9-D, L3-12-D, L6-24-D, L8-18i-D, ML6-15-D

LOGIQ Fortis™ – Microvascular imaging

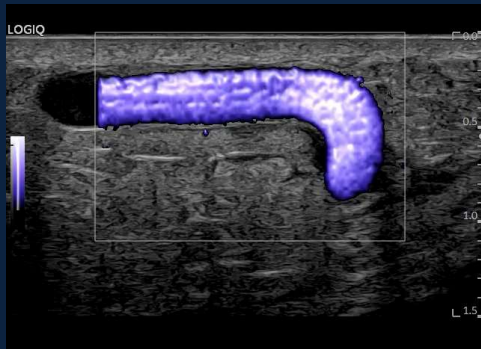

- Finger or wrist to assess inflammation
- Improve visualization of a foreign body



- Renal (transplants, etc.) to assess perfusion in areas of ischemia
- Superficial liver lesions for flow patterns

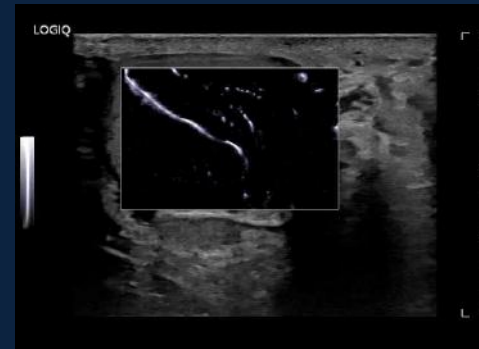

- Pediatric scrotal imaging to assess inflammation or torsion
- Lymph node to note inflammation or suspicious breast CA

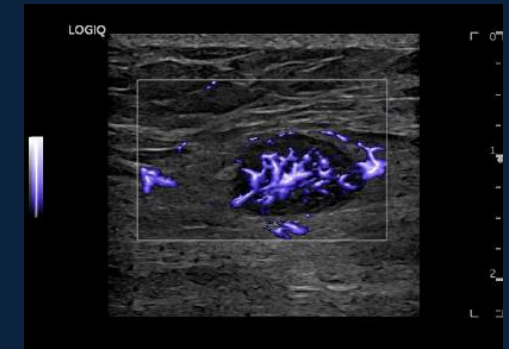

- Pediatric imaging to evaluate lumps/bumps
- Neonatal head perfusion

LOGIQ Fortis™ – Coded contrast imaging



Applications

- Abdominal – Liver, Kidney, Pancreas, Aorta
- Superficial – Lymph Nodes, Thyroid, Breast
- Endocavitary – Prostate, GYN
- Cardiac

Probes

- C1-6/VN-D
- C2-9/VN-D
- C2-7/VN-D
- C3-10-D
- L2-9/VN-D
- ML6-15-D
- L3-12-D
- M5Sc-D
- RAB6-D
- RIC5-9-D
- IC5-9D
- BE9Cs-D

Features

- Static & quick 3D imaging
- Multiple displays: DualView, Single and Hybrid
- Accumulation: Adds/accumulates image frame by frame
- Time intensity curves: Up to 8 regions of interest
- Parametric imaging
- Contrast Clock: 2 timers
- Max Enhance & Flash: Quick 100% acoustic output
- Intermittent Imaging: From .05 to 10 second delay



The LOGIQ Fortis is designed for compatibility with most commercially available ultrasound contrast agents. Availability of these agents is subject to government regulation and approval. Contrast imaging should be performed within the approved indications for use of the contrast agent used in the exam.

Contrast ultrasound

Amplitude Modulation and HRes



Amplitude Modulation (AM)

- Great penetration
- High image uniformity
- Superb contrast sensitivity
- Excellent tissue suppression

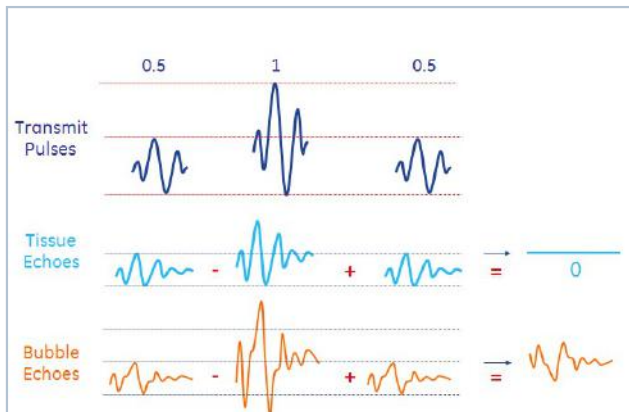

Phase Inversion (HRes)

- Great spatial resolution
- Outstanding contrast level differentiation
- High temporal resolution

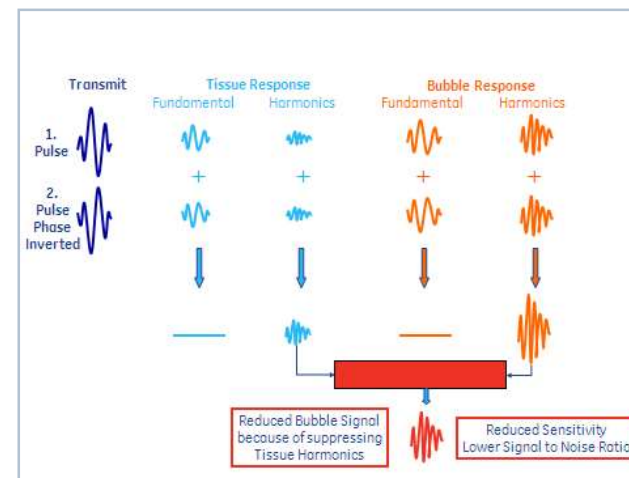

Contrast ultrasound

High fidelity imaging



Amplitude Modulation (AM)



Superb contrast sensitivity
Excellent tissue suppression
Good penetration depth



Lower spatial resolution
Lower temporal resolution

Phase Inversion (HRes)



Great spatial resolution
Contrast level differentiation
Higher temporal resolution
No blooming artifacts



Tissue background noise

Contrast ultrasound



Time Intensity Curve (TIC)

- Raw data processing for Contrast uptake
- Time Intensity Analysis of both compressed and uncompressed data
- Up to 8 selectable ROIs, Up to 10 parameters
- Ellipsoid or manual ROI tracing
- Motion correction feature
- Ability to export traces for offline analysis

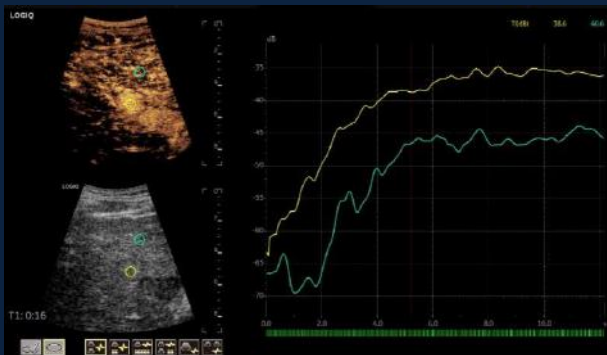

Liver Mass CEUS TIC Analysis, C1-6VN-D

Parametric analysis

- Arrival time analysis of contrast-enhanced raw data cine clips
- **User configurable settings:**
 - Color bar
 - Transparency
 - Gradation
 - Capture
 - Threshold
 - Motion correction

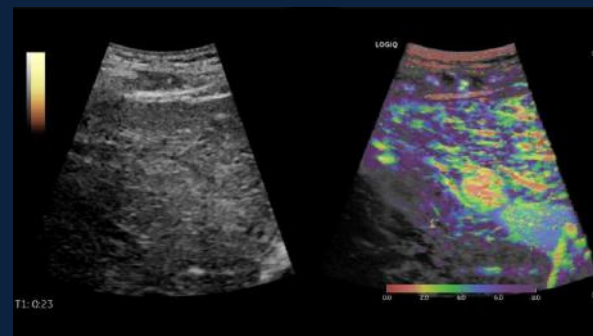

Parametric Analysis – FNH, C1-6VN-D

CEUS – AM mode

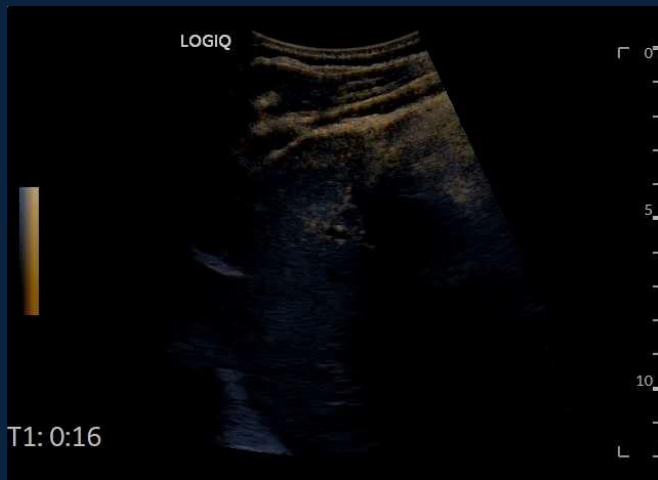

Contrast Enhanced Hybrid View of Liver Lesion, C1-6-D



Contrast Enhanced Liver Lesion, C2-9-D



Contrast Enhanced Liver Lesion, C1-6-D

Contrast MVI



Features

- High sensitivity and spatial resolution
- Assess perfusion through a lesion or organ

Contrast tools available

- Flash
- Flash + Capture
- Max Enhance
- Contrast Clock

Probes

- C1-6-D
- C1-6VN-D
- L2-9-D
- L2-9VN-D
- L3-12-D
- ML6-15-D

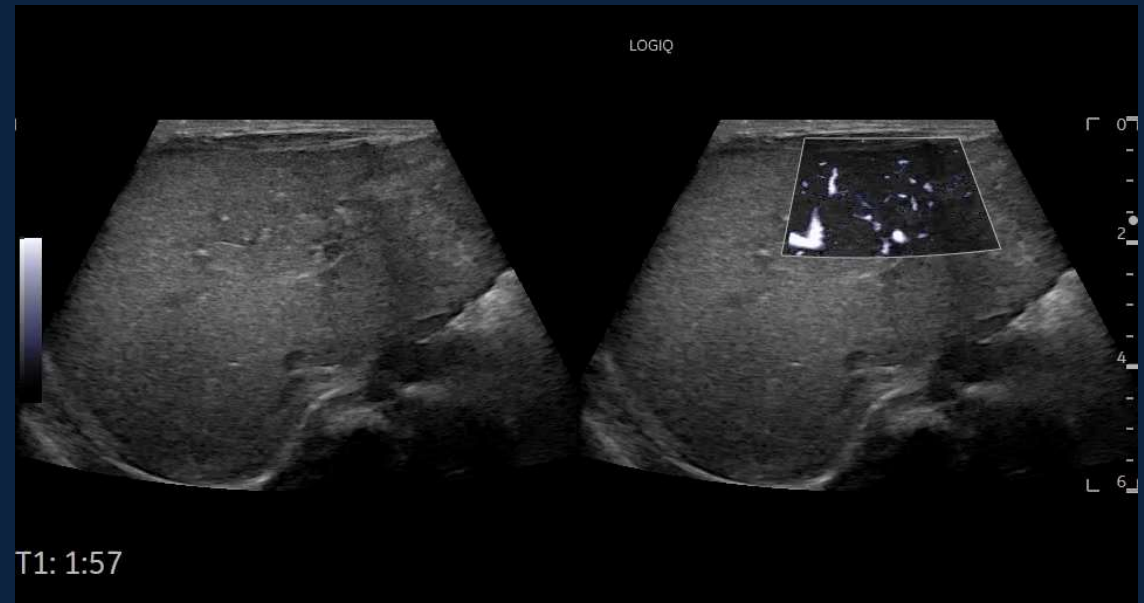

Contrast MVI Liver, L2-9-D

Volume Navigation

Highlights



Features:

- **C1-6VN-D, C2-9VN-D, L2-9VN-D, C2-7VN-D** with embedded Volume Navigation sensor for enhanced scanning comfort
- **'Dual sensor brackets'** for C3-10-D, L8-18i-D, ML6-15-D and IC5-9-D probes
- **Active Tracker** for Quick US/CT, CBCT & MR Auto-Registration and breath compensation
- **Needle Tip and Virtual Tracker** for interventional procedures planning and tracking
- **Enhanced GPS markers** management with extended flexibility



Volume Navigation

Fusion imaging



Embedded sensor
positioning system

Real ultrasound



CT, MR, PET, CBCT,
US volume data
set



Volume Navigation

Fusion imaging

Match real time ultrasound with a volume DICOM® dataset, Can be any modality as CT, MR, PET/CT, CBCT, and 3D CEUS

Benefit from:

- Real Time versus still image
- Add Flow or CEUS Information
- Combining U/S high spatial resolution & MR contrast resolution
- Guiding interventions in real time ... biopsies, drainages, RF ablation
- Avoiding multiple exposure to radiation in interventions and follow up exams

Different visualization

- Side by side
- Side by side w/different scale factors
- Overlay

Side-by-side



Side-by-side
different scale



Overlay



Volume Navigation

Highlights



Advantages

- Advantages of Real Time Imaging associated with high spatial/contrast of CT/MRI
- Help increase precision and accuracy of imaging-guided interventional procedures
- Help with the ablation of liver lesions potentially reducing the duration and number of needed sessions

Potential clinical indications

- Lesions poorly visualized with US
- Lesions difficult to detect with US (small, hidden by lung air)
- Large lesions, partially visible with US an partially “obscured” by anatomical situations
- Adequate visible lesions with US, but coexisting with difficult targets



Volume Navigation

Auto-registration with CT, CBCT & MR

Beside manual registration by plane and/or point, LOGIQ Fortis™ introduces an innovative sensor-based Auto-Registration technique between Live US and a CT/CBCT/MR dataset.

An Active Tracker device (omniTRAX™) is placed on patient during a CT/CBCT/MR scan and then detected in the retrieved CT/CBCT/MR images to facilitate an auto registration during Fusion imaging Mode.

The Active Tracker can be removed from its bracket during intervention while not selected as Reference Sensor.

Highlights

- Fast
- Easy
- Automatic
- Accurate



CT Tracker



MR Tracker

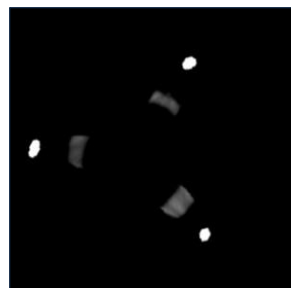

CT of device



INTERACT with LOGIQ™ CT Active Tracker



INTERACT Active Tracker enables automatic image registration between U/S and 3D CBCT volumes even when the tracker is located peripherally to the 3D volume.

Main benefits:

- Tracker can be electromagnetically detected even when located peripherally far outside the CBCT volume, allowing more flexible imaging patient coverage
- Simple fusion process: Transparent and automatic detection of the tracker in CBCT volumes, network transfer to LOGIQ Fortis™, automated volume handling and co-registration

Main outcomes:

- Improve lab productivity, reducing time spent on anatomical centering
- Leverage CBCT as a bridge to register U/S with any pre-op image, even if acquired without tracker, using multi-modality fusion on AW
- Improve lesion visualization and needle guidance using a large variety of images
- Leverage radiation-free modalities
- Free-up CT scan time,¹ avoid patient transfer and increase staff and equipment efficiency



INTERACT Active Tracker is an optional feature of 3DXR (part of GE vascular systems IGS 5/6/7/TOR). 3DXR cannot be placed on the market or put into service until it has been made to comply with all required regulatory authorizations including the Medical Device Directive requirements.

1. Results may vary depending on the institution, the patient characteristics, and the experience of the operator.

Volume Navigation

Auto-registration with CT, CBCT & MR



The same **Active Tracker** is usually selected as **Reference Sensor**, meaning that tracking is done relative to the sensor attached to the Active Tracker instead of the current transmitter, with the following advantages:

- Perform some breath compensation
- Allow registration and GPS markers to be maintained if the transmitter, or the patient to some extent, moves



Volume Navigation

GPS



Examples of potential applications

- Visually track position to save time and help improve confidence
- Find an anatomical structure from a different view
- Mark and track selected points in the body while scanning
- Simplify counting structures such as masses, lesions, nodules
- Help improve confidence that count was not duplicated. Good for treatment planning and follow up
- Guide procedures through needle tracking finding and drawing the most suitable angle
- Help avoid anatomical structures (e.g. nerves, vessels) during interventions

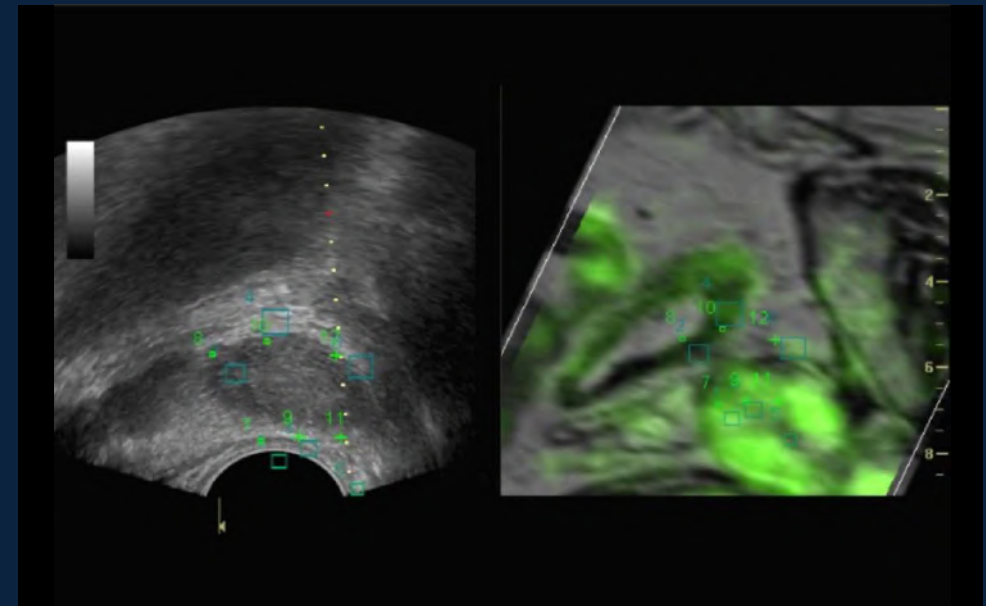

VNav Prostate Biopsy Fused with MRI, IC5-9-D

Volume Navigation

3D GPS



Examples of potential applications

- Spherical markers for tracking anatomy, including margins
- Ellipsoidal markers for tracking planned ablation zones, including needle path
- Designed for real-time interventions
- Can be combined with needle tracking



VNav Liver Mass RF Ablation 3D GPS Marker Fused with CT, C1-6VN-D

Volume Navigation

Needle Tip Tracker



Description

- Magnetic sensor embedded in the tip of a needle
- Reusable sensor helps you track the needle tip as you navigate through the body
- View a live display of position and orientation
- Guide in-plane or out-of-plane biopsies
- Plan and monitor interventional procedures with real-time fused data
- While selected as Reference Sensor, the needle tip sensor helps compensate for respiration and organ related motion

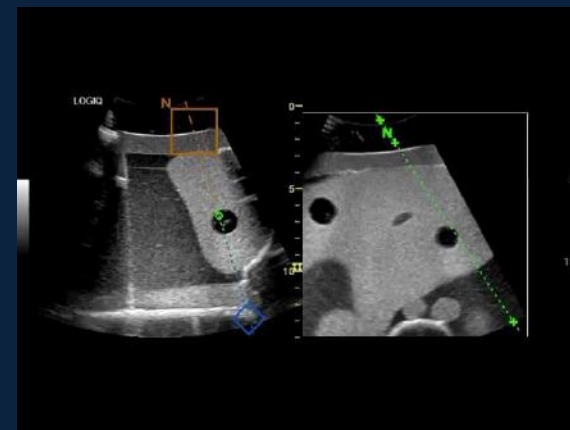

LOGIQ Fortis™ and Verza™ Needle Guide



Includes five angles for visualization

Available on:

- C1-6-D/C1-6VN-D
- L2-9-D/L2-9VN-D



Volume Navigation

Needle Tip Tracker components



CIVCO's eTRAX™ Reusable Sensor

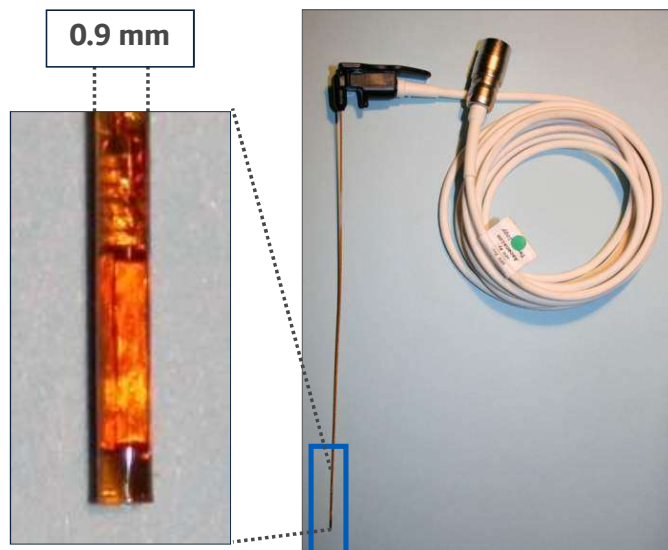

Not sterile, Reusable
(Cover not shown)



Volume Navigation

Needle Tip Tracker range



Needles can be:

- 14 G with a 12 G introducer
- 16 G with a 14 G introducer
- 18 G with a 16 G introducer
- 20 G with an 18 G introducer
- Availability of a wide range of needle lengths (17, 15, 13, 10, 8 & 6 cm), depending on the needle thickness, to cover more applications



Volume Navigation

Virtual Tracker



Virtual Tracker enables the user to track an interventional needle during a procedure thanks to a sensor placed at the hub of the needle rather than in the tip.

The projected line is a virtual line and would not display the potential bending of the needle during the procedure (depending on needle thickness, length and examined anatomical area. Refer to manufacturer for recommendations).

On screen graphics are the same as Needle Tip Tracker except:

N = Needle Tip Tracker

V = Virtual Tip Tracker

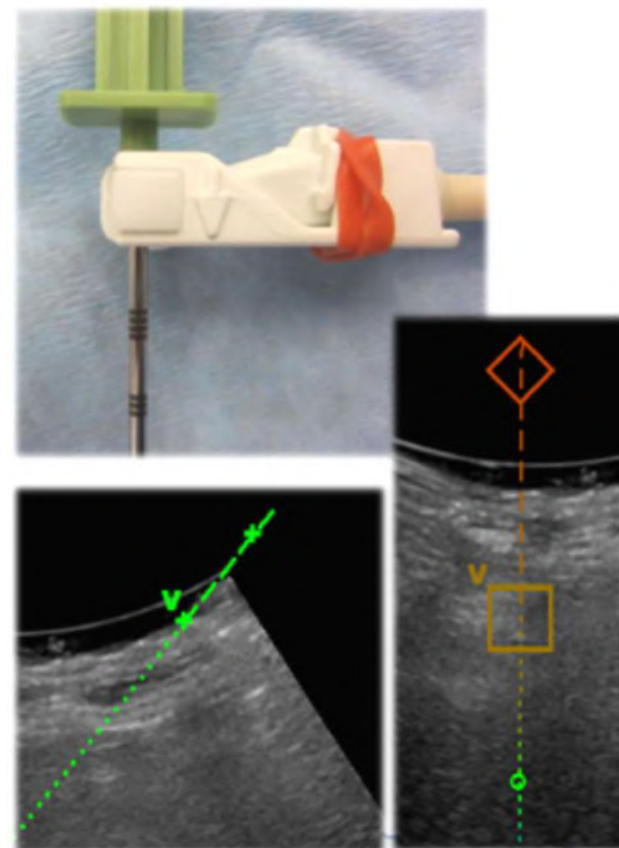

Volume Navigation

Tracking solutions



Needle tracking



Real Needle Tracking

May help reduce risk of cancer cells seeding

First Paper by De Baère (2011)



No insulated sheath yet

Applications:

- Difficult biopsy guidance
- Drainages
- No RFA guidance yet

Virtual Tracker



Coaxial needle not required

Track most of the ablative procedure

User standard needles (≤ 14 G)



Inaccuracy for potential bending

Limited to ≤ 14 G needles

Applications:

- Live guidance of RFA/Microwave ablations
- Biopsy with thicker needles (ex. breast)
- Treatment planning

Volume Navigation

Highlights



Features:

- Easy to use & accurate tool
- Quick plane and point manual registration with internal or external anatomical markers for all modalities
- Quick and accurate fusion with Auto-Registration with CT while using the Active Tracker
- Innovative magnetic distortion indicator based on GE dual sensors position check (in case of a standard V Nav transducer)
- Save Patient Volume Registration file
- Multiple volume support (CT, PET/CT, MRI, CBCT, SPECT and 3D CEUS)
- **Volume Registration** to fuse two volume datasets from different exams and compare to live US
- **Active reference sensor** option, by selecting the reference sensor, allows patient movement and/or provide breathing compensation



Volume Navigation

Volume Navigation inside transducers



Probes with embedded Volume Navigation

sensor: C1-6VN-D, C2-9VN-D, C2-7VN-D, L2-9VN-D

- Sensor integrated in the transducer, no need of external brackets
- No sensor cables for an improved scanning comfort
- Environmental quality indicator
- Transducer's size, footprint and cable identical to standard Volume Navigation transducers
- Comparable image quality and sensitivity to standard V Nav transducers
- Touchscreen's graphical dot indicates that a V Nav Inside transducer is connected and its state (active or not)

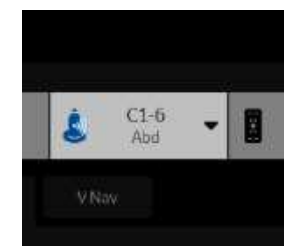

Volume Navigation

Transducers and applications



Brackets are available for the following applications:

- Musculoskeletal and small parts
–L8-18i-D, ML6-15-D
- Endocavitary imaging
–IC5-9-D
- Pediatric imaging
–C3-10-D, L8-18i-D, ML6-15-D



Volume Navigation (V Nav) image gallery

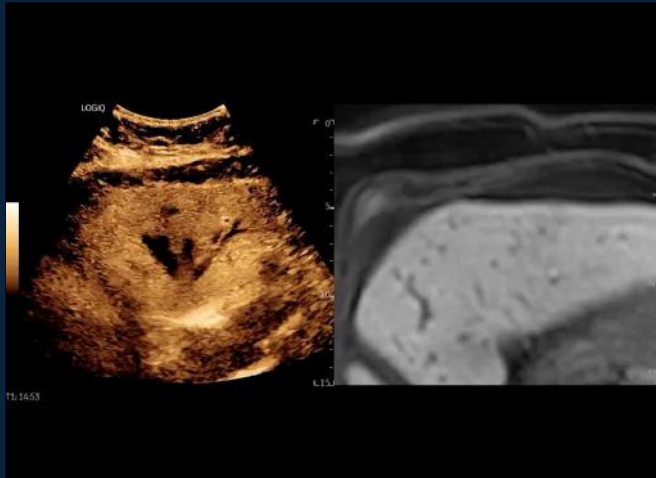

VNav Liver Mass Fused with CT using CEUS, C1-6VN-D



VNav Liver Mass RF Ablation 3D GPS Marker Fused with CT, C1-6VN-D

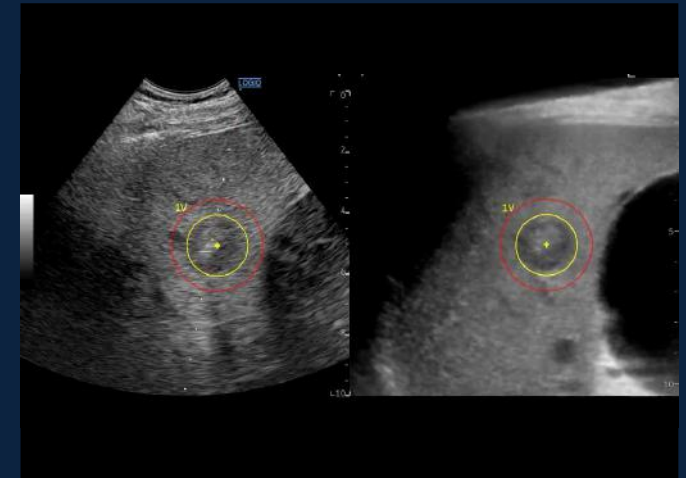

Volume Navigation Liver Lesion 3D GPS Fused with CT, C2-7VN-D

B-Flow

Direct hemodynamic visualization

The challenge

Visualize blood flow and depict the hemodynamic profile without unwanted signals from surrounding tissue and with increase sensitivity and resolution compared to Color Doppler.

GE solution

B-Flow Imaging

- Innovative non-Doppler technology
- Direct visualization of blood reflectors
- Higher frame rate and spatial resolution than Color Flow – without vessel overwrite
- Less dependent on user technique and scanning angle as compared to color Doppler
- Display small vessels with ease
- Can be used in combination with contrast agents



B-Flow

Direct hemodynamic visualization



A GE innovation

- Not using Doppler processing
- Based on GE Patented Coded Technology
- Display real hemodynamics
- Direct visualization of blood reflectors

True hemodynamics and anatomy

- Dynamic appearance of flow
- Minimal tissue overwrite compared to Color Flow
- Better control of flash artifacts compared to Color Flow



B-Flow Left Ventricle, M5Sc-D

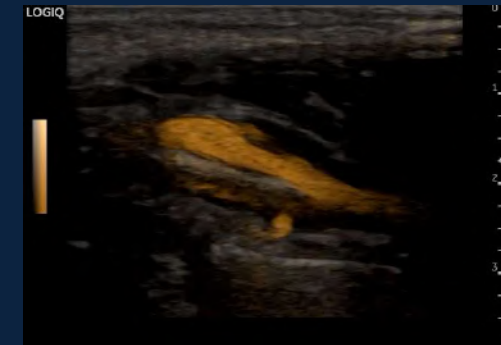

B-Flow Hybrid Carotid, L2-9-D

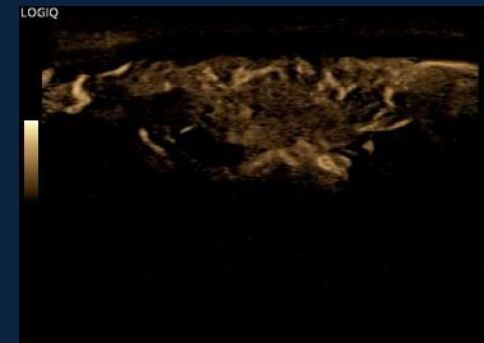

B-Flow Thyroid, ML6-15-D

B-Flow



Benefits over Doppler

- No tissue overwrite
- No impact on frame rate
- Less angle dependency
- High resolution imaging
- Background image clearly visible

Available on probes:

- C1-6-D/C1-6VN-D
- C2-9-D/C2-9VN-D
- C2-7-D/C2-7VN-D
- C3-10-D
- L2-9-D/L2-9VN-D
- L8-18i-D
- M5Sc-D
- ML6-15-D



B-Flow Hybrid Visualization of Kidney, C2-9-D



B-Flow Dual View Spleen, C2-9-D

LOGIQ Fortis™ – B-Flow imaging

Direct visualization of blood reflectors



B-Flow benefits

- Increased sensitivity
- No angle dependence
- True hemodynamics

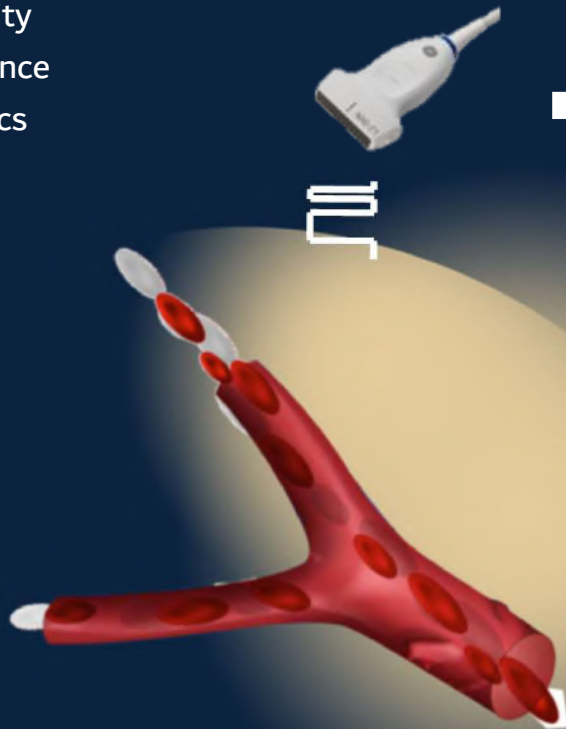

Receive with cSound™ Imageformer:

Transmit pulse #1

Transmit pulse #2

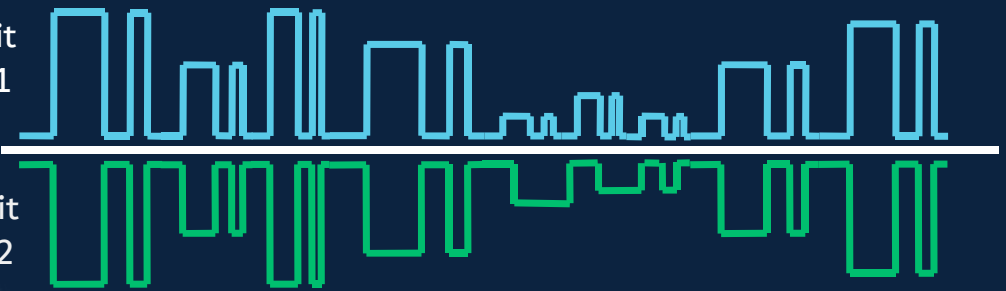

Subtraction:

Suppress Tissue



LOGIQ Fortis™ – B-Flow imaging



B-Flow Neonate Liver,
C2-9-D

Small vessel
sensitivity

*Detects small vessel flow with cSound™
imageformer and coded-excitation*

True vessel
diameter

*Eliminates wall overwriting, show
true hemodynamics*

Wide
availability

*C1-6-D, L2-9-D, C2-9-D, ML6-15-D, L8-18i-
D, C2-7-D, C3-10-D & M5Sc-D*

LOGIQ Fortis™ – B-Flow clinical benefits

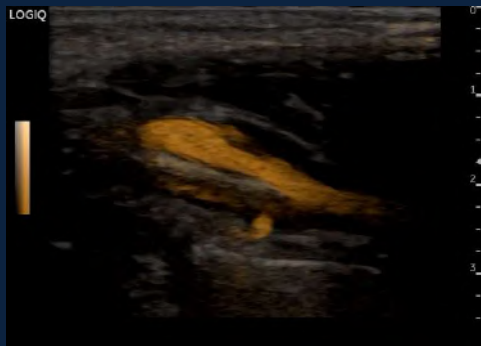

- Visualize flow profile and hemodynamics through a tight stenosis
- True vessel diameter to improve soft plaque detection



- Evaluation of liver surface vessels assessing for tortuosity
- Assess organ perfusion through a kidney transplant



- Confirmation of vessel patterns in liver lesions
- Improve visualization of a hernia or ureteral jets



- Assess nodule or inflammation for vascularity
- Placenta perfusion

Hybrid B-Flow



Highlights

- Side-by-side, simultaneous display of B-Mode and B-Flow images to facilitate assessment of carotid stenosis, fetal brain, and other studies
- B-Flow Capture with Reconstruction provides a three-dimensional view of blood vessels in which artifacts are automatically suppressed and weak vessel signals enhanced

Available on probes:

- C1-6-D
- C2-9-D
- L2-9-D
- ML6-15-D
- L8-18i-D



B-Flow Hybrid Visualization of Kidney, C2-9-D

Attributes and comparison of LOGIQ Fortis™ flow modes



	CF	PDI	MVI	B-Flow
Quantify velocity	X			
Show flow direction	X	X		
No aliasing		X	X	X
Flow angle independent				X
Background B image	X	X	X	X
Whole image flow (no ROI)				X
Best penetration	X	X		
Best hemodynamics			X	X
Best spatial resolution			X	X

LOGIQ Fortis™ – Color Flow Imaging technology



Fundamentals of Color Flow (CF)

- Separated Tx and Rx for flow (inside color box) and background B-Mode frame
- Overlay flow and background B for complete CF Imaging frame
- Apply Wall Filter to differentiate true flow and clutters
- Display both flow velocity and direction information

Advantages of LOGIQ Fortis CF

- Incorporates GE proprietary Coded Excitation technology for a new flow processing chain
- Achieve high spatial resolution and minimal flow overwriting at shallow depth, and simultaneously penetrate more at deep depth

Transmit & Receive

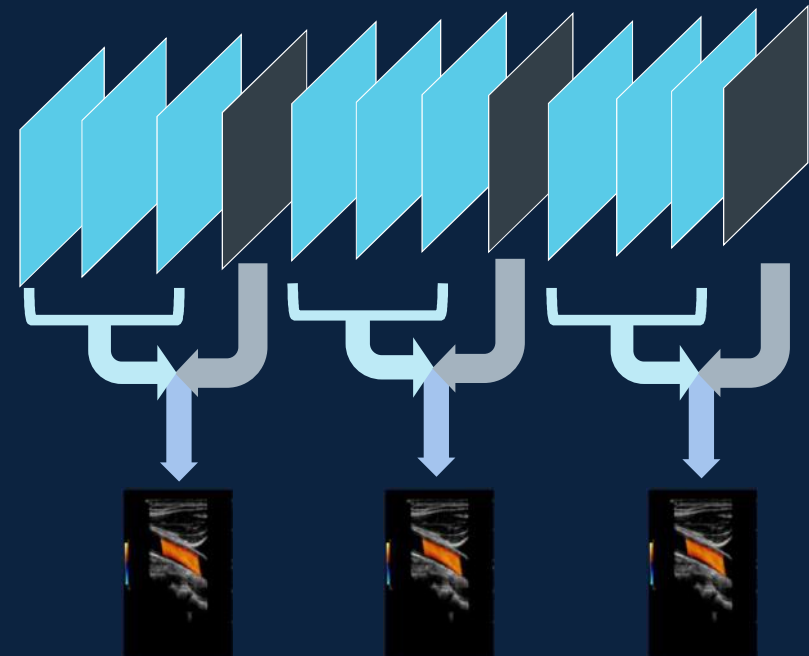

LOGIQ Fortis™ – Advantages of Color Flow Imaging

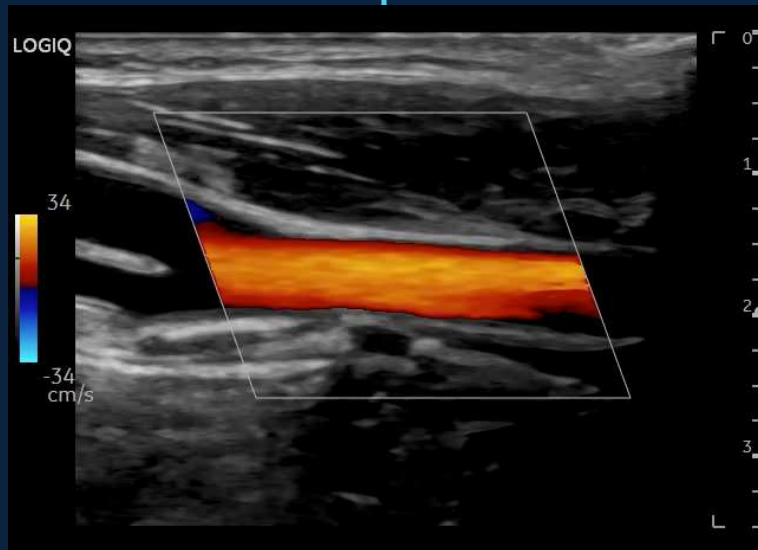

Color Flow Carotid, L2-9

Flow velocity

Displays flow velocity for both small and large vessels at different depths

Deep penetration

Penetrates more to show flow information at deep depths

Clear large vessel separation

Shows artery and vein flows with clear large vessels separations

LOGIQ Fortis™ – Color Flow Imaging clinical benefits



- Hepatic artery and PV separation
- Renal vessels from hilum through parenchyma
- Deep aortic imaging

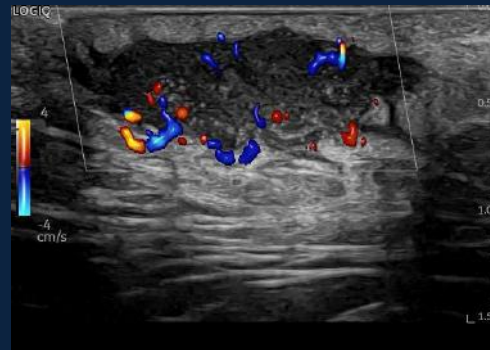

- Evaluation for torsion in deep ovarian vessels
- Assessing flow in a fibrotic uterus



- Fetal heart to visualize the chambers and great vessels easily
- Umbilical cord to see separation of the vein and arteries

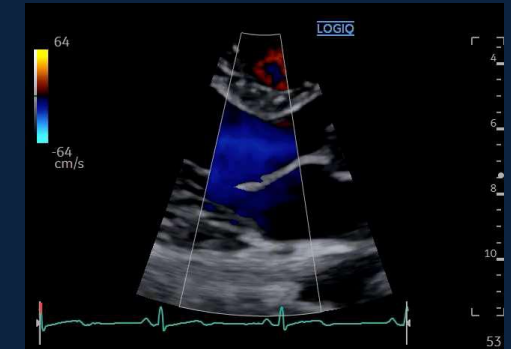

- Assess velocity information and direction
- Slow flow in deep arteries and veins

LOGIQ Fortis™ – Power Doppler Imaging (PDI) technology



Fundamentals of PDI

- Separated Tx and Rx for flow (inside color box) and background B-Mode
- Overlay flow and background B-Mode for a complete PDI flow
- Apply Wall Filter to differentiate flow and clutter

Advantages of LOGIQ Fortis PDI

- Incorporate GE proprietary Coded Excitation technology for a new flow processing chain
- Achieve high spatial resolution and high sensitivity at shallow depth, and simultaneously penetrate more at a deep depth

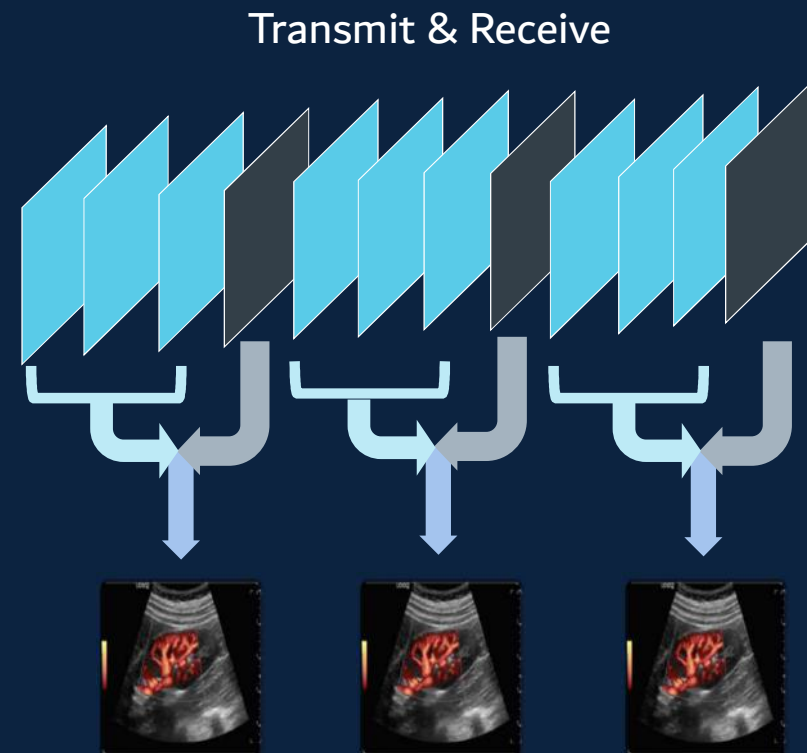

LOGIQ Fortis™ – Power Doppler Imaging (PDI)



High sensitivity with fine spatial resolution

Shows high flow sensitivity, especially for small vessels at shallow depths with GE proprietary Coded-Excitation

No aliasing

No aliasing as CF does

Directional color map showing flow direction

Displays extra flow direction in addition to its strength information



PDI with Radiantflow™ in Fetal Aortic Arch, L2-9-D

LOGIQ Fortis™ – Power Doppler Imaging clinical benefits

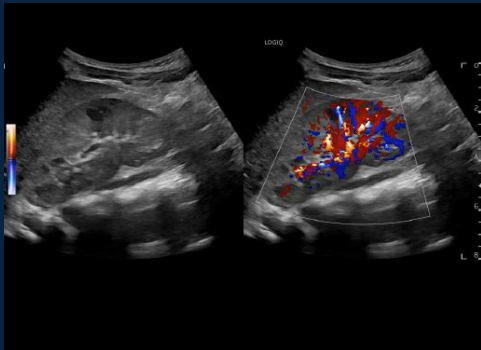

- Liver lesions
- Assessment of inflammation or ischemia on the kidneys



- Evaluation for torsion in deep ovarian vessels when high sensitivity is needed
- Evaluation of testicular torsion or hyperemia on the epididymis



- Fetal heart to visualize the chambers and great vessels easily
- Umbilical cord to see separation of the arteries

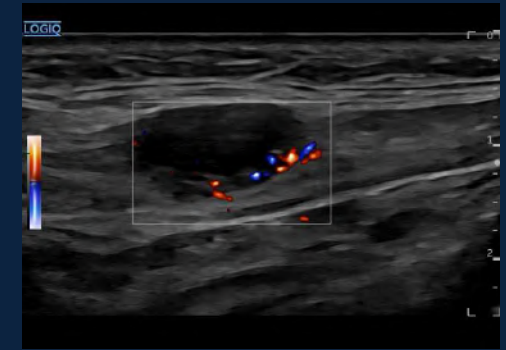

- Evaluation of blood flow through neonatal head

B-Steer+

B-Steer+ feature enables enhanced visualization of the needles structure during interventional procedures, helping improve user confidence.

Highlights

- Up to 12 selectable steering angles available (six each direction)
- Separate gain control for needle reflection
- Available on all linear transducers
- Quick one-button operation





Elastography

The LOGIQ Fortis™ has a comprehensive elastography package, offering both Strain Imaging and Shear Wave elastography techniques to perform tissue deformation and provide tissue stiffness measurements in different clinical applications.

Strain imaging

- Light manual compression to perform tissue deformation
- Qualitative and semi-quantitative information
- Focus: Oncology, inflammatory disease

Shear Wave elastography

- Focused burst of acoustic energy to perform tissue deformation through a comb-push excitation
- Color coded elastogram and quantitative measurements
- Focus: Chronic liver disease, oncology
- Now available with a Shear Wave Elastography Quality Indicator to support confident measurements

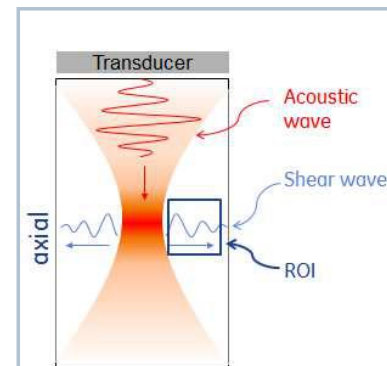

Elastography

Strain imaging

Strain imaging technology requiring a light manual compression or vessel pulsation to perform tissue deformation. The package includes a qualitative and semi-quantitative solution.

Highlights:

- High sensitivity and persistence
- Consistent pattern
- User selectable color maps
- Dedicated color map for liver using physiological pulsation
- Dual measurements
- User support by pressure quality bar and graph
- Working in combination with Volume Navigation (V Nav)



Elastography

Strain imaging



Available on the following probes:

- L2-9-D/L2-9VN-D (Small Parts, Abdomen, MSK)
- L3-12-D (Small Parts, Breast, MSK)
- IC5-9-D (Urology, Gyn)
- C1-6-D/C1-6VN-D (Abdomen)
- C2-9-D/C2-9VN-D (Abdomen, Pediatrics)
- ML6-15-D (Small Parts, Breast, MSK)
- L8-18i-D (Small Parts, Breast, MSK)
- BE9Cs-D (Prostate)

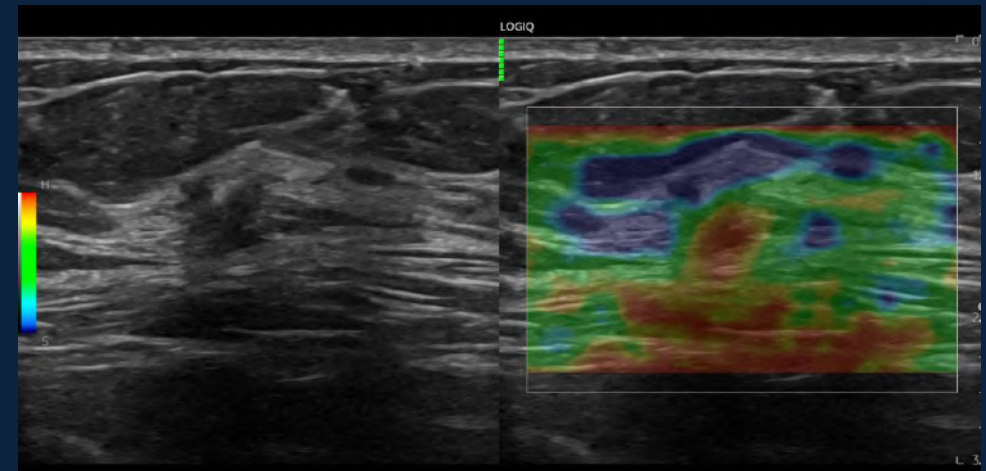

Stiff breast mass with strain elastography, ML6-15-D

COVERING A WIDE RANGE OF APPLICATIONS

Elastography

2D Shear Wave



Available on the following probes:

- C1-6-D/C1-6VN-D (Abdomen)
- IC5-9-D (Prostate, GYN)
- L2-9-D/L2-9VN-D (Small Parts, Breast, MSK)
- L3-12-D (Small Parts, Breast, MSK)
- L8-18i-D (Small Parts, MSK)
- ML6-15-D (Small Parts, Breast, MSK)

Worksheet

Records up to 12 sample values for each series:

- Displays Mean, Median, IQR and STD of the average of multiple series
- Allows easy deletion, exclusion and quick replacement of measurements
- Allows annotations for different organ measurements

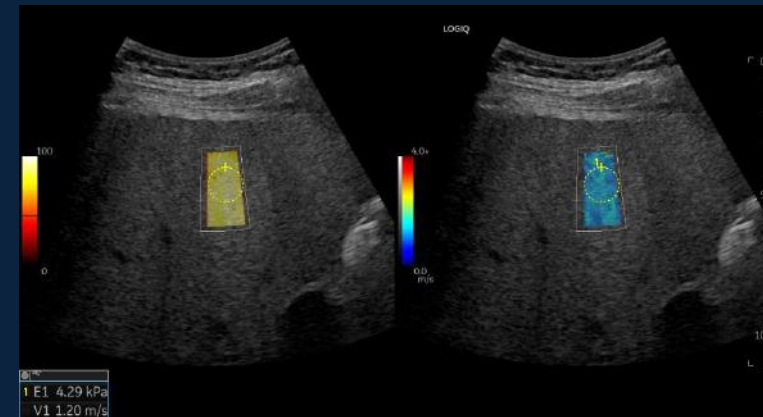

Liver Shear Wave Elastography, C1-6-D

	5.8	5.9
Mean	4.22 kPa	3.82 m/s
SD	0.57 kPa	0.07 m/s
IQR (min)	3.74	3.48
1	4.58 kPa	3.23 m/s
2	4.57 kPa	3.25 m/s
3	4.07 kPa	3.00 m/s
4	4.55 kPa	3.22 m/s
5	4.07 kPa	3.24 m/s
6	5.57 kPa	3.15 m/s
7	4.33 kPa	3.12 m/s
8	4.05 kPa	3.00 m/s
9	5.05 kPa	3.15 m/s
10	3.82 kPa	3.13 m/s
11	4.09 kPa	3.17 m/s
12	4.17 kPa	3.18 m/s

Display Both Stiffness and Velocity in One Summary

Elastography

2D Shear Wave



General highlights

2D Shear Wave elastography technique (visual and quantitative information in a color coded box)

- User selectable color maps
- Now with Quality Indicator
- **Adjustable Color Box** and **ROI depth** and **size**
- Multiple measurements within a single shear wave image
- **Auto sequencing feature** for an automatic placement of measurement ROI within image
- Dual or single display option
- Measurements in kPa or m/s or both
- Mean, Median, IQR and STD display for multiple measurements
- Fast acquisition time to reduce motion artifacts
- **Penetration mode** for technically challenging cases
- Summary worksheet
- Supporting GE Raw Data
 - Measurements can be done on acquired clips after the exam is ended
- Working in combination with Volume Navigation and Needle Tracking
 - Comprehensive tool for liver disease management

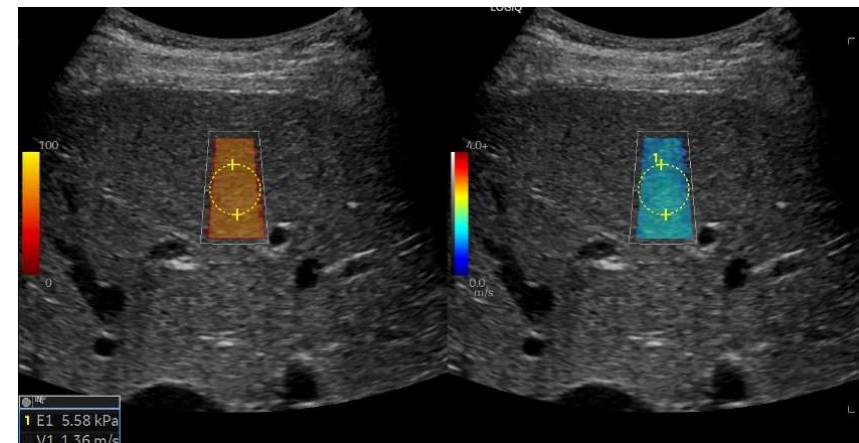

Liver Shear Wave Elastography Quality Indicator, C1-6-D

Shear Wave Elastography

Case gallery



Liver Shear Wave Elastography, C1-6-D

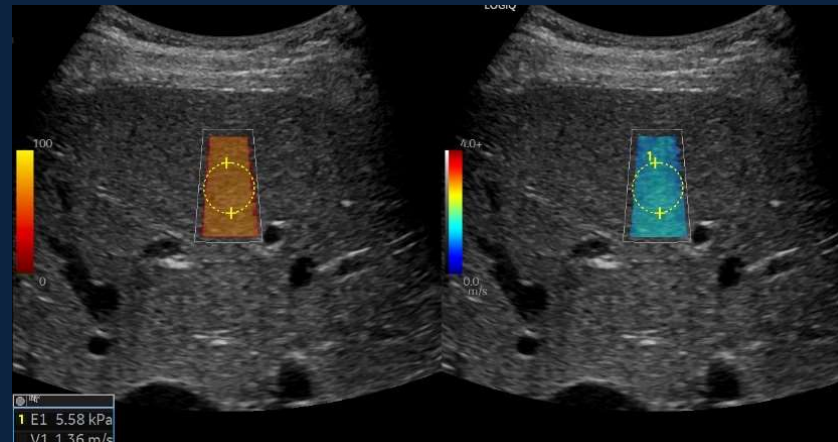

Liver Shear Wave Elastography Quality Indicator, C1-6-D

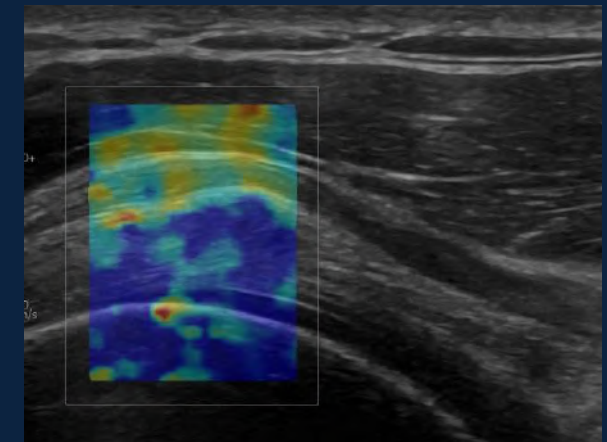

Shoulder Shear Wave Elastography, ML6-15-D

LOGIQ Fortis™ 2D Shear Wave Elastography

Liver fibrosis staging chart



A GE study has demonstrated that LOGIQ™ E9 Shear Wave Elastography is a robust technique and capable of evaluating stiffness changes in the liver associated with fibrosis. Although a limited number of subjects were evaluated at the hospital in this study, liver stiffness measurements were shown to be useful for discriminating different stages of fibrosis. It is important to note that a small number of subjects with intermediate stages of fibrosis were evaluated in this study, and that a mix of disease etiologies were present. Therefore, the values shown may not be directly applicable to other patient populations. Data was acquired using LOGIQ E9 R5.1.0 equivalent software and the C1-6-D probe.

The results are applicable to LOGIQ E9 R6, LOGIQ E10 and LOGIQ Fortis™ software versions. For detailed information, please see the LOGIQ E9/E10/Fortis Shear Wave Elastography white paper.

CAUTION: The values for the shear wave speed and tissue modulus are relative indices intended only for the purpose of comparison with other measurements performed using the LOGIQ E9, LOGIQ E10 and LOGIQ Fortis. Absolute values for these measurements may vary among different measurement devices.

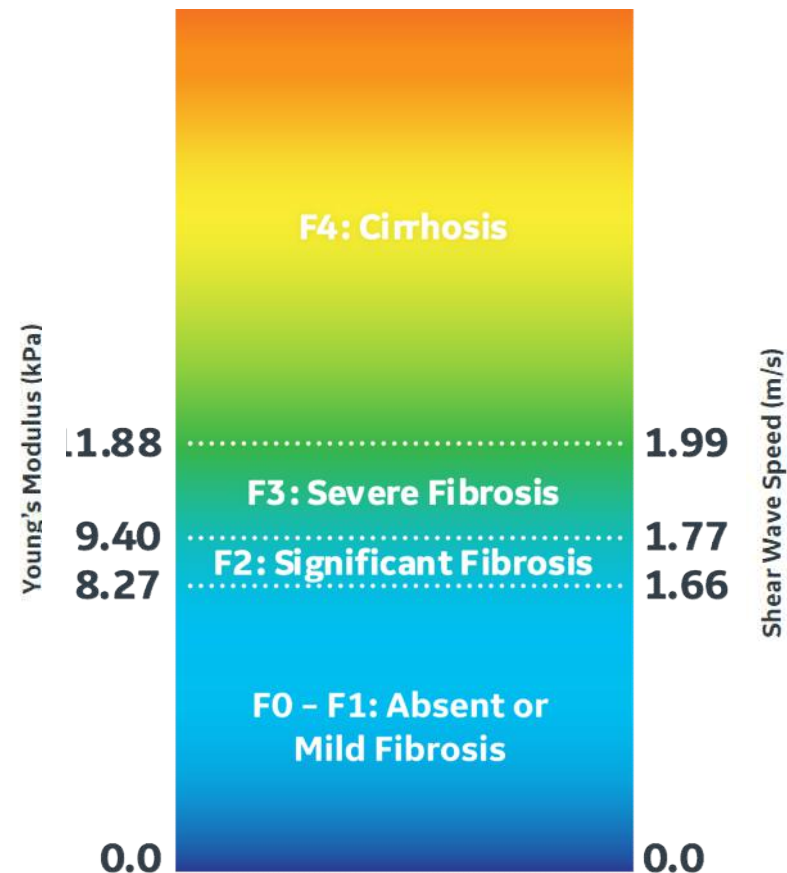

Ultrasound-Guided Attenuation Parameter (UGAP)



Quantifies liver steatosis to aid in early identification and monitoring of patients with NAFLD, NASH or ASH

Highlights

- Quality Indicator and user selectable color maps
- Attenuation Map
- Multiple measurements within an image
- Auto measurement feature for ROI placement
- Dual or single display option
- Measurements available in Attenuation Rate or Attenuation Coefficient
- Mean and IQR display

See the UGAP Whitepaper for detailed information.

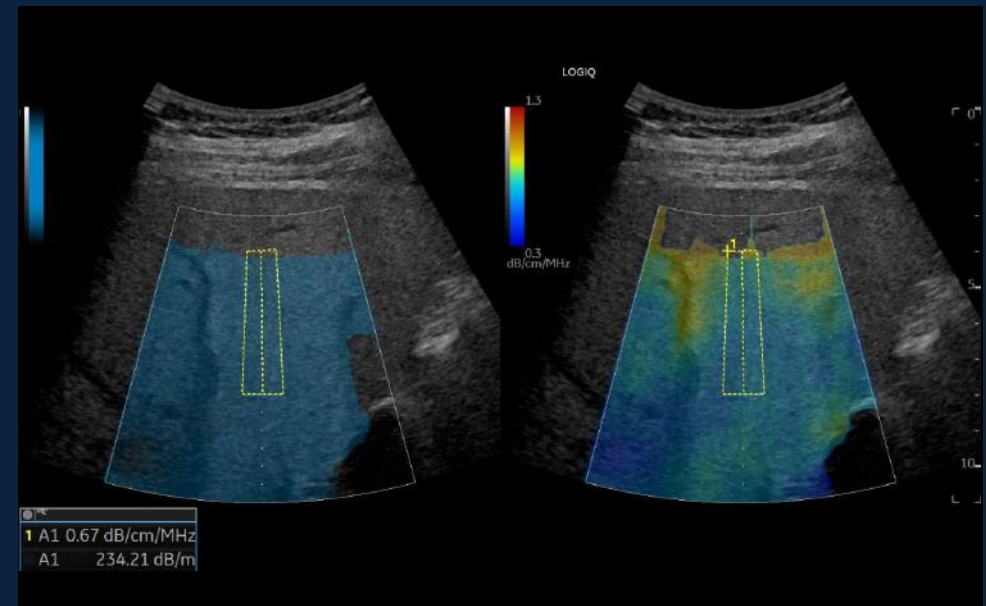

Ultrasound-Guided Attenuation Parameter Dual View with Attenuation Map and Quality Map, C1-6-D

LOGIQ Fortis™ Ultrasound-Guided Attenuation Parameter (UGAP)



Liver steatosis grading

UGAP provides a non-invasive quantifiable way to measure hepatic steatosis that utilizes attenuation of the sound waves.

Designed to address the prevalence of non-alcoholic fatty liver disease (NAFLD), UGAP provides a non-invasive, quantifiable way to measure hepatic steatosis that utilizes attenuation of the sound wave.

For more information, please see the UGAP whitepaper.

	≥S1	≥S2	S3
AUROC (95% CI)	0.901 (0.891-0.928)	0.912 (0.894-0.929)	0.894 (0.873-0.916)
Attenuation coefficient cutoff value (dB/cm/MHz)	0.65	0.71	0.77
Attenuation rate cutoff value (dB/m)	228	249	270

AUROC, 95% CI and cutoff values of UGAP for the prediction of ≥ S1, ≥ S2 and S3 steatosis.

3D/4D ultrasound

GE volume imaging with 3D/4D dedicated hybrid abdominal probe



Highlights

- Easy, quick, reproducible
- High volume data
- Comprehensive settings
- Auto sweep
- Beta View

Available on probes

- RAB6-D: abdominal, obstetrics
- RIC5-9-D: gynecology, urology

Volume Modes

- Multi-planar imaging, surface rendering
- TUI – Tomographic Ultrasound Imaging
- VCI – Volume Contrast Imaging
- VOCAL – Volume Calculation
- STIC – Spatio-Temporal Image Correlation
- OmniView
- VCI OmniView



3D HDlive™ Fetal Hand, RAB6-D

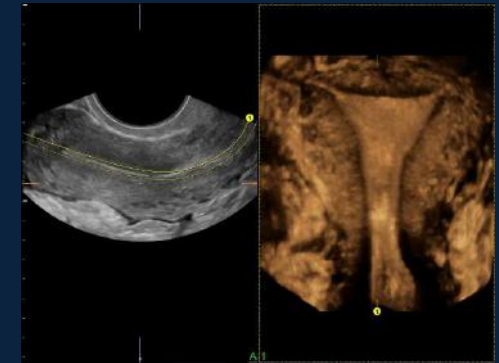

OmniView Dual Screen, RIC5-9-D

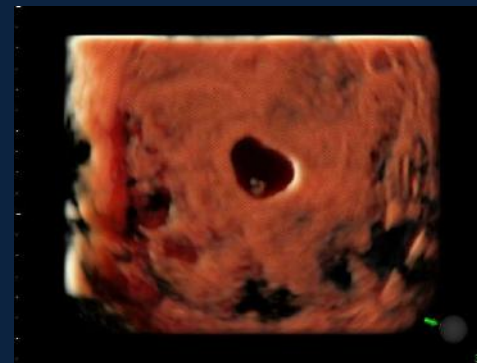

3D HDlive Early Gest Sac and Fetal Pole, RIC5-9-D

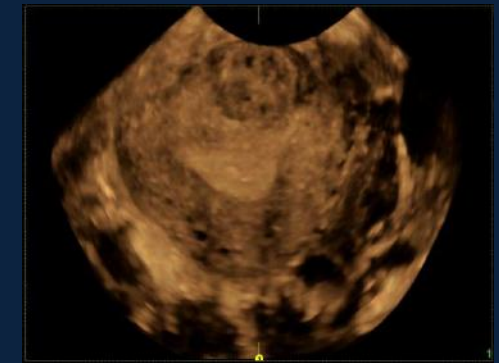

OmniView Uterine Fundus, RIC5-9-D

3D/4D ultrasound

TUI – Tomographic Ultrasound Imaging



Visualization mode that presents data as parallel slices (planes) through acquired Volume dataset. It works with CFM/PDI and SRI-HD.

Highlights

- Information consistent to CT & MR format
- 3D static with color
- Up to 9 slices, with user selectable distance (min 0.5 mm, step by 0.1 mm) and angle
- Top left held as reference image
- Works with SRI

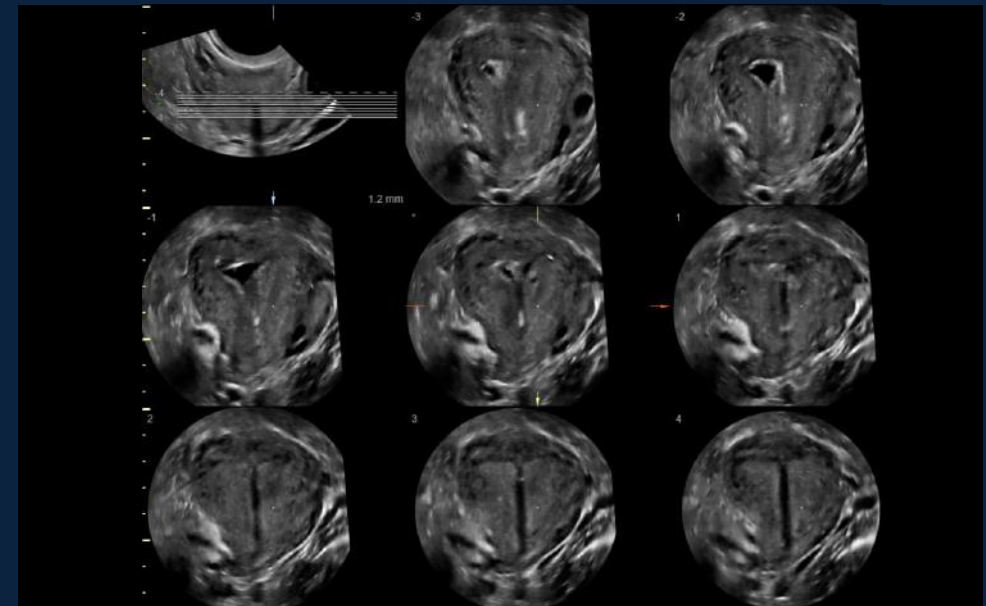

3D TUI Uterus IUD, RIC5-9-D

3D/4D ultrasound

VCI – Volume Contrast Imaging



VCI is a volume post processing technique which helps improve B-Mode contrast resolution and speckle suppression.

Helps improve assessment of lesions size, margins and internal structures for comprehensive patient management.

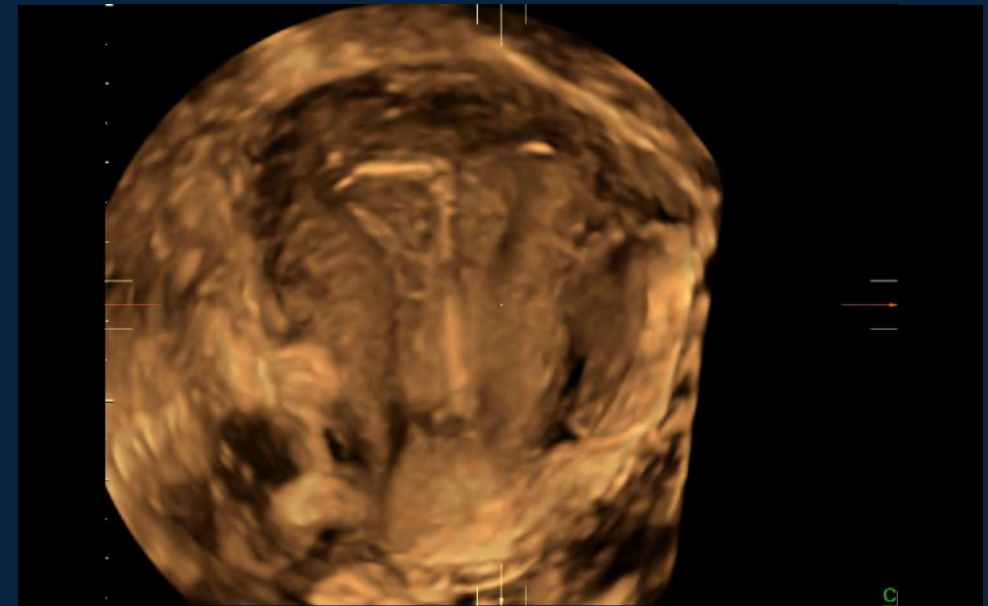
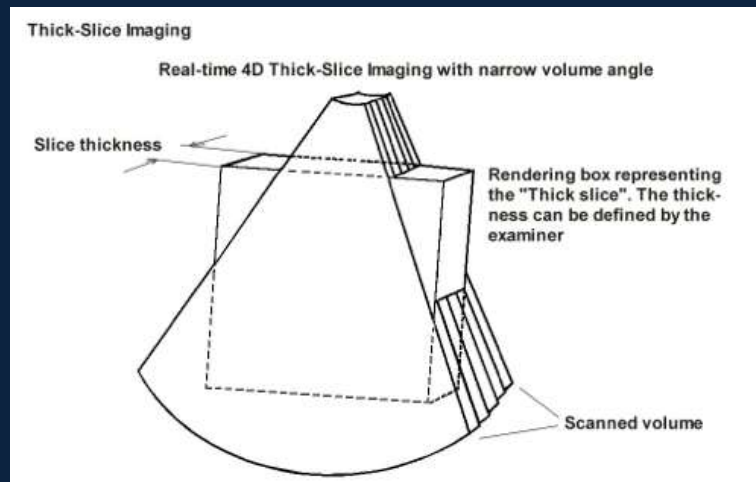

3D VCI Uterus IUD, RIC5-9-D

3D/4D ultrasound

VOCAL



VOCAL is a 'Volume Computer-Aided Analysis' based on a volume acquisition to help enable fast and accurate volume calculations.

Highlights

- Manual, semi automatic or automatic borders definition
- Basic measurements as length, angle and area
- Easy corrections and contour modifications
- Can be used with any lesion or volume to measure

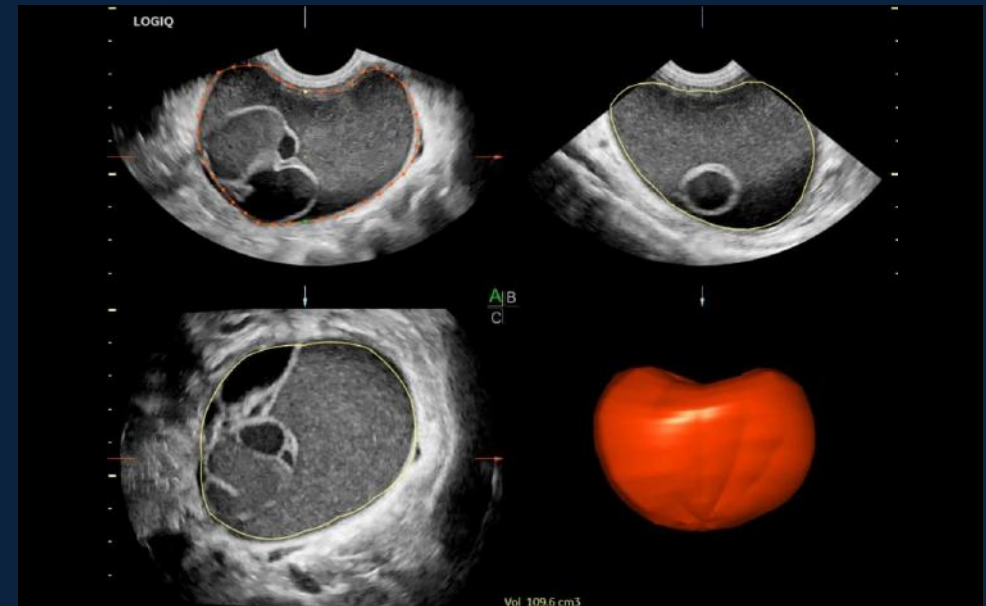

VOCAL Ovarian Cystic Mass, RIC5-9-D

3D/4D ultrasound

OmniView



OmniView is the “Any-Plane” function for 3D and 4D data.

Highlights

- Gives the ability to trace along any shape or structure
- Can be started from A, B or C. Up to 3 planes can be displayed simultaneously

VCI OmniView is the “Any-Plane” function with thick slice detail.

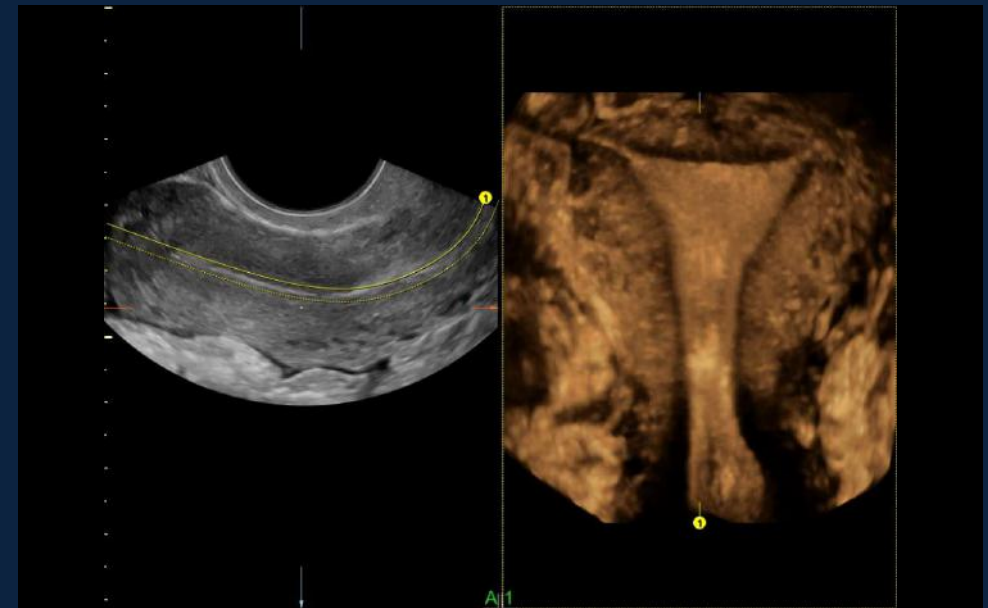

OmniView Dual Screen, RIC5-9-D

SonoRender*live*



Automate render line placement in 3D/4D imaging, enabling clinicians to easily acquire surface-rendered images

Highlights

- Render start line is a “free” trace for optimal adaptation to the render object
- Useful in fetal imaging



OB 3D Render, RAB6-D

Compare Assistant

Help streamline comparison to prior exams



Opportunity

Many ultrasound exams are follow-ups to prior ultrasound or other modality exams.

Goal

Drive productivity for acquiring and reading the exam by designing a workflow that uses prior exam data.

Result

A quick image comparison or a replicated prior exam.



Compare Assistant

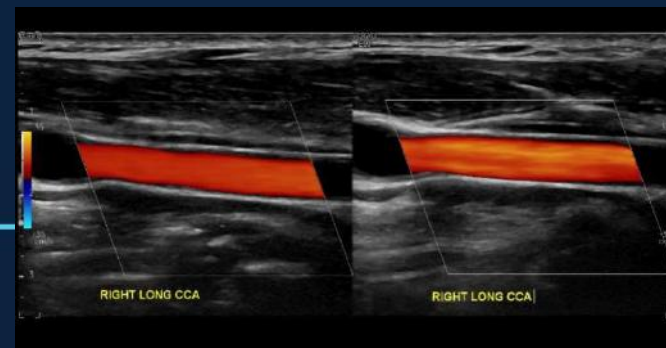
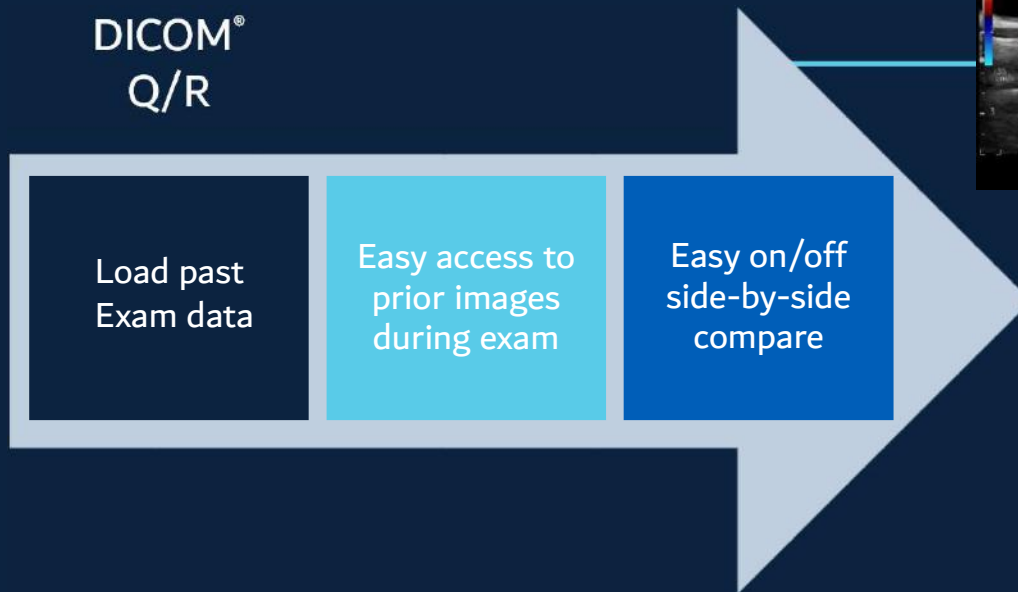

Compare Assistant

Help streamline comparison to prior exams



At the scanner...

Easy access to past exam data on the scanner

Side-by-side compare and store past exam image to today's image

Set image settings of live scanning to match past exam image¹

Create entire new exam to match old exam

At the reading station...

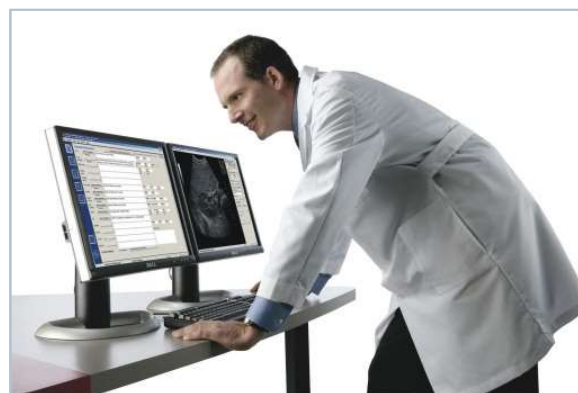

Reduce the time spent to find, open, sort, compare to prior exams

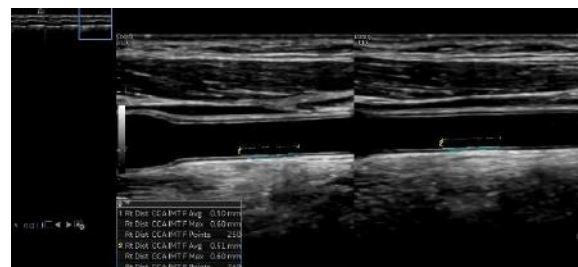

Carotid Compare Assistant

Breast Assistant, powered by Koios DS™

Decision support: Harnessing the power of Artificial Intelligence (AI)



DESIGNED TO INCREASE CLINICAL CONFIDENCE AND REDUCE PATIENT ANXIETY

Breast Assistant, powered by Koios DS™



Automatically provides an AI-based quantitative risk assessment that aligns to a BI-RADS® category

In Breast Assistant:

- Measure the lesion (either manually or with Auto Contour)
- Select the “Koios” button to analyze the image
- In 2 seconds or less, a quantitative color-coded confidence scale is generated that includes the Likelihood of Malignancy (LoM)

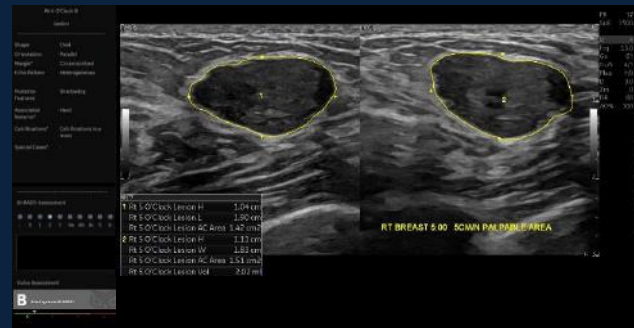
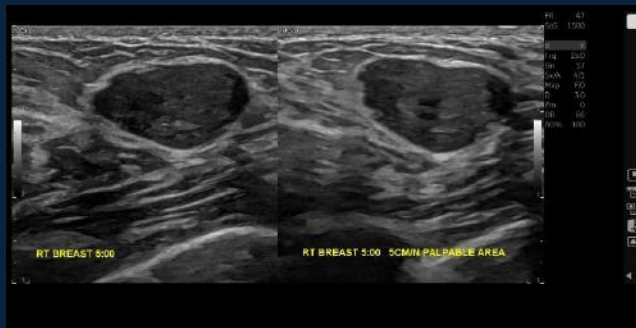

Benign Breast Mass, ML6-15-D

DESIGNED TO INCREASE CLINICAL CONFIDENCE AND REDUCE PATIENT ANXIETY

Breast Assistant, powered by Koios DS™



Automatically provides an AI-based quantitative risk assessment that aligns to a BI-RADS® category:

- Based on machine learning
- Uses a proprietary AI algorithm that includes >400,000 clinical breast lesion images
- One button click to analyze
- A color-coded confidence scale generates a likelihood of malignancy (LoM) aligned to the appropriate BI-RADS category
- Results on scanner
- Available in two seconds, or less



Koios DS is a trademark of Koios Medical.
BI-RADS is a trademark of the American College of Radiology.

Breast Assistant, powered by Koios DS™



Benign Breast Mass, ML6-15-D

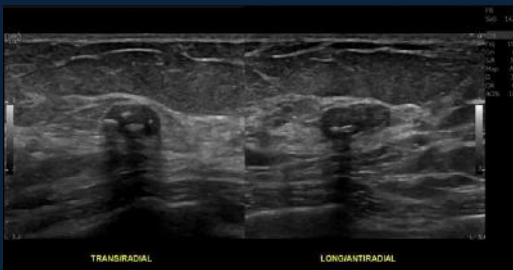

Benign Breast Mass with Multiple Calcifications, ML6-15-D

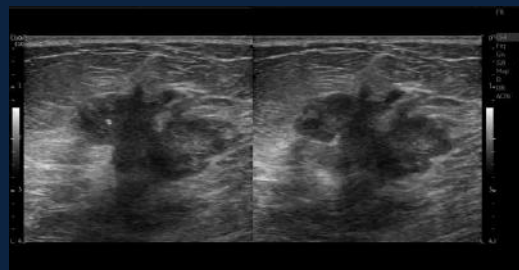
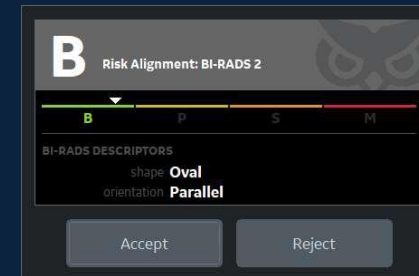

Malignant Breast Mass



Breast Assistant, powered by Koios DS™

Analysis return examples



B = Benign
P = Probable Benign
S = Suspicious
M = Malignant

B Risk Alignment: BI-RADS 2

▼

B P S M

BI-RADS DESCRIPTORS

shape **Oval**
orientation **Parallel**

Accept Reject

P Risk Alignment: BI-RADS 3

▼

B P S M

BI-RADS DESCRIPTORS

shape **Round**
orientation **Not parallel**

Accept Reject

S Risk Alignment: BI-RADS 4A-4B

▼

B P S M

BI-RADS DESCRIPTORS

shape **Irregular**
orientation **Parallel**

Accept Reject

M Risk Alignment: BI-RADS 4C+

▼

B P S M

BI-RADS DESCRIPTORS

shape **Irregular**
orientation **Not parallel**

Accept Reject

Breast Assistant, powered by Koios DS™

Decision support for confident diagnosis



- Based on machine learning
- Uses a proprietary AI algorithm that includes >400,000 clinical breast lesion images
- Select the “Koios” button to analyze the image
- Available in two seconds, or less

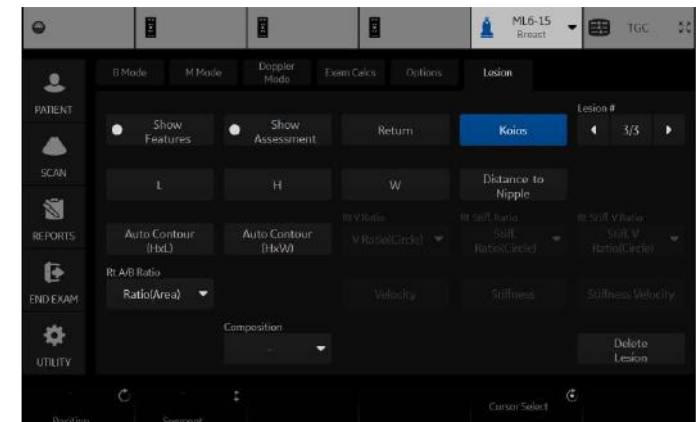



— OPTIMIZING Your Productivity

Optimizing your productivity



The LOGIQ Fortis™ is powerfully streamlined to optimize your daily workflow. Outfitted with advanced productivity tools that help facilitate diagnosis and improve treatment, it is the system you can count on for consistent whole-body imaging. Ergonomically, it has maintained the LOGIQ™ family key layout proven to cut down on keystrokes and time. Intuitive to learn and integrate into your day, the LOGIQ Fortis gives you a level of clinical confidence that comes from comprehensive decision support.



LOGIQ™ apps

Photo Assistant



A picture is worth a 1000 words

- Photograph relevant anatomy and include photos with the clinical images
- Provides value context for documentation and comparison after a procedure
- Utilizes Android™ tablet or phone
- Bar code reader



Photo Assistant app



Take a photo with your smart device and have it become part of the ultrasound exam, including side-by-side with an actual ultrasound image



LOGIQ™ apps

Remote Control



Remotely operate the system from tablet or phone that has LOGIQ Smart app loaded

- Focused on ergonomics
- Includes:
 - Major modes
 - Freeze/print
 - Depth
 - Gain
 - ROI placement
 - Dual image

Harnessing the power of AI

AI-based Auto Doppler Assistant on the LOGIQ Fortis™

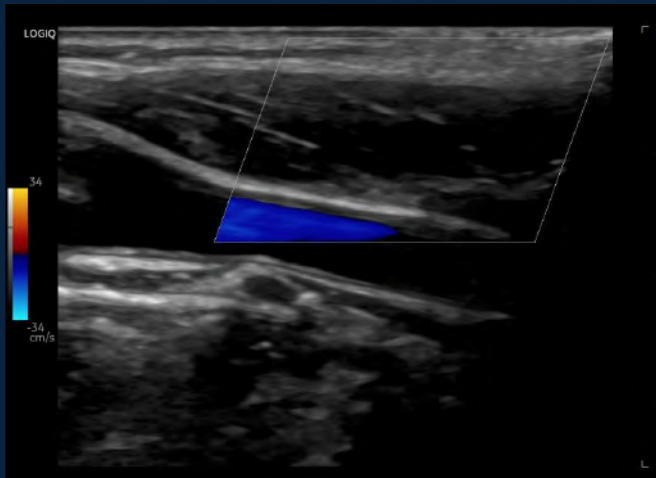

User guides system to the vasculature of interest and pushes a button

Benefit: Users scan as they normally would and control initiation of the algorithm

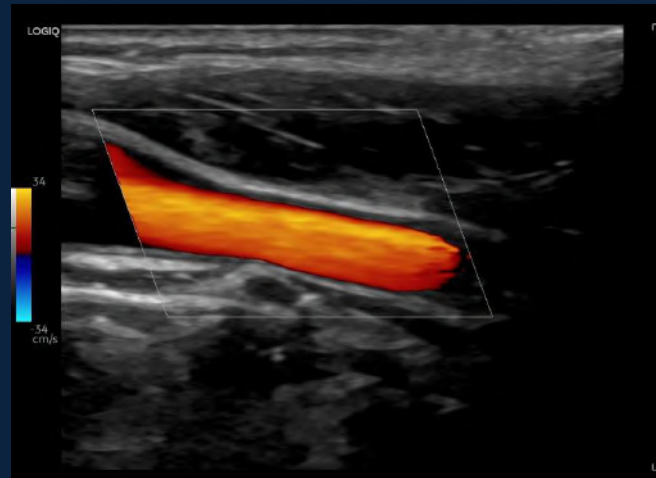

Doppler Assistant determines the location and direction of vessels

Benefit: Keystrokes are reduced as the color ROI and Doppler gate are automatically placed

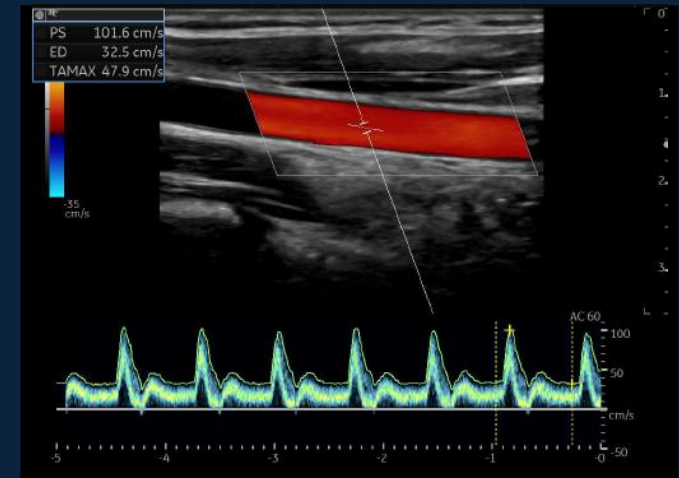

Doppler Assistant determines the location and direction of vessels

Benefit: Results are appropriate for venous versus atrial exams even when both types of vessels are present

MANUAL VIEW CLASSIFICATION

AUTOMATED STRUCTURE DETECTION & CLASSIFICATION

Harnessing the power of AI

AI-based Auto Lesion Segmentation on the LOGIQ Fortis™

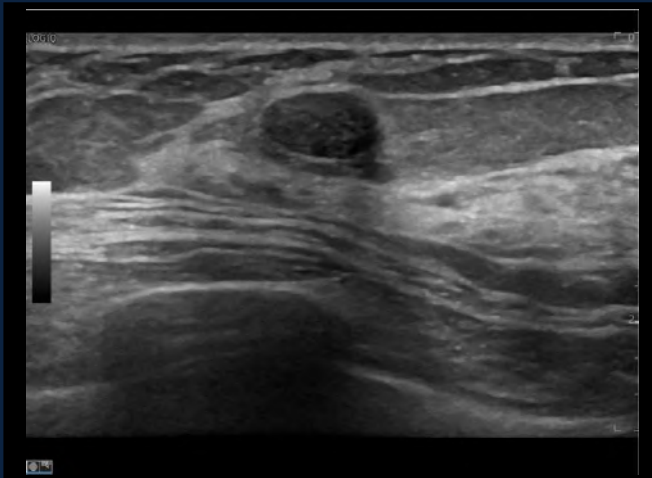

User identifies a breast, thyroid or liver lesion

Benefit: Users scan as they normally would

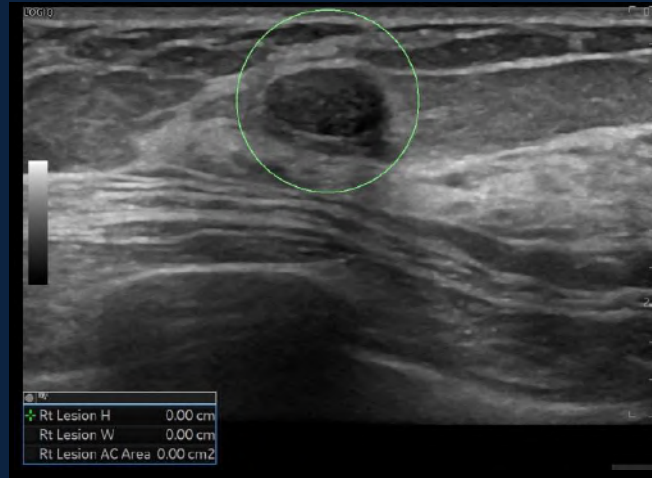

User clicks on the lesion and simply expands a graphical circle to encompass it

Benefit: User identifies a lesion with a single click

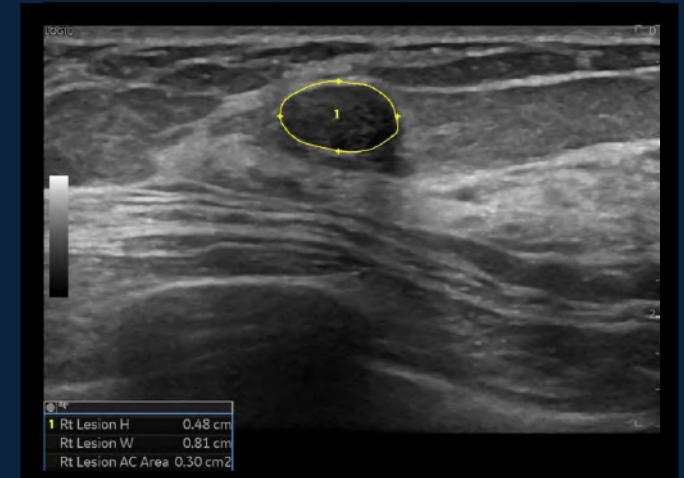

The algorithm segments the lesion, providing a trace and extents of the lesion

Benefit: Calipers are automatically placed to measure the lesion, saving keystrokes and providing consistency

MANUAL VIEW CLASSIFICATION

SEMI-AUTOMATED STRUCTURE DETECTION

Harnessing the power of AI

AI-based OB Measure Assistant on the LOGIQ Fortis™



User identifies a view appropriate for measuring the BPD, HC, AC or FL and initiates a measurement

Benefit: Users scan and initiate a measurement as they normally would



Auto OB Assistant automatically segments out the appropriate structure from the image

Benefit: Measurement is automatically performed, saving keystrokes and providing consistency



The measurement result and associated fetal age is presented to the user

Benefit: Results presented to the user without extra steps

MANUAL VIEW CLASSIFICATION

AUTOMATED STRUCTURE DETECTION & RESULTS

Scan Assistant

A system that thinks the way you do



Assists the user with customizable automations

- Initiates and completes required measurements
- Automatically steers color Doppler
- Automatically sets up imaging controls and modes
- Automatically inserts comments



37% TIME SAVINGS USING SCAN ASSISTANT

Measure Assistant

Designed to work in breast exams



A few simple steps to assist the user with breast measurements

- User bounds lesion with ROI
- System auto traces, generates height and width
- User prints to accept or easily edits as needed
- Messages on the status bar help guide the user



Measure Assistant in two breast lesions

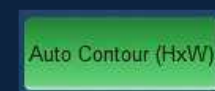

Breast Productivity

Measurement package



A dedicated breast-specific measurement package that allows users

- Make labeling, measuring and describing lesion easy
- Leverage the BI-RADS® lexicon criteria/assessment
- Organizes multiple measurements into a convenient worksheet
- Send results via DICOM® SR

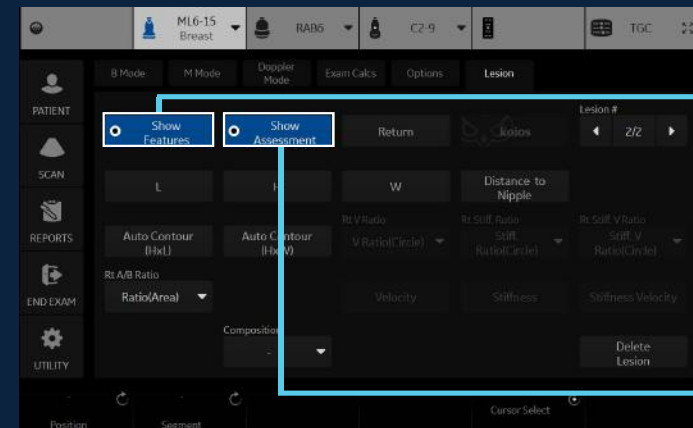

Straight from BI-RADS Lexicon

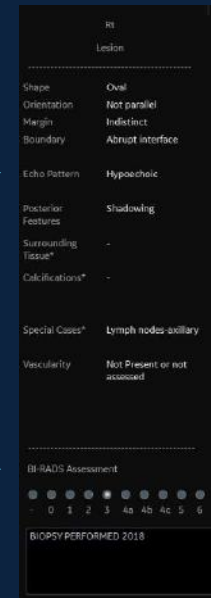

Measure Assistant

Designed to work in OB exams



In Scan Assistant:

- Freeze on anatomy
- Measurement auto applied
- Print to accept or easily edit if needed



FL



HC/BPD



AC

OB MEASURE ASSISTANT AC, HC/BPD & FL 37 WEEKS GESTATION, C2-9-D

Thyroid Productivity

Measurement package



Thyroid-specific measurement package that easily enables labeling, measuring and describing nodules, lymph nodes and parathyroids.

Multiple measurements can be organized into a convenient worksheet. Send results via DICOM® SR.

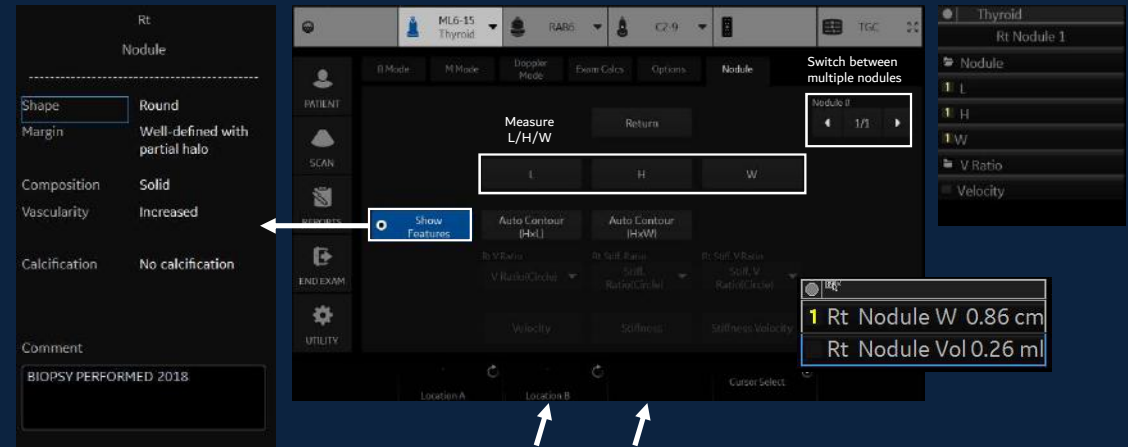

Location qualifiers that are specific enough to provide measurements meaning, even without the image

Fetal Assessment Tools

SonoNT and SonoIT

SonoNT and SonoIT semi-automated measurement tools support exam consistency and reproducibility, while SonoRenderlive automates render line placement in 3D/4D imaging



LOGIQ Fortis™

Design criteria



Usability

Cleanability

Portability

LOGIQ Fortis™ Design

Easy to hide/show lower use imaging controls

Large touch panel...
more comments and
measurements up front



6 context sensitive controls around trackball



Usability

- Consistent with award winning LOGIQ™-style user interface
- One-handed adjustment of operator panel position and height
- Highly adjustable display position
- Key configurability allows for site customization
- Side mounted air intake filters

LOGIQ USERS COMFORTABLE IN LESS THAN AN HOUR



LOGIQ Fortis™ Design

Cleanability

- Rugged materials are robust in the face of harsh cleaning chemicals
- **22** approved agents for *both* console and probes
- Easy to lock controls while cleaning



LOGIQ Fortis™

Design



'Shopping cart'
rear handle

Single bin
storage

Optional
wireless 



'No cord' casters

Fold down
display

Front or rear
transport



Easy
2-pedal brake

Built-in gel
warmer

Twin bin storage

4 active pinless +
2 parking ports

Portability

- Built-in battery to bypass power down and power up (20+ minutes)
- 50 kg lighter than LOGIQ™ E9
- Floating keyboard and adjustable display improve ergonomics in every room
- Robust XDclear™ display even in bright lighting

GO PORTABLE WITH YOUR BEST TO HANDLE YOUR TOUGHEST

LOGIQ Fortis™

Designed for easy disinfection

- 24 compatible cleaners
- Embedded speakers
- Digital TGCs
- Single surface touch panel



LOGIQ Fortis™ Design

Cleanability



**22 approved agents for
both console & probes**

**24 approved agents for
console**

Product	Console	Probe*
Acryl-Des® Wipes	X	X
ALCOHOL (ISOPROPANOL) 70%	X	X
CaviWipes™ 1	X	X
CLEANISEPT® Wipes	X	X
Clinell® Clorox® Wipes	X	X
Clinell® Universal Sanitising Wipes	X	X
CLOROX Healthcare® Bleach Germicidal Wipes	X	X
Easy Screen Cleaning Wipes	X	X
Mikrobac Tissues®	X	X
Mikrozyd® Sensitive Wipes	X	X
Oxivir® Tb Wipes	X	X
PROTEX® Ultra Disinfectant	X	X
Sani-Cloth® AF3 Germicidal Disposable Wipe	X	X
Sani-Cloth® Bleach Germicidal Disposable Wipe	X	X
Sani-Cloth® HB Germicidal Disposable Wipe	X	X
Sani-Cloth Plus Germicidal Disposable Cloth	X	X
Sani-Cloth® Plus Germicidal Disposable Cloth	X	X
Septiwipes®	X	X
SONO® Ultrasound Wipes	X	X
Sodium Hypochlorite 5.25% (Bleach) diluted 10:1	X	
Super Sani-Cloth® Germicidal Disposable Wipes	X	X
Tristel™ Distel™	X	
Trophon® Companion Cleaning Wipes	X	X
Virox™ Accel TB Wipes	X	X

* Compatible with most probes, consult

to check your specific probe.

Acryl-Des is a registered trademark of LYSIS. CaviWipes is a trademark of Metrex. CLEANISEPT is a registered trademark of Dr. Schumacher GmbH. Clinell is a registered trademark of GAMA Healthcare. CLOROX Healthcare is a registered trademark of The Clorox Company. Mikrobac Tissues is a registered trademark of BODE Chemie GmbH. Mikrozyd is a registered trademark of Schülke & Mayr GmbH. Oxivir is a registered trademark of Diversey. PDI Easy Screen is a registered trademark of PDI, Inc. PROTEX is a trademark of Parker Laboratories. Sani-Cloth is a trademark of PDI. Septiwipes is a registered trademark of EDM Medical Solutions. SONO is a registered trademark of Advanced Ultrasound Solutions. Tristel Distel is a trademark of Fischer Scientific. Trophon is a registered trademark of Nanosonics, Inc. Virox is a trademark of Virox Technologies Inc.



Scan on battery



Scan on battery provides battery power **during transport** to help decrease system shut-down and reboot time. It also enables a clinician to **pick up a probe and scan, even when not plugged in** – helping to achieve excellent productivity for high quality, portable exams.

Highlights

- Prompt in and out of battery operation mode to help improve system's portability
- Simple plug in and out operation
- System safely shuts down automatically before battery runs out
- ~50 minutes offline scanning is available
- Battery always charges when power cord is plugged into the power outlet



Scan on battery



- Available as an option on LOGIQ Fortis™
- Allows for scanning while on battery power (AC unplugged)
- When the AC cable is unplugged, the system automatically switches to battery mode
- When the battery is fully charged, the Fortis can scan for ~50 minutes

To save battery power, you can switch to power saving mode.

- Charging needs around 2-3 hours from empty to full
- System automatically starts charging when plugged into a power source (stand-by-charge)

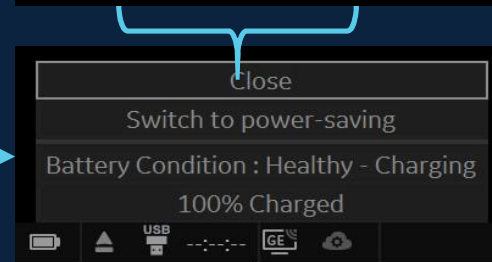

Scan on battery is an option on the LOGIQ Fortis.
LOGIQ Fortis is a trademark of GE.

Scan on battery

Large battery icon at the top of the monitor makes it easy for the user to see. The status updates in increments of 10% from 100-0%. Also will show when the AC power is plugged, and the battery is charging.

Small battery icon in the tool tray at the bottom of the monitor also updates the status from 100-0%. Icon will also show when the AC power is plugged in and the status of the charge. Select this icon to switch to battery saving mode.

Battery error icon. **NOTE: If this icon displays, do not initiate Power Assistant. Contact Service.**

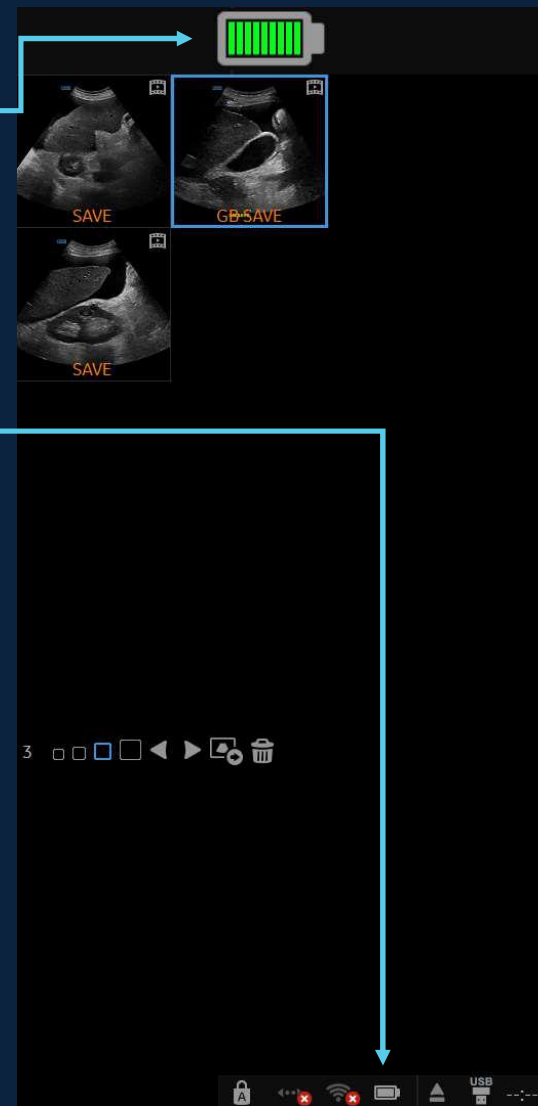
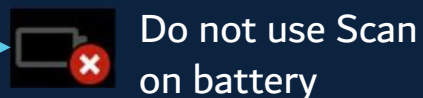
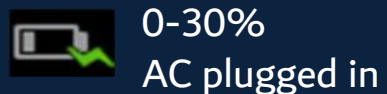
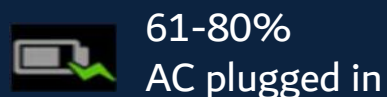
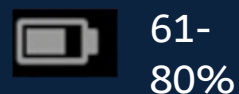
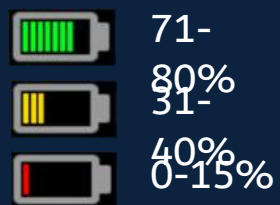

End to end workflow



Start Assistant



Highlights

Automatically launches the preferred setting when the user selects an exam description, reducing keystrokes and helping to ensure high quality imaging



Start Assistant



Current Workflow

- 1 Select Patient from Worklist
Auto Populate Exam Description
- 2 Select Exam Category Tab
- 3 Select Scan Assistant
- 4 Exit Patient Screen
- 5 Select Probe
- 6 Select Application

With Start Assistant

- 1 Select Patient from Worklist
Auto Populate Exam Description
Auto Select Exam Category Tab
Auto Select Scan Assistant
- 2 Exit Patient Screen
Auto Select Probe
Auto Select Application

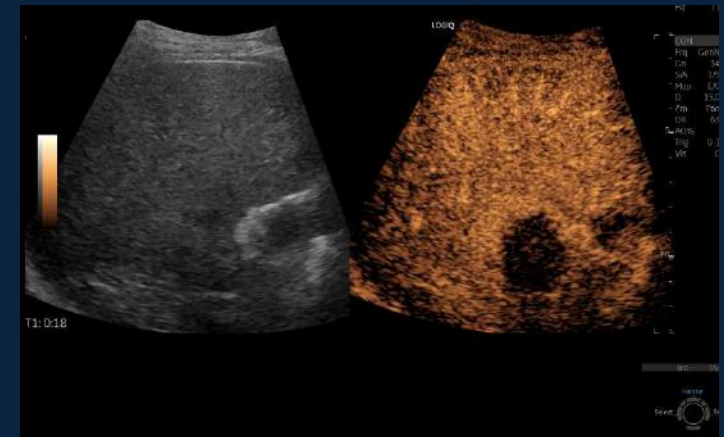
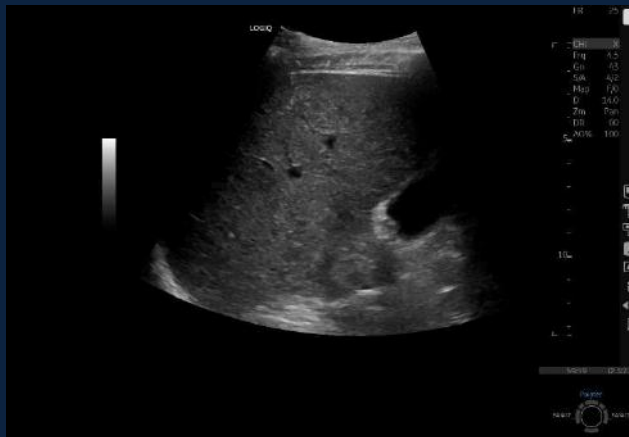

Image reordering



Highlights

- Acquire images in your preferred order
- Easily reorder images within the exam
- Send to radiologist in their preferred reading order



Easy access to PACS



Highlights

- Enables the console to receive exams from PACs in the background without interrupting workflow
- Easily pull images via Query Retrieve to console
- Operates both wired and wirelessly

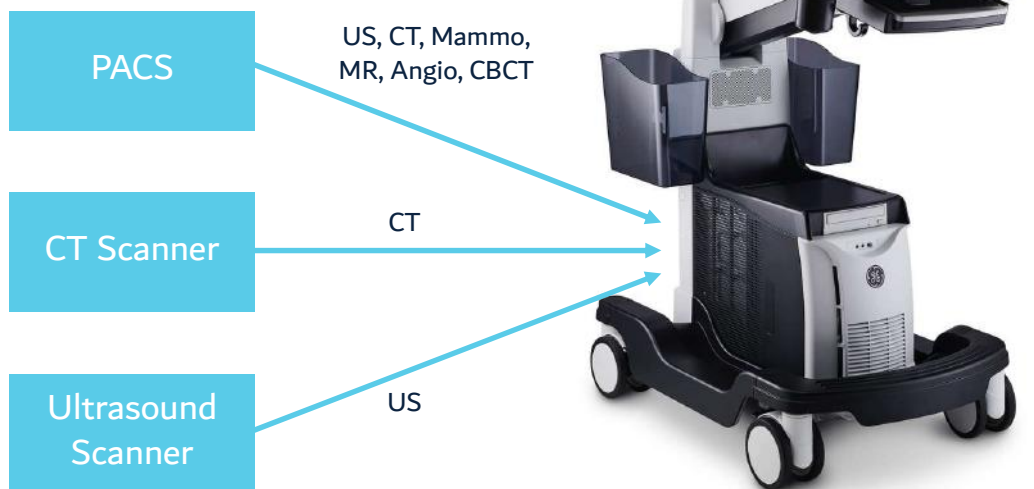

LOGIQ Fortis™ and Trice™ – Sharing ultrasound images



Clinical communication

- Ultrasound lab sends images, reports for consultation before referring the patient
- Ultrasound lab shares examination results for second opinion
- Ultrasound lab shares examination results with surgeon for treatment and surgery planning
- Sharing cases with medical community, accreditation support
- Routing of studies from remote sites

Doctor-patient communication

- Sharing exam results with patients

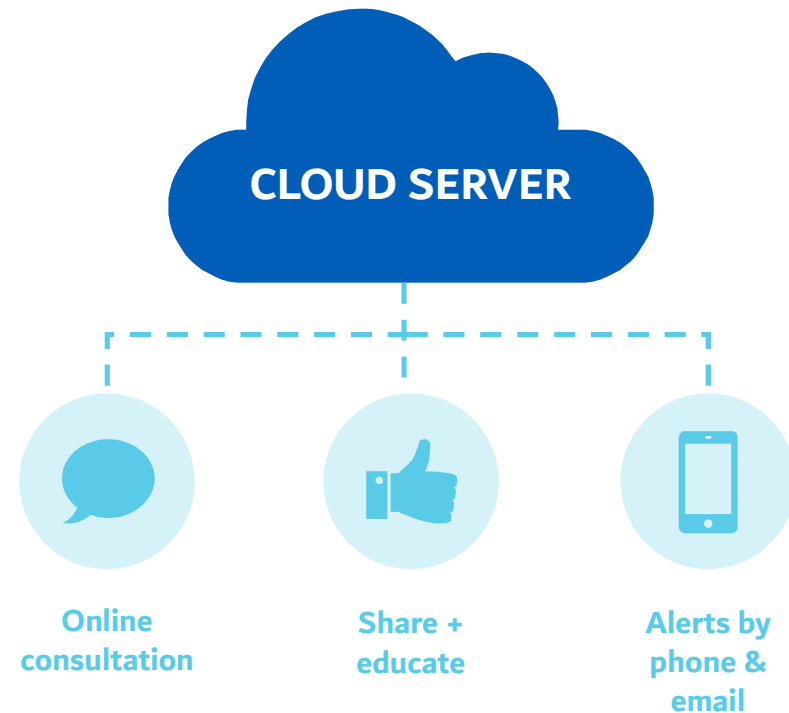

Patient image sharing via Trice™



Patient image sharing enables image clips and reports to be shared securely and instantly to patients. Patients simply receive a text message or e-mail with a link. Patients can then share the information with family and friends.



Cloud-based archiving



Cloud-based archiving enables exams to be securely archived and viewed from anywhere at any time on an internet-connected device. These exams can even be reloaded onto the scanner via DICOM® Q/R.



Collaboration



Collaboration allows easy and immediate sharing of the exam with referring physicians, colleagues, and other experts. Collaborators use internet-connected devices to view the exam data. Optionally, the exam data can be anonymized.



Next Gen Digital Platform

Cloud, Smart Devices & Machine Data

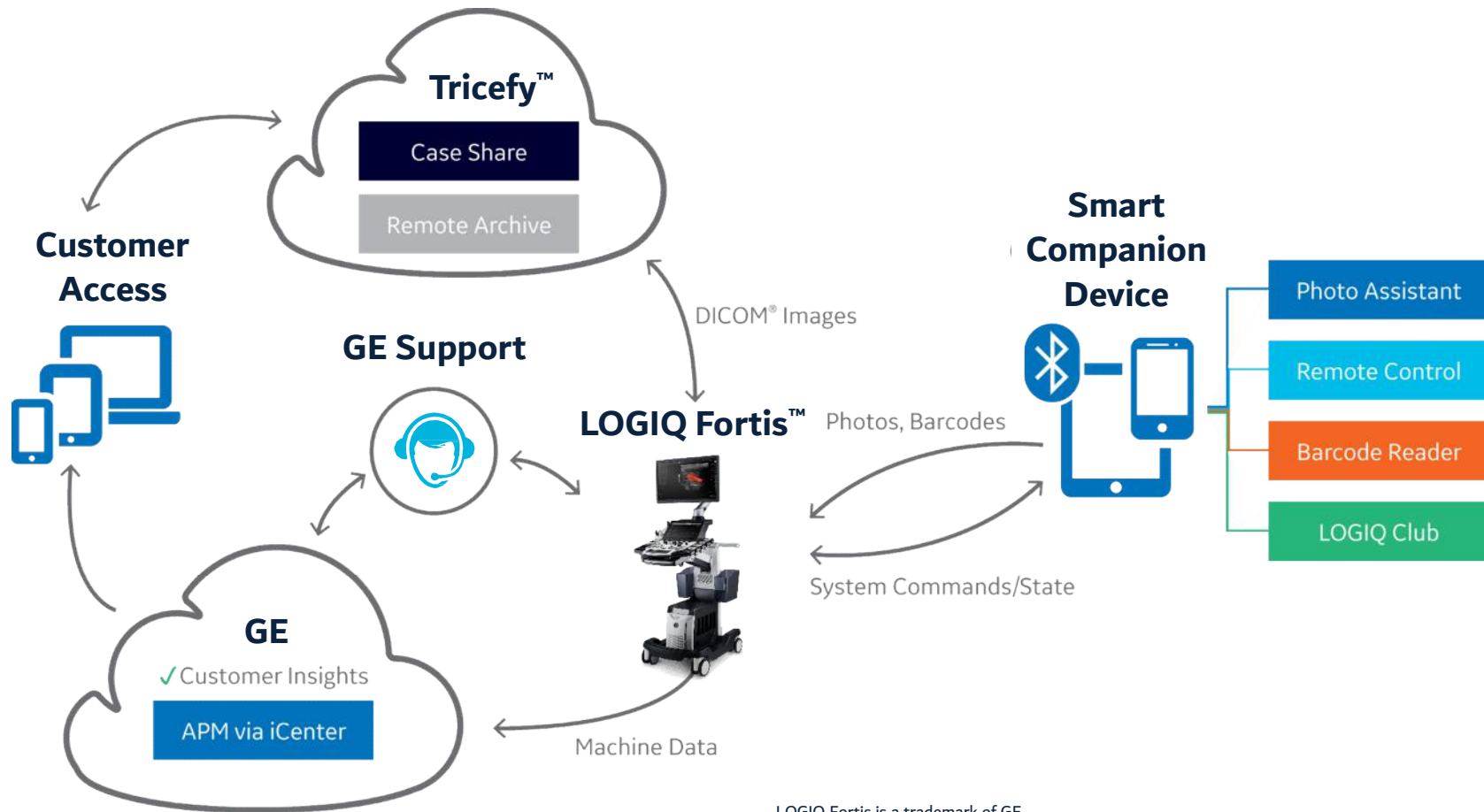

EZ Imaging Simplified touch panel



Highlights

- Customizable probe pre-sets
- Simplified touch panel to reduce operator interaction
- Quick patient set-up

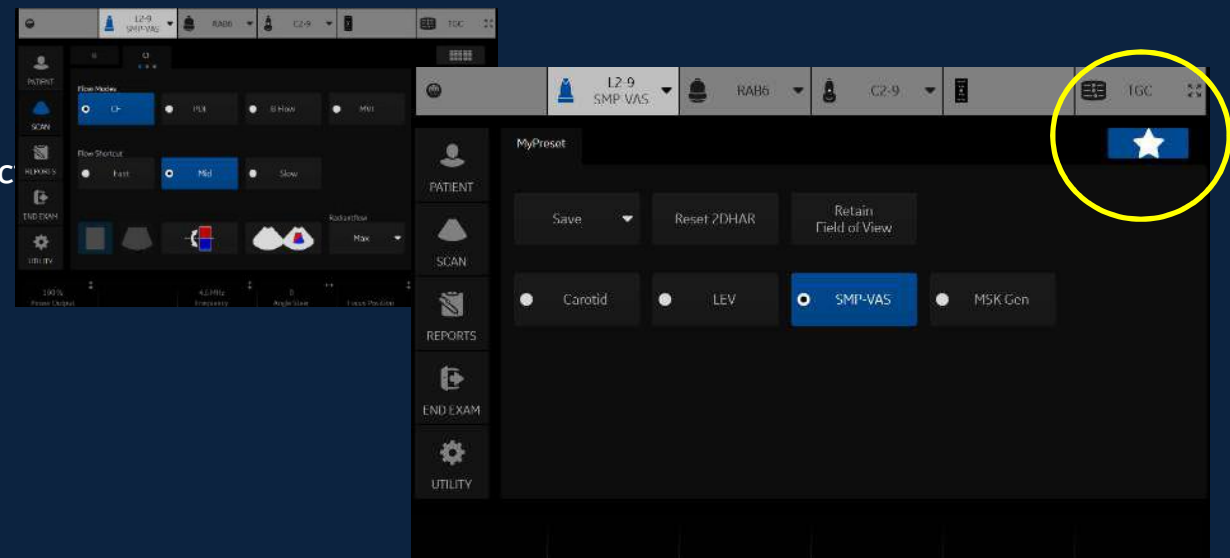

EZ Imaging

Simplified touch panel



Results that impact exams

- 33% reduction of keystroke time
- 40% reduction of keystroke steps
- Increased consistency among users

Users tell us

“I like that it is all on one page on the touch panel.”

Sonographer with 6 years experience, currently uses LOGIQ™ E10

“It’s more intuitive – it saves a lot of manual adjustments. It will result in a smoother, faster workflow with less button pushes.”

Sonographer with 28 years experience, currently uses LOGIQ E10 & Voluson™

“It would be quick to learn for current LOGIQ users and less steps once you transitioned, which would help with throughput.”

30 years experience, ultrasound manager, 2 years experience with LOGIQ E10

Hepatic Assistant

Simplifies liver workflow



Enables clinicians to combine 2D Shear Wave Elastography and Ultrasound-Guided Attenuation Parameter (UGAP) in a single exam with just the push of a button.

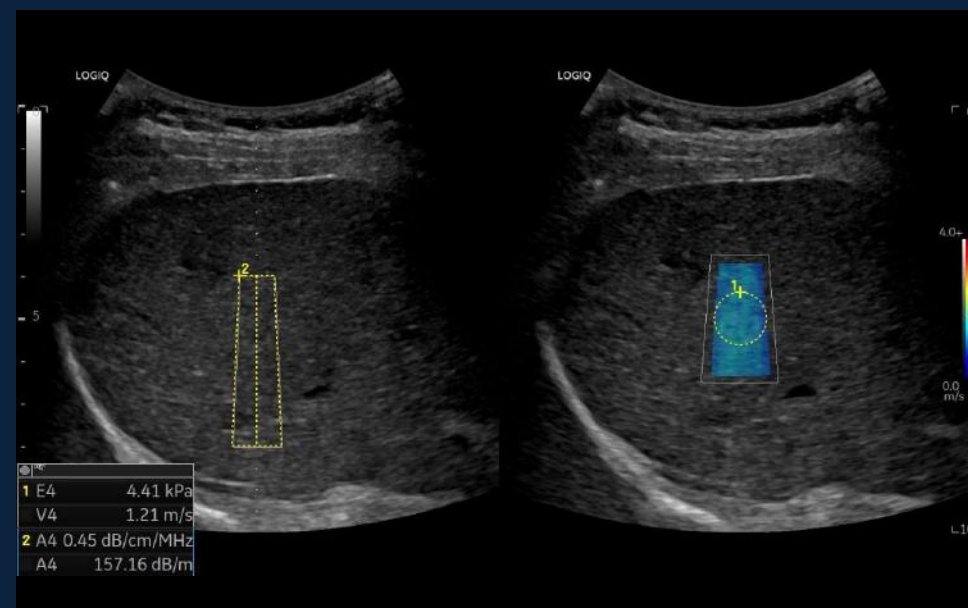

Hepatic Assistant UGAP and Shear Wave, C1-6-D

Flow Quantification



2D CFM/PDI Quantitative assessment of vascular feeding in a selected ROI. Can help in the assessment of inflammatory disease and vascular feeding of suspicious anatomical areas

Highlights

- Consistent, repeatable and objective measurement
- Can help in treatment planning and monitoring protocols
- Provides data to support outcome measurements

Features

- Up to 8 selectable ROIs
- Analysis over 4/5 heartbeat cycles
- Automatic or manual ROI tracing
- Save ROI feature for monitoring
- Manual disabling & enabling of frames
- Ability to export traces for offline analysis

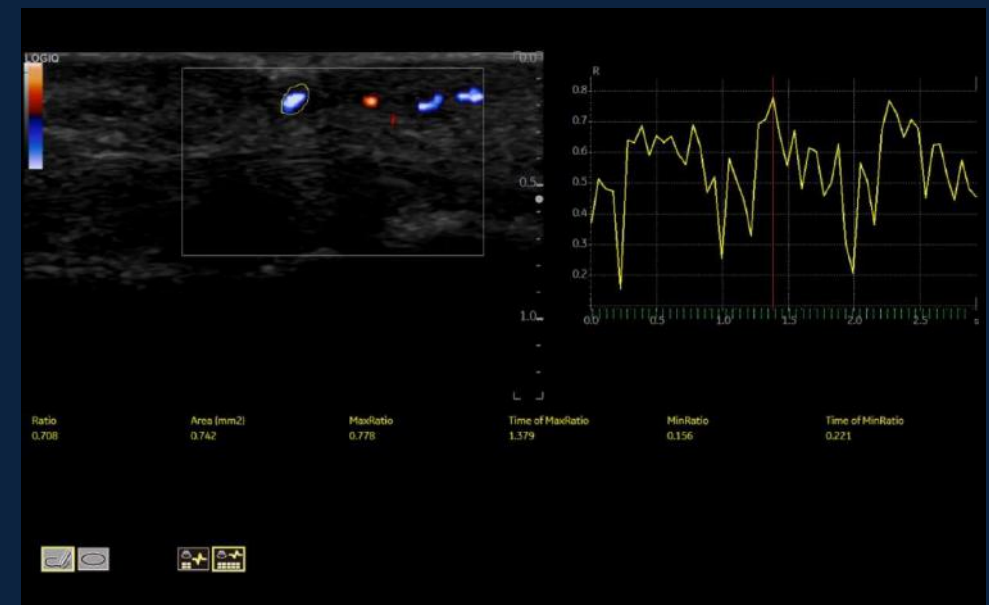

Finger Flow Quantification using PDI, L8-18i-D

Automatic IMT



Auto IMT is an automated method of measuring the intima media thickness of the CCA or ICA from multiple samples across a user defined length

- Simple and easy to operate
- Direct export of measurements to a worksheet and report page
- Including ECG trigger to help increase consistency and reliability
- Save offset distance and IMT measurement lengths to help increase reproducibility

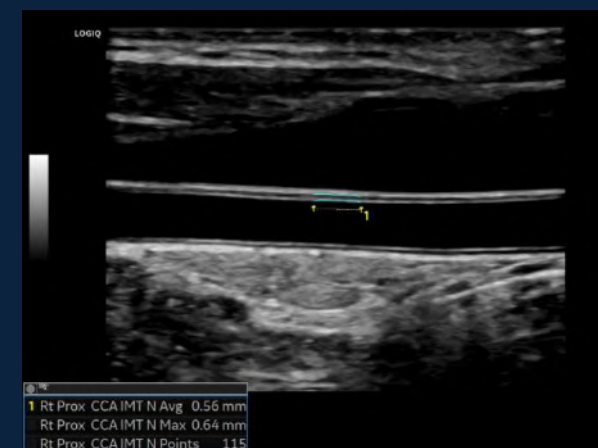

Carotid Intimal Measurements using Automatic IMT Tool for Both Near and Far Intima, L2-9-D

Auto EF



Automated Ejection Fraction (Auto EF) is a semi-automatic measurement tool used for global EF

- The Auto EF tool tracks and calculates the myocardial tissue deformation based on feature tracking on
- B-Mode cine loops
- Auto EF is performed on either one or both apical
- 4-chamber or 2-chamber views, in any order
- Result is presented as Ejection Fraction value for each view and average Ejection Fraction for the whole LV. All values are stored to the worksheet after the results are approved

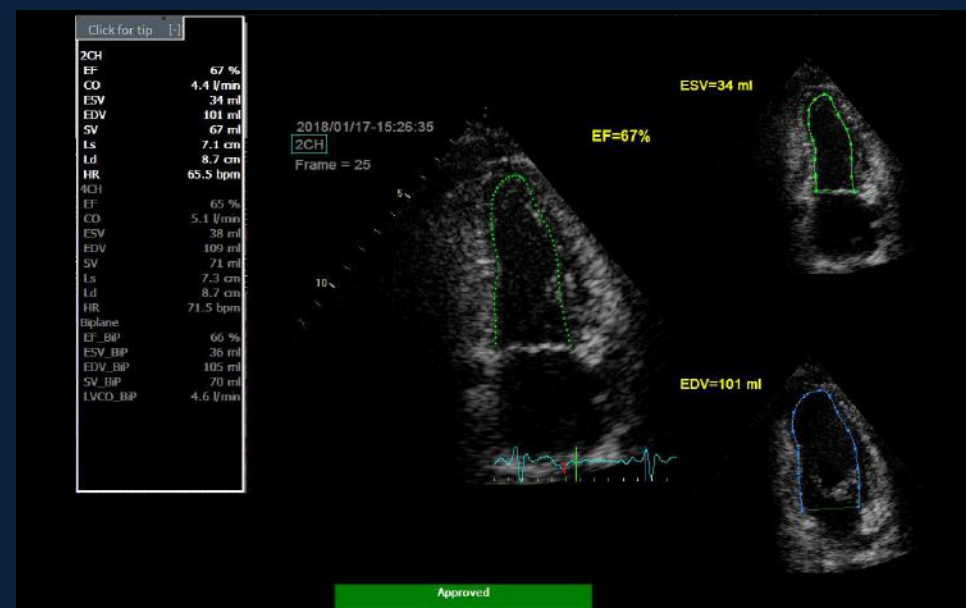

Auto EF Cardiac, M5Sc-D

Cardiac Strain



Access and quantify left ventricular wall motion at rest, calculating a large set of parameters

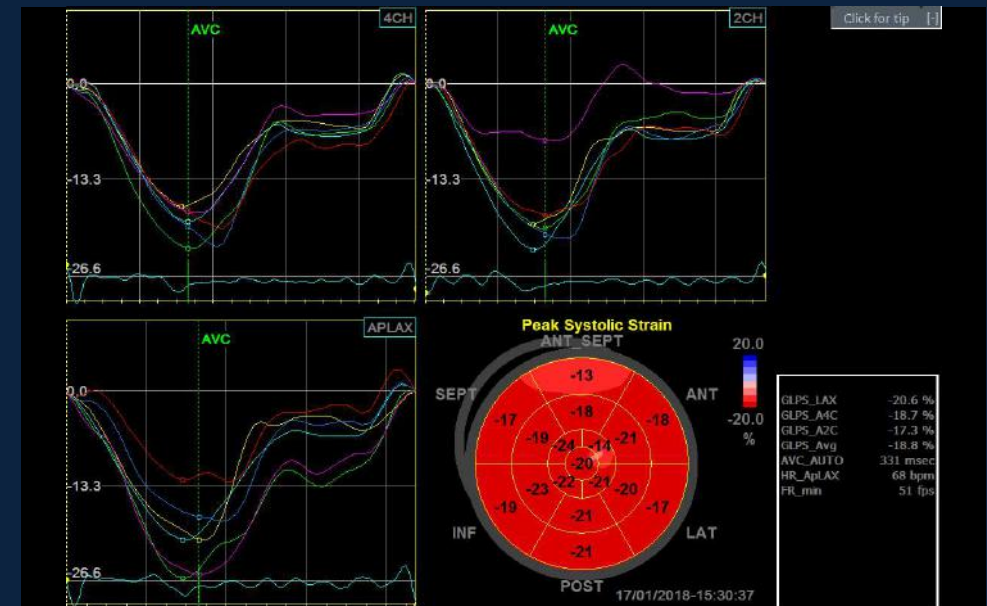

Cardiac Strain, M5Sc-D

3D/4D Ultrasound

STIC



Spatio-Temporal Image Correlation (STIC)
captures one fetal heart cycle in 3D cine.

Highlights

- Adjustable acquisition time
- Use with Color Doppler or Power Doppler modes
- 3D manipulation in A, B and C planes



Fetal Heart Acquired using STIC with Color Doppler, RAB6-D

Multi-modality Query Retrieve



One click Query/Retrieve

Query Retrieve puts an end to running back and forth to view previously acquired PET, MR, CT, mammography or ultrasound images.

This feature allows the user to retrieve any CT or MR volume dataset onto the system allowing the user to find the most relevant view of the anatomical area in the exam.



VIEW SIDE-BY-SIDE WITH REAL-TIME ULTRASOUND IMAGE SO YOU CAN QUICKLY GET TO AN AREA OF INTEREST

Raw data

The foundation for easy workflow



Raw data capture enables you to build a thorough exam while reducing scan time. This **proprietary raw data format** from GE Healthcare captures data earlier in the image processing chain enabling users to make changes to the data during or even after the exam has ended.

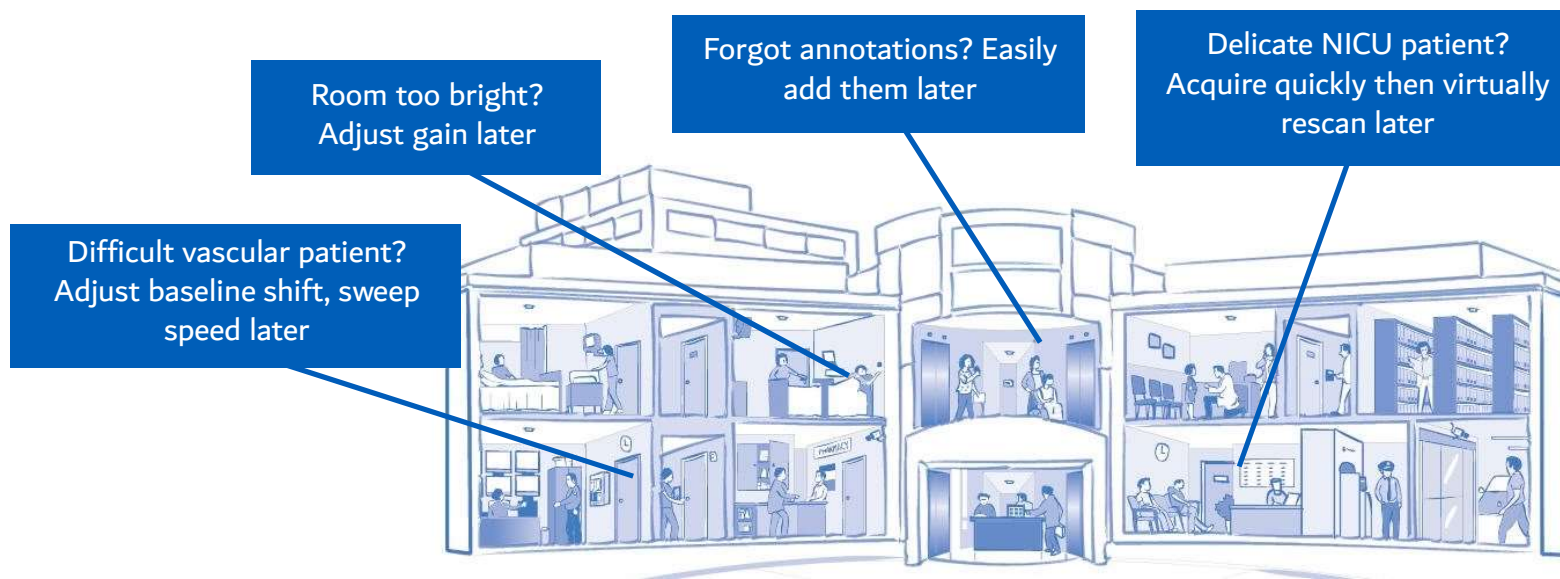

Raw Data Processing

Now with dual display

Original Acoustic Data are stored before scan converting in a GE “raw” format to be easily accessed and re-processed any time after the exam completion.

Highlights

- Sub-optimal studies can be optimized
- Measurements can be re-done and reports regenerated
- All Imaging control parameters can be changed as:
 - B-Mode: Gain, DR, AO, Zoom, SRI
 - CFM: Gain, Threshold, DualView, DR
 - PW: Baseline, Invert, Angle, DR, Gain

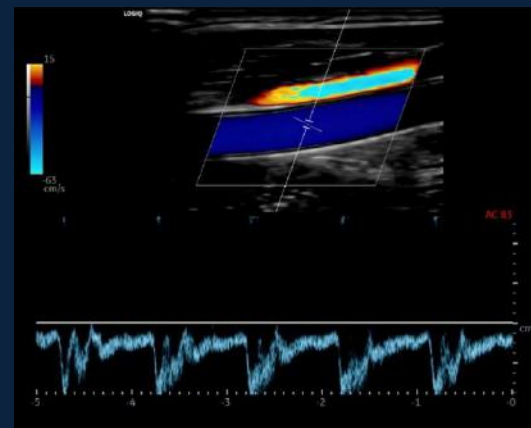

Carotid Doppler Raw Data Image Acquired with Incorrect Settings, L2-9-D

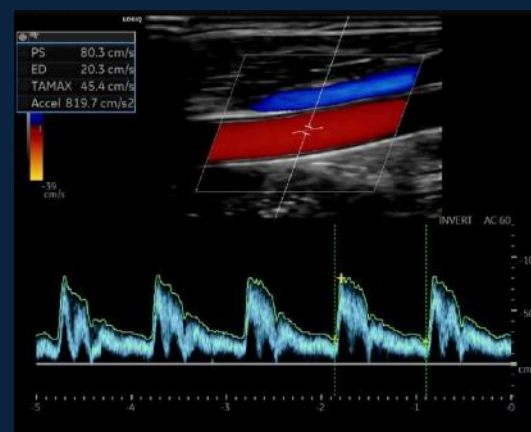

Same Raw Data Image of Carotid Doppler with Correct Settings Applied on Recalled Image, L2-9-D



— MAXIMIZING Your Investment

Maximizing your investment



Make the most out of your ultrasound investment with the GE LOGIQ Fortis™. Powered by GE Healthcare's next generation architecture and platform, the cSound™ Architecture and the A to A Digital platform, and sleek enough to move to patients, it's the system needed across your facility. New users can count on the LOGIQ™ Club to ensure quick training and ongoing support while hospital administrators can monitor utilization and performance through expert digital tools such as the probe health check and on-demand support. With constant coverage for the life of the system and access to technology updates, the LOGIQ Fortis maximizes your ultrasound investment today and into the future.



LOGIQ Fortis™: Powerfully streamlined

Next generation, multi-purpose ultrasound



Key challenges

- Wide range of clinical applications
- Wide range of body habitus
- Wide range of patient ages
- High BMI patients, frequently
- Labor intensive & technically
- Challenging cases
- Visualize small details
- Accuracy
- Speed

GE solutions

- Designed to accommodate infrequent and uncommon studies
- cSound™ Architecture
- A to A Digital Platform
- Portability
- B-Flow & Hybrid B-Flow imaging
- Radiant*flow*™ & MVI imaging
- LOGIQ™ Apps for Photo Assistant & Remote Control
- Hepatic Assistant: 2D Shear Wave Elastography & UGAP
- Volume Navigation
- Cardiac Strain, Auto EF & Auto IMT
- OmniView & VCI OmniView; HD*live*™ rendering
- AI-based tools
- Productivity & measurement packages
- Raw Data
- Intuitive operation
- Cleanability
- Service and support



LOGIQ Fortis Presentation

LOGIQ Fortis, cSound, Radiant*flow*, LOGIQ, and HD*live* are trademarks of GE.

LOGIQ Fortis™: Powerfully streamlined

Next generation, multi-purpose ultrasound

Key challenges

- Wide range of clinical applications
- Wide range of body habitus
- Wide range of patient ages
- High BMI patients, frequently
- Labor intensive & technically challenging cases
- Visualize small details
- Accuracy
- Speed

GE solutions

- Designed to accommodate infrequent and uncommon studies
- cSound™ Architecture
- A to A Digital Platform
- Portability
- B-Flow & Hybrid B-Flow imaging
- Radiant*flow*™ & MVI imaging
- LOGIQ™ apps for Photo Assistant & Remote Control
- Hepatic Assistant: 2D Shear Wave Elastography & UGAP
- Volume Navigation
- Cardiac Strain, Auto EF & Auto IMT
- OmniView & VCI OmniView; HD*live*™ rendering
- AI-based tools
- Productivity & measurement packages
- Raw Data
- Intuitive operation
- Cleanability
- Service and support



AI & Digital Snapshot

Technology evolves



CALLING DEVICES

Technology revolutionizes



Ultrasound technology evolves



ULTRASOUND SCANNERS

Ultrasound revolutionizes

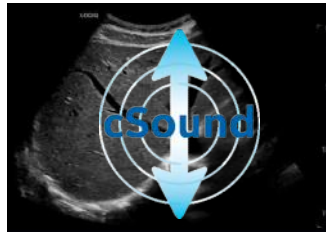

Even typical in focus
Imageforming

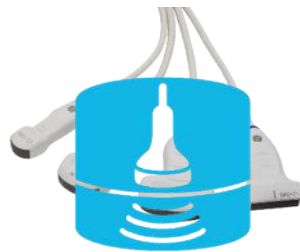

XDclear™ probes for high definition
and deep penetration
Probe Technology

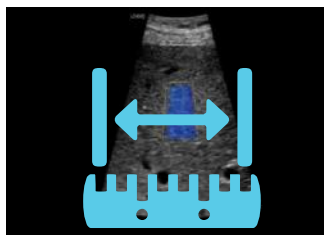

2D Shear Wave Elastography
Quantification Tools

XDclear and LOGIQ are trademarks of GE.

LOGIQ Fortis Presentation



LOGIQ™ Photo Assistant
Smart Device Connectivity



Analytics
Data Driven Decisions

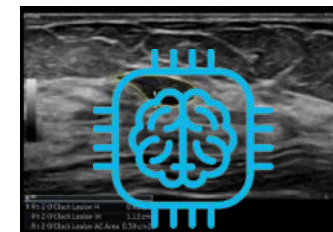

Automated Lesion Segmentation
Artificial Intelligence (AI)



LOGIQ Fortis™: An ultrasound system for today...



...a platform for tomorrow.

cSound™
Next Gen Imaging
Architecture

A to A
Next Gen Digital
Platform

cSound™ Architecture

Combines the power of XDclear™ probes with a new cSound Imageformer to enable confident diagnosis, comprehensive tools and concise workflow

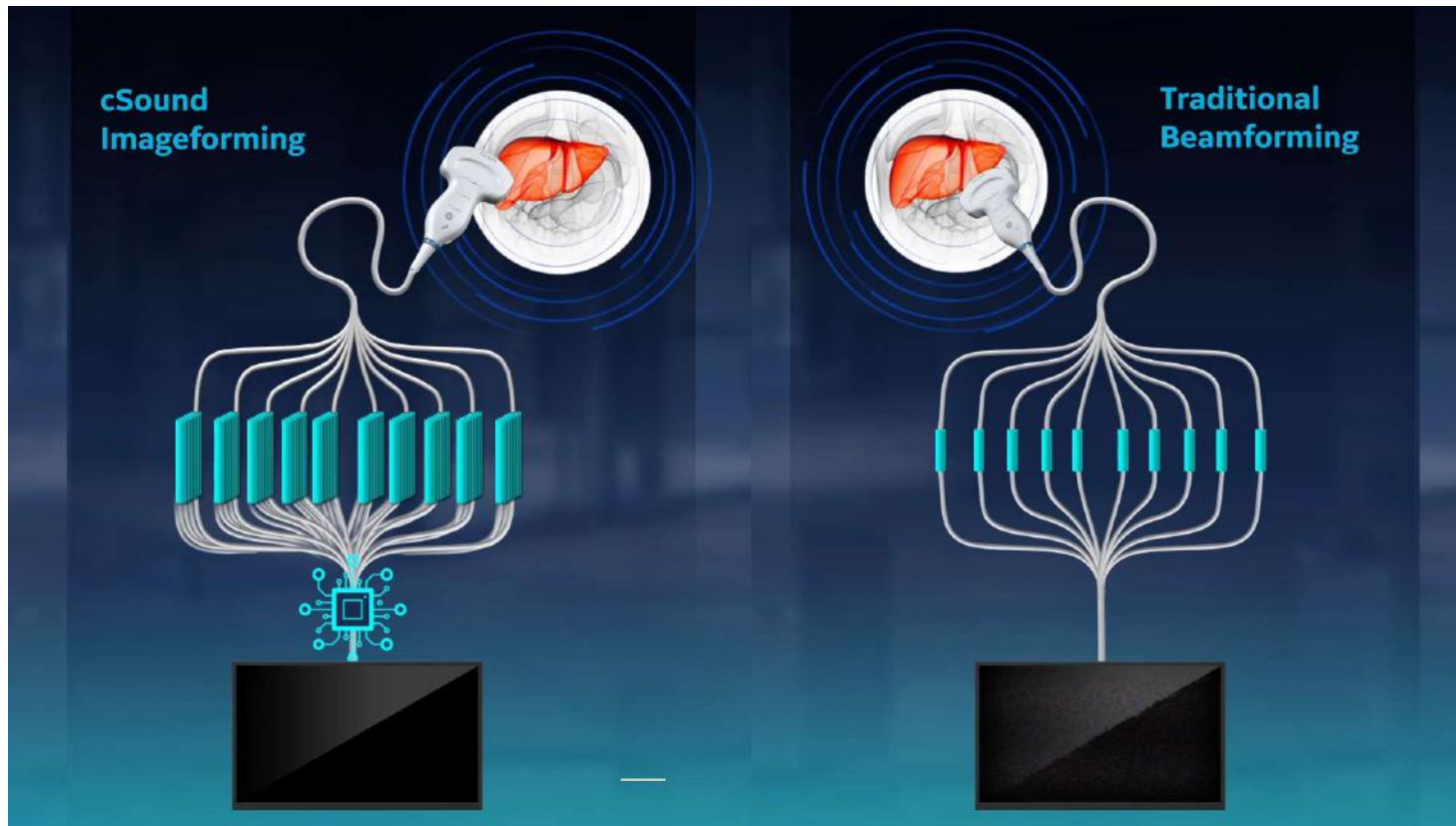

A to A digital platform

Enabling the Intelligent Digital Assistant



AWARENESS



ASSISTANCE



App Assistant

Aware of the digital world around the ultrasound system, including **smart devices** and **cloud** technology

Assist the user with **new clinical and/or workflow improvements**



Remotely operate the scanner via LOGIQ™ apps



Analytics Assistant

Aware of **big data** that is being generated each time the user interacts with the system

Assist by identifying **actionable insights from data analytics**



Receive system utilization reports to make data driven decisions



Anatomical Assistant

Using **Artificial Intelligence (AI)** to make the scanner aware of what is being scanned as it being scanned

Provide anatomically based assistance to the user for **enhanced workflow and decision support**



Automatically segment lesions

cSound™ Next Gen Imaging Architecture

A to A Next Gen Digital Platform



10x processing power

Smart device compatibility

Same **technology** used for next gen gaming

Generate **big data** and deploy deep learning

48x data throughput

AI for decision support connectivity





— A to A Digital Platform

Next Gen Imaging System cSound™ Architecture

Next Gen Digital Platform A to A (Awareness to Assistance)



10x processing power

Same **technology** used
for driverless cars and next
gen gaming

48x data throughput

Smart device compatibility

Cloud connectivity

Generate **big data** and
deploy deep learning



The vision... The Intelligent Digital Assistant

Knowing *what* you are scanning *as* you are scanning and fully leveraging the digital ecosystem



A to A Digital Platform

Enabled by:

- Digital platform
 - Systematic big data collection
 - Smart device compatibility
 - Cloud connectivity
 - GPU-based AI inference engine
- Position sensing built into probes
- AI-driven anatomical awareness

Onboard now:

- Photo Assistant app
- Remote app
- Case sharing

Digital Ecosystem



- Smart device apps
- Cloud services
- Big data storage
- Analytics tools



Intelligent Digital Assistant

Cloud connectivity and services



Smart device compatibility and apps



AI on board

- Anatomical awareness
- Decision support



Big Data analytics: Machine and image data



MACHINE AWARENESS LEADING TO NEXT GEN USER ASSISTANCE

A to A Digital Platform

Awareness to Assistance



App Assistant

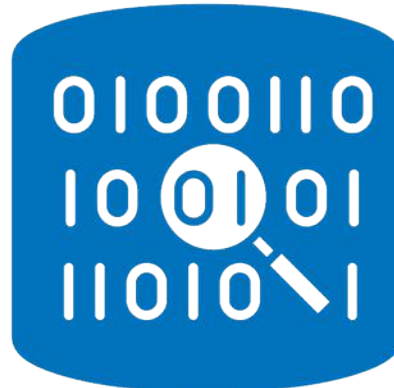

Analytics Assistant

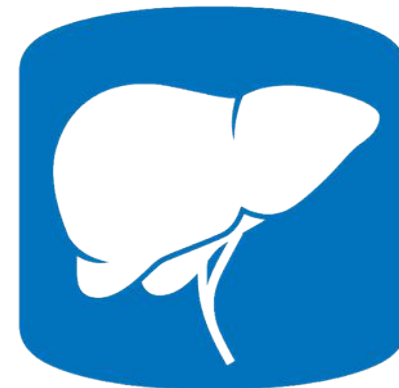

Anatomical Assistant

App Assistant

A to A Digital Platform



Awareness



Assistance

Aware of the digital world around the ultrasound system, including **smart devices** and **cloud** technology

Assist the user with new clinical and/or workflow functionality

Photo Assistant app



Take a photo with your smart device and have it become part of the ultrasound exam, including side-by-side with an actual ultrasound image



Remote Control app



Remotely operate the system from tablet or phone that has LOGIQ™ Smart App loaded

- Focused on ergonomics
- Includes:
 - Major modes
 - Freeze/print
 - Depth
 - Gain
 - ROI placement
 - Dual image



Analytics Assistant

A to A Digital Platform



Awareness



Assistance

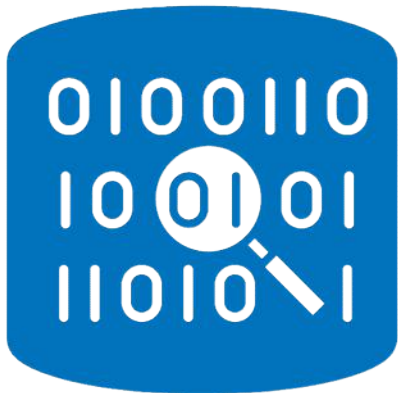

Aware of **big data** that is being generated each time the user interacts with the system

Assist by identifying actionable insights from utilization data analytics

Maintenance Assistance with System Health Dashboard*

Secure online access for administrators to monitor exam types, volume, time, and more*

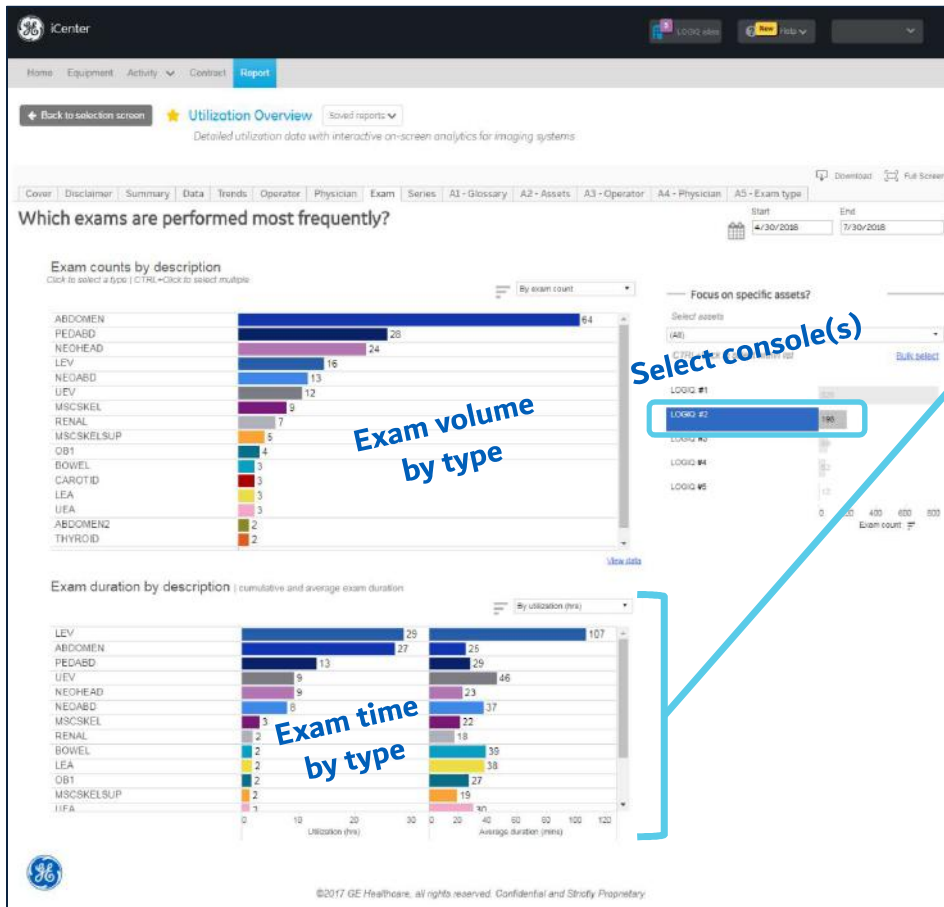

EXAMPLE:

- Are LEV exams taking too long on this console?
- Do I need Scan Assistant to reduce exam times?
- See more at

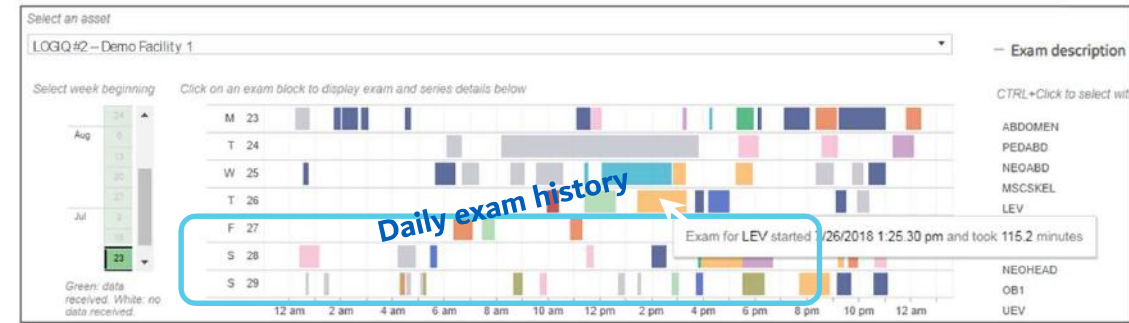
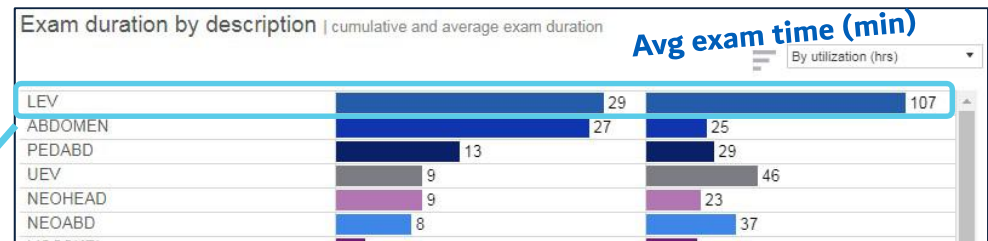

LOGIQ Fortis™ System Health Dashboard*



Visual status of key subsystems, intelligent alerts, and click-through details make it easier to manage preventative and corrective maintenance for qualified users. Includes new diagnostics for connected probes that run in air (no probe manipulation).

Dashboard features are enabled remotely and are included with proprietary service license (offered with In House support contracts).

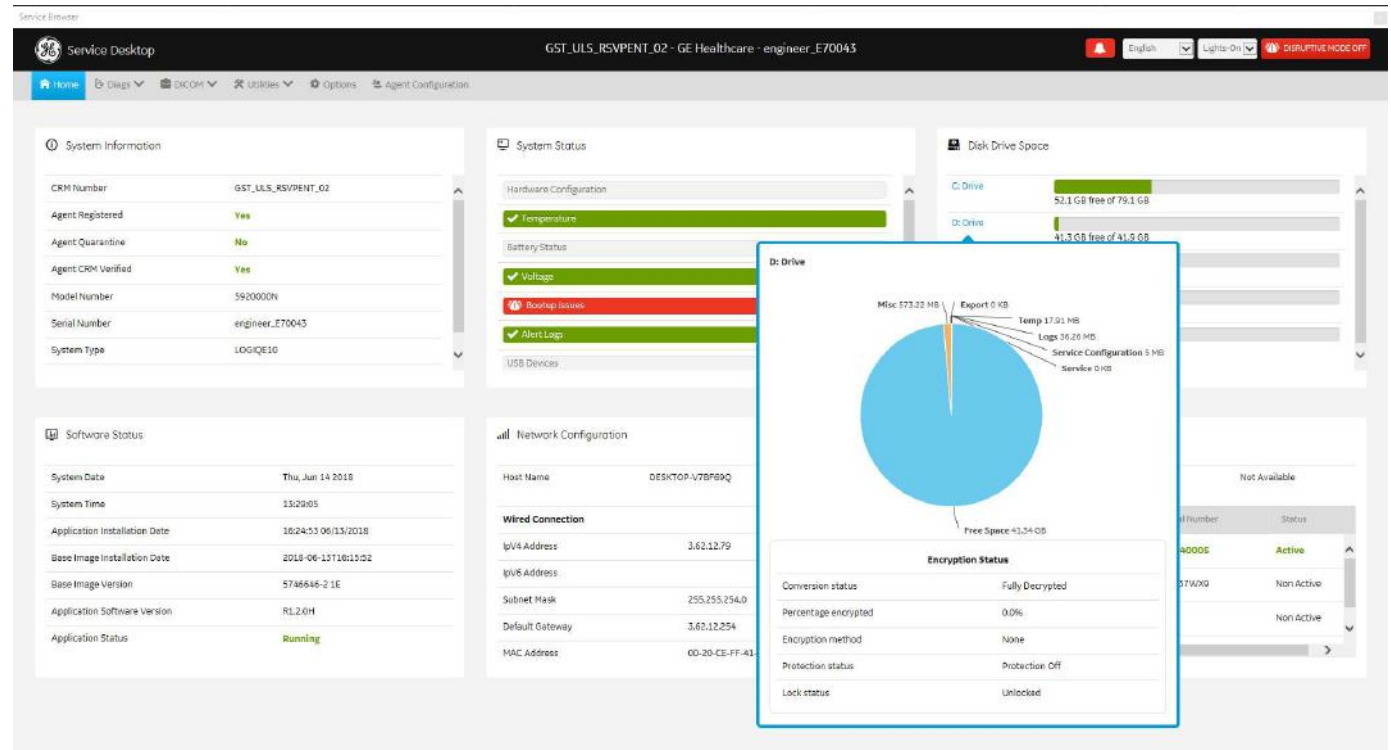

INTELLIGENT VISUAL DIAGNOSTICS SIMPLIFY MAINTENANCE AND IMPROVE UPTIME

Anatomical Assistant

A to A Digital Platform

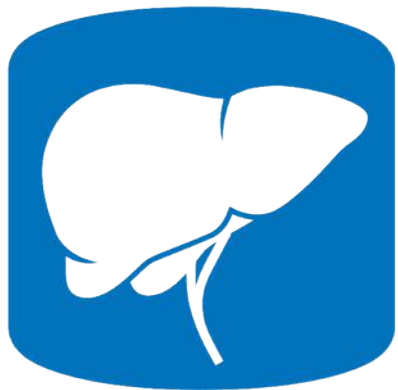

Awareness



Assistance

Using **machine learning** to make the scanner aware of what is being scanned as it being scanned

Provide anatomically based assistance to the user for enhanced workflow and decision support

Surgical Assistant

By knowing what is going on at a similar level to the surgeon, the surgical assistant...

Anticipates what is next

Serves as another set of eyes

Awareness



Powered By
Edison



The **surgeon** gets...

Workflow enhancement

Decision support

Assistance

A to A Digital Platform

Anatomical Assistant

By knowing what is going on at a similar level to the sonographer, the anatomical assistant...

Anticipates what is next

Serves as another set of eyes

Awareness



Powered By
Edison



The **sonographer** gets...

Workflow enhancement

Decision support

Assistance

A to A Digital Platform

Artificial Intelligence

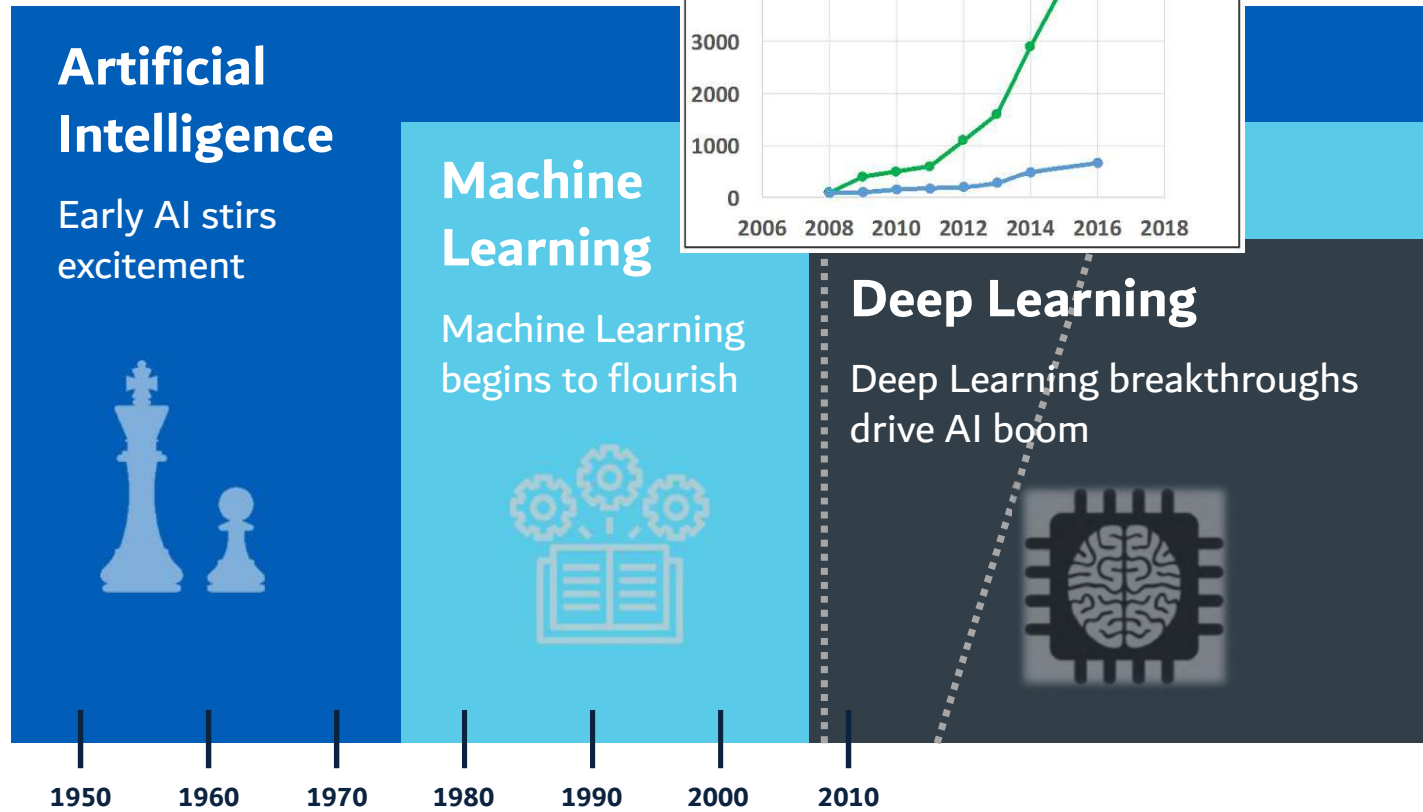

AI – Intelligence demonstrated by machines

ML – Machines discover the rules for performing a task

DL – ML where the rules are represented by an artificial neural network inspired by the human brain's neural networks

ML & DL ARE PARTICULARLY WELL SUITED TO PERFORM CLASSIFICATION AND DETECTION

Forms of anatomical awareness

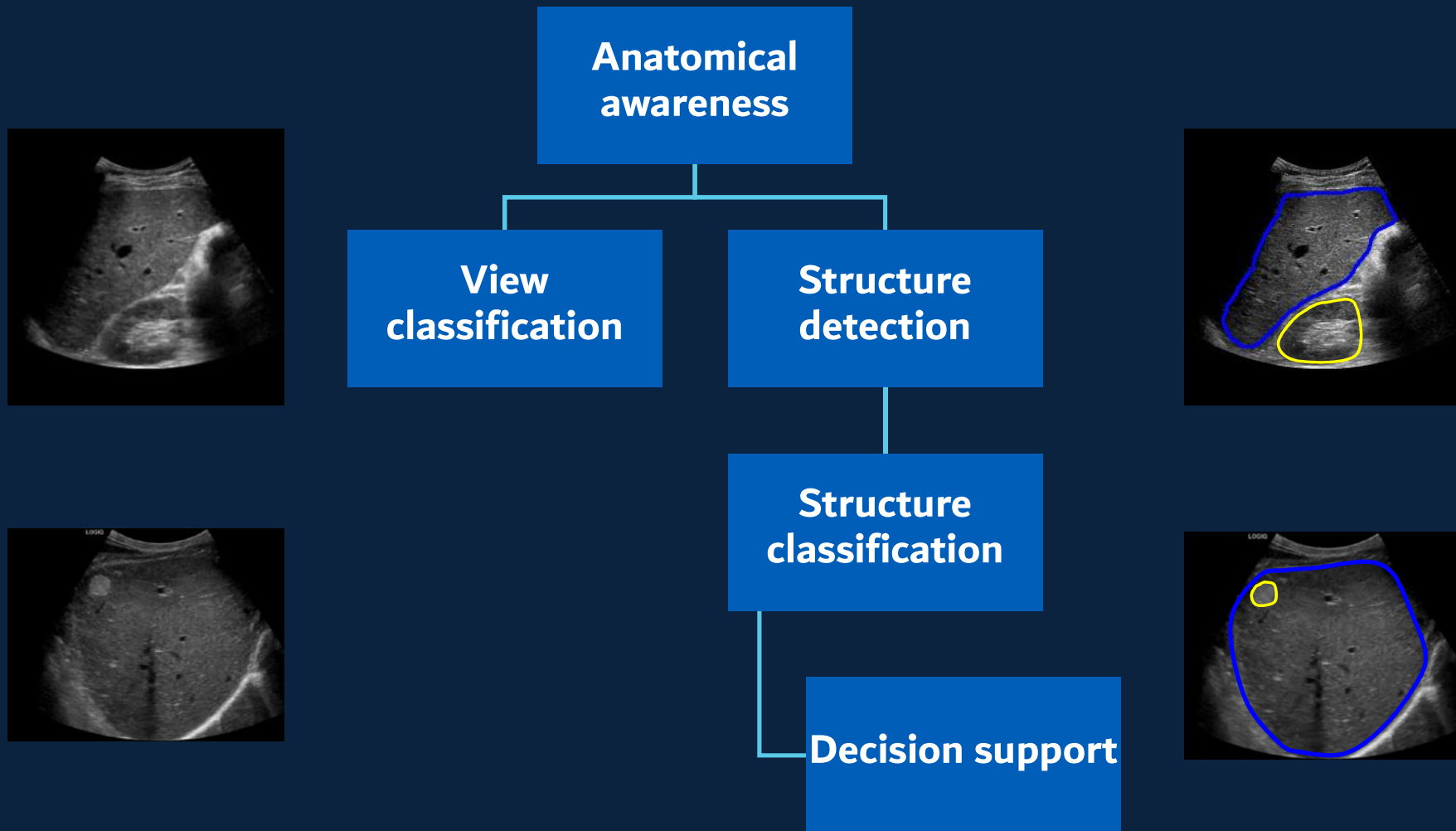

Anatomical Assistant today



Doppler Assistant

- Manual view classification
- Automated structure detection

Automated Lesion Segmentation

- Manual view classification
- Semi-automated structure detection

OB Measure Assistant

- Manual view classification
- Automated structure detection

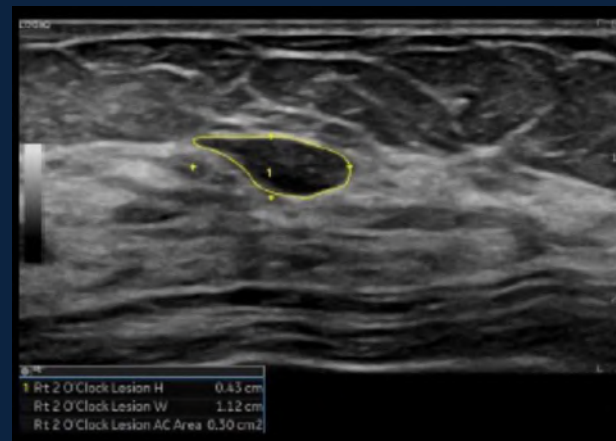
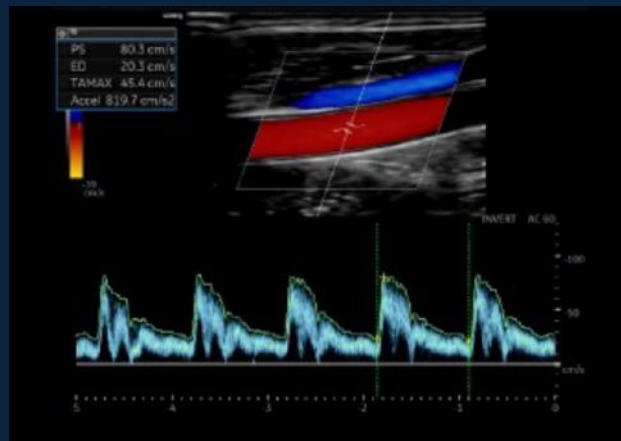

Enhancing user productivity and experience over time

The journey to AI: Doppler Assistant

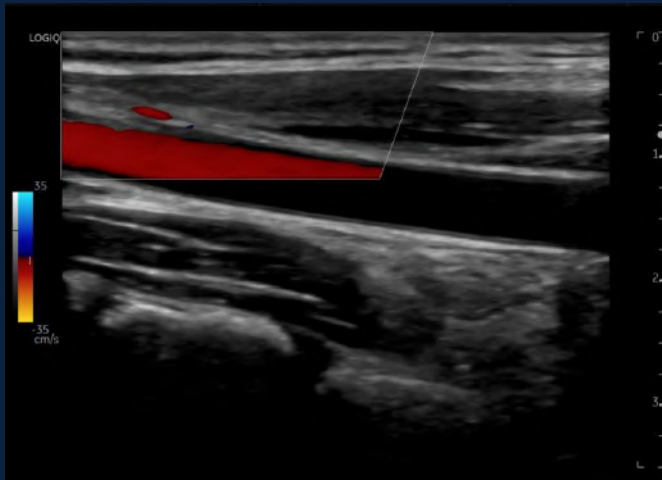

User guides system to the vasculature of interest and pushes a button

Benefit: Users scan as they normally would and control initiation of the algorithm

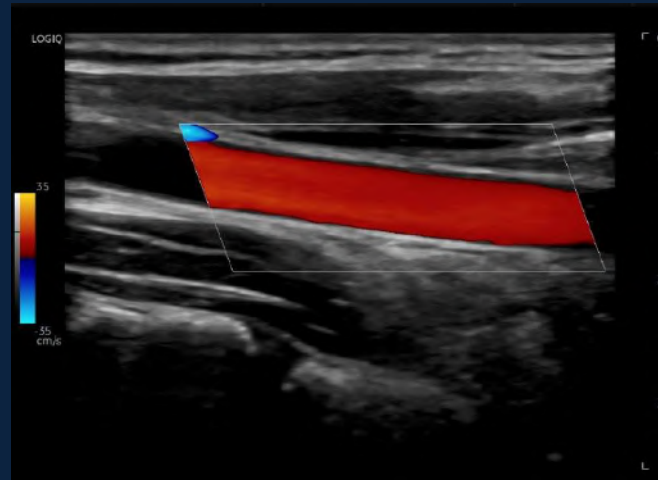

Doppler Assistant determines the location and direction of vessels

Benefit: Keystrokes are reduced as the color ROI and Doppler gate are automatically placed

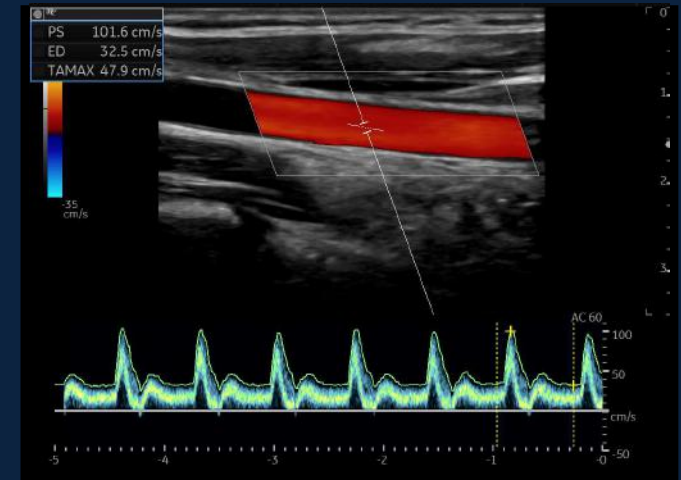

The system knows the difference between veins and arteries to make exam-specific decisions

Benefit: Results are appropriate for venous versus arterial exams even when both types of vessels are present

MANUAL VIEW CLASSIFICATION

AUTOMATED STRUCTURE DETECTION & CLASSIFICATION

Enhancing user productivity and experience over time

The journey to AI: Automated Lesion Segmentation

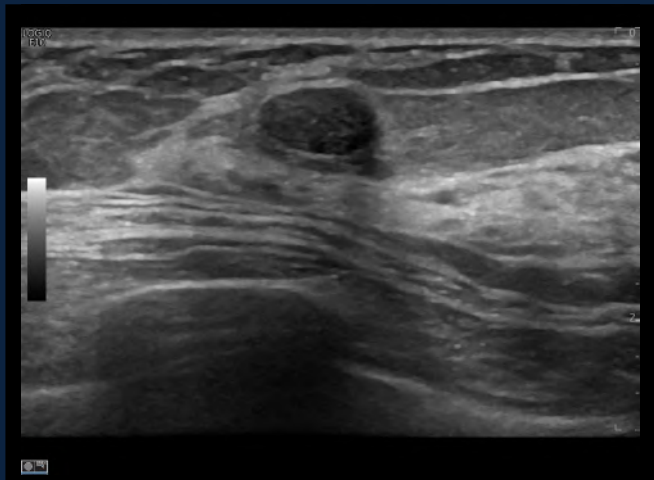

User identifies a breast, thyroid or liver lesion

Benefit: Users scan as they normally would

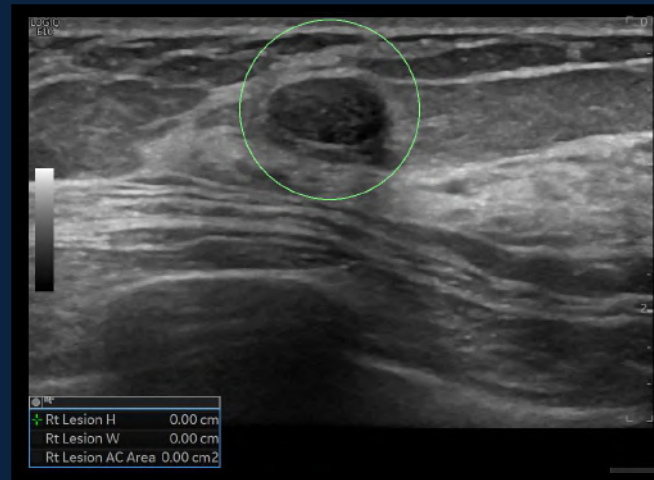

User clicks on the lesion and simply expands a graphical circle to encompass it

Benefit: User identifies a lesion with a single click

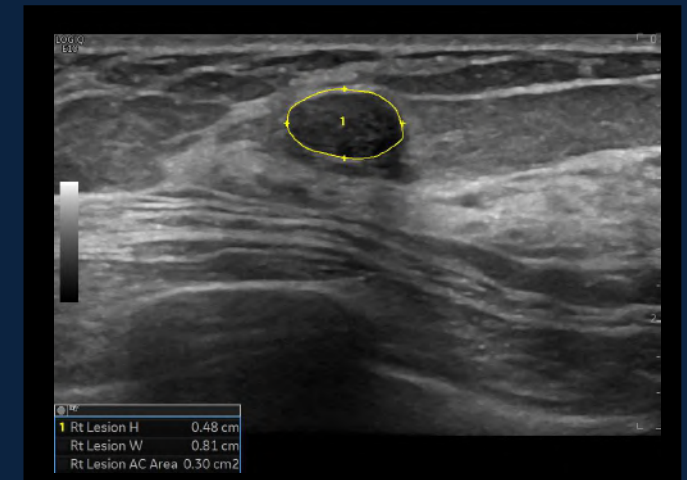

The algorithm segments the lesion, providing a trace and extents of the lesion

Benefit: Calipers are automatically placed to measure the lesion, saving keystrokes and providing consistency

MANUAL VIEW CLASSIFICATION

SEMI-AUTOMATED STRUCTURE DETECTION

Enhancing user productivity and experience over time

The journey to AI: Auto OB Assistant



User identifies a view appropriate for measuring the BPD, HC, AC or FL and initiates a measurement

Benefit: Users scan and initiates a measurement as they normally would



Auto OB Assistant automatically segments out the appropriate structure from the image

Benefit: Measurement is automatically performed, saving keystrokes and providing consistency



The measurement result and associated fetal age is presented to the user

Benefit: Results presented to the user without extra steps

MANUAL VIEW CLASSIFICATION

AUTOMATED STRUCTURE DETECTION AND RESULTS

What if I could tell where I am on a map?

GPS – Location awareness



The obvious

Aid for navigation... a smarter map!

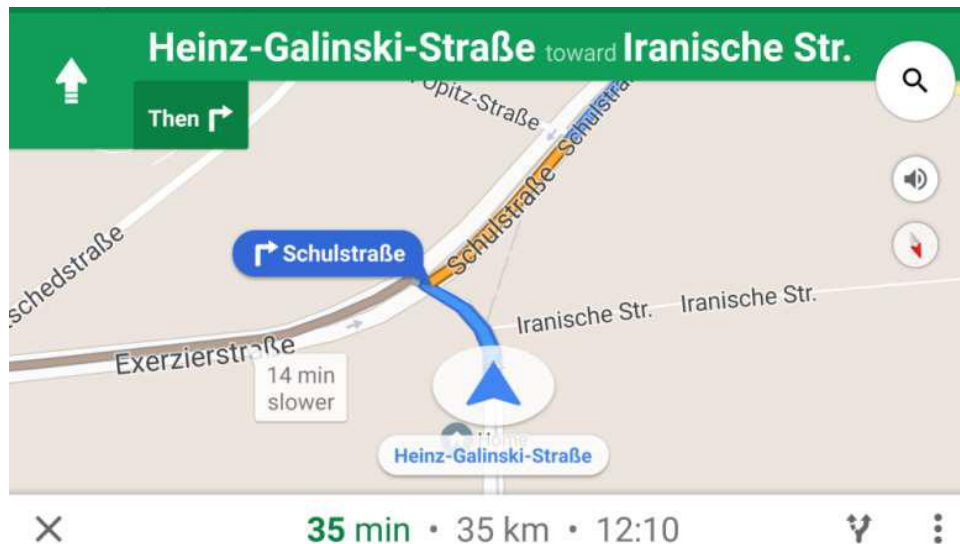

The not so obvious

- Runners track workouts
- Researchers track wildlife
- Caregivers track dementia patients
- People locate other people in close proximity
- Access to real-time traffic information

...

What if an ultrasound machine could tell what you are scanning?

Anatomical Awareness



The obvious

- Automated image labelling
- Automated measurements
- Auto optimization of scan parameters
- Auto place scanning ROI's
- Classify a lesion based on likelihood of being malignant or benign

The not so obvious

- We don't know what we don't know
- These are incredibly exciting times for those who love ultrasound

AI feature development

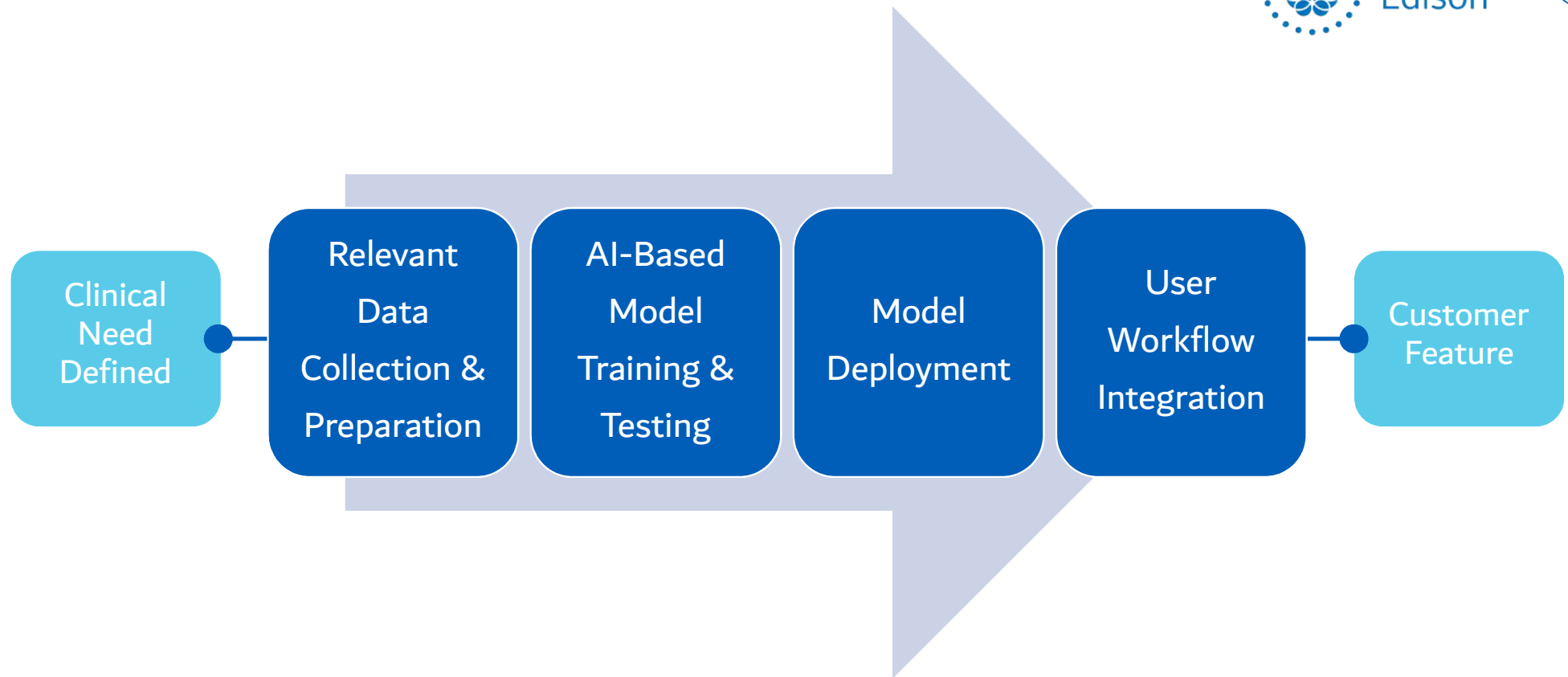

EDISON IS GE HEALTHCARE'S INTELLIGENCE OFFERING COMPRISED OF APPLICATIONS AND SMART DEVICES

Machine Intelligence – The LOGIQ Fortis™ Digital Platform



- **Lesion segmentation:** Liver, breast & thyroid
- **Doppler Assist:** Vessel recognition for automated ROI placement and steering
- **Auto OB:** Automated fetal structure detection and measurement

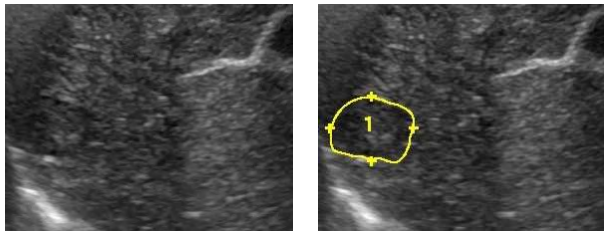

Existing features and future features

Deployment infrastructure

- Software access to RF data
- High end NVIDIA GPU
- Real-time inference engine
- Cloud connectivity

Data collection engine

- Machine logs
- Never identifiable images
- Cloud-based image collection w/anonymization



An ultrasound system for today...



...a platform for tomorrow.

**Next Gen
cSound™ Architecture**

**Next Gen
A to A Digital Platform**

Privacy & security



Purpose

- Keep the machine functional in the face of cyber threats
- Protect the patient data on the machine from unauthorized access
- Enable you to successfully implement their HIPPA and security policies and still manage your daily workflow

SonoDefense solution



Defense-in-depth strategy

SonoDefense is designed for maximum security protection with a defense-in-depth strategy that incorporates security controls deployed in multiple layers. This approach enhances security by protecting the system against any particular attack using several independent methods.

Limits what can be run on the LOGIQ Fortis™

- Customizable, role-based access
- Federated Identity Management
- Session management
- Auditing
- Secure remote access

- Customizable patient data encryption
- Enterprise wireless encryption
- IPv6 Internet Protocol address standard

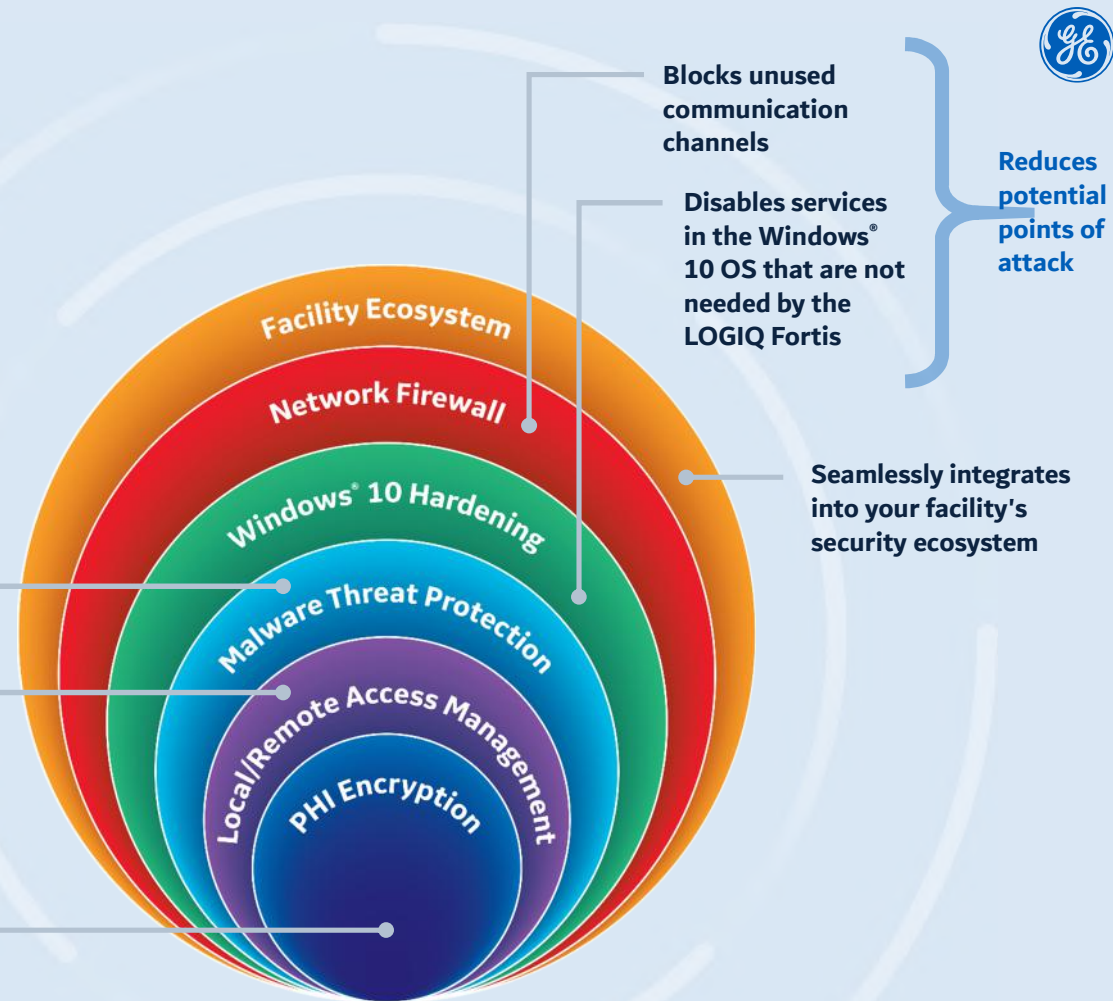

Ultrasound Lifecycle Solutions

How can the GE ultrasound ecosystem of solutions support you in your daily practice?



Education



Care &
Hygiene



Support



Insurance



Evolution



Security



Patient Report
Management



Fleet
Performance
Management





INSURANCE

Different solutions to meet your needs

Get peace of mind & optimize your investment

Thanks to a comprehensive range of services to meet your operational and financial goals

**From annual preventive maintenance to
full-service contract**

Our services agreement are flexible to allow you to tailor it to your organizational needs and priorities.



SUPPORT

Expert Live Support

Unlimited* remote access to our **technical and clinical** experts

How to contact us?



- Service center: number in the STAR app



- STAR: augmented reality mobile app for console education with an access to our experts



- Directly on your ultrasound system with the button « Contact GE » located at the bottom of your screen

To benefit the best from this offer, the ultrasound system needs to be connected to GE back-office.

** Depending on the countries*

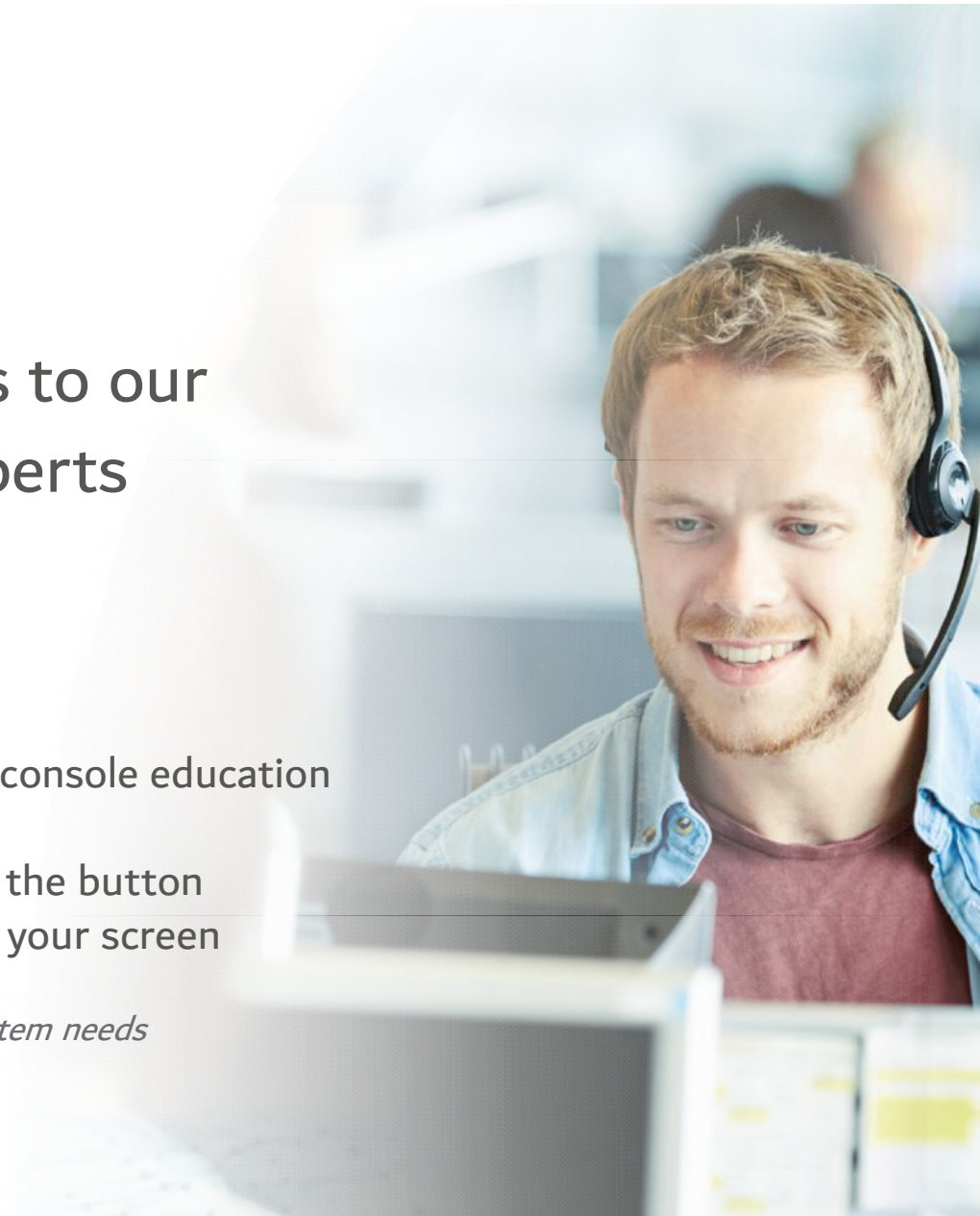



Expert Live Support through GE back-office connection

- Get an answer to all your questions by reaching out to GE experts during the lifetime of your console
- Fast access to GE experts whenever customers need it thanks to remote connection
- One service center for technical & application support



30%

of issues on a ultrasound system are repaired remotely and often

3 times quicker*

If your ultrasound cannot be repaired remotely,

.....→ **90%**

of issues are resolved on the 1st visit.*

*GE internal data





SECURITY

SonoDefense

ADVANCED CYBERSECURITY AND DATA PRIVACY PROTECTION

Healthcare institutions are under growing threats of cyberattacks – and the implications for data security, patient privacy, and the quality and cost of care are staggering.

Protecting against these threats and safeguarding your patients and your institution requires more than anti-virus protection. SonoDefense is GE Healthcare's multi-layer strategic approach to cybersecurity and patient data privacy for ultrasound.

SonoDefense is designed to:

- Keep the ultrasound machine safe and functional in the face of cyberthreats
- Protect patient data on the machine from unauthorized access
- Enable you to successfully implement patient data and security policies, while still managing product daily workflows





EVOLUTION

Keep your ultrasound system up-to-date with the latest clinical applications

As part of the GE Healthcare Family, we want to make sure you protect your investment and stay ahead of curve in terms of innovations that will help you achieve more for your patients.

This is why we have in our portfolio different upgrades available for our wide range of products.

This portfolio is evolving every year with new product introduction.

You can purchase a new release when it becomes available or if you want to proactively take care of your equipment's lifecycle performance, you have the possibility to add the EverGreen option to your GE service contract.



Voluson™ expert series



Vivid™ Series



LOGIQ™ Expert Series



FLEET PERFORMANCE MANAGEMENT

iCenter: Maintenance management of your ultrasound fleet

Access data & analytics on maintenance status of your ultrasound fleet*, including:

- **Transparency & service reliability** thanks to the Business Review Dashboard on the technical status of your ultrasound equipment
- **Traceability**: availability to download service report for compliance purposes
- History and Planning of your maintenance activity
- Available online and via mobile app

GET MORE
**VISIBILITY &
TRANSPARENCY**



**under GE contract*





FLEET PERFORMANCE MANAGEMENT

MyGEHealthcare App: Services requests made easy

Clinical engineers or technology managers can't always be near a PC, which is a challenge when a service request needs to be made on the go! GE Healthcare is bringing iCenter's asset management and service request tools right to your mobile device: giving you access to the resources you need, anywhere you need them

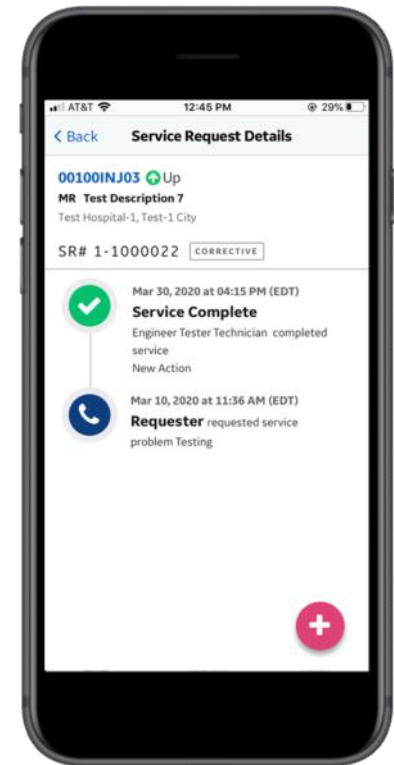
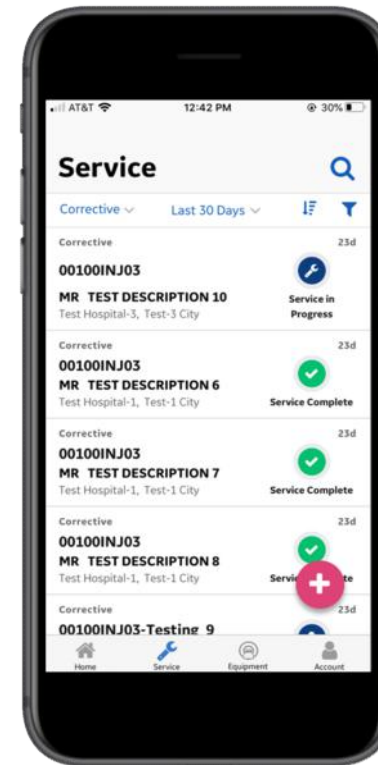
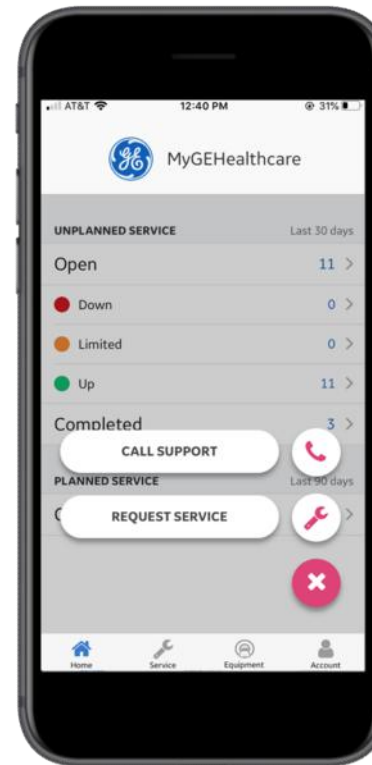

Create and track service requests to completion



View service request history and upcoming planned service



Access engineer debrief data



Get real-time push notifications for every step of the service process



Ultrasound Excellence

Leverage the data of your Ultrasound fleet

Analytic software



- ✓ Easy to access & maintain (Web based)
- ✓ Data secured (On premise)
- ✓ Intuitive & Interactive (Dynamic filters)
- ✓ Multivendor systems (Dicom)
- ✓ Multi modalities (Ultrasound MR, CT)
- ✓ For all departments (U/S Exam/NonExam activities)

Personalized consulting



Remote and onsite consulting touchpoints are scheduled between our digital adoption experts and members of your site. The goal is to support you to fully exploit the software solution by personalizing your dashboards and to help you to build a plan to deliver the operational, clinicals and/or financials desired outcomes.

Outcomes



Biomedical engineer & purchasing manager

Manage fairly the investment/costs
Identify equipment sharing capacity
Finance systems based on utilization
Monitor vacation resources needs
Digitalize your investment planning



Head of department

Optimize the consultation flow
Justify needs for equipment/probes
Identify education needs for your staff



Sonographers

Gain in expertise as users and save time for repetitive tasks
Increase patient experience

5 YEARS

30Eur

per month per device*

* for 20 U/S Systems connected





IT SOLUTIONS

Image management & reporting solution

ViewPoint™ 6 is GE's ultrasound image management and reporting solution that can help enhance efficiency and quality in your daily routine.



Manage your data in one solution and connect seamlessly with your ultrasound and IT systems to help enhance your current investment. With customizable reporting and interfaces, ViewPoint 6 is scalable to meet your unique needs.

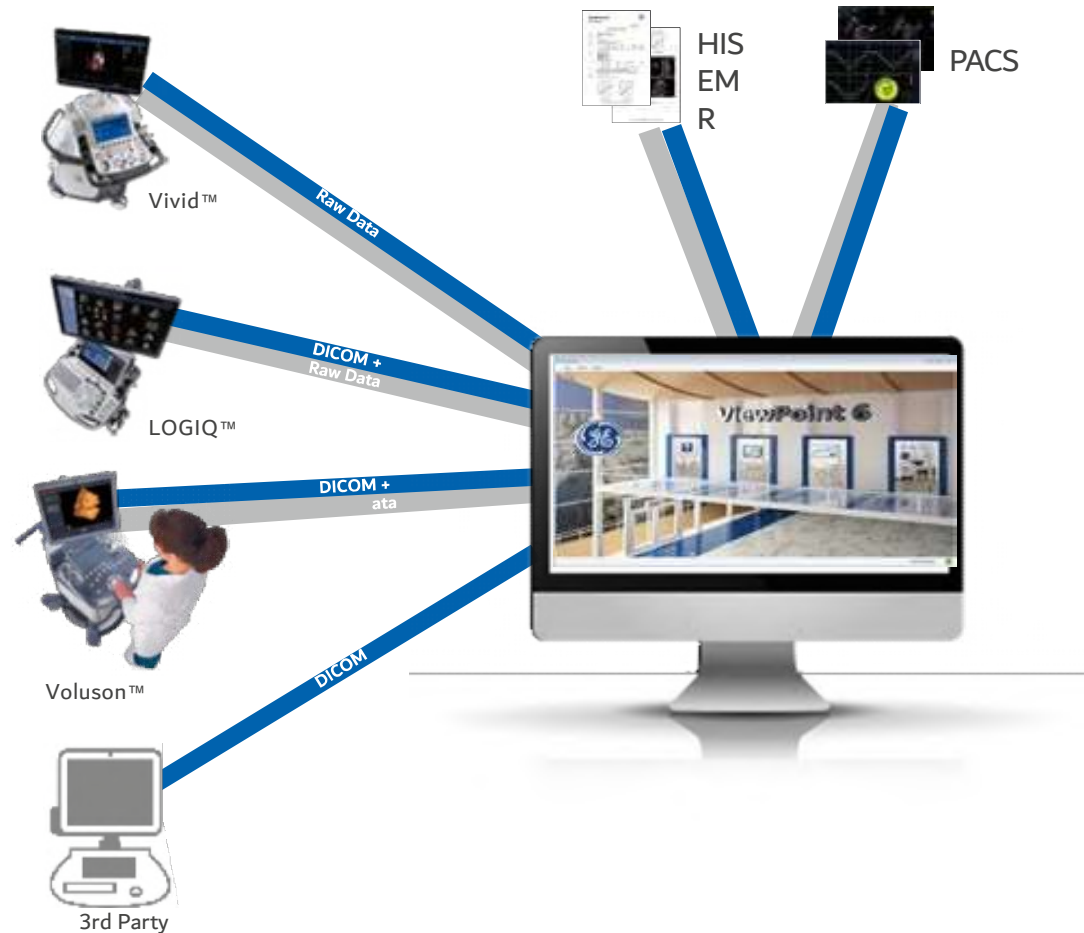



IT SOLUTIONS

Image management & reporting solution



IMAGE MANAGEMENT

- Reduce need to print images with digital image storage
- Easily access images, clips, and volumes all in one place
- Analyze data offline with integrated post-processing applications



REPORTING

- Provide clean, comprehensive, easy-to-read reports to referring physicians
 - Help reduce errors when measurements auto-populate the report
- Complete a report faster with quick report templates



WORKFLOW

- Digitize workflow with electronic reporting worksheets
- Reduce manual entry by sending order and patient data from EMR to the ultrasound
- Print final report, fax to a referring physician, and send a report to an EMR all with a single click



IT INTEGRATION

- Enhance communication with seamless integration to existing IT systems like PACS & EMR as well as dictation systems
- Connect with multi-vendor ultrasound and IT systems
- Build a solution to meet your unique integration needs

ViewPoint 6 helps:

- enhance your workflow
- save time
- reduce errors
- enhance communication



CARE & HYGIENE

Guarantee an optimal care for patients

Education

- Probe Care course
- Care cards
- Webinars

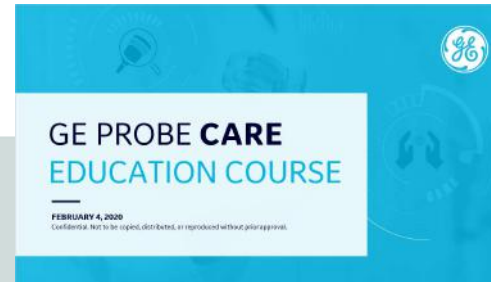

Solutions

- Cleaning
- Disinfection
- Transport
- Storage
- Testing





STAR

Saving Time with Augmented Reality



Augmented reality

- All ULS products
- IOS version
- 6 languages
- Knobology support



Loyalty clubs

- Bridge to Clubs
- Education program
- Product content

Quick cards

- All ULS products
- Printable version

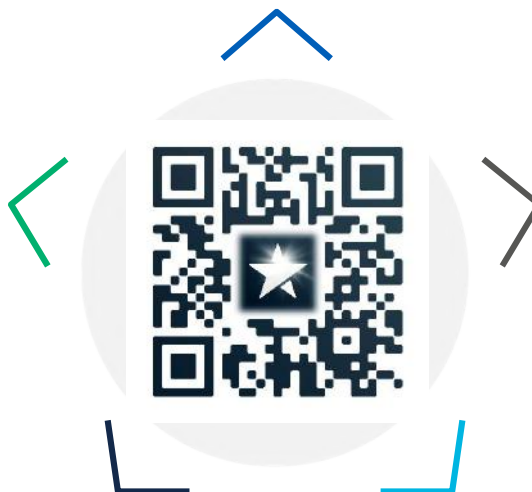

Getting started videos

- All ULS products
- 6 videos tutorials
- Knobology support

Remote support



- Access to call center
- Phone number
- GE remote laptop view
- Customer phone view
- Knobology support
- Settings optimization
- Configuration support



LOGIQ™ Club users' community



Access to the Club websites

- Local contents, events
- Clinical courses in your country
- Application tips & tracks
- Publications and cases & papers
- Clinical cases & technical presentations
- Downloadable educational materials and DVD
- Online education

Personalized mailings & newsletters

- Be first to learn about new ultrasound products and software upgrades



LOGIQ™ Club users' community

Education highlights

Online education

- GE White Papers
- Application videos
- Clinical tutorials
- Clinical Web Series
- Video tutorials on advanced features
- Access to peer-to-peer reviewed papers
- My Trainer Web/App for some products

Mobile App – now available

- Watch course videos and product tutorials directly on your smartphone
- MyLOGIQ area



Welcome to the LOGIQ Club

