

Foldable IOL

B-Lens

- Modified C haptic shape
- Square edge design - Optic and Haptic
- High refractive index
- Excellent memory - Superior foldability - Slow and gentle unfolding
- Manufactured from Copolymer HEMA/EOEMA, 25% water content with UV blocker
- Yag laser compatible
- Insertion through a 2mm - 3.2mm

Specifications

Overall length.....	12.50 mm
Optic diameter.....	6.00 mm
Power range.....	+1.00 to +7.00 (1 dpt increments) +8.00 to +30.00 (0.5 dpt increments) +31.00 to +40.00 (1 dpt increments)
Optic design.....	Bi Convex
Finish.....	Square edge
Haptic shape.....	Modified C
Haptic angulation.....	5°
Material.....	Hydrophilic Acrylic UV
Refractive index.....	1.462 (35°C)
Yag laser.....	Compatible
A. constant.....	118.2
Placement.....	Capsular Bag

B-Lens - The excellent optic resolution provides optimum postoperative visual acuity

Improved modified C haptic shape

B-Lens design optimizes the stability of the lens in the capsular bag.

Square edge design

B-Lens square edge design - intended to prevent cell growth under the lens.

Improved posterior capsular tension

B-Lens 5° angulation and haptic shape, improve the posterior capsular tension.

High refractive index

B-Lens High Refractive Index (1,462), optimizes the profile of the lens thus enabling insertion through a 2 ÷ 3.2 mm incision.

Insertion

B-Lens can be implanted with either Forceps or Injector.

Superior foldability with a gentle and slow unfolding release

B-Lens material has excellent memory properties that ensure a perfect foldability and perfectly slow and gentle unfolding release.

UV blocker

B-Lens material has a built in UV blocker that effectively filters damaging UV radiation.

YAG laser compatible

B-Lens is YAG laser compatible

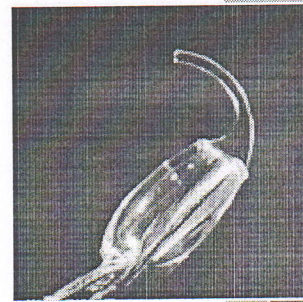

Easy folding with forceps

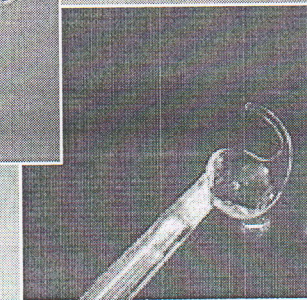
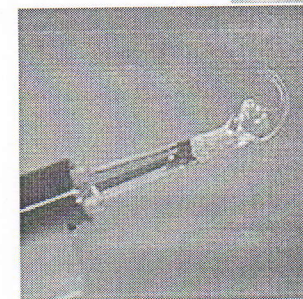
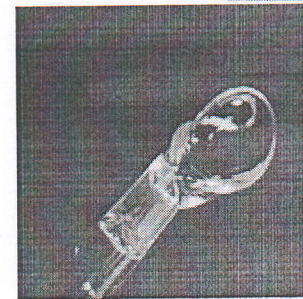
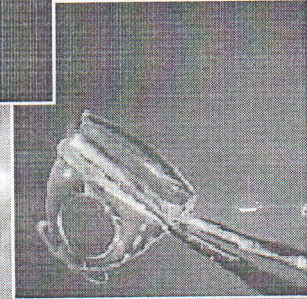

Gentle unfolding from injector

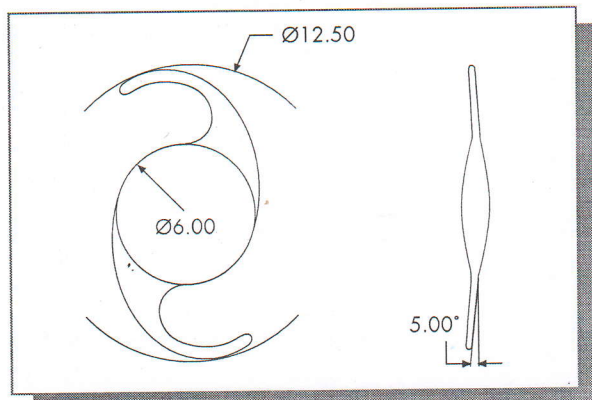
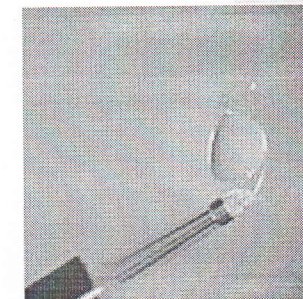

T1007 08/07

Hanita
Lenses

www.hanitalenses.com • email: marketing@hanitalenses.com

Hanita Lenses • Intraocular & Contact Lenses • Kibbutz Hanita 22885 Israel • Tel. 972 4 9950700 • Fax. 972 4 9950755

European Authorized Rep. OBELIS S.A., 34, avenue de Tervuren, Bte 44, 1040 Brussels, Belgium.

