

**Anexa 29 Dispozitiv fizioterapeutic laserterapie 3B, Model: PhysioGo.Lite Laser, Astar,  
Nr. de inregistrare AMDM: DM000663217**

Specificarea tehnică deplină solicitată, Standarde de referință	Specificarea tehnică deplină oferita, Standarde de referință
<p>Dispozitiv fizioterapeutic laserterapie 3B Cod 400170</p> <p>Descriere Dispozitivul portabil de laserterapie clasa 3B este destinat utilizării în cabinete de fizioterapie, recuperare medicală, reumatologie, ortopedie și medicină sportivă pentru ameliorarea durerii acute și cronice musculo-scheletale, reducerea inflamației și edemului, accelerarea vindecării rănilor, stimulare regenerării țesuturilor moi.</p> <p>Parametru Specificație Clasa dispozitivului cu laser 3B Laser roșu obligatoriu Laser infraroșu obligatoriu Protocoale de lucru presetate obligatoriu Protocoale de lucru personalizate obligatoriu</p> <p>Cronometru diapazon 1-99 min Portabil obligatoriu</p> <p>Alimentare 230V ± 10%, 50 Hz Accesorii "Sonda roșu ≥ 1 buc, să se indice codul produsului" "Sonda infraroșu ≥ 1 buc, să se indice codul produsului" "Ochelari de protecție ≥ 2 buc, să se indice codul produsului" Set de accesorii standard - obligatoriu</p>	<p>Dispozitiv fizioterapeutic laserterapie 3B– broșura, pag.1 Cod 400170</p> <p>Descriere Dispozitivul portabil de laserterapie clasa 3B este destinat utilizării în cabinete de fizioterapie, recuperare medicală, reumatologie, ortopedie și medicină sportivă pentru ameliorarea durerii acute și cronice musculo-scheletale, reducerea inflamației și edemului, accelerarea vindecării rănilor, stimulare regenerării țesuturilor moi.- manual pag.8,38,51,</p> <p>Parametru Specificație Clasa dispozitivului cu laser 3B- broșura, pag.1 Laser roșu – broșura, pag.1 Laser infraroșu – broșura, pag.1 Protocoale de lucru presetate -da, per total 175 programe Protocoale de lucru personalizate -da, posibilitatea de configurație a 200 programe, – broșura, pag.2 Cronometru diapazon 1s-100 min- broșura, pag.1 Tip Portabil, da dispozitivul avind doar 3 kg poate usor fi transportat – broșura, pag.2 Alimentare 100-240 V, 50/60 Hz, – broșura, pag.2 Accesorii "Sonda roșu -1buc, cod: A-AL-AST-80RDV3, manual pag 65 "Sonda infraroșu -1buc, cod:A-AL-AST-400IRV3, manual pag 65 "Ochelari de protecție - 2 buc, Protective goggles- manual pag 65 Set de accesorii standard – da, manual pag. 64</p>



# PhysioGo.Lite LASER

Biostimulation laser therapy



## Features

product code	A-UL-AST-PLL
color display with touch panel	5"
independent treatment channels	1
manual mode	✓
disease entities selected by name or medical field	✓
preset treatment programs database	✓
user-defined programs database	✓
favorite programs	✓
possibility of program names edition	✓
encyclopedia describing the treatment methodology	✓
statistics of performed treatment procedures	✓
buzzer sound volume regulation	✓
STAND BY mode	✓
battery (optional accessory)	✓
battery saving mode (option)	✓

## Laser therapy

operation with applicators: scanning laser, cluster laser and point probes	✓
emission mode: continuous and pulse	✓
adjustment of laser radiation power	✓
duty factor	✓
possibility of automatic treatment procedure repetition	✓
automatic laser radiation power test	✓
automatic calculation of time relative to treatment parameters - dose, power, duty factor, treatment area	✓
three modes of treatment field irradiation in scanning laser applicators	✓
dedicated modes for cooperation with optical fiber applicators	✓
optical fiber applicators for laserpuncture and ENT applications	✓
pilot beam indicating the application site	✓

## Preset treatment programs

built-in treatment programs, including:	175
IR point probe programs	39
R point probe programs	18
programs with Nogier frequency	8
programs with Voll frequency	30
cluster laser applicator programs	54
program sequences for scanning laser applicators	26

## Laser therapy technical parameters

laser device class	3B
treatment timer	1 s - 100 minutes

user configurable programs	200
favorite programs	✓

## Laser therapy parameters - biostimulation laser point probes

---

red light laser point probes wavelength	660 nm
maximum power of the red light point probes	80 mW
infrared laser point probes wavelength	808 nm
maximum power of the infrared point probes	400 mW
power regulation	25%, 50%, 75%, 100%
pulse mode frequency	1 - 5000 Hz
duty factor in pulse mode	10 - 90%, pulse 50 us

## Laser therapy parameters - scanning laser applicator

---

scanning laser applicator wavelength	808 & 660 nm
maximum power of the scanning laser applicator	450 & 100 mW
power regulation	50%, 100%
pulse mode frequency	1 - 5000 Hz
duty factor for scanning laser applicator pulse mode	75%

## Laser therapy parameters - cluster laser applicator

---

cluster laser applicator wavelength	4x 808 nm & 5x 660 nm
maximum power of the cluster laser applicator	4x 400 mW & 5x 40 mW
power regulation	50%, 100%
pulse mode frequency	1 - 5000 Hz
duty factor in pulse mode	10 - 90%

## General technical parameters

---

dimensions	25 x 27 x 16,5 cm
device weight	3 kg
battery type (option)	Li-ion
battery capacity (option)	2100 mAh
power supply, power consumption	100-240 V, 50/60 Hz



PhysioGo.Lite Laser  
Instructions for use





## Contents

<b>1.</b>	<b>BASIC INFORMATION .....</b>	<b>6</b>
1.1	MANUFACTURER .....	6
1.2	RISK MANAGEMENT PROCESS .....	6
<b>2.</b>	<b>INTENDED USE .....</b>	<b>7</b>
2.1	INTENDED USERS .....	8
2.2	USER TRAINING .....	8
<b>3.</b>	<b>WARRANTY AND MANUFACTURER'S RESPONSIBILITY .....</b>	<b>10</b>
<b>4.</b>	<b>OPERATIONAL SAFETY .....</b>	<b>11</b>
4.1	MAINS SUPPLY AND OPERATION MODE .....	11
4.2	STORAGE, OPERATION AND TRANSPORT CONDITIONS .....	11
4.3	WARNINGS AND SAFETY NOTES .....	12
4.4	EXPLOSION PROOF ENVIRONMENT .....	14
4.5	ELECTROMAGNETIC ENVIRONMENT .....	14
4.6	OPERATION OF TOUCH-SENSITIVE DISPLAYS .....	15
4.7	APPLIED PARTS .....	15
4.8	ESSENTIAL PERFORMANCE .....	15
4.8.1	<i>Test of essential performance and basic safety</i> .....	16
4.9	EYE PROTECTION .....	17
4.10	LASER LABELS .....	19
4.11	DISPOSAL .....	20
<b>5.</b>	<b>UNIT DESCRIPTION .....</b>	<b>21</b>
5.1	GENERAL CHARACTERISTICS .....	21
5.2	FRONT PANEL .....	22
5.2.1	<i>Operation status and battery level indicators</i> .....	23
5.3	BATTERY INSTALLATION .....	24
5.4	NAME PLATE .....	25
5.4.1	<i>UDI code</i> .....	25
5.5	LASER RADIATION MEASUREMENT .....	26
5.6	PROTECTION .....	26
5.6.1	<i>Remote interlock connector</i> .....	26
5.6.2	<i>Emergency laser stop</i> .....	26
5.7	LASER APPLICATORS .....	27
<b>6.</b>	<b>DEVICE INSTALLATION AND START-UP .....</b>	<b>31</b>
6.1	UNIT INSTALLATION .....	31
6.1.1	<i>Assembling of the holders</i> .....	31
6.1.2	<i>Connection of laser applicators</i> .....	33
6.1.3	<i>Laser scanner stand</i> .....	34
6.1.4	<i>Integrated emergency laser stop and remote interlock connector (DOOR) installation</i> .....	36
6.2	FIRST OPERATION .....	36
6.2.1	<i>Laser therapy access code</i> .....	36
6.3	SETUP MODE .....	37
6.3.1	<i>Basic information</i> .....	37
6.3.2	<i>Language</i> .....	37
6.3.3	<i>Global settings</i> .....	37
6.3.4	<i>Functional settings</i> .....	38
6.3.5	<i>Control functions</i> .....	38
6.3.6	<i>Information</i> .....	39
6.4	TRANSPORT POSITION – THE STAND WITH SCANNING APPLICATOR .....	40
6.5	TRANSPORT POSITION – TROLLEY FOR THE UNIT .....	41
<b>7.</b>	<b>UNIT OPERATION .....</b>	<b>42</b>
7.1	PATIENT PREPARATION AND TREATMENT PERFORMANCE .....	42
7.1.1	<i>General information</i> .....	42
7.1.2	<i>Laser therapy</i> .....	42
7.2	SCREEN CONFIGURATION .....	43
7.3	GENERAL CONFIGURATION .....	44

7.4	DISPLAY DESCRIPTION .....	45
7.5	OPERATION WITH PRESET TREATMENT PROGRAMS .....	45
7.5.1	<i>Voll and Nogier programs</i> .....	47
7.6	FAVORITE PROGRAMS .....	47
7.7	MANUAL MODE OPERATION .....	48
7.8	USER PROGRAMS .....	49
7.9	SAFE SHUTDOWN PROCEDURE .....	50
<b>8.</b>	<b>DEFINITIONS AND PARAMETERS .....</b>	<b>51</b>
8.1	POINT LASER APPLICATORS (LASER PROBES) .....	52
8.2	SCANNING APPLICATOR .....	53
8.2.1	<i>Limitation of the laser scanner power</i> .....	53
8.3	CLUSTER APPLICATOR .....	54
<b>9.</b>	<b>INDICATIONS AND CONTRAINDICATIONS .....</b>	<b>55</b>
9.1	INDICATIONS .....	55
9.2	CONTRAINDICATIONS .....	55
<b>10.</b>	<b>MAINTENANCE, CLEANING, DISINFECTION .....</b>	<b>56</b>
10.1	CLEANING OF THE UNIT AND SWITCH MODE POWER SUPPLY CASING .....	56
10.2	CLEANING OF TOUCHSCREEN .....	56
10.3	CLEANING AND DISINFECTION OF THE SCANNING AND CLUSTER APPLICATOR .....	57
10.4	CLEANING AND DISINFECTION OF THE POINT LASER APPLICATORS .....	57
10.4.1	<i>Disinfection and sterilization of the optical fiber applicators</i> .....	57
10.5	SPECIAL MESSAGES .....	58
10.6	SELF-TEST PROCEDURE .....	58
10.7	TROUBLESHOOTING .....	59
10.8	FUSE REPLACEMENT .....	60
<b>11.</b>	<b>SPECIFICATION AND PARTS OF THE UNIT .....</b>	<b>61</b>
11.1	TECHNICAL DATA .....	61
11.2	EMC PARAMETERS .....	63
11.3	STANDARD PARTS OF THE UNIT .....	64
11.4	OPTIONAL PARTS OF THE UNIT .....	65
<b>12.</b>	<b>APPENDIX A. SYMBOL DESCRIPTION .....</b>	<b>66</b>
12.1	CONTROLLER, PARTS OF THE UNIT, PACKAGING .....	66
12.2	SWITCHED-MODE POWER SUPPLY – CASING .....	68
<b>13.</b>	<b>APPENDIX B. DISASSEMBLY OF LASER SCANNER FROM THE STAND .....</b>	<b>70</b>

#### Figure list

Figure 4-1	The symbols of the emergency laser stop and remote interlock connector .....	13
Figure 4-2	Labels for marking the room, where laser therapy treatment procedures are performed .....	19
Figure 4-3	Laser label of the unit .....	19
Figure 4-4	Labels of point applicators .....	19
Figure 4-5	Labels of scanning applicator .....	19
Figure 4-4	Labels of cluster applicator .....	19
Figure 5-1	General view .....	21
Figure 5-2	Unit rear panel view .....	21
Figure 5-3	Arrangement of front panel components .....	22
Figure 5-4	The battery installation method .....	24
Figure 5-5	Name plate of PhysioGo.Lite Laser .....	25
Figure 5-6	UDI code – example .....	25
Figure 5-7	Therapy selection mode screen .....	26
Figure 5-8	The view of the emergency laser stop .....	27
Figure 5-9	Emergency laser stop label sample .....	27
Figure 5-10	Point laser applicators and optical fibers .....	28
Figure 5-11	Laser scanning applicator – panel description .....	29
Figure 5-12	Scanning and cluster laser applicators .....	29
Figure 5-13	Laser cluster applicator – panel description .....	29
Figure 6-1	Method of mounting the point applicator holder .....	32
Figure 6-2	Method of mounting the cluster applicator holder .....	33
Figure 6-3	Laser therapy sockets .....	34

Figure 6-4 Sticking the magnetic tape to the power supply .....	34
Figure 6-5 Handwheels – scanner and arm of the stand .....	35
Figure 6-6 Wheel with brake .....	35
Figure 6-7 The view of the device on a stand .....	35
Figure 6-8 Remote interlock connector socket .....	36
Figure 7-1 Field description .....	43
Figure 7-2 Screenshot sample view for laser therapy – cluster applicator .....	45
Figure 7-3 Information screen sample view .....	46
Figure 10-1 The unit error signaling and information visible after closing of the error message .....	58

# 1. Basic information

**Read this Instructions for use carefully before starting the unit operation!  
Follow the recommendations presented in this Instructions for use!**

**The laser therapy unit PhysioGo.Lite Laser should be installed and started off by the seller. The recipient has the right to insist on the product operation training.**

**The unit may only be operated by qualified personnel or under supervision of such personnel!**

**WARNING: The device is intended for adult patients only. It is not intended for use in a home healthcare environment.**

**Revision 20.0 and higher of this instruction applies to a device that complies with the requirements of Regulation (EU) 2017/745 of the European Parliament and of the Council of 5 April 2017 on medical devices.**

Description of symbols used in this manual:



Read appropriate passage of this Instructions for use, warnings or important information. Failure to observe warnings can lead to injuries.



Important notices and information.



Following texts marked with this symbol facilitates device operation.

**NOTE:**

The outlook of screens shown in this manual may slightly differ from their actual outlook during device operation. These differences may concern size and type of fonts and size of symbols. There are no differences in the content of shown information.

**NOTE:**

This manual contains instructions for use and technical description. This instructions for use is provided in the paper form. It is possible to receive a copy of the instructions in the form of a file. To do this, please submit the form available at <https://astar.eu/instructions/>

**WARNING: No modification of this equipment is allowed!**

## 1.1 Manufacturer

**ASTAR Sp. z o.o.  
ul. Świt 33  
43-382 Bielsko-Biała, Poland  
[www.astar.eu](http://www.astar.eu)**

## 1.2 Risk management process

The manufacturer conducts continuous risk management process referring to the device construction, its intended use, method of operation and maintenance. Residual risks are presented in this Instructions for use in form of information about precautions, contraindications and warnings.

## 2. Intended use

Laser therapy unit PhysioGo.Lite Laser is an active, non-invasive therapeutic device, intended for carrying out treatment procedures using laser radiation within the visible (for wavelength 660 nm) and invisible range (for wavelength 808 nm).

As regards to laser radiation, the unit may be operated with point, cluster and scanning laser applicators. Due to the available maximum radiation power output at the level of 450 mW for wave length 808 nm and 100 mW for 660 nm, the PhysioGo.Lite Laser unit is classified as a small power output laser device. In physiotherapy such lasers are designated as "cold", "soft" or biostimulating. The laser radiation is delivered through direct contact method with non-injured skin or without a contact. Parts of the body intended for treatments with PhysioGo.Lite Laser are back, upper limbs (shoulder, arm, forearm, hand), lower limbs (hip, thigh, shank, foot), neck and face for interaction with body tissues such as muscle, skeletal, nervous, circulatory and lymphatic system and/or skin.

Its specific medical purposes are:



- treatment or alleviation of disease,
- treatment or alleviation of an injury or disability.



**The unit is a laser therapy device class 3B.**

The device has one therapeutic channel for laser therapy. The list of available applicators in particular sockets is presented in the Table 2-1. Further information on supported types of laser applicator is given in sections 5.7 and 8.

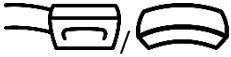
Table 2-1

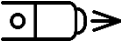
Socket	Socket labelling	Laser applicator type
1		Cluster laser applicator (cluster applicator) or scanning laser applicator (laser scanner)
2		Point laser applicator (laser probe)
3		Point laser applicator (laser probe)

The unit possesses the base of preset treatment procedures along with therapeutic encyclopedia, which significantly increases comfort of operation. There is a possibility to create own user-defined programs – for all laser applicators. Laser therapy treatments can be performed in continuous or pulse mode.

**Detailed information about indications and contraindications are presented in chapter 9.**

Impact of low energy laser radiation on tissue includes:

- improvement of micro-circulation,
- stimulation of angiogenesis,
- increase in amplitude of activity potentials with nerve fibers,
- increase in enzyme activity,
- changes in potential of cell membranes,
- changes in secretion of neurotransmitters, hormones and kinins.

At the level of cells follows:

- acceleration of electrolyte exchange between cell and environment,
- increase in biological activity,
- anti-mutagen impact,
- changes in liquid crystal structure of biological membranes
- increase in synthesis of collagen, proteins, RNA and ATP.

Due to the wide range of impact laser may be applied to treat disorders on many fields, among others in:

- sports medicine,
- orthopedics,
- rheumatology,
- neurology,
- dermatology
- laryngology,
- esthetic medicine,
- stomatology.

An important factor of bio-stimulating laser activity is the missing heat effect, which allows application for acute conditions.

Due to the optional availability of a battery, the unit is perfectly suited for use:

- in sports medicine in case of training camps,
- wherever there are problems with power supply quality.

## 2.1 Intended users



**The patient should not be the operator.**

Users (operators) of PhysioGo.Lite Laser can be:

- specialists in the field of the laser therapy,
- physiotherapists specializing in the therapy of the musculoskeletal system,
- sports medicine specialists,
- aesthetic medicine specialists,
- trained personnel performing treatments under the supervision of the above-mentioned specialists.

The user should have:

- knowledge about the indications and contraindications for the use of laser therapy,
- knowledge of the terminology and technical terms used in the manual (e.g. knowledge of units of physical quantities),
- practical skills in performing therapeutic treatments using devices for laser therapy, resulting from education, experience and training.

Physical and cognitive requirements of the operator:

- eyesight enabling to recognize elements of screen and keyboard,
- hearing enabling to hear the patient's voice,
- reading comprehension that allows to read the instructions for use and information on the screen of the device,
- two functional upper limbs that allow to perform treatments and other activities related to the operation of the device (e.g. cleaning of applicators),
- age in the range of admissible value of professional activity (depending on the regulations of the country where the device is used).

## 2.2 User training

The PhysioGo.Lite Laser user has to be properly trained in the device safe and effective use, before starting the operation. Training in the rules of operation can be carried out by representatives of the manufacturer or seller, based on this instructions for use.

Recommended training positions:

- information about the intended use of the device,
- occupational safety information,
- information on the construction and method of the shockwave generation,
- information on available settings and operation modes,
- instructions for use,
- indications and contraindications for the therapy,

## *2. Intended use*

---

- information on recommended maintenance, cleaning and disinfection,
- handling in the event of a technical malfunction.

Due to requirements of local law and regulations in different countries, additional training activities may be required. The user should inform the seller about such requirements in order to receive complete information.

### 3. Warranty and manufacturer's responsibility



The manufacturer warrants the controller and laser applicators to be free of faults for the period of time and conditions stated in Warranty Certificates. The manufacturer also provides post-warranty service for a period of 10 years from launching the unit onto the market. The warranty includes all material and workmanship faults.

The manufacturer undertakes to observe the warranty agreement, if the following conditions are met:

- all repairs, changes, extensions and calibrations of equipment are performed by manufacturer or authorized service personnel,
- firmware updates are performed by the manufacturer, an authorized service personnel or distributor,
- the mains supply system in the treatment room meets requirements of standards in force,
- the unit is operated by qualified personnel, in compliance with instructions presented in this manual,
- the unit is operated in compliance with its intended use.

The warranty does not include consumables, such as connection cables, mains cables, gas springs, laser applicator lenses, optical fiber applicators, holders and fuses, as well as faults or damage caused by:

- improper placement, installation or configuration of the device,
- misuse or failure to observe the instructions presented in this instructions for use,
- inaccurate or inadequate maintenance carried out by the operator,
- improper environmental conditions specified for the product,
- unauthorized opening of the outer casing,
- adjustment and/or unauthorized tuning,
- use of non-original parts of the unit.

The warranty does not cover any damage due to a failure to adhere to the recommendations stated in chapter 4.3 and 10 hereof.

The manufacturer is not liable in case of transmission of infection by parts of the unit.



**The expected "life time" of the device is 10 years.**

After elapse of 10 years from date of introduction of device and detachable parts in the market the manufacturer is not liable for device and detachable parts faults or its consequences. After elapse of the expected life time of the device the user bears the complete responsibility for the occurrence of medical incidents.

The manufacturer bears no responsibility for results of faulty installation, wrong diagnosis, wrong use of the device and parts of the unit, failure to observe instructions for use and performance of repairs by unauthorized persons.



**Inside the device there are no user serviceable components, except for fuses and battery.  
No parts can be serviced or maintained when the device is in use with a patient.**

The firmware that is part of the device is not intended to be installed, configured or updated by the user. See section 6.3.6.1 for details.

On demand, the producer makes available technical diagrams, parts lists, descriptions, instructions for calibration or other helpful information to appropriately qualified user's technical staff to repair these parts of unit, which are described by the producer as a repairable.

## 4. Operational safety

---

### 4.1 Mains supply and operation mode



The unit is designed for supply from AC mains with rating 100-240 V and frequency 50/60 Hz. It is a medical device under safety class II, type BF. The unit may be used only in rooms, where the electric system is executed in compliance with standards in force. The unit is intended for continuous operation. It is not necessary to switch it off from the mains between particular treatment procedures.

An external switched-mode power supply treated as part of the device is the source of supply for the device. Two models are allowed to be used with the device:

- type HPU63B-108 by Sinpro, constant output voltage 24V, rated current 2,62A,
- type GSM60B24-P1J by Mean Well, constant output voltage 24V, rated current 2,5A.

The types of switched-mode power supply approved for use with the device are placed on the identification label on the bottom of the device.

The power supply is connected to the mains using the detachable power cord. The power supply cord is equipped with a mains plug that isolates the device from the supply mains on all poles simultaneously.

The socket in the device where the plug of the switched-mode power supply is connected is marked with  and safety sign ISO 7010 - M002.

Connecting to the mains and the proper operation of the switched-mode power supply is signaled:

- by the green LED indicator located on the housing of the switched-mode power supply type HPU63B-108 by Sinpro,
- by the blue LED indicator located on the housing of the switched-mode power supply type GSM60B24-P1J by Mean Well.



**Recommendations related to isolation the device from the supply mains:**

- **do not position the PhysioGo.Lite Laser so that it is difficult to operate the disconnection of the device from the supply mains,**
- **to isolate the device from the supply mains, hold the mains socket-outlet with one hand, grasp the mains plug with second hand and disconnect it from the mains socket-outlet.**

**Disconnection from the mains takes place after:**

- **switching the power switch to the "0" position,**
- **removing the SMPS output cord plug from the socket on the unit,**
- **removing the mains cable plug from the mains socket.**

There is an option to equip the device with a battery which allows for operation without, or in conditions of reduced quality of power supply.

### 4.2 Storage, operation and transport conditions

The PhysioGo.Lite Laser unit must be stored in closed rooms, where the atmosphere is free from vapors and caustic substances and:

- the temperature is maintained between + 5°C and +45°C,
- relative humidity does not exceed 75%,
- atmospheric pressure value is between 700 and 1060 hPa (70-106 kPa).

The unit is intended for operation under the following conditions:

- ambient temperature between +15°C and +30°C,
- relative humidity between 30% to 75%,
- atmospheric pressure between 700 to 1060 hPa (70-106 kPa).

If further transport of the device is required, use the delivery packaging. Transport shall be performed with covered transport means.

Recommended transport conditions:

- ambient temperature between -10°C to +45°C,
- humidity between 20 and 95%,
- atmospheric pressure between 700 and 1060 hPa (70-106 kPa).

The above conditions refer also to the battery mode.



### 4.3 WARNINGS and safety notes

The PhysioGo.Lite Laser unit has been designed and manufactured in such a way that its use does not jeopardize the health and safety of patients, users and third parties, as well as the unit should provide therapeutic benefits to patients if it is operated in appropriate conditions and in accordance with its intended purpose.

General:

- PhysioGo.Lite Laser unit may be operated by qualified personnel, in compliance with instructions presented in this manual (see 2.1).
- **No modification of this equipment is allowed!**
- Using the methods of control, adjustment or performance of procedures other than those specified herein may result in exposure to hazardous laser radiation.
- The treatment station (bed, couch) shall be located away from other electric devices and water supply/ sewerage installation/ central heating system, so that it is impossible for the patient to touch any of them during treatment procedure.
- Do not position the PhysioGo.Lite Laser so that it is difficult to operate the disconnection of the device from the supply mains.
- Do not remove warning signs and labels put by the manufacturer on the unit casing and casings of laser applicators.
- The unit and laser applicators shall be protected against high temperatures and atmospheric conditions (e.g. direct sunlight).
- Detachable parts should be regularly inspected. Damaged cables shall be replaced immediately. Pay special attention to the casing cracks, threadbare isolation and partially torn interconnecting cables.
- Prevent any fluid from penetrating inside the unit, detachable parts or SMPS. In case of any fluid getting inside the unit, detachable parts or SMPS, switch the unit immediately off, isolate from the mains and contact the authorized service to inspect the unit.
- By any means do not cover the vents. Do not insert any objects into the vents.
- The unit may be only used with detachable parts, spare parts, disposable items which have been determined to be safe and appropriate inspection bodies have not issued contraindications against their use.
- Laser applicators are particularly sensitive to very low and very high temperatures. Pay particular attention not to connect a very cold device to the power supply (e.g. in the winter period directly after delivery by a courier company).
- Laser applicators may only be connected to the sockets when power supply is switched off. Connecting of probes with the power on may cause irreversible damage of the laser diode which is beyond the scope of warranty repairs!
- After switching the unit off, wait for 10 seconds before you switch it on again.
- Each serious incident concerned with the device should be reported to the manufacturer and competent authority of the country, where the user or patient resides. Serious incident means any incident that directly or indirectly led, might have led or might lead to any of the following:
  - the death of a patient, user or other person,
  - the temporary or permanent serious deterioration of a patient's, user's or other person's state of health,
  - a serious public health threat.

**Occupational safety and health for the laser operation:**

- The device allows combining two functions in one security system: the remote interlock connector and the emergency laser stop.
- The socket, where the remote interlock connector and the emergency laser stop should be connected, is marked with symbols no. 101 and 112, according to D1 table of EN 60601-2-22 standard (based on IEC 60601-2-22).

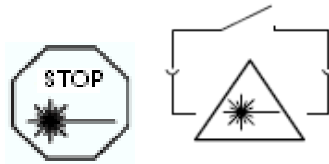

Figure 4-1 The symbols of the emergency laser stop and remote interlock connector

- The manufacturer offers an optional external emergency laser stop with the possibility of connection the remote interlock connector (e.g. in the form of a door opening sensor) to it. Details are given in section 5.6.
- An on-screen message confirms the activation of the remote interlock connector or the emergency laser stop.
- The emergency laser stop has higher priority over the remote interlock connector.
- If the user is not going to apply the remote interlock connector and the emergency laser stop, the DOOR plug, available as a standard part of the unit, performs their function.
- It is recommended to turn PhysioGo.Lite Laser device off when it is not used, so as it is not operated by unqualified or random persons.
- Patient and operator must wear protective goggles during treatment. The suitable information is presented in chapter 4.9. Third persons who are not wearing protective goggles should not be present in the room.
- Do not look directly into the laser beam, also avoid looking on reflected rays.
- Avoid directing laser beam onto surfaces, which reflect light.
- Each treatment procedure must be started at the moment, when laser applicator is set in the right direction (details – see 5.7).
- It is recommended, that walls of room, where the laser is operated, disperse to the greatest possible extent laser radiation incident of them. The color of walls must be so matched that the incident laser beam be visible.  
It should be added that some surfaces, which disperse visible light, may reflect infrared radiation emitted by laser.
- It is recommended to operate the unit, as far as possible, in a room dedicated exclusively to performance of laser therapy treatment procedures. If fulfilling this recommendation is not possible, we suggest to separate an area within the room used for different purposes in such a way that no emission of laser radiation outside the delimited area is possible.
- It is recommended to mark the room, where the laser therapy treatment procedures are performed, with warning labels and information delivered together with the unit.
- Point laser applicators can operate by contact or contactless method, scanning and cluster applicator by contactless method.
- The application methods depend on the area of application and the treatment purpose.
- Please take special care when handling laser applicator lens and optical fiber applicators, do not hit it against hard surfaces, and avoid scratches. Mechanical damage of lens may cause reduction in power output of laser radiation emitted by probe.

**Increased temperatures:**

- During operation of the cluster laser applicator, the head surface (polycarbonate panel) may be heated. The direct contact of this surface with the patient's body is not intended. The contact may be incidental, temporal, with the contact time less than a minute. Permissible temperature for such a situation and the applicator's material is 60°C according to table 24 IEC 60601-1 (see also EN 60601-1).

**Therapeutic:**

- The device is intended for adult patients. Patient must be conscious.
- It is impermissible for the patient to carry out the treatment on their own.

- It is prohibited to leave the patients unattended during treatments.
- It is necessary to continuously update knowledge and follow the references in the scope of therapy.
- Patients with implanted electronic devices (e.g. cardiac pacemakers, cardioverter defibrillator, spinal cord stimulator) or other metal implants should consult a physician prior to treatment.
- Before treatment it is necessary to interview the patient, by taking into consideration relative and absolute contraindications to use laser therapy. It is not recommended to carry out treatments in the patients with neurological disorders, synkinesis, trembling and convulsions.
- It is necessary to keep records of the treatment, including the parameters of the therapy, the area of treatment, treatment technique, dose and symptoms after therapy.
- Do not perform treatments on patients under the influence of alcohol.
- Do not perform treatments on patients under the influence of intoxicants.
- It is necessary to ensure the adequate interval between treatments for the patient, in order to avoid an increase of the risk of complications.
- Immediately disconnect the patient in the case of appearing warning or error messages on the display.
- Sitting or reclining position should be applied to the patients with respiratory disorders or breathing difficulties.
- The position of the patient should ensure good accessibility of the irradiated area and it should be comfortable for the patient.
- Treatment parameters should be as indicated by the physician.
- It is necessary to avoid carrying out treatments in the area of abdomen in pregnant women or women with the likelihood of pregnancy.

#### Battery use (optional):

- Rechargeable battery A-AW-AST-LITEAQ or A-AW-00003 is designed for use only with Astar PhysioGo.Lite range of devices.
- If you suspect that a battery-powered unit is not working properly, remove the battery.
- In case of mechanical damage to the battery module, there is a risk of fire, explosion or burns, due to used lithium-ion cells.
- Do not throw the battery or hit it. Do not heat it or incinerate.
- Do not short-circuit the contacts or disassemble the casing.
- Do not immerse in liquids.
- Operation, storage and transport conditions are presented in chapter 4.2.



## 4.4 Explosion proof environment

PhysioGo.Lite Laser is not adopted to operation in rooms, where combustible gases or their vapors occur. It is recommended to avoid anesthetics or oxygen derivate gases, such as nitrous oxide (N<sub>2</sub>O) and oxygen. Some materials (e.g. cotton, wool) may after saturation with oxygen become combustible at high temperatures generated with normal operation of equipment. It is recommended that solutions of adhesive and combustible solvents be vaporized before equipment is operated. It is also recommended to pay attention to the danger of ignition of endogenous gases. The unit must be separated from the mains before approaching the disinfection room, where it is installed.



## 4.5 Electromagnetic environment

- Due to the intended use the device can be used in hospitals, clinics, health centers, GP practices, rehabilitation offices and other health care facilities, under the supervision of qualified personnel.
- Simultaneous operation of unit with devices generating strong electromagnetic field, such as short wave and microwave diathermies, high frequency surgical equipment, MRI systems, may disturb unit operation. For this reason, it is recommended to maintain appropriate distance between these devices or to switch off the generator of strong fields during therapy with the PhysioGo.Lite Laser unit. Manufacturer doesn't claim compatibility of the PhysioGo.Lite Laser unit with high frequency surgical equipment.
- If the device is subjected to electromagnetic interference with an intensity that exceeds the compliance levels declared in section 11.2, the display may be affected, generation may be interrupted or the device may restart.

- **WARNING:** Use of the PhysioGo.Lite Laser adjacent to or stacked with other equipment should be avoided because it could result in improper operation. If such use is necessary, the PhysioGo.Lite Laser and the other equipment should be observed to verify that they are operating normally.
- It is recommended to use original detachable parts, spare parts and equipment of Astar.
- **WARNING:** Use of detachable parts, transducers and cables other than those specified or provided by the manufacturer of this equipment could result in increased electromagnetic emissions or decreased electromagnetic immunity of this equipment and result in improper operation.
- **WARNING:** Portable RF communications equipment (including peripherals such as antenna cables and external antennas) should be used no closer than 30 cm (12 inches) to any part of the PhysioGo.Lite Laser, including cables specified by the manufacturer. Otherwise, degradation of the performance of this equipment could result.

The PhysioGo.Lite Laser meets requirements of electromagnetic interference emission and immunity standards and shall not pose a threat to correct operation of the other devices. Compliance levels for emissions and immunity are given in the chapter 11.2.

## 4.6 Operation of touch-sensitive displays

Table 4-1.Recommendations for the operation of touch screens

Type of display	Method of operation of the display
5" with a resistive touch panel	<p>Recommended:</p> <ul style="list-style-type: none"><li>• Pen designed for resistive screens – preferably with a narrow plastic tip</li></ul> <p>Admissible:</p> <ul style="list-style-type: none"><li>• Operator's finger – much lower comfort of operation compared to the pen</li></ul>

## 4.7 Applied parts

The PhysioGo.Lite Laser unit has one type of applied part of BF type. It includes:

- point laser applicators,
- scanning applicator,
- cluster applicator,
- laser applicators sockets,
- laser applicators plugs with cables.

Elements of applied part are connected.

In general laser applicators do not require physical contact with patient's body during normal use. So, they do not come under the definition of the applied part, concerning the basic standard for the safety of medical electrical equipment (in Poland PN-EN 60601-1, in Europe EN 60601-1, both based on IEC 60601-1), but they are treated as applied parts (there are some indications to perform treatment with contact method, for point laser applicators).

The specification of the leads, along with the location of the output sockets and the characteristics applicators are described in detail in the chapters 5.1 and 5.7. The symbol of applied part type BF is presented on the label.

## 4.8 Essential performance

For the PhysioGo.Lite Laser device, the essential performance means the emission of laser radiation with specified output power, specified wavelength and with specified beam parameters, in a mode:

- continuous or pulsed (with a specific duty factor and pulse frequency),
- using continuous and/or pulsed wave radiation sources,

not causing long term deterioration of the patient's health with preservation of the class 3B laser product parameters. The device meets the requirements of IEC 60601-2-22 standard, which specifies permissible deviation of output power from the set value.



#### 4.8.1 Test of essential performance and basic safety

Calibrating or servicing the device shall be carried out by the manufacturer or an authorized service personnel in accordance with separate guidelines. If the warnings given in this manual are followed, there is no risk for persons performing the above-mentioned activities.

The user of unit must perform technical inspection of the unit at year's intervals. The inspection must be performed by a unit authorized by the manufacturer. The inspection is performed at the user's expense.

Table 4-2. Essential performance and basic safety testing recommendations

Test item	Method of checking	Acceptance criteria	Required measuring equipment
Safety test: <ul style="list-style-type: none"> <li>patient leakage current measurement,</li> <li>touch current measurement,</li> <li>insulation resistance if necessary</li> </ul>	The manufacturer allows the methods compliant with the requirements of the standards: <ul style="list-style-type: none"> <li>IEC 60601-1</li> <li>IEC 62353</li> </ul>	The measurement results are within the limits specified by the applied standard	Safety tester meeting the: <ul style="list-style-type: none"> <li>IEC 60601-1</li> <li>IEC 62353 requirements</li> </ul>
Control of correctness of the performed self-test	Visual inspection	No errors	No requirements
Evaluation of keyboard function and operation	Manual and visual inspection	The keys respond properly to pressure	No requirements
Evaluation of touchscreen function and operation	Manual and visual inspection	The touch panel responds correctly to pressing	No requirements
Inspection of the controller condition for casing defects and damage of sockets	Visual inspection	No deformation or cracks of the casing Undamaged sockets No loosened sockets	No requirements
Inspection of the laser applicators condition for casing defects and damage of interconnecting cables and connectors	Visual inspection	No deformation or cracks of the casing No tear and bending of cables Insulation Undamaged connectors	No requirements
Inspection of the SMPS condition for casing defects and damage of interconnecting cables and connectors	Visual inspection	No deformation or cracks of the casing No tear and bending of cable Insulation Undamaged connector	No requirements
Test of the power emitted by laser applicators	The manufacturer allows the methods compliant with the requirements of the IEC 60601-2-22 standard	The accuracy of the power indication is within a tolerance of $\pm 20\%$	Laser power meter

The inspection must also include control over the quality of applied detachable parts and treatment materials. Positive result of the technical inspection confirms that basic safety and essential performance is maintained. No action is required to maintain basic safety and essential performance with respect to electromagnetic interference during device "life time".



## 4.9 Eye protection

Astar recommends the following types of protective goggles:

- models with **AST**, **TP2**, **ML3** and **DI4** filters – manufactured by **NoIR**, optical density and spectral ranges are shown in the tables below:

Table 4-3. Parameters of AST filter

Spectral range [nm]	Optical density	Symbol
650-670	2+	DIR LB2
660	6+	DIR LB6
808-825	6+	DIR LB5

Table 4-4. Parameters of TP2 filter

Spectral range [nm]	Optical density	Symbol
650-<655	2+	DIR LB2
655-685	3+	DIR LB3
>685-690	2+	DIR LB2
770-<785	2+	DIR LB2
785-830	3+	DIR LB3
>830-845	2+	DIR LB2

Table 4-5. Parameters of ML3 filter

Spectral range [nm]	Optical density	Symbol
190-400	5+	190 – 315 nm D LB7 + IR LB4 >315-395 D LB5 + IRM LB6
630-660	3+	DIR LB3
660-670	2+	DIR LB2
800-915	3+	DIR LB3
780-920	2+	DIR LB2

Table 4-6. Parameters of DI4 filter

Spectral range [nm]	Optical density	Symbol
190-400	5+	190 – 315 nm D L7 + R L4 >315-400 D L5 + R L6
625-850	4+	625-830 DR LB4
660-835	5+	625-670 + >800-830 I LB4 >830-850 DIR LB3 >850-860 DIR LB2
633	5+	>670-800 I LB5 10600 DI LB2

- model with **31-21128** filter – manufactured by **Honeywell** (formerly Sperian), optical density and spectral ranges are shown in the table below:

Table 4-7. Parameters of 31-21128 filter

Spectral range [nm]	Optical density	Symbol
630-730	4+	DIR L4
770-1070	4+	DIR L4

- models with **P1L22** and **P1H03** filters – manufactured by **Laservision**, optical density and spectral ranges are shown in the tables below:

Table 4-8. Parameters of P1L22 filter

Spectral range [nm]	Optical density	Symbol
>315 - 375	8+	D LB6+ IR LB8 + M LB7Y
>375 - 378	6+	DIRM LB6
>378 - 382	4+	DIRM LB4
625 - <636	2+	DIRM LB2
636 - <640	4+	DIRM LB4
640 - 658	5+	DIRM LB5
>658 - 662	4+	DIRM LB4
>662 - 668	2+	DIRM LB2
797 - <804	2+	DIRM LB2
804 - <806	4+	DIRM LB4
806 - <809	5+	DIRM LB5
809 - 824	6+	D LB6 + I LB6Y + RM LB6
>824 - 827	5+	DIRM LB5
>827 - 829	4+	DIRM LB4
>829 - 836	2+	DIRM LB2

Table 4-9. Parameters of P1H03 filter

Spectral range [nm]	Optical density	Symbol
540 - <578	1+	DIRM LB1
578 - <595	2+	DIRM LB2
595 - <610	3+	DIRM LB3
610 - <630	5+	DIRM LB5
630 - <660	6+	DIRM LB6
660 - 775	7+	D LB6 + IR LB7 + M LB7Y
>775 - 790	6+	DIRM LB6
>790 - 800	5+	DIRM LB5
>800 - 820	4+	DIRM LB4
>820 - 835	3+	DIRM LB3
>835 - 850	2+	DIRM LB2
>850 - 870	1+	DIRM LB1

The above-mentioned models provide an adequate level of safety for the patient and the user during laser therapy treatment with the use of applicators handled by any PhysioGo.Lite Laser unit model.

It is admissible to wear other types of protective goggles under condition that appropriate level of safety is guaranteed by their manufacturer (they must meet requirements of EN207/EN 208 standard, feature CE marking and declaration of conformity).



## 4.10 Laser labels

The unit is equipped with information labels on laser radiation and warnings against it. The user is obliged to visibly mark with them the room, where the laser therapy treatment procedures are performed. A label must be stuck in such a way that the longer ray, which connects the triangle with point in the center of the label, must be on the right. The background of labels is yellow, framed and texts are in black.

Label patterns:

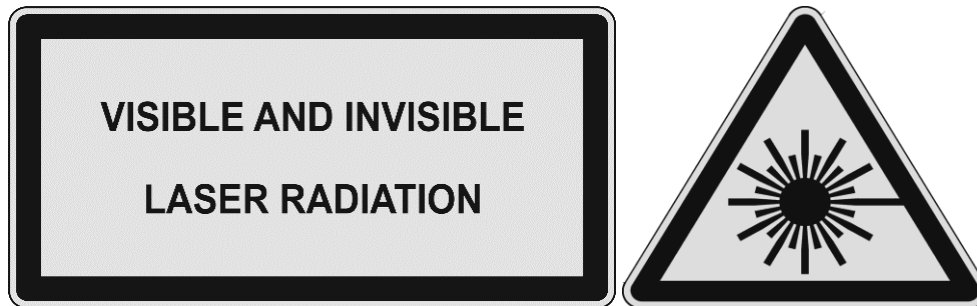

Figure 4-2 Labels for marking the room, where laser therapy treatment procedures are performed



Figure 4-3 Laser label of the unit



Figure 4-4 Labels of point applicators

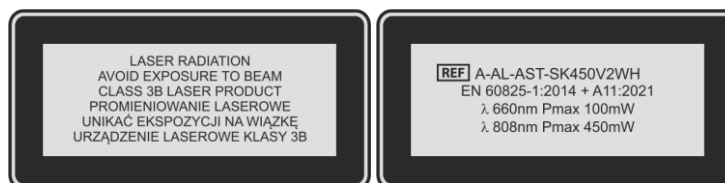

Figure 4-5 Labels of scanning applicator



Figure 4-6 Labels of cluster applicator

## 4.11 Disposal

In case, when the disposal of the unit will become necessary (e.g. after elapse of its service life), please contact the manufacturer or manufacturer representative, which must react in an appropriate way i.e. collecting the unit from the user. The user may also contact companies specialized in removal and/or disposal of electrical devices or computer equipment. Under no circumstances should you place the unit along with other wastes. The name plate includes an appropriate symbol (see Appendix at the end of the User Guide).

The unit is marked with an appropriate symbol complying with the directive on waste electrical and electronic equipment (WEEE) – see table with description of the symbols used to label the product presented in Appendix **A**.

## 5. Unit description

---

### 5.1 General characteristics

Laser therapy PhysioGo.Lite Laser unit is a highly specialized medical device based on modern microprocessor platform.

The unit has a plastic console casing. It is equipped with a color touch LCD display with a diagonal of 12.7 cm (5"). On the rear side of the casing are located:

- power switch,
- fuse socket,
- mains socket,
- integrated remote interlock connector/ emergency laser stop socket,
- sockets for connection of detachable parts.

General view of the unit is presented in Figure 5-1, view of the rear panel in Figure 5-2.



Figure 5-1 General view



Figure 5-2 Unit rear panel view





## 5.2 Front panel

Arrangement of front panel components is shown in Figure 5-3.



Figure 5-3 Arrangement of front panel components

Table 5-1. Description of front panel components

Symbol	Description	Function
1.	Liquid crystal display	The unit is equipped with a touch-sensitive display. The screen clearly displays all information related to the device operation.
2.	Operation status and battery level indicators	See 5.2.1.
3.	Turn ON/OFF key (STANDBY)	This key is marked with the symbol  . In order to activate the unit in the case of battery operation, please hold on for at least 5 seconds. Extension of the holding time prevents unintentional activation during transport.
4.	Edit keys	These keys are marked with symbols   . Pressing any of them results in change of value of edited parameter or setting in setup mode.  Keep holding the key down to change a parameter quicker.
5.	START/STOP key	This key is marked with the symbol  . It is used with the sequence of starting emission of laser radiation. Its pressing, after setting of treatment procedure parameters, activates status of unit readiness to emit laser radiation (laser probe, cluster applicator) or starts emission (scanning applicator). Pressing of this key once again stops the treatment procedure. The emission of laser radiation is stopped.

### 5.2.1 Operation status and battery level indicators

Symbols and description of unit operation status signaled by LED indicators are summarized in the table below.

Table 5-2. Non-battery unit



Symbol	Color	Indicator status	Mains switch	Explanation
 Operation status indicator	Green	No light	OFF („0“)	The unit is turned off. Turning ON: <ul style="list-style-type: none"> <li>• Turn the mains switch on</li> <li>• Press the STANDBY key</li> </ul>
		Blinks	ON („1“)	Unit is in standby mode. Turning ON: <ul style="list-style-type: none"> <li>• Press the STANDBY key</li> </ul>
		Steady light	ON („1“)	The unit is ready for operation.
 Battery level indicator	Orange	No light	---	No battery.

Table 5-3. Unit equipped with battery



Symbol	Color	Indicator status		Mains switch	Explanation
		Readiness	Battery		
 	Green	No light	No light	OFF („0“)	The unit is turned off. Turning ON: <ul style="list-style-type: none"> <li>• Turn the mains switch on</li> <li>• Press the STANDBY key</li> </ul>
		Blinks slowly	No light	ON („1“) Mains cable connected	Unit is in standby mode. Battery is fully charged. Turning ON: <ul style="list-style-type: none"> <li>• Press the STANDBY key</li> </ul>
		Blinks slowly	Blinks slowly	ON („1“) Mains cable connected	Unit is in standby mode. Battery is being charged. Turning ON: <ul style="list-style-type: none"> <li>• Press the STANDBY key</li> </ul>
	Orange	Steady light	Blinks slowly	ON („1“) Mains cable connected	The unit is turned on. Battery is being charged.
		Steady light	No light	ON („1“) Mains cable connected	The unit is turned on. Battery is fully charged.
		No light	Steady light	ON („1“) Mains cable disconnected	Unit is running on battery supply.

Table 5-4. Additional information about battery indicator

Symbol	Color	Battery indicator status	Explanation
	Orange	Blinks fast for 4 seconds	Battery module has been disconnected.
		3 pulses	Battery low.
		5 pulses	Battery error. Turn the unit off using STANDBY key and switch the power switch off. Restart it after 10 seconds. If the problem repeats, contact your authorized service.

### 5.3 Battery installation

PhysioGo.Lite Laser can be optionally fitted with a battery. Users can install the battery by themselves.



**WARNING:** Before performing the below actions, turn the device power off and disconnect the SMPS from the mains.

The battery assembly method is illustrated in the following figures.

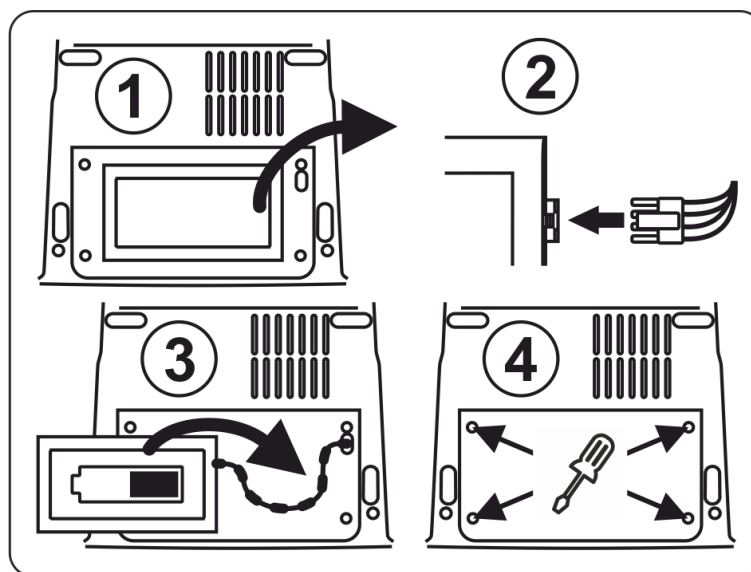

Figure 5-4 The battery installation method

Table 5-5. The battery installation method

Action no.:	Description
1.	Turn the device over.
	Unscrew four battery cover screws.
	Remove the stabilizing cartridge. Keep it for further use.
2.	Connect battery cable to the battery socket.
3.	Place the battery in the enclosure.
4.	Reinstall battery cover by means of 4 screws.
	Turn the device over to its normal position. Connect power supply to the mains. Switch on the unit and check if it starts correctly.

The above information is summarized on labels placed on the battery cover.

## 5.4 Name plate

The name plate is located on the bottom of unit casing. Among others there are following data on the name plate (see **Appendix A**):

- device version,
- UDI-DI code,
- serial number and manufacture date – UDI-PI code,
- nominal voltage and frequency of operation,
- type of applied fuses,
- IP protection class,
- manufacturer's data.

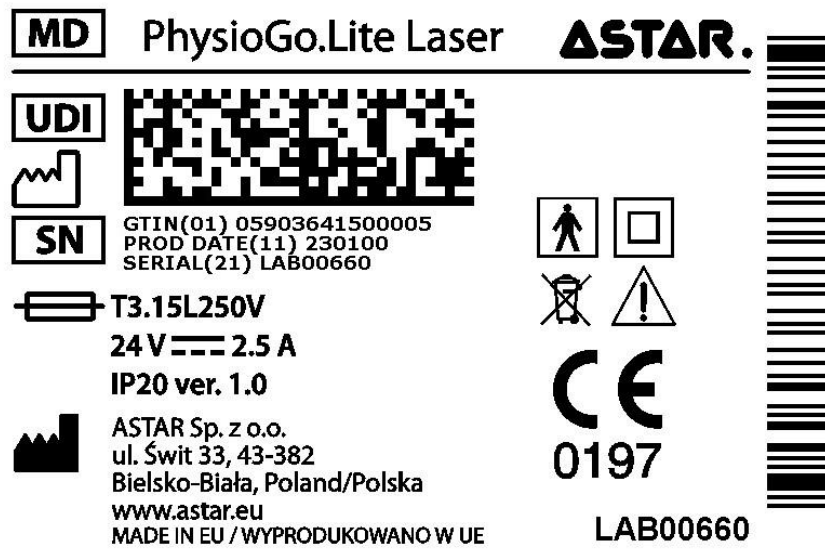

Figure 5-5 Name plate of PhysioGo.Lite Laser

Laser label is located at the bottom of unit casing (see **chapter 4.10**).

### 5.4.1 UDI code

Regulation (EU) 2017/745 of The European Parliament and of The Council defines “Unique Device Identifier” (‘UDI’) as a series of numeric or alphanumeric characters that is created through internationally accepted device identification and coding standards and that allows unambiguous identification of specific devices on the market (def.15). The code development process is supported by entities designated by Commission (EU) Implementing Decision. The manufacturer has chosen to cooperate with the GS1 organization.



Figure 5-6 UDI code – example

ID	Symbol	Description	UDI code part
(01)	GTIN	Unique GTIN code assigned by GS1 organization	UDI-DI
(11)	PROD DATE	Production date format: YYMMDD A record limited to the year and month is acceptable in the format: YYMM00	UDI-PI
(21)	SERIAL	Serial number	

## 5.5 Laser radiation measurement

Laser power radiation measurements are based on a built-in laser applicator photodetectors. An exception to this rule is cluster laser applicator, where the measurements should be performed with the use of an external laser power radiation meter.



## 5.6 Protection

### 5.6.1 Remote interlock connector

The remote interlock connector is one of the components which ensure laser system operation safety. The manufacturer provides (as a standard part of the unit) the integrated plug marked with DOOR symbol, which enables to connect the emergency laser stop and remote interlock connector in one safety system.

Connection of DOOR plug to dedicated socket (details – see 4.3) enables performance of treatment procedures without the need to apply additional means. If the plug is not connected, the start of the treatment won't be possible. An acoustic signal will be heard and the suitable message will be displayed when attempting to start the treatment.

In a situation, when the user utilizes a composed system as a remote interlock connector, which for example consists of the front door lock or other stationary lock, additional sensors together with cables, the DOOR plug can be utilized and connected with such a system. The manufacturer recommends the use of magnetic sensors to detect physical door opening (reed switch or, for more demanding systems, a magnetic safety sensor).

When the remote interlock connector is activated (unplugging, door opening), a message appears on the screen. When the key  is pressed, the device switches to the therapy selection mode or the applicator selection screen. This prevents from unwanted laser emission.

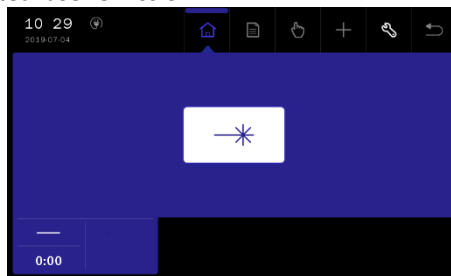



Figure 5-7 Therapy selection mode screen

The operation can be continued when the remote interlock connector is deactivated (plugging, door closing) and a therapy is chosen with the button  or the applicator is selected.



### 5.6.2 Emergency laser stop

This is an optional module with an emergency stop pushbutton (mushroom head), manufactured according to the IEC/EN 60947-5-1 standard, used for immediate interruption of laser emission in case of danger. The module is fitted with a socket to connect the remote interlock connector, which significantly facilitates the safety system organization (see: 5.6.1). The base of the module is fitted with magnets, which allow their easy placement on the dedicated trolley with metal shelves (e.g. Versa or Versa X).



Figure 5-8 The view of the emergency laser stop

In case of danger and when the emergency stop is used, before continuing the normal use, the following procedures have to be performed — deactivation procedure:

Step	Description
1.	Click the UNIT ON / OFF (STANDBY) button on the front panel  .
2.	After clicking the button, a message will appear on the display: <div data-bbox="568 759 1023 994" style="border: 1px solid black; padding: 5px; margin: 10px 0;"> <p style="text-align: center;">⚠ CAUTION</p> <hr/> <p style="text-align: center;">Are you sure to switch off the unit?</p> <p style="text-align: right;"> <input type="button" value="✖"/> <input type="button" value="✔"/> </p> </div>
3.	Press  to shut down the system correctly.
4.	Twist the mushroom head in the direction of the arrow to unlock it.
5.	Click the UNIT ON / OFF (STANDBY) button on the front panel  , to turn the unit on.

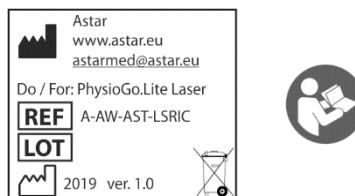

Figure 5-9 Emergency laser stop label sample

## 5.7 Laser applicators

Available types of point laser applicators:

- 80RDV3 – red light probe, wavelength 660 nm with maximum output power 80 mW in the continuous and pulse operation mode,
- 400IRV3 – infrared light probe, wavelength 808 nm with maximum output power 400 mW in the continuous and pulse operation mode.



Available types of scanning laser applicators:

- SKW2-450 / SK2-450 – wavelength 808 nm with maximum output power 450 mW and wavelength 660 nm with maximum output power 100 mW.

Available types of cluster laser applicators:

- CL1800WH / CL1800 – 4 laser diodes – wavelength 808 nm with maximum output power 400 mW and 5 laser diodes – wavelength 660 nm and maximum output power 40 mW, in abbreviated form R+IR 5x40+4x400.

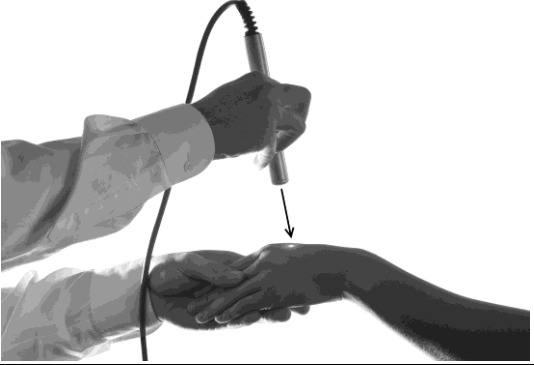
Table 5-6. Schemes of laser beams waveforms in the following laser applicators

Applicator type / Description	Figure
<p><b>Point laser applicators (Laser probes)</b></p> <p>Laser radiation is directed manually by the operator into the patient's body who is undergoing the therapy. The laser beam is collimated by a lens, which is also the laser aperture. The output laser beam is divergent.</p>	
<p><b>Scanning laser applicators</b></p> <p>Laser radiation is directed automatically after setting the applicator into the patient's body who is undergoing the therapy.</p> <p>The laser beam is collimated inside the applicator by a lens system and outputted by a polycarbonate glass, which is also the laser aperture. The output laser beam is divergent.</p>	
<p><b>Cluster laser applicator</b></p> <p>Laser radiation is directed manually by the operator into the patient's body who is undergoing the therapy. Laser beams from individual sources are not collimated. They pass through a clear polycarbonate plate, which is also the laser aperture. Laser beams are divergent.</p>	

All devices and applicator parameters are described in detail in chapters 8 and 11.



Figure 5-10 Point laser applicators and optical fibers

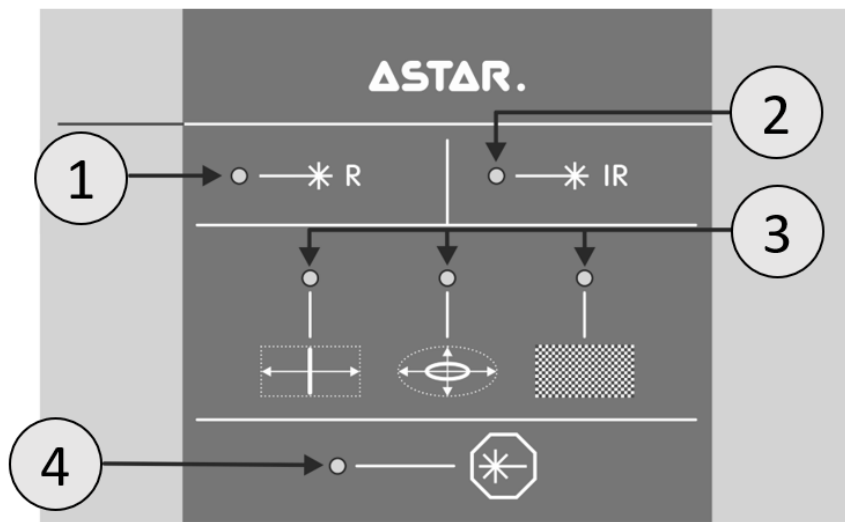

Figure 5-11 Laser scanning applicator – panel description

Table 5-7. Laser scanning applicator – panel description

Symbol	Description
1.	Radiation wavelength 660 nm selection indicator
2.	Radiation wavelength 808 nm selection indicator
3.	Field shape selection indicator
4.	Output radiation indicator



Figure 5-12 Scanning and cluster laser applicators

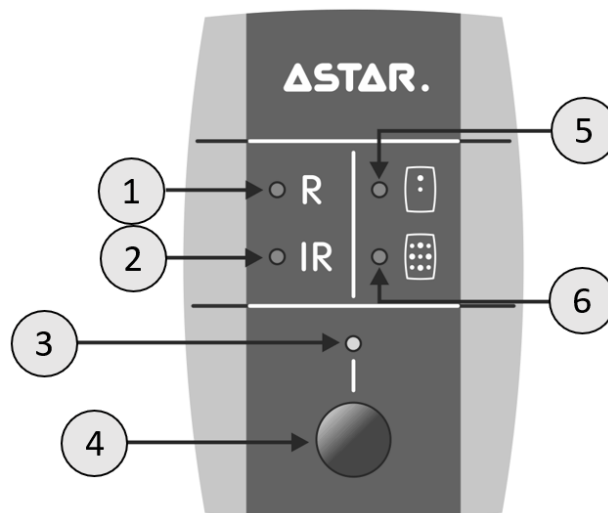

Figure 5-13 Laser cluster applicator – panel description

Table 5-8. Laser cluster applicator – panel description

Symbol	Description
1.	Radiation wavelength 660 nm selection indicator
2.	Radiation wavelength 808 nm selection indicator
3.	Output radiation indicator
4.	Emission start/stop button
5.	Single-diode mode indicator
6.	Multi-diode mode indicator

## 6. Device installation and start-up

---

### 6.1 Unit installation



**The first installation should be performed by a qualified manufacturer's or distributor's representative!**

After removing the unit from the carton, check if the complete unit has been delivered. In case of any inconsistencies contact the distributor or manufacturer.



**After removing the unit from transportation packaging wait approximately two hours before proceeding to next installation steps. This is aimed at adaptation of the unit to conditions in operation room.**

The unit shall be placed on a table or in a cabinet near mains socket with power input 100-240V and frequency 50/60 Hz. It is recommended to place the unit at such a height that it would enable convenient operation from the front panel.

The light shall enable easy readout of display indicators, however the unit shall not be exposed to direct sunlight.



**Laser applicators may only be connected to the sockets when the power supply is switched off. Connecting of laser applicators with the power supply on may cause irreversible damage of the laser diode which is beyond the scope of warranty repairs! Applicator connected when the mains supply is on will not be detected and its use will not be possible!**

#### 6.1.1 Assembling of the holders

According to possessed detachable parts to the unit casing you can mount:

- a holder / holders for point laser applicators,
- a holder for cluster laser applicator – on the left side of the casing only.

In order to mount the holder:

Step	Description
1.	Loosen the clasps and remove the holder masking cover – black parts of the casing located on the left and right side of the screen.
2.	Adjust the holders and screw bolts in according to Figure 6-1 and Figure 6-2.
3.	Reattach the masking cover.

Method of mounting the holders is presented in the following figures.

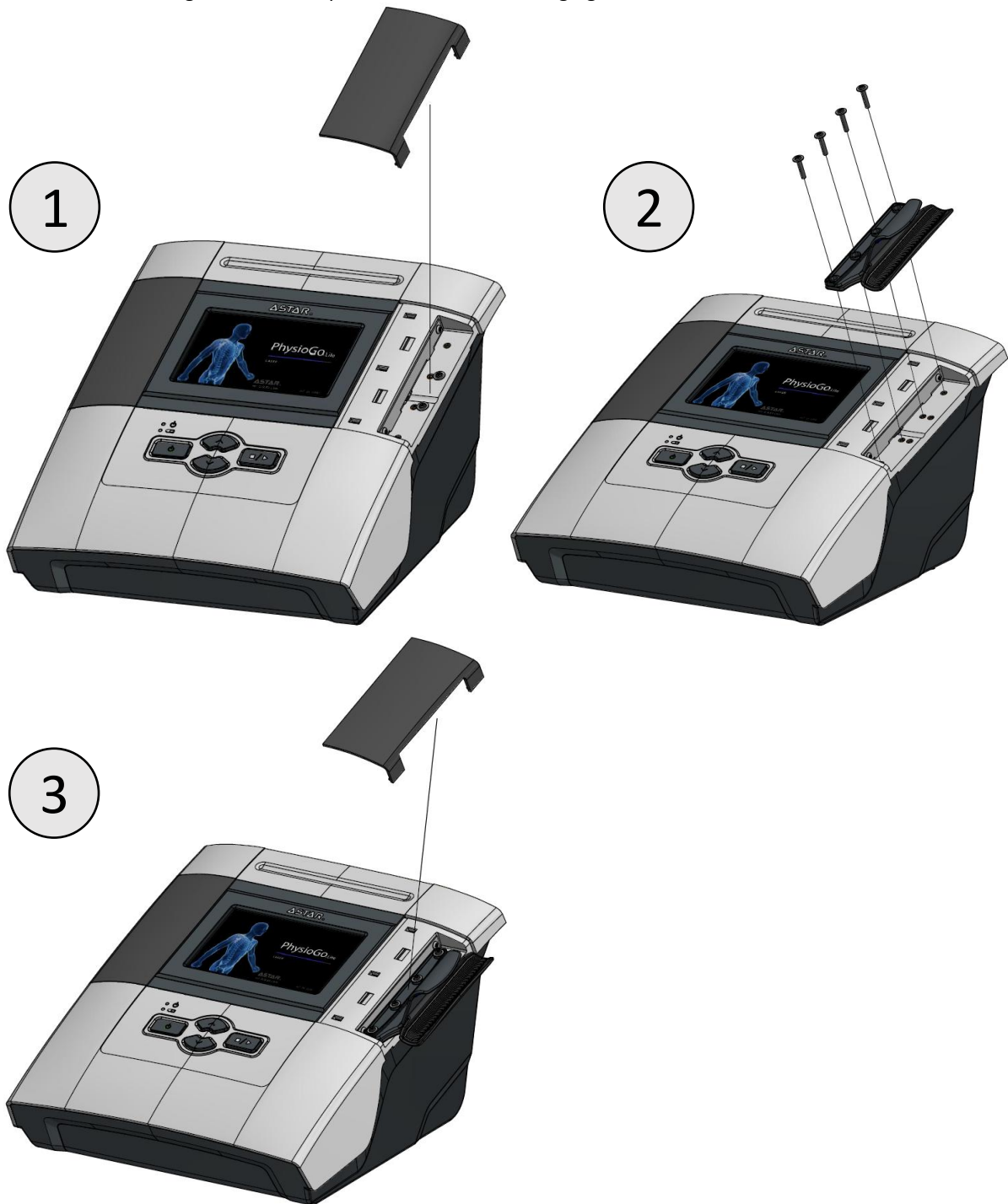

Figure 6-1 Method of mounting the point applicator holder

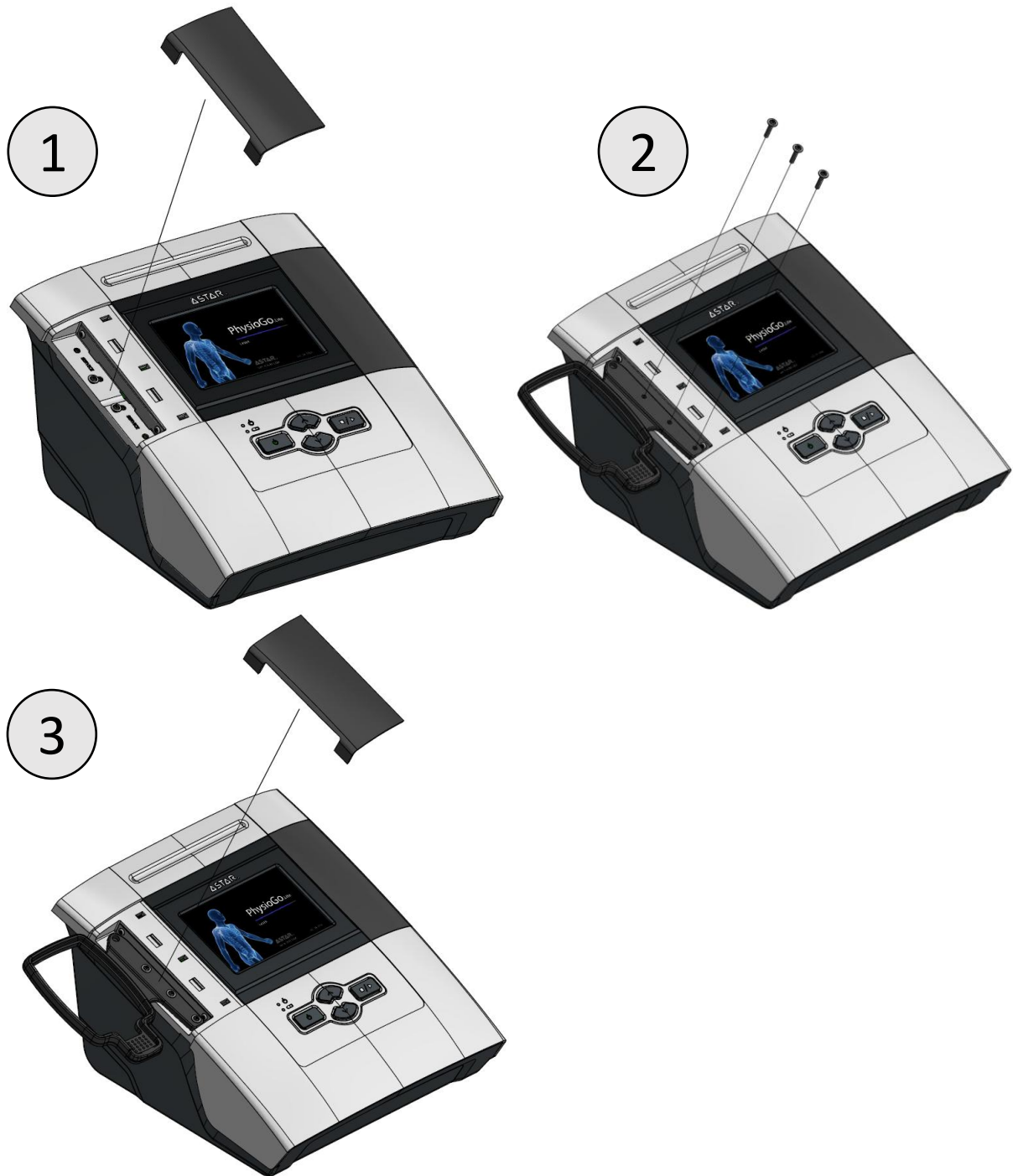

Figure 6-2 Method of mounting the cluster applicator holder

### 6.1.2 Connection of laser applicators

Laser applicators should be connected to laser therapy sockets according to Figure 6-3. Meaning of laser applicator symbols is shown in the table below. All connectors are protected against pulling out. When plugging a connector in, twist the thread to secure it.

Symbol	Types of supported applicators
	Red light probe, type 80RDV3
	Infrared radiation probe, type 400IRV3
	Scanning laser applicator, type SKW2-450 / SK2-450
	Cluster laser applicator, type CL1800WH / CL1800

**Note:**

- laser probes may be connected to sockets 1 and 2,
- scanning applicator may be connected only to socket 3,
- cluster applicator may be connected only to socket 3.

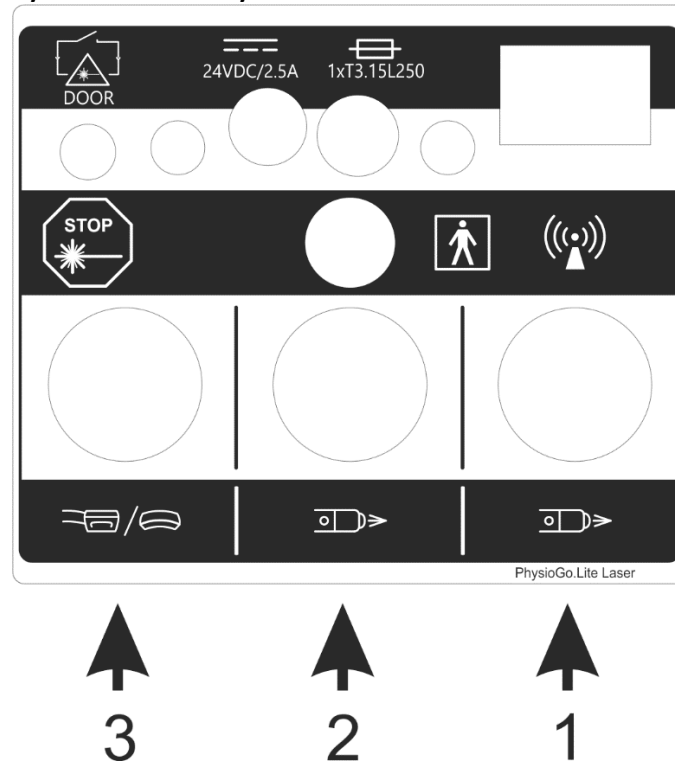

Figure 6-3 Laser therapy sockets



In case of improper connection of the applicator, an error message appears on-screen and the device is blocked. When placing the applicator, make sure that the button does not enter between the arms of the holder, as this may break the button.

### 6.1.3 Laser scanner stand



#### Operating notes for operation with the scanning laser applicator mounted on a stand:

- The stand with a unit and applicators shall be placed near mains socket, so that the change of stand position is not limited by the mains cable.
- Screw the power supply holder to the stand shelf using two bolts.
- Remove the foil protecting the glue layer from the magnetic tape. Stick the tape in the middle of the power supply on the power indicator side, as presented in Figure 6-4.

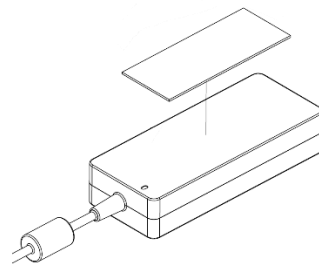

Figure 6-4 Sticking the magnetic tape to the power supply

- It is recommended to loosen or turn (depend on need) handwheel locking the arm of the stand or handwheel locking the laser scanner to adjust the right scanner position. Both handwheels are presented in Figure 6-5.

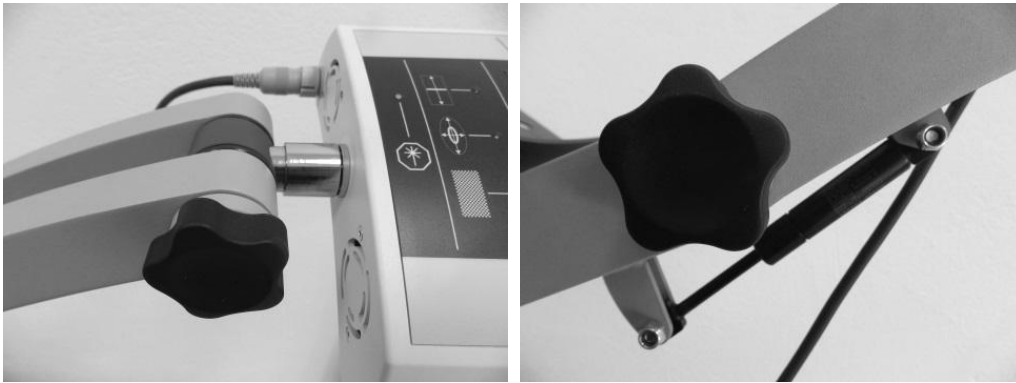

Figure 6-5 Handwheels – scanner and arm of the stand

- To protect the stand from unintentional change of its position it is recommended to lock wheel brakes – brake should be pressed to the floor. To release the brake, lift it up (wheel with brake is shown in the figure Figure 6-6).

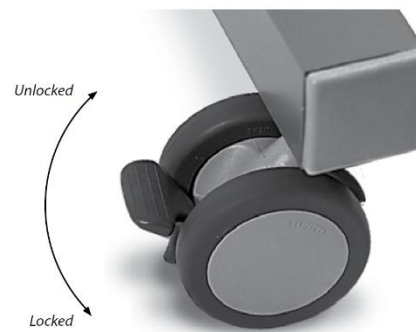

Figure 6-6 Wheel with brake

- To disassemble the controller from the shelf it is recommended to unscrew the bolts mounted to the shelf.
- To disassemble the scanning applicator, with one hand pull the mounting protection ring and using the other one release the scanner from the mounting socket.
- Other interconnecting cables shall be located to enable free change of position of the stand and scanning position adjustment.



Figure 6-7 The view of the device on a stand

- Connection between scanning applicator and controller should be done with cable run inside the stand. It must be connected to the socket on the rear casing panel of the scanner applicator and socket 3 located on the unit – see the Figure 6-3.

#### 6.1.4 Integrated emergency laser stop and remote interlock connector (DOOR) installation

To perform laser therapy treatments, plug the DOOR connector to the socket presented in the Figure 6-8.

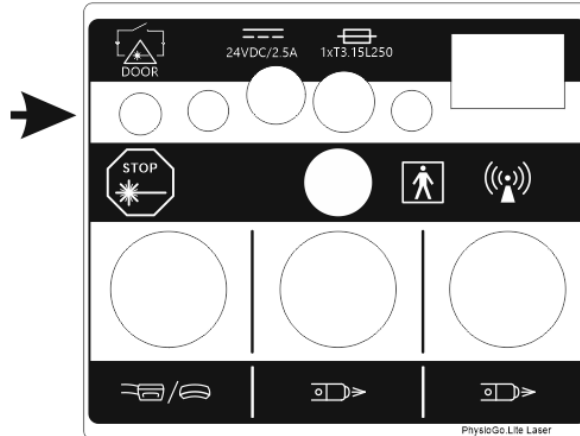





Figure 6-8 Remote interlock connector socket

## 6.2 First operation

Connect the power supply to mains supply with delivered detachable mains cable. Connect the power supply cord to the device socket marked with symbol . Switch the power switch on. Then press the STANDBY key  to start the operation. After switching the mains supply on proper work of all blocks are tested.

In the case of battery operation, please hold on for at least 5 seconds the STANDBY key . Extension of the holding time prevents unintentional activation during transport.



**If after switching on mains supply the display is illegible and no light indicator is illuminated, check whether mains fuse or mains cable operate correctly. Care shall be given to apply fuses with rating given on the name plate. If fuse and cables are working properly, contact the authorized service.**

**If the self-test results in appearing on the display the information about unit or connected applicator defect along with the error code, turn the unit off and contact the authorized service.**

Due to safety reasons the unit was equipped with software and hardware lock of laser applicators operation. The operation is possible only after correct entry of unique access code and inserting the integrated emergency stop and remote interlock connector (marked as DOOR) into DOOR socket, located on back panel of the enclosure (provided as a standard part of the unit).

The device is properly installed and is ready to perform safely and as intended by the manufacturer if:

- it is connected to a mains socket with a voltage in the range 100-240 V and a frequency of 50/60 Hz by a specified SMPS,
- appropriate detachable parts of the apparatus are connected to it for therapeutic treatments intended by the user,
- after switching on the unit, the display is legible,
- self-test result is positive.

Do not touch the screen during the system start-up.

#### 6.2.1 Laser therapy access code



The code which allows for laser applicator operation has the shape of: PLL

Entering an incorrect code prevents the device operation.



## 6.3 Setup mode

### 6.3.1 Basic information

Keyboard components designed for the unit operation are called "**keys**".

The area on the screen, where after its pressing a specific unit reaction is followed, is called "**button**".

The area on the screen that has the possibility to select or deselect any item, is called "**selection field**".

To enter <b>Setup</b> mode, press	
To leave <b>Setup</b> mode, press	
To go back one level, press	



Setup mode is available only if the treatment is not performed. Some setting options depend on the connected detachable parts. In the absence of some detachable parts, the options will not be available.

### 6.3.2 Language

Information on the display may be presented in different language versions (depending on the software version). The user is free to select language options.

To set the language version, press the **Language** button in the list of setup options, then press the desired version. Language version change is immediate.

### 6.3.3 Global settings

#### 6.3.3.1 Date and time

In this section there is a possibility to adjust date and time. To change these settings, press the button **Edit**. Using arrows, set the required value. Confirm settings using **Set** button or leave the edition mode by pressing **Cancel**.

#### 6.3.3.2 Sounds



The user may configure settings of acoustic signals, which occur during unit operation. Description of available configuration options:

- Keys sound
- Sound during treatment
- End of treatment sound
- Warning sounds
- Initial sound
- Repeatable sound of the end of treatment – if the option is selected, the sound will be played until the moment when an operator reacts, with the option unchecked, the sound will be active for 30 seconds.

In order to set the appropriate option, select or clear the selection field by its pressing.

#### 6.3.3.3 Volume

The user may adjust sound volume level. To perform this action:

- press the volume bar at desired place, or
- use buttons   on the screen.

### 6.3.3.4 Display

The user may adjust display brightness level. To perform this action:

- press the value bar at desired place, or
- use buttons   on the screen

## 6.3.4 Functional settings

### 6.3.4.1 Channel operation mode selection

This function allows the user to set preferred style of unit operation.

Option	Explanation
Manual mode – automatically	After therapy selection, the unit is set in manual mode of the operation.
Program mode – automatically	After therapy selection, the unit is set in program mode of the operation.
Mode selection pop-up	After therapy selection, the unit displays a window with a list of operation mode selection options.

In order to set the appropriate option, select or clear the selection field by its pressing.

### 6.3.4.2 Program groups / medical fields

This function allows the user to set filters of available program mode options according to the preferred program groups or medical fields. In order to set the appropriate option, select or clear the selection field by its pressing.

For program groups, the following options are available:

- Preset programs
- User programs
- Voll acupuncture programs – only for laser probes
- Nogier acupuncture programs – only for laser probes

For medical fields, instead of the preset treatment programs the following options classified by medical nomenclature are available (according to chosen applicator):

- Orthopedics
- Sports medicine
- Aesthetic medicine
- Rheumatology
- Neurology
- Dermatology
- Angiology

The classification of preset treatment programs into the above-mentioned categories do not limit their applications in other fields, according to the knowledge and experience of doctors and physiotherapists.

### 6.3.4.3 Energy saving mode

When the mode is activated, the device switches automatically into the standby mode after one hour of inactivity. The laser scanner switches off after 30 minutes of inactivity.

## 6.3.5 Control functions

### 6.3.5.1 Miscellaneous

In this section there is a possibility to manage some basic service functions:

- **Delete user programs** – button allows you to remove user-defined programs.
- **Calibrate the touch panel** – button starts the display calibration procedure. Follow the messages on the screen. First, touch three points, then validate the operation by touching five points on the screen.



You can also calibrate the display by pressing the   key combination simultaneously when starting the device. The progress bar will change to green and the calibration screen will be displayed when started.

- **Test the touch panel** – button allows you to check the touch screen operation – on the touched spots an indicator occurs:
  - red at the pressed spot,
  - yellow at the pressure detection spots,
  - white at the spot where the pen or finger is removed (it should coincide with the red one).
 Press the START/STOP key to exit the test mode.

### 6.3.5.2 Date of inspection

There is possibility to enter into the device the date of the next inspection – it will automatically remind you about the need to perform an annual technical inspection.

### 6.3.5.3 Laser applicators output power test



This function enables checking if the output power of laser radiation emitted by laser applicators is correct.

The applicator is chosen by pressing the relevant on-screen button: “Appl 1”, “Appl 2”, “Appl 3”.



**Laser output power measurement of point probes and scanning applicators is performed automatically, the results are displayed on the screen. Laser output power measurement of the cluster laser applicator is possible by the use of external radiation sensor.**

During this procedure it is recommended to follow the instructions shown on the display.

To measure output laser power of the laser applicator:

Step	Description
1.	Enter the setup mode. Select <b>Control functions</b> tab, then select <b>Laser applicators output power test</b> .
2.	Select the applicator. Connected applicator is identified in the <b>Accessory</b> field.
3.	Press <b>Run the power measurement</b> button.
4.	An instruction window depending on the type of tested applicator will appear on the screen. Follow the steps according to the instructions.
5.	Verify the measured value.
6.	To complete the procedure, press the button  according to the instruction.

If measurement power is different more than  $\pm 20\%$  from nominal power it is recommended to repeat the measurement. The cause of incorrect indication of emitted output power may be:

- fault of the laser applicator,
- heavily soiled laser diodes or optical elements.



**In case, when results of five consecutive measurements are incorrect, contact the authorized service.**

## 6.3.6 Information

### 6.3.6.1 Info

Provides information about the serial number, version of the unit, software, interface and software build date.

### 6.3.6.2 Manufacturer

Provides information about the manufacturer together with the contact details.

### 6.3.6.3 Distributor

Provides information about the distributor in a given country together with the contact details. The „Change contact data” button can be use only by authorized unit, after entering the access code. The full data consists of:

- the company name

- the company address
- the company website
- the company phone number
- the company e-mail

If data is not entered, the „----“ characters will be shown.

#### 6.3.6.4 Technical support

Provides information about technical staff (the manufacturer’s or distributor’s) in a given country together with the contact details. The „Change contact data“ button can be use only by authorized unit, after entering the access code. The full data consists of:

- the company name
- the company address
- the company website
- the company phone number
- the company e-mail

If data is not entered, the „----“ characters will be shown.

The „Show logs“ button supports service diagnostics, by displaying information about all saved device errors.



#### 6.3.6.5 Unit statistics

Provides information about the number of treatment procedures performed. Statistics can be deleted. If you want to delete statistics, press **Delete programs counters** button.

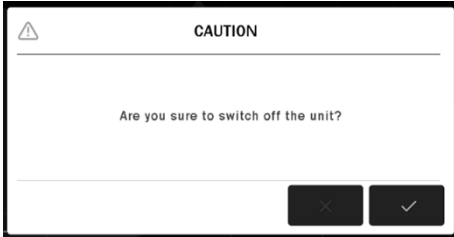

#### 6.3.6.6 Accessories statistics

There appears the information on connected detachable parts.

## 6.4 Transport position – the stand with scanning applicator

Step	Description
1.	Click the UNIT ON / OFF (STANDBY) button on the front panel  .
2.	A message will appear on the display: <div style="text-align: center; border: 1px solid black; padding: 10px; margin: 10px auto; width: fit-content;">  </div>
3.	Press  to shut down the system correctly.
4.	Disconnect the mains cable from the power supply.
5.	Then unlock the brakes and transport the stand.
6.	Transport the stand.
7.	After arranging the stand in the destination place, lock the brakes.
8.	Connect the mains cable to the power supply.

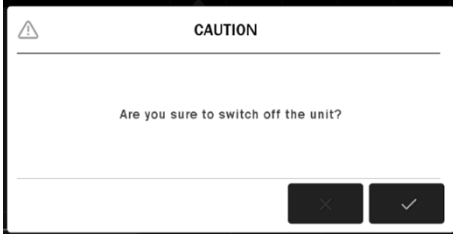
## 6.5 Transport position – trolley for the unit

Step	Description
1.	Click the UNIT ON / OFF (STANDBY) button on the front panel  .
	A message will appear on the display:
2.	
3.	Press  to shut down the system correctly.
4.	Disconnect from the controller the power cord and all applicators.
5.	Remove the device and applicators from the trolley.
6.	Then unlock all wheel brakes of the trolley.
7.	Transport the trolley. Move the device and applicators separately.
8.	After arranging the trolley in the destination place, lock the brakes.
9.	Place the device on the upper shelf. Reconnect the switched-mode power supply and the applicators.



## 7. Unit operation

The unit may operate in one of two modes:

- program mode,
- manual mode.



Notes – unit operation:

- In the program mode you can use preset procedures of treatment programs, as well as user-defined programs and sequences.
- In the program mode you cannot edit the preset programs parameters. However, they can be easily “copied” to the manual mode. In order to do it, press the button  .
- There is a possibility to repeat the completed treatment. In order to do it, press .

### 7.1 Patient preparation and treatment performance

#### 7.1.1 General information

To perform safe and effective treatment procedure you are obliged to:

- make sure, if there are no contraindications to perform the treatment,
- the patient should be placed in a comfortable position while providing relaxation of tissues in the treatment area, the patient should be in lying position in case of treatment performed near the head,
- sitting or reclining position should be applied to patients with respiratory disorders or breathing difficulties,
- inform the patient about the possible feelings occurring during treatment procedure.



The treatment effectiveness depends on the choice of parameters to the current patient's condition. The patient's condition changes over time. Its observation and assessment should take place before, during and after therapy. Such an action is necessary for changing the parameters in order to adapt them to the actual condition of the patient.

It is recommended to keep the records of treatment, including the parameters of the therapy, the area of treatment, treatment technique, dose and symptoms after therapy. If the treatment does not generate the intended effects, change of treatment parameters should be taken into consideration. It is necessary to continuously update knowledge and follow the references in the scope of therapy.

When performing therapy, it is recommended to follow the guidelines given in the following sections.

#### 7.1.2 Laser therapy

- Prior to treatment it is necessary to explain to each patient the applicable safety rules during laser therapy treatments. Prior to the treatment make the patient wear the appropriate protective goggles.
- Before the treatment it is necessary to check the efficiency of functioning of the device and to control condition of the applicator and periodic power measurement – see 6.3.5.3.
- Therapeutic dose is described as energy density and is expressed in J/cm<sup>2</sup>. Dose of radiation must be adapted to the goals of therapy.
- Technical parameters of the equipment, that is the wavelength and surface of an applicator, have direct impact on the dose of radiation.
- Methods of application (laser probes – contact or contactless, cluster applicator – contactless, scanning applicator – contactless) is adapted depending on the size of application area and the goal of therapy.
- It is necessary to follow the recommendations provided below when choosing energy density:
  - at the beginning of treatment series and in acute conditions it is necessary to use smaller doses up to 4 J/cm<sup>2</sup> – it is always necessary to observe the reaction of the patient's organism,
  - in chronic conditions – doses higher than 4 J/cm<sup>2</sup>.
- In therapy it is allowed to use the following application techniques:
  - single point or several points within a given area (e.g. painful points or acupuncture points, wound along the edges or within a small distance from the wound, within a joint),
  - grid method and scanning (large surfaces).

- In each technique it is necessary to ensure that the radiation beam is at right angle on the tissue.

## 7.2 Screen configuration

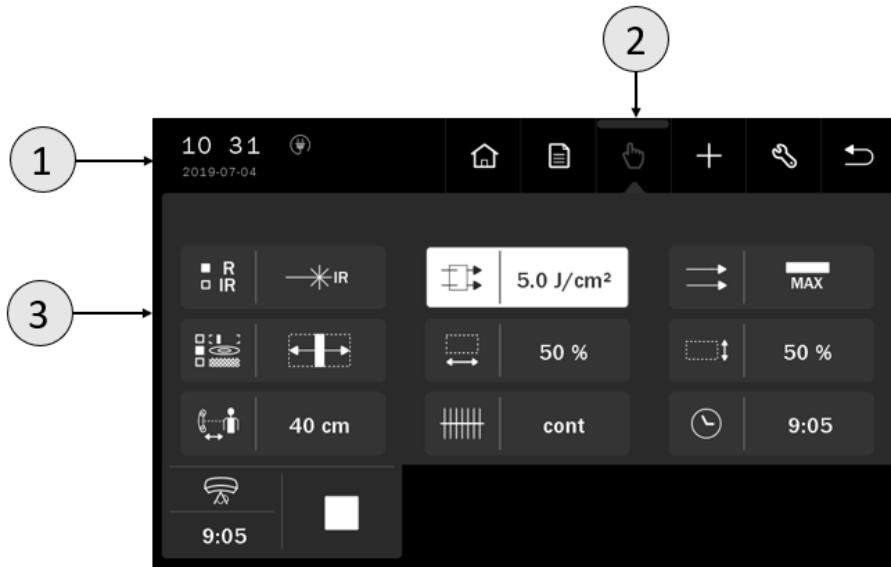

Figure 7-1 Field description

Symbol	Field	Description
1	Status tab	Date and time
		Battery – quality level battery charging symbols
		Mains cable connected
2	Main menu	Therapy and applicator selection menu
		Program mode
		Manual mode
		User-defined treatment programs edition mode
		Information mode
		Setup mode
		This field shows:
3	Edition field	<ul style="list-style-type: none"> <li>• available applicators</li> <li>• treatment parameters in manual mode</li> <li>• preset treatment program lists</li> <li>• user-defined program lists</li> <li>• settings</li> </ul>









**Note:** If the edition / main menu field is greyed out, it means that it is inactive.

## 7.3 General configuration

Channel	Applicator
1	<ul style="list-style-type: none"> <li>red light probe, type 80RDV3</li> <li>infrared light probe, type 400IRV3</li> <li>scanning laser applicator, type SKW2-450 or SK2-450</li> <li>cluster laser applicator, type CL1800WH or CL1800</li> </ul>

The table below explains the meaning of the symbols presented in tab:

Symbol	Description
	Selected laser point probes
	Selected scanning laser applicator
	Selected cluster laser applicator
	Ongoing treatment
	Treatment interrupted
	Pause
	Error (yellow symbol)

## 7.4 Display description

An example of the appearance of a treatment screen is presented below.

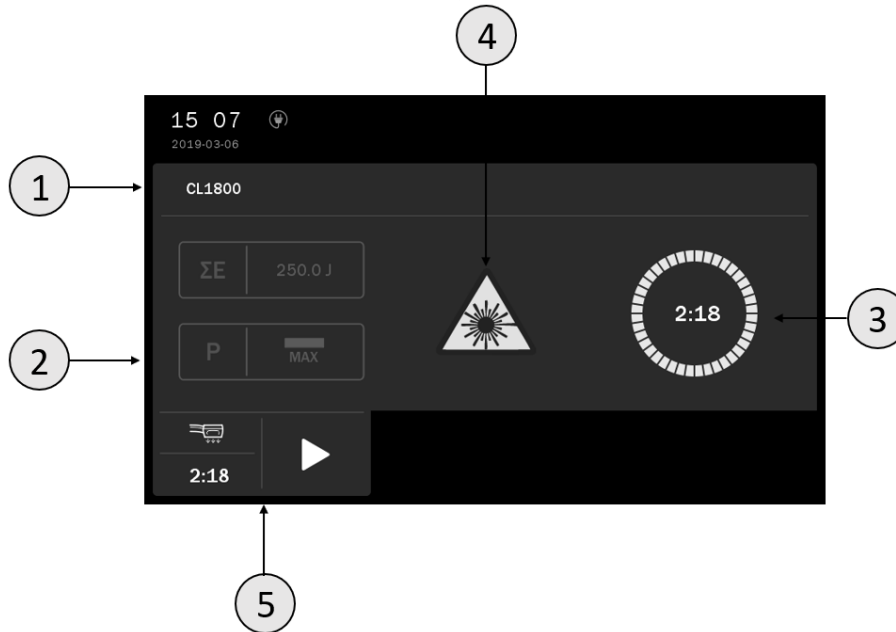



Figure 7-2 Screenshot sample view for laser therapy – cluster applicator

Symbol	Description
1	Applicator identifier / program name
2	$\Sigma E$ $P$ Output energy and power emitted by laser applicator
3	Presentation of the treatment elapsing time
4	 Information field – laser radiation emission
5	Tab field – channel 1.

## 7.5 Operation with preset treatment programs

The simplest method of unit's operation is to use its preset programs. The unit includes a database containing several dozens of most frequently met disorders together with suggested treatment types and parameters. In this mode, the operation is reduced to selection of disease entity from the list.



The values of the preset treatment programs parameters are based on the available literature data and they are determined as average values. Parameters should be treated exclusively as indications. The user is solely responsible for the application of the preset treatment programs.



Pressing the button  after program selection results in appearing information which contains:

- technique description of conducting laser irradiation,
- illustrations with highlighted points or areas of the body covered by the treatment,
- suggested number of procedures, the frequency of repetition,
- impact on the patient,
- notes,
- treatment parameters.

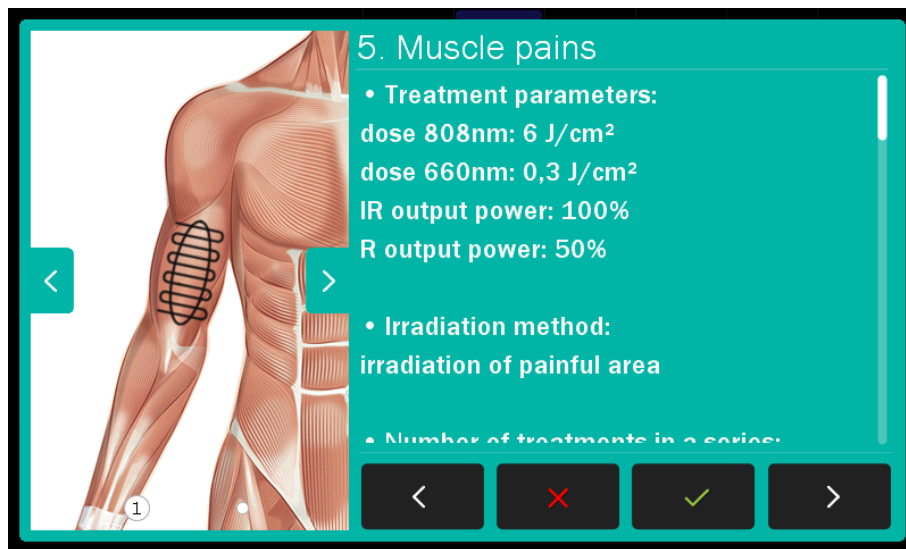

Figure 7-3 Information screen sample view

**Information mode navigation:**

Symbol	Explanation
	Approval of the program and return to the list (the current position)
	Back to the list of preset programs on a position from which there was an encyclopedia entry
	Go to the next program
	Go to the previous program
	Model of the human body – go to the previous / next illustration for the program



Use keys or a bar located on the right side of the display to scroll the information.





















If it is necessary to interrupt the treatment procedure (pause), press / key or applicator button (probe or cluster). To resume the treatment procedure, it is recommended to follow the instructions shown on the display.

**Symbol definition and parameters range are given in chapter 8.**

Schematic procedures for laser therapy are presented below. In continuous operation, it is recommended to start the treatment procedure from step 2 of the scheme.

**Operation scheme:**

Step	Description
1.	Connect an appropriate laser applicator.
2.	Switch on the unit.
3.	Enter the access code: <b>PLL</b> . Confirm by the button
4.	Select the applicator:  /  /
5.	Press the field <b>Program modes</b>
6.	Select the option <b>Preset programs</b> from <b>Program modes</b> menu or the medical field. Confirm by pressing the selected field once again.
7.	Select the program from the list.
8.	Prepare the patient for the treatment according to indications in point 7.1

Step	Description									
	Press the key  / 									
	<table border="1" style="width: 100%; border-collapse: collapse;"> <thead> <tr> <th style="width: 33%;">scanning applicator</th> <th style="width: 33%;">cluster applicator</th> <th style="width: 33%;">point applicator</th> </tr> </thead> <tbody> <tr> <td>9. Set the shape and size of the treatment area as well as default scanner distance.</td> <td>Set the treatment area. Press the key  / .</td> <td>Set the treatment area. Press the key  / .</td> </tr> <tr> <td>Press the key  / .</td> <td>Press the button on the applicator.</td> <td>Press the button on the probe.</td> </tr> </tbody> </table>	scanning applicator	cluster applicator	point applicator	9. Set the shape and size of the treatment area as well as default scanner distance.	Set the treatment area. Press the key  /  .	Set the treatment area. Press the key  /  .	Press the key  /  .	Press the button on the applicator.	Press the button on the probe.
scanning applicator	cluster applicator	point applicator								
9. Set the shape and size of the treatment area as well as default scanner distance.	Set the treatment area. Press the key  /  .	Set the treatment area. Press the key  /  .								
Press the key  /  .	Press the button on the applicator.	Press the button on the probe.								
<b>Start of emission is signaled acoustically. Laser radiation starts after two seconds after pressing the button on the probe.</b>										



**NOTE:**

Using the methods of control, adjustment or performance of procedures other than those specified herein may result in exposure to hazardous laser radiation.

**7.5.1 Voll and Nogier programs**







A specific group of preset treatment programs are positions dedicated to biostimulation laser point acupuncture according to Voll and Nogier, the so-called Voll and Nogier frequencies. These programs are only available for low lever laser point applicators. To select the program, proceed exactly as when choosing a preset treatment program.

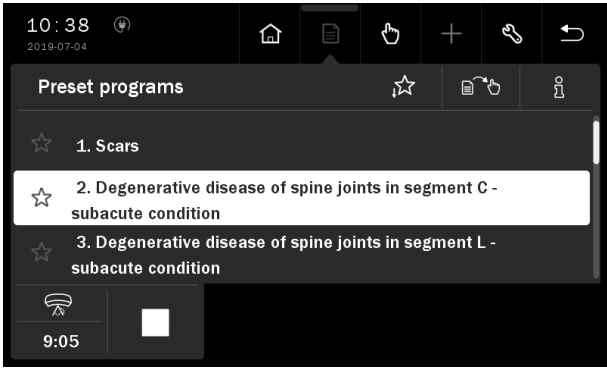

**7.6 Favorite programs**



The function offers quick access to frequently used **preset programs** without browsing the entire list. Function is available for all therapies.

To add or remove the program from the favorite list, follow the instructions:

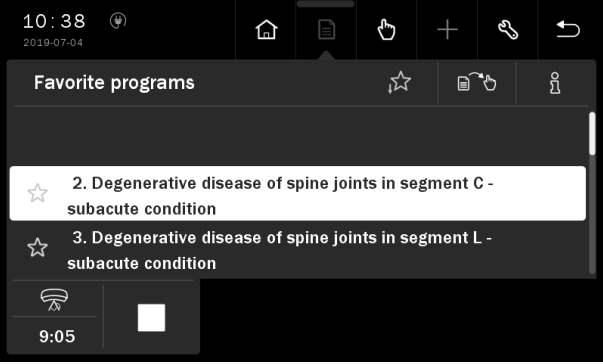
Step	Description				
1.	Prepare the unit to work with preset treatment programs (see section 7.5). Select the program.				
2.					
	<table border="1" style="width: 100%; border-collapse: collapse;"> <thead> <tr> <th style="width: 50%; text-align: center;">add</th> <th style="width: 50%; text-align: center;">remove</th> </tr> </thead> <tbody> <tr> <td>3. Press the symbol  next to the name of the selected preset treatment program. Symbol color changes to yellow and the program is inserted on the favorite list.</td> <td>Press the symbol  next to the name of the selected preset treatment program. Symbol color changes to blue and the program is deleted from the favorite list.</td> </tr> </tbody> </table>	add	remove	3. Press the symbol  next to the name of the selected preset treatment program. Symbol color changes to yellow and the program is inserted on the favorite list.	Press the symbol  next to the name of the selected preset treatment program. Symbol color changes to blue and the program is deleted from the favorite list.
add	remove				
3. Press the symbol  next to the name of the selected preset treatment program. Symbol color changes to yellow and the program is inserted on the favorite list.	Press the symbol  next to the name of the selected preset treatment program. Symbol color changes to blue and the program is deleted from the favorite list.				

Step	Description
4.	 <p>You can also remove the item from the favorite list, if you press the symbol .</p>









To enter the favorite list, press the symbol .

If no item from the preset treatment program list is selected as a "favorite", the after entering the option, the list will be empty.

**NOTE:**

**Favorite** option is not available when you set the view of preset treatment programs by medical fields. See point 6.3.4.2.

## 7.7 Manual mode operation

Step	Description
1.	Connect an appropriate laser applicator.
2.	Switch on the unit.
3.	Enter the access code: <b>PLL</b> . Confirm by the button 
4.	Select the applicator:  /  / 
5.	Press the field  <b>Manual mode</b>
6.	Select the parameter for edition, using the keys   set its value.
7.	Prepare the patient for the treatment according to indications in point 7.1
8.	Press the key  /  .
9.	Press the button on the casing in case of probe and cluster laser applicator.





If it is necessary to interrupt the treatment procedure (pause), press  key or applicator button (probe or cluster). To resume the treatment procedure, it is recommended to follow the instructions shown on the display.

## 7.8 User programs





The user has the possibility to save in to the device memory own sets of treatment parameters in the form of programs.

### Saving of user program:



Step	Description
1.	Prepare the unit to work in manual mode (steps 1 – 5 see section 7.7).
2.	Set the program parameters.
3.	Press the button  from main menu.
4.	Select the item number under which the program will be saved. Confirm your choice by clicking the field once again.
5.	Enter the program name. Press the button  .

The user-defined programs are selected in the same way as preset treatment programs. In **Program modes** menu select the option **User programs**.



### Edition of user program:

Step	Description
1.	Prepare the unit to work in the program mode (see section 7.5)
2.	Select the option <b>User programs</b> from <b>Program modes</b> menu. Confirm your choice by clicking the field once again.
3.	Select the program for edition.
4.	Press the button  from main menu.
5.	Select the action – <b>Edit</b> .
6.	Correct the parameters.
7.	Press the button  from main menu.
8.	Select the item number under which the program will be saved. Confirm your choice with the key  .
9.	Enter or edit the program name. Press button  .



### Removal of user program:

Step	Description
1.	Prepare the unit to work in the program mode (see section 7.5)
2.	Select the option <b>User programs</b> from <b>Program modes</b> menu. Confirm your choice by clicking the field once again.
3.	Select the program which will be deleted.
4.	Press the button  from main menu.
5.	Select the action – <b>Remove</b> .
6.	Confirm by pressing  or resign using  .

**User program parameter view:**

Step	Description
1.	Prepare the unit to work in the program mode (see section 7.5)
2.	Select the option <b>User programs</b> from <b>Program modes</b> menu. Confirm your choice by clicking the field once again.
3.	Select the program which parameters will be checked.
4.	Press button 
5.	Press the button  to return to the user-defined treatment program list.

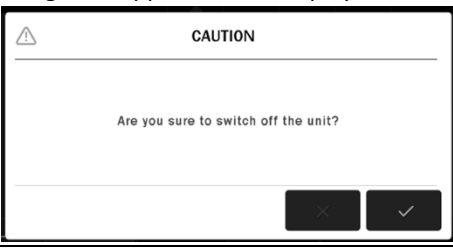
**7.9 Safe shutdown procedure****The work flow for the safe termination of the operation:**

Step	Description
1.	Click the UNIT ON / OFF (STANDBY) key on the front panel  . After clicking the button, a message will appear on the display as it is shown on the screen below.
2.	
3.	If you want to confirm the operation, select the  button, pressing of which will switch the unit off properly. If you quit turning the unit off, select  .
4.	After closing the system, you can disconnect the unit from the power supply network by means of power switch. If you want to charge the battery, leave the device connected to the mains.

## 8. Definitions and parameters

Due to the wide impact range, lasers may be applied to treat disorders on many fields, among others in:

- sports medicine,
- orthopedics,
- rheumatology,
- neurology,
- dermatology.
- laryngology,
- stomatology,
- esthetic medicine.

An important factor of bio-stimulating laser activity is the missing heat effect, which allows application for acute conditions.

The main clinical benefits caused by the biological effects of laser radiation in physiotherapy are:

- acceleration of bone union,
- acceleration of wound healing,
- increased elasticity,
- relief of pain syndromes, elimination of inflammation,
- shortening the recovery period,
- pain reduction.

**Characteristic of laser radiation sources used in laser applicators:**

Applicator type	Rated optical power	Wavelength	Laser diode type	Operation mode
80RDV3	80 mW	660 nm ± 5 nm	Semiconductor	Continuous and pulse operation mode
400IRV3	400 mW	808 nm ± 5 nm	Semiconductor	Continuous and pulse operation mode
SKW2-450 / SK2-450	100 mW	660 nm ± 5 nm	Semiconductor	Continuous and pulse operation mode
	450 mW	808 nm ± 5 nm	Semiconductor	Continuous and pulse operation mode
CL1800WH / CL1800	5x40 mW	660 nm ± 5 nm	Semiconductor	Continuous and pulse operation mode
	4x400 mW	808 nm ± 5 nm	Semiconductor	Continuous and pulse operation mode

Applicator type	Beam type	Nominal distance of sight hazard	Beam divergence	Class
80RDV3	divergent	2,7 m	0,045 rad ± 0,005 rad	3B
400IRV3	divergent	> 8 m	0,025 rad ± 0,005 rad	3B
SKW2-450 / SK2-450	660 nm divergent	> 8 m	0,025 rad ± 0,005 rad	3B
	808 nm divergent	> 8 m	0,025 rad ± 0,005 rad	3B
CL1800WH / CL1800	660 nm 5x divergent	2,7 m	5 x 0,045 rad ± 0,005 rad	3B
	808 nm 4x divergent	> 8 m	4 x 0,045 rad ± 0,005 rad	3B







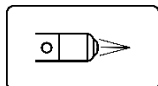

The values of maximum permissible exposure:

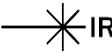
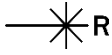
Radiation type	Wavelength	Influence	Maximum permissible exposure value
Direct beam or reflected beam	660 nm ± 5 nm	Cornea	10 W/m <sup>2</sup>
		Skin	2000 W/m <sup>2</sup>
Cornea, photochemical hazard		13 182 W/m <sup>2</sup>	
Cornea, thermal hazard		380 W/m <sup>2</sup>	
Dispersion	808 nm ± 5 nm	Cornea	16,6 W/m <sup>2</sup>
		Skin	3320 W/m <sup>2</sup>
Direct beam or reflected beam		Cornea	35 W/m <sup>2</sup>
		Cornea	

## 8.1 Point laser applicators (laser probes)

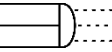
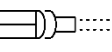
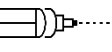

Characteristic of treatment parameters:

Symbol	Description	Available parameters
	Type of connected applicator	 IR laser applicator with the 808 nm wavelength
		 R laser applicator with the 660 nm wavelength
	Energy dose	0,5 J/cm <sup>2</sup> – 15 J/cm <sup>2</sup> regulation step 0,5 J/cm <sup>2</sup>
	Irradiated area	0,1; 0,3; 1, 3, 5; 10; 15; 20; 25; 30 cm <sup>2</sup>
	Pulse frequency	<ul style="list-style-type: none"> <li>cont – continuous mode</li> <li>1 Hz – 5000 Hz – pulse mode</li> </ul>
	Duty factor during pulse operation	<ul style="list-style-type: none"> <li>10 – 90% regulation step 10%</li> </ul>
	Radiation output power	25%, 50%, 75%, 100% of rated power
	Laser aperture	 Lens
		 Optical fiber applicator – straight / angled
		 Optical fiber applicator narrowed for laser acupuncture
	Delivered energy	Maximum 450 J
	Treatment time	1 second – 100 minutes, variable step

When using the optical fiber applicators, due to the attenuation, the correction factor found its application in calculation of treatment time. This allows to preserve the effectiveness of the treatment, because the effective dose of energy delivered to the tissue remains unchanged in relation to the exposure with the use of the lens. For standard fiber applicators the treatment time is extended up to 25%, for applicators dedicated to laser acupuncture up to 67%.

## 8.2 Scanning applicator



Characteristic of treatment parameters:

Symbol	Description	Available parameters
 <b>■ R</b> <b>□ IR</b>	Type of radiation source	IR Laser diode with the 808 nm wavelength
		R Laser diode with the 660 nm wavelength
		R+IR Laser diode with the 660 nm wavelength and laser diode with the 808 nm wavelength
	Energy dose	0,5 J/cm <sup>2</sup> – 20 J/cm <sup>2</sup> regulation step 0,5 J/cm <sup>2</sup>
	Radiation output power	 1/2 50% of rated power
		 MAX 100% of rated power
	Shape of treatment area	 Line
		 Ellipse
		 Rectangle
	Size of treatment area in axis X and Y	 1 – 100% in both axes
		 20 – 100% in both axes
		 20 – 100% in both axes
	Distance applicator-patient	2 cm – 100 cm
	Pulse frequency	<ul style="list-style-type: none"> <li>cont – continuous mode</li> <li>1 Hz – 5000 Hz – pulse mode</li> </ul> Duty factor: 75%, non-editable parameter
	Treatment time	1 second – 100 minutes, variable step
	Delivered energy	Maximum 3000 J

Characteristics of treatment area:

- rectangle linear – rectangular shape of area is scanned, pilot beam is visible as a line – length is set in X axis and reciprocates at a distance set in Y axis, the treatment area is uniformly illuminated,
- rectangle quasi-uniform – rectangular shape of area is scanned, pilot beam is visible as an ellipse, its axis reciprocates between the diagonals of rectangle in dimensions set in X and Y axis – the treatment area is uniformly illuminated,
- ellipse – ellipse shape of area is scanned, pilot beam is visible as an ellipse (circle) that pulses from the center to the sizes set in X and Y axis – the treatment area is more illuminated near the center.

### 8.2.1 Limitation of the laser scanner power

As the device is qualified as 3B class laser equipment, the power of the scanning applicator, type SK2-450, is limited to 500 mW. The limitation applies during the emission from two laser sources with 100% rated power. Distribution of power:

- laser diode with a wavelength of 808 nm – 450 mW
- laser diode with a wavelength of 660 nm – 50 mW.

### 8.3 Cluster applicator

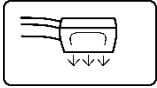

#### Characteristic of treatment parameters:

Symbol	Description	Available parameters
■ R □ IR	Type of radiation source	1xR      One laser diode with the 660 nm wavelength
		1xIR     One laser diode with the 808 nm wavelength
		5xR      Five laser diodes with the 660 nm wavelength
		4xIR     Four laser diodes with the 808 nm wavelength
		5xR+4xIR      • Five laser diodes with the 660 nm wavelength • Four laser diodes with the 808 nm wavelength
	Energy dose	1 J/cm <sup>2</sup> – 15 J/cm <sup>2</sup> regulation step 0,5 J/cm <sup>2</sup>
	Irradiated area	0,1; 0,2; 0,5; 1, 2, 5, 10, 15, 20 cm <sup>2</sup> for single-diode modes 25, 50, 75, 100, 125, 150, 200 cm <sup>2</sup> for multi-diode modes
	Radiation output power	 <b>1/2</b> 50% of maximum output power for each of laser diodes
		 <b>MAX</b> 100% of maximum output power for each of laser diodes
	Pulse frequency	<ul style="list-style-type: none"> <li>• cont – continuous mode</li> <li>• 1 Hz – 5000 Hz – pulse mode</li> </ul>
	Duty factor during pulse operation	<ul style="list-style-type: none"> <li>• 10 – 90% regulation step 10%</li> </ul>
	Treatment time	1 second – 100 minutes, variable step
<b>ΣE</b>	Delivered energy	Maximum 3000 J

## 9. Indications and contraindications

---

### 9.1 Indications

- difficult healing wounds and ulcerations
- post-surgical wounds, post-amputation wounds
- skin necrosis
- skin damages
- ulcerations of shanks, trophic ulcerations
- burns
- frostbites
- decubitus ulcers
- scars without fibrosis
- reduction of gynoid lipodystrophy symptoms
- simple acne
- simplex herpes
- aphtha
- psoriasis
- chronic arthritis conditions
- painful shoulder syndrome
- enthesopathies
- carpal tunnel syndrome
- bursitis, tendovaginitis, fasciitis
- subcutaneous hemorrhages (ecchymosis), contusions
- difficult, prolonged union of fractured bones
- muscles, ligaments, cartilage, synovium, bursae injuries
- sprains, dislocations
- torticollis
- Sudeck's syndrome (stage I and II)
- ankylosing spondylitis
- rheumatoid arthritis
- other rheumatic diseases (i.e. spondyloarthrosis, coxarthrosis, gonarthrosis)
- muscle, tendon, fascia, ligament overload syndromes
- neuralgias of peripheral nerves
- neuralgias after zoster
- diabetic neuropathy



### 9.2 Contraindications

- malignancy
- areas treated with radiotherapy
- active tuberculosis
- bleeding tendency
- feverish conditions
- diseases with elevated body temperature
- pregnancy (epigastric region)
- arrhythmia and circulatory insufficiency/circulatory failure
- hypersensitivity to light
- unstable diabetes
- implanted cardiac pacemaker (heart area)
- (generalized) bacterial diseases
- epilepsy
- fibrocystic breast changes
- endocrine hyperfunction
- infectious diseases
- severe conditions of obliterating arteritis
- chronic poisoning
- chronic nephritis
- high blood pressure and long-lasting hypertension

It is not recommended to carry out treatments in the patients with neurological disorders, synkinesis, trembling and convulsions. It is not recommended to perform the irradiation of eye socket and eyeball area due to possibility of the eye damage.

## 10. Maintenance, cleaning, disinfection



**NOTE:** The warranty does not cover any damage due to a failure to adhere to the recommendations stated in this chapter.



**NOTE:** Before attempting to perform following operations isolate the unit and switch mode power supply from the mains supply!

The activities of maintenance, cleaning and disinfection of device components should be realized at:

- ambient temperature between +15°C to +30°C,
- relative humidity between 30% to 75%,
- atmospheric pressure between 700 hPa and 1060 hPa (70 – 106 kPa).

These conditions are identical to those defined in chapter 4.2 as operation conditions.

**There are no limitations for the number of cleaning and disinfection cycles, procedures should be carried out during the entire device “life time”.**

### 10.1 Cleaning of the unit and switch mode power supply casing



**NOTE:** Before attempting to perform following operations isolate the unit and switch mode power supply from the mains supply!

Cleaning of the unit, switch mode power supply and cables shall be performed with lightly humid sponge or soft cloth with delicate soap solution or mild detergent. It is recommended to use a microfiber cloth, preferably designated for cleaning mirrors or electronic equipment.



**Do not use solvents for paints and lacquers. Do not use excessively dampened sponges either, which can lead to water penetration inside the unit.**

Then all cleaned cables shall be wiped with dry cloth and left for complete drying.

**Do not connect wet or moist leads!**

Do not disinfect or sterilize unit and switch mode power supply casing. Disinfection of detachable parts, which are not intended for contact with patient’s body (for example cables), shall be carried out at least once a week. It is recommended to use agent based on ethanol and/or isopropyl alcohol e.g. Alpro Minuten Spray or 70% solution of spirit.

**All disinfected parts of the device should be completely dry before switching the power on.**

It is not recommended to use sanitizers consisting of active oxygen, because it can lead to damage of the unit or its parts.

### 10.2 Cleaning of touchscreen

To clean the touchscreen, we recommend to use a cloth which is included in the standard parts of the unit, or other made of microfiber, preferably designated for cleaning mirrors or electronic equipment.

The manufacturer recommends to clean regularly the touchscreen display. Gently moisten the cloth with clean water. The cloth should be drained so that there is no dripping water. The screen should be wiped until removal of all dirt and dust.

The manufacturer does not recommend to use any product designated for cleaning screens, because there is no guarantee that the chemicals will not lead to faster wear out of touchscreen layers.



### 10.3 Cleaning and disinfection of the scanning and cluster applicator

**NOTE: Before attempting to perform following operations isolate the unit and SMPS from the mains supply!**

Cleaning of the scanning or cluster laser applicator and their cables shall be performed with lightly humid sponge or soft cloth with delicate soap solution or mild detergent. Please be careful while cleaning the protective glass of scanning and cluster applicator output opening. All cleaned parts shall be wiped with dry cloth and left for complete drying.

If protective glass of the:

- scanning applicator output opening,
- cluster applicator output opening,

is dirty, soak the cloth (made from dust-free fabric) with isopropyl alcohol or glasses cleaner and carefully clean them. You can apply glasses cleaner from Chemax, Uvex, Carl Zeiss, Bausch&Lomb or Alpro.

**Do not use humid or wet laser applicators and cables!**

**Do not use solvents for paints and lacquers. Do not use excessively dampened sponges either, which can lead to water penetration inside the unit or any laser applicator.**

**Where it is necessary to disinfect (accidental contact with patient's body), it is recommended to use agent based on ethanol and/or isopropyl alcohol e.g. Alpro Minuten Spray or 70% solution of spirit. After disinfection, detachable parts must be cleaned to avoid allergic reaction.**

**It is not recommended to use sanitizers consisting of active oxygen, because it can lead to laser applicators surface damage.**



### 10.4 Cleaning and disinfection of the point laser applicators

**NOTE: Before attempting to perform following operations isolate the unit and SMPS from the mains supply!**

Point laser applicators and their cables shall be cleaned with water and gentle soap or mild detergent, and then wiped with dry cloth and left for complete drying.

If the laser probe lens glass is dirty, soak the cloth (made from dust-free fabric) with isopropyl alcohol or glasses cleaner and carefully clean them. You can apply glasses cleaner from Chemax, Uvex, Carl Zeiss, Bausch&Lomb or Alpro. While cleaning pay attention, if the lens is not scratched.

**Do not use humid or wet point laser applicators and cables!**

**Do not use solvents for paints and lacquers. Do not use excessively dampened sponges either, which can lead to water penetration inside the unit or any laser applicator.**

**Lenses and components fixing lenses to applicator casing may contact patient's body during treatment procedure. Perform disinfection of these components after each treatment procedure, where there is contact with the patient's body. It is recommended to use sanitizers based on ethanol and/or isopropyl alcohol e.g. Alpro Minuten Spray or 70% solution of spirit. If no contact with patient's body takes place, apply disinfection using above mentioned agents at least once a week. The recommendation also applies to other elements of the point laser applicator point case. After disinfection, detachable parts must be cleaned to avoid allergic reaction.**

**It is not recommended to use sanitizers consisting of active oxygen, because it can lead to laser applicators surface damage.**

#### 10.4.1 Disinfection and sterilization of the optical fiber applicators



**Optical fiber applicators in combination with laser probes may contact patient's body during treatment procedure. Perform disinfection of these components after each treatment procedure, where there is contact with the patient's body. It is recommended to use sanitizers based on ethanol and/or isopropyl alcohol e.g. Alpro Minuten Spray or 70% solution of spirit. If no contact with patient's body takes place, apply disinfection**

using above mentioned agents at least once a week. The recommendation also applies to other elements of the point laser applicator point case. After disinfection, detachable parts must be cleaned to avoid allergic reaction.

Optical fiber applicators could be sterilized by any steam method.

## 10.5 Special messages

In case of an error occurrence, messages that facilitate error handling are displayed in the edition field. There can also be shown a window that informs user about the need to contact the technical support. By using the visible setup control, it is possible to display the unit logs, in order to pass them to the technical staff (see 6.3.6.4.).

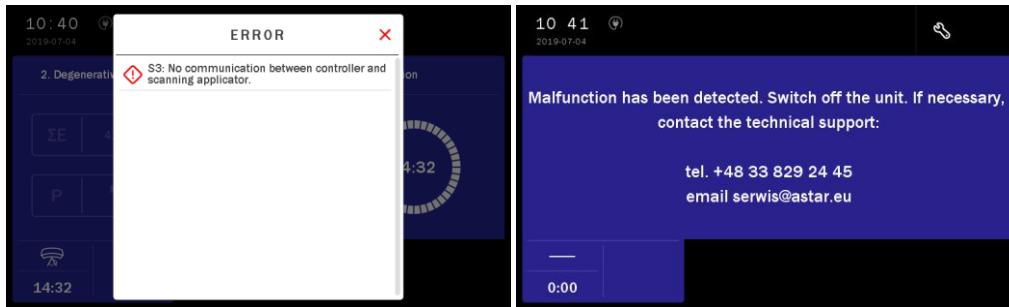

Figure 10-1 The unit error signaling and information visible after closing of the error message

Table 10-1. Signaling special messages

Type of message	Symbol
Errors	
General information	
Warnings	

## 10.6 Self-test procedure

Each time the PhysioGo.Lite Laser unit is started, a special self-test procedure is performed during which all modules and functional blocks of the device are tested. If any errors or damage are detected, the relevant information will be presented on the display screen. The module where the irregularity has been detected is blocked and the associated function is not available.

If any mistakes of the hardware nature are detected, the unit will not start. An acoustic signal reminiscent of "tapping" will be emitted. The number of signals ("taps") generated is adequate to the number of the error (see Table 10-2 of error codes). For example, if seven signals are emitted (followed by a short break), this means that the keyboard is damaged or one of the keys is locked.

In this situation, you must disconnect the unit from the mains and contact an authorized service for inspection and a possible repair.

Table 10-2. The "hardware" error coding system

Error code	Error description
I2	SDRAM self-test error
I3	No communication with the SD card

Error code	Error description
14	No communication with the TSC controller in the LCD
15	Program defect in the processor FLASH memory (CRC)
17	The keyboard is damaged or a button is pressed (a button short-circuit)
18	Main processor oscillator error

## 10.7 Troubleshooting

Table 10-3.

Symptoms	Undertaking action
<b>The unit does not respond to mains supply</b>	Check fuse. If it is blown, replace it in accordance with indications in point 10.8. Try to connect different mains cable. If the problem persists, contact your authorized service.
<b>The unit does not start. Acoustic sounds can be heard</b>	Turn off and on the device. If the problem persists or occurs frequently, determine the type of error based on chapter 10.6 and contact your authorized service.
<b>Unit Error indication – symbol  in the status field or channel tab</b>	Turn off and on the device. If the problem persists or frequently occurs, note down the error number and contact your authorized service.
<b>Error indication of laser applicator</b>	Switch the unit off. Disconnect detachable parts. Connect it once again and switch on the mains supply. If the problem persists or frequently occurs, note down the error number and contact your authorized service. If you have another applicator, connect it in and check if the problem persists.
<b>The unit does not respond when you press keys</b>	Turn off and on the device. If the problem persists or frequently occurs, contact your authorized service.
<b>The touch panel is too sensitive or does not respond to touch</b>	Calibrate the display. To carry out calibration, press the   keys simultaneously during system start-up. The unit then activates the display calibration mode. Follow the messages on the screen. First, touch three points, then validate the correctness of operation by touching five points on the screen.
<b>The touch panel reacts in a different spot from where it was touched</b>	Calibrate the display. To carry out calibration, press the   keys simultaneously during system start-up. The unit then activates the display calibration mode. Follow the messages on the screen. First, touch three points, then validate the correctness of operation by touching five points on the screen.
<b>Message “A problem in touch panel operation has been detected.”</b>	If the problem occurred once, it means the touch panel was touched while system start-up. Do not touch the screen during the system start-up. If the problem occurs after each system start-up, contact your authorized service.
<b>Incomprehensible messages</b>	Switch on the unit. Enter the setup mode. Select an appropriate language version.
<b>Unclear display</b>	Switch on the unit. Enter the setup mode. Adjust brightness.
<b>Lack of buzzer signals</b>	Switch on the unit. Enter the setup mode. Check the configuration of buzzer volume.
<b>Too silent buzzer volume</b>	Switch on the unit. Enter the setup mode. Set an appropriate buzzer volume.
<b>You cannot start laser operation</b>	Enter the proper code: <b>PLL</b>
<b>Lack of laser radiation of laser probe / scanner</b>	Switch on the unit. Enter the setup mode. Perform the laser power measurement according to 6.3.5.3
<b>Unit equipped with battery module – the device does not respond to mains supply</b>	Connect the mains supply. The battery may be discharged. To start the operation, please hold on for at least 5 seconds the STANDBY key.

Symptoms	Undertaking action
The battery discharges quickly	Contact your authorized service for battery replacement. If the battery module has to be dismantled, a stabilizing cartridge should be installed. If you change the battery yourself, follow the information included in 5.3.
Date and time settings cancel	If I16 error is shown on the display, it means that the backup battery is discharged. Its exchange should be directed to an authorized service. Type of memory backup battery is a CR2032.



## 10.8 Fuse replacement

### NOTE:

**Before proceeding to the further described operations isolate the unit from the mains supply!**

In case of burnt the fuse, it must be replaced. Fuse parameters are given in chapter **"Specification and parts of the unit"** and on the name plate.

To replace the fuse:

Step	Description
1.	Switch the power switch to the "0" position.
2.	Disconnect the mains cable from the mains socket. Disconnect the power supply cable from the device socket marked with symbol  .
3.	With flat screwdriver unscrew the fuse socket until the moment of its slipping from the socket.
4.	Remove the socket with your fingers, replace the fuse, install them in the socket again and screw firmly.
5.	Connect the power supply cord to the device socket. Then connect the mains cable to the mains socket.
6.	Switch the power switch on and start the device. Check the device operation.

## 11. Specification and parts of the unit

### 11.1 Technical data

#### Classifications:

Medical device class:	IIb
Classification rule: (according to REGULATION (EU) 2017/745 OF THE EUROPEAN PARLIAMENT AND OF THE COUNCIL of 5 April 2017)	9
Electrical safety class:	II
Application part type:	BF
Laser device class:	3B
Degree of protection provided by enclosures:	IP20
Pollution degree	2
Material group	IIIb
Operating altitude	<2000m

#### Mode of operation:

The unit is intended for continuous operation.

#### Treatment parameters:

Described in chapter 8.

#### Laser therapy:

Power control accuracy:	±20% of max value
Pulse repetition period:	±20%
Duty factor:	±20%
Laser emission readiness signal, the unit:	unit screen
Laser emission signal, the unit:	sound, unit screen
Laser emission readiness signal, laser point probes:	flashing yellow – LED indicator
Laser emission signal, laser point probes:	yellow LED indicator
Laser emission signal, scanning laser applicator:	yellow LED indicator
Laser emission readiness signal, cluster laser applicator:	flashing yellow – LED indicator
Laser emission signal, cluster laser applicator:	yellow LED indicator
Additional safety measures:	warning labels DOOR blocking plug
Remote interlock connector:	passive closing contact sensor

#### Parameters of scanning laser applicator

Laser class of pilot beam:	3R
Output power of pilot beam:	5 mW
Wavelength of pilot beam:	660 nm
Possibility of simultaneous radiation of RD and IR:	yes
Scanner height adjustment range:	60 – 140 cm
Adjustment angle of rotation:	-90÷ +90° in both axes
Duty factor for pulse operation of scanning applicator:	75%
Driving element of scanner stand:	4 with brake

#### Treatment programs:

Pre-defined treatment programs for point laser applicators with 808nm wavelength:	39
Pre-defined treatment programs for point laser applicators with 660nm wavelength:	18
Pre-defined treatment sequences for scanning laser applicators:	26
Pre-defined treatment sequences for cluster laser applicator:	54
Voll's frequencies:	30
Nogier's frequencies:	8

	<b>Total</b>	175
<b>User-defined programs:</b>		50 (for every applicator)
<b>Parameters for pulse operation of point applicators:</b>		
Nogier's frequencies:		1,14; 2,28; 4,56; 9,12; 18,3; 36,5; 73;146 Hz
Voll's frequencies:		1,2; 1,7; 1,75; 2,2; 2,45; 2,5; 2,65; 2,9; 3,3;3,5 Hz 3,6; 3,8; 3,9; 4; 4,9; 5,55; 5,8; 5,9; 6; 6,3; 6,8 Hz 7,5; 7,7; 8,25; 9,2; 9,35; 9,4; 9,45; 9,5; 9,6 Hz
<b>Treatment timer:</b>		
Ranges and resolutions:		defined in chapter 8
Time accuracy:		10%
<b>General:</b>		
Mains supply:		100-240 V; 50/60 Hz; 1,4 – 0,7 A
Mains fuses:		size 5x20mm, T3,15L250V; 3,15 A, 250 V
Type of memory backup battery:		CR2032
Unit weight:		max. 3 kg
Point laser applicator weight:		max. 0,5 kg
Scanning laser applicator weight:		max. 1 kg
Cluster laser applicator weight:		max. 0,5 kg
Unit dimensions (WxDxH)		25x27x16,5cm
<b>Switched-mode power supply, type HPU63B-108 by Sinpro:</b>		
Mains supply – input:		100-240 VAC; 1.62-0.72A; 47-63 Hz
Output:		max. 24VDC; 2.62A
Weight:		max. 0.38 kg
Dimensions (WxDxH):		13.2x5.6x3.7 cm
<b>Switched-mode power supply, type GSM60B24-P1J by Mean Well:</b>		
Mains supply – input:		100-240 VAC; 1.4-0.7A; 50/60 Hz
Output:		max. 24VDC; 2.5A
Weight:		max. 0.35 kg
Dimensions (WxDxH):		12.5x5x3.15 cm
<b>The power supply cord is equipped with a mains plug that isolates the device from the supply mains on all poles simultaneously.</b>		
<b>Battery A-AW-AST-LITEAQ (optional):</b>		
Type:		Li-Ion
Voltage:		18 V
Capacity:		2.1 Ah
Weight:		max. 0.45 kg
Dimensions (WxDxH):		15x8x3.3 cm
<b>Battery A-AW-00003 (optional):</b>		
Type:		Li-Ion
Voltage:		18.17 V
Capacity:		3.4 Ah
Weight:		max. 0.45 kg
Dimensions (WxDxH):		15x8x3.3 cm
<b>Storage conditions:</b>		
Temperature range:		+5÷+45°C
Relative humidity:		30÷75%
Pressure range:		700÷1060 hPa (70 – 106 kPa)
<b>Operation conditions:</b>		
Temperature range:		+15÷+30°C

Relative humidity:	30÷75%
Pressure range:	700÷1060 hPa (70 – 106 kPa)
<b>Transport conditions:</b>	
Temperature range:	-10÷+45°C
Relative humidity:	20÷95%
Pressure range:	700÷1060 hPa (70 – 106 kPa)

## 11.2 EMC parameters

Acc. to EN 60601-1-2:2015 and EN 60601-1-2:2015/A1:2021 (IEC 60601-1-2:2014 and IEC 60601-1-2:2014 /AMD1:2020).

### Guidance and manufacturer's declaration – electromagnetic emissions

Emission test	Compliance
Radiated emissions – CISPR 11	Group 1
Conducted emissions – CISPR 11	Class B
Harmonic emissions – IEC 61000-3-2	Class A
Voltage fluctuations / Flicker emissions – IEC 61000-3-3	Complies

### Guidance and manufacturer's declaration – electromagnetic immunity

Immunity test	IEC60601 test level	Compliance level
Electrostatic discharge (ESD)	±8 kV contact	±8 kV contact
IEC 61000-4-2	±2, ±4, ±8, ±15 kV air	±2, ±4, ±8, ±15 kV air
Recommendation: Floor should be made of wood, concrete or ceramic tile. If floors are covered with synthetic material, the relative humidity should be at least 30%.		

Immunity test	IEC60601 test level	Compliance level
Radiated RF	10 V/m	10 V/m
IEC 61000-4-3	80MHz to 2,7 GHz	
Field strengths from fixed transmitters, such a base stations for radio (cellular / cordless) telephones and land mobile radios, amateur radio, AM and FM radio broadcast and TV broadcast cannot be predicted theoretically with accuracy. To assess the electromagnetic environment due to fixed RF transmitters, an electromagnetic site survey should be considered. If the measured field strength in the location in which the PhysioGo.Lite Laser unit is used exceeds the applicable RF compliance level above, the unit should be observed to verify normal operation. If abnormal performance is observed, additional measures may be necessary, such as re-orienting or relocating the PhysioGo.Lite Laser unit. Applied compliance level is suitable for home healthcare environment. It means the device may be connected to the public low-voltage power supply network.		

Immunity test	IEC60601 test level	Compliance level
Electric fast transient / burst	±2 kV	±2 kV
IEC 61000-4-4		

Immunity test	IEC60601 test level	Compliance level
Surges	±1 kV line-to-line	±1 kV line-to-line
IEC 61000-4-5		

Immunity test	IEC60601 test level	Compliance level
Conducted RF	3 Vrms	3 Vrms
IEC 61000-4-6	150 kHz to 80 MHz	150 kHz to 80 MHz
	6 Vrms in ISM and amateur radio bands between 150 kHz – 80 MHz	6 Vrms in ISM and amateur radio bands between 150 kHz – 80 MHz

Field strengths from fixed transmitters, such a base stations for radio (cellular / cordless) telephones and land mobile radios, amateur radio, AM and FM radio broadcast and TV broadcast cannot be predicted theoretically with accuracy. To assess the electromagnetic environment due to fixed RF transmitters, an electromagnetic site survey should be considered. If the measured field strength in the location in which the PhysioGo.Lite Laser unit is used exceeds the applicable RF compliance level above, the unit should be observed to verify normal operation. If abnormal performance is observed, additional measures may be necessary, such as re-orienting or relocating the PhysioGo.Lite Laser unit.

Applied compliance level is suitable for home healthcare environment. It means the device may be connected to the public low-voltage power supply network.

Immunity test	IEC60601 test level	Compliance level
Magnetic field power frequency (50/60 Hz) IEC 61000-4-8	30 A/m	30 A/m

Immunity test	IEC60601 test level	Compliance level
Voltage dips IEC 61000-4-11	0% $U_T$ 0,5 cycle, phase angles of synchronization with power supply voltage 0°, 45°, 90°, 135°, 180°, 225°, 270°, 315°	Complies
	0% $U_T$ 1 cycle, phase angle of synchronization with power supply voltage 0°	Complies
	70% $U_T$ 25 cycles for 50Hz 30 cycles for 60Hz phase angles of synchronization with power supply voltage 0°	Complies
Voltage interruptions IEC 61000-4-11	0% $U_T$ 250 cycles for 50Hz 300 cycles for 60Hz	Complies

Immunity test	Compliance level
Immunity to proximity fields from RF wireless communications equipment according to the table 9 of IEC 60601-1-2:2014/AMD1:2020	Complies
Immunity to proximity magnetic fields in the frequency range 9 kHz to 13,56 MHz according to the table 11 of IEC 60601-1-2:2014/AMD1:2020 and IEC 61000-4-39	Complies

### 11.3 Standard parts of the unit

Laser therapy unit PhysioGo.Lite Laser defined as a medical device contains the controller and parts of the unit. Parts of the unit are not separate medical devices and works only with controllers manufactured by Astar.

Standard parts of the PhysioGo.Lite Laser unit:

No.	Name	REF	Quantity
1.	PhysioGo.Lite Laser controller	A-UL-AST-PLL	1
2.	Switch mode power supply – type HPU63B-108 by Sinpro or GSM60B24-P1J by Mean Well	-	1
3.	Mains cable	-	1
4.	Integrated remote interlock connector/ emergency laser stop connector	A-AL-AST-DOOR-PL	1
5.	Spare fuse – time lag T3,15L250V	-	1
6.	Pen for a resistive touch screen	-	1
7.	LCD touch screen cloth	-	1
8.	Masking covers with cutout	-	2
9.	M3x16DK screw	-	8
10.	Laser warning label	-	1
11.	Laser information label	-	1
12.	Instructions for use	-	1
13.	Electrical safety test report	-	1

## 11.4 Optional parts of the unit

<b>Applicators and trolleys</b>	
<b>Name</b>	<b>REF</b>
Scanning laser applicator type SKW2-450 with a stand	A-AL-AST-SK450V2WH
Cluster laser applicator – type CL1800WH	A-AL-AST-CL1800WH
Point laser probe – type 80RDV3	A-AL-AST-80RDV3
Point laser probe – type 400IRV3	A-AL-AST-400IRV3
Cluster applicator holder	A-AL-AST-CLHOLD
Laser probe holder	A-AL-UCH-LAS-C
Fiber optical applicators:	
a) Straight	a) A-AL-AST-ASP6MMV2
b) Angled	b) A-AL-AST-ASK6MMV2
c) Angled for laser acupuncture	c) A-AL-AST-ASK6MML2V2
d) Fiber holder	d) A-AL-AST-GA6MMV2
Stand for cluster applicator:	
a) with clamp holder	a) A-AL-AST-CLSTH1
b) with strap holder	b) A-AL-AST-CLSTH2B
Trolley:	
a) Versa	a) A-AM-AST-VSA
b) Versa X	b) A-AM-AST-VSX
<b>Other</b>	
<b>Name</b>	
Protective goggles	Bag for the unit and parts of the unit
Emergency laser stop (A-AW-AST-LSRIC)	Battery (A-AW-AST-LITEAQ or A-AW-00003)
Phillips screwdriver	-









## 12. Appendix A. Symbol description





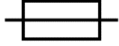









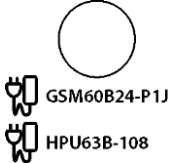







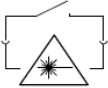

Recommendation for the operator's position to ensure the legibility of markings and information on the controller and detachable parts labels:

- visual distance – shall be 30 cm due to the applied technologies,
- lighting – 500 lx, which corresponds to normal room lighting conditions.





### 12.1 Controller, parts of the unit, packaging

Symbol	Definition
	Caution, see the ACCOMPANYING DOCUMENTATION, symbol ISO 7000-0434A
	Class II equipment, symbol IEC 60417-5172
	BF type equipment, symbol IEC 60417-5333
	Date of production: year, symbol ISO 7000-2497
	Manufacturer, symbol ISO 7000-3082
<b>IP20</b>	Degree of protection provided by enclosures (IP code), based on IEC 60529
	Fuse, symbol IEC 60417-5016
<b>VER</b>	Unit version
	Serial number, symbol ISO 7000-2498
	Batch code, symbol ISO 7000-2492
	Catalogue number, symbol ISO 7000-2493
	Medical device, symbol 5.7.7. of ISO 15223-1 standard

Symbol	Definition
	<p>Unique Device Identifier, symbol 5.7.10. of ISO 15223-1 standard</p>
	<p>Disposal of used devices together with other waste is prohibited, complied with the requirements of WEEE</p>
	<p>General symbol for recovery/recyclable, symbol ISO 7000-1135</p>
	<p>Operating instructions, symbol ISO 7000-1641</p>
	<p>Switch mode power supply socket, direct current, symbol IEC 60417-5031</p>
	<p>Switched-mode power supply identification</p>
	<p>Follow Instructions for use, symbol ISO 7010-M002 Background color: blue</p>
	<p>No heavy load, symbol ISO 7010-P012 Background color: white Circular band and slash: red Symbol or text: black</p>
	<p>No sitting, symbol ISO 7010-P018 Background color: white Circular band and slash: red Symbol or text: black</p>
	<p>No stepping on surface, symbol ISO 7010-P019 Background color: white Circular band and slash: red Symbol or text: black</p>
	<p>No pushing, symbol ISO 7010-P017 Background color: white Circular band and slash: red Symbol or text: black</p>
	<p>Do not disassemble Background color: white Circular band and slash: red Symbol or text: black</p>
	<p>General warning sign, symbol ISO 7010-W001 Background color: yellow Symbol or text: black</p>
	<p>The product has passed quality control</p>

Symbol	Definition
	Keep for further use
	Non-ionizing electromagnetic radiation, symbol IEC 60417-5140 Indication of equipment in the medical electrical area that intentionally apply RF electromagnetic energy for diagnosis or treatment.
	Remote interlock connector, symbol 112 of table D1 IEC 60601-2-22
	Emergency laser stop, symbol nr 101 of table D1 IEC 60601-2-22
	Weight
	Packaging size
	Temperature limit, symbol ISO 7000-0632
	Keep away from rain, symbol ISO 7000-0626
	Fragile; handle with care, symbol ISO 7000-0621
	This way up, symbol ISO 7000-0623
	The marking of conformity with legal regulations for medical devices applicable in the European Union along with the number of the Notified Body taking part in the conformity assessment.

## 12.2 Switched-mode power supply – casing

Symbol	Description	SMPS type
	TUV Rheinland conformity mark (the table lists the standards for which compliance has been demonstrated, the ID means the notified body's report number).	all
	Marking of compliance with the requirements of legal regulations in force in the European Union.	all
	UL+CU conformity mark (USA, Canada). The alphanumeric string represents the approved UL report number.	all
	Federal Communications Commission EMC compliance mark (USA)	HPU63B-108 (Sinpro)

Symbol	Description	SMPS type
	The Eurasian Conformity mark – conformity with all technical regulations of the Eurasian Customs Union.	GSM60B24-P1J (Mean Well)
	Caution, symbol ISO 7000-0434A	GSM60B24-P1J (Mean Well)
	Dangerous voltage, symbol IEC 60417-5036	GSM60B24-P1J (Mean Well)
	For indoor use only, symbol IEC 60417-5957	all
	Class II equipment, symbol IEC 60417-5172	all
	Compliance with the RoHS directive SJ/T 11364-2014 (China). The number indicates the service life of an environmentally friendly electric and electronic product.	GSM60B24-P1J (Mean Well)
	Disposal of used devices together with other waste is prohibited, complied with the requirements of WEEE	all
	Upper limit of temperature, symbol ISO 7000-0533	GSM60B24-P1J (Mean Well)
	Energy efficiency level	GSM60B24-P1J (Mean Well)
	Energy efficiency level	HPU63B-108 (Sinpro)
	Do not disassembly	GSM60B24-P1J (Mean Well)
	Voltage polarity in the output plug	all
	Direct current (DC), symbol IEC 60417-5031	all
	Alternating current (AC), symbol IEC 60417-5032	HPU63B-108 (Sinpro)
<b>IP22</b>	Degree of protection provided by enclosures (IP code), based on IEC 60529	GSM60B24-P1J (Mean Well)

---

## 13. Appendix B. Disassembly of laser scanner from the stand

---

To disassembly laser scanner from the stand:

- Disconnect the plug of interconnecting cable.
- Unscrew the set screws, if present.
- Hold one hand the stand and release the scanner from the mounting socket.

