

# CERTIFICATE

No.: TM 62000750 007



## Licence holder

Company Sporttehnika LTD  
Ushinskogo 24,  
14014 Chernihov  
Ukraine

## Manufacturing Plant

Company Sporttehnika LTD  
Ushinskogo 24,  
14014 Chernihov  
Ukraine



## Project number

26201061 001

## Our reference

39036522

## The period of validity

from 2016-04-26 to 2019-04-25

## Scope of evaluation

PN-EN 16630:2015-06

## Certification program PCWU-5

## Certified Product (Product Identification)

Permanently installed outdoor fitness equipment – Workout fitness

Name:	2 level parallel bars	Parallel bars	Parallel bars
Model:	S834.1	S834.2	S834.3
Dimensions: LxWxH (mm):	3130 x 873 x 1657	1630 x 996 x 1657	1630 x 996 x 327
Main material:	Powder coated steel		
Product visualization:			

## TÜV Rheinland Polska Sp. z o.o.

ul. 17 Stycznia 56,  
02-146 Warszawa, Polska  
Tel.: (+48/22) 846 79 99  
Tel.: (+48/22) 868 37 42  
e-mail: post@pl.tuv.com



Product Certification Body

Tomasz Mańczak

Warsaw, 2016-04-26

This certificate is subjected to the Certification Regulations as well as the General Conditions of Including Transactions in TRP and refers only to the products consistent with the sample being the basis of the carried out confirmation test. This certificate alone does not entitle the holder to attach the CE marking. The validity of the certificate can be checked on [www.certipedia.com](http://www.certipedia.com)



Safety  
Regular  
Production  
Surveillance

[www.tuv.com](http://www.tuv.com)  
ID 0000051557



AC 141



TÜVRheinland®  
Precisely Right.

[www.tuv.pl](http://www.tuv.pl)

# CERTIFICATE

No.: TM 62000750 010



## Licence holder

Company Sporttehnika LTD  
Ushinskogo 24,  
14014 Chernihov  
Ukraine

## Manufacturing Plant

Company Sporttehnika LTD  
Ushinskogo 24,  
14014 Chernihov  
Ukraine



## Project number

26201061 001

## Our reference

39036522

## The period of validity

from 2016-04-26 to 2019-04-25

## Scope of evaluation

PN-EN 16630:2015-06

## Certification program PCWU-5

## Certified Product (Product Identification)

Permanently installed outdoor fitness equipment – Workout fitness

Name:	Abdominals - hyperextension	Horizontal bar - ladder	Ladder 1,1m	Vertical handler	Gymnastic rings
Model:	S836.1	S836.2	S839.1	S839.2	S839.3
Dimensions: LxWxH (mm):	3698 x 4075 x 808	3430 x 326 x 2705	1230 x 283 x 2705	309 x 130 x 2705	2130 x 242 x 4127
Main material:	Powder coated steel				

Product visualization:

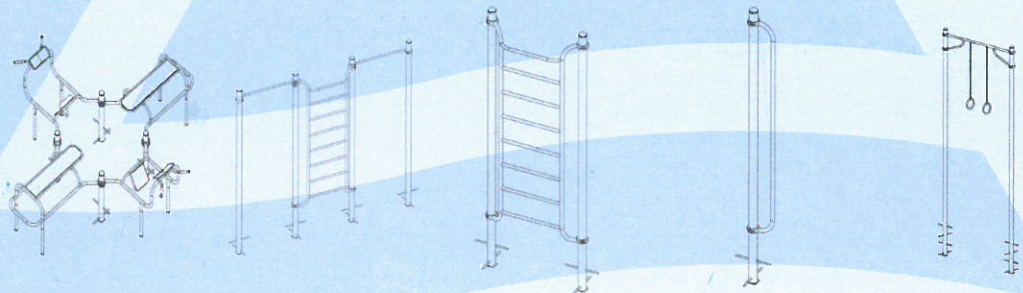

## TÜV Rheinland Polska Sp. z o.o.

ul. 17 Stycznia 56,  
02-146 Warszawa, Polska  
Tel.: (+48/22) 846 79 99  
Tel.: (+48/22) 868 37 42  
e-mail: post@pl.tuv.com

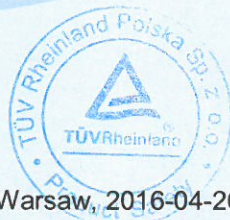

Product Certification Body

*Tomasz Mańczak*  
Tomasz Mańczak

Warsaw, 2016-04-26

This certificate is subjected to the Certification Regulations as well as the General Conditions of Including Transactions in TRP and refers only to the products consistent with the sample being the basis of the carried out confirmation test. This certificate alone does not entitle the holder to attach the CE marking. The validity of the certificate can be checked on [www.certipedia.com](http://www.certipedia.com)



Safety  
Regular  
Production  
Surveillance

[www.tuv.com](http://www.tuv.com)  
ID 0000051557



AC 141



TÜVRheinland®  
Precisely Right.

[www.tuv.pl](http://www.tuv.pl)

# CERTIFICATE

No.: TM 62000762 013



## Licence holder

Company Sporttehnika LTD  
Ushinskogo 24,  
14014 Chernihov  
Ukraine

## Manufacturing Plant

Company Sporttehnika LTD  
Ushinskogo 24,  
14014 Chernihov  
Ukraine



## Project number

26201060 001

## Our reference

39036524

## The period of validity

from 2016-07-22 to 2019-07-12

## Scope of evaluation

EN 16630:2015

## Certification program PCWU-5

## Certified Product (Product Identification)

### Permanently installed outdoor fitness equipment

<b>Product name:</b>	Leg press	Shoulders training (4 small wheels)	Shoulders training (2 big wheels)
<b>Symbol:</b>	SE103	SE107	SE108
<b>Dimensions [mm]: L x W x H</b>	1777 x 500 x 1548	1256 x 1180 x 1541	678 x 900 x 1855
<b>Max load per user [kg]:</b>	130	130	130
<b>Main material:</b>	galvanized and/or powder coated steel; plastic caps, seats, supports; rubber foot supports; plywood wheels		

## Product visualization:

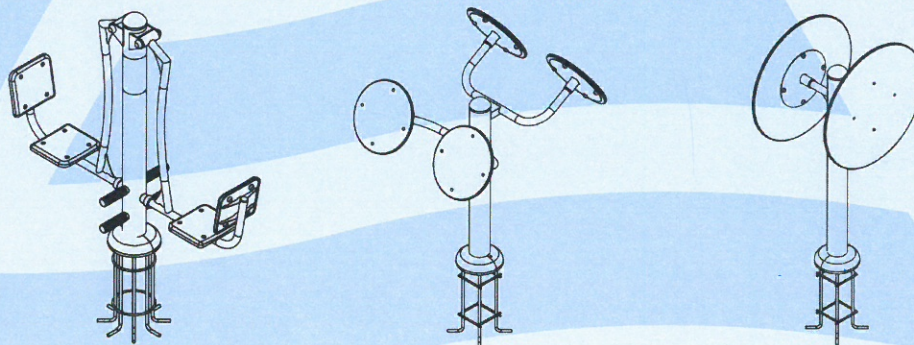

replaces: TM 62000762 003

## TÜV Rheinland Polska Sp. z o.o.

ul. 17 Stycznia 56,  
02-146 Warszawa, Polska  
Tel.: (+48/22) 846 79 99  
Tel.: (+48/22) 868 37 42  
e-mail: post@pl.tuv.com



## Product Certification Body

*Tomasz Mańczak*  
Tomasz Mańczak

This certificate is subjected to the Certification Regulations as well as the General Conditions of Including Transactions in TRP and refers only to the products consistent with the sample being the basis of the carried out confirmation test. This certificate alone does not entitle the holder to attach the CE marking. The validity of the certificate can be checked on [www.certipedia.com](http://www.certipedia.com)



Safety  
Regular  
Production  
Surveillance



[www.tuv.com](http://www.tuv.com)  
ID 0000051557

 **TÜVRheinland®**  
Precisely Right.

[www.tuv.pl](http://www.tuv.pl)

# CERTIFICATE

No.: TM 62000762 014



## Licence holder

Company Sporttehnika LTD  
Ushinskogo 24,  
14014 Chernihov  
Ukraine



## Manufacturing Plant

Company Sporttehnika LTD  
Ushinskogo 24,  
14014 Chernihov  
Ukraine

## Project number

26201060 001

## Our reference

39036524

## The period of validity

from 2016-07-22 to 2019-07-12

## Scope of evaluation

EN 16630:2015

## Certification program PCWU-5

## Certified Product (Product Identification)

### Permanently installed outdoor fitness equipment

<b>Product name:</b>	Abdominal muscles training	Air Walker	Single Ellipse
<b>Symbol:</b>	SE109	SE115-T	SE116
<b>Dimensions [mm]: L x W x H</b>	1280 x 1274 x 553	1071 x 481 x 1518	1186 x 625 x 1658
<b>Max load per user [kg]:</b>	130	130	130
<b>Main material:</b>	galvanized and/or powder coated steel; plastic caps; rubber/steel handles; rubber/steel foot supports, EPDM bench seat		

## Product visualization:

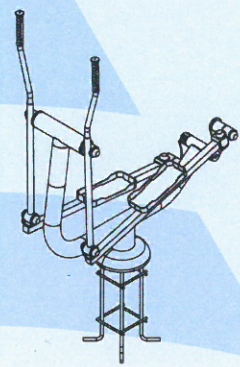
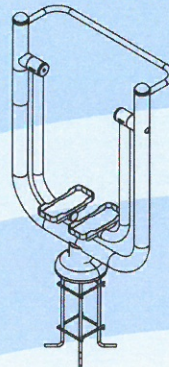
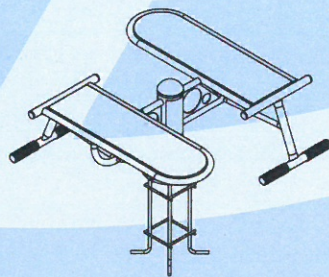

replaces: TM 62000762 004

## TÜV Rheinland Polska Sp. z o.o.

ul. 17 Stycznia 56,  
02-146 Warszawa, Polska  
Tel.: (+48/22) 846 79 99  
Tel.: (+48/22) 868 37 42  
e-mail: post@pl.tuv.com



Product Certification Body

Tomasz Mańczak

This certificate is subjected to the Certification Regulations as well as the General Conditions of Including Transactions in TRP and refers only to the products consistent with the sample being the basis of the carried out confirmation test. This certificate alone does not entitle the holder to attach the CE marking. The validity of the certificate can be checked on [www.certipedia.com](http://www.certipedia.com)



Safety  
Regular  
Production  
Surveillance



[www.tuv.com](http://www.tuv.com)  
ID 0000051557

TÜV Rheinland®  
Precisely Right.

[www.tuv.pl](http://www.tuv.pl)

# CERTIFICATE

No.: TM 62000762 016



## Licence holder

Company Sporttehnika LTD  
Ushinskogo 24,  
14014 Chernihov  
Ukraine



## Manufacturing Plant

Company Sporttehnika LTD  
Ushinskogo 24,  
14014 Chernihov  
Ukraine

## Project number

26201060 001

## Our reference

39036524

## The period of validity

from 2016-07-22 to 2019-07-12

## Scope of evaluation

EN 16630:2015

## Certification program PCWU-5

## Certified Product (Product Identification)

### Permanently installed outdoor fitness equipment

<b>Product name:</b>	Air rotation	Rowing machine	Bicycle
<b>Symbol:</b>	SE119	SE135	SE139
<b>Dimensions [mm]: L x W x H</b>	1951 x 387 x 2608	1123 x 824 x 887	979 x 482 x 1382
<b>Max load per user [kg]:</b>	130	130	130
<b>Main material:</b>	galvanized and/or powder coated steel; plastic caps, seats; steel/rubber handles; rubber/steel foot supports		

## Product visualization:

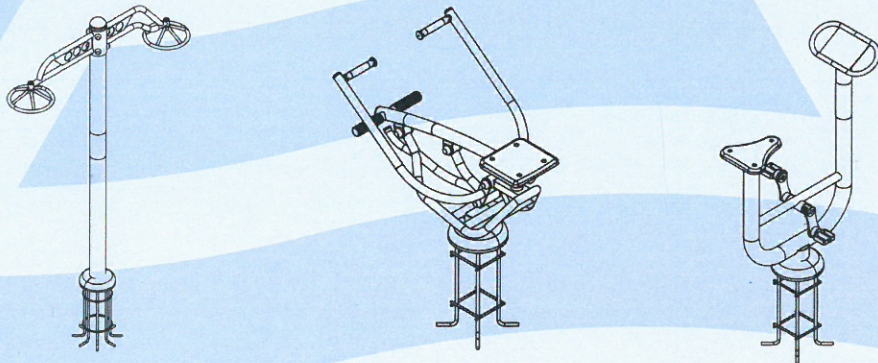

replaces: TM 62000762 006

## TÜV Rheinland Polska Sp. z o.o.

ul. 17 Stycznia 56,  
02-146 Warszawa, Polska  
Tel.: (+48/22) 846 79 99  
Tel.: (+48/22) 868 37 42  
e-mail: post@pl.tuv.com



Product Certification Body

Tomasz Mańczak

Warsaw, 2016-07-22

This certificate is subjected to the Certification Regulations as well as the General Conditions of Including Transactions in TRP and refers only to the products consistent with the sample being the basis of the carried out confirmation test. This certificate alone does not entitle the holder to attach the CE marking. The validity of the certificate can be checked on [www.certipedia.com](http://www.certipedia.com)



Safety  
Regular  
Production  
Surveillance



[www.tuv.com](http://www.tuv.com)  
ID 0000051557

TÜVRheinland®  
Precisely Right.

[www.tuv.pl](http://www.tuv.pl)

# « Eco Building Stage » SRL

R.Moldova, mun.Chisinau, str.V.Micle, 1/1  
IDNO 1012600022637, Certificatul de înregistrare din 19.07.2012,  
BC „VictoriaBank” SA filiala fil. Nr.20 Chisinau, cont de decontare 222452046MDL/USD/EUR,  
Cod VICBMD2X463  
E-mail: ecocarusel@gmail.com  
Tel.+373 22 000 988  
Fax. +373 22 000 188  
Mob. +373 60 281 188  
Administrator Gorșunova Alexandrina

Data:15.03.2019

Către Direcția  
generală locativ-comunală și amenajare

## Scrisoare

Compania “Eco Building Stage S.R.L.” din 2012-2019 și a format baza mare de clienți , a carui număr este trecut deja 300 , printre care:

- Direcția Asistență Socială și Protecție a Familiei Basarabeasca (2 terenuri de joacă)
- Fundația Mission Without Borders-Misiunea fără Frontiere (3 terenuri de joacă)
- IM Gospodăria Locativ Comunală Balti (aproape 50 terenuri de joacă)
- Inamstro SRL (1 teren de joacă)
- MF-TT Edinet Primăria orașului Edinet (3 terenuri de joacă)
- AO Centrul Comunicare Internațională și Drepturile Omului
- Primăria satului Congaz (3 terenuri de joacă)
- Camelon-Cons SRL (Compania de construcție)
- Rodaris-Pro SRL (Compania de construcție)
- Fundația Renato Usati (6 terenuri de joacă)
- Trabo-Plus SRL (Andys Pizza) (2 terenuri de joacă)
- Direcția Educație Tineret și Sport sect. Buiucani
- Asociația Obștească pentru Orhei (3 terenuri de joacă) (Teren mare pentru complex Orheiland)
- Fundația de Binefacere DIN SUFLET (3 terenuri de joacă)
- Horus SRL (Compania de construcție) (2 terenuri de joacă)
- Miron Shor Fundația (6 terenuri de joacă)
- Primăria municipiului Orhei (7 terenuri de joacă)
- Moldova Zahar SRL
- Primăria orașului Causeni (4 terenuri de joacă)
- Fundația lui Vlad Plahotniuc Edelweiss (47 terenuri de joacă)
- Primăria orașului Cimișlia (2 terenuri de joacă)
- Ideal Construct SRL (Compania de construcție)
- Silent Agro SRL (Compania de construcție) (3 terenuri de joacă)
- Primăria orașului Nisporeni (2 terenuri de joacă)
- Rodaris Pro SRL (3 terenuri de joacă)
- A.O.Concordia Proiecte sociale (7 terenuri de joacă)
- Incomas SA
- Reconcivil SRL (Compania de construcție)
- Direcția generală locativ-comunală și amenajare mun.Chișinău (80 terenuri)





**VICTORIABANK**  
PRIMA BANCĂ DIN MOLDOVA



**Filia nr. 17 Chișinău**

Str. 31 August 1989, 64  
MD-2012, mun. Chișinău  
Republica Moldova  
Tel.: (+373 22) 54-75-50, 54-85-73  
Fax: (+373 22) 26-03-66  
SWIFT: VICBMD 2X457  
IDNO 1002600001338  
Capital social - 250 000 910 lei  
www.victoriabank.md

Nr. 77 / 262 din "13" ianuarie 2018

La Nr. \_\_\_\_\_ din "\_\_\_\_" \_\_\_\_\_ 201

Secret bancar  
Confidențial

CERTIFICAT

Prin prezenta BC "Victoriabank" S.A. Sucursala nr.17 Chișinău confirmă precum că,  
ECO BUILDING STAGE SRL (c/f 1012600022637) deține următoarele conturi:

MD90VI000002224317643MDL – cont în lei moldovenești (MDL)

MD25VI000000002224317643 – cont în Dolari SUA (USD)

MD25VI000000002224317643 – cont în euro (EUR)

Certificatul este eliberat pentru a fi prezentat la cerere.

Contabil-șef  
Malovata Inga



Ex: Zaharia Victoria  
Tel. 022-54-75-41

VICTORIABANK

REPUBLICA



MOLDOVA

# CERTIFICAT DE ÎNREGISTRARE

**Societatea cu Răspundere Limitată "ECO BUILDING STAGE"**

ESTE ÎNREGISTRATĂ LA

**CAMERA ÎNREGISTRĂRII DE STAT**

*Numărul de identificare de stat - codul fiscal*

**1012600022637**

*Data înregistrării*

**19.07.2012**

*Data eliberării*

**19.07.2012**

**Ion MERLICI , Registrator**

*Funcția, numele, prenumele persoanei  
care a eliberat certificatul*

*semnătura*

**MD 0119531**

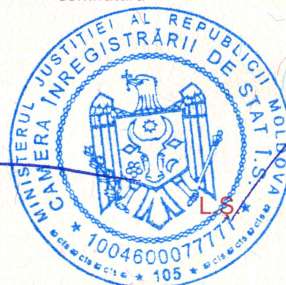



**CERTIFICAT**  
**privind lipsa sau existența restanțelor față de bugetul public național**

Nr. **A1916008**  
№

din **08.04.2019**  
от

**1. Destinatar /** Получатель

ACHIZIȚII PUBLICE

**2. Date despre contribuabil /** Информация о налогоплательщике

<b>Denumirea</b> Наименование	<b>Codul fiscal / Numărul de identificare</b> Фискальный код / Идентификационный номер
<b>ECO BUILDING STAGE S.R.L.</b>	<b>1012600022637</b>
<b>Adresa sediului de bază (strada, numărul)</b> Адрес основного месторасположения (улица, номер)	<b>Codul - Denumirea localității</b> Код - Наименование населенного пункта
<b>Bucuresti nr.57 of.1</b>	<b>0130-SEC.CENTRU</b>

**3. Atestarea lipsei sau existenței restanțelor conform datelor Sistemului Informațional Automatizat /**  
Подтверждение отсутствия или наличия недоимки согласно данных Автоматизированной Информационной Системы

La data emiterii prezentului certificat restanța la bugetul public național constituie/ На дату выдачи данной справки недоимка перед национальным публичным бюджетом составляет:  
**0,00 lei/лей.**

**4. Valabil pînă la /** Действителен до 23.04.2019

**5. Autentificarea organului fiscal /** Подтверждение налогового органа



Semnătura/Подпись

**VIORICA CĂUȘ**

Numele și prenumele/Фамилия и имя



# СЕРТИФІКАТ

Орган з сертифікації  
TÜV SÜD Management Service GmbH

засвідчує, що підприємство



**ТОВ "Компанія Спорттехніка"**

вул. Ушинського, 24  
м. Чернігів, 14014,  
Україна

у наступних галузях:

**Проектування, виробництво,  
реалізація і подальше обслуговування  
спортивно-тренажерного та дитячого ігрового обладнання**

впровадило та використовує систему  
менеджменту якості.

Аудит, номер звіту **70759283**  
підтверджує, що вимоги

**ISO 9001:2015**

виконані.

Сертифікат чинний з **10.09.2018р.** до **21.11.2021р.**

Реєстраційний номер сертифікату: **12 100 37471 TMS.**

Product Compliance  
Management м. Мюнхен,  
14.09.2018р.





Украина, 14014, Чернигов, ул. Ушинского 24  
Телефон/факс: +38 (0462) 662-285

"Eco Building Stage" SRL  
Республика Молдова, г.Кишинёв, ул. Букурешть 57 оф. 1

### **Декларация производителя**

Данным письмом ООО «Компания Спорттехника» подтверждает, что предприятие обладает необходимыми производственными мощностями для производства 40 комплектов следующих площадок в течении 120 дней с момента подтверждения заказа:

- Уличный тренажер SE 107
- Уличный тренажер SE 139
- Уличный тренажер SMP 102.1
- Уличный тренажер SE 115
- Уличный тренажер SL 204
- Турник лестница S 836.2
- Брусья параллельные S 834.2

### **Declarație de la producator**

Prin prezența scrisoarei confirmăm că «Compania Sporttehnica» dispune de capacități de producție pentru a confecționa echipamente necesare pentru 40 terenuri, timp de 120 zile din data confirmării comenzii, în următoare componentă :

- Aparat de fitness SE 107
- Aparat de fitness SE 139
- Aparat de fitness SMP 102.1
- Aparat de fitness SE115
- Aparat de fitness SL 204
- Echipament gimnastic (bara+spalier suedez)
- Echipament gymnastic (paralele)



Director  
V. Liver

# “ Eco Building Stage “ SRL

Mun.Chisinau ,Moldova  
Str.Bucuresti 57 of 1  
C/f: 1012600022637  
TVA 0208451  
IBAN: MD90VI000002224317643MDL  
B BC «VICTORIABANK» SA  
fil. Nr.17 Chisinau  
VICBMD2X457

Catre Direcția generală locativ-comunală  
și amenajare

## Declaratie de garantie

Noi , companie “EcoBuildingStage”S.R.L. confirmam ca perioada de garantie echipamentului nostru conform pasaportului tehnic este 12 luni.

Data : 07.03.2019



# CERTIFICATE

No.: TM 62000796 001



## Licence holder

Company Sporttehnika LTD  
Ushinskogo 24,  
14014 Chernihov,  
Ukraine

## Manufacturing Plant

Company Sporttehnika LTD  
Ushinskogo 24,  
14014 Chernihov,  
Ukraine



## Project number

26201647 001

## Our reference

39044693

## The period of validity

from 2017-03-24 to 2020-03-23

## Scope of evaluation

EN 16630:2015

## Certification program PCWU-5

## Certified Product (Product Identification)

Permanently installed outdoor fitness equipment

Name:	Chest press	Chest press - Lat pull down	Lat pull down	Leg press
Model:	SM101	SM101-102	SM102	SM103
Dimensions: LxWxH [mm]:	1569 x 875 x 1918	1563 x 930 x 1918	1565 x 930 x 1918	1747 x 500 x 1508
Main material:	galvanized or/and powder coated steel			

Product visualization:

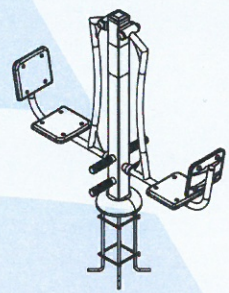
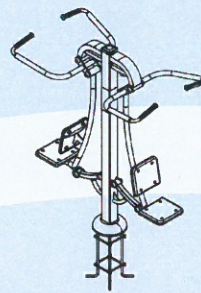
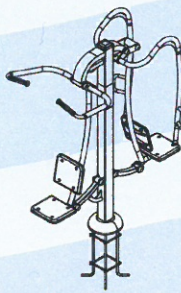
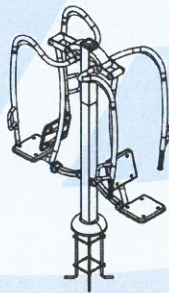

## TÜV Rheinland Polska Sp. z o.o.

ul. 17 Stycznia 56,  
02-146 Warszawa, Polska  
Tel.: (+48/22) 846 79 99  
Tel.: (+48/22) 868 37 42  
e-mail: post@pl.tuv.com



Product Certification Body

Tomasz Mańczak

Warsaw, 2017-03-24

This certificate is subjected to the Certification Regulations as well as the General Conditions of Including Transactions in TRP and refers only to the products consistent with the sample being the basis of the carried out confirmation test. This certificate alone does not entitle the holder to attach the CE marking. The validity of the certificate can be checked on [www.certipedia.com](http://www.certipedia.com)



Safety  
Regular  
Production  
Surveillance



[www.tuv.com](http://www.tuv.com)  
ID 0000051557



AC 141



TÜVRheinland®  
Precisely Right.

[www.tuv.pl](http://www.tuv.pl)

# CERTIFICATE

No.: TM 62000796 005



## Licence holder

Company Sporttehnika LTD  
Ushinskogo 24,  
14014 Chernihov,  
Ukraine

## Manufacturing Plant

Company Sporttehnika LTD  
Ushinskogo 24,  
14014 Chernihov,  
Ukraine



## Project number

26201647 001

## Our reference

39044693

## The period of validity

from 2017-03-24 to 2020-03-23

## Scope of evaluation

EN 16630:2015

## Certification program PCWU-5

## Certified Product (Product Identification)

Permanently installed outdoor fitness equipment

Name:	Pylon posts	Chest press	Leg press	Abductor-adductor
Model:	SMP000.1	SMP101.1	SMP103.1	SMP104.1
Dimensions: LxWxH [mm]:	513 x 100 x 1827	875 x 1022 x 1756	1113 x 500 x 1620	792 x 767 x 1620
Main material:		galvanized or/and powder coated steel		

Product visualization:

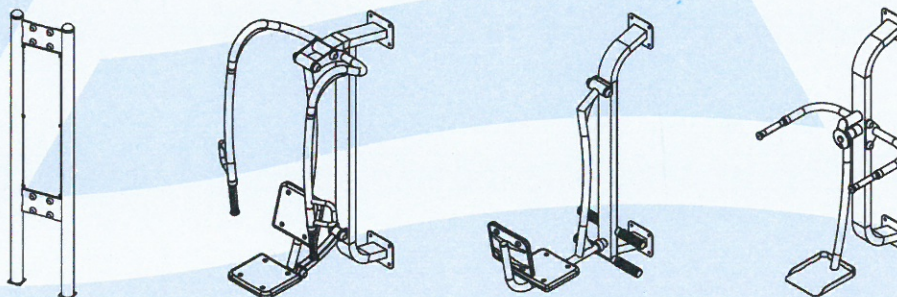

## TÜV Rheinland Polska Sp. z o.o.

ul. 17 Stycznia 56,  
02-146 Warszawa, Polska  
Tel.: (+48/22) 846 79 99  
Tel.: (+48/22) 868 37 42  
e-mail: post@pl.tuv.com



Product Certification Body

Tomasz Mańczak

Warsaw, 2017-03-24

This certificate is subjected to the Certification Regulations as well as the General Conditions of Including Transactions in TRP and refers only to the products consistent with the sample being the basis of the carried out confirmation test. This certificate alone does not entitle the holder to attach the CE marking. The validity of the certificate can be checked on [www.certipedia.com](http://www.certipedia.com)



Safety  
Regular  
Production  
Surveillance



[www.tuv.com](http://www.tuv.com)  
ID 0000051557



AC 141

TÜVRheinland®  
Precisely Right.

[www.tuv.pl](http://www.tuv.pl)

# CERTIFICATE

No.: TM 62000796 007



## Licence holder

Company Sporttehnika LTD  
Ushinskogo 24,  
14014 Chernihov,  
Ukraine

## Manufacturing Plant

Company Sporttehnika LTD  
Ushinskogo 24,  
14014 Chernihov,  
Ukraine



## Project number

26201647 001

## Our reference

39044693

## The period of validity

from 2017-03-24 to 2020-03-23

## Scope of evaluation

EN 16630:2015

## Certification program PCWU-5

## Certified Product (Product Identification)

Permanently installed outdoor fitness equipment

Name:

**Support for abdominal muscles**

**Hyperextension**

**Outdoor rower**

Model:

SMP125.1

SMP134.1

SMP135.1

Dimensions: LxWxH  
[mm]:

935 x 704 x 1620

1129 x 653 x 803

987 x 957 x 962

Main material:

galvanized or/and powder coated steel

Product  
visualization:

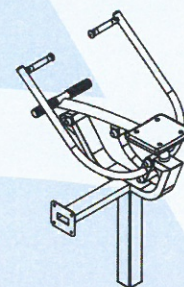
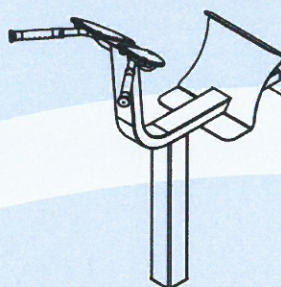
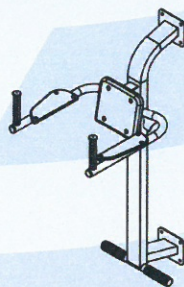

## TÜV Rheinland Polska Sp. z o.o.

ul. 17 Stycznia 56,  
02-146 Warszawa, Polska  
Tel.: (+48/22) 846 79 99  
Tel.: (+48/22) 868 37 42  
e-mail: [post@pl.tuv.com](mailto:post@pl.tuv.com)



Product Certification Body

Tomasz Mańczak

Warsaw, 2017-03-24

This certificate is subjected to the Certification Regulations as well as the General Conditions of Including Transactions in TRP and refers only to the products consistent with the sample being the basis of the carried out confirmation test. This certificate alone does not entitle the holder to attach the CE marking. The validity of the certificate can be checked on [www.certipedia.com](http://www.certipedia.com)



Safety  
Regular  
Production  
Surveillance



[www.tuv.com](http://www.tuv.com)  
ID 0000051557



AC 141

TÜVRheinland®  
Precisely Right.

[www.tuv.pl](http://www.tuv.pl)