



VVF42..  
VVF42..K



VXF42..

ACVATIX™

## 2- and 3-port valves with flanged connections, PN 16

**VVF42..  
VVF42..K  
VXF42..**

From the large-stroke valve line

- 
- Performance valves for medium temperatures from -10...150 °C
  - Valve body of grey cast iron EN-GJL-250
  - DN 15...150
  - $k_{vs}$  1.6...400 m<sup>3</sup>/h
  - Flange type 21, flange design B
  - VVF42..K with pressure compensation to handle high differential pressure
  - Equipable with electro-motoric actuators SAX.., SAV.. or electro-hydraulic actuators SKD.., SKB.., SKC..

### Use

---

In boiler, district heating and refrigeration plants, cooling towers, heating groups, in ventilation and air-handling units as control or shutoff valves.

For use in closed hydraulic circuits (observe cavitation).

## Type summary

Valves	Actuators Stroke Positioning force Data sheet				SAX.. <sup>1)</sup>		SKD..		SKB..		SAV.. <sup>1)</sup>		SKC..	
					20 mm				40 mm					
					800 N		1000 N		2800 N		1600 N		2800 N	
PN 16		N4501		N4561		N4564		N4503		N4566				
	Stock number	DN	k <sub>vs</sub> [m <sup>3</sup> /h]	S <sub>V</sub>	Δp <sub>s</sub>	Δp <sub>max</sub>	Δp <sub>s</sub>	Δp <sub>max</sub>	Δp <sub>s</sub>	Δp <sub>max</sub>	Δp <sub>s</sub>	Δp <sub>max</sub>	Δp <sub>s</sub>	Δp <sub>max</sub>
-10...150 °C	[kPa]													
VVF42.15-1.6	S55204-V100	15	1.6	> 50	1600	400	1600	400	1600	400	-	-	-	-
VVF42.15-2.5	S55204-V101	15	2.5											
VVF42.15-4	S55204-V102	15	4											
VVF42.20-6.3	S55204-V103	20	6.3											
VVF42.25-6.3	S55204-V104	25	6.3											
VVF42.25-10	S55204-V105	25	10											
VVF42.32-16	S55204-V106	32	16											
VVF42.40-16	S55204-V107	40	16											
VVF42.40-25	S55204-V108	40	25											
VVF42.50-31.5	S55204-V109	50	31.5											
VVF42.50-40	S55204-V110	50	40	> 100	1600	400	1600	400	1600	400	900	-	-	-
VVF42.65-50	S55204-V111	65	50											
VVF42.65-63	S55204-V112	65	63											
VVF42.80-80	S55204-V113	80	80											
VVF42.80-100	S55204-V114	80	100											
VVF42.100-125	S55204-V115	100	125											
VVF42.100-160	S55204-V116	100	160											
VVF42.125-200	S55204-V117	125	200											
VVF42.125-250	S55204-V118	125	250											
VVF42.150-315	S55204-V119	150	315											
VVF42.150-400	S55204-V120	150	400											
-5...150 °C														
VVF42.50-40K	S55204-V121	50	40	> 100	1600	400	1600	400	1600	400	-	-	-	-
VVF42.65-63K	S55204-V122	65	63											
VVF42.80-100K	S55204-V123	80	100											
VVF42.100-160K	S55204-V124	100	160											
VVF42.125-250K	S55204-V125	125	250											
VVF42.150-360K	S55204-V126	150	360	-	-	-	-	-	-	1600	400	1600	400	
											1400			

<sup>1)</sup> Suitable for medium temperatures up to 130 °C; SAV.. available in select countries only

Valves	Actuators				SAX.. <sup>1)</sup>	SKD..	SKB..	SAV.. <sup>1)</sup>	SKC..											
	Stroke				20 mm		40 mm													
PN 16	Positioning force				800 N	1000 N	2800 N	1600 N	2800 N											
	Data sheet				N4501	N4561	N4564	N4503	N4566											
	Stock number	DN	k <sub>vs</sub> [m <sup>3</sup> /h]	S <sub>v</sub>	$\Delta p_{max}$ [kPa]															
					A $\rightarrow$ AB B	AB $\rightarrow$ A B	A $\rightarrow$ AB B	AB $\rightarrow$ A B	A $\rightarrow$ AB B	AB $\rightarrow$ A B	A $\rightarrow$ AB B	AB $\rightarrow$ A B	A $\rightarrow$ AB B	AB $\rightarrow$ A B						
-10...150 °C																				
VXF42.15-1.6	S55204-V127	15	1.6	> 50	400	100	400	100	400	100	-	-	-	-	-	-	-	-	-	-
VXF42.15-2.5	S55204-V128	15	2.5																	
VXF42.15-4	S55204-V129	15	4																	
VXF42.20-6.3	S55204-V130	20	6.3																	
VXF42.25-6.3	S55204-V131	25	6.3																	
VXF42.25-10	S55204-V132	25	10																	
VXF42.32-16	S55204-V133	32	16	> 100	300	50	200	80	400	100	400	100	-	-	-	-	-	-	-	-
VXF42.40-16	S55204-V134	40	16																	
VXF42.40-25	S55204-V135	40	25																	
VXF42.50-31.5	S55204-V136	50	31.5																	
VXF42.50-40	S55204-V137	50	40																	
VXF42.65-50	S55204-V138	65	50																	
VXF42.65-63	S55204-V139	65	63																	
VXF42.80-80	S55204-V140	80	80																	
VXF42.80-100	S55204-V141	80	100																	
VXF42.100-125	S55204-V142	100	125																	
VXF42.100-160	S55204-V143	100	160																	
VXF42.125-200	S55204-V144	125	200																	
VXF42.125-250	S55204-V145	125	250	-	-	-	-	-	-	-	125	50	250	50						
VXF42.150-315	S55204-V146	150	315	-	-	-	-	-	-	-	90	160	100	50						
VXF42.150-400	S55204-V147	150	400	-	-	-	-	-	-	-	60	100	100	50						

<sup>1)</sup> Suitable for medium temperatures up to 130 °C; SAV.. available in select countries only

DN = Nominal size

k<sub>vs</sub> = Flow nominal value of cold water (5...30 °C) through the fully opened valve (H<sub>100</sub>) at a differential pressure of 100 kPa (1 bar)

S<sub>v</sub> = Rangeability

$\Delta p_s$  = Maximum permissible differential pressure at which the motorized valve still closes securely against the pressure

$\Delta p_{max}$  = Maximum permissible differential pressure across the valve's throughport for the entire positioning range of the motorized valve

## Ordering

### Example

Product number	Stock number	Description
VXF42.65-63	S55204-V139	3-port valve with flange, PN 16
SKD32.50	SKD32.50	Electro-hydraulic actuator

### Delivery

Valves, actuators and accessories are packed and delivered as separate items.

### Note

Counter-flanges, bolts and gaskets must be provided on site.

### Spare parts, Rev.-No.

See page 13

## Equipment combinations

Product number	Description	Stroke	Positioning force	Operating voltage	Positioning signal	Spring return time	Positioning time	LED	Manual adjuster	Auxiliary functions						
SAX31.00	S55150-A105	20 mm	800 N	AC 230 V	3-position	-	120 s	-	Press and fix	1)						
SAX31.03	S55150-A106						30 s	✓			2), 3)					
SAX61.03 SAX61.03U	S55150-A100 S55150-A100-A100			AC 24 V DC 24 V	0...10 V 4...20 mA 0...1000 Ω		120 s	-		1)						
SAX81.00 SAX81.03U	S55150-A102 S55150-A103 S55150-A103-A100						3-position	-				30 s	-			
SKD32.21	SKD32.21			20 mm	1000 N		AC 230 V	3-position		8 s	Opening: 30 s Closing: 10 s	-	Turn, Position is maintained	1)		
SKD32.50	SKD32.50	-	120 s			-										
SKD32.51	SKD32.51	8 s	-			-										
SKD60	SKD60	AC 24 V	0...10 V 4...20 mA 0...1000 Ω			-	15 s	Opening: 30 s Closing: 15 s	✓	2)						
SKD62 SKD62U	SKD62 SKD62U					15 s					-					
SKD62UA	SKD62UA					-					-	4)				
SKD82.50 SKD82.50U	SKD82.50 SKD82.50U					3-position					-	120 s		-	1)	
SKD82.51 SKD82.51U	SKD82.51 SKD82.51U										8 s			-		
SKB32.50	SKB32.50	20 mm	2800 N	AC 230 V	3-position	-	120 s	-	Turn, Position is maintained	1)						
SKB32.51	SKB32.51					10 s					-					
SKB60	SKB60			AC 24 V	0...10 V 4...20 mA 0...1000 Ω	-	10 s			Opening: 120 s Closing: 10 s	✓	2)				
SKB62 SKB62U	SKB62 SKB62U					10 s							-	4)		
SKB62UA	SKB62UA					-							-	-		
SKB82.50 SKB82.50U	SKB82.50 SKB82.50U					3-position							-	120 s	-	1)
SKB82.51 SKB82.51U	SKB82.51 SKB82.51U												10 s		-	
SAV31.00	S55150-A112	40 mm	1600 N	AC 230 V	3-position	-	120 s	-	Press and fix	1), 5)						
SAV61.00 SAV61.00U	S55150-A110 S55150-A110-A100			AC 24 V DC 24 V	0...10 V 4...20 mA 0...1000 Ω			✓		1), 2), 5), 6)						
SAV81.00 SAV81.00U	S55150-A111 S55150-A111-A100			3-position	-			-		1), 5)						
SKC32.60	SKC32.60	40 mm	2800 N	AC 230 V	3-position	-	120 s	-	Turn, Position is maintained	1)						
SKC32.61	SKC32.61					18 s					-					
SKC60	SKC60					-					-					
SKC62 SKC62U	SKC62 SKC62U			AC 24 V	0...10 V 4...20 mA 0...1000 Ω	20 s	Opening: 120 s Closing: 20 s			✓	2)					
SKC62UA	SKC62UA					-						-	4)			
SKC82.60 SKC82.60U	SKC82.60 SKC82.60U			3-position	-	120 s	-			1)						
SKC82.61 SKC82.61U	SKC82.61 SKC82.61U				18 s		-									

- 1) Auxiliary switch, potentiometer  
2) Position feedback, forced control, selection of valve characteristic  
3) Optional: sequence control, selection of acting direction  
4) Plus sequence control, stroke limitation, and selection of acting direction  
5) Stem heating element (optional)  
6) Function module (optional)

- Mounting Instructions M4030 74 319 0749 0
- Basic documentation P4030 Contains background information and technical basic knowledge of valves

Technical and mechanical design

The illustrations below show the basic design of the valves. Constructional features, such as the shape of plugs, may differ.

2-port valves

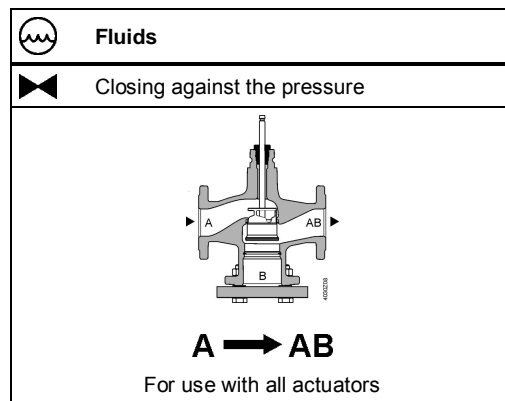

2-port valves pressure compensated

The VVF42..K valves use a pressure-compensated plug. This enables the same type of actuators to be used for the control of volumetric flow at higher differential pressures.

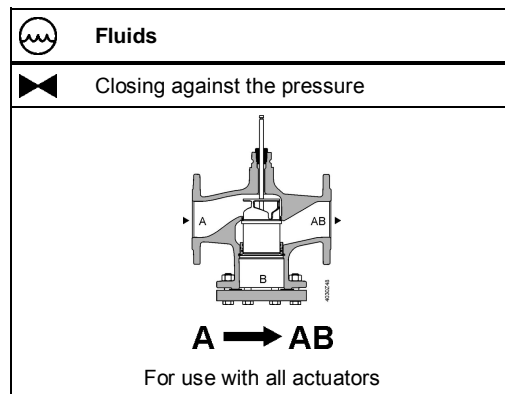

Note

**2-port valves do not become 3-port valves by removing the blank flange!**

3-port valves

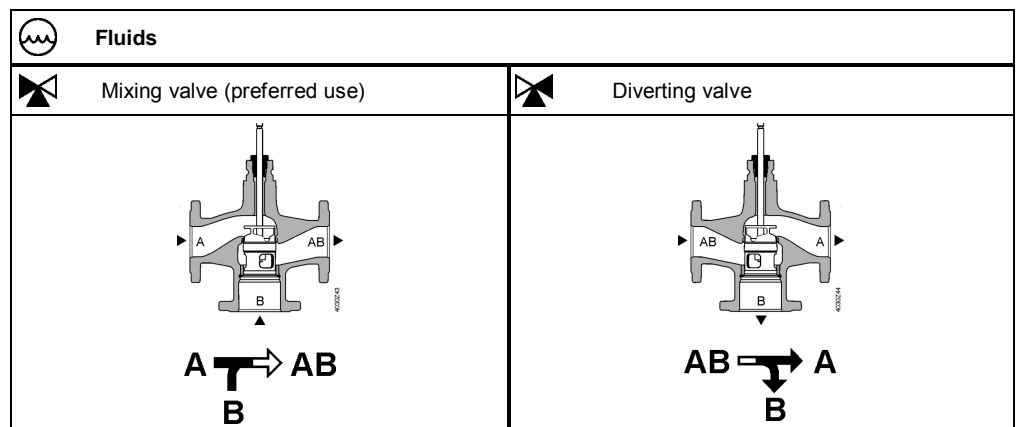

## Accessories

Product number	Stock number	Description	Note	Example
ASZ6.6	S55845-Z108	Stem heating element	Required for medium temperatures < 0 °C	

## Sizing

### Flow chart

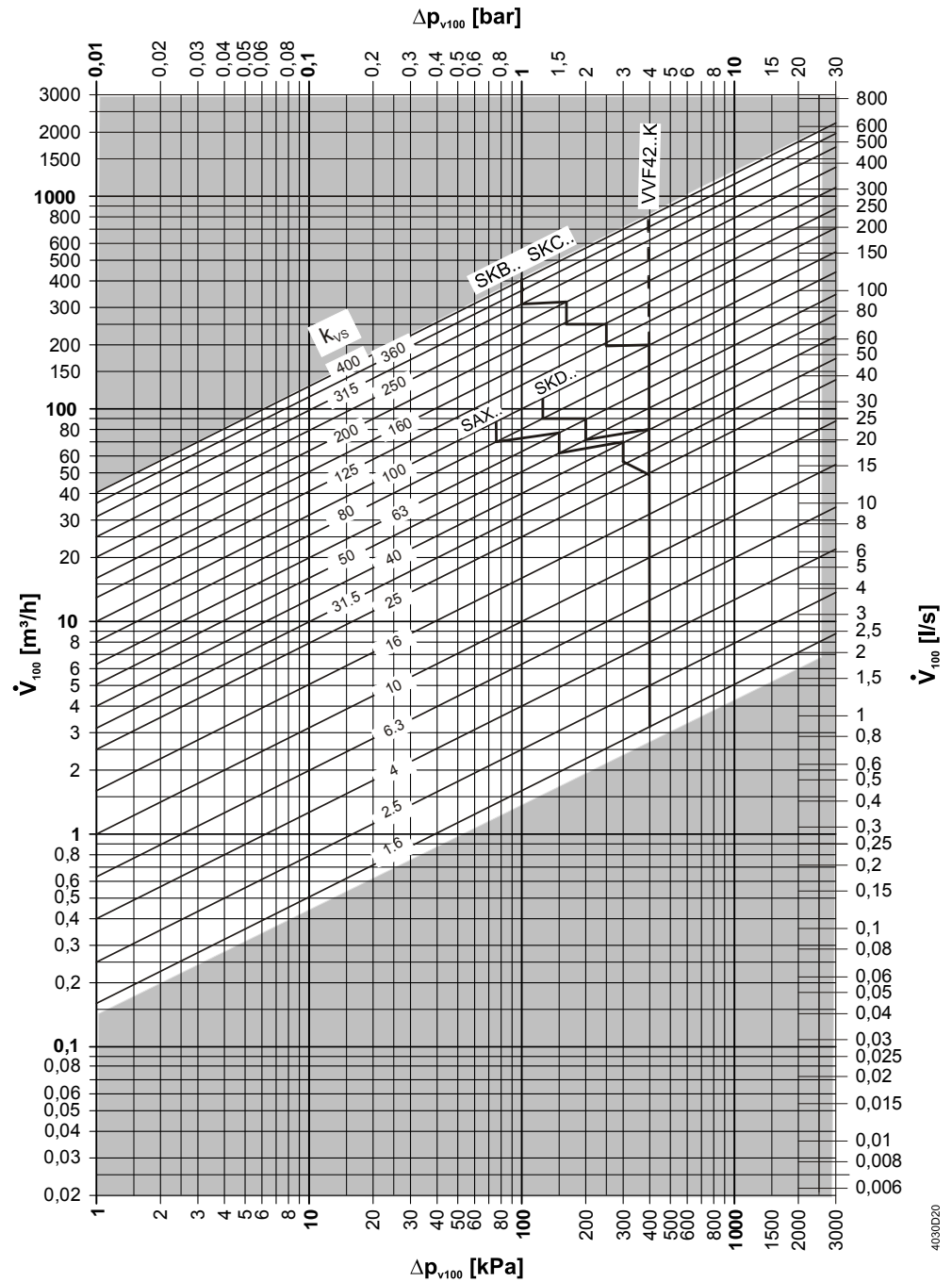

$\Delta p_{\text{max}}$  values apply for the mixing function.  $\Delta p_{\text{max}}$  values for the diverting function see table „Type summary“, page 2

**Valve characteristics**  
**2-port valves**

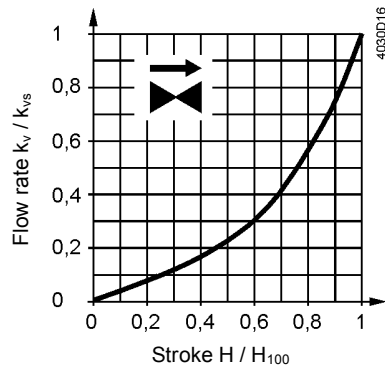

0...30%: Linear  
30...100%: Equal percentage  
 $n_{gl} = 3$  to VDI / VDE 2173  
For high  $k_{vs}$  values the valve characteristic is optimized for maximum volumetric flow  $k_{V100}$ .

For product lines:  
VVF42.125-250  
VVF42.125-250K  
VVF42.150-400  
VVF42.150-360K

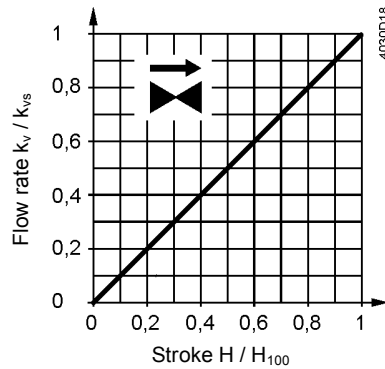

0...100%: Linear

**3-port valves**

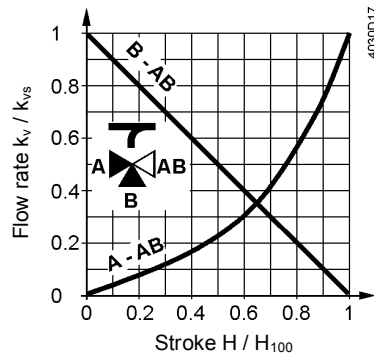

**Throughport A-AB**

0...30%: Linear  
30...100%: Equal percentage  
 $n_{gl} = 3$  to VDI / VDE 2173

For high  $k_{vs}$  values the valve characteristic is optimized for maximum volumetric flow  $k_{V100}$ .

**Bypass B-AB**

0...100%: Linear  
Tor AB = constant flow  
Tor A = variable flow  
Tor B = bypass (variable flow)

**Mixing:** Flow from port A and port B to port AB  
**Diverting:** Flow from port AB to port A and port B

For product lines:  
VXF42.125-250  
VXF42.150-400

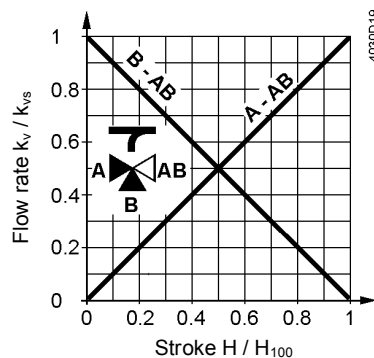

**Throughport A-AB**

0...100%: Linear

**Bypass B-AB**

0...100%: Linear

## Operating pressure and medium temperature

Fluids, PN16 with V..F42..

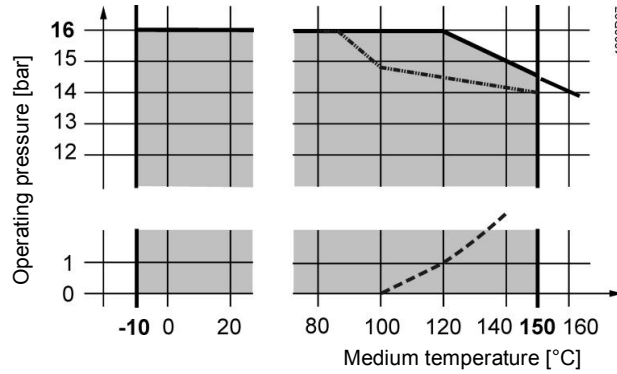

- Curve for saturated steam; steam forms below this line
- . . Operating pressure according to EN 1092-1, valid for 2-port valves with blank flange

## Operating pressure and operating temperatures according to ISO 7005, EN 1092 and EN 12284

Notes

All relevant local directives must be observed

## Medium compatibility and temperature ranges

Medium	Temperature range		Valve			Note
	T <sub>min</sub> [°C]	T <sub>max</sub> [°C]	VVF42..	VVF42..K	VXF42..	
Cold water	1	25	■	■	■	-
Low-temperature hot water	1	130	■	■	■	-
High-temperature hot water <sup>1)</sup>	130	150	■	■	■	-
	150	180	-	-	-	-
Water with antifreeze	-5	150	■	■	■	For medium temperatures below 0 °C, the stem heating ASZ6.6 has to be installed.
	-10	150	■	- <sup>3)</sup>	■	
	-20	150	-	-	-	
Cooling water <sup>2)</sup>	1	25	-	-	-	-
Brines	-5	150	■	■	■	For medium temperatures below 0 °C, the stem heating ASZ6.6 has to be installed.
	-10	150	■	- <sup>3)</sup>	■	
	-20	150	-	-	-	
Super-clean water (demineralized and deionized water)	1	150	-	-	-	
Demineralized water according to VDI2035 / SWKI_BT102-01	1	150	■	■	■	

<sup>1)</sup> Differentiation due to saturated steam curve

<sup>2)</sup> Open circuits

<sup>3)</sup> VVF42..K can't be used with media below -5 °C due to the compensation sealing material

## Fields of use

Fields of use		Valves		
		VVF42..	VVF42..K	VXF42..
Generation	Boiler plants	■	■	■
	District heating plants	■	■	-
	Refrigeration plants	■	■	■
Distribution	Heating groups	■	■	■
	Ventilation and air-handling units	■	■	■



## Engineering notes

Mounting location	Preferably mount the valves at the return, as the temperature is lower there and the strain on the stem sealing gland is lower.
Dirt trap	Mount a dirt filter or dirt trap before the valve to ensure proper functioning, and a long service life of the valve. Remove dirt, welding beads, etc. from the valves and pipes.
Cavitation	Cavitation can be avoided by limiting the pressure differential across the valve depending on the medium temperature and prepressure.

## Mounting notes

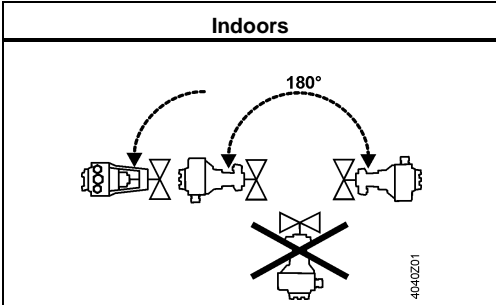
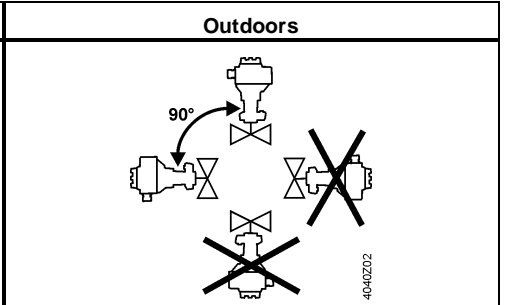
Monting position	<b>Indoors</b>	<b>Outdoors</b>
		

Mounting positions apply to both 2- and 3-port valves.

## Commissioning notes



**The valve may be put into operation only if actuator and valve are correctly assembled.**

Note Ensure that actuator stem and valve stem are rigidly connected in all positions.

## Function check

Valve	Throughport A→AB	Bypass B→AB
Valve stem extends	Closes	Opens
Valve stem retracts	Opens	Closes

## Maintenance notes

Valves are equipped with maintenance-free, continuously lubricated stem sealing glands. See page 13 for replacement stem sealing glands.



When servicing valves or actuators:

- Deactivate the pump and turn off the power supply
- Close the shutoff valves
- Fully reduce the pressure in the piping system and allow pipes to completely cool down

If necessary, disconnect the electrical wires.

## Disposal

Do not dispose of the device as household waste.

- Special handling of individual components may be mandated by law or make ecological sense.
- Observe all local and currently applicable laws and regulations.

## Warranty

Application-related technical data are guaranteed only when the valves are used in connection with the Siemens actuators listed under "Equipment combinations", page 4.

When used with actuators of other manufacture, any warranty by Siemens becomes void.

## Technical data

Functional data	PN class	PN 16		
	Connection	Flange		
	Operating pressure	See Section "Operating pressure and medium temperatures", page 8		
	Valve characteristics <sup>1)</sup>	See section "Valve characteristics", page 7		
	Leakage rate	Throughport	0...0.02% of $k_{vs}$ value	
		Bypass	0.5...2% of $k_{vs}$ value ( $k_{vs} \geq 6.3$ ) 0.5...3% of $k_{vs}$ value ( $k_{vs} 1.6; 2.5; 4$ )	
	Permissible media	See table "Medium compatibility and temperature ranges", page 8		
	Medium temperature	-10...150 °C VVF42..K: -5...150 °C		
	Rangeability	To DN 25: > 50 From DN 32: >100		
	Nominal stroke	To DN 80: 20 mm From DN 100: 40 mm		
	Materials	Valve body	EN-GJL-250	
Blank flange		VVF.	S235JRG2	
Valve stem		Stainless steel		
Seat		Machined		
Plug		VVF..., VXF...:	Brass/ Bronze	
		VVF..K...:	DN 65, DN 80	Brass/ Bronze
			DN 50, DN 100...150	Stainless steel
Stem sealing gland		Brass EPDM O-rings PTFE sleeve silicon-free		
Compensation sealing		Stainless steel FEPM (silicone-free)		

Standards, directives and approvals	Pressure Equipment Directive	PED 2014/68/EU		
	Pressure-carrying accessories	Scope: Article 1, section 1 Definitions: Article 2, section 5		
	Fluid group 2	PN 16		
	≤DN 50	Without CE certification as per article 4, section 3 (sound engineering practice) <sup>2)</sup>		
	DN 65...125	Category I, Modul A, with CE-marking as per article 14, section 2		
	DN 150	Category II, Modul A2, with CE-marking as per article 14, section 2, notified body number 0036		
	EU conformity (CE)			
		DN 65...150	A5W00006523 <sup>3)</sup>	
	PN class		ISO 7268	
	Operating pressure		ISO 7005, DIN EN 12284	
	Flanges		ISO 7005	
	Length of flanged valves		DIN EN 558-1, line 1	
	Valve characteristic		VDI 2173	
	Leakage rate		Throughport, bypass according to EN 60534-4 / EN 1349	
Water treatment		VDI 2035		
Environmental conditions				
	Storage: IEC 60721-3-1	Class	1K3	
		Temperature	-15...+55 °C	
		Rel. humidity	5...95% r.h.	
	Transport: IEC 60721-3-2	Class	2K3, 2M2	
		Temperature	-30...+65 °C	
		Rel. humidity	< 95% r.h.	
	Operation: IEC 60721-3-3	Class	3K5, 3Z11	
		Temperature	-15...+55 °C	
		Rel. humidity	5...95% r.h.	
Environmental compatibility	The product environmental declaration CE1E4403en01 <sup>3)</sup> , CE1E4403en02 <sup>3)</sup> and CE1E4403en03 <sup>3)</sup> contains data on environmentally compatible product design and assessments (RoHS compliance, materials composition, packaging, environmental benefit, disposal).			
Dimensions / Weight	Dimensions	See „Dimensions“, page 12/13		
	Weight	See „Dimensions“, page 12/13		

<sup>1)</sup> For certain valve lines and high  $k_{vs}$  values, the valve characteristic is optimized for maximum volumetric flow  $k_{V100}$ .

<sup>2)</sup> Valves where  $PS \times DN < 1000$ , do not require special testing and cannot carry the CE label.

<sup>3)</sup> The documents can be downloaded from <http://siemens.com/bt/download>

## Dimensions

### VVF42.. VVF42..K

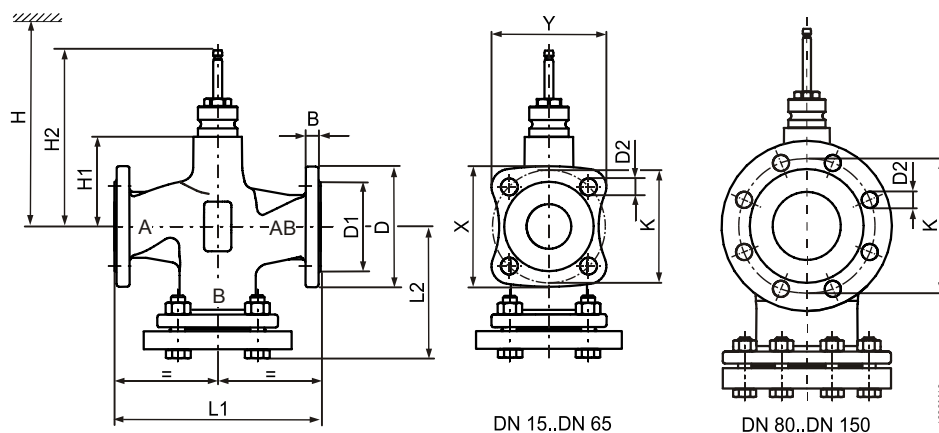

Product number	DN	kg	B	Ø D	Ø D1	Ø D2	L1	L2	X	Y	Ø K	H1	H2	H				
														SAX..	SKD..	SKB..	SAV..	SKC..
VVF42..	15	3.7	14	95	46	14 (4x)	130	86	79	76	65	37	133.5	479	537	612	-	-
	20	4.7	16	105	56	14 (4x)	150	97	86.6	83	75	37	133.5	479	537	612	-	-
	25	5.4	15	115	65	14 (4x)	160	106.5	94.4	90.1	85	37	133.5	479	537	612	-	-
	32	8.4	17	140	76	19 (4x)	180	119	115.6	110.7	100	37	133.5	479	537	612	-	-
	40	9.3	16	150	84	19 (4x)	200	126	123.2	117.8	110	37	133.5	479	537	612	502	-
	50	12.2	16	165	99	19 (4x)	230	144	135.2	128.4	125	50	146.5	492	550	625	525	-
	65	17	17	185	118	19 (4x)	290	174	150	142.5	145	75	171.5	517	575	650	540	-
	80	25	17	200	132	19 (8x)	310	186	-	-	160	75	171.5	517	575	650	540	-
	100	35.9	17	220	156	19 (8x)	350	205	-	-	180	110	226.5	-	-	-	575	685
	125	52.5	17	250	184	19 (8x)	400	233	-	-	210	123	239.5	-	-	-	588	698
VVF42..K	150	74.9	17	284	211	23 (8x)	480	275.5	-	-	240	150.5	267	-	-	-	616	726
	50	12	16	165	99	19 (4x)	230	144	135.2	128.4	125	50	146.5	492	550	625	-	-
	65	17.7	17	185	118	19 (4x)	290	174	150	142.5	145	75	171.5	517	575	650	-	-
	80	26.8	17	200	132	19 (8x)	310	186	-	-	160	75	171.5	517	575	650	-	-
	100	35.3	17	220	156	19 (8x)	350	206	-	-	180	110	226.5	-	-	-	575	685
	125	51.6	17	250	184	19 (8x)	400	233	-	-	210	123	239.5	-	-	-	588	698
150	74.8	17	284	211	23 (8x)	480	275.5	-	-	240	150.5	267	-	-	-	616	726	

## VXF42..

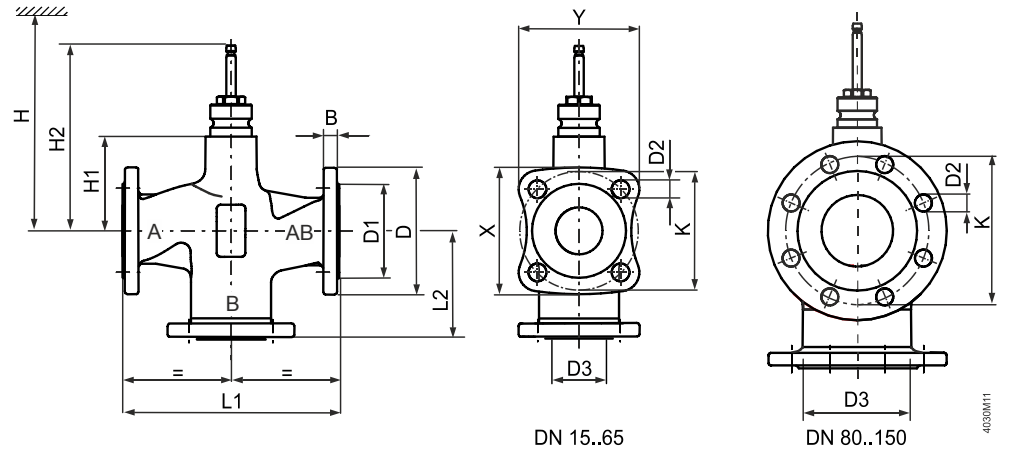

DN 15..65

DN 80..150



4030M11

Product number	DN	kg	B	Ø D	Ø D1	Ø D2	Ø D3 <sup>1)</sup>	L1	L2	X	Y	Ø K	H1	H2	H				
															SAX..	SKD..	SKB..	SAV..	SKC..
VXF42..	15	2.6	14	95	46	14 (4x)	23	130	65	79	76	65	37	133.5	479	537	612	-	-
	20	3.3	16	105	56	14 (4x)	29	150	75	86.6	83	75	37	133.5	479	537	612	-	-
	25	3.8	15	115	65	14 (4x)	36	160	80	94.4	90.1	85	37	133.5	479	537	612	-	-
	32	5.7	17	140	76	19 (4x)	46	180	90	115.6	110.7	100	37	133.5	479	537	612	-	-
	40	6.3	16	150	84	19 (4x)	56	200	100	123.2	117.8	110	37	133.5	479	537	612	502	-
	50	8.7	16	165	99	19 (4x)	69	230	115	135.2	128.4	125	50	146.5	492	550	625	525	-
	65	12.9	17	185	118	19 (4x)	85	290	145	150	142.5	145	75	171.5	517	575	650	540	-
	80	19.2	17	200	132	19 (8x)	102	310	155	-	-	160	75	171.5	517	575	650	540	-
	100	29	17	220	156	19 (8x)	124	350	175	-	-	180	110	226.5	-	-	-	575	685
	125	43.2	17	250	184	19 (8x)	149	400	200	-	-	210	123	239.5	-	-	-	588	698
150	62.1	17	284	211	23 (8x)	174	480	240	-	-	240	150.5	267	-	-	-	616	726	

<sup>1)</sup> Interior opening of the bypass port

## Spare parts

### Stem sealing gland

Product number	DN	Stock number	Comments	Image
VVF42.. VXF42..	DN 15...80	4 284 8806 0	Series A	 4 284 8806 0
	DN 100...150	4 284 8806 0	Series A, B and C until October 2015	
	DN 100...150	4 679 5629 0	Series D as of October 2015	
VVF42..K	DN 50...80	4 284 8806 0	Series A, B	 4 679 5629 0
	DN 100...150	4 284 8806 0	Series A	
	DN 100...150	4 679 5629 0	Series B	

## Revision numbers

VVF..  
VXF..

Product number	Valid from rev. no.	Product number	Valid from rev. no.
VVF42.15-1.6	..A	VXF42.15-1.6	..A
VVF42.15-2.5	..A	VXF42.15-2.5	..A
VVF42.15-4	..A	VXF42.15-4	..A
VVF42.20-6.3	..A	VXF42.20-6.3	..A
VVF42.25-6.3	..A	VXF42.25-6.3	..A
VVF42.25-10	..A	VXF42.25-10	..A
VVF42.32-16	..A	VXF42.32-16	..A
VVF42.40-16	..A	VXF42.40-16	..A
VVF42.40-25	..A	VXF42.40-25	..A
VVF42.50-31.5	..A	VXF42.50-31.5	..A
VVF42.50-40	..A	VXF42.50-40	..A
VVF42.65-50	..A	VXF42.65-50	..A
VVF42.65-63	..A	VXF42.65-63	..A
VVF42.80-80	..A	VXF42.80-80	..A
VVF42.80-100	..A	VXF42.80-100	..A
VVF42.100-125	..D	VXF42.100-125	..D
VVF42.100-160	..D	VXF42.100-160	..D
VVF42.125-200	..D	VXF42.125-200	..D
VVF42.125-250	..D	VXF42.125-250	..D
VVF42.150-300	..D	VXF42.150-300	..D
VVF42.150-400	..D	VXF42.150-400	..D
VVF42.50-40K	..B		
VVF42.65-63K	..A		
VVF42.80-100K	..A		
VVF42.100-160K	..B		
VVF42.125-250K	..B		
VVF42.150-360K	..B		

Issued by  
Siemens Switzerland Ltd  
Building Technologies Division  
International Headquarters  
Gubelstrasse 22  
6301 Zug  
Switzerland  
Tel. +41 41-724 24 24  
[www.siemens.com/buildingtechnologies](http://www.siemens.com/buildingtechnologies)

© Siemens Switzerland Ltd, 2013  
Technical specifications and availability subject to change without notice.