



ELECTROTECHNICAL TESTING INSTITUTE
Pod Lisem 129
171 02 Praha 8 - Troja

No. of pages: 26
No. of annexes/No. of an. pages: 0/0

No. of the Test Report: 701588-01/02

Issued: 4. 8. 2017



TEST REPORT

Name of product: Fixed general purpose luminaires, recessed luminaires

Type of product: URBINI LED, class I

Ratings: 220-240 V, 50/60Hz, 21 W, 29 W, 38 W, IK 09, IP 66 Class I

Serial number: --

Manufacturer: LUG Light Factory Sp. z o.o., ul. Gorzowska 11, 65-127 Zielona Góra, Polsko

Production site: LUG Light Factory Sp. z o.o., ul. Gorzowska 11, 65-127 Zielona Góra, Poland

Ordering firm: LUG Light Factory Sp. z o.o., ul. Gorzowska 11, 65-127 Zielona Góra, Polsko

Number of tested samples: 1, type representative: 130232.5L111.1X1

Samples submitted on: 3. 7. 2017

Location of testing: EZÚ

Tested from 27. 7. 2017 **through** 31. 7. 2017

Other data: -

The product was tested according to: ČSN EN 55015 ed. 4:14,
ČSN EN 61547: ed. 2:10,
ČSN EN 61000-3-3 ed. 3 :14,
ČSN EN 61000-3-2 ed. 4:15.

Compiled by: David Nádherný



Approved by: Miroslav Vondra
Testing laboratory technical manager

Test results stated in the test report apply only to the tested subject and unless specified otherwise in the test report, the tests were performed using the method and under the conditions determined in the test regulations, technical norm, instructions for use and information provided by the manufacturer on the tested subject and using accessories required by the manufacturer. Without written consent, this report must not be reproduced in any other way than as a whole.



1. Emission

- (ČSN) EN 55015:2013 *Limits and methods of measurement of radio disturbance characteristics of electrical lighting and similar equipment*
- (ČSN) EN 61000-3-2:2014 *Electromagnetic compatibility (EMC) - Limits - Limits for harmonic current emission*
- (ČSN) EN 61000-3-3 :2013 *Electromagnetic compatibility (EMC) -Part 3-3: Limits - Limitation of voltage changes, voltage fluctuations and flicker in public low-voltage supply systems, for equipment with rated current $\leq 16A$ per phase and not subject to conditional connection*
-

Product: Fixed general purpose luminaires, recessed luminaires

Type: URBINI LED, class I

Type representative: 130232.5L111.1X1

Requirements at tests:

Standard	Frequency band	Allowed values	Note
(ČSN) EN 55015 Art. 4.3.3	f [MHz] 0.15 - 0.5 0.05 - 30	QP / AV [dB(μV)] 84 - 74 / 74 - 64 74 / 64	Not applicable *1)
(ČSN) EN 55015 Art. 4.3.1	f [MHz] 0.009 - 0.05 0.05 - 0.15 0.15 - 0.5 0.5 - 5 5 - 30	QP / AV [dB(μV)] 110 / --- 90-80 / --- 66-56 / 56-46 56 / 46 60 / 50	Pass
(ČSN) EN 55015 Art. 4.4.1 (d=2m)	f [MHz] 0.009 - 0.07 0.07 - 0.15 0.15 - 3 3 - 30	QP [dB(μA)] 88 88-58 58-22 22	Pass
(ČSN) EN 55015 Art. 4.4.2	f [MHz] 30 - 230 230 - 300	QP [dB(μV/m)] 30 d=10m 37	Pass
(ČSN) EN 6100-3-2 Art. 7.3	0 - 2 kHz	Class C	Pass
(ČSN) EN 6100-3-3	50 Hz	---	Not applicable *2)

Notes:

The results of the tests specified in the protocol relating to device with electronic ballast:
130232.5L111.1X1: ELT LCM 42 / 350 ... 1050 - E

*1) The luminaire does not contains relevant terminals.

*2) According to EN 61000-3-3, Art. A2 (LED luminaires with power input $\leq 200W$)

Test result: Pass

Compiled by: Nádherný

Measured at: EZÚ



*Measurement of interference voltages introduced into the mains
According to: (ČSN) EN 55015 - art. 4.3.1*

Product: Fixed general purpose luminaires, recessed luminaires

Type: URBINI LED, class I

Operating conditions:

230V, 50Hz, minimally 15 minutes in operation

Temperature: 23°C

Rel. humidity: 30 – 45 %

Applied limits:

Band	Limits dB(μV), quasi-peak/average
9kHz - 50kHz	110 /--
50kHz - 150kHz	90 - 80 /--
150kHz - 0,5MHz	66 - 56 / 56 - 46
0,5MHz - 5,0MHz	56 / 46
5,0MHz - 30MHz	60 / 50

Measuring arrangement:

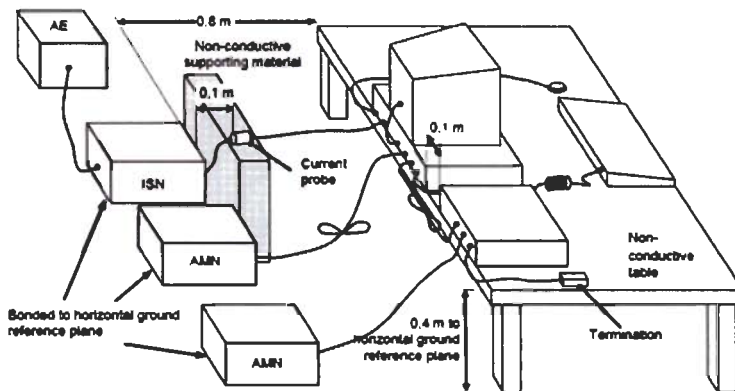

Notes:

For measured values see next page.

Test result: Pass

Measured by: Nádherný

Date: 27.7. 2017

Measured at: EZÚ



EMI Measurement

Common Information

EUT Name: Fixed general purpose luminaires, recessed luminaires
 Type: URBINI LED, class I (130232.5L111.1X1)
 Test Description: EN 55015
 Operation Conditions: 230 V, 50 Hz
 Operator Name: Nadherny
 Comment 1: L, N - Mains

Voltage EN 55015 tab2a

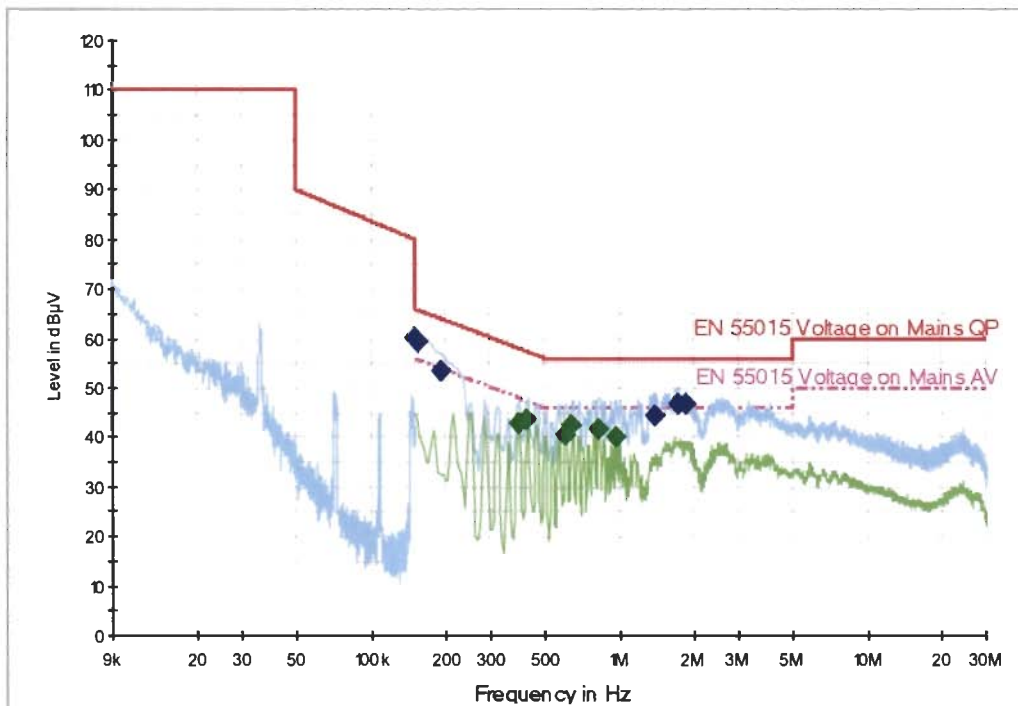

Final Result 1

Frequency (MHz)	QuasiPeak (dBµV)	Meas. Time (ms)	Bandwidth (kHz)	PE	Line	Corr. (dB)	Margin (dB)	Limit (dBµV)
0.150000	60.3	1000.0	9.000	GN	N	10.2	5.7	66.0
0.154000	59.5	1000.0	9.000	GN	N	10.2	6.3	65.8
0.190000	53.5	1000.0	9.000	GN	N	10.2	10.5	64.0
1.394000	44.4	1000.0	9.000	GN	L1	10.5	11.6	56.0
1.706000	46.7	1000.0	9.000	GN	N	10.6	9.3	56.0
1.850000	46.9	1000.0	9.000	GN	N	10.6	9.1	56.0

Final Result 2

Frequency (MHz)	Average (dBµV)	Meas. Time (ms)	Bandwidth (kHz)	PE	Line	Corr. (dB)	Margin (dB)	Limit (dBµV)
0.390000	42.7	1000.0	9.000	GN	L1	10.4	5.4	48.1
0.426000	43.8	1000.0	9.000	GN	L1	10.4	3.5	47.3
0.602000	40.6	1000.0	9.000	GN	L1	10.4	5.4	46.0
0.642000	42.3	1000.0	9.000	GN	N	10.4	3.7	46.0
0.822000	41.5	1000.0	9.000	GN	N	10.4	4.5	46.0
0.958000	40.1	1000.0	9.000	GN	N	10.4	5.9	46.0



**Measurement of interfering radiation in the 9 kHz - 30 MHz band
According to: (ČSN) EN 55015 - art 4.4.1**

Product: Fixed general purpose luminaires, recessed luminaires

Type: URBINI LED, class I

Operating conditions:

230V, 50Hz, minimally 15 minutes in operation

Temperature: 23°C Rel. humidity: 30 – 45 %

Applied limits:

Band	Limits dB(μA), quasi-peak
9 - 70 kHz	88
70 - 150 kHz	88 - 58
150 kHz - 3 MHz	58 - 22
3 - 30 MHz	22

Measuring arrangement:

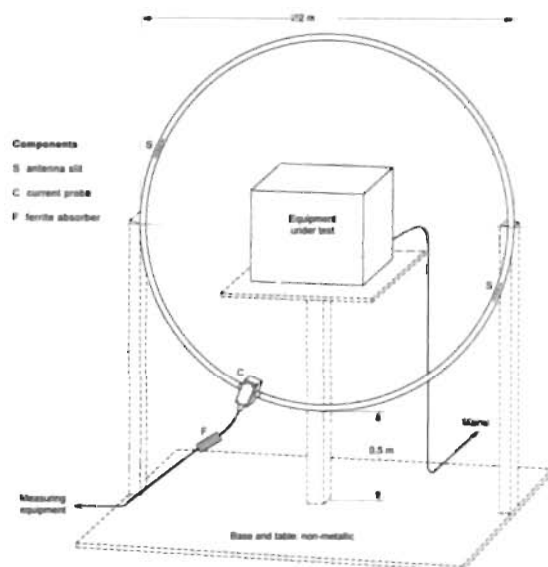

Notes:

For measured values see next pages

Test result: Pass

Measured by: Nádherný

Date: 31.7. 2017

Measured at: EZÚ



EMI Measurement

Common Information

EUT Name:	Fixed general purpose luminaires, recessed luminaires
Type	URBINI LED, class I (130232.5L111.1X1)
Test Description	EN 55015
Operating Conditions	230V, 50Hz
Operator Name:	Nadherry
Comment:	Axis X

EFS with Scans EZU KRUH2M2

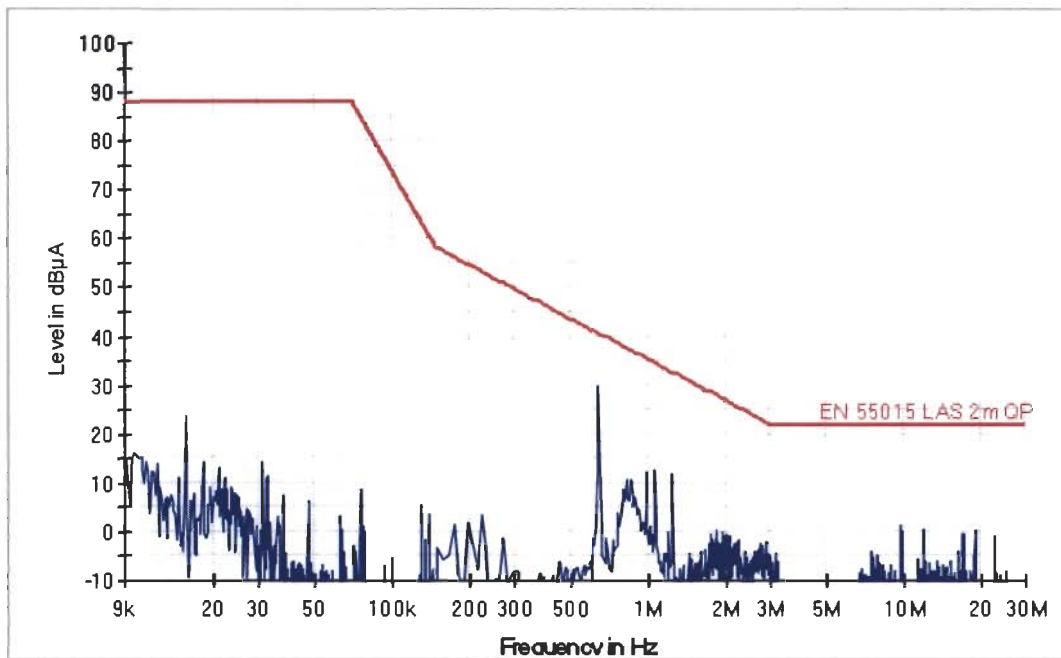



EMI Measurement

Common Information

EUT Name: Fixed general purpose luminaires, recessed luminaires
Type: URBINI LED, class I (130232.5L111.1X1)
Test Description: EN 55015
Operating Conditions: 230V, 50Hz
Operator Name: Nadherny
Comment: Axis Y

EFS with Scans EZU KRUH2M2

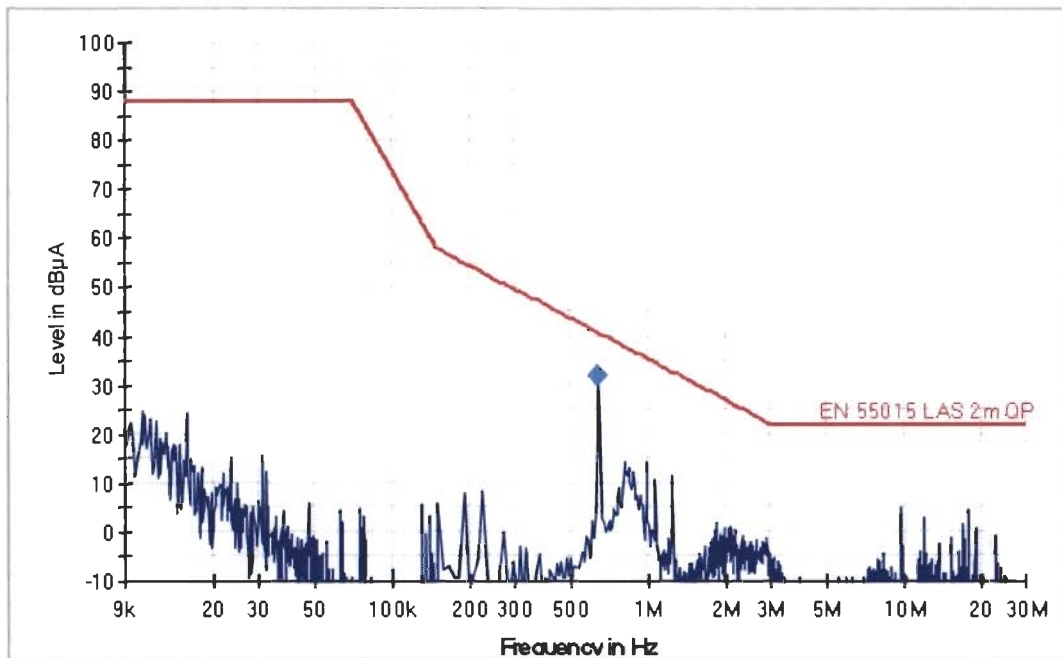

Final Result 1

Frequency (MHz)	QuasiPeak (dBµA)	Meas. Time (ms)	Bandwidth (kHz)	Corr. (dB)	Margin (dB)	Limit (dBµA)
0.638000	31.7	1000.00	9.000	1.0	8.9	40.6



EMI Measurement

Common Information

EUT Name: Fixed general purpose luminaires, recessed luminaires
Type: URBINI LED, class I (130232.5L111.1X1)
Test Description: EN 55015
Operating Conditions: 230V, 50Hz
Operator Name: Nadherny
Comment: Axis Z

EFS with Scans EZU KRUH2M2

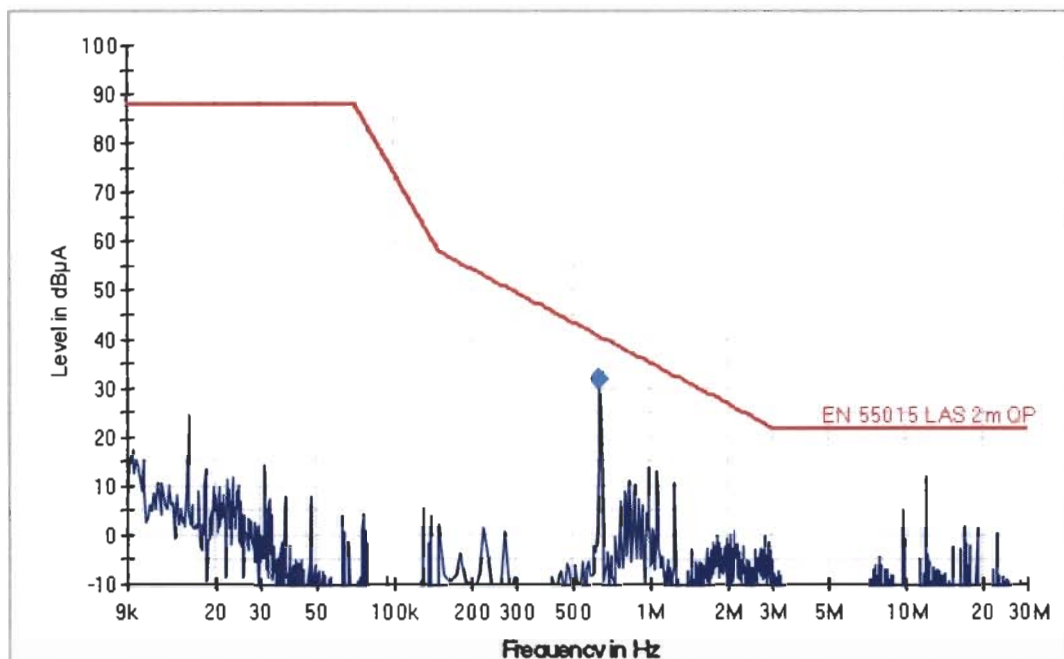

Final Result 1

Frequency (MHz)	QuasiPeak (dBµA)	Meas. Time (ms)	Bandwidth (kHz)	Corr. (dB)	Margin (dB)	Limit (dBµA)
0.638000	31.7	1000.00	9.000	1.0	8.9	40.6



**Measurement of interfering radiation in the 30 - 300 MHz band
According to: (ČSN) EN 55015 Art. 4.4.2**

Product: Fixed general purpose luminaires, recessed luminaires

Type: URBINI LED, class I

Operating conditions:

230V, 50Hz, minimally 15 minutes in operation

Temperature: 22°C Rel. humidity: 30 – 45 %

Applied limits:

Band (MHz)	Limits dB(μV/m), quasi-peak	
30 - 300	*)	30 (d=10m)
230 - 300	*)	37 (d=10m)

Measuring arrangement:

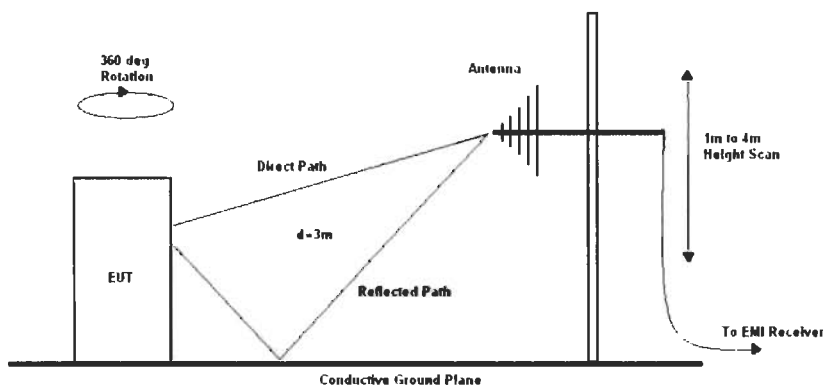

Notes:

For measured values see next pages

*) Limits and values converted to 3 m measuring distance

Test result: Pass

Measured by: Nádherný

Date: 28.7. 2017

Measured at: EZÚ



EMI Measurement

Common Information

EUT Name: Fixed general purpose luminaires, recessed luminaires
Type: URBINI LED, class I (130232.5L111.1X1)
Test Description: EN 55015
Operating Conditions: 230V, 50Hz
Operator Name: Nadherny
Comment: V, H polarization

EFS EZU Luminaire

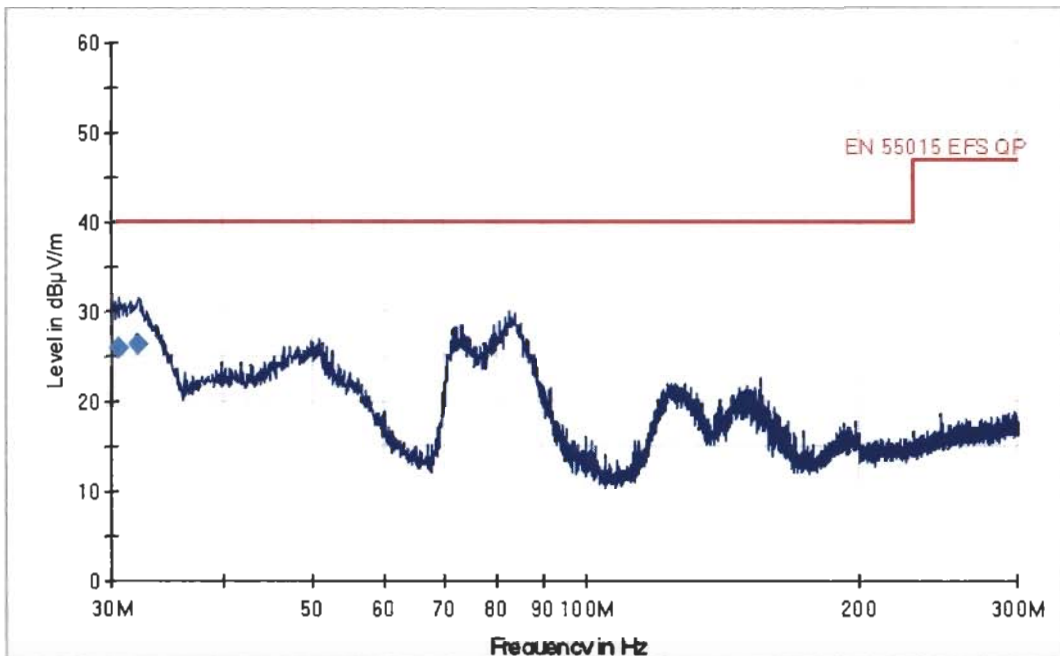

Final Result 1

Frequency (MHz)	QuasiPeak (dBµV/m)	Antenna height (cm)	Polarity	Turntable position (deg)	Corr. (dB)	Margin (dB)	Limit (dBµV/m)
30.600000	25.8	337.0	V	188.0	30.0	14.2	40.0
32.160000	26.2	115.0	V	114.0	30.4	13.8	40.0



**Electromagnetic compatibility (EMC) - Limits -
Limits for harmonic current emission
According to: (ČSN) EN 61000-3-2 - art. 7.3**

Product: Fixed general purpose luminaires, recessed luminaires

Type: URBINI LED, class I

Operating conditions:

230V, 50Hz, minimally 15 minutes in operation

Teplota - Temperature: 24°C

Rel. vlhkost - Rel. humidity: 30 – 45 %

Measuring arrangement:

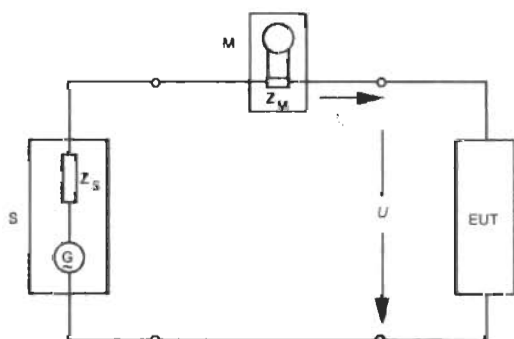

- S napájecí zdroj - source
- EUT zkoušené zařízení - tested equipment
- M analyzátor harmonických - harmonic analyser
- Z_M měřicí bočník - measuring shunt
- Z_S vnitřní impedance napájecího zdroje - internal impedance of source
- I_n n-té harmonické proudy ve fázovém/středním vodiči - nth harmonic component of current in the phase/neutral line

Applied limits:

Order of harmonics	Limit (%I1) P > 25W
2	2
3	30.λ
5	10
7	7
9	5
n 11 - 39 (only odd)	3

λ = účinník - power factor

Notes:

Equipment class C

For measured values see next pages

Test result: Pass

Measured by: Nádherný

Date: 28.7. 2017

Measured at: EZÚ



Report title:	701588-01/02
Company Name:	EZU
Date of test:	15:52 28.Jul 2017
Measurement file name:	Harmonics_3_2_Ed4.rsd
Tester:	Nadherny
Standard used:	EN/IEC 61000-3-2 Ed.4 Quasi-stationary Equipment class C
Observation time:	30s
Windows width:	10 periods - (EN/IEC 61000-4-7 Edition 2002 + A1:2008)
Customer:	LUG
E. U. T.:	URBINI LED, class I (130232.5L111.1X1)
Temperature :	24
Humidity :	40
Comment:	230 V, 50 Hz, 38W
Measurement smoothed data:	Fund. Current: 0.169A Power Factor: 0.948

Test Result	
E. U. T.:	PASS
Power Source:	PASS

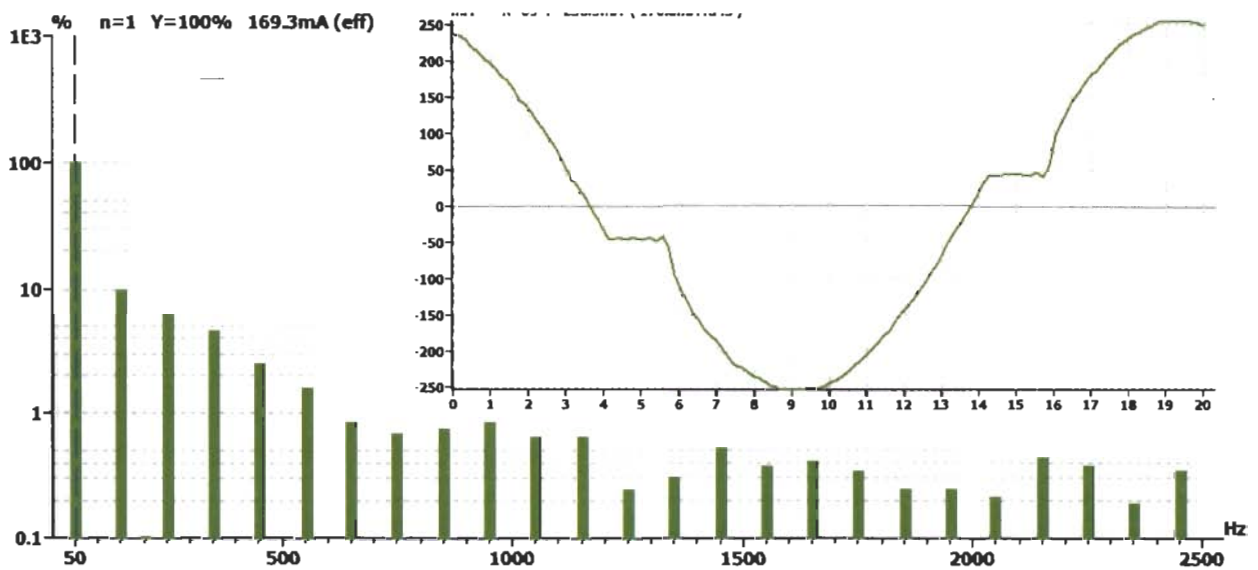



E. U. T. Result

Check harmonics 2..40 [exception odd 21..39]:

Harmonic(s) > 150%:

Order (n): None

Harmonic(s) with average > 100%:

Order (n): None

Check odd harmonics 21..39:

All Partial Odd Harmonics below partial limits.

Harmonic(s) > 150%:

Order (n): None

Harmonic(s) with average > 150%:

Order (n): None

Power Source Result

First dataset out of limit:

DS (time): None

Harmonic(s) out of limit:

Order (n): None

**Average harmonic current results**

Hn	I _{eff} [A]	I _{eff} [%]	Limit [%]	Result
1	169.303E-3	99.960		
2	339.355E-6	0.200		PASS
3	16.521E-3	9.754	28.45	PASS
4	420.270E-6	0.248		PASS
5	10.508E-3	6.204	10.00	PASS
6	541.243E-6	0.320		PASS
7	7.601E-3	4.488	7.00	PASS
8	429.171E-6	0.253		PASS
9	4.524E-3	2.671		PASS
10	310.508E-6	0.183		PASS
11	2.588E-3	1.528		PASS
12	283.192E-6	0.167		PASS
13	1.591E-3	0.939		PASS
14	309.386E-6	0.183		PASS
15	1.264E-3	0.746		PASS
16	363.008E-6	0.214		PASS
17	1.467E-3	0.866		PASS
18	304.477E-6	0.180		PASS
19	1.496E-3	0.884		PASS
20	294.158E-6	0.174		PASS
21	1.216E-3	0.718		PASS
22	327.701E-6	0.193		PASS
23	995.151E-6	0.588		PASS
24	312.142E-6	0.184		PASS
25	559.805E-6	0.331		PASS
26	299.131E-6	0.177		PASS
27	600.090E-6	0.354		PASS
28	295.850E-6	0.175		PASS
29	831.721E-6	0.491		PASS
30	278.860E-6	0.165		PASS
31	830.709E-6	0.490		PASS
32	348.079E-6	0.206		PASS
33	830.055E-6	0.490		PASS
34	280.221E-6	0.165		PASS
35	625.285E-6	0.369		PASS
36	281.892E-6	0.166		PASS
37	588.608E-6	0.348		PASS
38	360.058E-6	0.213		PASS
39	480.404E-6	0.284		PASS
40	340.761E-6	0.201		PASS

Harmonic currents less than 0.6% of the input current measured under the test conditions, or less than 5 mA, whichever is greater, are disregarded.

**Maximum harmonic current results**

Hn	I _{eff} [A]	I _{eff} [%]	Limit [%]	Result
1	169.371E-3	100.000		
2	386.269E-6	0.228		PASS
3	16.645E-3	9.828	42.67	PASS
4	494.412E-6	0.292		PASS
5	10.635E-3	6.279	15.00	PASS
6	610.004E-6	0.360		PASS
7	7.704E-3	4.548	10.50	PASS
8	470.280E-6	0.278		PASS
9	4.699E-3	2.774		PASS
10	350.128E-6	0.207		PASS
11	2.705E-3	1.597		PASS
12	317.727E-6	0.188		PASS
13	1.720E-3	1.016		PASS
14	349.905E-6	0.207		PASS
15	1.358E-3	0.802		PASS
16	414.600E-6	0.245		PASS
17	1.628E-3	0.961		PASS
18	333.133E-6	0.197		PASS
19	1.563E-3	0.923		PASS
20	325.734E-6	0.192		PASS
21	1.383E-3	0.817		PASS
22	368.640E-6	0.218		PASS
23	1.112E-3	0.656		PASS
24	345.614E-6	0.204		PASS
25	690.098E-6	0.407		PASS
26	330.815E-6	0.195		PASS
27	629.178E-6	0.371		PASS
28	318.527E-6	0.188		PASS
29	920.187E-6	0.543		PASS
30	299.504E-6	0.177		PASS
31	1.040E-3	0.614		PASS
32	413.468E-6	0.244		PASS
33	1.000E-3	0.591		PASS
34	304.299E-6	0.180		PASS
35	668.211E-6	0.395		PASS
36	305.878E-6	0.181		PASS
37	688.436E-6	0.406		PASS
38	410.076E-6	0.242		PASS
39	517.514E-6	0.306		PASS
40	402.388E-6	0.238		PASS

Harmonic currents less than 0.6% of the input current measured under the test conditions, or less than 5 mA, whichever is greater, are disregarded.

**Maximum harmonic voltage results**

Hn	Ueff [V]	Ueff [%]	Limit [%]	Result
1	229.85	99.933		
2	88.00E-3	0.038	0.2	PASS
3	541.86E-3	0.236	0.9	PASS
4	53.87E-3	0.023	0.2	PASS
5	59.36E-3	0.026	0.4	PASS
6	46.65E-3	0.020	0.2	PASS
7	51.09E-3	0.022	0.3	PASS
8	35.91E-3	0.016	0.2	PASS
9	29.02E-3	0.013	0.2	PASS
10	23.98E-3	0.010	0.2	PASS
11	22.52E-3	0.010	0.1	PASS
12	17.87E-3	0.008	0.1	PASS
13	23.40E-3	0.010	0.1	PASS
14	20.17E-3	0.009	0.1	PASS
15	10.96E-3	0.005	0.1	PASS
16	14.52E-3	0.006	0.1	PASS
17	14.83E-3	0.006	0.1	PASS
18	13.67E-3	0.006	0.1	PASS
19	10.62E-3	0.005	0.1	PASS
20	19.72E-3	0.009	0.1	PASS
21	11.23E-3	0.005	0.1	PASS
22	12.87E-3	0.006	0.1	PASS
23	8.61E-3	0.004	0.1	PASS
24	10.19E-3	0.004	0.1	PASS
25	13.05E-3	0.006	0.1	PASS
26	10.86E-3	0.005	0.1	PASS
27	9.23E-3	0.004	0.1	PASS
28	10.68E-3	0.005	0.1	PASS
29	10.02E-3	0.004	0.1	PASS
30	9.55E-3	0.004	0.1	PASS
31	9.84E-3	0.004	0.1	PASS
32	9.82E-3	0.004	0.1	PASS
33	8.29E-3	0.004	0.1	PASS
34	6.36E-3	0.003	0.1	PASS
35	7.75E-3	0.003	0.1	PASS
36	8.83E-3	0.004	0.1	PASS
37	9.09E-3	0.004	0.1	PASS
38	5.98E-3	0.003	0.1	PASS
39	7.80E-3	0.003	0.1	PASS
40	12.43E-3	0.005	0.1	PASS



2. Immunity

(ČSN) EN 61547 *Equipment for general lighting purposes - EMC - immunity requirements*

Product: Fixed general purpose luminaires, recessed luminaires

Type: URBINI LED, class I

Type representative: 130232.5L111.1X1

Requirements at tests:

Generic standard	Level	Allowed error *1)	Note
EN61000-4-2	±4kV / ±8 kV	B	Pass
EN61000-4-3	3V/m 80 - 1000 MHz	A	Pass
EN61000-4-4	±1kV AC power, ±0,5kV signal lines	B	Pass
EN61000-4-5	±1kV / ±2kV	C	Pass
EN61000-4-6	3 V 0,15 - 80 MHz	A	Pass
EN61000-4-8	3 A/m	A	*2) Pass
EN61000-4-11	200 ms / 70%U _T 10 ms / 0% U _T	C B	Pass

Notes:

The results of the tests specified in the protocol relating to device with electronic ballast:
130232.5L111.1X1: ELT LCM 42 / 350 ... 1050 - E

*1) Performance criteria according (ČSN) EN 61547, art. 4.2

*2) Devices do not contain parts sensitive to the magnetic field

Test result: Pass

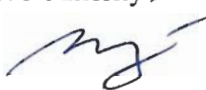
Compiled by: Nádherný 

Measured at: EZÚ



*Test of electric discharge resistance
According to: (ČSN) EN 61000-4-2*

Product: Fixed general purpose luminaires, recessed luminaires

Type: URBINI LED, class I

Operating conditions:

230V, 50Hz, minimally 15 minutes in operation

Temperature: 23°C Rel. humidity: 30 – 45 %

Allowed criterion: B

Number of testing discharges: 10/10 contact/air discharge to every test-places in each polarity, besides indirect contact discharges into a vertical and horizontal coupling plane

Tested points: Contact discharge into the metal parts and to the horizontal and vertical coupling plane. Air discharge into plastic parts. See photodocumentation.

Testing voltage [kV]: ± 4 – contact discharge / ± 8 - air discharge

Achieved criterion: A

Measuring arrangement:

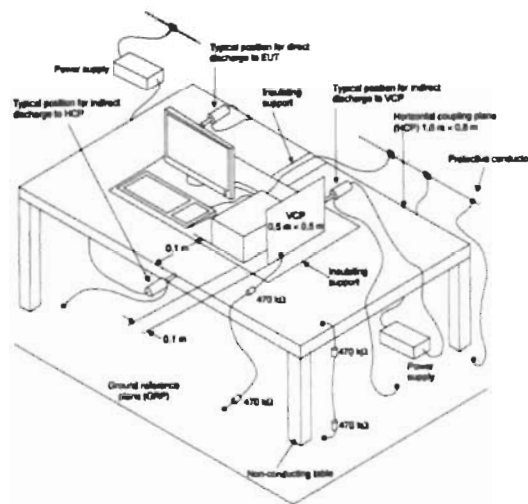

Notes:--

Test result: Pass

Measured by: Nádherný

Date: 31.7. 2017

Measured at: EZÚ



Immunity test - radiated electromagnetic field requirements
According to: (ČSN) EN 61000-4-3

Product: Fixed general purpose luminaires, recessed luminaires

Type: URBINI LED, class I

Operating conditions:

230V, 50Hz, minimally 15 minutes in operation

Temperature: 23°C Rel. humidity: 30 – 45 %

Applied limits:

Scan spectrum: 80 - 1000 MHz

Intensity of field: 3 V/m (80% AM, 1kHz)

Allowed criterion: A

Achieved criterion: A

Measuring arrangement:

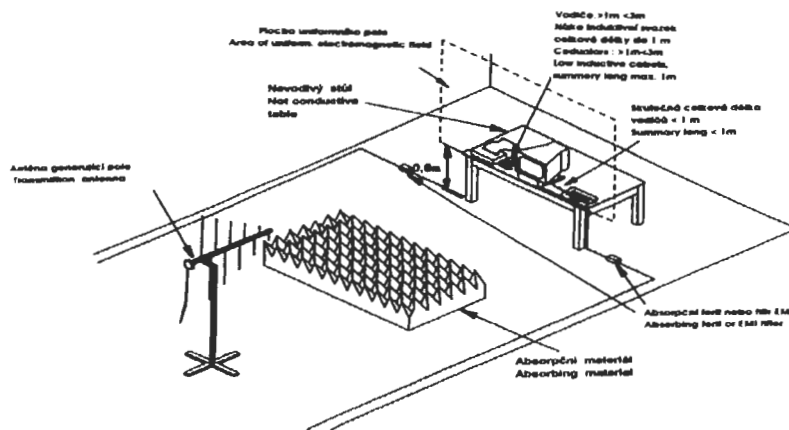

Notes: --

Test result: Pass

Measured by: Nádherný

Date: 31.7. 2017

Measured at: EZÚ

Test by quick transient burst
According to: (ČSN) EN 61000-4-4

Product: Fixed general purpose luminaires, recessed luminaires

Type: URBINI LED, class I

Operating conditions:

230V, 50Hz, minimally 15 minutes in operation

Temperature: 23°C Rel. humidity: 30 – 45 %

Allowed criterion: B

Testing voltage applied:

Applied to	Testing level	Performance criterion	Remark
L,N,L+N	±1kV	A	Coupling networks to power supply
L+PE	±1kV	A	
N+PE	±1kV	A	
L+N+PE	±1kV	A	

Measuring arrangement:

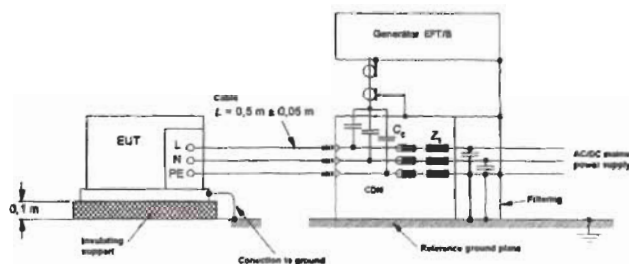

Notes: --

Test result: Pass

Measured by: Nádherný

Date: 31.7. 2017

Measured at: EZÚ



Surge immunity test
According to: (ČSN) EN 61000-4-5

Product: Fixed general purpose luminaires, recessed luminaires

Type: URBINI LED, class I

Operating conditions:

230V, 50Hz, minimally 15 minutes in operation

Temperature: 23°C

Rel. humidity: 30 – 45 %

Allowed criterion: C

Testing voltage applied:

Applied voltage	Testing level	Performance criterion	Remark
L-N	±1kV	A	90°, 270°
L-PE, N-PE, L+N-PE	±2kV	A	90°, 270°

Uspořádání při měření - Measuring arrangement:

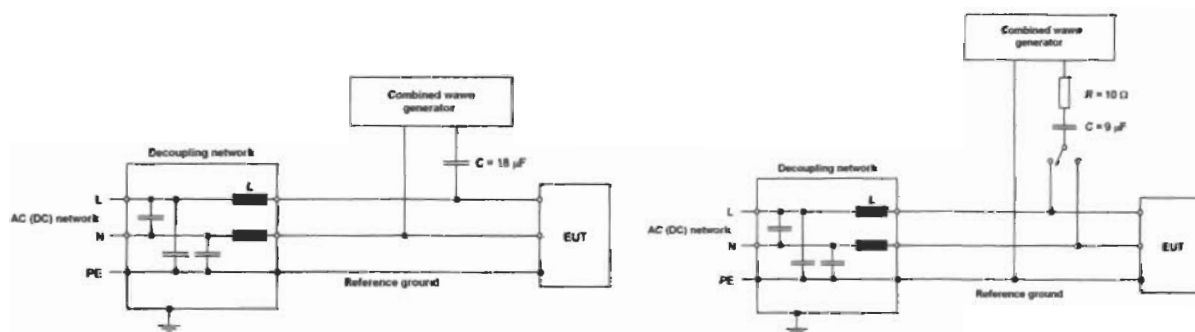

Poznámky - Notes:--

Test result: Pass

Measured by: Nádherný

Date: 31.7. 2017

Measured at: EZÚ



Immunity test - conducted disturbances induced by radio-frequency fields
According to: (ČSN) EN 61000-4-6

Product: Fixed general purpose luminaires, recessed luminaires

Type: URBINI LED, class I

Operating conditions:

230V, 50Hz, minimally 15 minutes in operation

Temperature: 24 °C Rel. humidity: 30 – 45 %

Allowed criterion: A

Testing voltage applied:

Frequency band	Testing voltage level	Note
150kHz - 80MHz	3V (mod. 80% AM / 1 kHz)	Applied by coupling network to mains

Achieved criterion: A

Measuring arrangement:

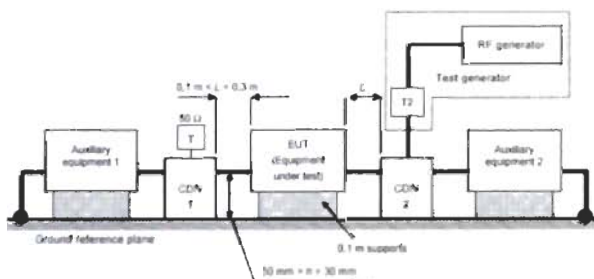

Notes:--

Test result: Pass

Measured by: Nádherný

Date: 31.7. 2017

Measured at: EZÚ



Test Report No.: 701588-01/02

Voltage dips, short interruptions and voltage variations
According to: (ČSN) EN 61000-4-11

Product: Fixed general purpose luminaires, recessed luminaires

Type: URBINI LED, class I

Operating conditions:

230V, 50/60Hz, minimally 15 minutes in operation

Temperature: 22°C Rel. humidity: 30 – 45 %

Allowed criterion: C, B

Tests requirements:

Test level % Ut	Duration 50 / 60Hz ms	Allowed criterion	Achieved criterion
0	10 / 8,3	B	A
70	200 / 167	C	A

Notes:--

Test result: Pass

Measured by: Nádherný

Date: 31.7. 2017

Measured at: EZÚ

**Measuring equipment used:**

<input checked="" type="checkbox"/>	Test receiver RaS	ESCI	110213	11.2017
<input checked="" type="checkbox"/>	Měřicí přijímač- Test receiver RaS	ESIB26	110097	11.2017
<input checked="" type="checkbox"/>	Continuos wave simulátor EM Test	CWS500N1	110232	03.2019
<input checked="" type="checkbox"/>	Harmonic analyzer EM TEST	DPA503N	110272	02.2019
<input checked="" type="checkbox"/>	Power fail simulator EM Test	PFS 500	98-6040	10.2017
<input type="checkbox"/>	Ultra Compact Simulator EM Test	UCS 500N	110235	02.2019
<input checked="" type="checkbox"/>	ESD generator	ESD30N	110196	03.2019
<input type="checkbox"/>	ESD generátor	ESD30	110090	12.2018
<input type="checkbox"/>	Artificial mains EMCO	3825/2	95-5852	07.2019
<input type="checkbox"/>	Artificial mains Narda	PMM L3-32	110250	11.2019
<input checked="" type="checkbox"/>	Artificial mains ESH	ESH4-Z5	5821/1	05.2020
<input checked="" type="checkbox"/>	Antenna Frankonia	BTA-M	00-6321	10.2017
<input type="checkbox"/>	Antenna Double Ridget	HF 907	110177	08.2017
<input type="checkbox"/>	Antenna Double Ridget Advantest	TR17206	5878	10.2017
<input checked="" type="checkbox"/>	Burst generátor Haefely	PEFT Junior	5872	12.2018
<input checked="" type="checkbox"/>	Surge generator	VCS500-M	110114	03.2018
<input type="checkbox"/>	Měřič pole Narda – Field meter Narda	ELT-400	110130	11.2018
<input checked="" type="checkbox"/>	Current Probe R&S	EZ-17	110098	05.2019

Pomocná zařízení – Auxiliary equipment:

<input checked="" type="checkbox"/>	Supply source EM TEST	HFS300	98-6042	02.2019
<input type="checkbox"/>	Ref. impedance SCHAFFNER	LR4	X71773	02.2019
<input checked="" type="checkbox"/>	Electric Field Probe Narda	EP603	110273	01.2019
<input checked="" type="checkbox"/>	Amplifier PRÁNA	AP32 LT225	07-110145	
<input type="checkbox"/>	Amplifier MILMEGA	AS0822-100	98-6038	
<input type="checkbox"/>	Amplifier MILMEGA	AS0204-125	110144	
<input type="checkbox"/>	Amplifier MILMEGA (1.8-6GHz)	AS1860-100	110219	
<input checked="" type="checkbox"/>	Signal generator RaS	SMF100A	110167	11.2018
<input type="checkbox"/>	Signal generator RaS	SMT03	96-5874	02.2018
<input type="checkbox"/>	Multimetr - Multimeter	FLUKE189	550049	01.2018
<input type="checkbox"/>	Probe RFT	TK12	700044	06.2020
<input checked="" type="checkbox"/>	Coupling/dec. EM TEST	CDN M3N	552097	06.2018
<input checked="" type="checkbox"/>	Coupling/dec. EM TEST	CDN M2N	110233/2	11.2019
<input type="checkbox"/>	Coupling/SCHAFFNER ISN T4xx	ISN T4xx	110032	
<input type="checkbox"/>	Capacitive coupling clamp	Haefely		
<input type="checkbox"/>	Current probe	P MP-120		
<input type="checkbox"/>	Current probe	AM503	79-4221	
<input checked="" type="checkbox"/>	Current probe RFT	SMZ 11	700459	06.2018
<input checked="" type="checkbox"/>	Elektromag. kleště- Electromag. injection clamp	EM-101	110233	11.2019
<input type="checkbox"/>	Ferite clamp 1-1000 MHz	EZ-24	10003	
<input checked="" type="checkbox"/>	Anechoic chamber - Euroshield Oy	RFMSD-F/A	6341	02.2020
<input checked="" type="checkbox"/>	Notebook Dell	Dell D351	551492	
<input checked="" type="checkbox"/>	Multimeter Fluke	289	552550	06.2018
<input checked="" type="checkbox"/>	Ocelové pásmo – Metal meter	5m	N400014	12.2020
<input checked="" type="checkbox"/>	Pulse Limiter RaS	ESH3-Z2	5424	01.2019

Kabely - Cables:

- K1
- K22 , ESH3-Z2
- K14 , K15a , K16
- KB01, KB02, KB04
- KB06
- K4 , K19
- K23
- K27
- K25, K2, K4

EZU přípravky – EZU equipments:

- PR 51 – EN 61000-4-2 – Vertical coupling plane
- Dummy lamp: dle - according to EN55015
- Regulating transformer - ZPA RA20
- PR-21 - Stabilized power supply BS 525
- P10 - EN55015 - Spherical cover
- P11 - EN6100-4-8 - EZÚ test setup
- P13 – Třífázový přepínač - three-phase switch
- PR45 - Loop antenna 2m



Photo-documentation

Product: Fixed general purpose luminaires, recessed luminaires

Type: URBINI LED, class I



Overview: 130232.5L111.1X1



Source and LED controller: 130232.5L111.1X1



Name plate 130232.5L111.1X1



Electrostatic discharges – tested points ( contact discharge  air discharge)

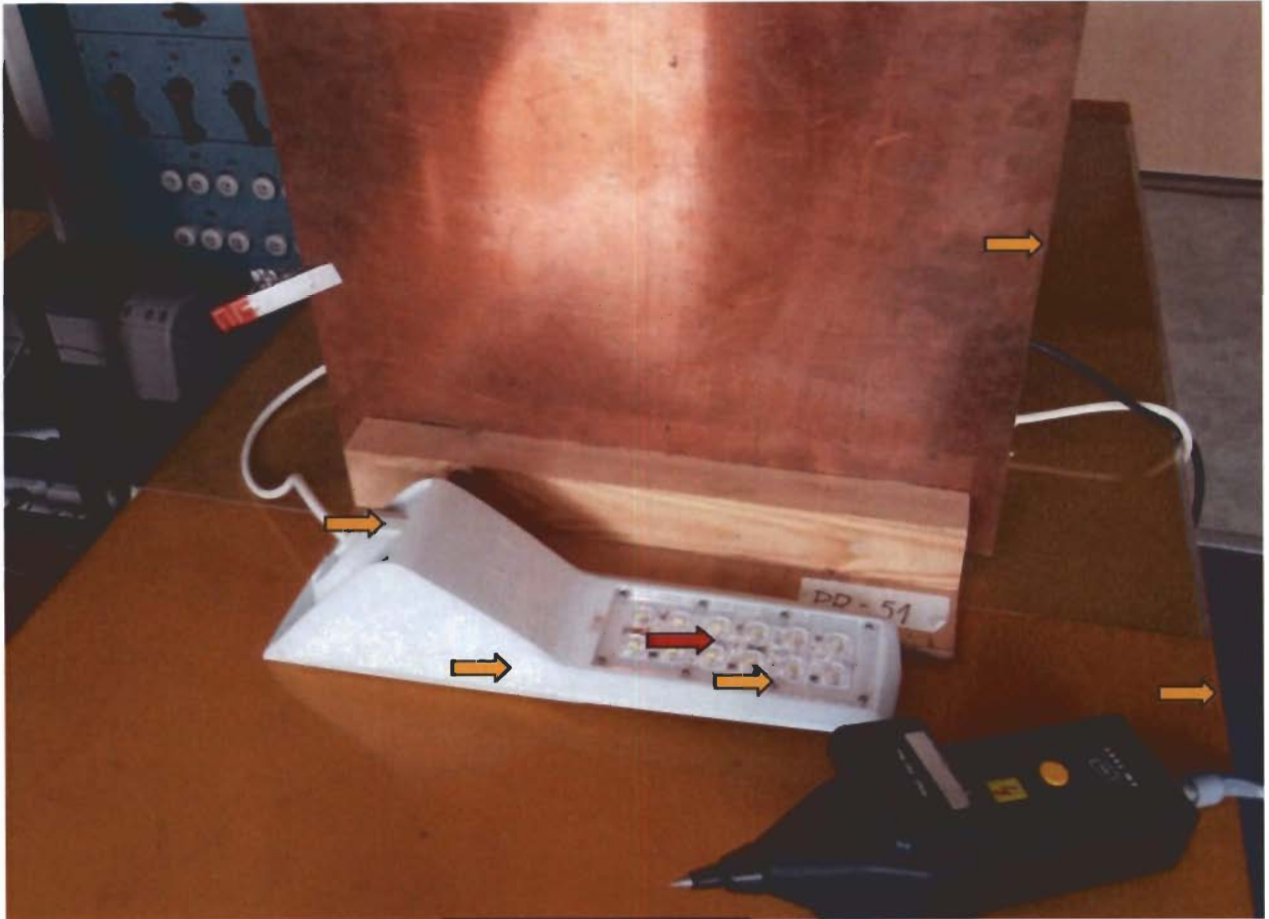

Ny