



Accesories for Operating Tables

FENIX OT-01

VIVAX OT-02

ACCESORIES FOR OPERATING TABLES

This catalogue presents the wide range of accessories available for INFIMED operating table.

They were created basing on long experience in designing of medical equipment, hours spent on consultation with medical staff and functional and ergonomy testing.

The accessories haven been sorted according to practical use and surgical disciplines.

Table of contents:

GENERAL BASIC ACCESORIES	3
GYNAECOLOGY UROLOGY PROCTOLOGY ACCESORIES	12
NEUROSURGERY LARYNGOLOGY OPHTHALMOLOGY ACCESORIES	14
ORTHOPAEDICS TRAUMATOLOGY ACCESORIES	17
ANGIOGRAPHY ACCESORIES	22
POSITIONING PADS	24

General surgery positions



SUPINE POSITION



BEACH CHAIR POSITION

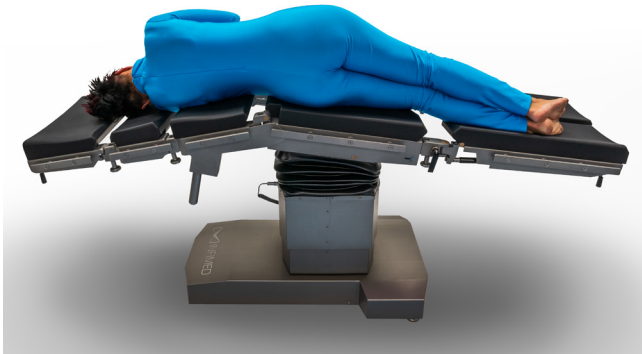

LATERAL POSITION AND FLEX

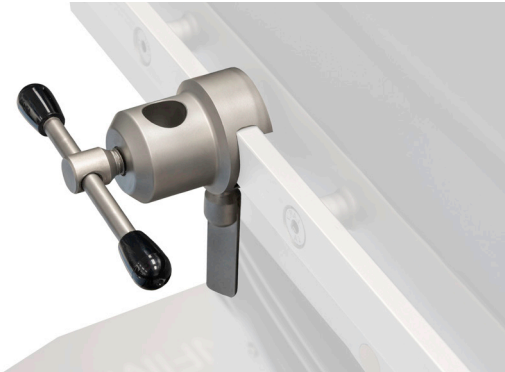

EB-01 One position clamp

TECHNICAL INFORMATION:

For fixation of the various accesories with rods of 16 mm diameter to the side rail

Made of stainless steel, with a matt finish

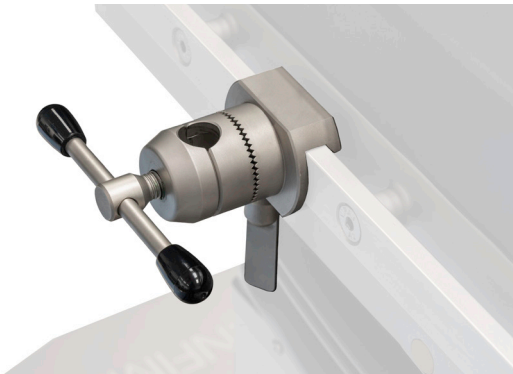

EB-02 Multi position clamp

TECHNICAL INFORMATION:

For fixation of the various accesories with rods of 16 mm diameter to the side rail

Allows radial adjustment of the accesories

Made of stainless steel, with a matt finish



EB-04 Angle arm support

TECHNICAL INFORMATION:

Height adjustment: 300mm

Distance from table top adjustment: 200mm

Tilting adjustment by ball joint

Made of stainless steel with matt finish and polyurethane foam, with two fixing velcro straps

To be fixed with EB-02 clamp



EB-05 Arm support

TECHNICAL INFORMATION:

Height adjustment: 100mm

Made of stainless steel with matt finish and polyurethane foam, with two fixing velcro straps

To be fixed with EB-01 clamp



EB-06 Thigh holder

TECHNICAL INFORMATION:

Height adjustment: 300mm

Made of stainless steel with matt finish and polyurethane foam

To be fixed with EB-01 clamp



EB-07 Side-shoulder support (side support position)

TECHNICAL INFORMATION:

Height adjustment: 230mm

Distance from table top adjustment: 150mm

Made of stainless steel with matt finish and polyurethane foam

To be fixed with EB-01 clamp



EB-07 Side-shoulder support (shoulder support position)

TECHNICAL INFORMATION:

Height adjustment: 230mm

Distance from table top adjustment: 150mm

Made of stainless steel with matt finish and polyurethane foam

To be fixed with EB-01 clamp

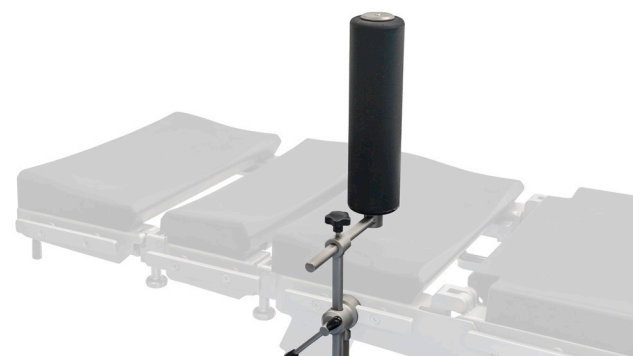

EB-08 Side support

TECHNICAL INFORMATION:

Height adjustment: 150mm

Distance from table top adjustment: 150mm

Made of stainless steel with matt finish and polyurethane foam

To be fixed with EB-01 clamp

**EB-09 Anesthetic frame**

TECHNICAL INFORMATION:

Height adjustment: 600mm

Made of stainless steel with matt finish

To be fixed with EB-01 clamp

**EB-10 Anesthetic frame with adjustable width**

TECHNICAL INFORMATION:

Height adjustment: 500mm

Both side width adjustment 200mm
Made of stainless steel with matt finish

To be fixed with EB-01 clamp

**EB-11 Infusion holder**

TECHNICAL INFORMATION:

Height adjustment: 200mm

Made of stainless steel with matt finish

To be fixed with EB-01 clamp

**EB-12 Hand (shank holder)**

TECHNICAL INFORMATION:

Height adjustment: 300mm

Made of stainless steel with matt finish and polyurethane foam

To be fixed with EB-01 clamp

General Basic Accesories

EB-13 Support for meniscus operation

TECHNICAL INFORMATION:

Height adjustment: 600mm

Made of stainless steel with matt finish and polyurethane foam

To be fixed with EB-02 clamp

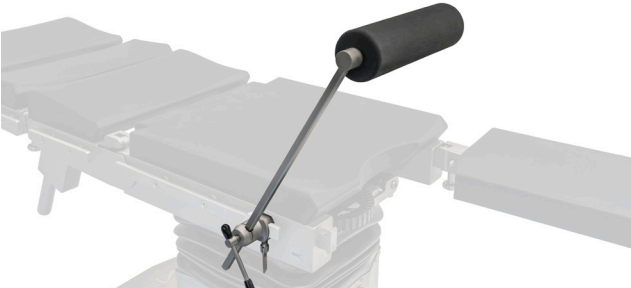

EB-14 Arm support, with horizontal movement

TECHNICAL INFORMATION:

Height adjustment: 300mm

Distance from tabletop adjustment: 200mm

Tilting adjustment by ball joint

Made of stainless steel with matt finish, HPL, foam mattress covered with antistatic artificial leather, fixing velcro straps
To be used with EB-01 clamp



ES-01 Leg strap ES-02 Thigh strap

TECHNICAL INFORMATION:

Adjustment by velcro: 400mm

Strap width: 100mm

Made of stainless steel with matt finish and polyamide strap

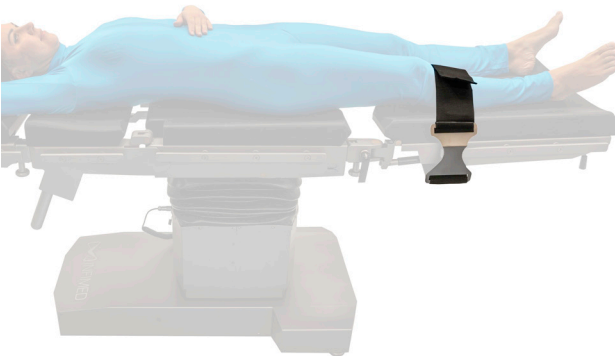

ES-03 Abdominal strap

TECHNICAL INFORMATION:

Adjustment by velcro: 400mm

Strap width: 100mm

Made of stainless steel with matt finish and polyamide strap





ES-04 Hand strap

TECHNICAL INFORMATION:

Adjustment by velcro: 400mm

Strap width: 100mm

Made of stainless steel with matt finish and polyamide strap



ES-07 Holder for additional equipment, mobile

TECHNICAL INFORMATION:

Non-marking wheels with brakes

Hooks and rails for assembly of accessories on rack

Basket in basis

Made of stainless steel with matt finish



ES-08 Holder for arm operations

TECHNICAL INFORMATION:

Fixed to side rails of operating table

Vertical adjustment of angle against tabletop
Distance from tabletop adjustment: 100mm

Height adjustable feet

X-Ray permeable tabletop, dimensions 800x400mm

Made of stainless steel with matt finish, foam mattress covered with antistatic artificial leather



ES-09 Holder for tubes

TECHNICAL INFORMATION:

Height adjustment: 200mm

Distance from tabletop adjustment: 200mm

Made of stainless steel with matt finish and HPL

To be fixed with EB-01 clamp

General Basic Accesories



ES-10 Tray for additional accessories

TECHNICAL INFORMATION:

Height adjustment: 400mm

Tray dimensions: 450x250mm

Made of stainless steel with matt finish

To be used with EB-01 clamp

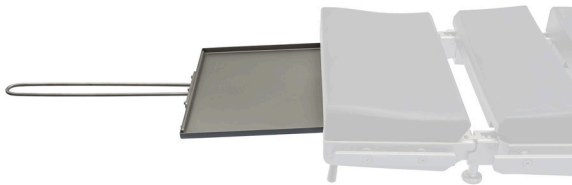

ES-11 X-ray tray

TECHNICAL INFORMATION:

Height adjustment: 400mm

To be used with X-Ray cassette of width381mm

Installation from head or side

Made of stainless steel with matt finish



ES-12 Chest support

TECHNICAL INFORMATION:

Height adjustment: 150mm

Distance from tabletop adjustment: 150mm

Made of stainless steel with matt finish and polyurethane foam

To be fixed with EB-01 clamp



ES-13 Attachement for knee operation

TECHNICAL INFORMATION:

Height adjustment: 200 mm

Knee holder adjustment

Made of stainless steel with matt finish and polyurethane foam

To be fixed with EB-01 clamp



ES-14 Pubic support

TECHNICAL INFORMATION:

Height adjustment: 150 mm

Distance from tabletop adjustment: 150 mm

Made of stainless steel with matt finish and polyurethane foam

To be fixed with EB-01 clamp

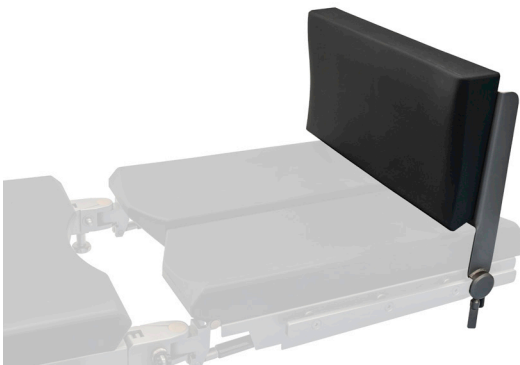

ES-15 Leg support, not-divided

TECHNICAL INFORMATION:

To be fixed to siderails

Made of stainless steel with matt finish and foam mattress covered with antistatic artificial leather



ES-17 Side rail extension

TECHNICAL INFORMATION:

Extension for side rail for mounting side rail accessories

Made of stainless steel with matt finish

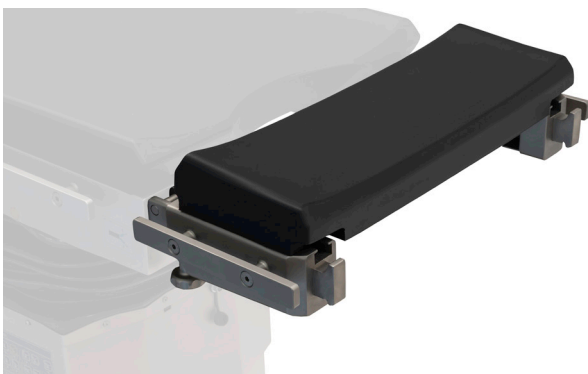

ES-18 Tabletop extension

TECHNICAL INFORMATION:

To be fixed to siderails

Made of stainless steel with matt finish, HPL and polyurethane foam

General Basic Accesories

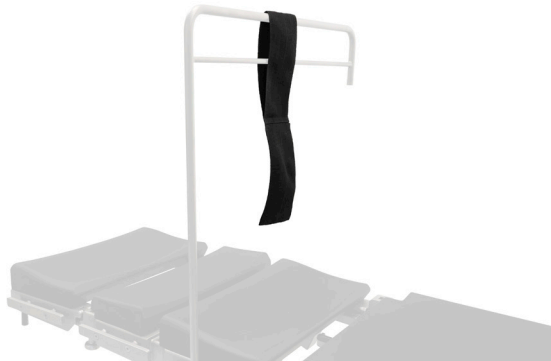

ES-19 Strap for anesthetic frame

TECHNICAL INFORMATION:

To be fixed to anesthetic frame EB-09 or EB-10

Made of polyimide strap

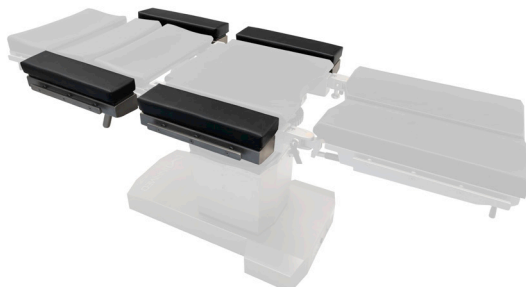

ES-20 Side extension for bariatric table-top

TECHNICAL INFORMATION:

To be fixed to siderails

Made of stainless steel with matt finish, HPL and polyurethane foam with artificial leather

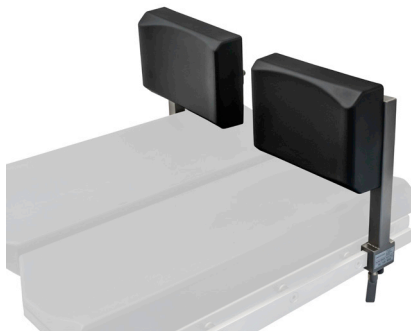

ES-21 Leg support, divided

TECHNICAL INFORMATION:

To be fixed to siderails

Made of stainless steel with matt finish and polyurethane foam



GYNEACOLOGICAL SURGERY



PROCTOLOGICAL (KNEEL) SURGERY

Gynaecology Urology Proctology Accesories



EB-03 Knee support

TECHNICAL INFORMATION:

Height adjustment: 100mm

Made of stainless steel with matt finish and polyurethane foam

To be fixed with EB-02 clamp



ES-05 Gyneacological bowl

TECHNICAL INFORMATION:

Fixed instead of the leg supports

Adjustable horizontal position and rotation

Bowl capacity: 4 litres

Made of stainless steel with matt finish



ES-06 Urological bowl

TECHNICAL INFORMATION:

Fixed instead of the leg supports

Adjustable horizontal position and rotation

Bowl capacity:4 litres, with rubber outflow

Made of stainless steel with matt finish



ES-16 Proctological attachment

TECHNICAL INFORMATION:

Height adjustment: 200mm

Kneeling chair, without clamp, fixed to side rails

Abdominal support to be used with 2 pcs of EB-02 clamps

Made of stainless steel with matt finish, HPL and polyurethane foam



NEUROSURGICAL SURGERY - SUPINE POSITION (WITH DORO NEUROSURGICAL ATTACHEMENT)



NEUROSURGICAL SURGERY - SITTING POSITION (WITH DORO NEUROSURGICAL ATTACHEMENT)

Neurosurgery Laryngology Ophthalmology Accesories



EA-01 Adapter for specialistic head rest

TECHNICAL INFORMATION:

Neccesary to fix to the operating table to use DORO neurosurgical attachement or any of specialistic head rest

Made of stainless steel with matt finish



EN-01 Specialistic head rest with adjustable track

TECHNICAL INFORMATION:

Fixed to the adapter EA-01

Height adjustment 150mm, angle adjustment to the table top

Adjustment of the distance from the tabletop: 250mm

Made of stainless steel with matt finish and polyurethane foam



EN-02 Specialistic head rest, horseshoe

TECHNICAL INFORMATION:

Fixed to the adapter EA-01

Height adjustment 150mm, angle adjustment to the table top

Adjustment of the distance from the tabletop: 250mm

Made of stainless steel with matt finish and polyurethane foam



EN-05 Arm support

TECHNICAL INFORMATION:

Height adjustment: 300mm

Distance from tabletop adjustment: 200mm

Tilting adjustment by ball joint

Made of stainless steel with matt finish, HPL, foam mattress covered with antistatic artificial leather, fixing velcro straps
To be used with EB-01 clamp



DORO neurosurgical attachment for laying position

TECHNICAL INFORMATION:

To be fixed to adapter EA-01

Including:

- Adjustable Base Unit 3001-00
- Swivel Adaptor 3002-00
- QR3 Skull Clamp 1001.001
- Reusable Skull Pins Pediatric 3004-00 (3 pcs)
- Reusable Skull Pins Adult 3005-00 (3 pcs)



DORO neurosurgical attachment for sitting position

TECHNICAL INFORMATION:

To be fixed to side rails using EB-02 multiposition clamps

Including:

- Adjustable Base Unit 3001-00
- Swivel Adaptor 3002-00
- QR3 Skull Clamp 1001.001
- Reusable Skull Pins Pediatric 3004-00 (3 pcs)
- Reusable Skull Pins Adult 3005-00 (3 pcs)
- Crossbar Adaptor

Orthopaedics Traumatology Positions

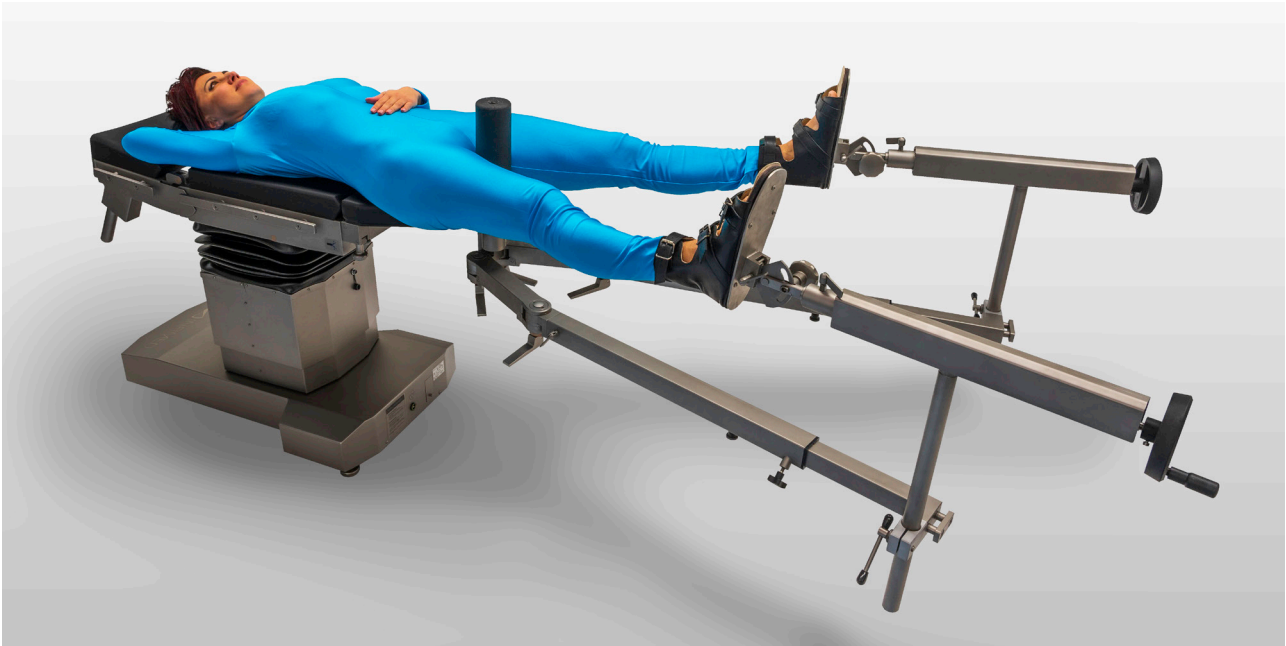

ORTHOPAEDIC SURGERY - SUPINE POSITION (ORTHOPAEDIC ATTACHEMENT EO-01)



**ORTHOPAEDIC SURGERY - SUPINE POSITION
(ORTHOPAEDIC ATTACHEMENT EO-01 WITH SUPPORTS EO-10 AND BAR SUPPORT EO-02)**



**ORTHOPAEDIC SURGERY - LATERAL DECUBITUS POSITION
(ORTHOPAEDIC ATTACHEMNT EO-01 WITH SUPPORTS EO-10 AND HIP SUPPORT EO-09)**

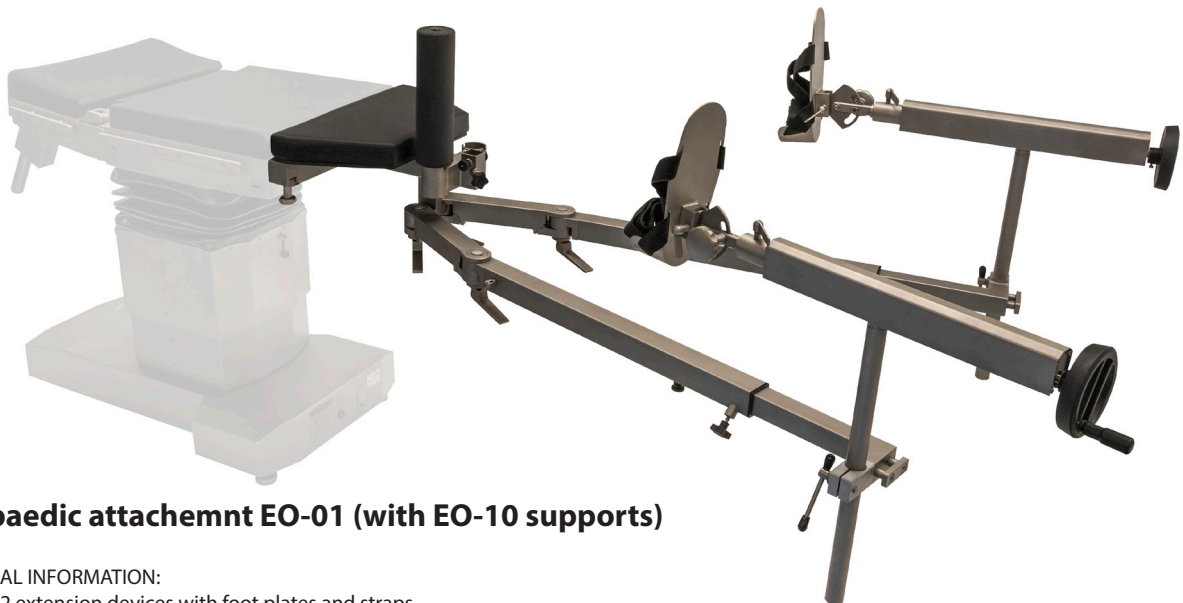

Ortopaedic attachemnt EO-01 (with EO-10 supports)

TECHNICAL INFORMATION:

- Includes 2 extension devices with foot plates and straps
- Additional accessories (EO-02...EO-11) are to be ordered seperately
- Fixed to leg rests sockets
- Adjustment of extensions devices height: 350mm
- Distance between support roll and extensions devices: 300-1300mm
- Adjustment of rotation arms position: 0-180
- Adjstment of length of ortropaedic attachemnts arms: 600mm
- Support roll X-Ray permeable
- Made of stainless steel with matt finish, foam mattress covered with artificial leather, polyurethane

Orthopaedics Traumatology Accessories



EO-02 Bar support

TECHNICAL INFORMATION:

To be fixed to the arms of the orthopedic attachment EO-01 with EO-07 clamp

Height adjustment 400mm

Made of stainless steel with matt finish and leather strap



EO-03 Leg support

TECHNICAL INFORMATION:

To be fixed to the arms of the orthopedic attachment EO-01 with EO-07 clamp

Height adjustment 400mm

Made of stainless steel with matt finish and leather strap / polyurethane foam



EO-04 Support for plastering

TECHNICAL INFORMATION:

To be fixed to the socket of the orthopedic attachment EO-01

Made of stainless steel with matt finish and leather strap / polyurethane foam

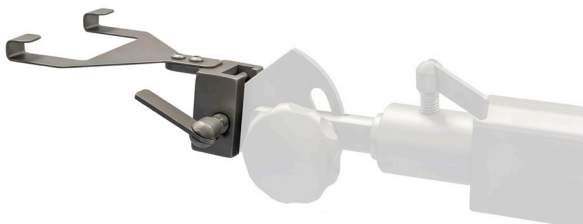

EO-05 Heel holder

TECHNICAL INFORMATION:

To be fixed to orthopedic attachment EO-01 instead of plate supports

Made of stainless steel with matt finish



EO-06 foot support

TECHNICAL INFORMATION:

To be fixed to the orthopaedic attachment EO-01 instead of plate supports

Made of stainless steel with matt finish and leather straps



EO-07 Clamp for orthopaedic attachment supports

TECHNICAL INFORMATION:

Used to fix the following accessories: EO-02, EO-03, EO-08, EO-11, to the orthopaedic attachment EO-01

Made of stainless steel with matt finish



EO-08 Knee operation attachment for orthopaedic attachment

TECHNICAL INFORMATION:

Without extension device

To be fixed to the arms of the orthopaedic attachment EO-01 with EO-07 clamp Height adjustment: 200mm

Adjustment of distance between support roll and extension device: 800mm

Angle adjustment against tabletop

Made of stainless steel with matt finish and polyurethane foam



EO-09 Hip support for lateral decubitus position

TECHNICAL INFORMATION:

To be fixed to the socket of the orthopaedic attachment EO-01

Adjustment left/right

Adjustment of support roll rotation

Made of stainless steel with matt finish and polyurethane foam

Orthopaedics Traumatology Accessories



EO-10 Support for orthopedic attachment arms

TECHNICAL INFORMATION:

To be fixed to the arms of the orthopaedic attachment EO-01

Height adjustment: 400 mm

Made of stainless steel with matt finish



EO-11 Knee support for side positions

TECHNICAL INFORMATION:

To be fixed to the arms of the orthopaedic attachment EO-01 with EO-07 clamp

Made of stainless steel with matt finish and polyurethane foam



EO-12 Trolley for installation of orthopaedic attachment

TECHNICAL INFORMATION:

Used to transport and assembly the orthopaedic attachment EO-01 to the operating table

Non-marking castors with individual brakes

Basket for accesories in the base

Made of stainless steel with matt finish



EO-13 Mobile stand for additional equipment of orthopaedic attachment

TECHNICAL INFORMATION:

Non-marking castors with individual brakes

Hooks and rails for storage of orthopaedic accessories

Basket in the basi

Made of stainless steel with matt finish and HPL



EO-14 Leather shoes for orthopedic attachment

TECHNICAL INFORMATION:

To be fixed to the orthopedic attachment EO-01 instead of plate supports

Made of stainless steel with matt finish and leather



EO-20 Attachment for hand operating

TECHNICAL INFORMATION:

To be fixed with 2 pcs of clamp EB-01

Height adjustment: 200mm

Adjustment of extension device length: 350mm

Adjustment of tilt and rotation of hand fixing

Made of stainless steel with matt finish and polyurethane foam



EO-30 Attachement for shoulder operations head rest EN-02

TECHNICAL INFORMATION:

To be fixed to legrests sockets

Includes EN-02 head rest

Removable right and left shoulder sections

Made of stainless steel with matt finish, polyurethane foam and HPL

Angiography table



VIEW FROM THE SIDE, WITH MAX LONGITUDINAL SLIDE



VIEW FROM THE BACKSIDE, WITH MAX LATERAL SLIDE



ER-01.0

TECHNICAL INFORMATION:

To be fixed on carbo fibre tabletop

Allows to fix heavier additional accesories on the side rails

Made of stainless steel with matt finish.



ER-01.1

TECHNICAL INFORMATION:

To be fixed on carbo fibre tabletop

Allows to fix lighter additional accesories on the side rails

Made of stainless steel with matt finish.



ER-02.0

TECHNICAL INFORMATION:

To be fixed on carbo fibre tabletop

Allows to fix heavier additional accesories on the side rails

X-ray permeable

Made of carbon fibre and stainless steel with matt finish.



ER-02.1

TECHNICAL INFORMATION:

To be fixed on carbo fibre tabletop

llows to fix lighter additional accesories on the side rails

X-ray permeable

Made of carbon fibre and stainless steel with matt finish.

Positioning pads

EM-01 Mattress for spine surgeries

TECHNICAL INFORMATION:

For positioning the patient, especially during surgical procedures on the spine

Made of polyurethane foam with artificial letter



EM-02 Mattress for sitting position

TECHNICAL INFORMATION:

For positioning the patient, especially during procedures requiring sitting position

Made of polyurethane foam with artificial letter



Gel patient body positioners

TECHNICAL INFORMATION:

Thick layered gel patient body positioners for patient on operation table: arm, chest, heel, head positioners and table pads

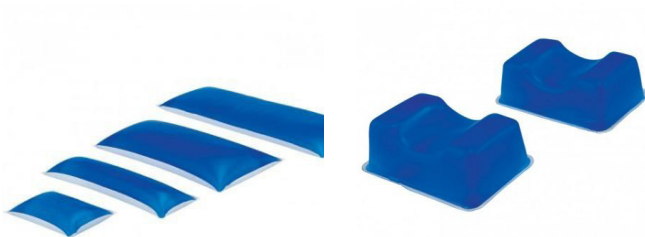



**European
Funds**
Smart Growth



Polska

European Union
European Regional
Development Fund



For special requirement of the customer it is possible to produce the product with changed technical parameters which do not diminish its safety.

The details given in this catalogue are correct at the time of going to press. Infimed Sp. z o.o., however, reserves the right to improve shown equipment.

adres INFIMED Sp. z o.o.
ul. Kabaty 1,
34-300 Żywiec,
Polska
tel/fax +48 33 861 40 96
email office@infimed.pl
www www.infimed.pl

NIP 553-251-29-67
REGON 243274947
KRS 0000463933

Sąd Rejonowy w Bielsku-Białej, VIII Wydział
Gospodarczy Krajowego Rejestru Sądowego.
Wysokość Kapitału Zakładowego: 500 000 PLN

bank Bank Spółdzielczy
w Węgierskiej Górcie
SWIFT POLUPLPR

78 8131 0005 0016 2492 2000 0010 PLN
PL02 8131 0005 0016 2492 2000 0020 EUR
PL23 8131 0005 0016 2492 2000 0030 USD



www.infimed.pl