

BC-5150 Auto Hematology Analyzer

Operator's Manual





© 2013 Shenzhen Mindray Bio-Medical Electronics Co., Ltd. All rights Reserved.
For this Operator's Manual, the issue date is 2013-09.

Intellectual Property Statement

SHENZHEN MINDRAY BIO-MEDICAL ELECTRONICS CO., LTD. (hereinafter called Mindray) owns the intellectual property rights to this Mindray product and this manual. This manual may refer to information protected by copyright or patents and does not convey any license under the patent rights or copyright of Mindray, or of others.

Mindray intends to maintain the contents of this manual as confidential information. Disclosure of the information in this manual in any manner whatsoever without the written permission of Mindray is strictly forbidden.

Release, amendment, reproduction, distribution, rental, adaptation, translation or any other derivative work of this manual in any manner whatsoever without the written permission of Mindray is strictly forbidden.

 ,  , **MINDRAY** are the trademarks, registered or otherwise, of Mindray in China and other countries. All other trademarks that appear in this manual are used only for informational or editorial purposes. They are the property of their respective owners.

Responsibility on the Manufacturer Party

Contents of this manual are subject to change without prior notice.

All information contained in this manual is believed to be correct. Mindray shall not be liable for errors contained herein or for incidental or consequential damages in connection with the furnishing, performance, or use of this manual.

Mindray is responsible for the effects on safety, reliability and performance of this product, only if:

- all installation operations, expansions, changes, modifications and repairs of this product are conducted by Mindray authorized personnel;
- the electrical installation of the relevant room complies with the applicable national and local requirements; and the product is used in accordance with the instructions for use.

⚠ WARNING

- It is important for the hospital or organization that employs this equipment to carry out a reasonable service/maintenance plan. Neglect of this may result in machine breakdown or personal injury.
- Be sure to operate the analyzer under the situation specified in this manual; otherwise, the analyzer will not work normally and the analysis results will be unreliable, which would damage the analyzer components and cause personal injury.

NOTE

- This equipment must be operated by skilled/trained clinical professionals.
-

Warranty

THIS WARRANTY IS EXCLUSIVE AND IS IN LIEU OF ALL OTHER WARRANTIES, EXPRESSED OR IMPLIED, INCLUDING WARRANTIES OF MERCHANTABILITY OR FITNESS FOR ANY PARTICULAR PURPOSE.

Exemptions

Mindray's obligation or liability under this warranty does not include any transportation or other charges or liability for direct, indirect or consequential damages or delay resulting from the improper use or application of the product or the use of parts or accessories not approved by Mindray or repairs by people other than Mindray authorized personnel.

This warranty shall not extend to:

- Malfunction or damage caused by improper use or man-made failure.
- Malfunction or damage caused by unstable or out-of-range power input.
- Malfunction or damage caused by force majeure such as fire and earthquake.
- Malfunction or damage caused by improper operation or repair by unqualified or unauthorized service people.
- Malfunction of the instrument or part whose serial number is not legible enough.
- Others not caused by instrument or part itself.

Company Contact

Manufacturer:	Shenzhen Mindray Bio-Medical Electronics Co., Ltd.
Address:	Mindray Building, Keji 12th Road South, High-tech industrial park, Nanshan, Shenzhen 518057, P.R. China
Website:	www.mindray.com
E-mail Address:	service@mindray.com
Tel:	+86 755 81888998
Fax:	+86 755 26582680

EC-Representative: Shanghai International Holding Corp. GmbH(Europe)

Address: Eiffestraße 80, 20537 Hamburg, Germany

Tel: 0049-40-2513175

Fax: 0049-40-255726

Table of Contents

1	Using This Manual	1-1
1.1	Introduction	1-1
1.2	Who Should Read This Manual	1-2
1.3	How to Find Information.....	1-3
1.4	Conventions Used in This Manual	1-4
1.5	Safety Information	1-5
1.6	When you see... ..	1-7
2	Understanding the Analyzer.....	2-1
2.1.	Introduction	2-1
2.2.	Parameters	2-2
2.3.	Product Description.....	2-4
2.4.	Status Indicator.....	2-9
2.5.	Buzzer	2-10
2.6.	System Menu.....	2-11
2.7.	Reagents, Controls and Calibrators	2-12
3	Understanding the System Principles.....	3-1
3.1	Introduction	3-1
3.2	Aspiration.....	3-2
3.3	Dilution	3-3
3.4	WBC Measurement	3-5
3.5	HGB Measurement.....	3-6
3.6	RBC/PLT Measurement	3-7
4	Installing Your Analyzer	4-1
4.1.	Introduction	4-1
4.2.	Installation Requirements.....	4-2
4.2.1.	Space Requirements	4-2
4.2.2.	Power Requirements	4-2
4.2.3.	General Environment	4-3
4.2.4.	Moving and Installing the Analyzer	4-3
4.3.	Connecting the Analyzer System	4-4
4.4.	Notes	4-8
5	Operating Your Analyzer.....	5-1
5.1.	Introduction	5-1
5.2.	Initial Checks	5-3
5.3.	Startup and Logon	5-4
5.4.	Daily Quality Control.....	5-7

Table of Contents

5.5.	Sample Collection and Handling.....	5-8
5.6.	Auto-Standby	5-21
5.7.	Shutdown.....	5-23
6	Reviewing Sample Results	6-1
6.1.	Introduction	6-1
6.2.	Browsing in the "Table Review" mode	6-2
7	Using the QC Programs.....	7-1
7.1.	Introduction	7-1
7.2.	L-J QC.....	7-3
7.2.1.	Editing L-J settings (for administrators only)	7-3
7.2.2	L-J QC Run	7-6
7.2.3	Reviewing L-J Results	7-9
7.3.	X-B QC Program.....	7-14
7.3.1	Introduction.....	7-14
7.3.2	Editing X-B settings (for administrators only).....	7-14
7.3.3	X-B QC Run.....	7-18
7.3.4	Reviewing X-B Results.....	7-19
8	Calibrating Your Analyzer.....	8-1
8.1.	Introduction	8-1
8.2.	When to Calibrate	8-3
8.3.	How to Calibrate	8-4
8.3.1	Preparing Your Analyzer	8-4
8.3.2	Manual Calibration.....	8-5
8.3.3	Calibration with Calibrator.....	8-6
8.3.4	Calibration with Fresh Blood	8-11
9	Customizing the Analyzer Software.....	9-1
9.1.	Introduction	9-1
9.2.	Setting Up the Analyzer	9-2
9.2.1	System Setup	9-2
9.2.2	Access Setup.....	9-10
9.2.3	Auxiliary Setup.....	9-13
9.2.4	Parameter Setup.....	9-15
9.2.5	Maintenance Setup (for administrators only)	9-21
9.2.6	Reagent Setup.....	9-21
9.2.7	Gain Setup (for administrators only).....	9-24
9.3.	Save the settings	9-26
10	Servicing Your Analyzer	10-1
10.1.	Introduction	10-1
10.2.	Maintaining Your Analyzer	10-2

Table of Contents

10.2.1	Maintenance	10-2
10.2.2	Cleaning	10-4
10.2.3	Servicing the Fluidics	10-5
10.3.	Self-Test	10-10
10.3.1	System self-test	10-10
10.3.2	Valve self-test	10-10
10.3.3	Fan self-test	10-11
10.4.	Touch Screen Calibration	10-13
10.5.	Viewing Logs	10-14
10.6.	Checking the Analyzer Status	10-16
10.6.1	Counter	10-16
10.6.2	Temp. & Pressure	10-16
10.6.3	Voltage and Current	10-17
10.6.4	Sensor	10-18
10.6.5	Version Info.	10-19
11	Troubleshooting Your Analyzer.....	11-1
11.1.	Introduction	11-1
11.2.	Error Information and Handling.....	11-2
12	Appendices	12-2
A.	Index	A-2
B.	Specifications	B-1
B.1.	Classification	B-1
B.2.	Reagents.....	B-1
B.3.	Applicable Tubes	B-1
B.4.	Parameters	B-1
B.5.	Sampling Features	B-2
B.5.1.	Sample Volumes Required for Each Analysis	B-2
B.5.2.	Throughput	B-2
B.6.	Performance Specifications	B-2
B.6.1.	Display Range	B-2
B.6.2.	Background/Blank Count.....	B-3
B.6.3.	Linearity Range	B-3
B.6.4.	Deviation of Reading.....	B-3
B.6.5.	Compatibility	B-3
B.6.6.	Reproducibility.....	B-4
B.6.7.	Carryover	B-4
B.7.	Input/Output Device	B-4
B.7.1.	External Computer (optional).....	B-5
B.7.2.	Keyboard (Optional)	B-5
B.7.3.	Mouse (Optional)	B-5

Table of Contents

B.7.4.	External Barcode Scanner (Optional).....	B-5
B.7.5.	Printer (Optional)	B-5
B.8.	Interfaces	B-5
B.9.	Power Supply	B-5
B.10.	FUSE	B-5
B.11.	EMC Description.....	B-6
B.12.	Sound	B-6
B.13.	Operating Environment.....	B-6
B.14.	Storage Environment	B-6
B.15.	Running Environment	B-6
B.16.	Dimensions and Weight.....	B-7
B.17.	Contraindications	B-7
B.18.	Safety Classification.....	B-7

1 Using This Manual

1.1 Introduction

This chapter explains how to use your BC-5150 operator's manual, which is shipped with your BC-5150 AUTO HEMATOLOGY ANALYZER and contains reference information about the analyzer and procedures for operating, troubleshooting and maintaining the analyzer. Read this manual carefully before operating your BC-5150 analyzer and operate your BC-5150 analyzer strictly as instructed in this manual.

1.2 Who Should Read This Manual

This manual is intended to be read by clinical laboratory professionals. This equipment must only be operated by skilled/trained clinical professionals. This information contains information for clinical laboratory professionals to:

- learn about the BC-5150 hardware and software.
- customize system settings.
- perform daily operating tasks.
- perform system maintenance and troubleshooting.

1.3 How to Find Information

This operator's manual comprises 11 chapters and 3 appendices. Refer to the table below to find the information you need.

If you want to ...	See ...
learn about the intended use and parameters of the BC-5150	Chapter 2 Understanding Your Analyzer
learn about the hardware, interface and software of the BC-5150	Chapter 2 Understanding Your Analyzer
learn about how the BC-5150 works	Chapter 3 Understanding the System Principles
learn about the installation requirements of the BC-5150	Chapter 4 Installing Your Analyzer
learn about the process of sample collection and analysis	Chapter 5 Operating Your Analyzer
learn about how to use the BC-5150 to perform your daily operating tasks	Chapter 5 Operating Your Analyzer
review sample results	Chapter 6 Reviewing Sample Results
learn about how to use the quality control programs of the BC-5150	Chapter 7 Using the QC Programs
learn about how to calibrate the BC-5150	Chapter 8 Using the Calibration Programs
learn about how to define/adjust system settings	Chapter 9 Customizing the Analyzer Software
learn about how to maintain/service the BC-5150	Chapter 10 Maintaining Your Analyzer
learn about how to solve the problems of the BC-5150	Chapter 11 Troubleshooting Your Analyzer
learn about the technical specifications of the BC-5150	Appendix B Specifications

1.4 Conventions Used in This Manual





This manual uses certain typographical conventions to clarify meaning in the text:

Format	Indication
[xx]	all capital letters enclosed in [] indicate a key name on the analyzer or external keyboard, such as [ENTER]
"xx"	bold letters included in " " indicate text you may find on the screen of BC-5150, such as "Clean"
xx	bold letters indicate chapter titles, such as Chapter 1 Using This Manual.

All illustrations in this manual are provided as examples only. They may not necessarily reflect setup of the BC-5150 or data displayed.

1.5 Safety Information

The following symbols are used to indicate danger and alert information in this manual.

When you see...	Meaning
	read the statement below the symbol. The statement is alerting you to a potentially biohazardous condition.
 WARNING	read the statement below the symbol. The statement is alerting you to an operating hazard that can cause personnel injury.
 CAUTION	read the statement below the symbol. The statement is alerting you to a possibility of analyzer damage or unreliable analysis results.
 NOTE	read the statement below the symbol. The statement is alerting you to information that requires your attention.



- All the samples, controls, calibrators, reagents, wastes and areas contacted them are potentially biohazardous. Wear proper personal protective equipment (e.g. gloves, lab coat, etc.) and follow safe laboratory procedures when handling them and the contacted areas in the laboratory.
- If leak happens to the analyzer, the leak liquid is potentially biohazardous.



- Please check the firmness of all the doors and covers before running the analyzer.
- Make sure all the safety measurements are adopted. Disable any safety device or sensor is prohibited.
- Please take action to any alarm and problem indication immediately.
- Do not touch the moving parts.
- Contact Mindray or Mindray-authorized distributors in time if any damaged part is found.
- Be careful when opening/closing and removing/installing the doors, covers and boards of the analyzer.
- Discard the analyzer according to government regulations.
- Do not contact the patients' sample blood directly.

- Be sure to dispose of reagents, waste, samples, consumables, etc. according to government regulations.
 - The reagents are irritating to eyes, skin and airway. Wear proper personal protective equipment (e.g. gloves, lab coat, etc.) and follow safe laboratory procedures when handling them and the contacted areas in the laboratory.
 - If reagents accidentally spill on your skin or in your eyes, rinse the area with ample amount of clean water; seek medical attention immediately.
 - Keep your clothes, hairs and hands away from the moving parts to avoid injury.
 - The sample probe tip is sharp and may contain biohazardous materials. Exercise caution to avoid contact with the probe when working around it.
 - Before maintaining or servicing the analyzer, its surface or the sample probe and other parts concerned must be cleaned and sterilized (it is recommend that the parts be wiped with alcohol of which the concentration is 75%) to avoid biohazards or other damages.
-

⚠ CAUTION





- Please use the analyzer strictly according to this manual.
 - Please adopt proper measurements to prevent the reagents from being polluted.
-

NOTE

- Use the reagents specified by the manufacturer only. Store and use the reagents as instructed by instructions for use of the reagents.
 - Check if the reagent tubes are properly connected before using the analyzer.
-

1.6 When you see...





You will find the following symbols in this manual:













When you see...	Meaning
	read the statement below the symbol. The statement is alerting you to a potentially biohazardous condition.
 WARNING	read the statement below the symbol. The statement is alerting you to an operating hazard that can cause personnel injury.
 CAUTION	read the statement below the symbol. The statement is alerting you to a possibility of analyzer damage or unreliable analysis results.
 NOTE	read the statement below the symbol. The statement is alerting you to information that requires your attention.

You may find the following symbols of the analyzer system:

CAUTION

- Make sure the symbols are in good condition during daily use and maintenance.

When you see...	Meaning
	CAUTION, CONSULT ACCOMPANYING DOCUMENTS.
	BIOLOGICAL RISK
	WARNING, LASER BEAM
	PROTECTIVE EARTH (GROUND)
	USB PORT

	<p>NETWORK PORT</p>
	<p>ALTERNATING CURRENT</p>
	<p>FOR IN VITRO DIAGNOSTIC USE</p>
	<p>BATCH CODE</p>
	<p>USE BY</p>
	<p>SERIAL NUMBER</p>
	<p>DATE OF MANUFACTURE</p>
	<p>EXERCISE CAUTION WHEN WORKING AROUND TO AVIOD PRICKING</p>
	<p>MANUFACTURER</p>
	<p>TEMPERATURE LIMITATION</p>
	<p>CONSULT THE OPERATOR'S MANUAL</p>
	<p>THE DEVICE IS FULLY CONFORMANCE WITH THE COUNCIL DIRECTIVE CONCERNING IN VITRO DIAGNOSTIC MEDICAL DEVICES 98/79/EC.</p>

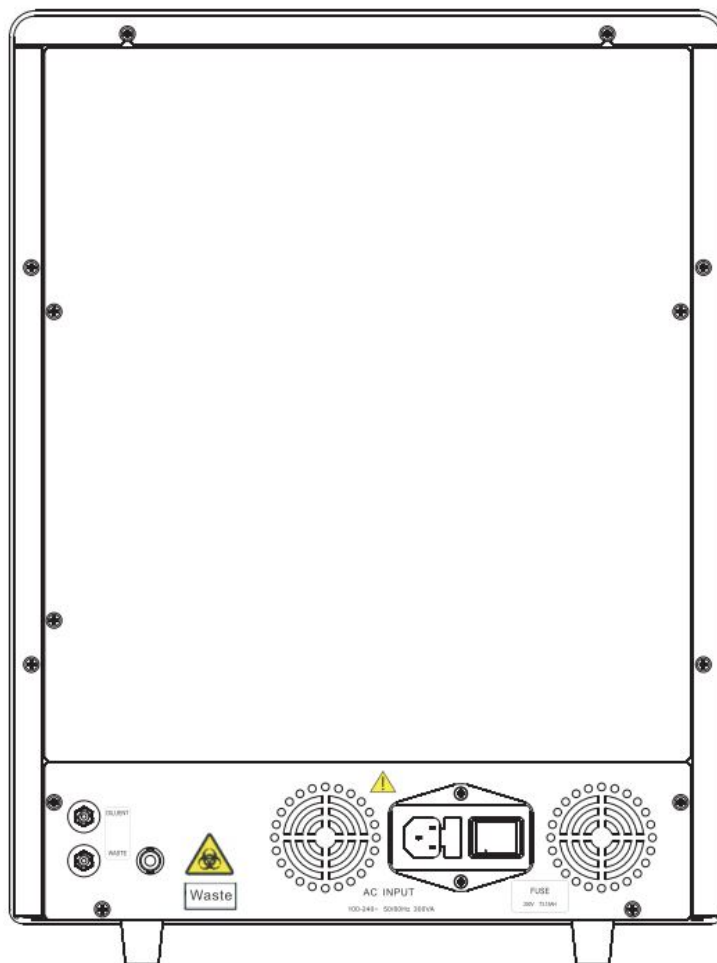
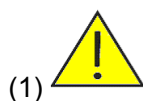

Figure 1-1 Back of the analyzer



Connect only to a properly earth grounded outlet.

To avoid electric shock, disconnect power cord prior to removing or replacing fuse.

Replace fuse only with the type and rating specified.



Warning, potential biological risk.

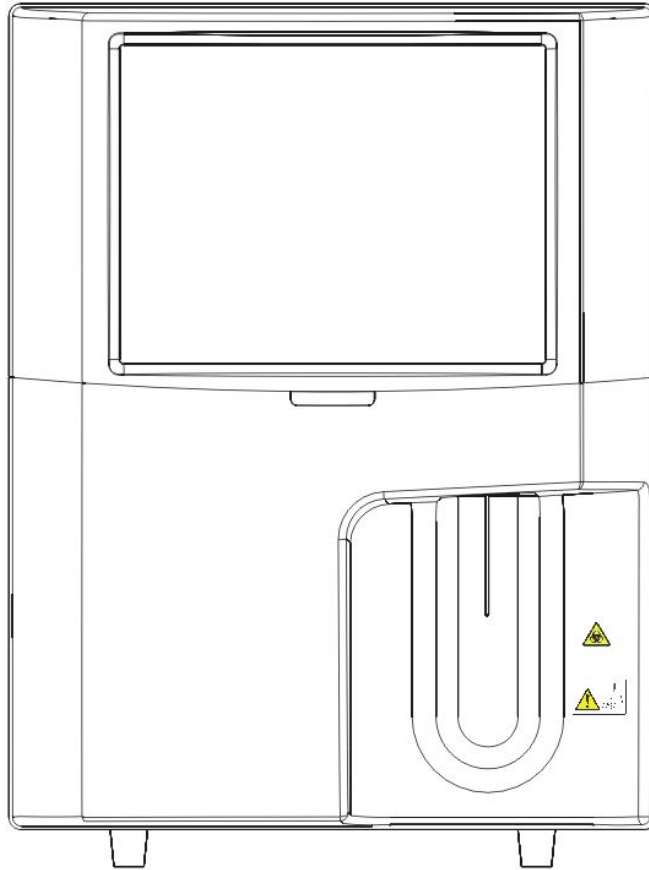

Figure 1-2 Front of the analyzer



- (1)
Warning, potential biohazardous risk.



- (2)
The sample probe is sharp and potentially biohazardous. Exercise caution to avoid contact with the probe when working around it.

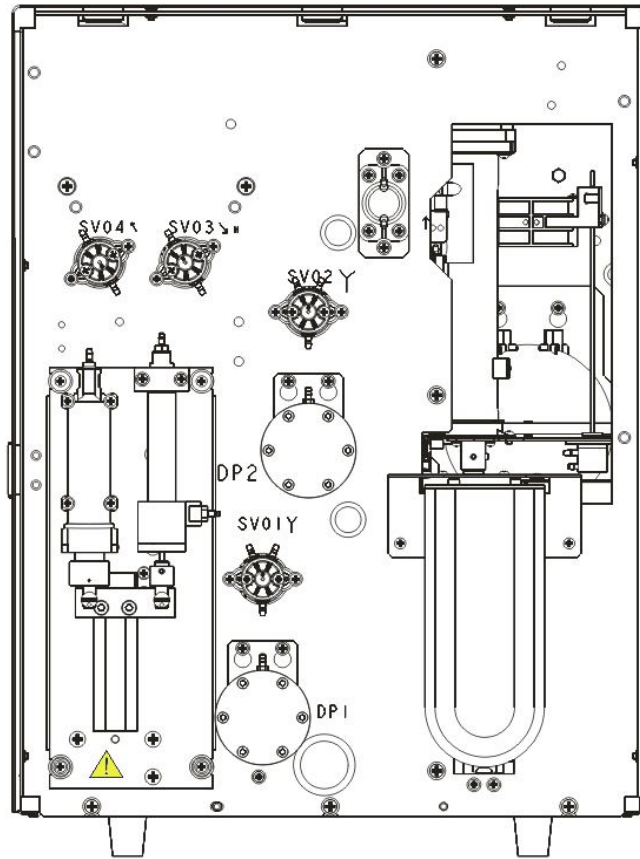
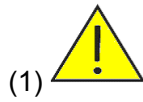

Figure 1-3 Front of the analyzer (front cover open)



Do not put hands under the syringe or in the guide slot when the analyzer is running.

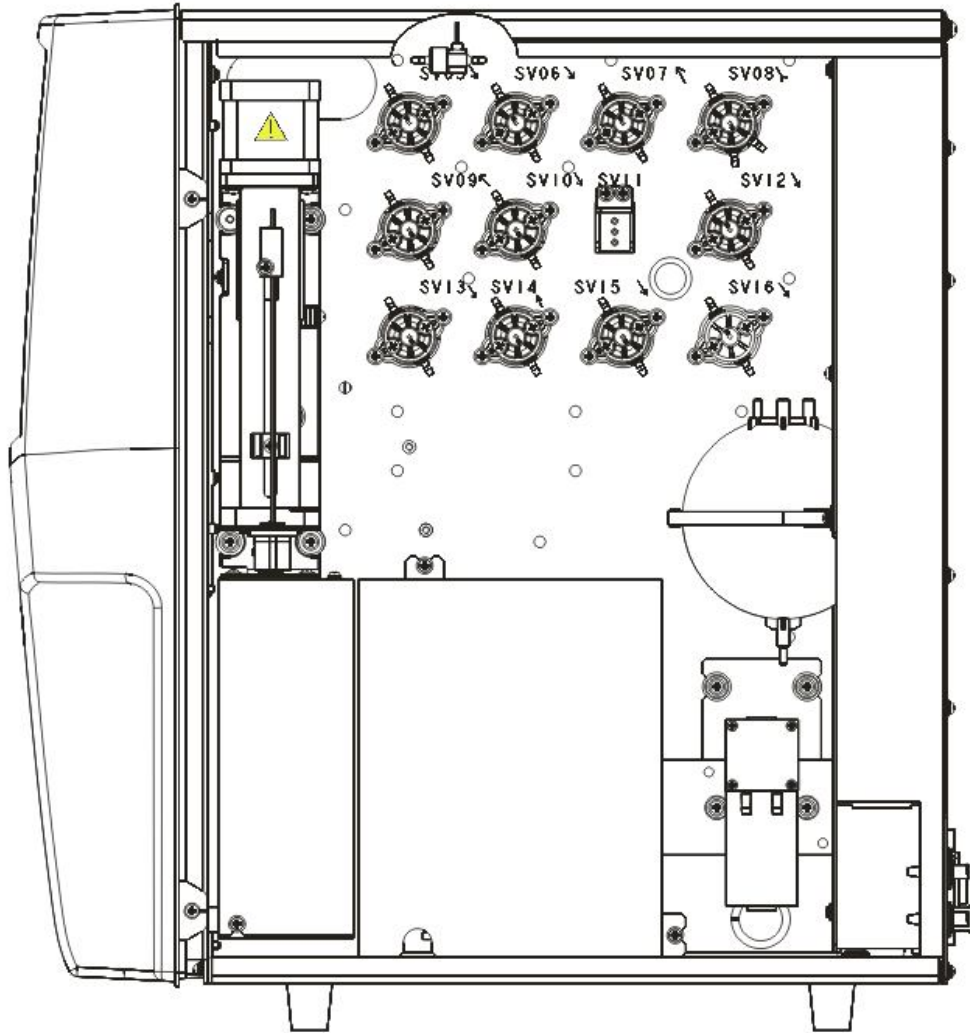
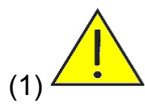

Figure 1-4 Right of the analyzer



Do not put hands under the syringe or in the guide slot when the analyzer is running.

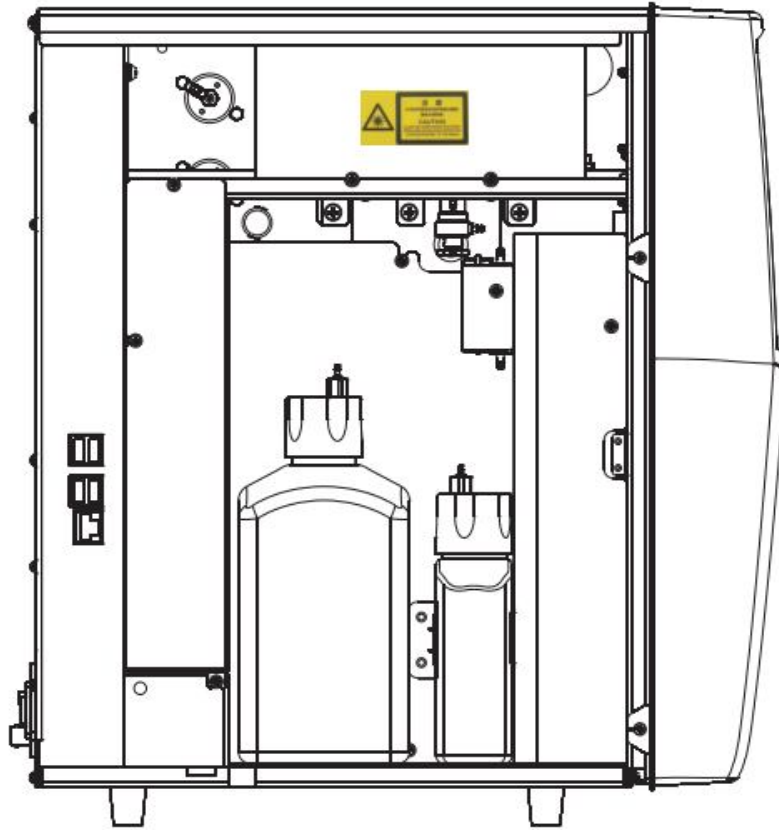

Figure 1-5 Left of the analyzer



(1)

Caution: Class 3B Laser radiation when open and interlocks defeated avoid exposure to the beam

2 Understanding the Analyzer

2.1. Introduction

This chapter introduces the parameters, major components, interfaces, buttons, menus, software help system, operation information and reagent system of the BC-5150 AUTO HEMATOLOGY ANALYZER.

2.2. Parameters

NOTE

- The purpose of this analyzer is to identify the normal patient, with all normal system-generated parameters, and to flag or identify patient results that require additional studies.

The analyzer determines 25 parameters, 4RUO parameters, histograms and 1 scattergram of blood samples. The parameters under CBC and CBC+DIFF mode are listed as follows:

Table 2-1 Parameters

Parameter Group	Name	Abbreviation	CBC	CBC + DIFF
WBC group (15), including 4 RUO parameters	White Blood Cell count	WBC	√	√
	Basophils number	Bas#	/	√
	Basophils percentage	Bas%	/	√
	Neutrophils number	Neu#	/	√
	Neutrophils percentage	Neu%	/	√
	Eosinophils number	Eos#	/	√
	Eosinophils percentage	Eos%	/	√
	Lymphocytes number	Lym#	/	√
	Lymphocytes percentage	Lym%	/	√
	Monocytes number	Mon#	/	√
	Monocytes percentage	Mon%	/	√
	Abnormal Lymphocytes number	ALY#	/	√
	Abnormal Lymphocytes percentage	ALY%	/	√
	Large Immature Cells number	LIC#	/	√
	Large Immature Cells percentage	LIC%	/	√
RBC group (8)	Red Blood Cell count	RBC	√	√
	Hemoglobin Concentration	HGB	√	√
	Mean Corpuscular Volume	MCV	√	√
	Mean Corpuscular Hemoglobin	MCH	√	√

	Mean Corpuscular Hemoglobin Concentration	MCHC	√	√
	Red Blood Cell Distribution Width - Coefficient of Variation	RDW-CV	√	√
	Red Blood Cell Distribution Width - Standard Deviation	RDW-SD	√	√
	Hematocrit	HCT	√	√
PLT group (6)	Platelet count	PLT	√	√
	Mean Platelet Volume	MPV	√	√
	Platelet Distribution Width	PDW	√	√
	Plateletcrit	PCT	√	√
	Platelet larger cell ratio	P-LCR	√	√
	Platelet larger cell count	P-LCC	√	√

- **Histograms**

Table 2-2 Histograms

Name	Abbreviation	CBC	CBC + DIFF
White Blood Cell Histogram	WBC Histogram	√	√
Red Blood Cell Histogram	RBC Histogram	√	√
Platelet Histogram	PLT Histogram	√	√

- **Scattergram**

Table 2-3 Scattergram

Abbreviation	CBC	CBC + DIFF
Diff Scattergram	/	√

NOTE

- "√" means "available under the mode", "/" means "not available under the mode".
- ALY%, LIC%, ALY# and LIC# are for research use only. *For more information about RUO parameters, see 9.2.4 Parameter Setup-RUO parameters.*

2.3. Product Description

BC-5150 AUTO HEMATOLOGY ANALYZER includes the Sample Processing Unit (SPU), Data Managing Unit (DMU), Result Output Unit (ROP) and accessories. The appearance of the product is as follows:



⚠ WARNING

- Please check the firmness of all the doors and covers before running the analyzer, and make sure they do not get loose when the analyzer is running.
-

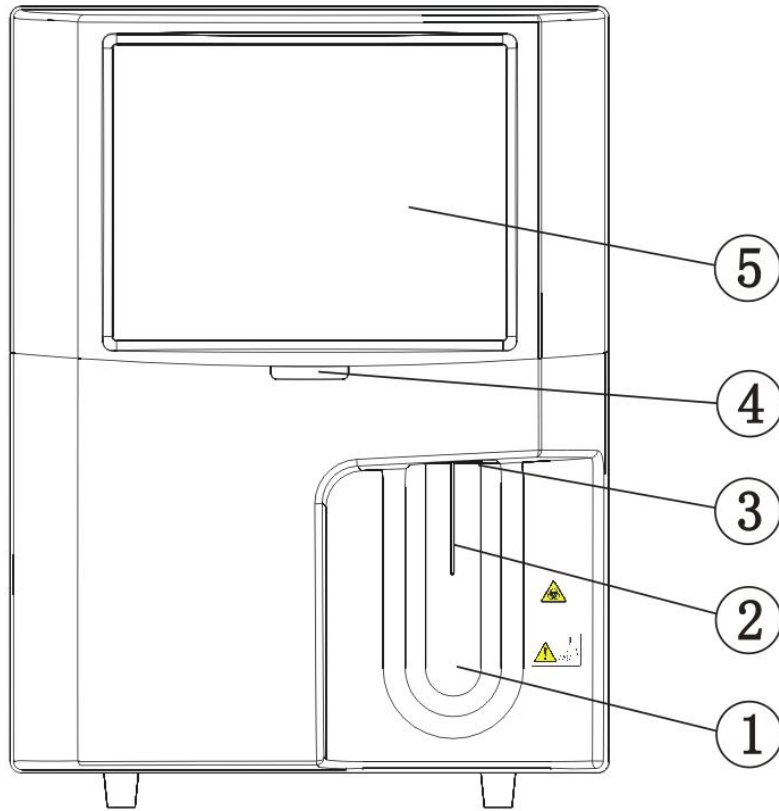

Figure 2-1 Front of the analyzer

1 ---- [Aspirate] key

2 ---- Sample probe

3 ----Probe wipe block

4 ----Power/status indicator

5 ----Display

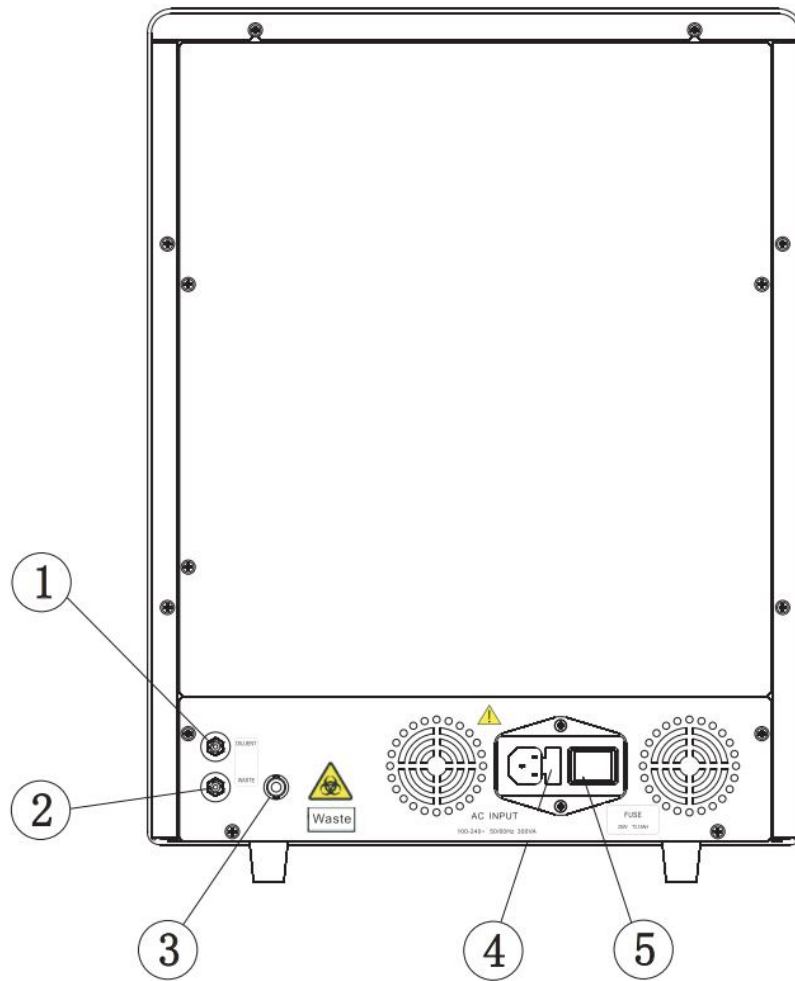

Figure 2-2 Back of the analyzer

1 --- M-52D diluent inlet

2 ---Waste outlet

3 --- Waste sensor

4 ---AC input

5 --- Power switch

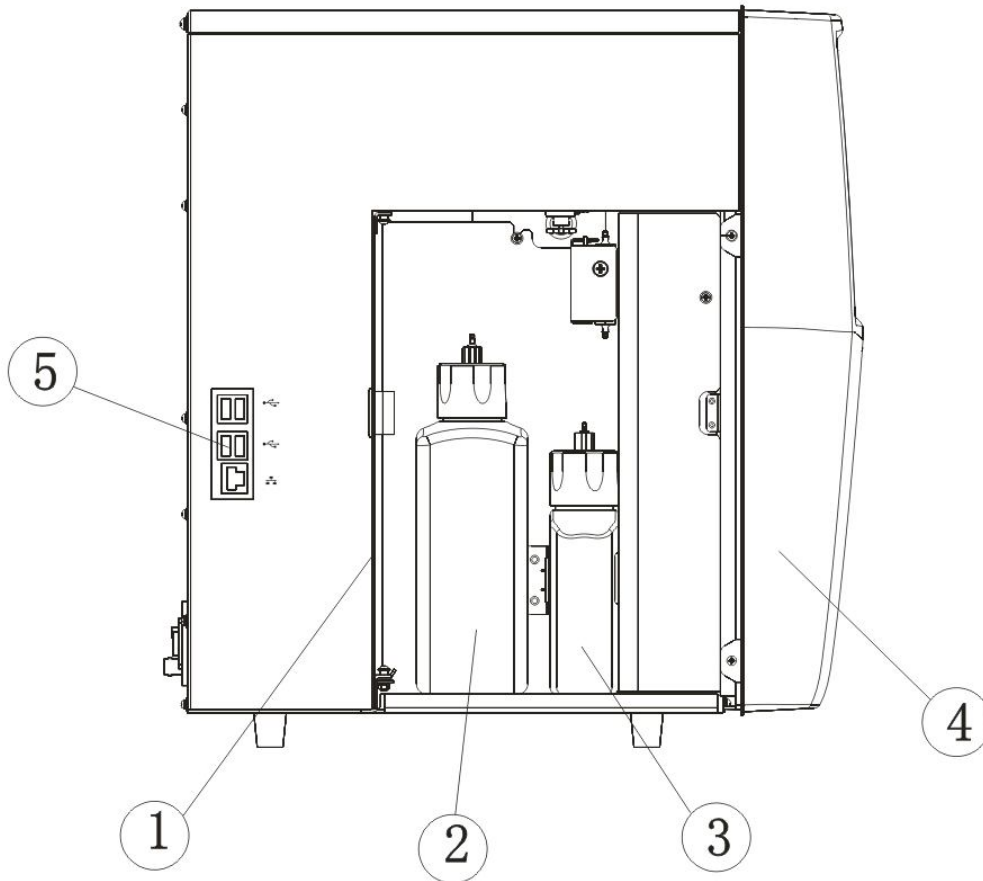

Figure 2-3 Left of the analyzer (left door open)

- | | |
|------------------------------|----------------------------|
| 1 --- Left door | 2 --- DIFF reagent bottle |
| 3 --- LH reagent bottle | 4 --- Front cover assembly |
| 5 --- Network port, USB port | |

- **Power switch**

Power switch is located on the back of the analyzer.

⚠ CAUTION

Do not turn on/off the switch repeatedly in a short time to avoid damaging the analyzer.

- **[Aspirate] key**

The aspirate key is on the front of the analyzer, press it to start analysis, dispense diluent or exit from standby mode.

- **USB/network port**

The USB port and network port are on the left of the analyzer. They can be used to connect the printer, barcode scanner, etc., and to transmit data.

The supported printer models are: EPSON LQ-590K, HP Laser Jet P1505n, HP OfficeJet Pro K5300 and HP LaserJet P1606dn.

2.4. Status Indicator

The status indicator is on the front of the analyzer; it indicates the ready, running, error and standby status of the analyzer.

The indicator illuminates in 3 colors to indicate the current status of the analyzer; its flickering interval is 2 seconds. See the following table:

Table 2-4 the indicator and analyzer status

Status	Indicator	Note
Ready	Solid green	Ready to sequence actions
Running	Flickering green	sequence actions in progressing
Running with error	Flickering red	The analyzer is running with error
Error	Solid red	An error has occurred, and the analyzer is not running
No error, but fluidic actions are not allowed.	Solid yellow	Initializing (not involving sequence actions) in startup process, standby status
Entering/exiting standby status	Flickering yellow	Entering/exiting standby status

2.5. Buzzer

The buzzer indicates errors of the analyzer. When you click the touch screen or the error is cleared, the alarming sound of the buzzer can be cleared.

Table 2-5 the buzzer and analyzer status

When...	How...	Note
The startup process completes	1 short beep	The startup process completes and the analyzer ready to run analysis.
Open vial sample aspiration finishes	2 short beeps	
Press the aspirate key at the analysis screens (including sample analysis, QC, calibration, Reproducibility, carryover, background, aging, optical gain calibration screens) when analysis cannot be started.	1 long beep	When dialog box message is given, the buzzer may not beep.
Error	Long beeps at intervals	Tap the touch screen to turn off the buzzer.
The analyzer enters ready status	1 short beep	The analyzer enters ready status from another status.
When the analyzer screen turns black and the message "Please power off the analyzer" appears	Turn off the buzzer.	If error occurs during the shutdown process, please turn off the buzzer when the screen turns black.

2.6. System Menu



2.7. Reagents, Controls and Calibrators

As the analyzer, reagents (diluent, lyses, and probe cleanser), controls, and calibrators are components of a system. Performance of the system depends on the combined integrity of all components. Only Mindray-specified reagents (see Appendix B Specifications), which are formulated specifically for the fluidic system of your analyzer in order to provide optimal system performance, could be used. Do not use the analyzer with reagents from multiple suppliers. Otherwise, the analyzer may not meet the performance specified in this manual and may provide unreliable results. All references related to reagents in this manual refer to the reagents specifically formulated for this analyzer.

Each reagent package must be examined before use. Product integrity may be compromised in packages that have been damaged. Inspect the package for signs of leakage or moisture. If there is evidence of leakage or improper handling, do not use the reagent.

NOTE

- Store and use the reagents as instructed by instructions for use of the reagents.
 - When you have changed the diluents or lyse, implement a background test to see if the results meet the requirement.
 - Pay attention to the expiration dates and open-container stability days of all the reagents. Be sure not to use expired reagents.
-

2.7.1. Reagents

M-52 D Diluent

It is used to dilute blood samples and provide a stable environment for counting and sizing blood cells.

M-52 DIFF Lyse

It is used to lyse red blood cells and differentiate WBCs.

M-52 LH Lyse

It is used to lyse red blood cells, count and differentiate WBCs, and determine the HGB.

Probe Cleanser

Probe cleanser is used to clean the analyzer regularly.

2.7.2. Controls and Calibrators

The controls and calibrators are used to verify accurate operation of and calibrate the analyzer.

The controls are commercially prepared whole-blood products used to verify that the analyzer is functioning properly. They are available in low, normal, and high levels. Daily use of all levels verifies the operation of the analyzer and ensures reliable results are obtained. The calibrators are commercially prepared whole-blood products used to calibrate the analyzer. Store and use the controls and calibrators as instructed by their instructions for use.

All references related to controls and calibrators in this manual refer to the controls and calibrators specifically formulated for this analyzer by Mindray. You must buy those controls and calibrators from Mindray or Mindray-authorized distributors.

3 Understanding the System Principles

3.1 Introduction

The measurement methods used in this analyzer are: the Electrical Impedance method for determining the RBC and PLT data; the colorimetric method for determining the HGB; flow cytometry by laser for determining the WBC data. Other parameter results are obtained via calculation.

3.2 Aspiration

If you are to analyze a whole blood sample in the open vial sampling mode, the analyzer will aspirate 15 μ L (CBC+DIFF mode) or 11.7 μ L (CBC mode) of the sample.

If you are to analyze a capillary blood sample in the open vial sampling mode, you should first manually dilute the sample (20 μ L of capillary sample needs to be diluted by 480 μ L of diluent, dilution ratio: 1:25) and then present the pre-diluted sample to the analyzer, which will aspirate 200 μ L of the sample.

3.3 Dilution

The aspirated sample will quickly and precisely be diluted in RBC bath and then segmented into two portions. One of these two portions will then be diluted again and processed by different reagents. After this, they are ready for analysis.

This analyzer can process two types of blood samples – whole blood samples and pre-diluted sample.

- **Whole Blood Mode**

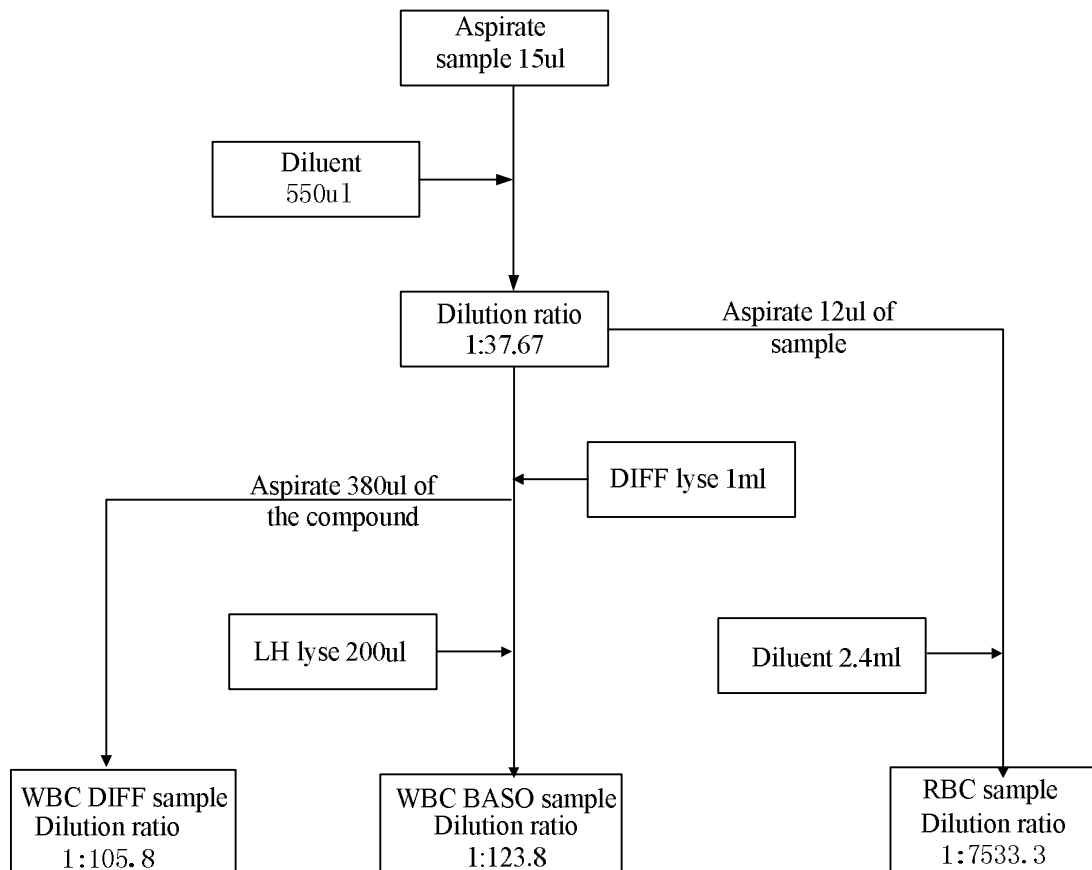

Figure 3-1 Dilution procedure of whole blood CBC+DIFF mode

● **Pre-diluted Mode**

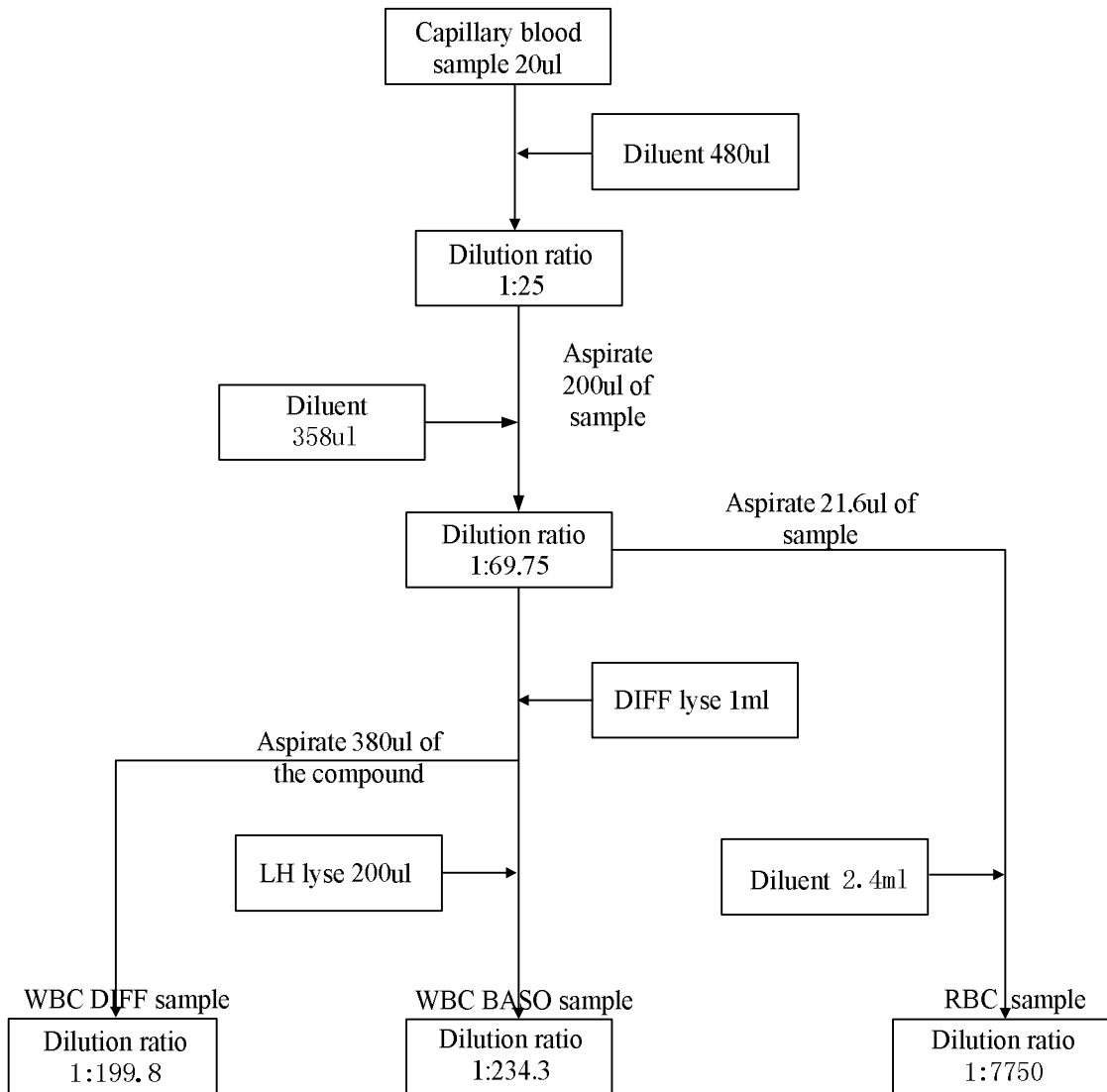

Figure 3-2 Dilution procedure of pre-diluted CBC+DIFF mode

3.4 WBC Measurement

- Flow Cytometry by Laser

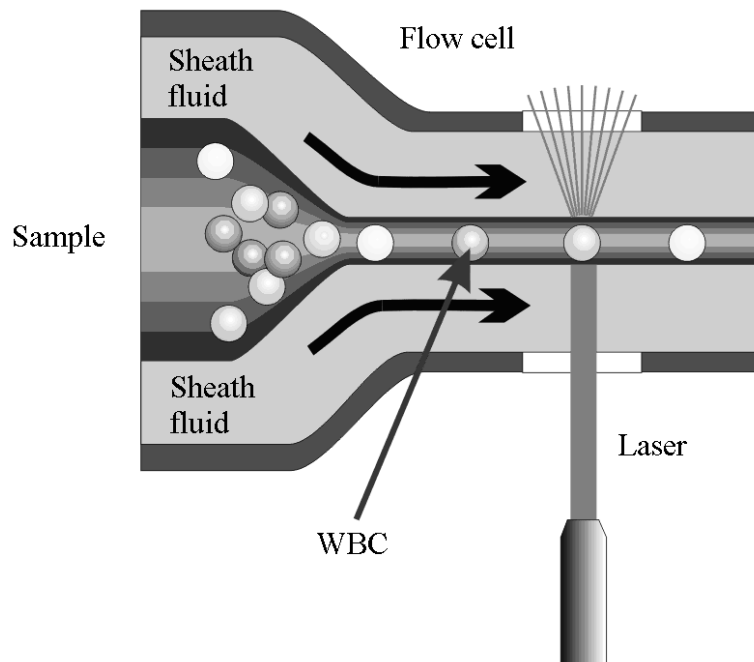

Figure 3-3 WBC Measurement

After a predetermined volume of blood is aspirated and diluted by a certain amount of reagent, it is injected into the flow cell. Surrounded with sheath fluid (diluent), the blood cells pass through the center of the flow cell in a single column at a faster speed. When the blood cells suspended in the diluent pass through the flow cell, they are exposed to a laser beam. The intensity of scatter light reflects the blood cell size and intracellular density. The low-angle scattered light reflects cell size, and the high-angle scattered light reflects intracellular density (nucleus size and density). The optical detector receives this scatter light and converts it into electrical pulses. Pulse data collected can be used to draw a 3-dimensional distribution (scattergram).

3.5 HGB Measurement

- **Colorimetric Method**

The WBC/HGB dilution is delivered to the HGB bath where it is bubble mixed with a certain amount of lyse, which converts hemoglobin to a hemoglobin complex that is measurable at 530 nm. An LED is mounted on one side of the bath and emits a beam of monochromatic light, whose central wavelength is 530nm. The light passes through the sample and is then measured by an optical sensor that is mounted on the opposite side. The signal is then amplified and the voltage is measured and compared to the blank reference reading (readings taken when there is only diluent in the bath), and the HGB is measured and calculated in the analyzer automatically.

- **HGB**

The HGB is calculated per the following equation and expressed in g/L.

$$\text{HGB(g/L)} = \text{Constant} \times \text{Log } 10 (\text{Blank Photocurrent} / \text{Sample Photocurrent})$$

3.6 RBC/PLT Measurement

● Electrical Impedance Method

RBCs/PLTs are counted and sized by the Electrical Impedance method. This method is based on the measurement of changes in electrical resistance produced by a particle, which in this case is a blood cell, suspended in a conductive diluent as it passes through an aperture of known dimensions. A pair of electrodes is submerged in the liquid on both sides of the aperture to create an electrical pathway. As each particle passes through the aperture, a transitory change in the resistance between the electrodes is produced. This change produces a measurable electrical pulse. The number of pulses generated represents the number of particles that passed through the aperture. The amplitude of each pulse is proportional to the volume of each particle.

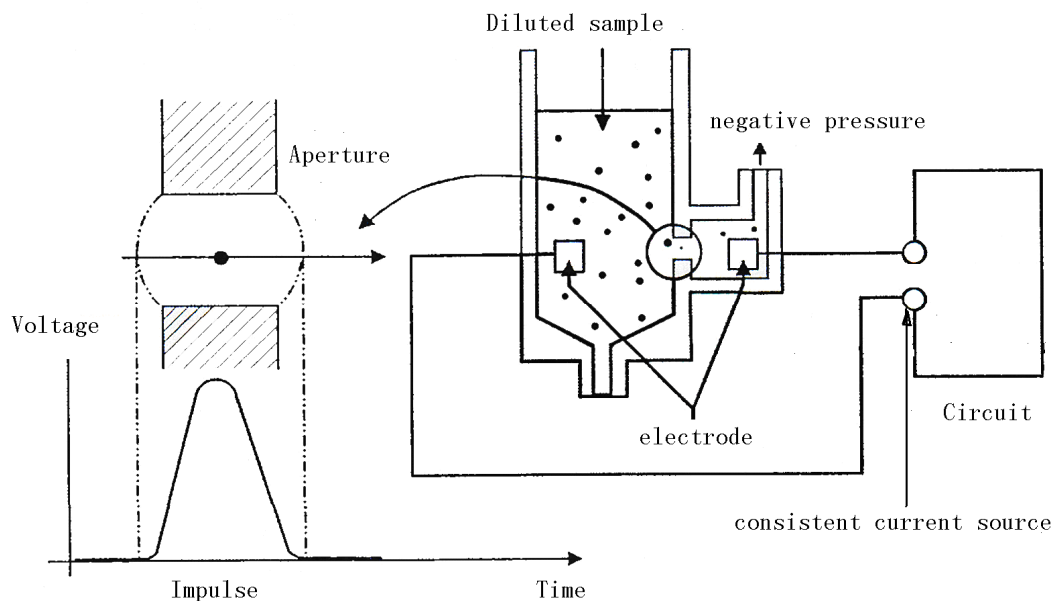

Figure 3-4 Electrical Impedance method

Each pulse is amplified and compared to the internal reference voltage channel, which only accepts the pulses of certain amplitude. If the pulse generated is above the RBC/PLT lower threshold, it is counted as a RBC/PLT. The analyzer presents the RBC/PLT histogram, whose x-coordinate represents the cell volume (fL) and y-coordinate represents the number of the cells.

● Derivation of RBC-Related Parameters

● RBC

RBC ($10^{12}/L$) is the number of erythrocytes measured directly by counting the erythrocytes passing through the aperture.

- MCV

Based on the RBC histogram, this analyzer calculates the mean cell volume (MCV) and expresses the result in fL.

- HCT, MCH, and MCHC

This analyzer calculates the HCT(%), MCH (pg) and MCHC (g/L) as follows:

$$\text{HCT} = \frac{\text{RBC} \times \text{MCV}}{10}$$

$$\text{MCH} = \frac{\text{HGB}}{\text{RBC}}$$

$$\text{MCHC} = \frac{\text{HGB}}{\text{HCT}} \times 100$$

Where the RBC is expressed in $10^{12}/\text{L}$, MCV in fL and HGB in g/L.

- RDW-CV

Based on the RBC histogram, this analyzer calculates the CV (Coefficient of Variation) of the erythrocyte distribution width, it is expressed in %.

- RDW-SD

Based on the standard deviation of erythrocyte size distribution, this analyzer calculates the RDW-SD, its unit is fL.

- **Derivation of PLT-Related Parameters**

- PLT

PLT ($10^9/\text{L}$) is measured directly by counting the platelets passing through the aperture.

- MPV

Based on the PLT histogram, this analyzer calculates the mean platelet volume (MPV, fL).

- PDW

Platelet distribution width (PDW) is the geometric standard deviation (GSD) of the platelet size distribution. Each PDW result is derived from the platelet histogram data and is reported as 10(GSD).

- PCT

This analyzer calculates the PCT as follows and expresses it in %.

Where the PLT is expressed in $10^9/L$ and the MPV in fL.

$$PCT = \frac{PLT \times MPV}{10000}$$

- P-LCR

Platelet larger cell ratio (P-LCR) is the ratio of the larger platelet (volume larger than 12fL) count to the total PLT count. This analyzer calculates the P-LCR based on the PLT histogram and expresses the result in %. In the following figure, S2 represents the number of larger platelet cells, and S1+S2 represents the total PLT count.

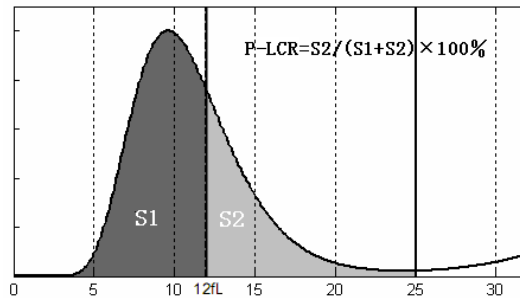

- P-LCC

This analyzer calculates the platelet large cell count (P-LCC) and expresses the result in $10^9/L$.

$$P-LCC = PLT \times P-LCR$$

4 Installing Your Analyzer

4.1. Introduction

WARNING

- Installation by personnel not authorized or trained by Mindray may cause personal injury or damage your analyzer. Do not install your analyzer without the presence of Mindray-authorized personnel.
 - The installation, authorization, upgrade and modification of the analyzer software must be performed by Mindray-authorized personnel.
-

Your analyzer is tested before it is shipped from the factory. International symbols and special handling instructions tell the carrier how to treat this electronic instrument. When you receive your analyzer, carefully inspect the carton. If you see any signs of mishandling or damage, contact Mindray customer service department or your local distributor immediately.

4.2. Installation Requirements

4.2.1. Space Requirements

Check the site for proper space allocation. In addition to the space required for the analyzer itself, arrange for:

- proper height to place the analyzer;
- at least 50 cm on each side, which is the preferred access to perform service procedures;
- at least 10 cm behind the analyzer for cabling and ventilation;
- enough room on and below the countertop to accommodate the reagents and waste containers;
- diluent container shall be put within 1.0m under the analyzer, lyse containers are placed inside the analyzer.
- The countertop (or the floor) where the analyzer is placed shall be able to withstand at least 40kg of weight.

4.2.2. Power Requirements

⚠ WARNING

- Make sure the analyzer is properly grounded.
- Before turning on the analyzer, make sure the input voltage meets the requirements.

⚠ CAUTION

- Using pinboard may bring the electrical interference and the analysis results may be unreliable. Please place the analyzer near the electrical outlet to avoid using the pinboard.
- Please use the original power cable shipped with the analyzer. Using other power cable may damage the analyzer or cause unreliable analysis results.

Table 4-1 Power specification

	Voltage	Input power	Frequency
Analyzer	(100V-240V~)±10%	300VA	(50Hz/60Hz) ±1Hz

4.2.3. General Environment

Optimal operating temperature: 10 °C ~ 30 °C

Optimal operating humidity: 20 % ~ 85 %

Atmospheric pressure: 70 kPa ~ 106 kPa

The environment shall be as free as possible from dust, mechanical vibrations, loud noises, and electrical interference.

It is advisable to evaluate the electromagnetic environment prior to operation of this analyzer.

Do not use this analyzer in close proximity to sources of strong electromagnetic radiation (e.g. unshielded intentional RF sources), as these may interfere with the proper operation.

Do not place the analyzer near brush-type motors, flickering fluorescent lights, and electrical contacts that regularly open and close.

Do not place the analyzer in direct sunlight or in front of a source of heat or drafts.

The environment shall be ventilated.

Do not place the analyzer on a slope.

Connect only to a properly earth grounded outlet.

Only use this analyzer indoors.

4.2.4. Moving and Installing the Analyzer

⚠ WARNING

- Installation by personnel not authorized or trained by Mindray may cause personal injury or damage your analyzer. Do not install your analyzer without the presence of Mindray-authorized personnel.
-

NOTE

- Before the analyzer is shipped out, the sample probe is fixed by a plastic cable tie to avoid damaging the sample probe during transportation. Remove the cable tie before using the analyzer.
-

Moving and installation of the analyzer shall be conducted by Mindray-authorized personnel. Do not move or install your analyzer without the presence of Mindray-authorized personnel.

4.3. Connecting the Analyzer System

Connect the analyzer and the reagents as shown in the following figure. Make sure the connections are correct and firm.

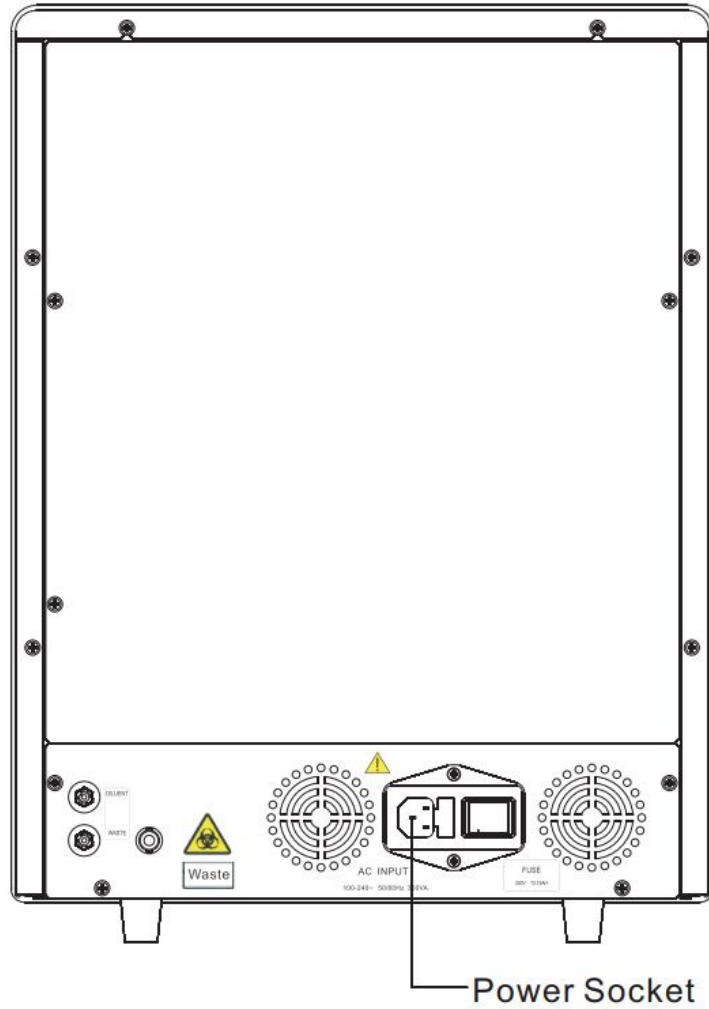

Figure 4-1 Connecting the analyzer to power outlet

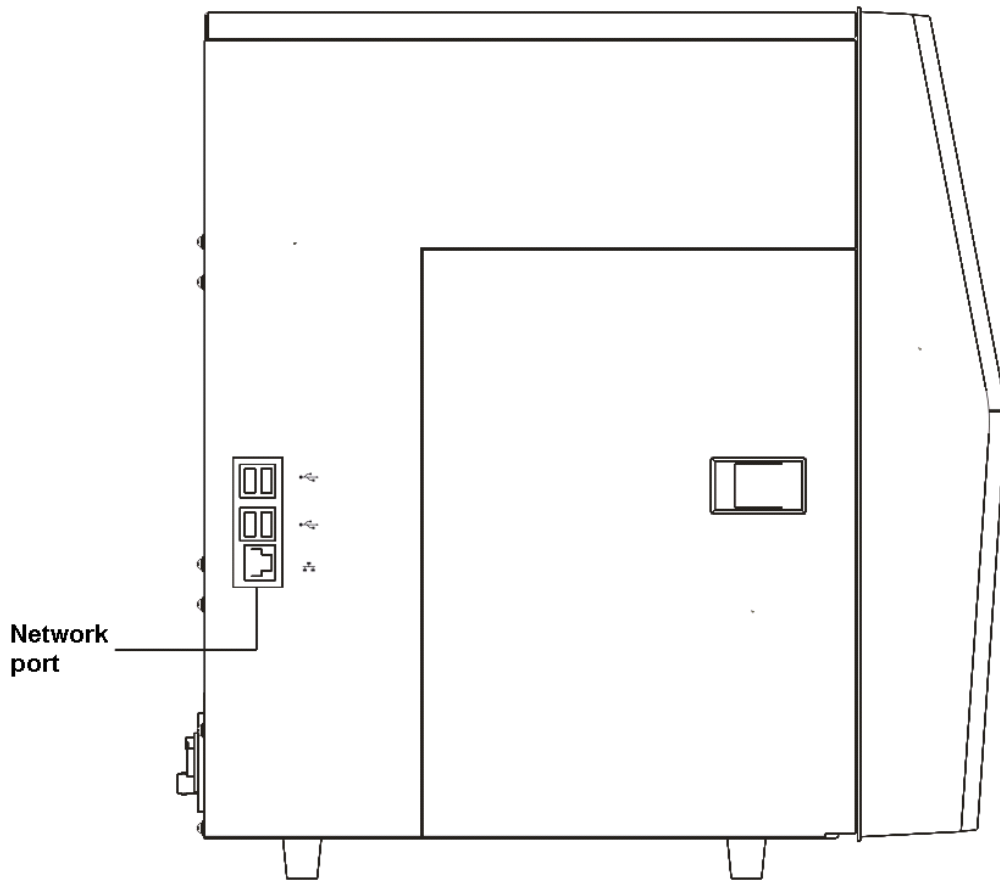

Figure 4-2 Connecting the analyzer to power outlet

⚠ WARNING

- Be sure to dispose of reagents, waste, samples, consumables, etc. according to government regulations.
 - The reagents are irritating to eyes, skin and airway. Wear proper personal protective equipment (e.g. gloves, lab coat, etc.) and follow safe laboratory procedures when handling them and the contacted areas in the laboratory.
 - If reagents accidentally spill on your skin or in your eyes, rinse the area with ample amount of clean water; seek medical attention immediately.
-

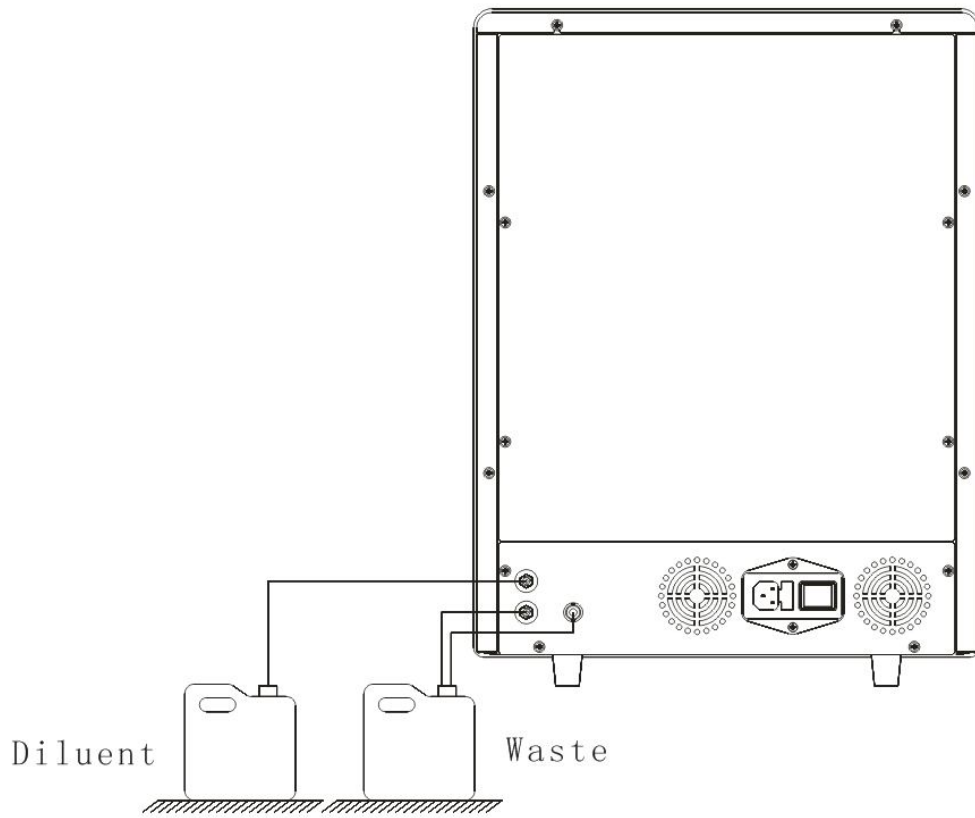

Figure 4-3 Connecting reagents placed outside the analyzer

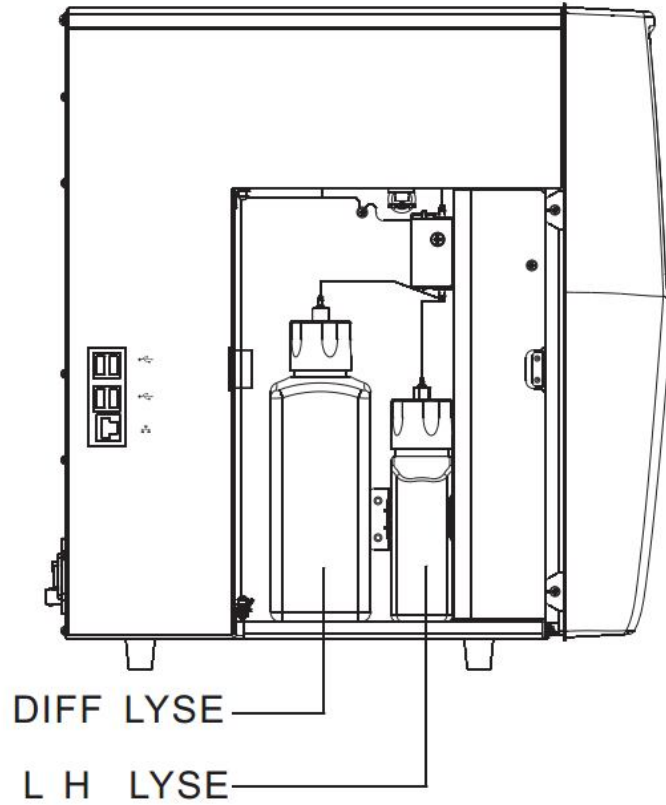

Figure 4-4 Connecting reagents placed inside the analyzer

⚠ CAUTION

- Make sure the diluent pipe and waste pipe are no longer than 1500mm.
- The waste and diluent containers must be placed lower than the countertop that accommodates the analyzer.

4.4. Notes

- The analyzer performance may be undermined if it has been placed in environment of high dustiness.
- The surface of the analyzer shall be cleaned and sterilized regularly with alcohol (75%).
- The probe wipe block of the analyzer (see *Figure 4-5 Front of the analyzer*) shall be wiped with alcohol (75%) regularly.
- Sample collection and preparation must be done following standard procedures.
- If any of the pipes or fluidic components is worn out, stop using the analyzer and contact Mindray customer service department immediately for inspection or replacement.
- Check and make sure the reagents, lyse and waste pipes are not pressed or bent.
- You must only use the Mindray-specified reagents, otherwise the analyzer may be damaged or provide unreliable results.
- Pay attention to the expiration dates and open-container stability days of all the reagents. Be sure not to use expired reagents.

5 Operating Your Analyzer

5.1. Introduction

This chapter provides step-by-step procedures for operating your analyzer on a daily basis.

A flow chart indicating the common daily operating process is presented below.

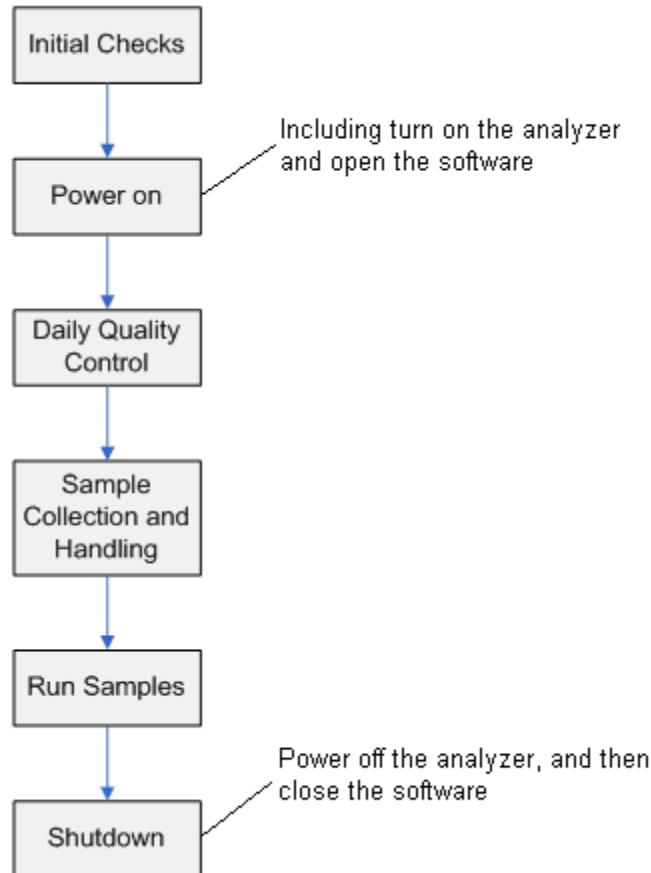

- All the samples, controls, calibrators, reagents, wastes and areas contacted them are potentially biohazardous. Wear proper personal protective equipment (e.g. gloves, lab coat, etc.) and follow safe laboratory procedures when handling them and the contacted areas in the laboratory.

⚠ WARNING

- Do not contact the patients' sample blood directly.
 - Be sure to dispose of reagents, waste, samples, consumables, etc. according
-

to government regulations.

- The reagents are irritating to eyes, skin and airway. Wear proper personal protective equipment (e.g. gloves, lab coat, etc.) and follow safe laboratory procedures when handling them and the contacted areas in the laboratory.
 - If reagents accidentally spill on your skin or in your eyes, rinse the area with ample amount of clean water; seek medical attention immediately.
 - Keep your clothes, hairs and hands away from the moving parts to avoid injury.
 - The sample probe tip is sharp and may contain biohazardous materials. Exercise caution to avoid contact with the probe when working around it.
-

⚠ CAUTION

- Do not reuse disposable products such as collection tubes, test tubes, capillary tubes and so on.
-

NOTE

- Use the reagents specified by the manufacturer only. Store and use the reagents as instructed by instructions for use of the reagents.
 - Check if the reagent tubes are properly connected before using the analyzer.
 - Be sure to use clean EDTAK₂ or EDTAK₃ anticoagulant collection tubes, fused silica glass/plastic test tubes, centrifugal tubes and borosilicate glass capillary tubes.
 - Be sure to use the evacuated collection tubes recommended in the Appendix.
 - Be sure to use the Mindray-specified disposable products including evacuated blood collection tube, anticoagulant collection tubes and capillary tubes etc.
-

5.2. Initial Checks

Perform the following checks before turning on the analyzer.

- Checking the waste container

Check and make sure the waste container is not full.

- Checking reagents

Check to see if the reagents are expired or frozen. Reagents must be equilibrated for 24 hours before use.

- Checking tubing and power connections

Check and make sure the reagents, waste and pneumatic unit tubes are properly connected and not bent.

Check and make sure the power cord of the analyzer is properly plugged into the power outlet.

- Checking the printer

Check and make sure enough printer paper is installed. Check and make sure the power cord of the printer is properly plugged into power outlet, and the printer is properly connected to the analyzer.

5.3. Startup and Logon

Start up the analyzer:

1. Change the power switch at the backside to ON position ('I') will power on the instrument.
2. The indicator light turns on.
3. The analyzer will perform self-test and initialization.

NOTE

- Time needed for initializing the fluidic systems depends on how the analyzer was previously shut down.
 - Background check is the measurement of particle and electric interference by the analyzer.
 - If the results of the first background check do not meet requirement, the analyzer will perform background check again.
 - The sample ID of background check results is "background".
 - The error message "Background abnormal" will be given when the background results are out of range.
-

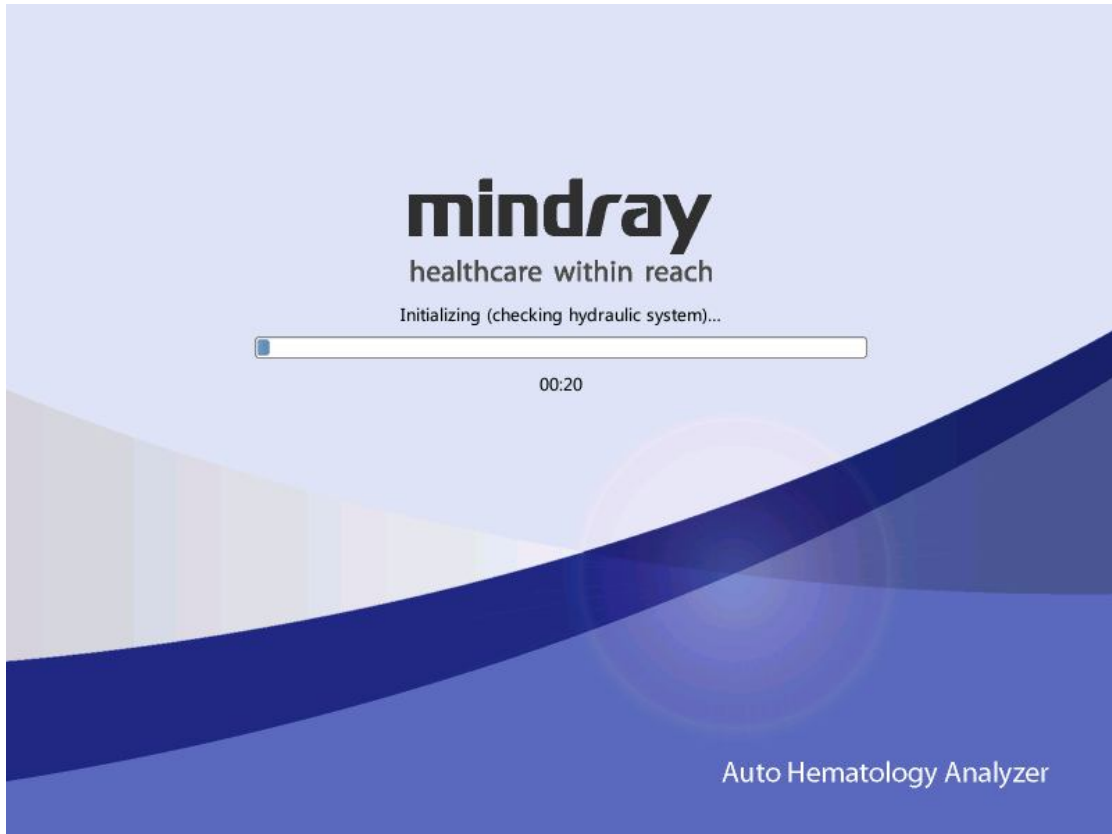

4. Enter the current user name and the password respectively into the "User ID" box and the "Password" box.

The image shows a 'Login' screen with a dark blue header. Below the header, there are two input fields: 'User ID' and 'Password'. Each field is accompanied by a white rectangular input box. At the bottom of the screen, there are two dark blue buttons with white text: 'Login' and 'Shutdown'.

NOTE

- If the software cannot be started successfully after being launched for several times, contact Mindray Customer Service Department or the authorized distributors.
- After starting up the analyzer, check if the date/time is correct.
- The default user name and password for administrator are both "Admin".
- The user name and password may be consisted of 1-12 letters, and the

password cannot be null.

5. Tap "Logon" to enter the system.



NOTE

- If error occurs during the initialization process (e.g., background check fails), the analyzer will report the error. See Chapter 11 Troubleshooting Your Analyzer for the solution.
- See Appendix B Specifications for the background range of each parameter.
- The system opens different function for the user according to the user level. The user level depends on the user name and the password when the user logs in.
- If user switching is necessary, click the "Log off" icon on the system menu. Enter the desired user name and the password into the pop-up dialog box and Click the "OK" button to log on.
- Running sample with the background abnormal error present will lead to unreliable results.

5.4. Daily Quality Control

Perform daily quality control before running any samples. See Chapter 7 Using the QC Programs for details.

5.5. Sample Collection and Handling



- All the samples, controls, calibrators, reagents, wastes and areas contacted them are potentially biohazardous. Wear proper personal protective equipment (e.g. gloves, lab coat, etc.) and follow safe laboratory procedures when handling them and the contacted areas in the laboratory.
-

⚠ WARNING

- The sample probe is sharp and potentially biohazardous. Do not contact the sample probe during operations.
-

⚠ CAUTION

- Do not reuse disposable products such as collection tubes, test tubes, capillary tubes and so on.
-

NOTE

- Make sure the probe tip does not contact the sample tube to avoid potential spillage.
-

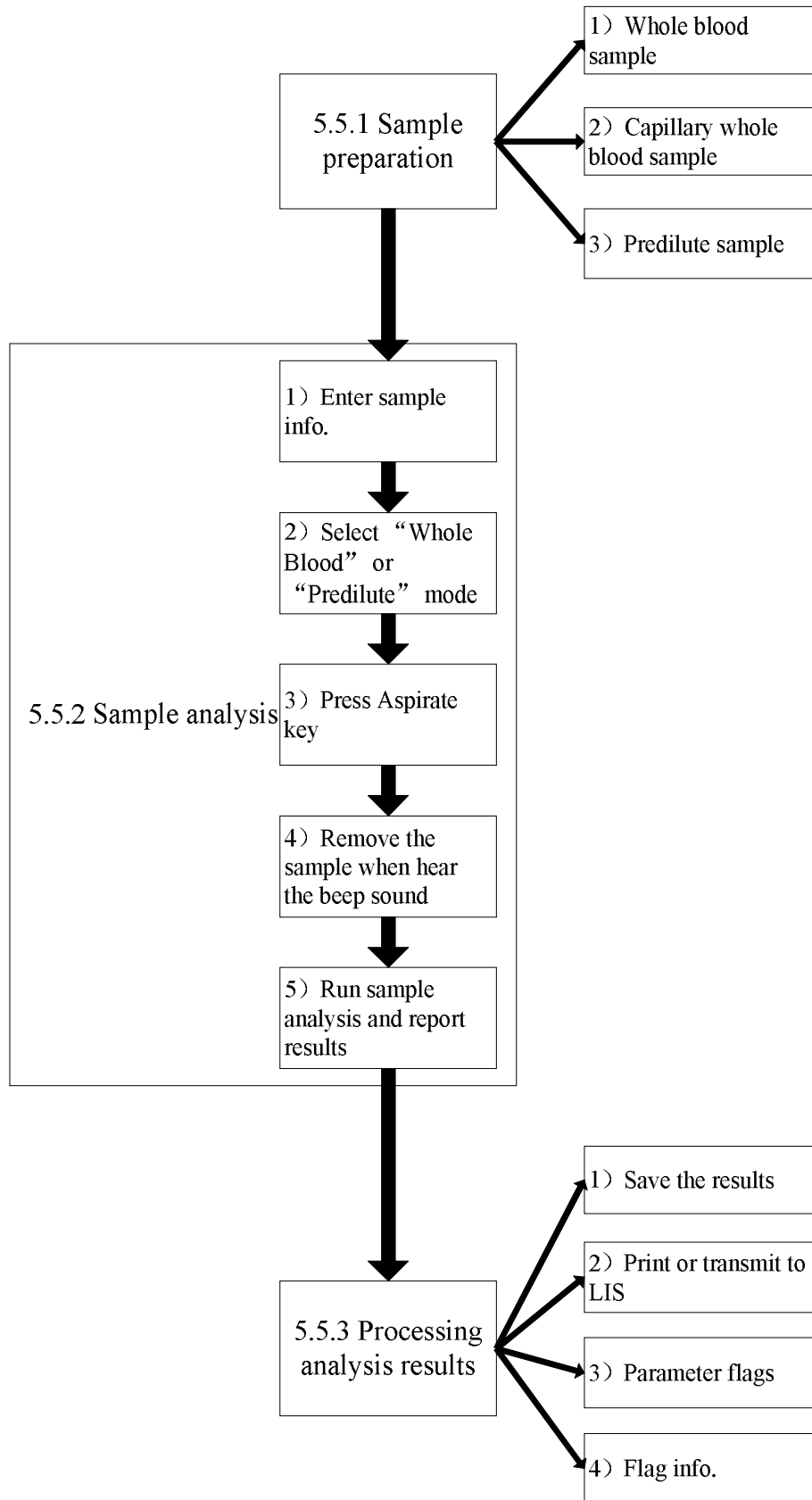

5.5.1. Sample Preparation

The analyzer can run 3 types of samples: whole blood samples, capillary whole blood samples and pre-diluted samples.

⚠ CAUTION

- Prepare samples following the recommend procedure of the manufacturer.
- All samples shall be mixed as shown in the following figure.

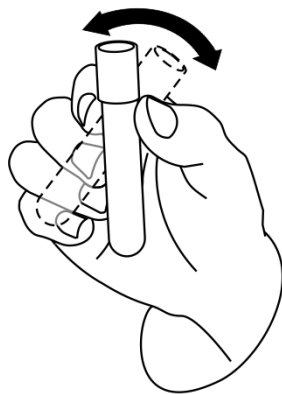

1) Whole blood samples

1. Use clean EDTAK₂ or EDTAK₃ anticoagulant collection tubes to collect venous blood samples.
 2. Mix the sample according to your laboratory's protocol.
-

⚠ CAUTION

- Be sure to collect at least 0.5 mL of blood to ensure the accuracy of the results.
-

2) Capillary whole blood samples

1. Use tubes to collect capillary whole blood samples.
-

CAUTION

- Be sure to collect at least 120uL of capillary whole blood to ensure the accuracy of the results.

NOTE

- Be sure to run the capillary whole blood samples within 3 minutes to 2 hours after being collected.
-

3) Pre-diluted samples

1. Click the diluent dispensing icon, the following dialog box pops up.

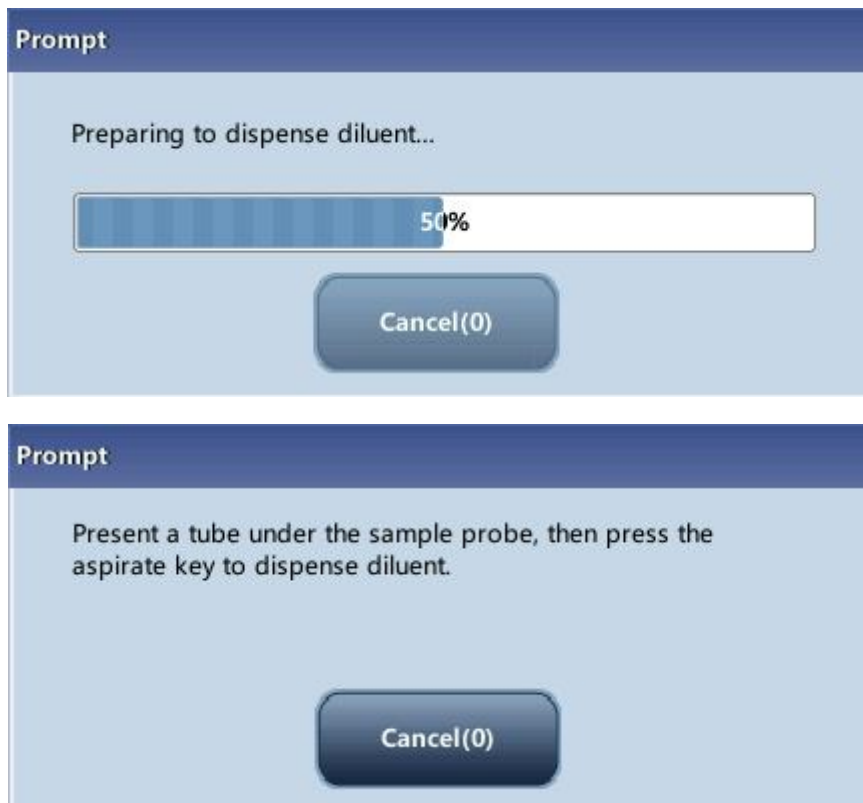

2. Present a clean tube to the sample probe, press the aspirate key to dispense diluents (480µL). The dispensing progress bar will be displayed on the screen.
3. To continue with diluent dispensing, repeat the step 1-2.
4. Add 20µL of venous blood or capillary blood to the diluent, close the tube cap and mix it properly according to your laboratory's protocol.
5. Click "Cancel" after preparing all the samples, the analyzer will clean the sample

probe automatically.

NOTE

- You can also use pipette to aspirate 480µL of diluent.
 - Be sure to keep dust from the prepared diluent.
 - After mixing the capillary sample with the diluent, be sure to wait 3 minutes and then remix before running the sample.
 - Be sure to run the pre-diluted samples within 30 minutes after the mixing.
 - Be sure to mix any sample that has been prepared for a while before running it. Do not mix the samples with massive force using swirl mixer.
 - Be sure to evaluate pre-diluted stability based on your laboratory's sample population and sample collection techniques or methods.
-

5.5.2. Sample Analysis

Tap "Sample Analysis" to enter the sample analysis screen. Tap "Mode" button to select "Whole blood-CBC+DIFF", "Whole blood-CBC", "Capillary whole blood-CBC+DIFF", "Capillary whole blood-CBC", "Pre-diluted-CBC+DIFF" or "Pre-diluted-CBC" mode.

1) Enter sample information

The analyzer provides two ways for you to enter sample information: entering sample ID only and entering all sample information.

If you want to enter sample information after analysis, you may skip this chapter, and enter sample information at the result review screen (see Chapter 6 Reviewing Sample Results).

You may first set up the way to enter sample information at the "Setup→Auxiliary" screen as instructed in Chapter 9 Customizing the Analyzer Software, then you may enter sample information at the "Analysis" screen.

- **Entering Patient Demographics**

When the way to enter patient demographic information is set to "Enter all information", click "Next Sample" at the sample analysis screen, the following dialog box will display. You may enter complete information of the next sample into the dialog box. The "Ref. group" will be selected by the system.

■ Entering the sample ID

Enter the sample ID in the "Sample ID" box.

NOTE

- Letters, numerics and all characters (including special characters) supported by the keyboard are allowed for sample ID entering.
- The allowed length of sample ID is [1, 20], and the ID cannot be null.

■ Entering the medical record number

Enter the medical record number in the "Patient ID" box.

■ Entering the patient name

Enter the patient name into the "Name" box.

■ Selecting patient gender

Select patient gender from the "Gender" pull-down list. There are two options: "Male" and "Female".

■ Entering the date of birth

Enter the patient's date of birth into the "Date of Birth" box. Its format must be the same with the system date format.

■ Entering the patient's age

The analyzer provides four ways for you to enter the patient's age – in years, in months, in days and in hours. The first way is designed for the adult or pediatric patients no younger than one year; the second for the infant patients one month to two years; the third for the neonatal no older than one month, and the fourth for the neonatal no older than 48 hours. You may choose one of the four ways to enter the patient age.

NOTE

- If the patient's date of birth is entered, his/her age will be calculated automatically, and the age field will gray out and cannot be edited.
 - If the entered date of birth is later than the current system, then it is considered invalid.
-

■ Entering the patient type

Select patient type from the "Patient Type" pull-down list.

■ Entering the department name

Enter the name of the department into the "Department" box or select it from the "Department" pull-down list (when there are previously saved records in the list). The saved contents will be added in the pull-down list automatically.

■ Entering the bed number

Enter the number of the patient's bed into the "Bed No." box.

■ Entering the draw time

Enter the time when the sample is collected into the "Draw Time" box.

■ Entering the delivery time

Enter the delivery time of analysis into the "Delivery Time" box.

■ Entering the Clinician

To enter the name of the person who sent the sample for analysis, enter the name into

the "Clinician" box or SELECT the desired name from the "Clinician" pull-down list (if there are previously saved names in the list). The saved contents will be added in the pull-down list automatically.

■ Entering comments

Enter comments in the "Comments" box.

■ OK

When you have finished entering the work list information, click the "OK" button to save the changes and return to the "Sample Analysis" screen.

■ Cancel

If you do not want to save the entered work list information, click the "Cancel" button to return to the "Analysis" screen without saving the changes.

● **Entering sample ID only**

When the way to enter patient demographic information is set to "Enter sample ID only", click "Next Sample" at the sample analysis screen, the following dialog box will display.

A screenshot of a dialog box titled "Next Sample". It features a light blue background and a dark blue header bar with the title. Below the header, the text "Sample ID" is followed by a red asterisk and a white rectangular input field. Underneath the input field, the text "* Required field" is displayed. At the bottom of the dialog, there are two dark blue buttons with white text: "OK" on the left and "Cancel" on the right.

Enter the sample ID in the "Sample ID" box. Click "OK" to save the ID and close the dialog box, the ID will be displayed on the screen as the next sample ID.

2) Selecting mode

Make sure the analyzer indicator is green. Select whole blood (CBC+DIFF or CBC), capillary whole blood (CBC+DIFF or CBC), or pre-diluted (CBC+DIFF or CBC) mode based on your needs on the mode selection screen. The selected mode will be displayed at the bottom of the screen.

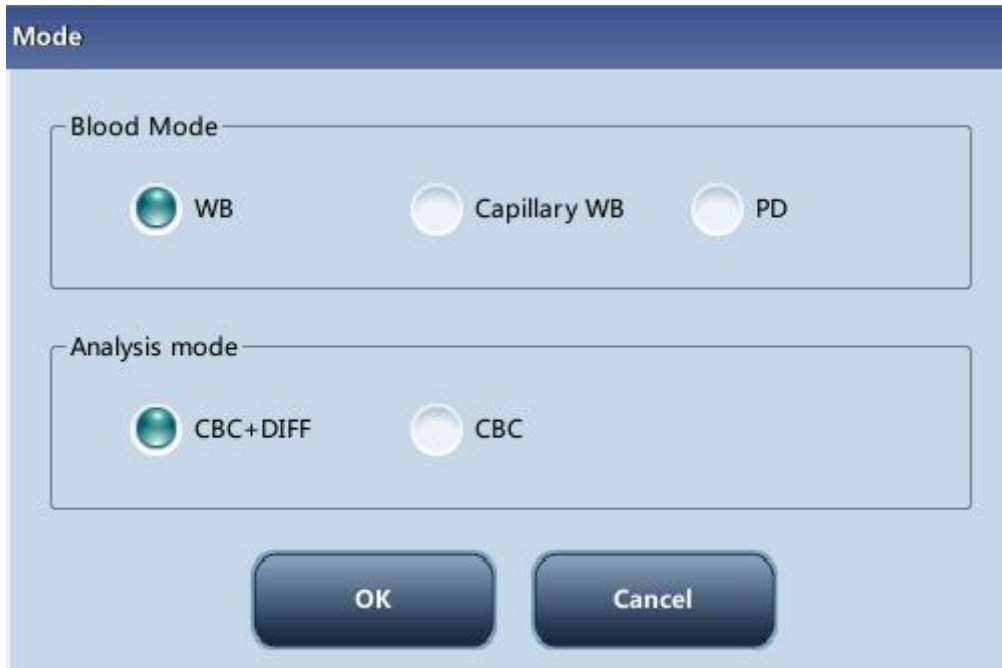

3) Aspirate sample

Present the sample to the sample probe. Press the aspirate key to start the analysis.

4) Remove the sample

The sample probe will automatically aspirate sample. When you hear the beep sound, you may remove the sample.

5) Auto analysis and result reporting

The analyzer will automatically run the sample. When the analysis is finished, the results will be displayed on the screen.

Parameter	Result	Unit	Parameter	Result	Unit
WBC	6.01	10 ⁹ /L	RBC	4.57	10 ¹² /L
Neu#	3.26	10 ⁹ /L	HGB	146	g/L
Lym#	2.39	10 ⁹ /L	HCT	0.467	
Mon#	0.14	10 ⁹ /L	MCV	H 102.2	fL
Eos#	0.21	10 ⁹ /L	MCH	31.9	pg
Bas#	0.01	10 ⁹ /L	MCHC	L 312	g/L
Neu%	0.541		RDW-CV	0.137	
Lym%	0.397		RDW-SD	49.7	fL
Mon%	L 0.024		PLT	132	10 ⁹ /L
Eos%	0.036		MPV	H 12.1	fL
Bas%	0.002		PDW	16.7	
			PCT	1.59	mL/L
			P-LCC	54	10 ⁹ /L
			P-LCR	40.7	%

NOTE

- During the analysis process, if errors like clog or bubble occur, the analyzer will automatically display the results of related parameters as invalid, and alarm information will show on the error information area. See Chapter 11 Troubleshooting Your Analyzer for the way to remove errors.
- If the ambient temperature is outside the specified operating range, thus causing the analyzer temperature (the temperature tested by the sensor inside the analyzer) goes out its specified range, the analyzer will alarm you for abnormal ambient temperature and the analysis results may be unreliable. See Chapter 11 Troubleshooting Your Analyzer for solutions.

5.5.3.Processing Analysis Results

1) Automatic saving of analysis results

This analyzer automatically saves sample results. When the maximum number of results that can be saved has been reached (40,000 records), the newest result will overwrite the oldest.

2) Printing and Transmission to LIS

If "Auto print after sample analysis" function is enabled, the analyzer will print reports automatically; and if "Auto comm." function is enabled, the analysis results, sample and patient information will be auto transmitted to LIS.

3) Parameter flags

See the following section for details about parameter flags.

- If the parameter is followed by a "H" or "L", it means the analysis result has exceeded the upper or lower limit of the reference range (See Section 9.2.4 Ref. range).
- If the parameter is followed by an "R", it means the analysis result is questionable.
- If you see "*****", as opposed to the result, it means the result is invalid; if you see "+++++" as opposed to the result, it means the result is out of the display range (See Table 6-1 Display Range for details).

Table 5-1 Display Range

Parameter	Display Range
WBC, Bas#, Neu#, Eos#, Mon#, Lym#, ALY#, LIC #	0.00 ~ 999.99×10 ⁹ /L
Bas%, Neu%, Eos%, Mon%, Lym%, ALY%, LIC %	0.0 ~ 99.9 %
RBC	0.00 ~ 18.00 ×10 ¹² /L
HGB	0 ~ 300 g/L
HCT	0.0 ~ 80.0 %
MCV	0.0 ~ 250.0 fL
MCH	0.0 ~ 999.9 pg
MCHC	0 ~ 9999 g/L
RDW-SD	0.0 ~ 999.9 fL
RDW-CV	0.0 ~ 99.9 %
PLT	0 ~ 9999×10 ⁹ /L
PDW	0.0 ~ 99.9
MPV	0.0 ~ 99.9 fL
PCT	0.0 ~ 0.999 %
P-LCC	0 ~ 9999×10 ⁹ /L
P-LCR	0.0 ~ 99.9 %

4) Flags of Abnormal Blood Cell Differential or Morphology

The following table lists all flags and their indications.

Table 5-2 Flags of Abnormal Blood Cell Differential or Morphology

Flag Type	Flag	Meaning	Judgment criterion
-----------	------	---------	--------------------

WBC Flag	WBC Abnormal	Interference of PLT clump or NRBC to WBC count and differential may exist:	The DIFF and BASO channels are unproportionate.
	Immature Cell?	Immature cells or blasts may exist	Many scatter-points in the immature cell area of the scattergram
	Abn./Atypical Lym?	Abnormal lymphocytes or atypical lymphocytes may exist.	Many scatter-points in the abnormal/ atypical lymphocytes area of the scattergram
	Leucopenia	Low WBC analysis results	$WBC < 2.50 \times 10^9/L$
	Leucocytosis	High WBC analysis results	$WBC > 18.00 \times 10^9/L$
	Neutropenia	Low neutrophils analysis results	$NEUT\# < 1.00 \times 10^9/L$
	Neutrophilia	High neutrophils analysis results	$NEUT\# > 11.00 \times 10^9/L$
	Lymphopenia	Low lymphocytes analysis results	$LYMPH\# < 0.80 \times 10^9/L$
	Lymphocytosis	High lymphocytes analysis results	$LYMPH\# > 4.00 \times 10^9/L$
	Monocytosis	High monocytes analysis results	$MONO\# > 1.50 \times 10^9/L$
	Eosinophilia	High eosinophils analysis results	$EO\# > 0.70 \times 10^9/L$
	Basophilia	High basophils analysis results	$BASO\# > 0.20 \times 10^9/L$
	Pancytopenia	WBC, RBC and PLT low	$WBC < 4.0 \times 10^9/L$ and $RBC < 3.5 \times 10^{12}/L$ and $PLT < 100 \times 10^9/L$
RBC Flag	RBC Histogram Abn.	Possible presence of microcytes, macrocytes, anisocytosis, RBC agglutination and dimorphic histogram	The distribution of RBC histogram is abnormal
	HGB Abn./Interfere?	HGB abnormal or RBC agglutination, or interference may exist (e.g., WBC high)	$MCHC > 380 \text{ g/L}$ or HGB interference
	Microcytosis	MCV low	$MCV < 70\text{fL}$
	Macrocytosis	MCV high	$MCV > 110\text{fL}$
	Anemia	Anemia	$HGB < 90\text{g/L}$
	Erythrocytosis	RBC high	$RBC > 6.5 \times 10^{12}/L$

PLT Flag	PLT Scattergram Abn.	Possible presence of microcytes, red blood cell debris, giant PLT or PLT clump	The distribution of PLT scattergram is abnormal
	Thrombopenia	PLT low	PLT < 60×10 ⁹ /L
	Thrombocytosis	PLT high	PLT > 600×10 ⁹ /L

5.6. Auto-Standby

When the time for which the analyzer is free from fluidic operations reaches that you have set at the "Setup" screen of the analyzer (default setting is 15 minutes), a dialog box will pop up, prompting "Entering standby status...".

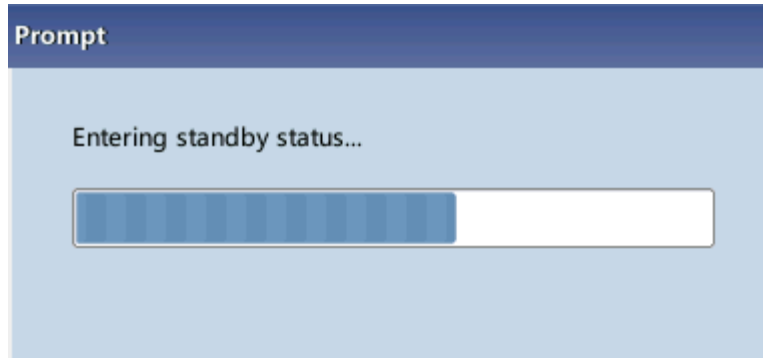

And the analyzer will prompt you to backup data.

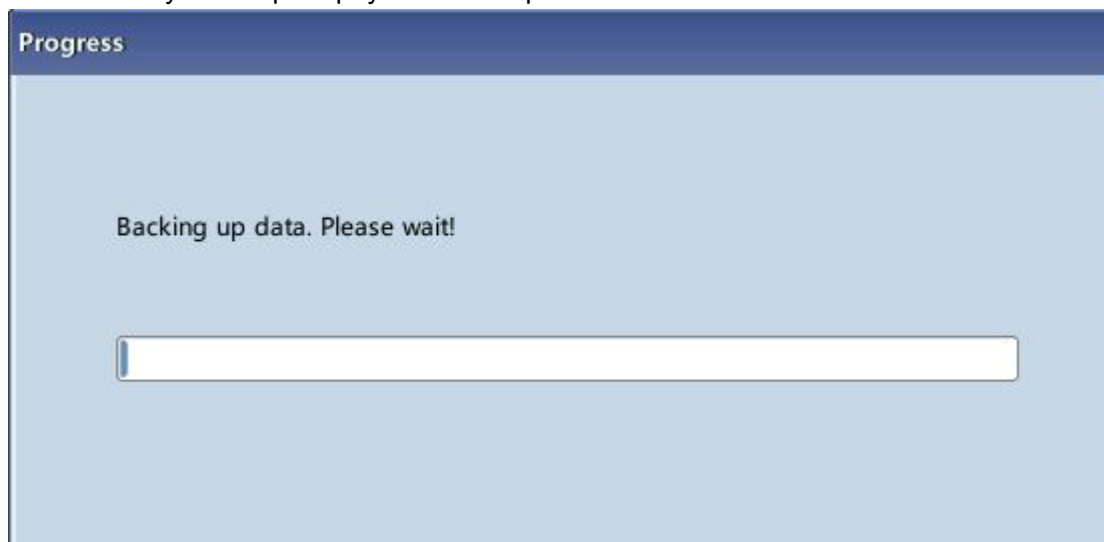

After entering standby status, the message " Standby. Press the aspirate key to exit. " will be displayed at the bottom left of the screen.

Standby. Press the aspirate key to exit.

Administrator : Admin

07-08-2013 15:53

NOTE

- The analyzer will not enter standby status from the Status screen.
- If it is time for auto-Standby and the analyzer is reporting error, then the error must be resolved first.
- During this condition, you can still perform any other operations (e.g., printing and transmission) other than fluidic operations.
- Refer to Section 9.2.5 Maintenance Setup for how to edit waiting time before entering standby mode.

- Under stand-by mode, if there are unfinished printing or communication tasks, the analyzer will go on processing them.
-

- Aspirate key

Press the aspirate key to exit the standby status.

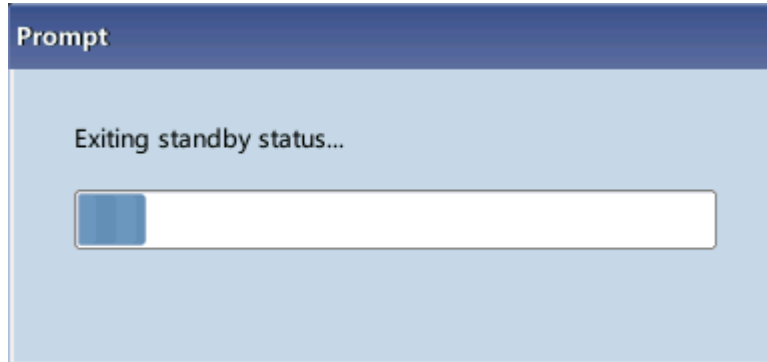

After the auto-Standby is canceled, the dialog box above will close automatically.

NOTE

- When exiting from the standby status, the analyzer will perform different maintenance operations based on the time consumed entering standby status.
 - If error occurs when the analyzer is exiting from the standby status, see Chapter 11 Troubleshooting Your Analyzer for solutions.
 - After exiting the standby status, the analyzer will resume its original status. The Analysis icon will turn into solid green. And the analyzer indicator will also turn into solid green.
-

5.7. Shutdown

⚠ CAUTION

- Do not start up the analyzer immediately after it is shut down. Wait for at least 10 seconds.
-

NOTE

- To ensure stable analyzer performance and accurate analysis results, be sure to perform the "Shutdown" procedure to shut down the analyzer after it has been running continuously for 24 hours.
-

Perform the shutdown procedure to shut down the analyzer daily.

1. Click the shutdown button on the menu and the following shutdown dialog box will display.



2. Click "OK".
 3. When dialog box prompting probe cleanser maintenance displays, present probe cleanser to the sample probe, press aspirate key. The probe will aspirate probe cleanser automatically.
 4. After shutting down finishes, the message "Please power off the analyzer!" will be displayed. Press the Power switch on back of the instrument to power off.
-

⚠ WARNING

- Be sure to dispose of reagents, waste, samples, consumables, etc. according to government regulations.
-

NOTE

- Do not disconnect power during the shutdown process.
 - If error that will affect shutdown occurs during the shutdown process, the analyzer will resume to its original status and report the error. See Chapter 11 Troubleshooting Your Analyzer for solutions.
-

6 Reviewing Sample Results

6.1. Introduction

The analyzer automatically saves analysis results. The BC-5150 can store up to 40,000 analysis results.

You can review all the analysis results, scattergrams and histograms either in table or graph mode.

6.2. Browsing in the "Table Review" mode

Operators can review, validate, search, edit and export saved results at the "Table Review" screen.

Tap "Table Review" to enter the following screen.

	3	4	5	6	7	8
Sample ID	Background	Background	0826-1	0826-2	0826-3	0826-4
Sample State						
WBC	0.03	0.02	6.21	6.05	6.01	5.93
Neu#			3.53	3.37	3.46	3.45
Lym#			2.01	2.00	1.89	1.87
Mon#			0.45	0.49	0.46	0.42
Eos#			0.21	0.19	0.19	0.18
Bas#			0.01	0.00	0.01	0.01
Neu%			0.567	0.557	0.576	0.581
Lym%			0.324	0.330	0.315	0.314
Mon%			0.073	0.080	0.076	0.072
Eos%			0.034	0.032	0.031	0.032

Pos./Total 9 / 18 Administrator : Admin 08-27-2013 12:37

6.2.1. Table

The table lists all analyzed samples, including basic sample information like sample ID, sample state and so on.

Reviewing Sample Results

	3	4	5	6	7	8	
Sample ID	Background	Background	0826-1	0826-2	0826-3	0826-4	▲
Sample State							
WBC	0.03	0.02	6.21	6.05	6.01	5.93	
Neu#			3.53	3.37	3.46	3.45	▲
Lym#			2.01	2.00	1.89	1.87	
Mon#			0.45	0.49	0.46	0.42	
Eos#			0.21	0.19	0.19	0.18	▼
Bas#			0.01	0.00	0.01	0.01	
Neu%			0.567	0.557	0.576	0.581	
Lym%			0.324	0.330	0.315	0.314	
Mon%			0.073	0.080	0.076	0.072	▼
Eos%			0.034	0.032	0.031	0.032	

◀ ◀ ▶ ▶ ▶ ▶

NOTE

- The table displays the latest sample results at the top.
-

6.2.2. Graph Review

Tap "Graph Review" button at the table review screen, or tap the "Previous" button at the analysis screen to view the analysis results of samples.

The screenshot displays a laboratory information system interface for reviewing sample results. At the top, there are navigation buttons: Menu, Sample Analysis, Table Review, QC, Reagent Setup, Diluent, and Print. Below these, the sample information is shown: Sample ID 0827-1, Name, Time 08-27-2013 09:22, Age, Mode WB-CBC+DIFF, and Gender. A table of parameters follows, with columns for Parameter, Result, and Unit. The table includes values for WBC, Neu#, Lym#, Mon#, Eos#, Bas#, Neu%, Lym%, Eos%, Bas%, RBC, HGB, HCT, MCV, MCH, MCHC, RDW-CV, RDW-SD, PLT, MPV, PDW, PCT, P-LCC, and P-LCR. Some values are highlighted in red (H 102.2, H 12.1) or blue (L 0.024, L 312). To the right of the table are message boxes for WBC, RBC, and PLT. Below the table are four histograms: LAS DIFF, WBC, RBC, and PLT. At the bottom, there are navigation buttons: Previous, Next, Other Para., Edit Result, Cancel validate, Special Info., and a back arrow. The status bar at the very bottom shows 'Pos./Total 13 / 18', 'Administrator : Admin', and '08-27-2013 12:32'.

Parameter	Result	Unit	Parameter	Result	Unit
WBC	6.01	10 ⁹ /L	RBC	4.57	10 ¹² /L
Neu#	3.26	10 ⁹ /L	HGB	146	g/L
Lym#	2.39	10 ⁹ /L	HCT	0.467	
Mon#	0.14	10 ⁹ /L	MCV	H 102.2	fL
Eos#	0.21	10 ⁹ /L	MCH	31.9	pg
Bas#	0.01	10 ⁹ /L	MCHC	L 312	g/L
Neu%	0.541		RDW-CV	0.137	
Lym%	0.397		RDW-SD	49.7	fL
Eos%	L 0.024		PLT	132	10 ⁹ /L
Bas%	0.036		MPV	H 12.1	fL
	0.002		PDW	16.7	
			PCT	1.59	mL/L
			P-LCC	54	10 ⁹ /L
			P-LCR	40.7	%

6.2.3.validate/Cancel validate (for administrators only)

- validate sample data

Select one or more sample records, tap "validate", the sample state of the record will be marked with "validated".

	13	14	15	16	17	18
Sample ID	0827-1	Background	0827-8	0827-9	0827-10	0827-11
Sample State	Validated		Validated	Validated	Validated	
WBC	6.01	0.03	L 1.12	L 2.23	L 1.87	L 0.21
Neu#	3.26		L 0.21	L 0.12	L 0.36	L 0.06
Lym#	2.39		L 0.04	L 0.05	L 0.14	L 0.02
Mon#	0.14		L 0.00	L 0.00	L 0.00	L 0.00
Eos#	0.21		H 0.87	H 2.06	H 1.37	0.13
Bas#	0.01		0.00	0.00	0.00	0.00
Neu%	0.541		L 0.182	L 0.053	L 0.193	L 0.273
Lym%	0.397		L 0.043	L 0.023	L 0.075	L 0.130
Mon%	L 0.024		L 0.000	L 0.000	L 0.000	L 0.000
Eos%	0.036		H 0.773	H 0.922	H 0.731	H 0.591

■ Cancel validate

Select one or more validated sample records, tap "Cancel validate", the "validated" will disappear.

6.2.4.Delete (for administrators only)

1. Select the sample record to be deleted.
2. Tap "Delete", the following dialog box will display.



3. Tap "OK" to delete the record, and the dialog box will be closed.

6.2.5. Edit info.

Click the desired sample result and it will be highlighted. Click the "Edit Info." button and the following dialog box will display.

The image shows an "Edit info." dialog box with the following fields:

- Sample ID: (marked with a red asterisk)
- First name:
- Date of Birth:
- Gender: (dropdown arrow)
- Department: (dropdown arrow)
- Patient Type: (dropdown arrow)
- Clinician: (dropdown arrow)
- Mode:
- Operator:
- Comments:
- Patient ID:
- Last name:
- Age: Years (dropdown arrow)
- Ref. group: (dropdown arrow)
- Bed No.:
- Draw time:
- Delivery time:
- Time:
- Validated by:

At the bottom of the dialog box are two buttons: "OK" and "Cancel".

You may edit the sample and patient information, and tap "OK" to save the change. The

information on the table review screen will be refreshed.

6.2.6. Edit results

Click the desired sample result and it will be highlighted. Click the "Edit Result" button and the following dialog box will display.

The "Edit Result" dialog box contains the following data:

Parameter	Value	Unit
WBC	4.50	10 ⁹ /L
Neu%	0.502	
Lym%	0.363	
Mon%	0.085	
Eos%	0.025	
Bas%	0.025	
RBC	4.37	10 ¹² /L
HGB	130	g/L
HCT	0.394	
PLT	188	10 ⁹ /L
RDW-CV	0.127	
RDW-SD	40.8	fL

Buttons: OK, Cancel, Restore

Modify the results and tap "OK" to save the changes. The information on the graph review screen will be refreshed.

6.2.7. Search

1. Tap "Search", the following dialog box will display.
-

Search

Not validated today Not printed today Not transmitted today

Sample ID

Patient ID

First name Last name

Date 02 - 18 - 2014 - 02 - 18 - 2014

Sample No.

Sample State Not validated Not printed Not transmitted

Auto select searched record

OK Cancel

2. Enter search conditions into the edit boxes or select them from the pull-down lists.
3. Tap "OK" to start search, the results will displayed in the table.

6.2.8.Print

- Print reports as per the default report template

Select sample records to be printed, and then tap "Print" to print them. In the table review interface, a 'printed' sign will be applied to each printed sample in the sample state sector.

	5	6	7	8	9	10
Sample ID	0826-1	0826-2	0826-3	0826-4	0826-5	0826-6
Sample State	Validated	Validated	Validated		Printed	
WBC	6.21	6.05	6.01	5.93	6.01	6.05
Neu#	3.53	3.37	3.46	3.45	3.52	3.48
Lym#	2.01	2.00	1.89	1.87	1.83	1.91
Mon#	0.45	0.49	0.46	0.42	0.46	0.47
Eos#	0.21	0.19	0.19	0.18	0.18	0.18
Bas#	0.01	0.00	0.01	0.01	0.02	0.01
Neu%	0.567	0.557	0.576	0.581	0.586	0.575
Lym%	0.324	0.330	0.315	0.314	0.304	0.315
Mon%	0.073	0.080	0.076	0.072	0.077	0.078
Eos%	0.034	0.032	0.031	0.032	0.030	0.030

Pos./Total 7 / 18 Administrator : Admin 08-27-2013 12:38

NOTE

- In sample state sector, 'Validated' sign is prior to 'Printed' sign.

6.2.9. Transmission

Transmit selected data

1. Select samples to be transmitted at the table review screen.
2. Tap "Comm.", the following dialog box will display.



-
3. Tap the "Selected" radio button.
 4. Tap "OK" to start transmitting specified results to the data management software.
-

Transmit all data

-
1. Tap "Comm.", the following dialog box will display.
 2. Tap the "All" radio button.
 4. Tap "OK" to start transmitting all results to the data management software.
-

6.2.10. Export

-
- 1 Tap "Export", the following dialog box will display.
-

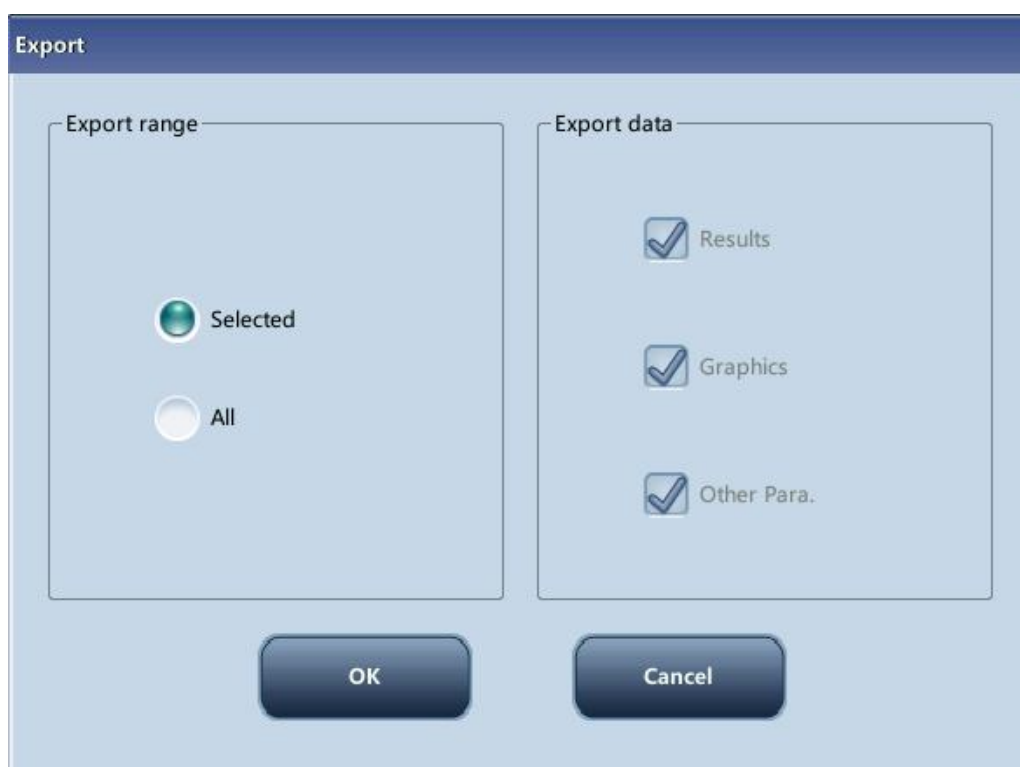

The image shows a software dialog box titled "Export". It is divided into two main sections: "Export range" and "Export data".

- Export range:** This section contains two radio buttons. The top one is labeled "Selected" and is currently selected, indicated by a blue dot. The bottom one is labeled "All" and is unselected.
- Export data:** This section contains three checked checkboxes, each with a blue checkmark icon:
 - Results
 - Graphics
 - Other Para.

At the bottom of the dialog box, there are two buttons: "OK" on the left and "Cancel" on the right.

-
- 2 Select "Selected" or "All" in the "Export range" area.
 - 3 Check the type of information to be exported in the "Export data" area.
-

7 Using the QC Programs

7.1. Introduction

Quality Control (QC) consists of strategies and procedures that measure the precision and stability of the analyzer. The results imply the reliability of the sample results.

QC involves measuring materials with known, stable characteristics at frequent intervals. Analysis of the results with statistical methods allows the inference that sample results are reliable. Mindray recommends you run the QC program daily with normal level controls.

A new lot of controls should be analyzed in parallel with the current lot prior to their expiration dates.

This may be accomplished by running the new lot of controls twice a day for five days using any empty QC files. The QC files calculate the mean, standard deviation and coefficient of variation for each selected parameter. The instrument-calculated means of these ten runs should be within the expected ranges published by the manufacturer. .

This analyzer provides 2 QC programs: L-J QC and X-B QC.



- All the samples, controls, calibrators, reagents, wastes and areas contacted them are potentially biohazardous. Wear proper personal protective equipment (e.g. gloves, lab coat, etc.) and follow safe laboratory procedures when handling them and the contacted areas in the laboratory.

WARNING

- Keep your clothes, hairs and hands away from the moving parts to avoid injury.
 - The sample may spill from the uncapped collection tubes and cause biohazard. Exercise caution to the uncapped collection tubes.
 - The reagents are irritating to eyes, skin and airway. Wear proper personal protective equipment (e.g. gloves, lab coat, etc.) and follow safe laboratory procedures when handling them and the contacted areas in the laboratory.
 - If reagents accidentally spill on your skin or in your eyes, rinse the area with ample amount of clean water; seek medical attention immediately.
-

⚠ CAUTION

- Running QC sample with error present will lead to unreliable results. If errors are reported during QC analysis, remove the errors first and then continue with the analysis.
 - Do not reuse disposable products such as collection tubes, test tubes, capillary tubes and so on.
 - Sample agglutination may result in inaccurate analysis results. Check the control samples to see if there is any agglutination, if yes, process the samples according to your laboratory's protocols.
-

NOTE

- Use the controls and reagents specified by the manufacturer only. Store and use the controls and reagents as instructed by their instructions for use. Store and use the controls and reagents as instructed by instructions for use of the controls and reagents.
 - Refer to the instructions for use of the control for its use and storage.
 - Be sure to mix any control sample that has been prepared for a while before running it.
 - Be sure to use the Mindray-specified disposable products including evacuated blood collection tube, anticoagulant collection tubes and capillary tubes etc.
-

7.2.L-J QC

7.2.1.Editing L-J settings (for administrators only)

Before running a new lot of controls, you must set up a QC file for each lot of controls.

- 1 Tap the menu option "QC" > "L-J QC" > "Setup".
- 2 Enter the L-J QC setup screen.

File No.	Lot No.	Level	Exp. Date	Mode	Control type	QC Sample ID	Data/Capacity
1*	ddd	Normal	09-09-2013	WB	B55	hj	0/100

WB Administrator : Admin 07-08-2013 16:21

You may set up QC information by any of the following two ways.

- Reading the information provided by the manufacturer
- Manual Entry

Reading the information provided by the manufacturer

1. Enter the L-J QC setup screen.
2. Tap "New", or select a QC file without QC results, and then tap "Edit".
3. Tap "Import File".

The screenshot shows the QC program interface with the following elements:

- Navigation Bar:** Menu, Sample Analysis, Table Review, QC, Reagent Setup, Diluent, Print.
- Form Fields:**
 - Lot No. (text input)
 - Level (dropdown menu: Normal)
 - Exp. Date (text input: MM-DD-YYYY)
 - Mode (dropdown menu: WB)
 - Control type (dropdown menu: Mindray)
 - QC Sample ID (text input)
- Table:**

Parameter	Target	Limit(#)	Parameter	Target	Limit(#)
WBC			HGB		
Neu#			HCT		
Lym#			MCV		
Mon#			MCH		
Eos#			MCHC		
Bas#			RDW-CV		
Neu%			RDW-SD		
Lym%			PLT		
- Buttons:** Import File, Set Limits, Return.
- Status Bar:** File No. 2, WB, Administrator: Admin, 07-09-2013 13:54.

4. Select the QC file to be imported.
5. Tap "OK" to close the dialog box and return to the L-J QC setup screen.
6. Tap "OK" to read the selected QC information to the current QC file.

NOTE

- The "Import target/limits" check box is selected by default. If it is deselected, the operator must enter the target and limits of QC parameters manually.

8. Select "Control type" from the pull-down list.
9. Select the QC mode.
10. Set QC sample ID: if you are used to analyze control together with blood samples, you can set a unique ID for the control. The analyzer will recognize the sample as control when it reads the unique ID. After the analysis completes, the results will be saved into the QC file of the QC sample ID.
11. Tap other icons to switch screen and save the QC information.

Manual Entry

1. Enter the L-J QC setup screen.
2. Tap "New", or select a QC file without QC results, and then tap "Edit".

3. Enter the lot No. of the controls in the edit box manually.

The screenshot shows the QC program interface with the following fields and values:

- Lot No.: BC304N
- Level: Normal
- Exp. Date: 07 - 05 - 2013
- Mode: WB
- Control type: Mindray
- QC Sample ID: 1

Parameter	Target	Limit(#)	Parameter	Target	Limit(#)
WBC	8.48	0.20	HCT	0.389	0.050
Neu#	5.44	0.15	MCV	90.0	3.0
Lym#	1.64	0.20	MCH	30.0	3.0
Mon#	0.43	0.10	MCHC	335	10
Eos#	0.51	0.10	RDW-CV	0.167	0.040
Bas#	0.46	0.10	RDW-SD		
Neu%	0.642	0.100	PLT		
Lym%	0.193	0.050	MPV		

Buttons: Import File, Set Limits

File No. 1 WB Administrator : Admin 07-08-2013 16:22

NOTE

- The lot No. shall not be empty and up to 16 digits can be entered. You can enter characters, numbers, letters and special characters.

4. Select the control level.
5. Enter the expiration date of the lot
6. Select the control type.
7. Select the QC mode.
8. Set QC sample ID: if you are used to analyze control together with blood samples, you can set a unique ID for the control. The analyzer will recognize the sample as control when it reads the unique ID. After the analysis completes, the results will be saved into the QC file of the QC sample ID.
9. Enter the target and limits in the edit boxes according to the package insert of the lot of controls.
10. Tap other icons to switch screen and save the QC information.

Setting limits

You can adjust the format of limits as per the following procedure:

1. Tap "Set Limits".

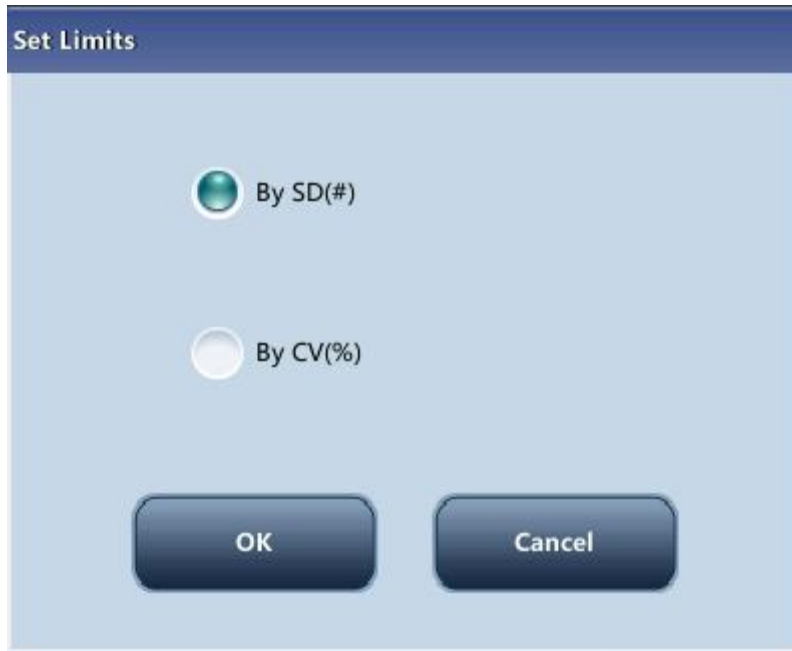

2. Click "By SD" to display the limits in the form of absolute value;
Or click "By CV" to display the limits in the form of percentage.
 3. Click the "OK" button to save the settings.
-

7.2.2 L-J QC Run

You can select one of the two ways below to run controls:

Run controls under the "QC" screen.

Put controls together with normal samples, and run the controls under the sample analysis screen.

7.2.3 Run controls under the "QC" screen

After editing the QC information, you can start QC analysis by one of the following ways according to the selected QC mode.

- Whole blood
- Pre-diluted

⚠ CAUTION

- Running QC sample with error present will lead to unreliable results. If errors are reported during QC analysis, remove the errors first and then continue with the analysis.
-

- Sample agglutination may result in inaccurate analysis results. Check the control samples to see if there is any agglutination, if yes, process the samples according to your laboratory's protocols.

NOTE

- When switching mode from "Pre-diluted" to "Whole Blood", a progress bar will be displayed while the analyzer runs mode switching sequence.

1. Tap "QC" > "L-J QC" > "Count" to enter the QC count screen.

2. **NOTE**

- Be sure that the level of the control to be run is the same with the current QC file, and the control is not expired.
- The expiration date of expired controls is displayed in red.

3.

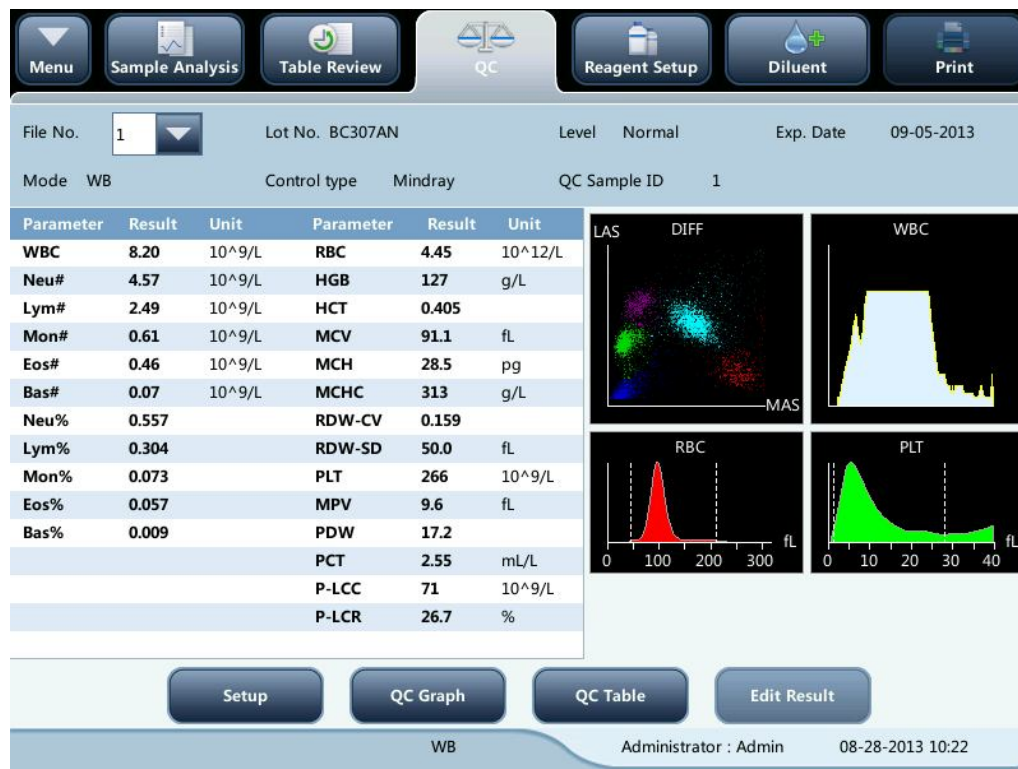

4. Prepare the control as instructed by instructions for use of the controls.

5. Run QC analysis:

- 1) Make sure the analysis mode is "Whole Blood" or "Pre-diluted" and the indicator of the analyzer is green.
- 2) Shake the vial of sample as instructed by instructions for use of the control to mix the sample thoroughly.

- 3) Present the control sample to the sample probe. Press the aspirate key to start QC run.
 - 4) When you hear the beep, remove the control.
-
6. When analysis finishes, the QC results will be displayed in the current screen and be saved in the QC file automatically.
-

NOTE

- Up to 100 QC results can be saved in each QC file.
-

7. Do the above procedures to continue running QC analysis if necessary.
-

Put controls together with normal samples, and run the controls under the sample analysis screen.

After setting special "QC Sample ID" for a control under the QC setup screen, you can put the control together with normal samples, and run it under the "Count" screen.

When editing worklist or entering next sample information in the "Next Sample" dialog box before daily analysis, enter the special "QC Sample ID" as "Sample ID".

Based on the QC mode selected, you can choose to run QC analysis from one of the following ways:

- Whole blood
- Pre-diluted

-
1. Prepare the control as instructed by instructions for use of the controls.
-
2. Refer to section 5.5.1 Sample Collection and Handling for sample preparation under whole blood and pre-diluted modes.
-
3. When it is ready to run a sample (i.e. the status icon and the analyzer indicator is green), present the sample to the sample probe.
-
4. When you hear the beep, remove the control.
-
5. When analysis finishes, the QC results will be displayed in the current screen and be saved in the QC file automatically.
-

NOTE

- Up to 100 QC results can be saved in each QC file.
-

6. Do the above procedures to continue running QC analysis if necessary.
-

NOTE

- When switching mode from "Pre-diluted" to "Whole Blood", a progress bar will be displayed while the analyzer runs mode switching sequence.
-

Editing and saving results (for administrators only)

Tap "Edit Result" on the QC screen to edit results and tap "OK" to save the edited results. The edited results will be marked with an "E".

Restore results (for administrators only)

Operators of administrator access level can restore the edited results to the original measurement results.

1. Tap "Restore" on the edit result screen.
 2. Tap "OK" to restore the measurement values.
 3. Tap "OK" to close the dialog box.
-

7.2.3 Reviewing L-J Results

After QC analysis, you can review the QC results in the following ways:

QC Graph

- QC Table

L-J QC graph review

1. Tap "Graph" button on the "L-J QC" screen to enter the L-J QC graph screen.
-



2. You can tap the arrow buttons on the right of the graph to browse graphs of the parameters. You can tap the arrow buttons under the graph horizontally to browse all the QC results.

NOTE

- If a parameter target/limits of the QC files with QC results are modified and saved, and the targets/limits of other parameters changes accordingly, those changed data will be highlighted in yellow.

Print

Tap the "Print" icon in the status bar to print information of the current QC file and the QC graph of all parameters.

NOTE

- The green vertical line and values of the corresponding QC points will not be printed.

L-J QC table review

1. Tap "Table" button on the "L-J QC" screen to enter the L-J QC table screen.

File No.	1	Lot No.	BC304N	Level	Normal	Exp. Date	07-05-2013	
Mode	WB	Control type	Mindray	QC Sample ID	1			
	Date	Time	WBC	Neu#	Lym#	Mon#	Eos#	Bas#
Target	/	/	8.48	5.44	1.64	0.43	0.51	0.46
Limit(#)	/	/	0.20	0.15	0.20	0.10	0.10	0.10
*5	07-04-2013	16:50	8.41	5.46	1.52	0.38	0.56	0.49
4	07-04-2013	16:46	8.31	5.43	1.51	L 0.32	0.57	0.48
3	07-04-2013	16:40	8.45	5.47	1.58	0.42	0.49	0.49
2	07-04-2013	16:39	8.50	5.55	1.54	0.42	0.52	0.47
1	07-04-2013	16:38	8.53	5.58	1.58	0.37	0.54	0.46

Pos./Total 5/5 WB Administrator : Admin 07-05-2013 14:19

2. You can tap the arrow buttons on the right of the graph to browse all QC records. You can tap the arrow buttons under the graph horizontally to browse all the parameter results.

NOTE

- If a parameter target/limits of the QC files with QC results are modified and saved, and the targets/limits of other parameters changes accordingly, those changed data will be highlighted in yellow.

Delete (for administrators only)

1. Tap "Delete", the following dialog box will display.



-
2. Tap "Yes" to delete the selected records.
-

NOTE

- The operation will be recorded in the system log.
-

Print

You can tap the "Print" icon in the status bar to print the QC table.

Transmission

To transmit QC data to external data management software or HIS/LIS/HIS, do as follows:

1. Tap "Comm.", the following dialog box will display.



-
2. Select to transmit "Selected" or "All" records.
 3. Tap "OK" to start transmitting specified results to the data management software.
-

NOTE

- If auto-communication is enabled and a sample is run during the transmission of the QC data, then only when the QC data transmission finished will the auto-communication of the sample result start.
 - The QC data saved in the process of transmission will not be transmitted.
-

Export

To Export QC information and results of the current QC file, do as follows:

1. Insert an USB and then tap "Export".
 2. The system will detect the USB and export data automatically.
 3. The prompt "Export succeeded!" will display.
-

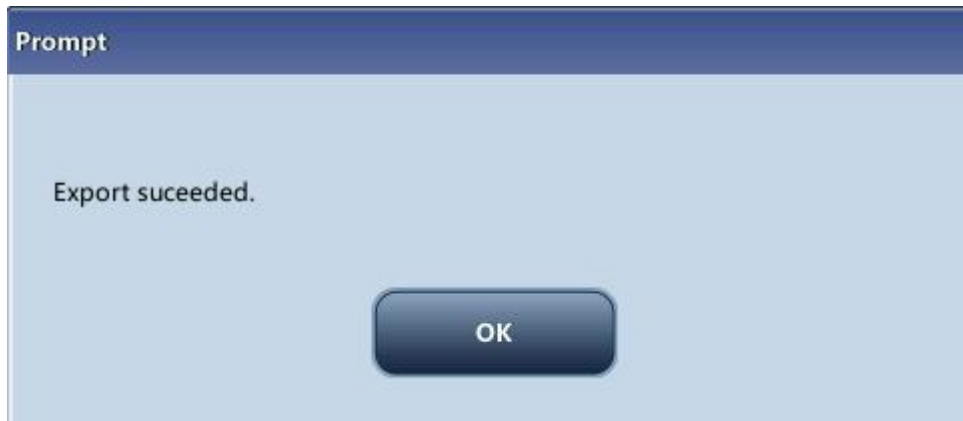

7.3. X-B QC Program

7.3.1 Introduction

The X-B analysis is a weighted moving average analysis that uses values obtained from patient samples. It uses the 3 red cell indices, MCV, MCH and MCHC to indicate the hematology instrument performance.

It is recommended the X-B analysis be activated when the sample volume of your laboratory is greater than 100 samples per day. Effective use of X-B requires randomization of samples and a normal cross section of patients to prevent skewing of indices. It observes the trend of QC results in the reference range formed by the specified target and limits.

The analyzer implement X-B QC on the 3 parameters: MCV, MCH and MCHC, each group of samples for X-B analysis consists of 20-200 sample results obtained from normal analysis of both WB and PD modes. The analyzer can save up to 500 X-B QC results. When the saved QC results have reached the maximum number, the newest result will overwrite the oldest.

7.3.2 Editing X-B settings (for administrators only)

1. Click the menu option "QC" - "X-B QC" - "Setup", the following screen will display.

X-B QC

X-B QC On Off

Samples/Batch [20, 200]

Target/Limits Setup

Parameter	Target	Limit(#)
MCV	89.5	2.7
MCH	30.5	0.9
MCHC	340	10

Sample Validity Setup

Parameter	Lower Limit	Upper Limit
RBC	1.00	8.00
MCV	50.0	150.0
MCH	20.0	40.0
MCHC	240	440

Restore Defaults Set Limits

WB Administrator : Admin 07-08-2013 16:26

At the X-B QC setting screen, you may activate/deactivate X-B QC, set target/limits, and configure the sample validity setup.

Editing X-B settings

1. In the “Sample number/group” edit box, you may enter the amount of samples [within the range 20(default) to 200] to be included in calculating for an X-B QC point.
 2. Activate/deactivate X-B QC If X-B QC is activated, the samples meeting validity requirements will be included in X-B QC.
-

Set target/limits

Before the X-B QC analysis, you shall set up the target and limit for each parameter at the X-B QC setup screen.

NOTE

- The units of target/limits of all parameters are the same as those in the parameter unit setup screen.
-

1. In the “Target/Limit” area of the X-B QC setup screen, specify the targets and limits in the “Target/Limit” table by entering manually.
-

NOTE

- Do not leave any of the targets and limits for the QC parameters blank.
 - When first use, the default setting will provide the initial values for the targets and limits of all QC parameters.
-

2. Tap other icons to switch screen and save the settings.
-

Setting sample validity

In X-B QC, sample results conforming to any of the following conditions will be considered as invalid and cannot be used in the QC calculation.

- Sample results exceeding the linearity range;
 - Background results;
-

- Sample results not conforming to the "Sample Validity Setup";
- QC data for QC programs other than X-B;
- Calibration data;
- Results generated while there are errors which could affect the accuracy of the results (insufficient aspiration volume or clogging for example).

"Sample Validity Setup" is to set up the ranges of valid RBC, MCV, MCH and MCHC results. Only when the results of all these four parameters are within the specified ranges, the sample results can be used for X-B QC calculation. Do as follows to set the sample validity:

1. Select "On" to activate X-B QC.

In the "Sample Validity Setup" of the X-B QC setup screen, set the upper and lower limits of the 4 parameters in the sample validity setup area.



The default validity range of each parameter is shown in the following figure.

Sample Validity Setup	Parameter	Lower Limit	Upper Limit
	RBC	1.00	8.00
	MCV	50.0	150.0
	MCH	20.0	40.0
	MCHC	240	440

2. Tap "Save" to save the setup.



NOTE

- In the sample validity setup, the upper limit shall be no smaller than the lower limit. Otherwise, there will be prompted message asking you to revise.
 - The valid ranges of the RBC parameters are their linearity ranges; the valid ranges of other parameters are their display ranges.
 - All the entries shall be numbers with only one decimal point. The length of the number entered cannot be longer than the length of the text box.
 - Once the validity range is changed, the previous results will not be used in the QC calculation as valid results. For example, if 20 valid samples are needed for the X-B QC calculation, when you change the validity range after 10 groups of valid sample results have been acquired, these 10 groups of results will be discarded, and only valid sample results generated afterwards will be used in the QC calculation.
 - The units of lower and upper limits of all parameters are the same as those in the parameter unit setup screen. See section 9.2.4 Setup - *Parameter Unit Setup*.
-

Setting limits

You can adjust the format of limits as per the following procedure:

1. Tap "Set Limits".

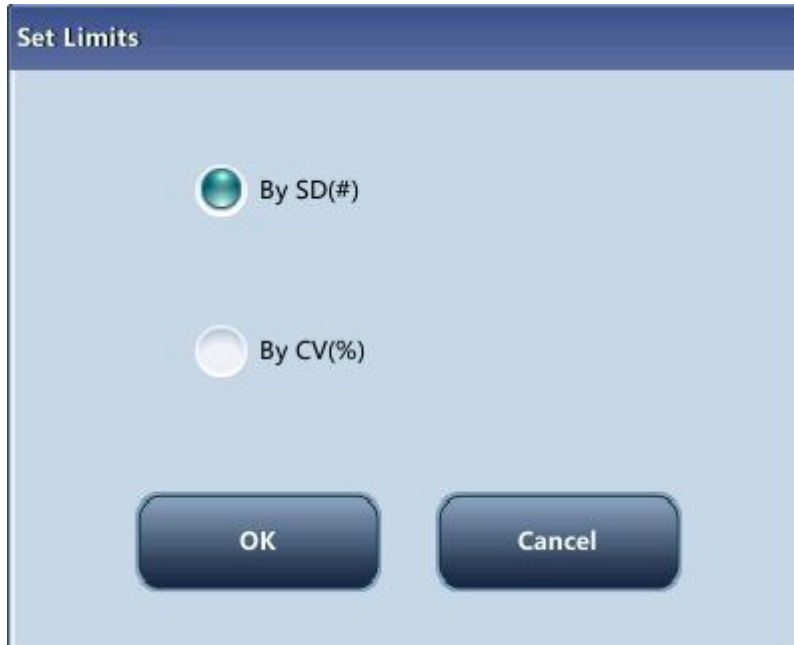

2. Click "By SD" to display the limits in the form of absolute value;
Or click "By CV" to display the limits in the form of percentage.
3. Click the "OK" button to save the settings.

Restore defaults

If you want to restore the default targets and limits of the parameter, tap "Restore Defaults".

The default values of the target and limits of each parameter are as follows:

Parameter	Target	Limits (#)
MCV	89.5	2.7
MCH	30.5	0.9
MCHC	340	10

7.3.3 X-B QC Run

After editing X-B setup, the system will start X-B run automatically.

After every 20~200 results (determined by the setting) are obtained, the system will perform the X-B calculation once automatically. You can review the result in X-B QC graph or X-B QC table.

7.3.4 Reviewing X-B Results

After QC analysis, you can review the QC results in the following ways:

- QC Graph
- QC Table

X-B QC graph review

1. Click the menu option "QC" > "X-B QC" > "Graph", the following screen will display.



2. Select QC file No., the information of the file and the QC graph will be displayed on the screen.
3. You can tap the arrow buttons under the graph horizontally to browse all the QC results.

X-B QC table review

1. Enter the X-B QC graph screen.
2. Tap "Table" button to enter the X-B QC table screen.

	Date	Time	MCV	MCH	MCHC
Target	/	/	89.5	30.5	340
Limit(#)	/	/	2.7	0.9	10
*5	07-08-2013	16:33	89.8	H 31.8	H 355
4	07-05-2013	16:25	H 96.9	H 36.4	H 356
3	07-05-2013	14:39	L 86.7	H 32.4	H 356
2	07-05-2013	11:18	92.1	H 33.3	H 356
1	07-04-2013	17:19	H 92.6	H 33.3	H 356

Pos./Total 5/5 WB Administrator : Admin 07-08-2013 16:54

3. You can tap the arrow buttons on the right of the graph to browse all QC records.

The delete, print and export operations can all be performed same as stated in the L-J QC table review section.

8 Calibrating Your Analyzer

8.1. Introduction

Calibration is a procedure to standardize the analyzer by determining its deviation under certain specified conditions. In order to get accurate sample analysis results, you should calibrate the analyzer per the procedure below when necessary.

There are three calibration programs available on this analyzer: manual calibration, auto calibration using calibrators and auto calibration using fresh blood samples.

All the parameters or part of the parameters of WBC, RBC, HGB, MCV and PLT can be calibrated by the calibration programs.



- All the samples, controls, calibrators, reagents, wastes and areas contacted them are potentially biohazardous. Wear proper personal protective equipment (e.g. gloves, lab coat, etc.) and follow safe laboratory procedures when handling them and they contacted areas in the laboratory.

▲WARNING

- The reagents are irritating to eyes, skin and airway. Wear proper personal protective equipment (e.g. gloves, lab coat, etc.) and follow safe laboratory procedures when handling them and they contacted areas in the laboratory.
- If reagents accidentally spill on your skin or in your eyes, rinse the area with ample amount of clean water; seek medical attention immediately.
- Keep your clothes, hairs and hands away from the moving parts to avoid injury.
- Be sure to dispose of reagents, waste, samples, consumables, etc. according to government regulations.

▲CAUTION

- Do not reuse disposable products such as collection tubes, test tubes, capillary tubes and so on.

NOTE

- Be sure to use the Mindray-specified disposable products including evacuated
-

blood collection tube, anticoagulant collection tubes and capillary tubes etc.

- Calibration procedures can only be performed by users of the administrator-level.
 - Use the calibrators and reagents specified by the manufacturer only. Store and use the calibrators and reagents as instructed by their instructions for use.
 - The analyzer identifies a sample as a calibration sample only if the analysis is started from the "Calibration" screen.
 - Calculation of reproducibility is included in the calibration procedure.
-

8.2. When to Calibrate

This analyzer is calibrated at the factory just before shipment. It is electronically stable and does not require frequent recalibration if you operate and maintain it as instructed by this manual. You only need to recalibrate this analyzer if:

- you are going to use this analyzer for the first time (usually done by a Mindray-authorized representative when installing the analyzer).
- an analytical component has been changed.
- you are going to re-use the analyzer after a long-term storage.
- the quality control results indicate there may be a problem.
- use environment changes significantly.

NOTE

- All of the measured parameters must be calibrated before readings of this analyzer can be used as valid analysis results.
-

8.3. How to Calibrate

8.3.1 Preparing Your Analyzer

Do the following pre-calibration procedures before calibration. If problems are detected during these checks, do not attempt to calibrate the analyzer. If necessary, call Mindray Customer Service Department or your local distributor for assistance.

1. Check and make sure enough reagents have been prepared for the calibration. You need to start over the calibration if the reagents run out during the process.
2. Check the background (for calibration right after startup) or blank count results. If the analyzer alarms for abnormal background results, see Chapter 11 Troubleshooting for solutions. (see Appendix B Specifications for the background range).

Run a vial of normal control consecutively for 10 times under Whole Blood -CBC+DIFF mode. Enter the "Table" review screen to check the reproducibility of the 10th runs and make sure they meet the following requirements.

Parameter	Range	Whole Blood Reproducibility (CV)	Pre-diluted Reproducibility (CV)
WBC	$4.00 \times 10^9 / L \sim 15.00 \times 10^9 / L$	$\leq 2.0\%$	$\leq 4.0\%$
RBC	$3.50 \times 10^{12} / L \sim 6.00 \times 10^{12} / L$	$\leq 1.5\%$	$\leq 3.0\%$
HGB	110 g/L ~ 180 g/L	$\leq 1.5\%$	$\leq 3.0\%$
MCV	70 fL ~ 120 fL	$\leq 1.0\%$	$\leq 2.0\%$
PLT	$100 \times 10^9 / L \sim 149 \times 10^9 / L$	$\leq 6.0\%$	$\leq 10.0\%$
	$150 \times 10^9 / L \sim 500 \times 10^9 / L$	$\leq 4.0\%$	$\leq 8.0\%$

4. It is recommended that you create a log table for your analyzer. This log table should contain all necessary information that is pertinent to your analyzer. Suggested items that you may want to include in the log table are: calibration date, supplier of calibrator, lot number, expected results and limits, and result of background check.

NOTE

- Be sure to use the evacuated collection tubes recommended in the Appendix.
- If fresh blood samples are used for reproducibility test, make sure the sample volume is enough to support the test.

8.3.2 Manual Calibration

Tap "Calibration" > "Manual" in the menu to enter the following screen.



NOTE

- If you log in at the operator access level, you can only view the calibration factors. To perform calibration, please log out and then log in at the administrator access level.

Do as follows to calibrate the analyzer.

1. At the "Manual" calibration screen, check the calibration factors and calculate the new factors per the following equation:

$$new\ factor = \frac{old\ factor \times reference\ value}{calculated\ mean}$$

For example: Suppose the WBC reference value of a calibrator is 8.4, and the current calibration factor of the whole blood mode is 98.90%.

Run the calibrator under the whole blood mode for 11 consecutive times and take the WBC results of the 2nd to 11th runs to calculate: 8.1, 8.0, 8.1, 8.1, 8.3, 8.3, 8.2, 8.0, 8.1, 8.3. The obtained CV is 1.5% and Mean is 8.16, which meet the requirements.

The new calibration factor is obtained:

$$\text{New factor} = \frac{98.90\% \times 8.4}{8.16} = 101.81\%$$

The calculated calibration factors shall be between 75.00%~125.00%. In case of an invalid calibration factor, try to find out the reason (e.g. calibration material not thoroughly mixed, misoperation, etc.). Then recalibrate the analyzer and recalculate the calibration factors.

2. Enter the new calibration factors into the factor cell of the parameter that requires calibration.

3. When you switch screen after entering the new calibration factor, a prompt will display.

If the entered calibration factors are valid, a dialog box will pop up asking you to save the new factor when you are exiting the screen. And the calibration date of the corresponding parameter changes to current system date.

If the entered calibration factors are invalid, a dialog box will pop up prompting "Invalid entry" when you are switching to another screen. The new calibration factor will not be saved, and the calibration date will not be refreshed.

Other Operations

Print

Tap "Print" to print the current calibration factor.

If the calibration factors are invalid, you will not be able to print them and the dialog box "New calibration factor is invalid." will display.

If the calibration factors are valid but not saved, a dialog box will display asking you to save the factors.

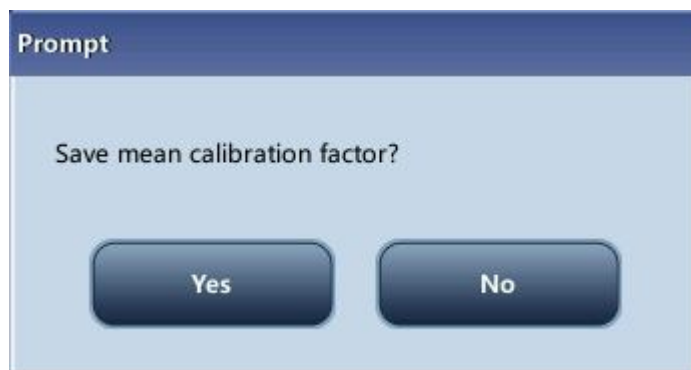

Click "Yes" to save and print the factors. Or click "No" to cancel the operation without saving or printing them.

8.3.3 Calibration with Calibrator

Tap "Calibration" > "Calibrator" in the menu to enter the following screen.

	Select	WBC	RBC	HGB	MCV	PLT
Target						
1						
2						
3						
4						
5						
6						
7						
8						
9						
10						
Mean						
CV(%)						
New Factor (%)						
Old Factor (%)		100.00	100.00	100.00	100.00	100.00

Mode: WB-CBC+DIFF Administrator: Admin 07-08-2013 15:42

NOTE

- The calibrator calibration can be performed under Whole Blood -CBC+DIFF, Whole Blood -CBC, pre-diluted -CBC+DIFF and pre-diluted -CBC mode.
- Only Mindray-specified calibrators shall be used. Mindray will not be responsible for any erroneous result caused by using other calibrators.
- See the instruction for use of the calibrators for the lot No., expiration date and the target.
- The out-of-range CV% does not influence the display of calibration factors.

Do as follows to calibrate the analyzer with calibrators.

1. Check the mode on the analyzer screen.
2. Enter the lot No. of the calibrator into the "Lot No." box.
3. Enter the "Expiration date". The entered expiration date should be either the expiration date printed on the labeling or the open-container expiration date, whichever is earlier. The open-container expiration date is calculated as follows: the date that container is opened + the open-container stability days.
4. Enter the targets into the "Target" cells.
5. Prepare the calibrator as instructed by instructions for use of the calibrators.

6. Press the aspirate key to start calibration.

After the analysis, the analyzer will have different responses to different analysis results.

When the current running is done, if there is a parameter whose calibration data is out of its linearity range but still within the display range, then the calibration data will be displayed in the list and a message box will also pop up.

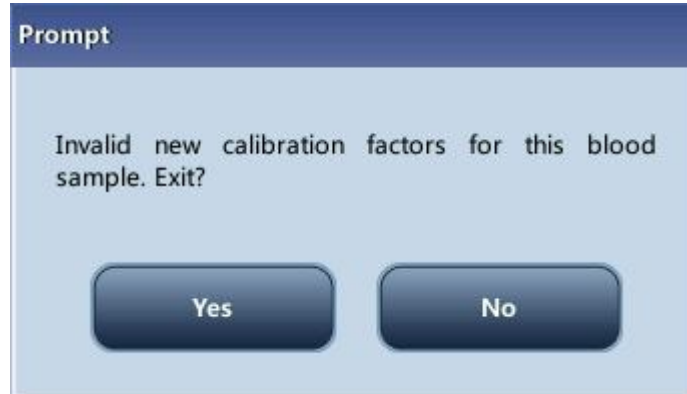

Tap "OK" to close the message box, and the data will be deleted from the table without saving automatically.

When the running is done, if there is a parameter whose calibration data is out of the display range, then the non-numeric parameter values "****" will be displayed in the list and a message box will pop up.

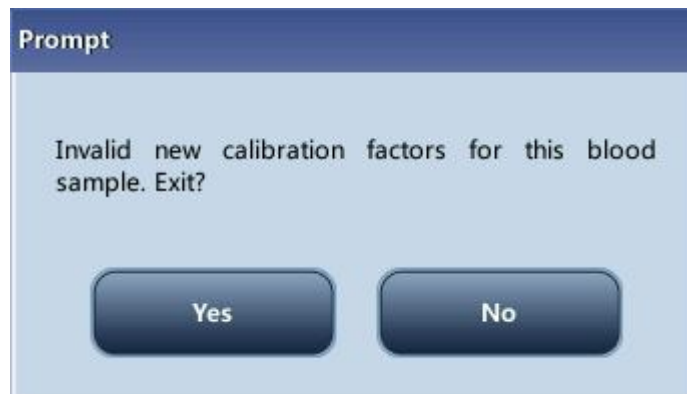

Tap "OK" to close the message box, and the data will be deleted from the table without saving automatically.

The valid results within the linearity range will be displayed directly. Valid calibration results will be marked with " \sqrt{h} " per the default setting, and will be taken to calculate calibration factors.

8. If the calibration factors have not been calculated but you switch to another screen, then a message box will pop up.

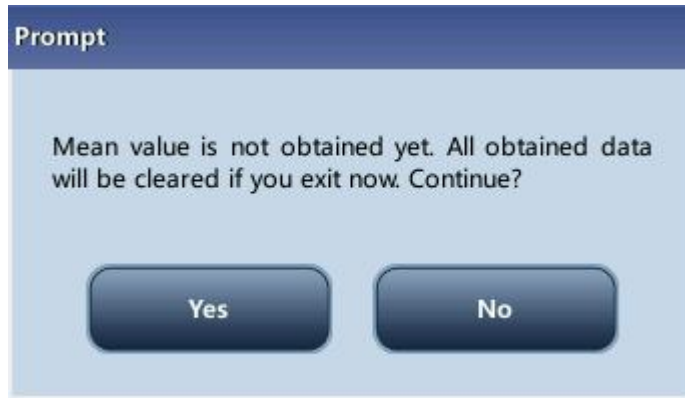

Tap "Yes" to switch to another screen while discarding the calibration data and closing the message box. The original calibration factors remain.

9. When calibration count has been performed to a sample for n times ($n \geq 5$), the analyzer will calculate the Mean, CV% and calibration factors of all the calibration data marked with "√" (calibration data of the first run is not marked with "√", so it is not included in the calculation).

You can select several data to calculate the calibration factors, but only after at least 5 groups of the data are marked with "√" can you get the calibration factors. The calibration factors will be refreshed whenever you select "√" or deselect "√".

When the amount of valid calibration data in the list reaches 10, a message box "Calibration is completed!" will pop up. Then, if you press the aspirate key again, the analyzer will beep without starting analysis.

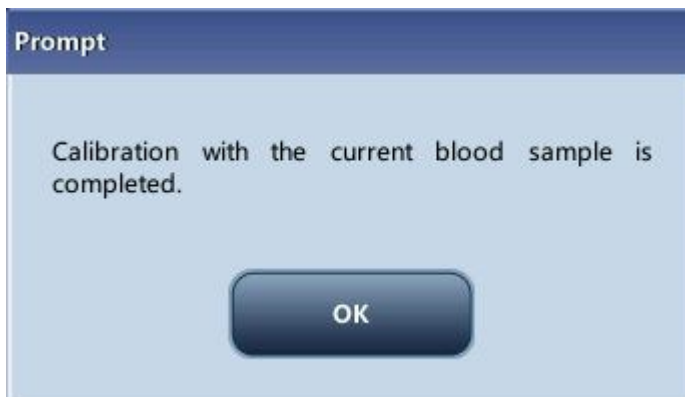

10. There may be two cases when you are switching to another screen:

If the calibration factors of any parameter is out of the range [75%-125%] or the CV% of any parameter exceeds the reproducibility range, then the calculated calibration factors of all parameters will not be saved and a message box will also pop up.

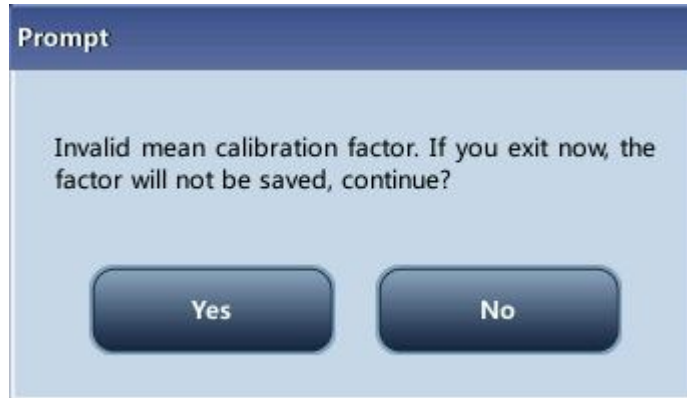

Tap "Yes" to close the dialog box and switch to another screen. The calibration factors and dates of all parameters will not be changed.

If the calculated calibration factors of all parameter are within the range [75%-125%] and the CV% of all parameter are also within the reproducibility range, then a message box will pop up.

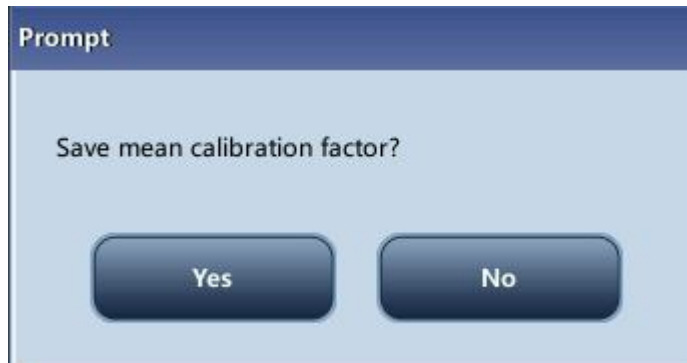

Tap "Yes" to save the new calibration factors while closing the message box and switching to another screen.

Other Operations

Print

If the calibration factors are invalid, tap print, the dialog box "New calibration factor is invalid." will display.

If the calibration factors are valid but not saved, tap "Print", a dialog box will display asking you to save the factors.

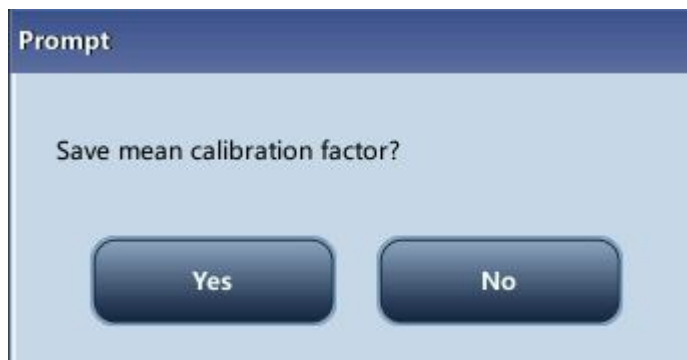

Click "Yes" to close the dialog box, save and print the calibration results. Or click "No" to cancel the operation without saving or printing them.

8.3.4 Calibration with Fresh Blood

Tap "Calibration" > "Fresh Blood" in the menu to enter the following screen.

	Select	WBC	RBC	HGB	MCV	PLT
Target						
1						
2						
3						
4						
5						
6						
7						
8						
9						
10						
Mean						
CV(%)						
Calibration Factor1(%)						
Old Factor (%)		100.00	100.00	100.00	100.00	100.00

Mode WB-CBC+DIFF Administrator : Admin 07-08-2013 15:42

Do as follows to calibrate the analyzer with fresh blood.

1. Prepare 3 to 5 normal fresh blood samples as instructed by 5.5.1 Preparing Samples.
2. Run each of the prepared samples on the reference instrument (or by the reference method) five times at least. Calculate the mean values and use them as the targets. Or perform measurement and calculation as per the reference method and take the calculated data as the targets.
3. Select mode for fresh blood calibration, which can be Whole Blood-CBC+DIFF, Whole Blood-CBC, Pre-diluted-CBC+DIFF and Pre-diluted-CBC.
4. Select the ID of current sample from the pull-down box "Current Sample ID".
5. Enter the targets into the "Target" cells.

Current Sample ID: Blood1

Analysis mode: WB PD

Select	WBC	RBC	HGB	MCV	PLT
Target	7.28	5.05	152	87.8	249
1					
2					
3					
4					
5					
6					
7					
8					
9					
10					
Mean					
CV(%)					
Calibration Factor1(%)					
Old Factor (%)	106.47	102.73	95.80	94.48	124.00

Mode: WB-CBC+DIFF Administrator: Admin 07-04-2013 15:30

6. Prepare fresh blood sample.

7. Press the aspirate key to start calibration.

After the analysis, the analyzer will have different responses to different analysis results.

If the results are out of the linearity range but still within the display range, a dialog box will pop up when the results are displayed in the table.

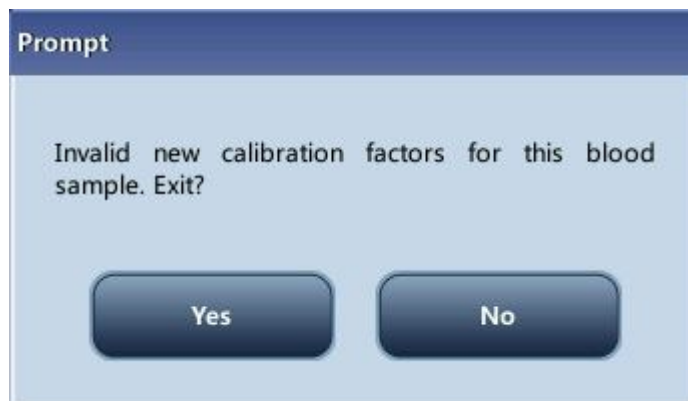

Tap "Yes" to close the message box, and the data will be deleted from the table without saving automatically.

If the results are out of the display range, the non-numeric parameter values "****" are obtained and a dialog box will pop up.

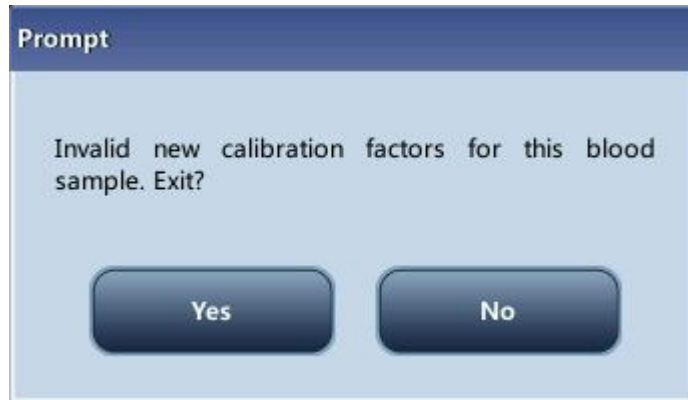

Tap "Yes" to close the message box, and the data will be deleted from the table without saving automatically.

The valid results within the linearity range will be displayed directly.

Valid calibration results will be marked with "√" per the default setting, and will be taken to calculate calibration factors.

9. When calibration count has been performed to a sample for n times ($n \geq 5$), the analyzer will calculate the Mean, CV% and calibration factors of all the calibration data marked with "√" automatically.

You can select several data to calculate the calibration factors, but only after at least 5 groups of the data are marked with "√" can you get the calibration factors. The calibration factors will be refreshed whenever you select "√" or deselect "√".

When the amount of valid calibration data in the list reaches 10, a message box "Calibration with the current blood sample is completed." will pop up when you start calibration again.

10. Select other calibration sample ID from the "Current Sample ID" pull-down box, analyze other samples according to Step 7-9 above to obtain the calibration factors of all samples.

11. There may be several cases when switching to another blood sample:

If the calibration factors of the blood sample are invalid or the CV% of any parameter exceeds the reproducibility range, a dialog box will pop up when switching to another blood sample.

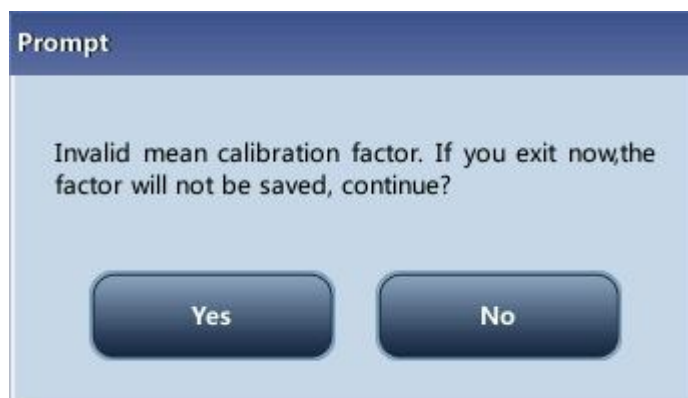

Tap "Yes" to empty the entered target of the current sample, all the calibration data obtained and each calculated value including calibration factors, then close the dialog box and switch to another blood sample.

If the calibration factors have not been calculated, a dialog box will pop up.

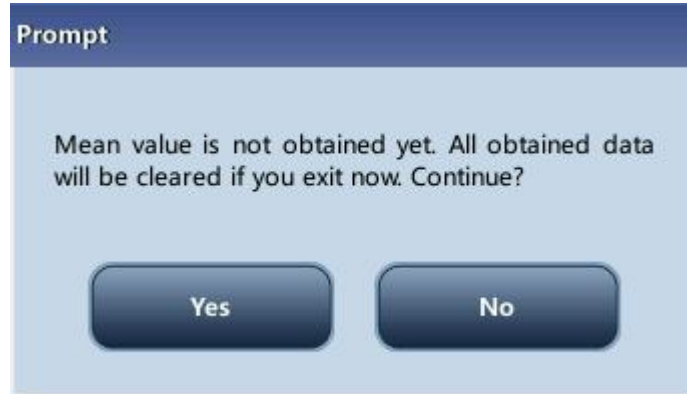

Tap "Yes" to empty the entered target of the current sample and all the calibration data obtained, then close the dialog box and switch to another blood sample.

If the calibration factors of the sample are valid and the CV% of all the parameters do not exceed the reproducibility range, you can switch to another blood sample directly.

12. After calibration factors of at least 3 fresh blood samples are obtained, tap the "Calculate" button to enter the screen of calibration calculation.

Calculate						
	Select	WBC	RBC	HGB	MCV	PLT
Calibration Factor1(%)	<input checked="" type="checkbox"/>	99.96	99.92	114.91	99.52	101.45
Calibration Factor2(%)	<input checked="" type="checkbox"/>	99.86	99.64	114.75	99.69	100.88
Calibration Factor3(%)	<input checked="" type="checkbox"/>	99.77	99.88	115.07	99.34	101.20
Calibration Factor4(%)	<input type="checkbox"/>					
Calibration Factor5(%)	<input type="checkbox"/>					
Mean Factor (%)		99.86	99.81	114.91	99.52	101.18
Old Factor (%)		100.90	102.90	118.00	100.00	100.00

Select or deselect the calibration factors of a blood sample for the calculation of the Mean calibration factors by tapping the check boxes before the calibration factors.

When 3 or more groups of calibration factors are checked, CV% will be re-calculated

automatically base on the checked calibration factors.

When 3 or more groups of calibration factors are checked, the mean calibration factor will be re-calculated automatically base on the checked calibration factors. The mean calibration factors are regarded as invalid if the deviation of absolute value between the calibration factors included in calculating the mean and the original calibration factors reaches or exceeds 5%; a dialog box will pop up when you exit the current fresh blood calibration screen.

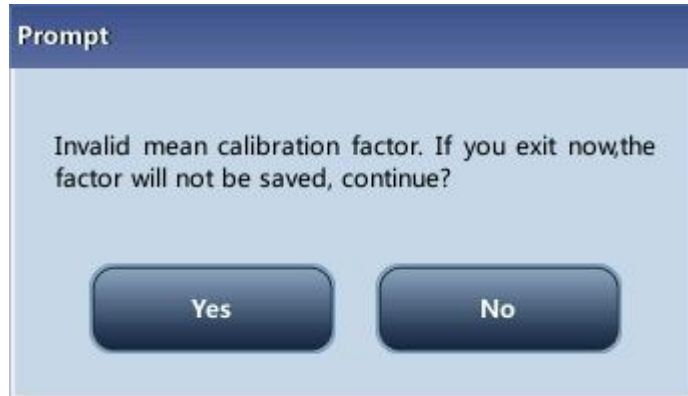

Tap "Yes" to close the dialog box and exit with the current calibration data emptied, and then switch to another screen.

Tap "No" to return to the current screen. Invalid mean calibration factors are followed with a "?", and displayed in red.

13. If the mean calibration factors have not been calculated, when you exit the fresh blood screen or switch to another calibration mode, a dialog box will pop up.

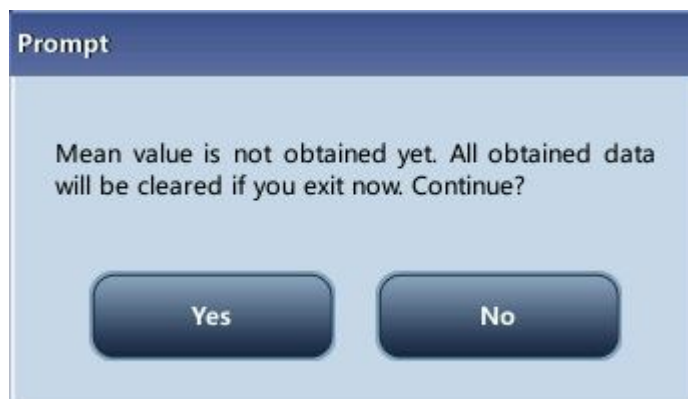

Tap "Yes" to discard the calibration data, close the dialog box, and switch to another screen or calibration mode. The original calibration factors and date remain the same.

14. If the calculated mean calibration factors are valid, when exiting the fresh blood calibration screen or switching to another calibration mode, a dialog box will pop up.

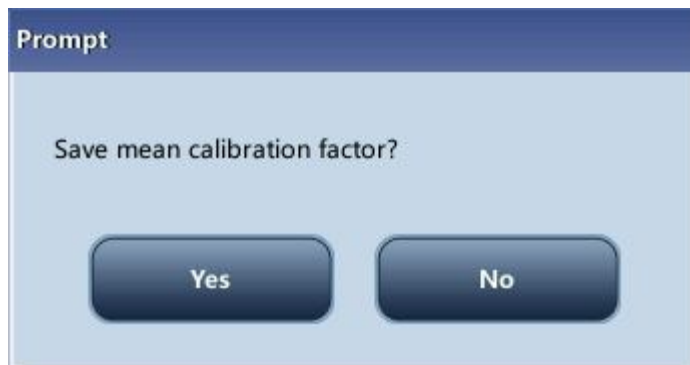

Tap "Yes" to save the current mean calibration factors. Then, you can switch to another screen or calibration mode. Tap "No" to close the dialog box and switch to another screen or calibration mode without saving the mean calibration factors and all the calibration data.

Other Operations

Print

If the mean calibration factors are invalid, tap print, the dialog box "Calibration factor is invalid." will display.

If the mean calibration factors are valid, you can tap "Print" to print the calibration factors of a group (or more) of blood samples in table form, no matter whether they are selected ("√") or not. The results obtained in the calibration process and the mean calibration factors can also be printed.

9 Customizing the Analyzer Software

9.1. Introduction

The BC-5150 is a flexible laboratory instrument that can be tailored to your working environment. You can use the “Setup” program to customize the software options as introduced in this chapter.

For the security of the settings and data, two access levels are provided to the operator of the analyzer. The administrator access level provides the operator with access to more functions or settings, some of which can be configured to be accessible to operators.

See the following figure for the setup menu.



9.2. Setting Up the Analyzer

9.2.1 System Setup

- **Date/Time**

Tap the menu option "Setup" > "System Setup" > "Date/Time" to enter the "Date/Time" screen as shown below. You can set up the date, time and date format of the analyzer at the screen.

The screenshot shows the "Date/Time" configuration screen. At the top, there is a navigation bar with seven buttons: Menu, Sample Analysis, Table Review, QC, Reagent Setup, Diluent, and Print. Below this, the main content area has three rows of settings:

- Date:** A text input field containing "07 - 05 - 2013".
- Time:** A text input field containing "14 : 20", followed by the text "24 hours".
- Date Format:** A dropdown menu showing "MM-DD-YYYY".

At the bottom right of the screen, a status bar displays "Administrator : Admin" and "07-05-2013 14:20".

- **Print**

Tap the menu option "Setup" > "System Setup" > "Date/Time" to enter the "Print setup" screen as shown below. You can set up the following contents:

- Print setup
- Printing content
- Auto print



- **Print setup**

Print device

There are 2 types of printing device available: printer and recorder. You can select either of them from the pull-down list.

Printer driver

Tap the pull-down list to select printer driver of the analyzer.

Paper

Tap the pull-down list to select the paper type of the reports to be printed.

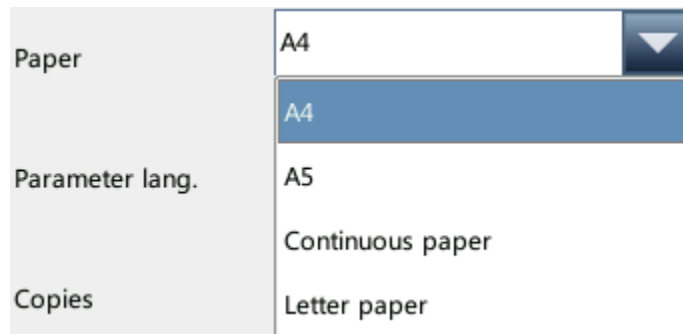

Parameter language

Tap the pull-down list to select the parameter language of the reports.

Copies

Enter the number of copies to be printed for each report into the edit box "Copies".

Copies	<input type="text" value="1"/>	[1, 20]
--------	--------------------------------	---------

Report title

Report title	<input type="text" value="Hematology Analysis Report"/>
--------------	---

Report template

Applicable report templates for printer are shown as below:

Report template	<input type="text" value="One page with histogram"/>	▼
Header Info	One page with histogram	
	One page without histogram	
	Half page with histogram	
	Half page without histogram	

Applicable report templates for recorder are shown as below.

Report template	<input type="text" value="Horizontal layout w. histogram"/>	▼
Header Info	Horizontal layout w. histogram	
	Horizontal layout w/o histogram	
	Vertical layout w. histogram	
	Vertical layout w/o histogram	

- Printing content

You can choose to select the functions based on your needs by tapping on the check boxes.

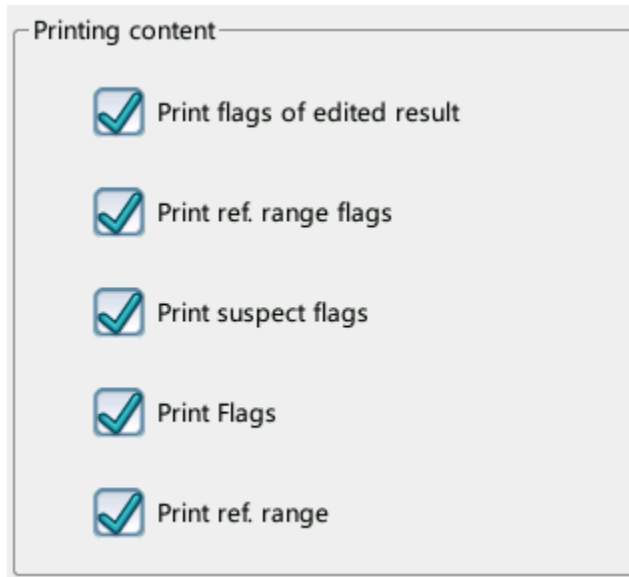

- Auto print

You can choose to disable auto print or set up printing conditions.

- **Communication setup**

Tap the menu option "Setup" > "System Setup" > "Communication" to enter the communication setup screen as shown below. You can set up the following contents:

- Protocol Setup
- Transmission Mode



- Protocol Setup

Tap the "IP Address", "Subnet Mask" and "Default Gateway" edit boxes to enter the contents.

Communication Protocol

Tap the "Comm. Protocol" pull-down list to select the communication protocol.

ACK synchronous transmission

Tap on the "ACK synchronous transmission" check box to activate the function.

When the function is activated, ACK overtime is 10 seconds by default. You can re-enter the ACK overtime in the edit box.

- Transmission Mode

You can choose to select the functions based on your needs by tapping on the check boxes.

- Auto retransmit
- Auto comm.
- Transmit as Print Bitmap Data

Transmission mode of histogram and scattergram

Tap the pull-down lists to select the transmission modes of histogram and scattergram.

- Not to be transmitted
- Bitmap
- Data

● **Flag alarm sensitivity**

Tap the menu option "Setup" > "System Setup" > "Flag alarm sensitivity" to enter the screen as shown below. This function allows you to set up flag alarm sensitivity based on your own needs.



This screen shows the values that may trigger flag alarm. Operators of administrator access level can modify the reference values of the flags, which indicated the possibility of triggering flags. The lower the values are, the higher the possibility can be.



- **Shortcut code setup**

Tap the menu option "Setup" > "System Setup" > "Shortcut Code Setup" to enter the screen as shown below. This function allows you to set up shortcut codes for the contents in sample information setup screens.



- Add shortcut codes

1. Select "Department" or "Clinician" tab.
2. Tap "Add", a line will be added in the table.
3. Enter the "Name", "Shortcut Code" and "Digital Code" based on your needs.

- Edit shortcut codes

1. Select "Department" or "Clinician" tab.
2. Select the line of the shortcut code to be edited.
3. Modify it directly in the table.

- Delete shortcut codes

1. Tap the shortcut code to be deleted.
2. Select the line of the shortcut code to be deleted.
3. Tap "Delete" to delete it.

● **Lab info. setup**

Tap the menu option "Setup" > "System Setup" > "Lab Info. Setup" to enter the screen as shown below. Operators may enter, save and view lab information. Tap on the edit boxes to enter the information.

The screenshot shows a mobile application interface for 'Lab Info. Setup'. At the top, there is a dark navigation bar with seven icons: Menu, Sample Analysis, Table Review, QC, Reagent Setup, Diluent, and Print. Below this is a light gray form area with the following fields:

- Hospital Name:
- Lab Name:
- Supervisor:
- Contact Info.:
- Zip Code:
- Analyzer Model:
- Analyzer SN: (This field is highlighted in blue, indicating it is not editable.)
- Date of Installation: MM - DD - YYYY
- Customer service contact:
- Customer service contact:
- Comments:

At the bottom right of the screen, there is a status bar showing 'Administrator : Admin' and the date/time '07-05-2013 14:21'.

NOTE

- The analyzer SN cannot be edited.
- The date of installation is the date the analyzer is installed by default. It can be edited, but cannot be later than the current system date.

9.2.2 Access Setup

Tap "Setup" > "Access Setup" in the menu to enter the following screen.



- Modify password

You can modify your own password.

1. Select the current user, and then tap "Modify password", the following dialog box will display.



2. Enter the required information in the edit boxes.

3. Tap "OK" to save the change and close the dialog box.
-

NOTE

- The password cannot be null, and 12 characters can be entered at most.
-

- Create new user
-

1. Tap "New", the following dialog box displays.

The image shows a screenshot of a mobile application dialog box titled "Add user". The dialog has a light blue background and a dark blue header with the text "Add user". Below the header, there are four text input fields arranged vertically, labeled "User ID", "Name", "Password", and "Confirm password". Below these fields, there are two radio button options for "Access Level": "Operator" (which is selected) and "Administrator". At the bottom of the dialog, there are two buttons: "OK" and "Cancel".

2. Enter the "User ID", "Name" and "Password" information.
-

3. Select access level of the user:

- Operator
 - Administrator
-

4. Tap "OK" to save the change and close the dialog box.
-

NOTE

- The user ID cannot be null, and 12 characters can be entered at most.
- The password cannot be null, and 12 characters can be entered at most.
- The name cannot be null, and 20 characters can be entered at most.

- Delete user

Select a user and then tap "Delete" to delete it.

NOTE

- The current login user cannot be deleted.

9.2.3 Auxiliary Setup

Tap "Setup" > "Auxiliary Setup" in the menu to enter the following screen. You can set up the following contents:

- Setting of the next sample
- Setting of the first sample after startup
- Other settings

The screenshot displays the 'Auxiliary Setup' screen. At the top, there is a navigation bar with icons for Menu, Sample Analysis, Table Review, QC, Reagent Setup, Diluent, and Print. Below this, the screen is organized into three main sections:

- Setting of the next sample:**
 - Entry of Next Sample ID: Auto Increase
 - Not counted as an auto increase character: 0
 - Entry of next sample info.: Enter all information
- Setting of the first sample after startup:**
 - First sample after startup: Custom
 - Sample ID: 1
 - Mode: WB-CBC+DIFF
- Other settings:**
 - Predilute Mode Prompt: On
 - Pop-up keyboard: On
 - Flags: Suspect (R), High (H), Low (L)

The bottom of the screen features a status bar with the text 'Administrator : Admin' and the timestamp '07-05-2013 14:22'.

- Setting of the next sample

Setting of the next sample

Entry of Next Sample ID	<input style="width: 95%;" type="text" value="Auto Increase"/>
Not counted as an auto increase character	<input style="width: 95%;" type="text" value="0"/>
Entry of next sample info.	<input style="width: 95%;" type="text" value="Enter all information"/>

Entry of the next sample ID

Tap the pull-down list to select the way to enter the next sample ID.

- Auto Increase
- Manual Entry

Not counted as an auto increase character

Operators can set up the number of characters in the sample ID that will not be auto increased.

When "Auto Increase" is selected as the way to enter the next sample ID, this edit box will be activated.

Enter a number n into the edit box. The first n characters in the sample ID will not be auto increased.

- Setting of the first sample after startup

Operators may:

Customize the first sample ID after startup by entering it into the edit box. Or select to continue with the sample ID before last shutdown.

Setting of the first sample after startup

First sample after startup	<input style="width: 95%;" type="text" value="Custom"/>
Sample ID	<input style="width: 95%;" type="text" value="1"/>
Mode	<input style="width: 95%;" type="text" value="WB-CBC+DIFF"/>

- Other settings

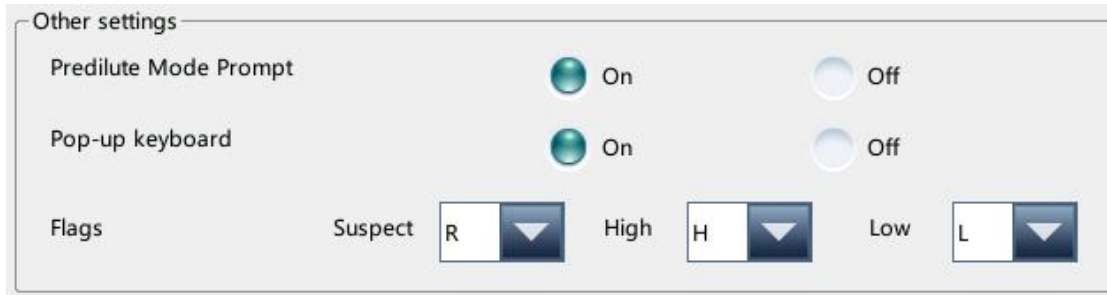

On/Off radio buttons

Select "On" or "Off" to activate or deactivate the functions.

Flags

Operators may set up the suspect flag by entering a character into the edit box, or selecting a letter from the pull-down list (the default character is "R").

Operators may set up the high/low flag by entering two characters into the edit boxes, or selecting two letters from the pull-down lists (the default character of high flag is "H", and that of low flag is "L").

9.2.4 Parameter Setup

● Parameter unit setup

Tap the menu option "Setup" > "System Setup" > "Parameter Unit Setup" to enter the screen as shown below. You can set up parameter unit at this screen.



- Select unit system

Tap the "Unit system" pull-down list to select unit system.

- Customizing parameter units

Under each unit system, you can tap the "Unit" cell to customize the parameter unit.

Tap the "Default" button to restore the default units.

NOTE

- The units displayed will be different when different unit system is selected.

● Reference range setup

Tap the menu option "Setup" > "System Setup" > "Reference Range Setup" to enter the screen as shown below. 5 factory reference group and 10 customized reference groups are provided for your choice. Each laboratory shall select a proper reference range of its own based on its patient demographics. The reference range differs among races, genders, ages and geographic locations.

	Reference group	Default reference group	Lower Limit of Age (>)	Upper Limit of Age (<=)	Gender
1	General	<input checked="" type="checkbox"/>			Any
2			13 Years	999 Years	
3	Adult male		13 Years	999 Years	Male
4	Adult female		13 Years	999 Years	Female
5	Child		28 Days	13 Years	
6	Neonate		0 Hours	28 Days	

Match customized ref. group first

New Edit Delete Set to Default

Administrator : Admin 07-05-2013 14:22

- Customizing reference groups

Select a reference group and tap "New" or "Edit" to enter the reference group setup screen. You can set up the name, lower and upper limits of age and parameter range.

Parameter	Lower Limit	Upper Limit	Parameter	Lower Limit	Upper Limit
WBC			HCT		
Neu#			MCV		
Lym#			MCH		
Mon#			MCHC		
Eos#			RDW-CV		
Bas#			RDW-SD		
Neu%			PLT		
Lym%			MPV		
Mon%			PDW		
Eos%			PCT		
Bas%			P-LCC		
RBC			P-LCR		
HGB					

Reference group: Custom1

Lower Limit of Age (>): 0 Hours

Upper Limit of Age (<=): 999 Years

Gender: [Dropdown]

Return

Administrator : Admin 07-05-2013 14:22

Tap the "Set to Default" button, the reference ranges of the selected factory reference group can be restored to the default settings.

NOTE

- The name of the reference group cannot be null.
 - The names of the customized reference groups shall not repeat the names of the 5 default groups, and they shall not repeat each other either.
-

- Setting as default reference group

Select a reference group and then tap "Set to Default" to set it as default reference group.

NOTE

- The name, lower and upper limits of age and gender of the factory reference groups cannot be modified.
 - The input range of age is [0,999].
-

- Modify reference range(s)

To modify the reference range of a reference group,

Select the group from the reference group list on the left, and then click the cells of upper and lower limits in the table and re-enter the values.

To restore the reference ranges to default, click the "Default" button on top right of the screen.

Select "Match customized ref. group first ", when the age ranges of the customized reference group and the default reference group contradicts with each other, the customized reference group will be matched first on the sample analysis and review screens.

- **RUO parameter setup**

Tap the menu option "Setup" > "System Setup" > "RUO Para". Setup to enter the screen as shown below. You may modify RUO parameter related settings.

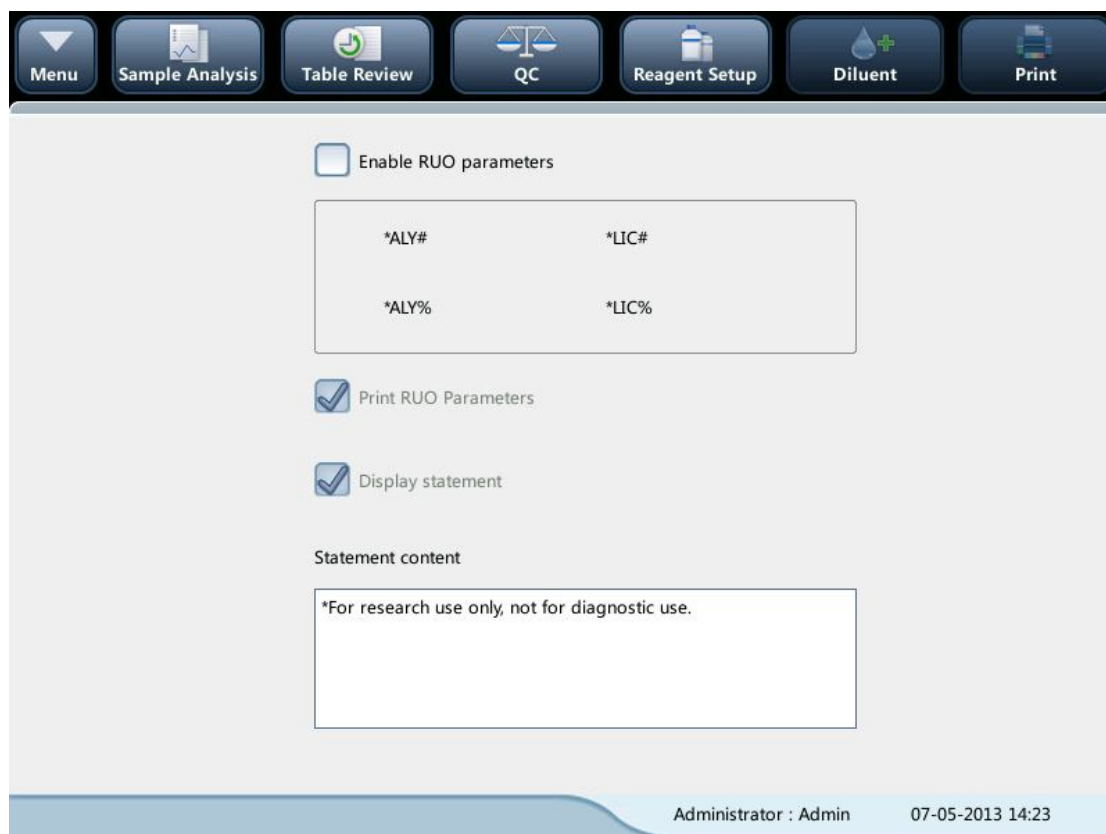

Select "Enable RUO parameters". The 4 RUO parameter results will be given for the samples analyzed thereafter.

Parameter	Result	Unit	Parameter	Result	Unit
WBC	6.82	10 ⁹ /L	RBC	4.21	10 ¹² /L
Neu#	4.58	10 ⁹ /L	HGB	130	g/L
Lym#	1.68	10 ⁹ /L	HCT	0.397	
Mon#	0.41	10 ⁹ /L	MCV	94.2	fL
Eos#	0.09	10 ⁹ /L	MCH	30.9	pg
Bas#	0.06	10 ⁹ /L	MCHC	328	g/L
Neu%	67.2	%	RDW-CV	0.134	
Lym%	24.6	%	RDW-SD	43.2	fL
Mon%	6.1	%	PLT	200	10 ⁹ /L
Eos%	1.3	%	MPV	10.9	fL
Bas%	0.8	%	PDW	16.0	
*ALY#	0.00	10 ⁹ /L	PCT	2.17	mL/L
*ALY%	0.0	%	P-LCC	68	10 ⁹ /L
*LIC#	0.00	10 ⁹ /L	P-LCR	33.9	%
*LIC%	0.1	%			

● Microscopic parameter setup

Tap the menu option "Setup" > "System Setup" > "Microscopic Para. Setup" to enter the

screen as shown below. You may modify microscopic parameter related settings.



- Add new parameter

Tap the “New” button to add a new row in the table, and then you can enter the name of the parameter in the row.

- Delete

Select a row in the table, click the “Delete” button to delete the parameter.

- Editing parameter name

Tap a parameter name in the table to edit the name.

NOTE

- You can add up to 40 microscopic parameters.
- The reconfigured setup will not be applied to sample records which already have microscopic results saved, but only applied to sample records with unsaved microscopic results and records attained after the new setup is applied.

9.2.5 Maintenance Setup (for administrators only)

Tap "Setup" > "Maintenance" in the menu to enter the following screen. You can set up the following contents:

The screenshot shows the Maintenance Setup interface. At the top, there is a navigation bar with seven buttons: Menu, Sample Analysis, Table Review, QC, Reagent Setup, Diluent, and Print. Below this, the main content area is divided into two sections. The first section, titled "Standby", contains a "Wait" label and a text input field with the value "15". To the right of the input field is the range "[10, 30] minutes". The second section, titled "Probe Cleanser Maintenance", contains two rows. The first row is labeled "Time-based daily maintenance" and has two text input fields with values "16" and "00", followed by the range "[00:00, 23:59]". The second row is labeled "Remind every" and has a text input field with the value "10", followed by the range "[5, 10] min". At the bottom right of the screen, there is a status bar displaying "Administrator : Admin" and "07-05-2013 14:25".

- Standby

Tap the text box "Wait" and enter the waiting time before entering the standby status. The range allowed is 10 -30 minutes, and the default setting is 15 minutes.

- Probe cleanser maintenance

Tap the first text box in the "Probe Cleanser Maintenance" area to enter the time to start time-based probe cleanser maintenance. Tap the second text box to enter a time in the text box. Then when the operator cancels the time-based maintenance, a reminder dialog box will pop up after the defined minutes.

9.2.6 Reagent Setup

Tap "Setup" > "Reagent Setup" in the menu to enter the following screen.



It is recommended that you replace the reagents when their residue volume icons turn from BLUE to RED.

This function may also be used to refill reagent inside the fluidic system when a new container of reagent is loaded.

NOTE

- The reagents must be kept still for at least a day after long-term transportation.
- When you have changed the diluents or lyse, run a background test to see if the results meet the requirement.

You should replace reagents when:

- the reagent ran out and a new container of reagent is installed.
- the reagent in the tubing is contaminated.
- there are bubbles in the tubing.

You can replace the following reagents in the fluidics:

- Diluent
- DIFF lyse
- LH lyse

- Do as follows to replace the reagents.

1. Tap the reagent you want to replace, and then tap "Setup".

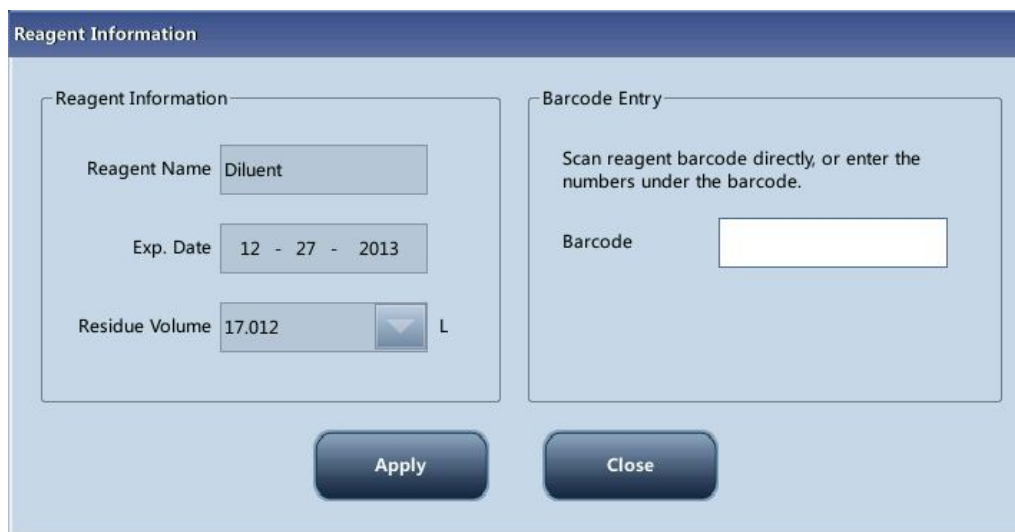

2. Enter reagent information at the screen.

3. Or scan in the barcode. If the barcode is valid, the corresponding reagent information will automatically display.

4. Tap "Replace" to save the exp. date and start to replace the reagent. A progress bar will be displayed in the process.

5. Replace other reagents as per the above procedures if needed.

NOTE

- Please keep the diluent container from severe shock or crashing against other object. Otherwise, the alarming would be unreliable.
- When replacing diluent container, do as follows: 1) Install the supporting board under the cap of the diluent container as instructed below. 2) Insert the diluent cap assembly into the container as shown in the figure below, and tighten the cap. Otherwise the alarming may be unreliable.

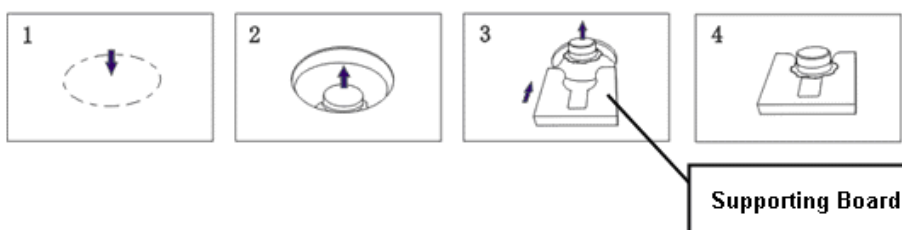



9.2.7 Gain Setup (for administrators only)

Tap "Setup" > "Gain Setup" in the menu to enter the following screen. Gain setup function allows you to adjust the digital potentiometers. The operation shall not be performed frequently.

- Setup

	Gain Factor (%)	Adjustment rate
LAS	100.00	100.0%
MAS	100.00	100.0%
WAS	100.00	100.0%
Width	100.00	100.0%

	Set Value	Adjustment rate	Blank Volt.
MCV_G	128	100.0%	/
HGB	86	/	4.53V

Administrator : Admin 07-05-2013 14:26

- RBC gain

Tap the MCV-G "Set Value" cell, and enter the new value of RBC gain.

- HGB gain

The purpose of adjusting HGB gain is to change HGB blank voltage.
Enter the new value in to the HGB "Set Value" cell to modify HGB gain.

NOTE

- The gains of LAS, MAS and WAS cannot be modified.
-

9.3. Save the settings

To save the modified settings, you may switch to another screen, the following dialog box will display.



Click "Yes" to save the settings and switch to the corresponding screen. Click "No" to switch to the corresponding screen without saving the settings.

10 Servicing Your Analyzer

10.1. Introduction

Preventive and corrective maintenance procedures are required to keep the analyzer in a good operating condition. This analyzer provides multiple maintenance functions for this purpose.

This chapter introduces how to use the provided functions to maintain and troubleshoot your analyzer.



- All the analyzer components and surfaces are potentially infectious, take proper protective measures for operation or maintenance.
-

⚠ WARNING

- The reagents are irritating to eyes, skin and airway. Wear proper personal protective equipment (e.g. gloves, lab coat, etc.) and follow safe laboratory procedures when handling them and the contacted areas in the laboratory.
 - If reagents accidentally spill on your skin or in your eyes, rinse the area with ample amount of clean water; seek medical attention immediately.
-

⚠ CAUTION

- Improper maintenance may damage the analyzer. Operators must follow the instruction of this Operator's Manual to perform maintenance operations.
 - For any questions, contact Mindray customer service department.
 - Only Mindray-supplied parts can be used for maintenance. For any questions, contact Mindray customer service department.
 - Exercise caution to avoid contact with the sharp sample probe when performing maintenance.
-

The following table lists the tools that may be used in maintenance.

No.	Tools
1.	Cross-headed screwdriver
2.	Slotted head screwdriver
3.	Medical gloves
4.	Alcohol

10.2. Maintaining Your Analyzer

Maintenance options of the analyzer includes: maintenance, cleaning and fluidics maintenance.

10.2.1 Maintenance

Tap "Service" > "Maintenance", and select the "Maintenance" tab to enter the following screen.



Unclog aperture

Unclogging includes zapping and flushing the aperture. When clog error us reported, you should unclog the aperture.

The unclogging procedures are:

1. Tap the "Unclog" button to start unclogging.
2. When the progress ends, a message will display indicating "Maintaining finished!".
3. Do the above procedures to continue unclogging aperture if necessary. If the error persists, perform probe cleanser maintenance of the related channels.

Probe cleanser maintenance

You should perform the probe cleanser soaking procedure when:

- background results are out of range, QC results abnormal or scattergram abnormal due to long term idleness of the analyzer; or when other maintenance operations fail to solve the clog error.
- the analyzer shuts down due to abnormal power break-off; probe cleanser maintenance must be performed after it is started up again.

The probe cleanser maintenance procedures are:

1. Tap "Overall Soak" button, the following dialog box will display.

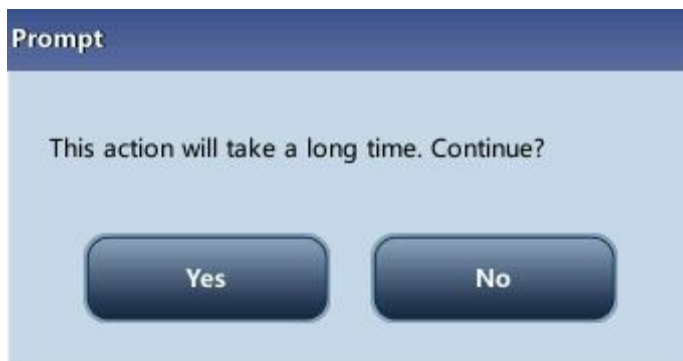

2. Tap "Yes", the analyzer starts to prepare for the maintenance.
-

3. When the preparation is done, the following dialog box will display.

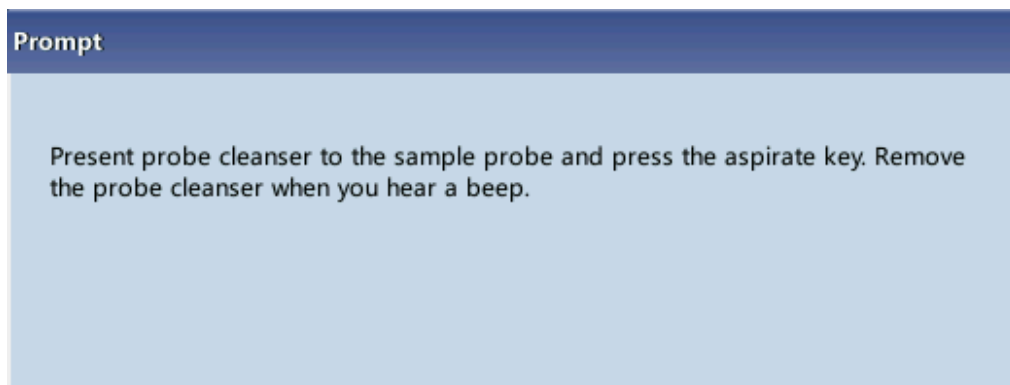

4. After aspirating probe cleanser, the analyzer performs probe cleanser soak automatically, and a progress bar will display indicating the progress.
-

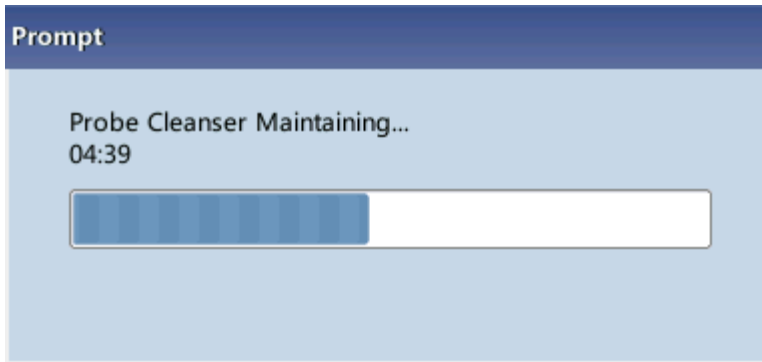

5. When the progress ends, the following dialog box will display, click "OK" to close the dialog box.



10.2.2 Cleaning

You should clean the following components when:

- WBC and (or) HGB background results exceed their limits, perform WBC bath cleaning. If WBC bath cleaning does not solve the problem, perform WBC probe cleanser maintenance.
- RBC and (or) PLT background results exceed their limits, perform RBC bath cleaning. If RBC bath cleaning does not solve the problem, perform RBC probe cleanser maintenance.
- there are too many particles in the scattergram of background results, perform WBC bath cleaning. If WBC bath cleaning does not solve the problem, perform WBC probe cleanser maintenance.
- sample probe gets dirty, perform sample probe cleaning.

Tap "Service" > "Maintenance", and select the "Cleaning" tab to enter the following screen.

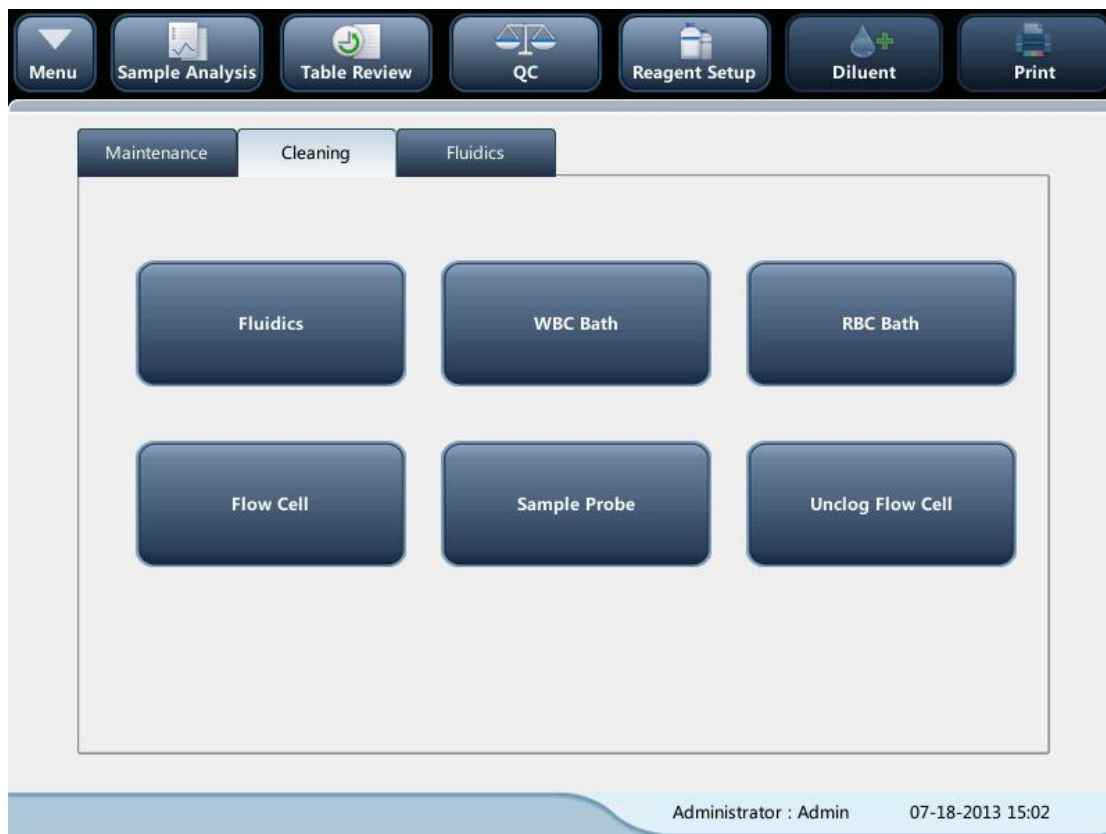

You may perform cleaning operation to the following components:

- Fluidics
- Flow cell
- Sample probe
- Unclog flow cell
- WBC bath
- RBC bath

The cleaning procedures are:

1. Tap the button of the component you want to clean. The message "Cleaning in process. Please wait..." will display.
2. When the progress ends, a message will display indicating "Cleaning finished!".
3. Clean other components as per the above procedures if needed.

10.2.3 Servicing the Fluidics

Tap "Maintenance", and select the "Fluidics" tab to enter the following screen.



Pack-up

If the analyzer is not to be used for over 2 weeks, you should perform this procedure. Do as follows to pack up:

1. Tap "Pack-up", the dialog box "Start pack-up?" will pop up.
2. Tap "Yes" to perform the pack-up procedure. The following dialog box will be displayed.

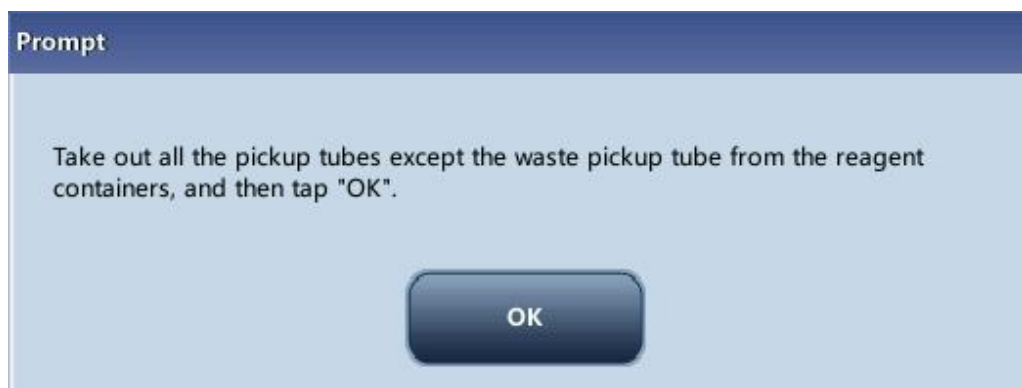

3. Take out the tubes as instructed and then tap "OK" to drain the fluidics.

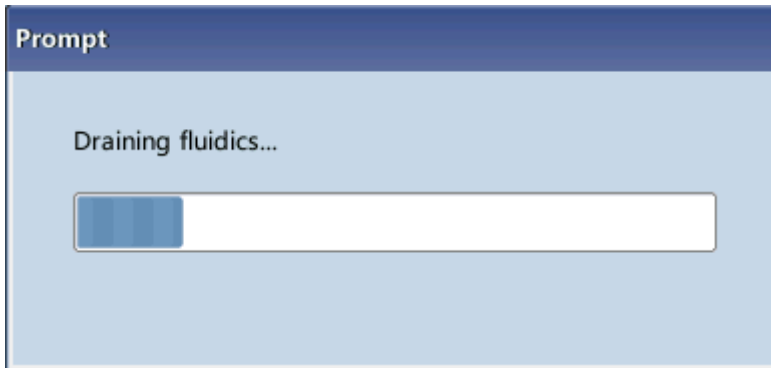

4. The following dialog box will be displayed after draining the fluidics.

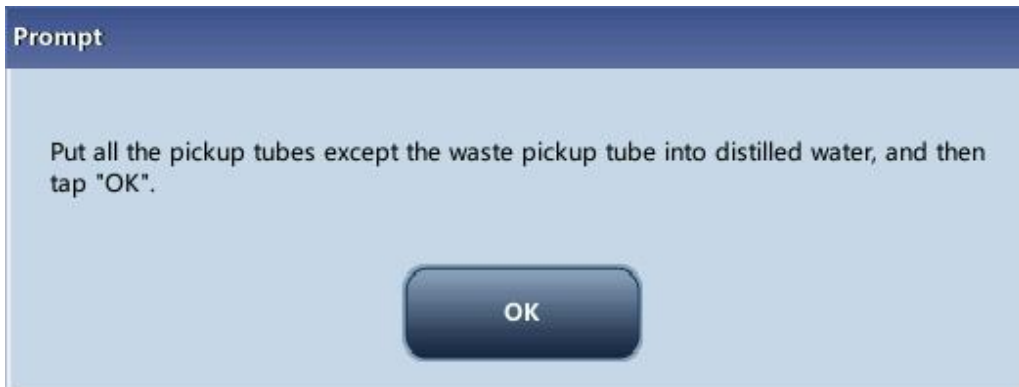

5. Put the tubes into distilled water as instructed, and tap "OK" to start priming.

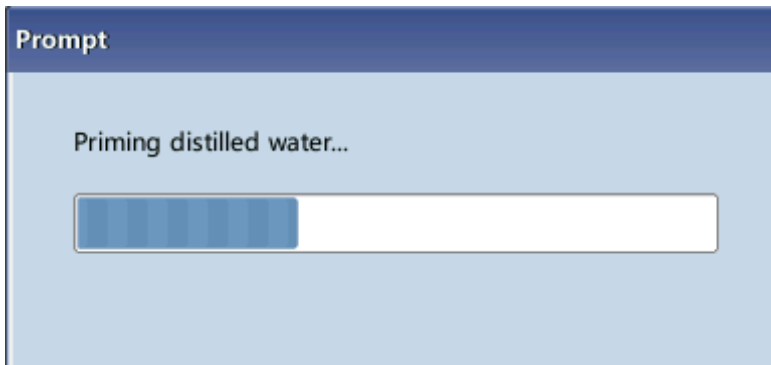

6. When the priming progress ends, the following dialog box will be displayed.

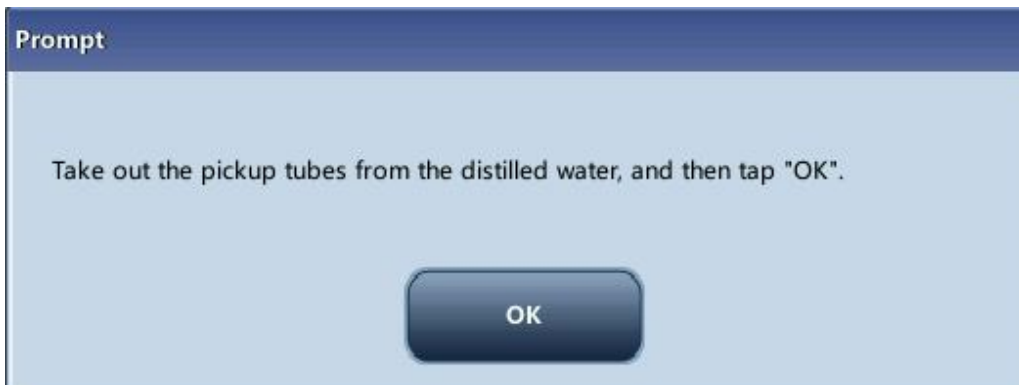

7. Take out the tubes as instructed and then tap "OK" to drain the fluidics again.

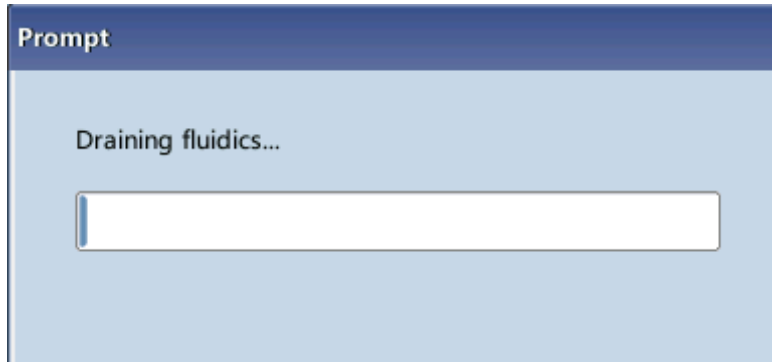

8. The following dialog box will be displayed after draining the fluidics.



9. When the pack-up is finished, shut down the analyzer as prompted.

NOTE

- This software can still be used after the pack-up.

Reset

When major components of the analyzer have been replaced, or the fluidic system has been serviced, you must reset the fluidics.

Do as instructed below:

1. Tap "Reset Fluidics", a dialog box will pop up asking you to confirm the operation.
-

2. Tap "OK" to start initialization, the message "Resetting fluidics. Please wait..." will be displayed.
 3. When the progress ends, a dialog box will display indicating "Resetting fluidics finished!".
 4. Do the above procedures to continue resetting fluidics if necessary.
-

10.3. Self-Test

The analyzer provides self-test function.

10.3.1 System self-test

Click "Maintenance">"Self-Test" >"System self-test" to enter the following screen.



You may test status of the analyzer components based on your needs.

1. Tap on the button of a test item to start self-test, the progress will be displayed on the screen.
2. Test other items as per the above procedures if needed.

NOTE

- If the test result is abnormal, contact Mindray customer service department or your local distributor for assistance.

10.3.2 Valve self-test

Click "Maintenance">"Self-Test" >"Valve self-test" to enter the following screen.



You can tell the status of the valve by observing its sound during the valve self -test. You can test the status of a single valve or all valves.

- Test a single valve

Tap the No. of the valve (e.g. 1), and observe its sound to see if it is normal.

- Test all valves

Tap the "Check all valves" button to test the status of all valves.

10.3.3 Fan self-test

Click "Maintenance">"Self-Test" >"Fan self-test" to enter the following screen.



Tap the "Spin" or "Stop" button to start fan self-test. When the test finishes, the message "Spin" will be displayed.

10.4. Touch Screen Calibration

Tap "Maintenance" > "TouchScreen " in the menu to enter the following screen.



10.5. Viewing Logs

Tap "Maintenance" > "Log" in the menu to enter the following screen.

	Date/Time	Operator	Summary	Times	Detail
1	08-27-2013 12:36	Admin (Admin...	Modify reference grou...	1	Modify reference group setting to: De...
2	08-27-2013 12:36	Admin (Admin...	Modify reference grou...	1	Modify reference group setting to: De...
3	08-27-2013 12:35	Admin (Admin...	Login	1	Admin(Administrator) logged in
4	08-27-2013 12:35	Admin (Admin...	Logout	1	Admin(Administrator) logged out
5	08-27-2013 12:34	Admin (Admin...	Modify flag setup	1	Modify flag to: Abn./Atypical Lympho?...
6	08-27-2013 12:31	Admin (Admin...	Modify flag setup	1	Modify flag to: Immature Cell?: 10 -> 50
7	08-27-2013 12:30	Admin (Admin...	Sample deleted	1	Sample 0827-15 analyzed at 08-27-20...
8	08-27-2013 12:30	Admin (Admin...	Login	1	Admin(Administrator) logged in

Date/time: 08-27-2013 12:36
 Operator: Admin (Administrator)
 Summary: Modify reference group setting
 Details: Modify reference group setting to: Default reference group: Adult male -> General

Administrator : Admin 08-27-2013 12:36

You may view the error info., parameter modification info. And records of daily operation in the log.

The "Log" screen records all activities of the analyzer. It contributes significantly to searching for operation history and troubleshooting the analyzer.

NOTE

- The oldest record will be overwritten automatically when number of log records reaches the utmost.
- Records of two years can be stored at most.

● Exporting logs

1. Tap "Export", the following dialog box will display.



The image shows a dialog box titled "Export" with a dark blue header. The main area is light blue and contains the following elements: "Input Range:" followed by the text "1-1115"; "From" followed by an empty white text input field; "To" followed by another empty white text input field; a checkbox labeled "Maximum range" which is currently unchecked; and two dark blue buttons at the bottom labeled "OK" and "Cancel".

-
2. Select the range of the logs that you want to export.
 3. Tap "OK" to close the dialog box and export the logs.
-

10.6. Checking the Analyzer Status

NOTE

- If the status is outside normal range, it will be highlighted with red background.

10.6.1 Counter

The counter counts the running times of the analyzer and the occurrence times of some major parameters.



- Viewing details

You may tap the "Detail..." buttons following "Runs", "QC Runs" or "Calibration Runs" to view the related details.

- Print

Tap the "Print" icon to print all information on the screen.

10.6.2 Temp. & Pressure

Tap "Status" > "Temp. & Pressure" in the menu to enter the following screen. You may check, export or print the temperature and pressure values of different components of

the analyzer.

The screenshot shows a software interface with a top navigation bar containing icons for Menu, Sample Analysis, Table Review, QC, Reagent Setup, Diluent, and Print. Below this, there are two data tables. The first table displays temperature settings in degrees Celsius, and the second table displays pressure settings in Kpa. At the bottom right, the interface shows the user is Administrator (Admin) and the date/time is 07-05-2013 14:38.

	Temperature(°C)	Range
Diluent	28.6	[10.0, 40.0]
Reagent preheating temperature	41.1	[39.1, 43.6]
Optical System Temperature	33.8	[15.0, 40.0]

	Pressure(Kpa)	Range
Liquid pressure	86.0	[70.0, 110.0]
Vacuum	-28.9	[-35.0, -26.0]

Administrator : Admin 07-05-2013 14:38

10.6.3 Voltage and Current

Tap "Status" > "Voltage & Current" in the menu to enter the following screen.

You may check the Voltage and Current values of different components of the analyzer.

The screenshot displays the 'QC' menu of the analyzer. At the top, there is a navigation bar with icons for Menu, Sample Analysis, Table Review, QC, Reagent Setup, Diluent, and Print. The main content area contains two tables. The first table lists voltage settings in Volts (V) and their respective ranges. The second table lists the Laser Diode Current in milliamperes (mA) and its range. At the bottom right, the user is identified as Administrator: Admin, and the date and time are 07-18-2013 15:01.

	Volt. (V)	Range
Power +12V	12.0	[11.5, 12.5]
Power +24V	25.3	[22.0, 29.0]
Analog +12V	11.9	[11.5, 12.5]
Analog -12V	-11.8	[-12.5, -11.5]
Digital +56V	56.9	[47.0, 60.0]
HGB Blank Voltage	4.5	[3.2, 4.9]
FS Blank Voltage	0.4	[0.0, 0.5]

	Current(mA)	Range
Laser Diode Current	39	[20, 70]

Administrator : Admin 07-18-2013 15:01

10.6.4 Sensor

Tap "Status" > "Sensor" in the menu to enter the following screen.
 You may check the sensor status of the analyzer.

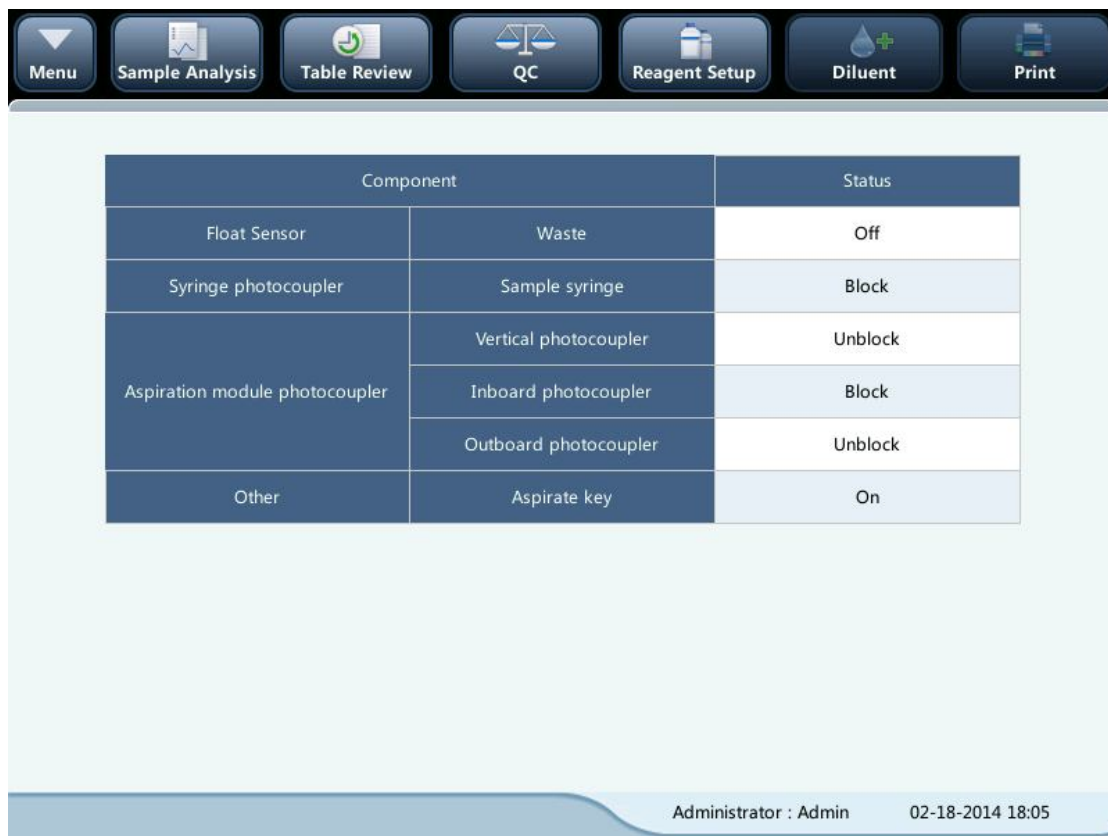

10.6.5 Version Info.

Tap "Status" > "Version Info." in the menu to enter the following screen. You may view the current version information of the analyzer.

Menu Sample Analysis Table Review QC Reagent Setup Diluent Print

Software version	Boot Software	1.3
	Kernel	V1.02.997
	System software	V01.02.03.3031
	Print drive	1.3.0
	Print template	01.02
	Sequence	1.2.229GENERAL
	Language	English
	Algorithm	2.3.4.2516
Hardware version	Data Board FPGA	2.0.1.40
	Drive Board FPGA	1.0.3.12
	Drive Board MCU	01.02.00.943
Version Info.	CD	1.2

Administrator : Admin 07-05-2013 14:39

11 Troubleshooting Your Analyzer

11.1. Introduction

This chapter contains information that is helpful in locating and correcting problems that may occur during operation of your analyzer.

NOTE

- This chapter is not a complete service manual and is limited to problems that are readily diagnosed and/or corrected by the user of the analyzer.
-

11.2. Error Information and Handling

During the operation, if error(s) is detected, the analyzer will beep and display the corresponding error message in the error information area at the bottom right of the screen. Meanwhile, the indicator will turn red.

According to the severity of the errors, the colors of error messages are red, orange, blue and green.

- Red: fatal error. When this kind of error occurs, the analyzer will stop running immediately, and any further operation is prohibited.
- Orange: error that stops operation. When this kind of error occurs, the analyzer will stop running immediately.
- Blue: error that restricts certain operations. When this kind of error occurs, the analyzer can still continue with the current operation, but any other operations related to the error will be restricted.

The following Figure is the error info. dialog box.

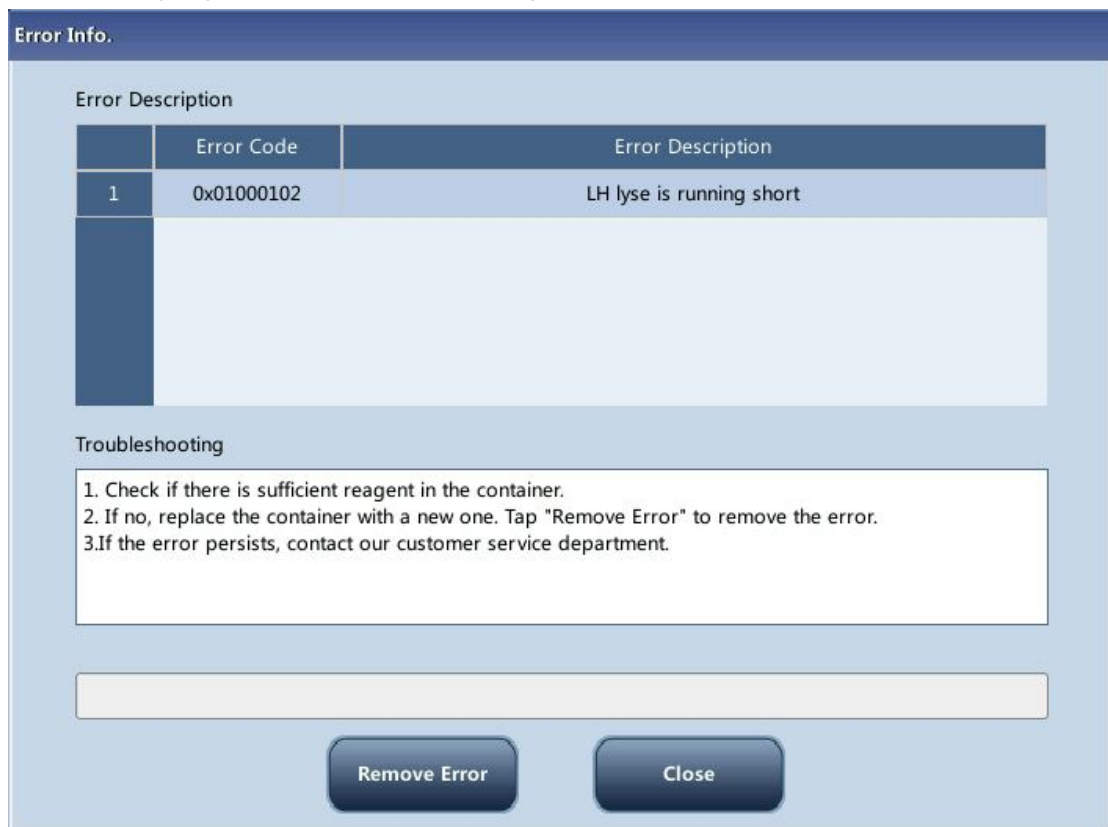

The name and troubleshooting method of the errors are displayed. Names of the errors are displayed by the order of their occurrence.

You may tap to select the error, and view its troubleshooting information in the troubleshooting box. The troubleshooting information of the first error is displayed by default. Please follow the troubleshooting to resolve the error by sequence.

The following functions are provided:

- Remove error

Tap the "Remove Error" button to clear all the errors that can be removed automatically. For the errors that cannot be removed automatically, follow the troubleshooting method to solve them.

- Close the error info. dialog box

Tap "Close" to close the dialog box, but the errors will still be displayed in the error info. area on the screen. Tap the error info. area again, the dialog box will be displayed.

The possible error(s) and the corresponding troubleshooting information are listed below:

Error Name	Actions
Communication error	<ol style="list-style-type: none"> 1. Tap "Remove Error" to see if the error can be removed. 2. If the error still exists, contact our customer service department.
Digital board error	<ol style="list-style-type: none"> 1. Power off the analyzer directly, and then contact our customer service department.
System clock error	<ol style="list-style-type: none"> 1. Power off the analyzer directly, and then contact our customer service department.
Diluent ran out	<ol style="list-style-type: none"> 1. Tap "Remove Error", and enter the new barcode of the diluent into the reagent setup dialog box. 2. After replacing the diluent container, tap "Apply" to prime diluent. 3. If the error still exists after replacing the diluent, contact our customer service department.
LH lyse ran out	<ol style="list-style-type: none"> 1. Tap "Remove Error", and enter the new barcode of the LH lyse into the reagent setup dialog box. 2. After replacing the lyse container, tap "Apply" to prime the lyse. 3. If the error still exists after replacing the lyse, contact our customer service department.
DIFF lyse ran out	<ol style="list-style-type: none"> 1. Tap "Remove Error", and enter the new barcode of the DIFF lyse into the reagent setup dialog box. 2. After replacing the lyse container, tap "Apply" to prime the lyse.

	<p>3. If the error still exists after replacing the lyse, contact our customer service department.</p>
Diluent expired	<p>1. Tap "Remove Error", and enter the new barcode of the LH lyse into the reagent setup dialog box.</p> <p>2. After replacing the lyse container, tap "Apply" to prime the lyse.</p> <p>3. If the error still exists after replacing the lyse, contact our customer service department.</p>
LH lyse expired	<p>1. Tap "Remove Error", and enter the new barcode of the LH lyse into the reagent setup dialog box.</p> <p>2. After replacing the lyse container, tap "Apply" to prime the lyse.</p> <p>3. If the error still exists after replacing the lyse, contact our customer service department.</p>
DIFF lyse expired	<p>1. Tap "Remove Error", and enter the new barcode of the DIFF lyse into the reagent setup dialog box.</p> <p>2. After replacing the lyse container, tap "Apply" to prime the lyse.</p> <p>3. If the error still exists after replacing the lyse, contact our customer service department.</p>
Waste container full	<p>Empty the waste container or use a new waste container.</p> <p>2. Tap "Remove Error" to see if the error can be removed.</p> <p>3. If the error still exists, contact our customer service department.</p>
Power source error	<p>1. Power off the analyzer directly, and then contact our customer service department.</p>
Preheat bath temperature sensor error	<p>1. Power off the analyzer directly, and then contact our customer service department.</p>
Optical assembly temperature sensor error	<p>1. Power off the analyzer directly, and then contact our customer service department.</p>
Diluent temperature sensor error	<p>1. Power off the analyzer directly, and then contact our customer service department.</p>
Preheat assembly error	<p>1. Power off the analyzer directly, and then contact our customer service department.</p>
Laser error	<p>1. Power off the analyzer directly, and then contact our</p>

	customer service department.
Syringe assembly error	<ol style="list-style-type: none"> 1. Tap "Remove Error" to see if the error can be removed. 2. If the error still exists, contact our customer service department.
Aspiration module lift mechanism error	<ol style="list-style-type: none"> 1. Tap "Remove Error" to see if the error can be removed. 2. If the error still exists, contact our customer service department.
Aspiration module rotary mechanism error	<ol style="list-style-type: none"> 1. Tap "Remove Error" to see if the error can be removed. 2. If the error still exists, contact our customer service department.
Background abnormal	<ol style="list-style-type: none"> 1. Tap "Remove Error" to see if the error can be removed. 2. If the error still exists, contact our customer service department.
Exiting standby mode failed	<ol style="list-style-type: none"> 1. Tap "Remove Error" to see if the error can be removed. 2. If the error still exists, contact our customer service department.
Replacing diluent failed	<ol style="list-style-type: none"> 1. Tap "Remove Error" to see if the error can be removed. 2. If the error still exists, contact our customer service department.
Replacing DIFF lyse failed	<ol style="list-style-type: none"> 1. Tap "Remove Error" to see if the error can be removed. 2. If the error still exists, contact our customer service department.
Replacing LH lyse failed	<ol style="list-style-type: none"> 1. Tap "Remove Error" to see if the error can be removed. 2. If the error still exists, contact our customer service department.
HGB blank voltage abnormal	<ol style="list-style-type: none"> 1. Tap "Remove Error" to see if the error can be removed. 2. If the error still exists, contact our customer service department.
Liquid pressure overloaded	<ol style="list-style-type: none"> 1. Please do "Probe Cleanser Maintenance". 2. Please do "Unclog Flow Cell". 3. Power off the analyzer directly, and restart it after a while. 4. If the error persists, contact our customer service department.
Vacuum pressure abnormal	<ol style="list-style-type: none"> 1. Tap "Remove Error" to see if the error can be removed. 2. If the error still exists, contact our customer service department.
Preheat bath temperature	<ol style="list-style-type: none"> 1. Tap "Remove Error" to see if the error can be removed.

error	2. If the error still exists, contact our customer service department.
Analyzer temperature too high	1. The ambient temperature shall be within [10°C, 30°C] 2. Diluent temperature shall be within [10°C, 30°C]. 3. Tap "Remove Error" to see if the error can be removed.
Diluent temperature too high	1. Diluent temperature shall be within [10°C, 30°C].
Diluent temperature too low	1. Diluent temperature shall be within [10°C, 30°C].
Clogging	1. Tap "Remove Error" to see if the error can be removed. 2. If the error still exists, contact our customer service department.
Aperture voltage too low	1. Tap "Remove Error" to see if the error can be removed. 2. If the error still exists, contact our customer service department.
Impedance channel signal abnormal	1. Please eliminate sources of interference. 2. Tap "Remove Error" to see if the error can be removed.
Analysis is abnormal	1. Tap "Remove Error" button to remove the error. 2. If the error persists, power off the analyzer and power on later. 3. If the error persists, contact our customer service department.
RBC channel is abnormal	1. Please check the analysis mode. 2. Tap "Remove Error" button to remove the error. 3. If the error persists, power off the analyzer and power on later. 4. If the error persists, contact our customer service department.
DIFF channel is abnormal	1. Please check the DIFF lyse residue and the analysis mode. 2. Tap "Remove Error" button to remove the error. 3. If the error persists, power off the analyzer and power on later. 4. If the error persists, contact our customer service department.
BASO channel is abnormal	1. Please check the LH lyse residue and the analysis mode. 2. Tap "Remove Error" button to remove the error. 3. If the error persists, power off the analyzer and power on later. 4. If the error persists, contact our customer service department.

12 Appendices

A. Index

- Analysis, 5-12
- Aspiration, 3-2
- Auto-Sleep, 5-21
- buzzer, 2-10
- Calibration, 8-1
- calibrators, 2-13
- Capillary whole blood samples, 5-10
- Colorimetric Method, 3-6
- controls, 2-13
- Dilution, 3-3
- Electrical Impedance Method, 3-7
- Flow Cytometry by Laser, 3-5
- Graph Review, 6-3
- hardware, 1-2
- Initial Checks, 5-3
- Installation, 4-2
- Logon, 5-4
- Logs, 10-14
- maintenance, 10-1
- Manual Calibration, 8-5
- Parameter flags, 5-18
- Parameters, 2-2
- Prediluted samples, 5-10
- Quality Control, 7-1
- Reagents, 2-12
- Self-Test, 10-10
- Setup, 9-1
- Shutdown, 5-23
- software, 1-2
- Startup, 5-4
- Table Review, 6-2
- Touch Screen Calibration, 10-13
- Transmission, 6-8
- troubleshooting, 11-2
- Whole blood samples, 5-10

B. Specifications

B.1. Classification

According to the CE classification, the BC-5150 belongs to In vitro diagnostic medical devices other than those covered by Annex II and devices for performance evaluation.

B.2. Reagents

Diluent	M-52 D diluent
Lyse	M-52 DIFF lyse
	M-52 LH lyse
/	Probe cleanser

B.3. Applicable Tubes

The following tubes can be used:

Φ12~15×75mm evacuated collection tube (without cap) for whole blood mode

Φ11×40mm (1.5ml centrifugal tube) and 0.5ml centrifugal tube for pre-dilute and capillary whole blood mode.

Φ10.7×42mm small closed anticoagulated tube (without cap), 0.5ml, can be used with cap opened, for capillary whole blood mode. Recommended tube: No. 365974 closed anticoagulated tube (0.5ml) manufactured by BD.

B.4. Parameters

Parameter	Abbreviation	Default Unit
White Blood Cell count	WBC	10 ⁹ / L
Basophils number	Bas#	10 ⁹ / L
Basophils percentage	Bas%	%
Neutrophils number	Neu#	10 ⁹ / L
Neutrophils percentage	Neu%	%
Eosinophils number	Eos#	10 ⁹ / L
Eosinophils percentage	Eos%	%
Lymphocytes number	Lym#	10 ⁹ / L
Lymphocytes percentage	Lym%	%
Monocytes number	Mon#	10 ⁹ / L
Monocytes percentage	Mon%	%
Abnormal Lymphocyte number	ALY# (RUO parameter)	10 ⁹ / L
Abnormal Lymphocytes	ALY% (RUO parameter)	%
Large Immature Cell number	LIC# (RUO parameter)	10 ⁹ / L

Large Immature Cell	LIC% (RUO parameter)	%
Red Blood Cell count	RBC	10^{12} / L
Hemoglobin Concentration	HGB	g/L
Mean Corpuscular Volume	MCV	fL
Mean Corpuscular Hemoglobin	MCH	pg
Mean Corpuscular Hemoglobin	MCHC	g/L
Red Blood Cell Distribution	RDW-CV	%
Red Blood Cell Distribution	RDW-SD	fL
Hematocrit	HCT	%
Platelet count	PLT	10^9 / L
Mean Platelet Volume	MPV	fL
Platelet Distribution Width	PDW	None
Plateletcrit	PCT	%
Platelet-Large Cell Ratio	P-LCR	%
Platelet Larger Cell Count	P-LCC	10^9 / L
White blood Cell Histogram	WBC Histogram	None
Red blood Cell Histogram	RBC Histogram	None
Platelet Histogram	PLT Histogram	None
Differential Scattergram	Diff Scattergram	None

B.5. Sampling Features

B.5.1. Sample Volumes Required for Each Analysis

Whole blood and capillary whole blood mode	≤15ul under both CBC and CBC+DIFF modes
Pre-diluted mode	≤20ul under both CBC and CBC+DIFF modes

B.5.2. Throughput

Open vial-whole blood, open vial-pre-diluted and open vial-capillary whole blood modes:
no less than 60 samples per hour

B.6. Performance Specifications

B.6.1. Display Range

Parameter	Display range
WBC	$0.00 \times 10^9/L \sim 999.99 \times 10^9/L$
RBC	$0.00 \times 10^{12}/L \sim 18.00 \times 10^{12}/L$
HGB	0 g/L ~ 300g/L
PLT	$0 \times 10^9/L \sim 9999 \times 10^9/L$

HCT	0%~80%
-----	--------

B.6.2. Background/Blank Count

Parameter	Background/blank count requirements
WBC	$\leq 0.20 \times 10^9 / L$
RBC	$\leq 0.02 \times 10^{12} / L$
HGB	$\leq 1 g / L$
HCT	$\leq 0.5 \%$
PLT	$\leq 10 \times 10^9 / L$

B.6.3. Linearity Range

Parameter	Linearity Range	Deviation Range (Whole Blood)	Deviation Range (Pre-diluted)
WBC	0.00×10 ⁹ /L ~ 100.00×10 ⁹ /L	±0.30×10 ⁹ /L or ±5%	±0.60×10 ⁹ /L or ±6%
	100.01×10 ⁹ /L ~ 500.00×10 ⁹ /L	±10%	±12%
RBC	0.00×10 ¹² /L ~ 8.00×10 ¹² /L	±0.05×10 ¹² /L or ±5%	±0.10×10 ¹² /L or ±10%
	8.00×10 ¹² /L		
HGB	0 g/L ~ 250g/L	±2g/L or ±2%	±4g/L or ±4%
PLT	0×10 ⁹ /L ~ 1000×10 ⁹ /L	±10×10 ⁹ /L or ±8%	±20×10 ⁹ /L or ±16%
	1001×10 ⁹ /L ~ 5000×10 ⁹ /L	±12%	±20%

B.6.4. Deviation of Reading

Parameter	Deviation of Reading
WBC	$\leq \pm 10 \%$
RBC	$\leq \pm 6 \%$
HGB	$\leq \pm 7 \%$
PLT	$\leq \pm 15 \%$

B.6.5. Compatibility

Deviation ranges: WBC $\leq \pm 5 \%$, RBC $\leq \pm 2 \%$, HGB $\leq \pm 2 \%$, PLT $\leq \pm 8 \%$, HCT/MCV $\leq \pm 3 \%$.

B.6.6. Reproducibility

Parameter	Condition	Whole Blood Reproducibility (CV/absolute deviation d)	Pre-diluted Reproducibility (CV/absolute deviation d)
WBC	$4.00 \times 10^9 / L \sim 15.00 \times 10^9 / L$	$\leq 2.5\%$	$\leq 4.0\%$
Neu%	50.0% ~ 70.0%	$\pm 4.0(d)$	$\pm 8.0(d)$
Lym%	20.0% ~ 40.0%	$\pm 3.0(d)$	$\pm 6.0(d)$
Mon%	5.0% ~ 10.0%	$\pm 2.0(d)$	$\pm 4.0(d)$
Eos%	2.0% ~ 5.0%	$\pm 1.5(d)$	$\pm 2.5(d)$
Bas%	0.5% ~ 1.5%	$\pm 0.8(d)$	$\pm 1.2(d)$
RBC	$3.50 \times 10^{12} / L \sim 6.00 \times 10^{12} / L$	$\leq 1.5\%$	$\leq 3.0\%$
HGB	110 g/L ~ 180 g/L	$\leq 1.5\%$	$\leq 3.0\%$
MCV	70 fL ~ 120 fL	$\leq 1.0\%$	$\leq 2.0\%$
PLT	$100 \times 10^9 / L \sim 149 \times 10^9 / L$	$\leq 6.0\%$	$\leq 10.0\%$
	$150 \times 10^9 / L \sim 500 \times 10^9 / L$	$\leq 4.0\%$	$\leq 8.0\%$
MPV	/	$\leq 4.0\%$	$\leq 8.0\%$

B.6.7. Carryover

Parameter	Carryover
WBC	$\leq 0.5\%$
RBC	$\leq 0.5\%$
HGB	$\leq 0.6\%$
HCT	$\leq 0.5\%$
PLT	$\leq 1.0\%$

B.7. Input/Output Device**⚠ WARNING**

- Be sure to use the specified devices only.

NOTE

- If the analyzer is to be connected with LIS, the PC must be configured with dual network cards.

B.7.1. External Computer (optional)

Recommended PC configurations: CPU Intel® 1.6GHz and above

RAM: 1G or above

Hard disk: 160GB or above

Recommended resolution of the display 1280*1024(standard), 1680*1050 (wide screen)

Operating system: Microsoft Windows 7 or above, with DVD-ROM.

B.7.2. Keyboard (Optional)

101-Key alpha-numeric keyboard

B.7.3. Mouse (Optional)

B.7.4. External Barcode Scanner (Optional)

B.7.5. Printer (Optional)

B.8. Interfaces

4 USB ports

B.9. Power Supply

	Voltage	Input power	Frequency
Analyzer	(100V-240V~)±10%	300 VA	(50Hz/60Hz)±1Hz

B.10. FUSE

⚠ WARNING

- Use specified fuse only.

Fuse specification: 250V T3.15AH

B.11. EMC Description

1. Do not use this device in close proximity to sources of strong electromagnetic radiation (e.g. unshielded intentional RF sources), as these may interfere with the proper operation.
2. This equipment complies with the emission and immunity requirements of the EN61326-1:2006 and EN61326-2-6:2006.
3. NOTE1 it is the manufacturer's responsibility to provide equipment electromagnetic compatibility information to the customer or user.

NOTE2 it is the user's responsibility to ensure that a compatible electromagnetic environment for the equipment can be maintained in order that the device will perform as intended.

B.12. Sound

Maximal sound: 65 dBA

NOTE

- Be sure to use and store the analyzer in the specified environment.
-

B.13. Operating Environment

Optimal operating temperature: 10 °C~30 °C

Optimal operating humidity: 20 %~85 %

Atmospheric pressure: 70 kPa~106 kPa

B.14. Storage Environment

Ambient temperature: -10 °C~40 °C

Relative humidity: 10 %~90 %

Atmospheric pressure: 50 kPa~106 kPa

B.15. Running Environment

Ambient temperature: 10 °C~40 °C

Relative humidity: 10 %~90 %

Atmospheric pressure: 70 kPa~106 kPa

B.16. Dimensions and Weight

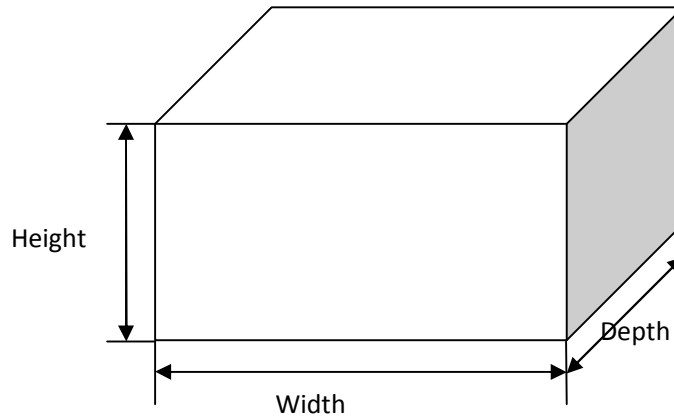

BC-5150	Analyzer
Dimensions	Width(mm) \leq 325 Height (mm) \leq 435 (with foot) Depth (mm) \leq 410
Weight	\leq 25Kg

B.17. Contraindications

None

B.18. Safety Classification

Level of transient overvoltage: Category II.

Rated pollution degree: 2.



046-005389-00(5.0)

P/N: 046-005389-00(5.0)