

**THE NETHERLANDS
(N E D E R L A N D)****COMMUNICATION**Concerning ⁽¹⁾:

- ~~approval granted~~
- approval extended
- ~~approval refused~~
- ~~approval withdrawn~~
- ~~production definitely discontinued~~

of a type of tyre for motor vehicles pursuant to Regulation number 30.

Approval number: E4-30R-0298353**Extension number: 03**

1. Manufacturer's name and address : Shandong Longyue Rubber Co., Ltd.
The South of Yalujiang Road Wenzhuang
Village Qinghe Agency of Cao County
Heze City, Shandong Province 274400
China (PRC)
2. Tyre type designation ⁽²⁾ :
- 2.1. Brand-name(s)/trademark(s) : GRENLANDER; ARIVO; T TYRE;
CONSTANCY; ILINK; LUXXAN; RHINO;
CRYSTAL; ROCKBLADE; FRONWAY;
SAILWIN; XBRI; ROADMARCH

- 2.2. Trade description(s)/Commercial name(s) : COLO H01; L-GRIP66; LY168; ECOGREEN 66; VENUSATR 66; PREMIO ARZ1; ECOLOGY; INSPIRER C4; THREE; ROCK 515; Winter GL868; Winter IL868; LY868; ICEPOWER 868; ICEWINNER 868; WINMASTER ARW2; ROCK 868S; Energize; PRIMESTAR 66; INSPIRER W20; THIRTY TWO; SNOWROVER 868; GREENWING A/S; MULTIMATCH A/S; FRONWING A/S; FREIMATCH A/S; Carlforful A/S; INSPIRER A/S 1; FORTY ONE; ROCK A/S ONE; PRIME A/S; L-ZEAL56; LY566; SPEEDWAY 56; SPORTWAY 56; ULTRA ARZ5; SPORT+; INSPIRER S4; EMOTION; TEN; Drift; ROCK 566; ENRI U08; THUNDER U09; LY169; EURUS 08; VENUSATR 08; ULTRA ARZ4; SPORT+2; INSPIRER S8; FOUR; Envoy; ROCK 525; PRIME UHP 08; MAHO 77; POWERCITY 77; TOPOWER 87 H/T; ROADPOWER H/T; ROADKING H/T; TERRANO ARV H/T; FORZA H/T2; INSPIRER F4; TWENTY TWO; Maxim; ROCK 717 H/T; PRIMEMARCH H/T 77; MAGA A/T TWO; TERRA MAX LSR2 A/T; TERRA XPLOER C2 A/T; ROCKBLADE A/T II; GLADIATAX A/T II; TERRAMAX ARV PRO A/T; FORZA A/T2; INSPIRER A/T II; TOUGH TRAC A/T II; ROCK 737 A/T; PRIMEMAX A/T II; MAGA A/T ONE; TERRA MAX LSR1 A/T; TERRA XPLOER C1 A/T; ROCKBLADE A/T I; GLADIATAX A/T I; TERRAMAX ARV A/T; FORZA A/T; INSPIRER A/T I; TOUGH TRAC A/T I; ROCK 727 A/T; PRIMEMAX A/T I
3. If applicable, name and address of the manufacturer's representative : N/A
4. Summarised description :
- 4.1. Tyre size designation : 215/65R16
- 4.2. Category of use : ~~normal~~/snow/~~special use~~/temporary use ⁽¹⁾
- 4.3. Structure : ~~diagonal/bias belted~~/radial/~~run flat~~ tyre ⁽¹⁾
- 4.4. Speed category symbol : H
- 4.5. Load-capacity index : 98



5. Technical service and, where applicable, test laboratory approved for purposes of approval or of verification of conformity : CSI S.p.A.
Viale Lombardia 20
20021 Bollate (MI)
Italy
6. Date of report issued by that service : 16/11/2018
07/06/2019
7. Number of report issued by that service : 86-R30-3291/18-00
0124\ISP\OMLS\19_38
8. Reason(s) of extension (if applicable) : Addition of trademark and trade descriptions
9. Any remarks : Change of technical service
10. Place : Zoetermeer
11. Date : 11 July 2019
12. Signature :

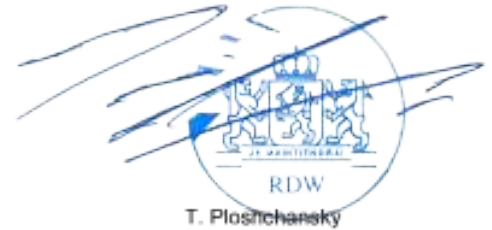

13. The list of documents in the approval file which are deposited at the administrative service having delivered the approval and which can be obtained upon request.
- Application form relating to ECE approval for a pneumatic tyre pursuant to Regulation number 30.
 - The drawing of the tyre's sidewalls, tread and dimensioned cross-section.
 - The test report as mentioned in item 7.

⁽¹⁾ Strike out what does not apply.

⁽²⁾ A list of Brand name(s)/trademark(s) or Trade description(s)/ Commercial name(s) may be annexed to this communication

RAPPORTO DI PROVA / TEST REPORT

NUMBER

0124\ISP\OMLS\19_38

ISSUE DATE

07/06/2019

DIVISION

AUTOMOTIVE

LABORATORY

Homologation

SPECIMEN DESCRIPTION

Tyre Size

215/65R16**APPROVAL EXTENSION TESTS****MANUFACTURER****Shandong Longyue Rubber Co., Ltd.**

The South of Yalujiang Road, Wenzhuang Village Qinghe Agency of Cao County
Heze City, Shandong Province 274400 China (PRC)

REFERENCE STANDARD**Regulation 30/02**

Supplement 20

(E/ECE/324/ Rev.1/Add.29/Rev.3/Amend.6 – E/ECE/TRANS/505/ Rev.1/Add.29/Rev.3/Amend.6)



GENERAL DATA

Test date:	N/A
Test site:	N/A
Sampling:	N/A
Deviation from test methods:	N/A

DECLARATIONS

Test results contained in this test report pertain exclusively to the tested specimen.

This test report cannot be reproduced partially without the consent of the test center managing director.



PRODUCT IDENTIFICATION

Manufacturer's name	Shandong Longyue Rubber Co., Ltd.
Address(es) of Manufacturing plant(s)	The South of Yalujiang Road, Wenzhuang Village Qinghe Agency of Cao County Heze City, Shandong Province 274400 China (PRC)
Brand-name(s) / trademark(s)	GRENLANDER; ARIVO; T TYRE; CONSTANCY; ILINK; LUXXAN; RHINO; CRYSTAL; ROCKBLADE; FRONWAY; SAILWIN; XBRI; <u>ROADMARCH</u>
Trade description(s) / Commercial name(s)	COLO H01; L-GRIP66; LY168; ECOGREEN 66; VENUSATR 66; PREMIO ARZ1; ECOLOGY; INSPIRER C4; THREE; ROCK 515; Winter GL868; Winter IL868; LY868; ICEPOWER 868; ICEWINNER 868; WINMASTER ARW2; ROCK 868S; <u>Energize;</u> <u>PRIMESTAR 66; INSPIRER W20; THIRTY TWO; SNOWROVER</u> <u>868; GREENWING A/S; MULTIMATCH A/S; FRONWING A/S;</u> <u>FREIMATCH A/S; Carlorful A/S; INSPIRER A/S 1; FORTY</u> <u>ONE; ROCK A/S ONE; PRIME A/S; L-ZEAL56; LY566;</u> <u>SPEEDWAY 56; SPORTWAY 56; ULTRA ARZ5; SPORT+;</u> <u>INSPIRER S4; EMOTION; TEN; Drift; ROCK 566; ENRI U08;</u> <u>THUNDER U09; LY169; EURUS 08; VENUSATR 08; ULTRA</u> <u>ARZ4; SPORT+2; INSPIRER S8; FOUR; Envoy; ROCK 525;</u> <u>PRIME UHP 08; MAHO 77; POWERCITY 77; TOPOWER 87</u> <u>H/T; ROADPOWER H/T; ROADKING H/T; TERRANO ARV H/T;</u> <u>FORZA H/T2; INSPIRER F4; TWENTY TWO; Maxim; ROCK 717</u> <u>H/T; PRIMEMARCH H/T 77; MAGA A/T TWO;</u> <u>TERRA MAX LSR2 A/T; TERRA XPLOER C2 A/T;</u> <u>ROCKBLADE A/T II; GLADIATAX A/T II; TERRAMAX ARV</u> <u>PRO A/T; FORZA A/T2; INSPIRER A/T II; TOUGH TRAC A/T</u> <u>II; ROCK 737 A/T; PRIMEMAX A/T II; MAGA A/T ONE;</u> <u>TERRA MAX LSR1 A/T; TERRA XPLOER C1 A/T;</u> <u>ROCKBLADE A/T I; GLADIATAX A/T I; TERRAMAX ARV</u> <u>A/T; FORZA A/T; INSPIRER A/T I; TOUGH TRAC A/T I;</u> <u>ROCK 727 A/T; PRIMEMAX A/T I</u>
Tyre size designation	215/65R16
Category of use	Snow



Tyre structure	Radial
Speed category symbol	H
Load capacity index	98

TYRE MAIN FEATURES

See attached Technical Sheet.



APPROVAL STATUS

Approval Number: E4-30R-0298353-02

Last amended on: 17/01/2019

For details, see test reports:

- 86-R30-3291/18-00 issued on 16/11/2018 by TÜV Rheinland Kraftfahrt GmbH

REASON FOR EXTENSION

- Addition of trademark and trade descriptions



SUMMARY OF TEST RESULTS

The results of the previous tests are still valid as no difference can affect tests already performed and all new variant/versions fulfil the requirements of Regulation ECE 30/02.

Tests and verification		PASS	FAIL	N/A	R
1	Test tyre details	<input checked="" type="checkbox"/>	<input type="checkbox"/>	<input type="checkbox"/>	
2	Test results	<input checked="" type="checkbox"/>	<input type="checkbox"/>	<input type="checkbox"/>	



RESULTS

Following verification and tests performed, we declare that the products submitted for approval comply with all technical requirements of UNECE Regulation 30/02.

DATA
Date

07/06/2019

Settore Omologazioni
Test Engineer

Luca Bolgiani

**Area Omologazioni**
Homologation Area

Ing. Daniele Gervasini

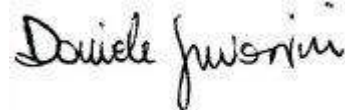

Documento firmato digitalmente ai sensi del D. Lgs. N. 82 del 7 Marzo 2005 e successive modifiche
Digitally signed document in accordance with Legislative Decree n. 82 dated March 7th 2005 and subsequent amendments.



APPLICATION FOR APPROVAL EXTENSION OF A TYPE OF PNEUMATIC TYRE ACCORDING
TO ECE REGULATION No. 30, 02 SERIES OF AMENDMENTS

- | | | |
|------|----------------------------------------------------------------------|--------------------------------------------------------------------------------------------------------------------------------------------------------------------------------------------------------------------------------------------------------------------------------------------------------------------------------------------------------------------------------------------------------------------------------------------------------------------------------------------------------------------------------------------------------------------------------------------------------------------------------------------------------------------------------------------------------------------------------------------------------------------------------------------------------------------------------------------------------------------------------------------------------------------------------------------------------------------------------------------------------------------------------------------------------------------------------------------------------------------------------------------------------------------------------------------------------------------------------------------------------------------------------------------------------------------------------------------------------------------------------------------------------------------------------------------------------------------------------------------------------------------------------------------------------------------------------------------------------------------------------------------------------------------------------------------------------------------------------------------------------------------------------------------|
| 1. | Manufacturer's name or trade mark(s) on the tyre type ⁽²⁾ | : GRENLANDER; ARIVO; T TYRE; CONSTANCY; ILINK; LUXXAN; RHINO; CRYSTAL; ROCKBLADE; FRONWAY; SAILWIN; XBRI; <u>ROADMARCH</u> |
| 2. | Tyre type designation by the manufacturer ⁽²⁾ | : COLO H01; L-GRIP66; LY168; ECOGREEN 66; VENUSATR 66; PREMIO ARZ1; ECOLOGY; INSPIRER C4; THREE; ROCK 515; Winter GL868; Winter IL868; LY868; ICEPOWER 868; ICEWINNER 868; WINMASTER ARW2; ROCK 868S; <u>Energize</u> ; <u>PRIMESTAR 66</u> ; <u>INSPIRER W20</u> ; <u>THIRTY TWO</u> ; <u>SNOWROVER 868</u> ; <u>GREENWING A/S</u> ; <u>MULTIMATCH A/S</u> ; <u>FRONWING A/S</u> ; <u>FREIMATCH A/S</u> ; <u>Carlorful A/S</u> ; <u>INSPIRER A/S 1</u> ; <u>FORTY ONE</u> ; <u>ROCK A/S ONE</u> ; <u>PRIME A/S</u> ; <u>L-ZEAL56</u> ; <u>LY566</u> ; <u>SPEEDWAY 56</u> ; <u>SPORTWAY 56</u> ; <u>ULTRA ARZ5</u> ; <u>SPORT+</u> ; <u>INSPIRER S4</u> ; <u>EMOTION</u> ; <u>TEN</u> ; <u>Drift</u> ; <u>ROCK 566</u> ; <u>ENRI U08</u> ; <u>THUNDER U09</u> ; <u>LY169</u> ; <u>EURUS 08</u> ; <u>VENUSATR 08</u> ; <u>ULTRA ARZ4</u> ; <u>SPORT+2</u> ; <u>INSPIRER S8</u> ; <u>FOUR</u> ; <u>Envoy</u> ; <u>ROCK 525</u> ; <u>PRIME UHP 08</u> ; <u>MAHO 77</u> ; <u>POWERCITY 77</u> ; <u>TOPOWER 87 H/T</u> ; <u>ROADPOWER H/T</u> ; <u>ROADKING H/T</u> ; <u>TERRANO ARV H/T</u> ; <u>FORZA H/T2</u> ; <u>INSPIRER F4</u> ; <u>TWENTY TWO</u> ; <u>Maxim</u> ; <u>ROCK 717 H/T</u> ; <u>PRIMEMARCH H/T 77</u> ; <u>MAGA A/T TWO</u> ; <u>TERRA MAX LSR2 A/T</u> ; <u>TERRA XPLOER C2 A/T</u> ; <u>ROCKBLADE A/T II</u> ; <u>GLADIATAX A/T II</u> ; <u>TERRAMAX ARV PRO A/T</u> ; <u>FORZA A/T2</u> ; <u>INSPIRER A/T II</u> ; <u>TOUGH TRAC A/T II</u> ; <u>ROCK 737 A/T</u> ; <u>PRIMEMAX A/T II</u> ; <u>MAGA A/T ONE</u> ; <u>TERRA MAX LSR1 A/T</u> ; <u>TERRA XPLOER C1 A/T</u> ; <u>ROCKBLADE A/T I</u> ; <u>GLADIATAX A/T I</u> ; <u>TERRAMAX ARV A/T</u> ; <u>FORZA A/T</u> ; <u>INSPIRER A/T I</u> ; <u>TOUGH TRAC A/T I</u> ; <u>ROCK 727 A/T</u> ; <u>PRIMEMAX A/T I</u> |
| 3. | Manufacturer's name and address | : Shandong Longyue Rubber Co., Ltd.
The South of Yalujiang Road, Wenzhuang Village Qinghe Agency of Cao County Heze City, Shandong Province 274400 China(PROC) |
| 4. | If applicable, name and address of the manufacturer's representative | : N.A. |
| 5. | Summarized description | |
| 5.1. | Tyre size designation | : 215/65R16 |
| 5.2. | Category of use | : normal /snow/ special use / temporary use ⁽¹⁾ |
| 5.3. | Structure | : diagonal / bias belted / <u>radial</u> / run flat tyre ⁽¹⁾ |
| 5.4. | Speed category symbol | H |
| 5.5. | Load-capacity index | 98 |
| 6. | Overall dimensions | : Calculated/ Annex 5 ⁽¹⁾ |
| | overall section width | : 222.7 |
| | outer diameter | : 686 |
| 7. | Factor 'x' | : 0.7 |
| 8. | Rims on which the tyre can be mounted | : 6½J |
| 9. | Measuring rim and test rim | : See attached test report |
| 10. | State whether the tyre is | : Tubeless / tube type ⁽¹⁾ |
| 11. | State whether the tyre is | : Standard / reinforced ⁽¹⁾ |
| 12. | State if special use tyre | : N.A. |

(1) Strike out what does not apply.

(2) Modified points are underlined for extension.



Professional Off-Road : ~~Yes~~/no⁽¹⁾

Tread depth : N.A.

Void to fill ratio : N.A.

13. Submitted for approval on (date) : April 11, 2019

We herewith declare that we have not applied and will not apply for approval with another Contracting Party of the ECE for the same type of product.

MANUFACTURER'S STAMP

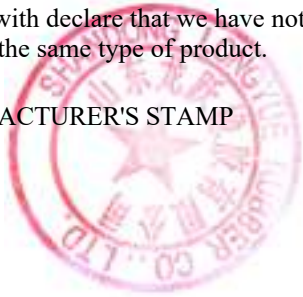

Signature :

Ren Hailong

.....

Name: Ren Hailong

THIS APPLICATION IS ACCOMPANIED BY:

- A drawing of the tyre's side wall, tread and dimensioned cross section.
- The test report.

(1) Strike out what does not apply.

(2) Modified points are underlined for extension.



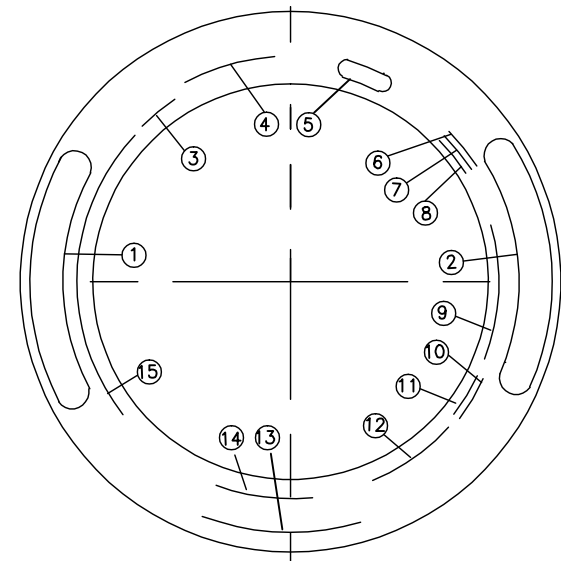
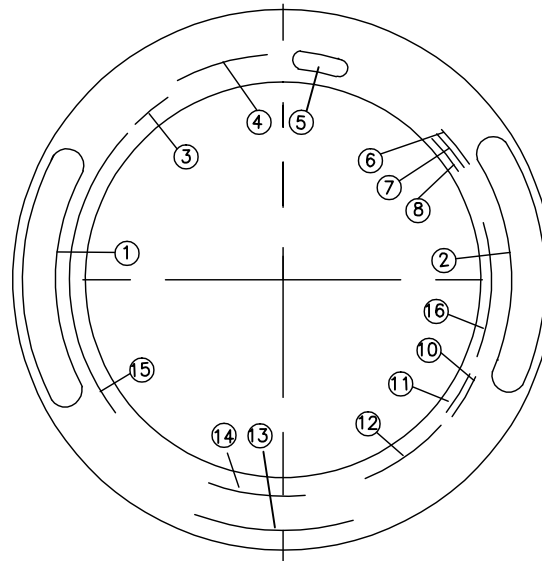
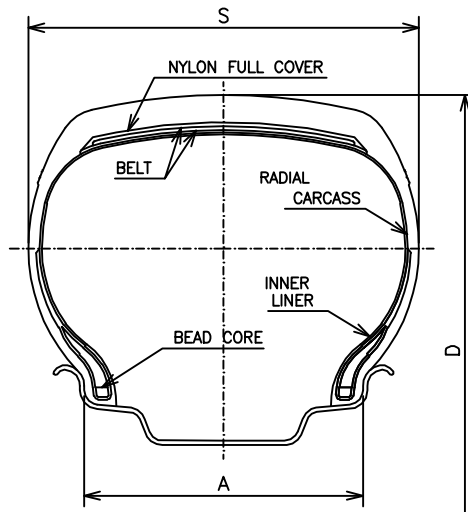

UPPER

LOWER

TREAD PATTERNS
REFER TO ATTACHMENT NO.11

1	CONSTANCY; I LINK; LUXXAN; RHINO; ARIVO; GRENLANDER; T TYRE; CRYSTAL; ROCKBLADE; FRONWAY; SAILWIN; XBRI; ROADMARCH	9	DOT 17B JNEAPA XXXX (DATE CODE)
2	COLO H01; L-GRIP66; LY168; ECOGREEN 66; VENUSATR 66; PREMIO ARZ1; ECOLOGY; INSPIRER C4; THREE; ROCK 515; Energize; PRIMESTAR 66	10	RADIAL
3	M+S	11	TUBELESS
4	215/65R16 98H	12	PLIES:TREAD 2POLYESTER 2STEEL 1NYLON SIDEWALL 2POLYESTER
5	ECE APPROVAL MARK	13	TREADWEAR 420 TRACTION A TEMPERATURE A
6	RIM:NOM. WIDTH 6 1/2J	14	MAX. LOAD 750 kg(1653 LBS) MAX. PRESSURE 300 kPa(44 PSI)
7	MOLD No.	15	SAFETY WARNING
8	MADE IN CHINA	16	DOT 17B JNEAPA

TIRE SIZE	D(mm)	S(mm)	A(mm)	LOAD INDEX SPEED CODE	REMARK
215/65R16	686	221	165	98H	—

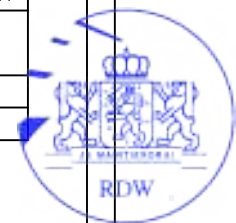

SCALE : FREE	DATE : 2019.4.11	DESIGNED BY	CHECKED BY	APPROVED BY	DRAWING NO.	
SHANDONG LONGYUE RUBBER CO., LTD.		Li Zun	Xie Baoshan	Shen Maoqiao	TITLE	215/65R16 98H

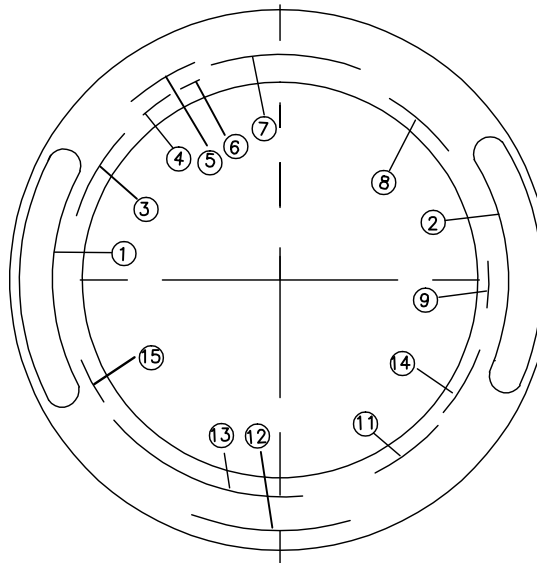
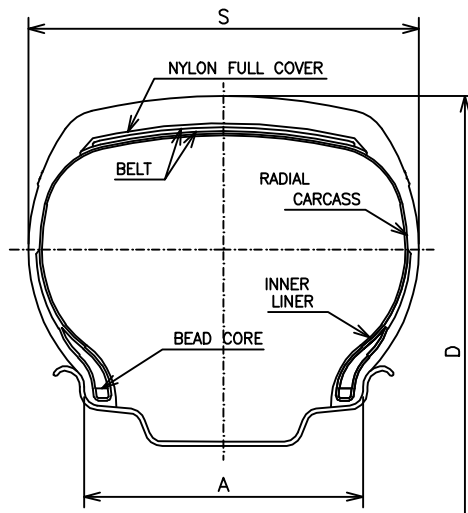

UPPER

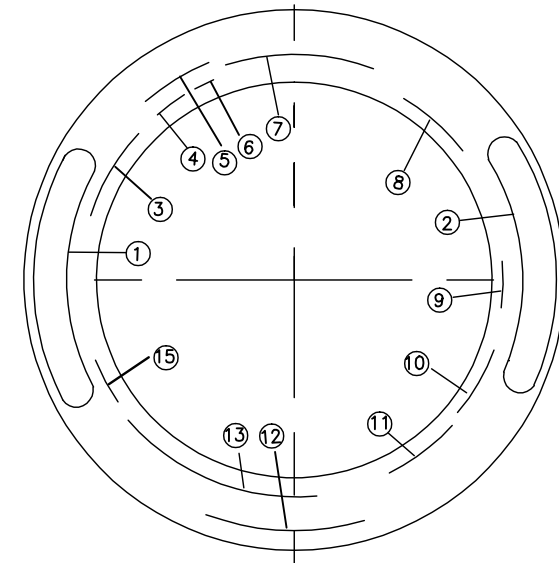

LOWER

TREAD PATTERNS
REFER TO ATTACHMENT NO.11

1	CONSTANCY; ILINK; LUXXAN; RHINO; ARIVO; GRENLANDER; T TYRE; CRYSTAL; ROCKBLADE; FRONWAY; SAILWIN; XBRI; ROADMARCH	8	MAX. LOAD 750 kg(1653 LBS) MAX. PRESS. 300 kPa(44 PSI)
2	Winter GL868; Winter IL868; LY868; ICEPOWER 868; ICEWINNER 868; WINMASTER ARW2; ROCK 868S; INSPIRER W20; THIRTY TWO; SNOWROVER 868	9	MADE IN CHINA
3	PLIES:TREAD 2POLYESTER+2STEEL+1NYLON SIDEWALL 2POLYESTER	10	DOT 17B XXXXXX XXXX (DATE CODE)
4	RIM:6 1/2 J	11	ECE APPROVAL MARK
5	RADIAL TUBELESS	12	OUTSIDE(LOWER)/INSIDE(UPPER)
6	MOLD No.	13	SAFETY WARNING
7	215/65R16 98H M+S	14	DOT 17B XXXXXX
		15	

TIRE SIZE	D(mm)	S(mm)	A(mm)	LOAD INDEX SPEED CODE	REMARK
215/65R16	686	221	165	98H	—

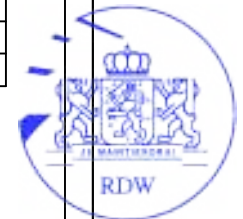

SCALE : FREE	DATE : 2019.4.11	DESIGNED BY	CHECKED BY	APPROVED BY	DRAWING NO.
SHANDONG LONGYUE RUBBER CO., LTD.	Wang Tong	Xie Baoshan	Shen Maoqiao	TITLE	215/65R16 98H

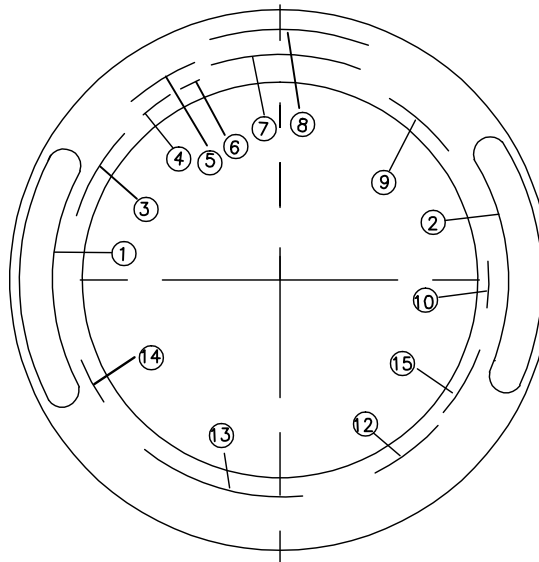
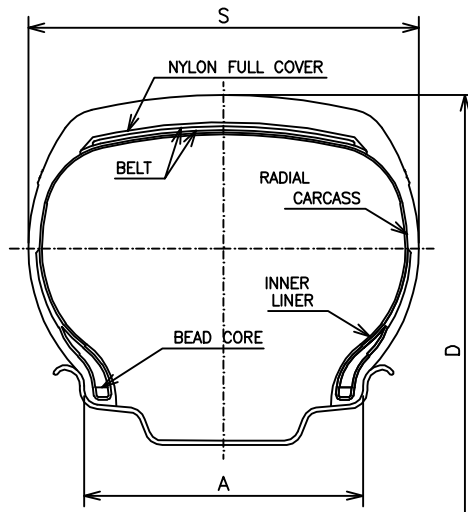

UPPER

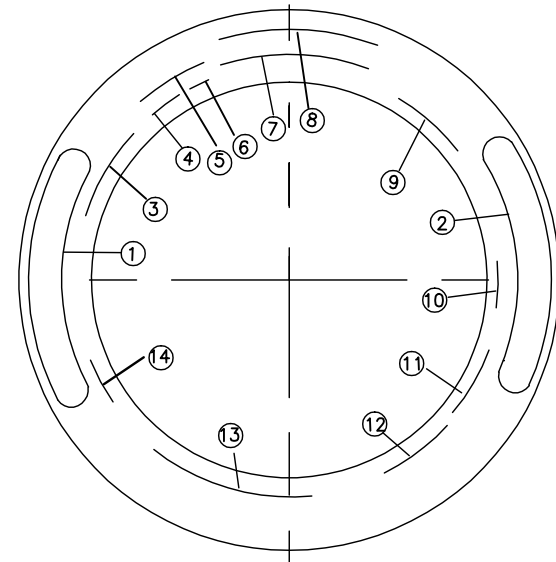

LOWER

TREAD PATTERNS
REFER TO ATTACHMENT NO.11

1	CONSTANCY; I LINK; LUXXAN; RHINO; ARIVO; GREENLANDER; T TYRE; CRYSTAL; ROCKBLADE; FRONWAY; SAILWIN; XBRI; ROADMARCH	8	ROTATION
2	<u>GREENWING A/S; MULTIMATCH A/S; FRONWING A/S; FREIMATCH A/S; Carlorful A/S; PRIME A/S; ROCK A/S ONE; FORTY ONE; INSPIRER A/S 1</u>	9	MAX. LOAD 750kg(1653 LBS) MAX. PRESS. 300kPa(44 PSI)
3	PLIES:TREAD 2POLYESTER+2STEEL+1NYLON SIDEWALL 2POLYESTER	10	MADE IN CHINA
4	RIM:6 1/2J	11	DOT 17B XXXXXX XXXX (DATE CODE)
5	RADIAL TUBELESS	12	ECE APPROVAL MARK
6	MOLD No.	13	SAFETY WARNING
7	215/65R16 98H M+S	14	ALL SEASONS
		15	DOT 17B XXXXXX

TIRE SIZE	D(mm)	S(mm)	A(mm)	LOAD INDEX SPEED CODE	REMARK
215/65R16	686	221	165	98H	—



SCALE : FREE	DATE : 2019.4.11	DESIGNED BY	CHECKED BY	APPROVED BY	DRAWING NO.
SHANDONG LONGYUE RUBBER CO., LTD.	Wang Tong	Xie Baoshan	Shen Maoqiao	TITLE	215/65R16 98H

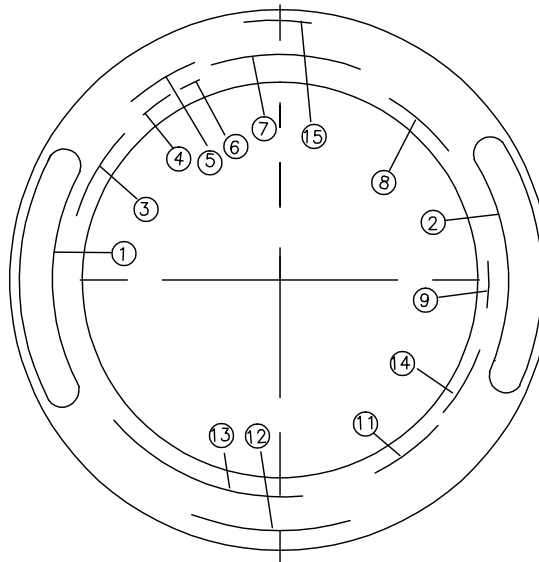
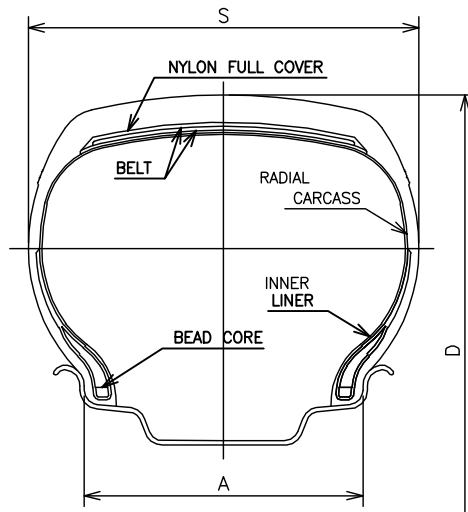

UPPER

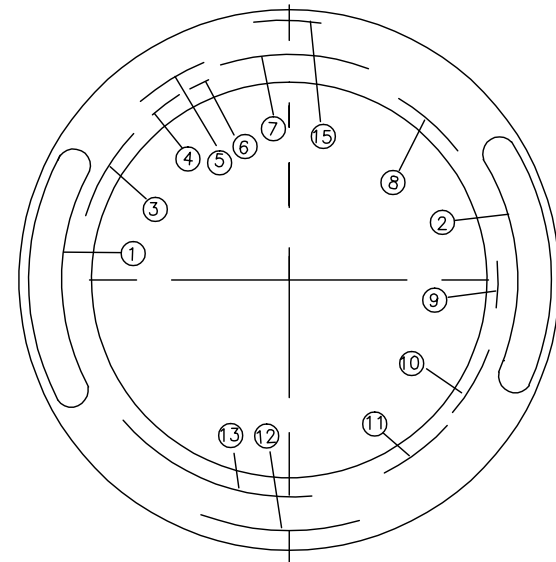

LOWER

TREAD PATTERNS
REFER TO ATTACHMENT NO.11

1	CONSTANCY; I LINK; LUXXAN; RHINO; ARIVO; GRENLANDER; T TYRE; CRYSTAL; ROCKBLADE; FRONWAY; SAILWIN; XBRI; ROADMARCH	8	MAX. LOAD 750kg(1653 LBS) MAX. PRESS. 300kPa (44PSI)
2	ULTRA ARZ4; ENRI U08; FOUR; THUNDER U09; LY169; EURUS 08; VENUSATR 08; SPORT+2; INSPIRER S8; ROCK 525; PRIME UHP 08; Envoy	9	MADE IN CHINA
3	PLIES:TREAD 2POLYESTER+2STEEL+1NYLON SIDEWALL 2POLYESTER	10	DOT 17B XXXXXX XXXX (DATE CODE)
4	RIM:6 1/2J	11	ECE APPROVAL MARK
5	RADIAL TUBELESS	12	TREADWEAR XXX TRACTION X TEMPERATURE X
6	MOLD No.	13	SAFETY WARNING
7	215/65R16 98H M+S	14	DOT 17B XXXXXX
		15	OUTSIDE(LOWER)/INSIDE(UPPER)

TIRE SIZE	D(mm)	S(mm)	A(mm)	LOAD INDEX SPEED CODE	REMARK
215/65R16	686	221	165	98H	—



SCALE : FREE	DATE : 2019.04.11	DESIGNED BY	CHECKED BY	APPROVED BY	DRAWING NO.
SHANDONG LONGYUE RUBBER CO., LTD.	Wang Tong	Xie Baoshan	Shen Maoqiao	TITLE	215/65R16 98H

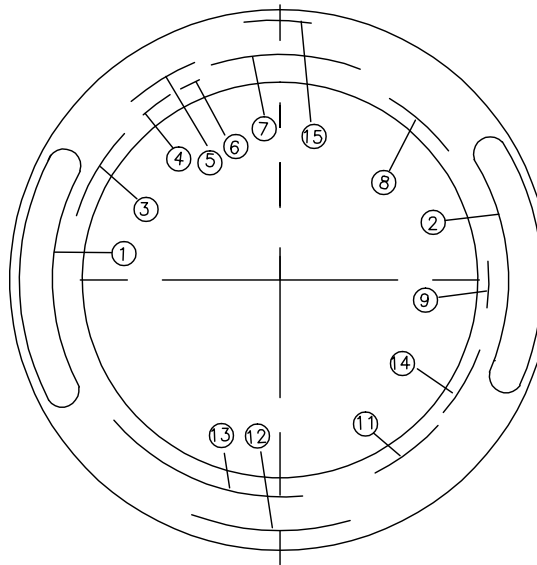
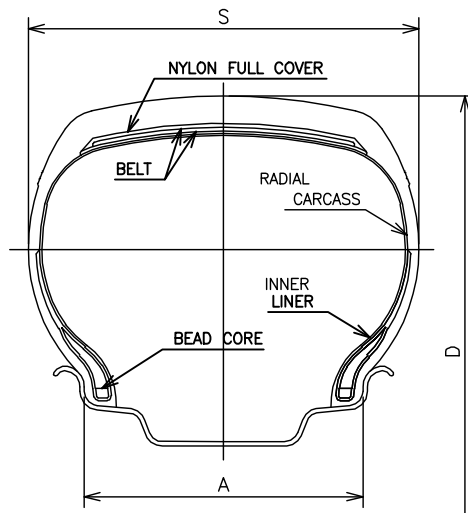

UPPER

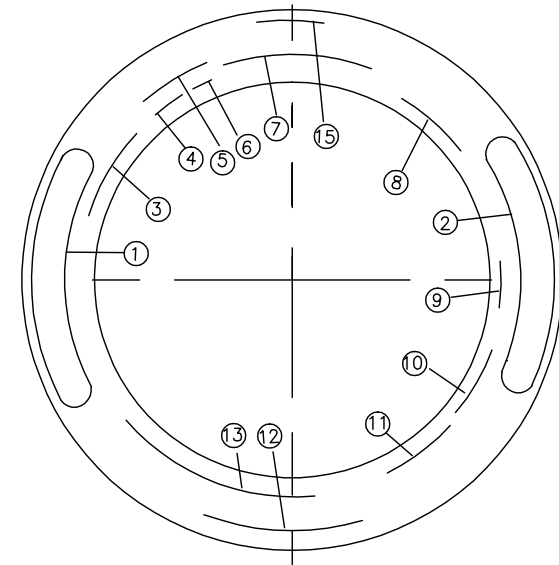

LOWER

TREAD PATTERNS
REFER TO ATTACHMENT NO.11

1	CONSTANCY; I LINK; LUXXAN; RHINO; ARIVO; GREENLANDER; T TYRE; CRYSTAL; ROCKBLADE; FRONWAY; SAILWIN; XBRI; ROADMARCH	8	MAX. LOAD 750kg(1653 LBS) MAX. PRESS. 300kPa (44PSI)
2	LY566; L-ZEAL56; INSPIRER S4; EMOTION; ULTRA ARZ5; Drift; TEN; SPORTWAY 56; SPORT+; SPEEDWAY 56; ROCK 566	9	MADE IN CHINA
3	PLIES: TREAD 2POLYESTER+2STEEL+1NYLON SIDEWALL 2POLYESTER	10	DOT 17B XXXXXX XXXX (DATE CODE)
4	RIM: 6 1/2J	11	ECE APPROVAL MARK
5	RADIAL TUBELESS	12	TREADWEAR XXX TRACTION X TEMPERATURE X
6	MOLD No.	13	SAFETY WARNING
7	215/65R16 98H M+S	14	DOT 17B XXXXXX
		15	OUTSIDE(LOWER)/INSIDE(UPPER)

TIRE SIZE	D(mm)	S(mm)	A(mm)	LOAD INDEX SPEED CODE	REMARK
215/65R16	686	221	165	98H	—



SCALE : FREE	DATE : 2019.04.11	DESIGNED BY	CHECKED BY	APPROVED BY	DRAWING NO.	
SHANDONG LONGYUE RUBBER CO., LTD.		Wang Tong	Xie Baoshan	Shen Maoqiao	TITLE	215/65R16 98H

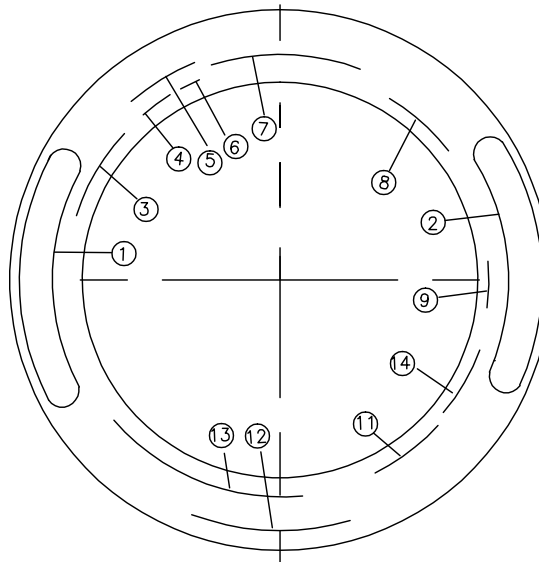
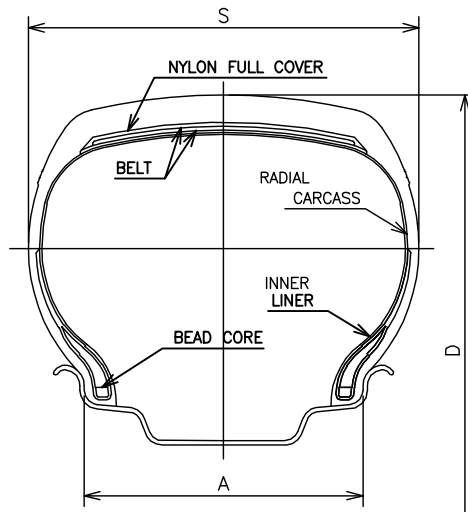

UPPER

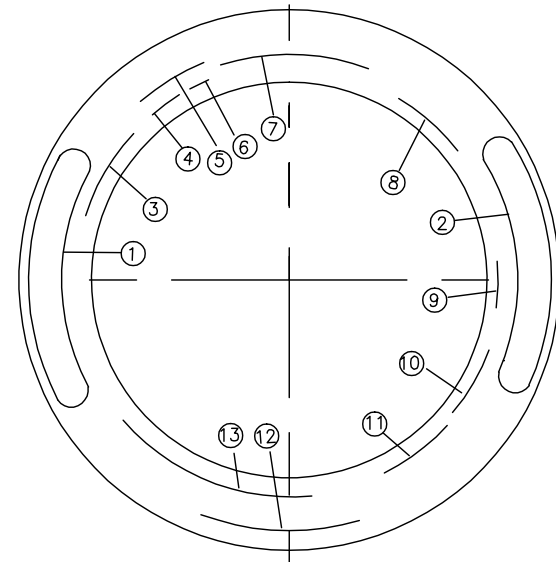

LOWER

TREAD PATTERNS
REFER TO ATTACHMENT NO.11

1	CONSTANCY; ILINK; LUXXAN; RHINO; ARIVO; GRENLANDER; T TYRE; CRYSTAL; ROCKBLADE; FRONWAY; SAILWIN; XBRI; ROADMARCH	8	MAX. LOAD 750kg(1653 LBS) MAX. PRESS. 300kPa (44PSI)
2	MAHO 77; TOPOWER 87 H/T; TERRANO ARV H/T; POWERCITY 77; ROADPOWER H/T; ROADKING H/T; FORZA H/T2 ; TWENTY TWO; INSPIRER F4; ROCK 717 H/T; PRIMEMARCH H/T 77; Maxim	9	MADE IN CHINA
3	PLIES:TREAD 2POLYESTER+2STEEL+1NYLON SIDEWALL 2POLYESTER	10	DOT 17B XXXXXX XXXX (DATE CODE)
4	RIM:6 1/2J	11	ECE APPROVAL MARK
5	RADIAL TUBELESS	12	TREADWEAR XXX TRACTION X TEMPERATURE X
6	MOLD No.	13	SAFETY WARNING
7	215/65R16 98H M+S	14	DOT 17B XXXXXX

TIRE SIZE	D(mm)	S(mm)	A(mm)	LOAD INDEX SPEED CODE	REMARK
215/65R16	686	221	165	98H	—



SCALE : FREE	DATE : 2019.04.11	DESIGNED BY	CHECKED BY	APPROVED BY	DRAWING NO.	
SHANDONG LONGYUE RUBBER CO., LTD.		Wang Tong	Xie Baoshan	Shen Maoqiao	TITLE	215/65R16 98H

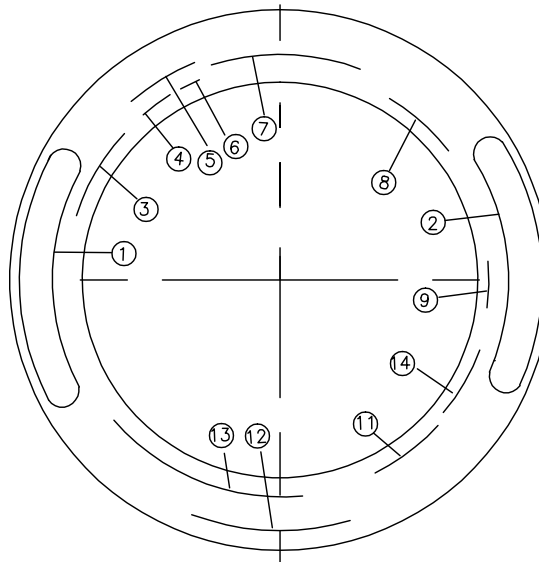
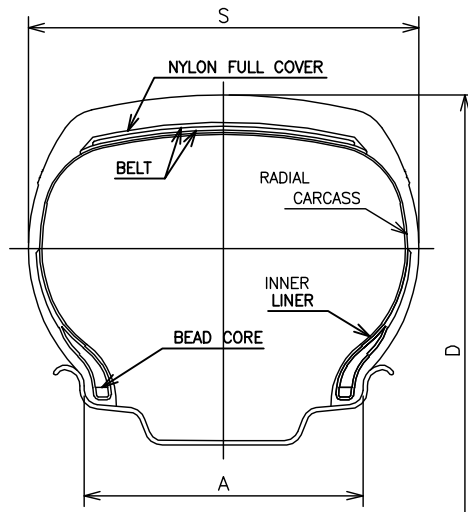

UPPER

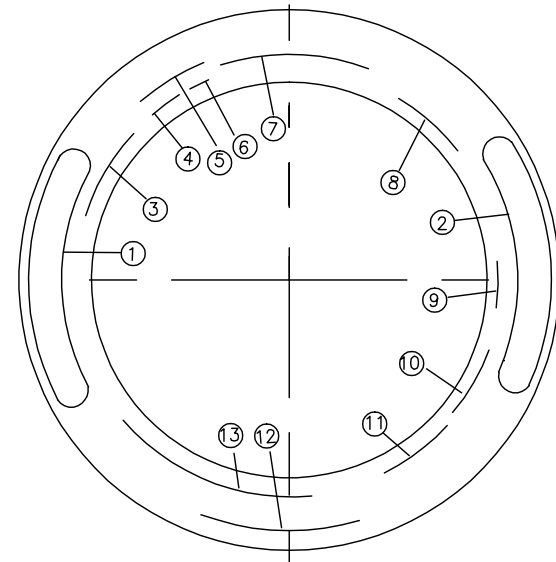

LOWER

TREAD PATTERNS
REFER TO ATTACHMENT NO.11

1	CONSTANCY; ILINK; LUXXAN; RHINO; ARIVO; GRENLANDER; T TYRE; CRYSTAL; ROCKBLADE; FRONWAY; SAILWIN; XBRI; ROADMARCH	8	MAX. LOAD 750kg(1653 LBS) MAX. PRESS. 300kPa (44PSI)
2	MAGA A/T ONE; TERRA MAX LSR1 A/T; TERRA XPLORER C1 A/T; TERRAMAX ARV A/T; ROCKBLADE A/T II; GLADIATOR A/T I; FORZA A/T; INSPIRE A/T I; TOUGH TRAC A/T I; ROCK 227 A/T; PRIMEVAX A/T I	9	MADE IN CHINA
3	PLIES:TREAD 2POLYESTER+2STEEL+1NYLON SIDEWALL 2POLYESTER	10	DOT 17B XXXXXX XXXX (DATE CODE)
4	RIM:6 1/2J	11	ECE APPROVAL MARK
5	RADIAL TUBELESS	12	TREADWEAR XXX TRACTION X TEMPERATURE X
6	MOLD No.	13	SAFETY WARNING
7	215/65R16 98H M+S	14	DOT 17B XXXXXX

TIRE SIZE	D(mm)	S(mm)	A(mm)	LOAD INDEX SPEED CODE	REMARK
215/65R16	686	221	165	98H	—



SCALE : FREE	DATE : 2019.04.11	DESIGNED BY	CHECKED BY	APPROVED BY	DRAWING NO.	
SHANDONG LONGYUE RUBBER CO., LTD.		Wang Tong	Xie Baoshan	Shen Maoqiao	TITLE	215/65R16 98H

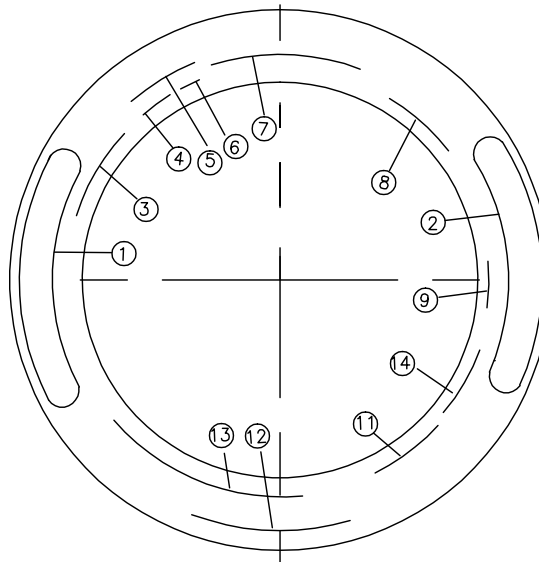
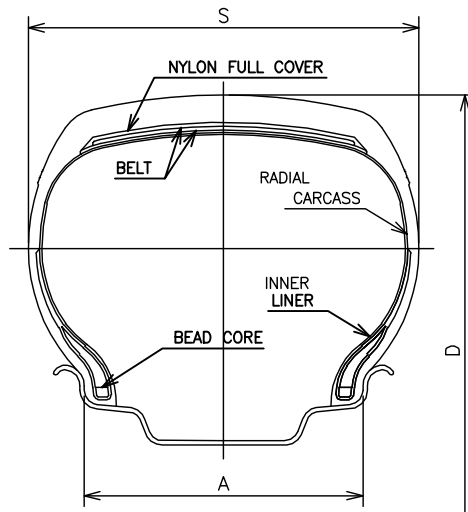

UPPER

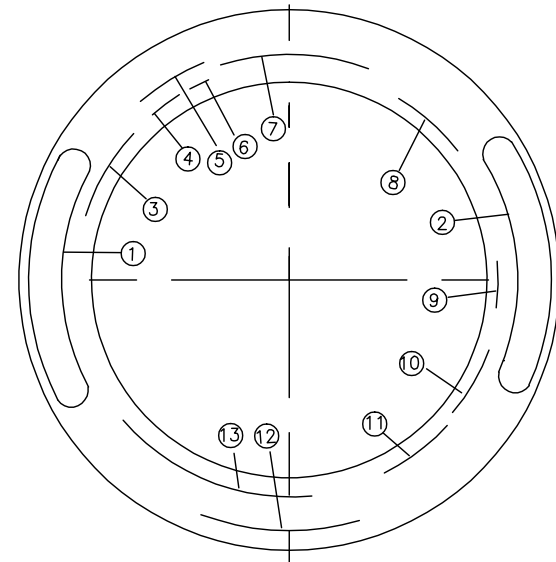

LOWER

TREAD PATTERNS
REFER TO ATTACHMENT NO.11

1	CONSTANCY; I LINK; LUXXAN; RHINO; ARIVO; GREENLANDER; T TYRE; CRYSTAL; ROCKBLADE; FRONWAY; SAILWIN; XBRI; ROADMARCH	8	MAX. LOAD 750kg(1653 LBS) MAX. PRESS. 300kPa (44PSI)
2	MAGA A/T TWO; TERRA MAX LSR2 A/T; TERRA XPLOER C2 A/T; TERRAMAX ARV PRO A/T; ROCKBLADE A/T II; GLADIATAX A/T II; FORZA A/T2 ; INSPIRER A/T II; TOUGH TRAC A/T II; ROCK 737 A/T; PRIMEMAX A/T II	9	MADE IN CHINA
3	PLIES:TREAD 2POLYESTER+2STEEL+1NYLON SIDEWALL 2POLYESTER	10	DOT 17B XXXXXX XXXX (DATE CODE)
4	RIM:6 1/2J	11	ECE APPROVAL MARK
5	RADIAL TUBELESS	12	TREADWEAR XXX TRACTION X TEMPERATURE X
6	MOLD No.	13	SAFETY WARNING
7	215/65R16 98H M+S	14	DOT 17B XXXXXX

TIRE SIZE	D(mm)	S(mm)	A(mm)	LOAD INDEX SPEED CODE	REMARK
215/65R16	686	221	165	98H	—



SCALE : FREE	DATE : 2019.04.11	DESIGNED BY	CHECKED BY	APPROVED BY	DRAWING NO.	
SHANDONG LONGYUE RUBBER CO., LTD.		Wang Tong	Xie Baoshan	Shen Maoqiao	TITLE	215/65R16 98H

TIRE SIZE 215/65R16 98H

ATTACHMENT NO.11

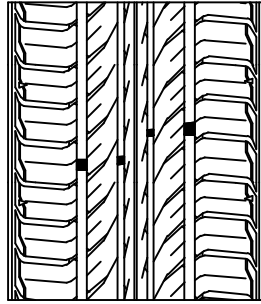

COLO H01; L-GRIP66;
LY168; ECOGREEN 66;
VENUSATR 66; Energize;
PREMIO ARZ1; ECOLOGY;
INSPIRER C4; THREE;
ROCK 515; PRIMESTAR 66

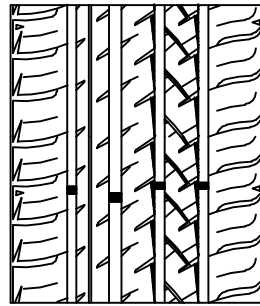

ENRI U08; EURUS 08;
LY169; THUNDER U09;
FOUR; VENUSATR 08;
ULTRA ARZ4; SPORT+2;
INSPIRER S8; ROCK 525;
PRIME UHP 08; Envoy

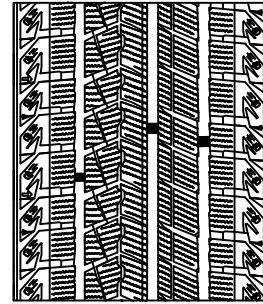

Winter GL868; Winter IL868;
LY868; ICEPOWER 868;
KEWINNER 868; WINMASTER ARW2;
ROCK 868S; THIRTY TWO;
SNOWROVER 868;
INSPIRER W20

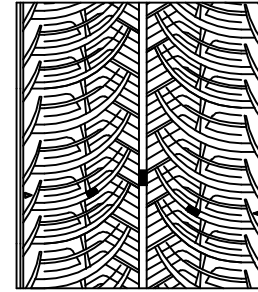

GREENWING A/S;
MULTIMATCH A/S;
FRONWING A/S;
FREIMATCH A/S;
Carlorful A/S; PRIME A/S;
ROCK A/S ONE; FORTY ONE;
INSPIRER A/S 1

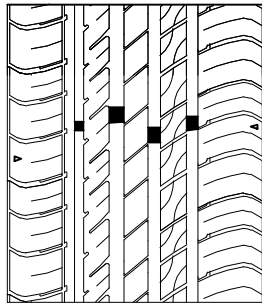

LY566; SPORTWAY 56;
SPEEDWAY 56;
L-ZEAL56; EMOTION; TEN;
ULTRA ARZ5; SPORT+;
INSPIRER S4; Drift;
ROCK 566

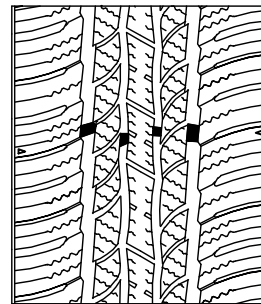

MAHO 77; POWERCITY 77;
TOPOWER 87 H/T;
ROADPOWER H/T;
ROADKING H/T; FORZA H/T2;
TERRANO ARV H/T;
INSPIRER F4; ROCK 717 H/T;
TWENTY TWO; Maxim;
PRIMEMARCH H/T 77

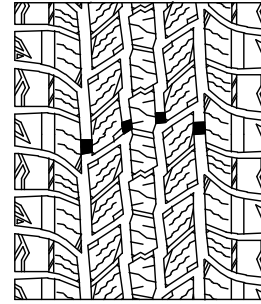

MAGA A/T ONE; FORZA A/T;
TERRA MAX LSR1 A/T;
TERRA XPLOER C1 A/T;
GLADIATAX A/T I; INSPIRER A/T I;
ROCKBLADE A/T I; ROCK 727 A/T;
TERRAMAX ARV A/T;
TOUGH TRAC A/T I;
PRIMEMAX A/T I

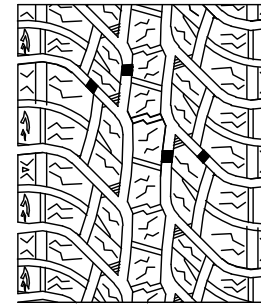

MAGA A/T TWO; FORZA A/T2;
TERRA MAX LSR2 A/T;
TERRA XPLOER C2 A/T;
GLADIATAX A/T II; INSPIRER A/T II;
ROCKBLADE A/T II;
TERRAMAX ARV PRO A/T;
TOUGH TRAC A/T II;
ROCK 737 A/T; PRIMEMAX A/T II

6 TREAD WEAR INDICATORS EQUALLY SPACED



DRAWN BY	Wang Tong	CHECKED BY	Wangshilun	APPROVED BY	Shen Maoqiao
----------	-----------	------------	------------	-------------	--------------

SHANDONG LONGYUE RUBBER TYRE CO.,LTD.