



**AK 328/22**  
82 x 22 mm



**AK 328/38**  
115 x 38 mm



**AK 328/65**  
115 x 65 mm



130 x 38 mm

**CORYLLOS**  
24,0 cm/9 1/2"

**SAUERBRUCH**  
**AK 330/25**  
25,0 cm/10"

**KM** OHR OTOTOLOGY OTOLOGIA OTOLOGIE OTOLOGIA

Schlingen, Hähchen  
 Loops, Hooklets  
 Asas, Ganchitos  
 Anses, Crochets  
 Anse, Uncini



**BILLEAU**  
 16,5 cm/6 1/2"



**SNELLEN**  
 16,5 cm/6 1/2"



**GROSS**  
**KM 556/12**  
 12,0 cm/4 3/4"

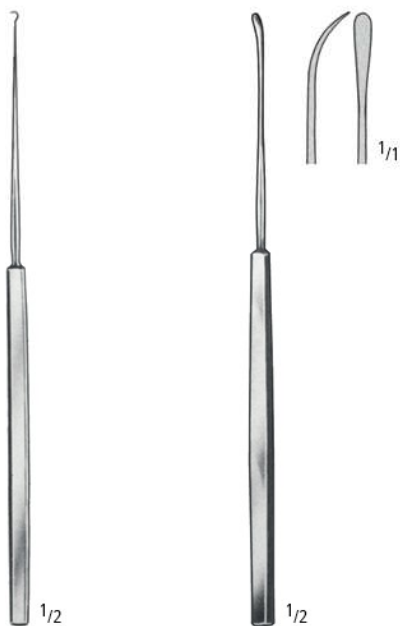

**HARTMANN**  
**KM 560/16**  
 16,5 cm/6 1/2"

**ZAUFAL**  
**KM 566/16**  
 16,5 cm/6 1/2"

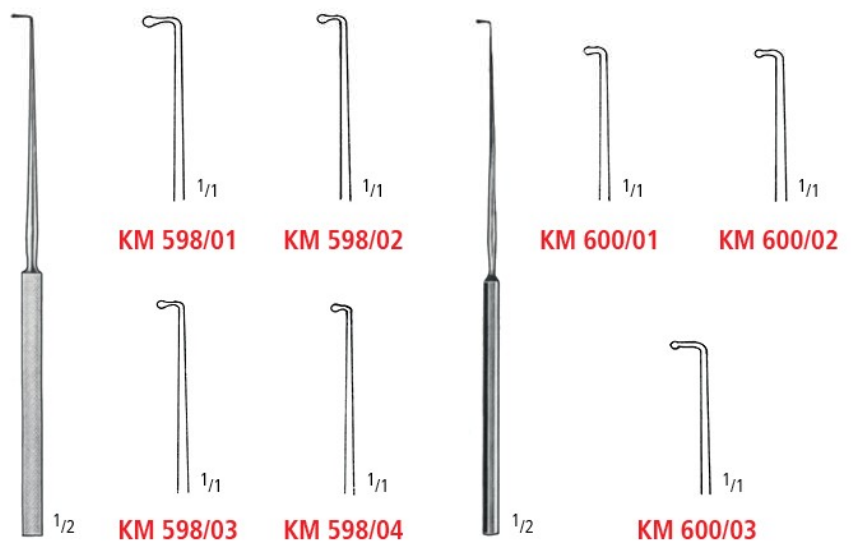

**WAGENER**  
 14,0 cm/5 1/2"

**LUCAE**  
 14,0 cm/5 1/2"

**AC** SCHEREN SCISSORS TIJERAS CISEAUX FORBICI

Chirurgische Scheren  
Operating Scissors  
Tijeras para cirugía  
Ciseaux à chirurgie  
Forbici per chirurgia



**STANDARD**

Fig.1  
gerade  
straight  
rectas  
droits  
rette

- AC 010/10 10,5 cm/4 1/4"
- AC 010/11 11,5 cm/4 1/2"
- AC 010/13 13,0 cm/5"
- AC 010/14\* 14,5 cm/5 3/4"
- AC 010/15 15,5 cm/6"
- AC 010/16 16,5 cm/6 1/2"
- AC 010/17 17,5 cm/7"
- AC 010/18 18,5 cm/7 1/3"
- AC 010/20 20,0 cm/8"

**STANDARD**

Fig.1  
gebogen  
curved  
curvas  
courbes  
curve

- AC 011/10 10,5 cm/4 1/4"
- AC 011/11 11,5 cm/4 1/2"
- AC 011/13 13,0 cm/5"
- AC 011/14\* 14,5 cm/5 3/4"
- AC 011/15 15,5 cm/6"
- AC 011/16 16,5 cm/6 1/2"
- AC 011/17 17,5 cm/7"
- AC 011/18 18,5 cm/7 1/3"
- AC 011/20 20,0 cm/8"

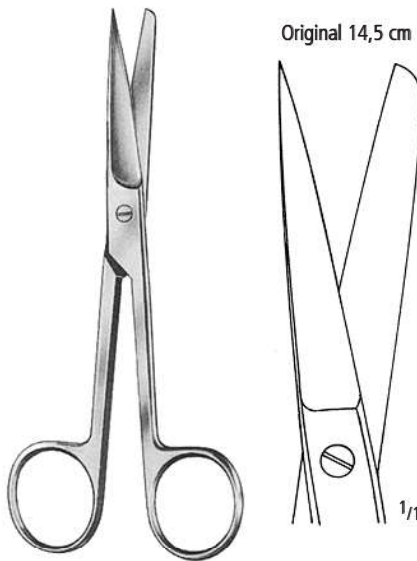

**STANDARD**

Fig.2  
gerade  
straight  
rectas  
droits  
rette

- AC 020/10 10,5 cm/4 1/4"
- AC 020/11 11,5 cm/4 1/2"
- AC 020/13 13,0 cm/5"
- AC 020/14\* 14,5 cm/5 3/4"
- AC 020/15 15,5 cm/6"
- AC 020/16 16,5 cm/6 1/2"
- AC 020/17 17,5 cm/7"
- AC 020/18 18,5 cm/7 1/3"
- AC 020/20 20,0 cm/8"

**STANDARD**

Fig.2  
gebogen  
curved  
curvas  
courbes  
curve

- AC 021/10 10,5 cm/4 1/4"
- AC 021/11 11,5 cm/4 1/2"
- AC 021/13 13,0 cm/5"
- AC 021/14\* 14,5 cm/5 3/4"
- AC 021/15 15,5 cm/6"
- AC 021/16 16,5 cm/6 1/2"
- AC 021/17 17,5 cm/7"
- AC 021/18 18,5 cm/7 1/3"
- AC 021/20 20,0 cm/8"

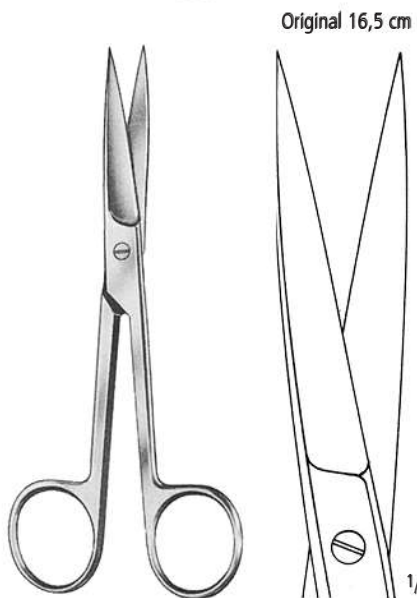

**STANDARD**

Fig.3  
gerade  
straight  
rectas  
droits  
rette

- AC 030/10 10,5 cm/4 1/4"
- AC 030/11 11,5 cm/4 1/2"
- AC 030/13 13,0 cm/5"
- AC 030/14\* 14,5 cm/5 3/4"
- AC 030/15 15,5 cm/6"
- AC 030/16 16,5 cm/6 1/2"
- AC 030/17 17,5 cm/7"
- AC 030/18 18,5 cm/7 1/3"
- AC 030/20 20,0 cm/8"

**STANDARD**

Fig.3  
gebogen  
curved  
curvas  
courbes  
curve

- AC 031/10 10,5 cm/4 1/4"
- AC 031/11 11,5 cm/4 1/2"
- AC 031/13 13,0 cm/5"
- AC 031/14\* 14,5 cm/5 3/4"
- AC 031/15 15,5 cm/6"
- AC 031/16 16,5 cm/6 1/2"
- AC 031/17 17,5 cm/7"
- AC 031/18 18,5 cm/7 1/3"
- AC 031/20 20,0 cm/8"

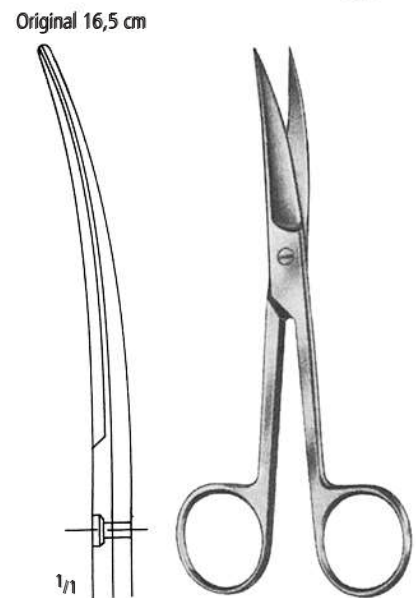

**KM** OHR OTOLOGY OTOLOGIA OTOLOGIE OTOLOGIA

Mikro Ohrzängchen  
 Micro Ear Forceps  
 Micro pinzas auriculares  
 Micro pinces auriculaires  
 Micro pinze auricolari

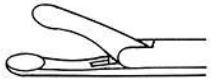

**KM 334/08**

gerade  
 straight  
 rectas  
 droits  
 rette

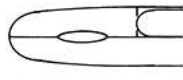

| 4,0 mm |

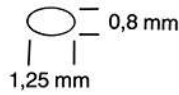

0,8 mm  
 1,25 mm



**KM 338/08**

rechts gebogen  
 curved right  
 curvas derecha  
 courbes à droite  
 curva destra



**KM 342/08**

links gebogen  
 curved left  
 curvas izquierda  
 courbes à gauche  
 curva sinistra



**KM 346/08**

aufgebogen  
 curved up  
 curvas arriba  
 courbes en montant  
 curva in alto

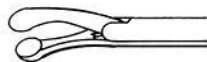

**KM 350/08**

abgebogen  
 curved down  
 curvas abajo  
 courbes en bas  
 curva in basso

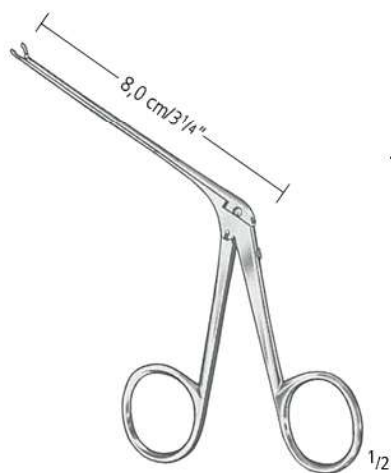
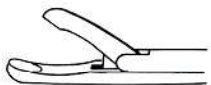

**CRURA-NIPPER**  
**KM 354/08**

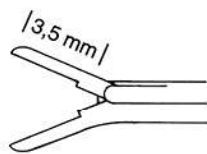

| 3,5 mm |  
 0,8 mm



**McGEE**  
**KM 356/08**

**AB** PINZETTEN FORCEPS PINZAS PINCES PINZE

Ohr- und Nasenpinzetten  
 Ear and Nose Dressing Forceps  
 Pinzas auriculares y nasales  
 Pincès auriculaires et nasales  
 Pinze auricolare e nasale



**AB 650/11**

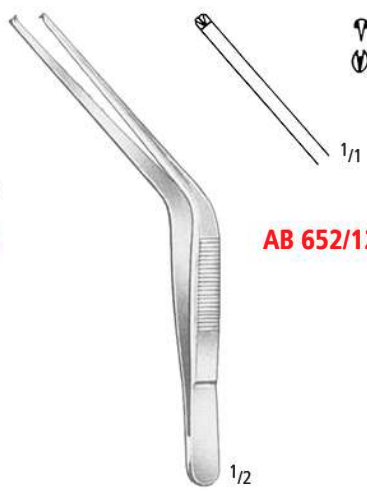

**AB 652/12**

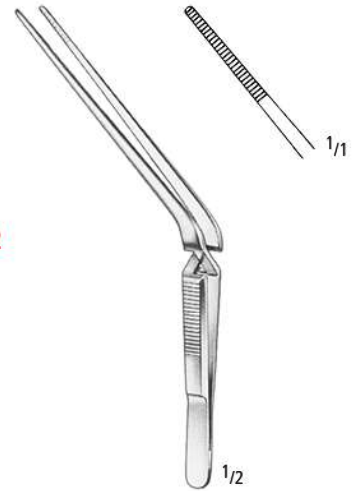

**TROELTSCH (WILDE)**

Mod. Jalasvirta

**AB 654/11**

**AB 654/13**

11,0 cm/4<sup>1</sup>/<sub>3</sub>"

13,0 cm/5"

11,0 cm/4<sup>1</sup>/<sub>3</sub>"  
 12,0 cm/4<sup>3</sup>/<sub>4</sub>"  
 15,0 cm/6"  
 18,0 cm/7"

**TROELTSCH (WILDE)**

**AB 650/11**

**AB 650/12**

**AB 650/15**

**AB 650/18**

**TROELTSCH (WILDE) 1:2**

**AB 652/12**

**AB 652/15**

**AB 652/18**



**LUCAE**

**AB 656/14**

14,0 cm/5<sup>1</sup>/<sub>2</sub>"

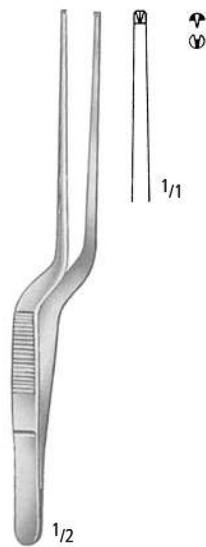

**LUCAE 1:2**

**AB 658/14**

14,0 cm/5<sup>1</sup>/<sub>2</sub>"



**JANSEN**

16,0 cm/6<sup>1</sup>/<sub>4</sub>"

18,0 cm/7"

20,0 cm/8"

**AB 660/16**

**AB 660/18**

**AB 660/20**

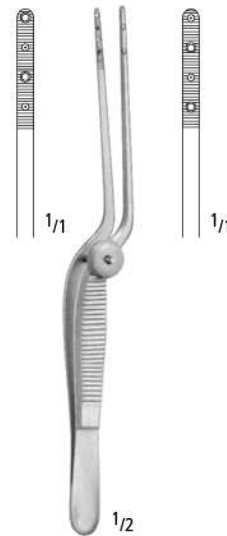

**COTTLE**

**AB 665/14**

14,0 cm/5<sup>1</sup>/<sub>2</sub>"



**GRUENWALD (JANSEN)**

**AB 690/20**

20,0 cm/8"