

EcoFit® cup EPORE®





TABLE OF CONTENTS

PREOPERATIVE PLANNING.....	4
DESIGN CHARACTERISTICS.....	5
SYSTEM OVERVIEW.....	6
SURGICAL TECHNIQUE.....	7
IMPLANTS.....	20
INSTRUMENTS.....	25
PRE- / POST-OPERATIVE INSTRUCTIONS.....	35
INDICATIONS / CONTRAINDICATIONS.....	36

Nota Bene: The author of this technique has outlined the procedure for the uncomplicated surgical scenario. Ultimately however it is the operating surgeon who is best placed to assess and address the individual needs of each patient.

Copyright Information: EcoFit®, EPORE®, implaFix®, implavit®, implatan®, implacross® and GIS® are registered trademarks of implantcast GmbH. The use and/or copying of the content of this brochure, be it wholly or in part, is only allowed with the prior written permission of implantcast GmbH. BIOLOX® is a trademark of CeramTec AG.

PREOPERATIVE PLANNING

Pre-operative planning and precise surgical techniques are mandatory for optimal results. The instructions and the procedure given in the surgical technique to the system must be adhered to. Familiarity with the recommended surgical technique and its careful application is essential to achieve the best possible outcome.

Before surgery a surgical planning with regard to the dimensions of the prosthetic model and the positioning of the implant components in the bone has to be carried out by the surgeon.

For this purpose, x-ray templates are available:

Digital templates: Digital templates are included in the data base of the common planning systems. For missing templates, please contact the provider of the planning software and request for these templates.

Radiographic templates: Alternatively radiographic templates are available in various scale factors, which can be obtained from your local representative.

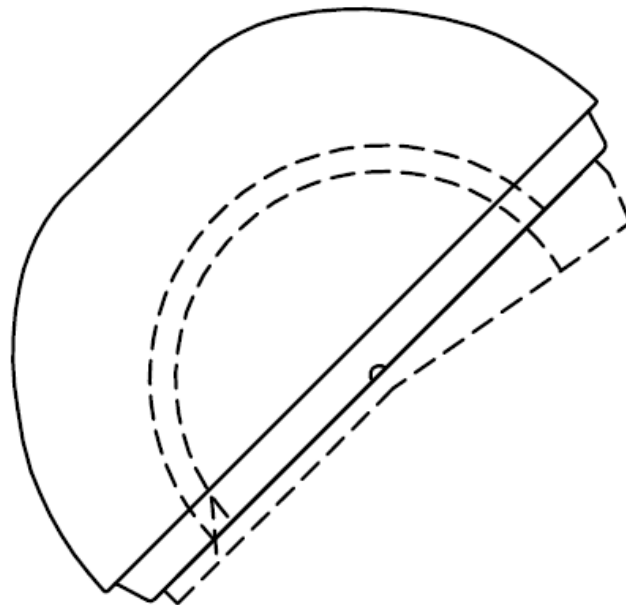

For more information, please refer to the instructions for use „cementless acetabular cup systems“ (09300038GB) and this surgical technique from page 35.

DESIGN CHARACTERISTICS

Pole-area:

- ⊕ gap between cup and acetabulum
- ⊕ protection of the bone

Fit-area:

- ⊕ reduction of tension towards the pole area

PressFit-area:

- ⊕ safety against tilting and migration

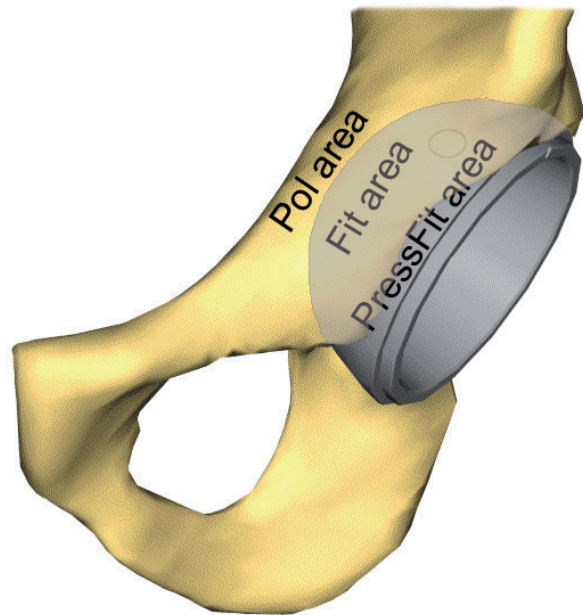

The 'Low Profile' design of the cementless EcoFit® acetabular system is defined to enhance the stability and to support long-lasting bony integration.

Pole-area

The PressFit of hemispherical acetabular implants results from under-reaming of the implant bed. The resulting PressFit acts upon the total bony area of contact. In the area of the acetabular base and in the pole area respectively this action is undesirable, because the resulting forces hold the risk of migration and loosening of the implant. For this reason the EcoFit® EPORE® cup is flattened in order to guarantee the protection of the bone and to reduce the risk of loosening.

















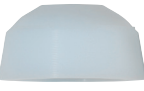







PressFit-area

The EcoFit® EPORE® cup locks stable through a peripheral enhanced PressFit. The PressFit grows progressively with the external diameter of the EcoFit® EPORE® acetabular implants. The primary stability decisively depends on the rate of tensions which appear during insertion of the implant. The degrees of these bone tensions are defined by the rate of the under-reaming. On equal under-reaming with all implant diameters you can see an increase of the resulting bone tensions rising with the growing diameter of the cups.

Fit area

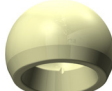
The cup has also got the EPORE® surface structure in the adjacent Fit area in order to enhance the osseointegration. The geometry corresponding to the reaming of the cup leads to reduced tensions in direction to the pole.

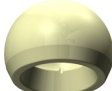
SYSTEM OVERVIEW

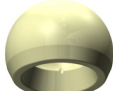
42-44mm	46-48mm	50-54mm	56-58mm	60-72mm	
					EcoFit® cup EPORE®
not available	 28 / 39 32 / 39*	 28 / 44 32 / 44 36 / 44*	 28 / 48 32 / 48 36 / 48	 28 / 52 32 / 52 36 / 52	PE-insert 0° UHMWPE acc. to ISO 5834-2 or implacross®
 28 / 35*	 28 / 39 32 / 39*	 28 / 44 32 / 44 36 / 44*	 28 / 48 32 / 48 36 / 48	 28 / 52 32 / 52 36 / 52	PE-insert 10° UHMWPE acc. to ISO 5834-2 or implacross®
 28 / 35	 32 / 39	 32 / 44 36 / 44	 32 / 48 36 / 48 40 / 48	 32 / 52 36 / 52 40 / 52	BIOLOX® delta insert acc. to ISO 6474-2
not available	not available	 38 / 44  22 / 38	 42 / 48  28 / 42	 46 / 52  28 / 46	EcoFit® cup insert acc. to ISO 5832-12 + 2M implacross® E / EcoFit® 2M head

* only available in implacross®

In order to minimize the micro motions and prevent PE abrasion in the contact area between metal cup and PE insert, a special locking mechanism has been developed. It allows the use of the identical acetabular cup implant for the use of BIOLOX® delta ceramic or PE inserts. The PE inserts are sterilized with ethylene oxide gas to prevent oxidative predegradation of the material. Alternatively PE inserts made of implacross® crosslinked polyethylene, are available. These PE-inserts have shown improved wear characteristics during preclinical tests.

The implants of the EcoFit® EPORE® system show a central hole in the acetabular base. The hole allows the control of the seating and the attachment of the impactor. It is covered by the use of a central screw cover which captures the cover while inserting. The EcoFit® EPORE® cup has three or seven (multihole) covered screw holes. To enhance the primary stability by using screws, the tapered covers may be removed (while the cup is already seated) and screws will be used. The cancellous screws can be angled up to 15°. The cup is also available without three additional holes (EcoFit® EPORE® NH).

SURGICAL TECHNIQUE

Preparation of the acetabulum

Please expose the hip joint completely. Resect the articular capsule and the labrum acetabulare. Dissect the bony rim of the acetabulum, if possible, completely.

Remove the osteophytes and the connective tissue of the fossa acetabuli. In order to rebuild normal anatomical proportions, the acetabulum should be medialised to the extent to which you are able to reconstruct the preoperatively chosen centre of rotation.

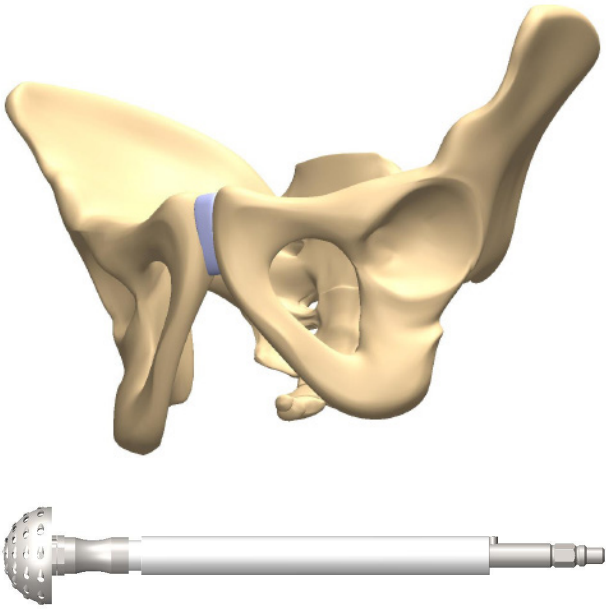

Figure 1

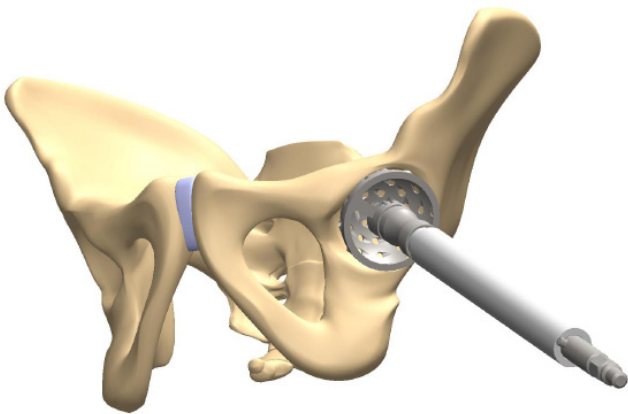

Figure 2

To prepare the acetabular bone, reamers of external diameters in increments of 2mm are available (Fig. 1).

Align the reamer anatomically, in abduction of about 45° and anteversion of 10 - 20°. By using the reamer the acetabulum is prepared until bleeding subchondral bone is reached (Fig. 2).

Please note that the posterior and anterior acetabular rim serve for sizing and therefore should be preserved accordingly.

SURGICAL TECHNIQUE

Sizing

Using the trial shells, the size of the prepared implant bed is checked (Fig. 3a).

The slots of the trial shells serve for the determination of the bone contact between the respective trial shell and the prepared acetabulum (Fig. 3b).

Please consider that the trial shells are of a hemispherical shape, while the EcoFit® cup shows a circumferential enhanced PressFit.

NOTE:

For the EcoFit® trial cup Ø 42mm please use the impactor 42mm.

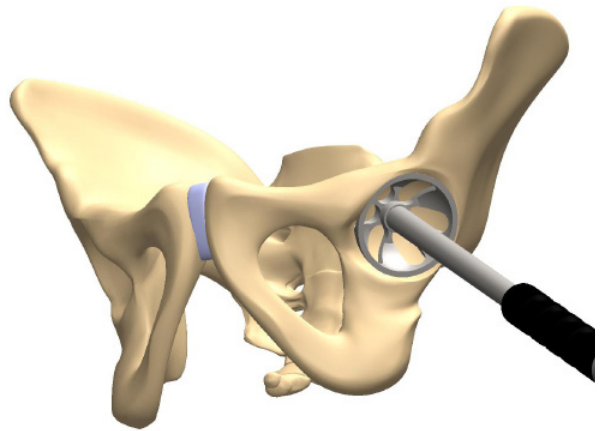

Figure 3b

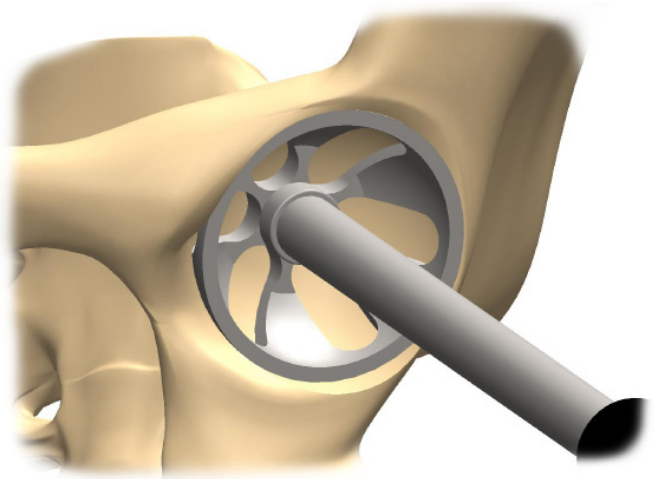
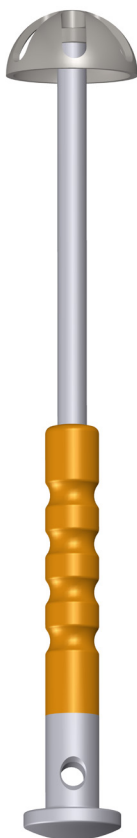

Figure 3c

SURGICAL TECHNIQUE

Insertion of the cup

The chosen EcoFit® cup is combined with the universal impactor and inserted in the prepared acetabulum (Fig. 4).

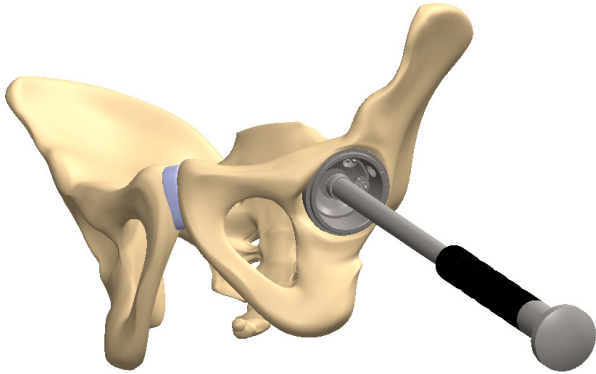

Figure 4

Exactly aligned the EcoFit® cup should rest at an angle of abduction of 45° and an anteversion of 10-20°. The chosen size of the EcoFit® cup should have the same diameter as the previously used reamer. The PressFit of the EcoFit® cup increases proportionally to the cup diameter. The stability of the implant fit (PressFit) and the implant-to-bone contact can be adjusted by moving the impactor at the end of the handle. In doing so the whole pelvic should move without changing the position of the cup in the acetabulum.

If so, you can act on the assumption of a firm primary fit and the impactor can be removed (Fig. 5). Peripheral osteophytes that possibly hinder the femoral implant from its full range of motion have to be removed.

If the stability is not desirable, please consider to use a larger reamer and cup size or consider to use additional cancellous bone screws to enhance the stability (see page 16).

NOTE:

The EcoFit® EPORE® cup 42mm does not have a central bore hole. The cup is placed with the impactor 42mm which is assembled with the cup impactor.

In the case of pathologically altered bone tissue of the operated patient (e.g. Osteosclerosis), there is a risk that during impaction of the EcoFit® EPORE® cup into the bone the crunchplugs may come loose from the cup.

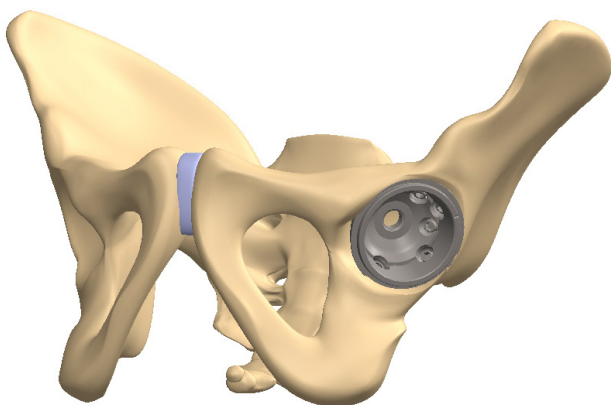

Figure 5

SURGICAL TECHNIQUE

Insertion of the central cover

The central hole of the EcoFit® cup has got a thread and is closed with a screw driver. Before inserting the central screw, the central hole has to be cleaned thoroughly by rinsing and sucking off. The captured screw driver holds the cover while inserting (Fig. 6 and Fig. 7)

Make sure that the central cover is seated completely (Fig. 8).

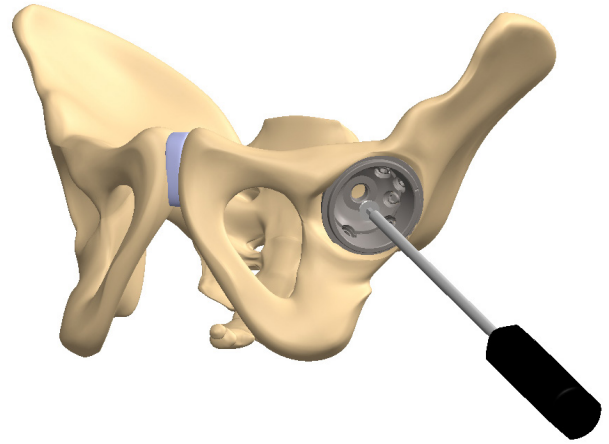

Figure 6

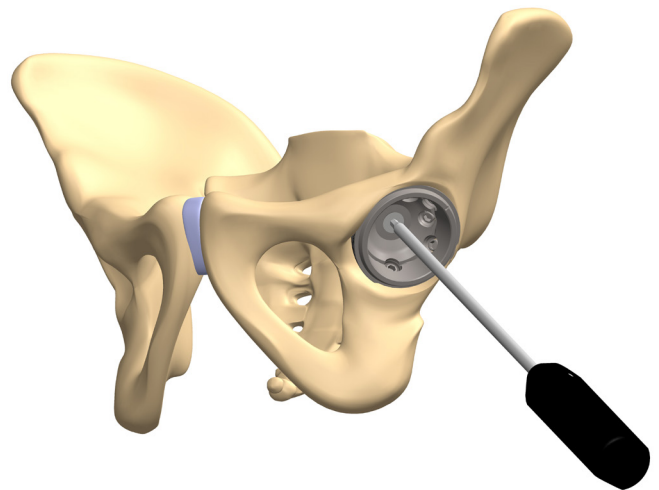

Figure 7

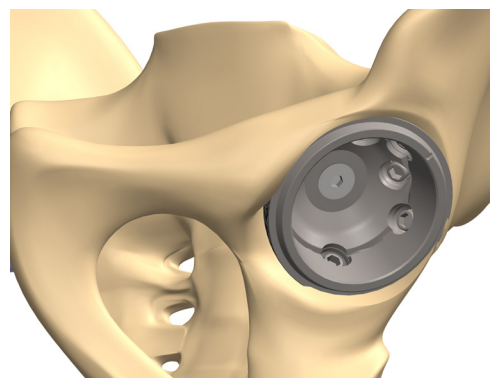

Figure 8

SURGICAL TECHNIQUE

Trial reduction

When the EcoFit® cup is fixed firmly in the desired position, a trial insert of the appropriated size may be inserted for the trial reduction. By the use of the trial insert you avoid damages of the PE and the ceramic insert respectively. Combine the universal impactor with the trial impactor and insert the trial insert (Fig. 9). Table 1 shows the colour coding of the trial inserts. The same colour coding could be found on the outside labelling of the implant packages.

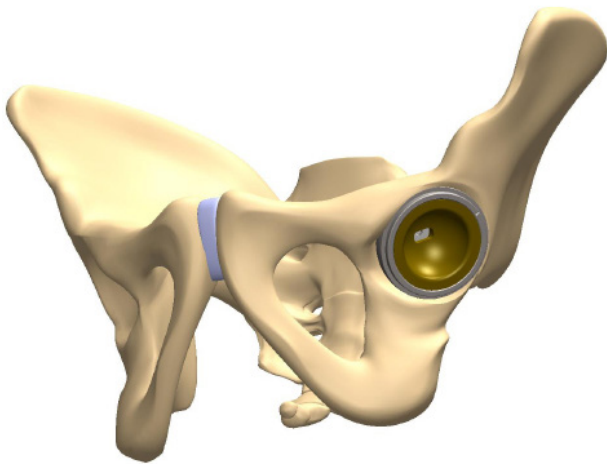
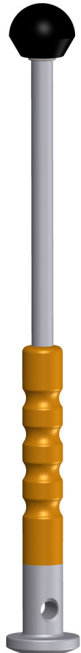

Figure 9



	trial insert 0°		trial for EcoFit® insert
cup Ø 42-44mm			not available
cup Ø 46-48mm			not available
cup Ø 50-54mm			
cup Ø 56-58mm			
cup Ø 60-72mm			

Table 1

SURGICAL TECHNIQUE

Removal of the trial insert

Mount the trial insert extractor to the universal impactor.

Insert the tip of the extractor into the bottom hole of the trial insert (Fig. 10) and turn the extractor. It will hook in and the trial insert can be pulled out (Fig. 11).

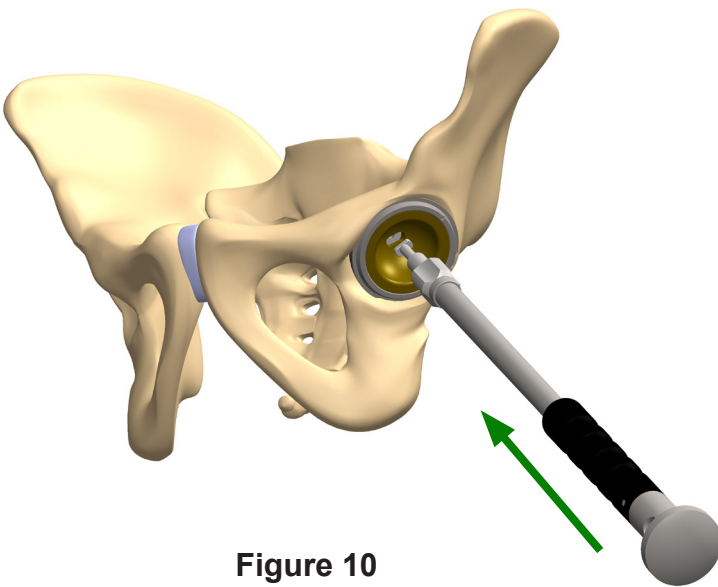
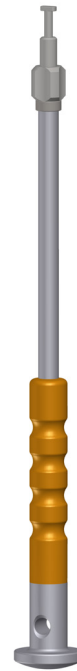

Figure 10

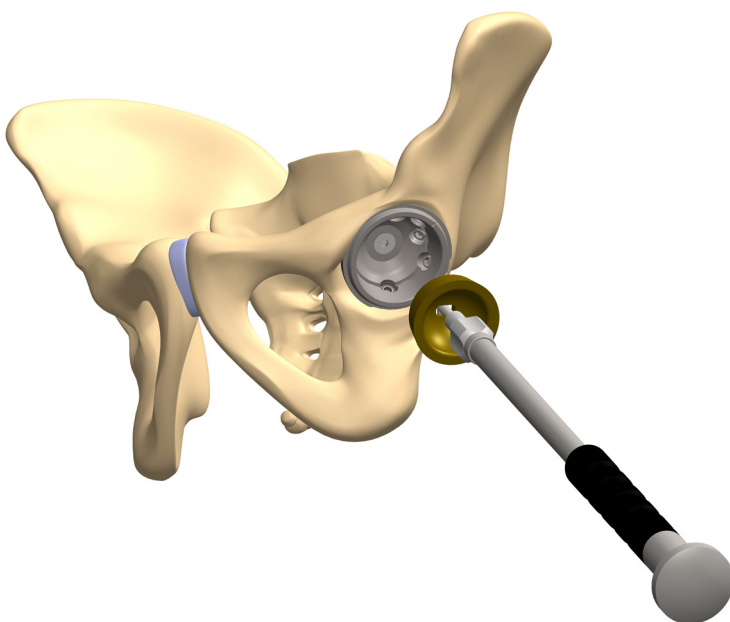
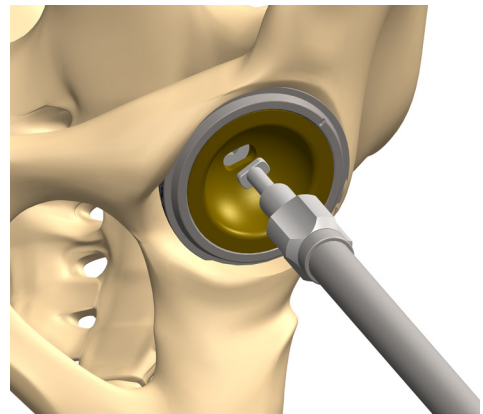

Figure 11

SURGICAL TECHNIQUE

Insertion of the PE-insert

Before final insertion of the PE articulation inserts into the EcoFit® cup, the rim and the inner surface have to be cleaned thoroughly. Tissue and bone particles have to be removed.

Combine the impactor for PE insert 10° with the PE insert of the correct size. The two spikes of the impactor will seat firmly into the holes of the PE insert. Before pressing in the PE insert 10° make sure the overhang is placed in the appropriate position. Please respect that the X-mark of the impactor should line up with the mark of the acetabular cup (Fig. 12).

The overhang optimizes the stability of the joint and reduces the tendency to sublunate. Usually the overhang is inserted in the cranio/posterior direction.

The PE insert 0° is inserted by using the non captured impactor as it is used for inserting the ceramic inserts (see next page).

Please make sure that the PE insert fits with stability thus assuring that the snap mechanism of the PE insert is caught completely by the cup (Fig. 13).

If a removal of the PE insert from the EcoFit® cup is necessary for correction, the polyethylene component has to be lifted up and discarded. In no case the PE insert may be inserted into the cup a second time. The use of a new PE insert is mandatory.

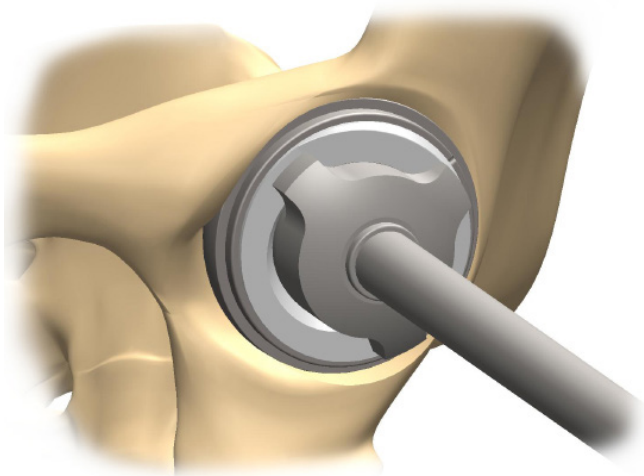

Figure 12

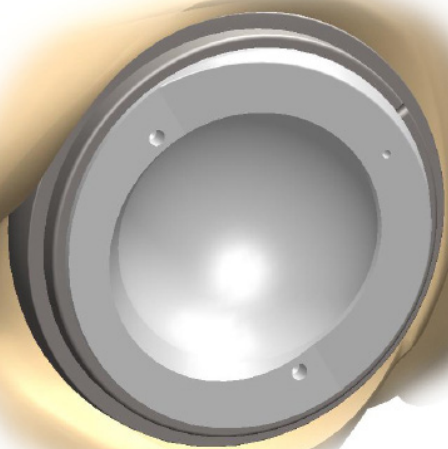
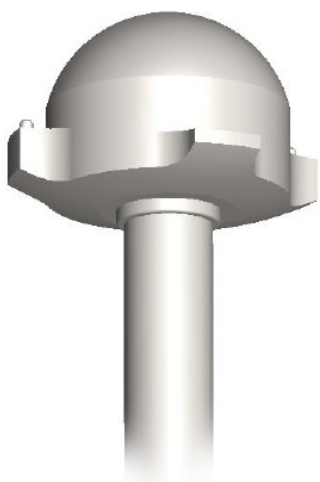

Figure 13

SURGICAL TECHNIQUE

Insertion of the ceramic insert

Before final insertion of one of the three insert types into the EcoFit® cup the rim and the inner surface of the cup have to be cleaned thoroughly. Tissue and bone particles have to be removed.

After a positioner for ceramic of the appropriated diameter had been mounted to the universal impactor, the insert is inserted into the cup (Fig. 14).

The insert is conically locked into the EcoFit® cup (Fig. 15a). If a ceramic insert has to be removed in case of revision, only a PE insert may be inserted in the residual cup implant afterwards.

Make sure that the insert is fully seated (Fig. 15b) before final reduction of the joint is performed (Fig. 15c).

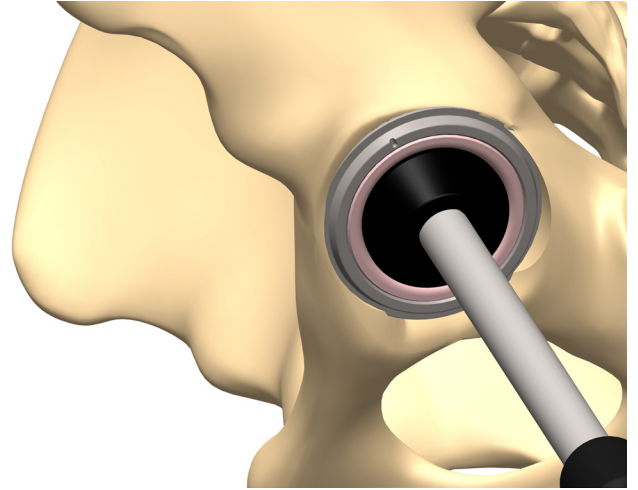

Figure 14

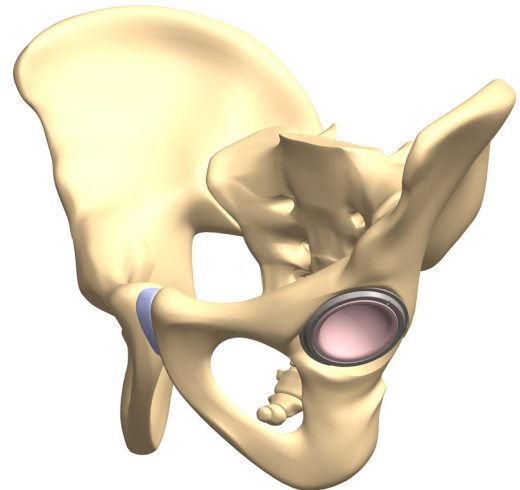

Figure 15a

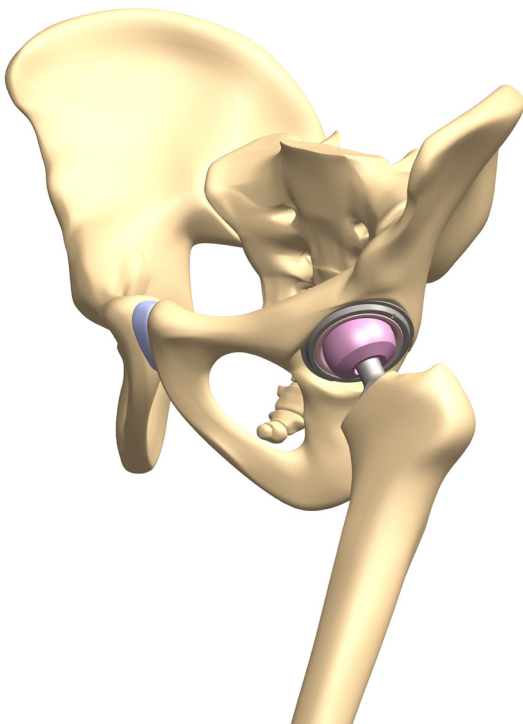

Figure 15c

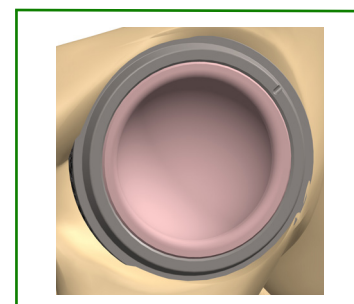

Figure 15b

SURGICAL TECHNIQUE

Impacting of EcoFit® insert (tripolar version)

After a successful trial reduction with the sample inserts for EcoFit® cup insert and the 2M sample head, the selected implant can be used. Before inserting any of the inserts into the EcoFit® cup, the edge and the inner surface of the cup must be freed from tissue and bone particles and carefully cleaned.

The EcoFit® cup insert is then compressed with the impactor. Beforehand, the ladle insert is mounted with the insert for the EcoFit® insert (38mm, 42mm or 46mm) (Fig. 16a).

The EcoFit® insert seizes via taper connection in the EcoFit® cup.

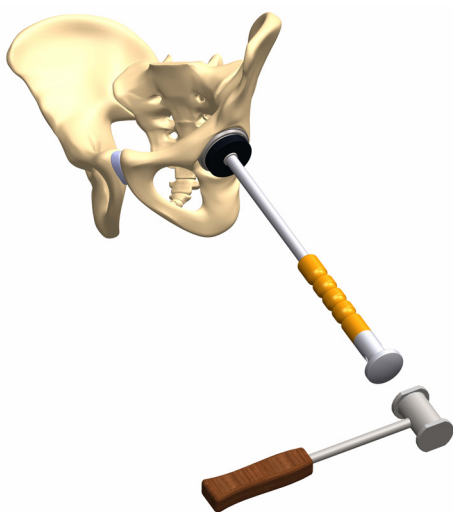
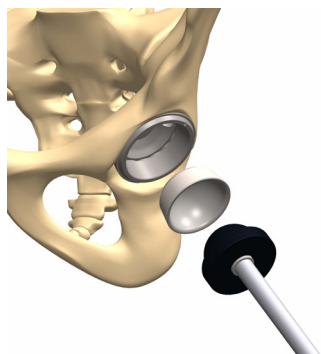

Figure 16a

Combination of the components

Combine the 2M head of the appropriate size with the desired femoral head (ic femoral head CoCrMo, ic femoral head, BIOLOX® delta) (Fig. 16b). Use the assembling tool for this purpose (Fig. 16c). Head and 2M head are combined by turning the thread of the assembling tool.

With the head impactor and some light hammer blows the combined heads are fixed on the taper of the hip stem.

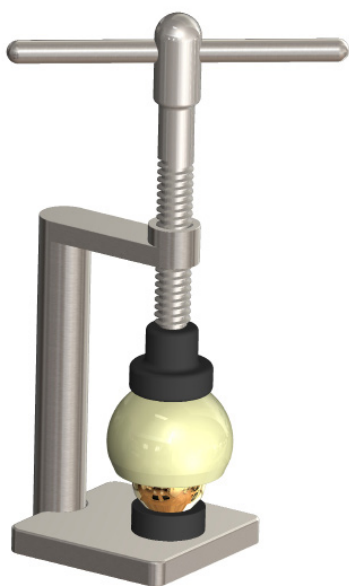

Figure 16c



Figure 16b

SURGICAL TECHNIQUE

Application of screws

The stability of the primary fixation of the cup can be enhanced by the use of additional cancellous bone screws.

The screw holes are covered with plugs that must be removed. Therefore put the screw driver 3,5mm into the relevant plug (Fig. 17a). By right- or leftturning and levering out the plugs can be removed (Fig. 17b). The plug is captured by the tip of the remover and it can be pulled out. The removed plugs (Fig. 18a and 18b) can be wiped off using the plug remover located in the container.

Alternatively, the cup can be placed on a sterile basis. By gently tapping the plug on the outside of the cup, it comes loose and can be removed out of the cup. For this you can use the cross bar tapered which can be found in the hip stem container.

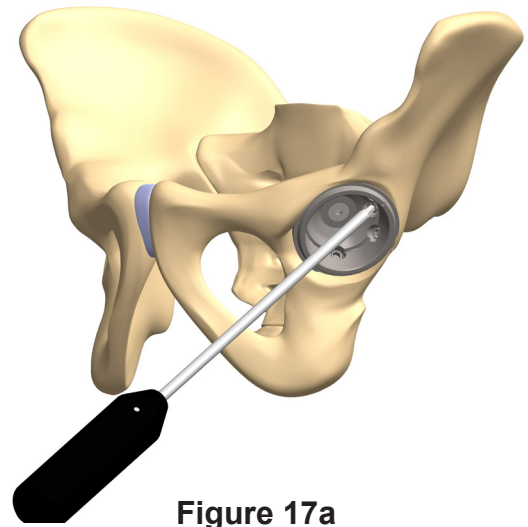

Figure 17a

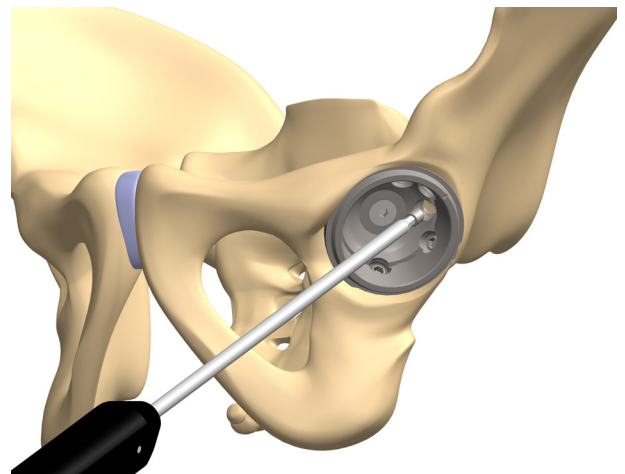

Figure 17b

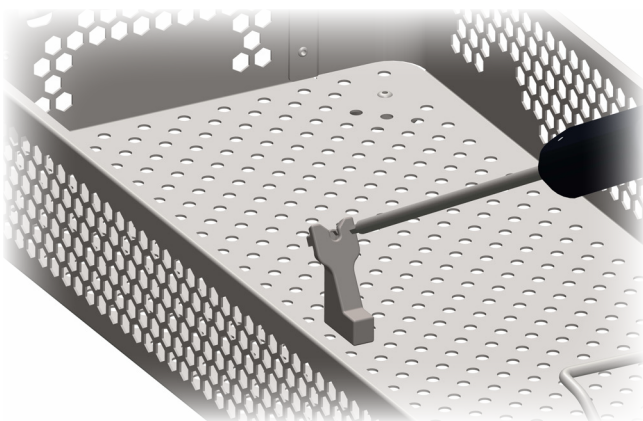

Figure 18a

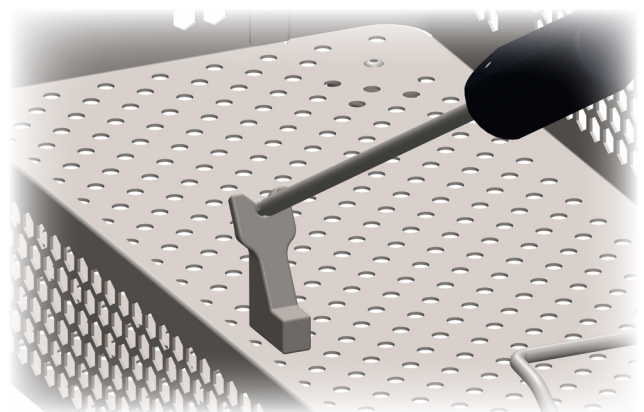
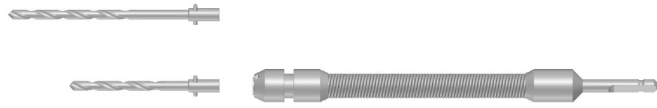
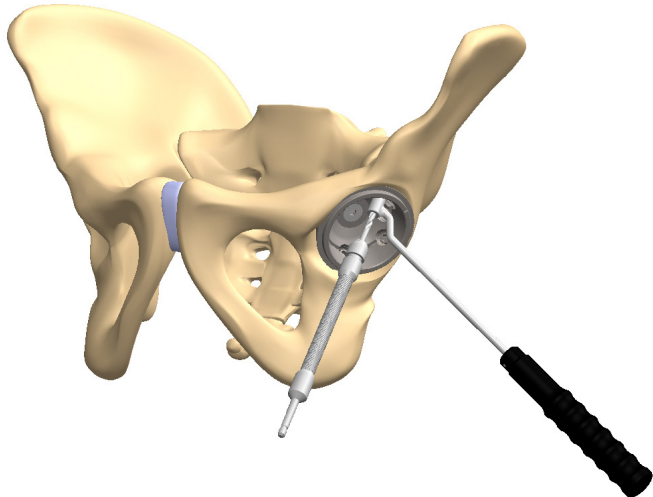

Figure 18b

SURGICAL TECHNIQUE



Two drill bits are available for preparing the screw holes.



Mount a drill bit to the flexible drill shaft and drill through the drill guide (Fig. 19). Screws can be angled up to 15 degrees.

Flexible drill shafts are allowed to be loaded with a maximum torque of 0,2Nm at a maximum bending of 45°. Pay attention that the flexible part is bent with a preferably uniform bending radius during application. The application with adjustments of narrow nonuniform or s-curved bendings can reduce the lifetime. The form stability of the flexible drill shaft is given for a torque of up to 0,5Nm.

Figure 19

When you position the holes, please consider that the most suitable bone for screw fixation is situated in the cranio/posterior parts of the acetabulum, whereas a screw fixation in the os ischii or os pubis leads to an unsatisfactory fit of the screws. In case of inserting the cancellous bone screws in direction to the foramen ischiadicum, you may guard against an injury of the N. ischiadicus by an exact palpation of this part. When positioning the screws and drilling the holes, please act with utmost caution to avoid the penetration of the interior corticalis of the pelvis or the foramen ischiadicum. Please consider the run of the neurovascular structures.

Please insert the depth gauge and determine the required length of the screw (Fig. 20). If you plan to use additional screws, proceed in the same way.

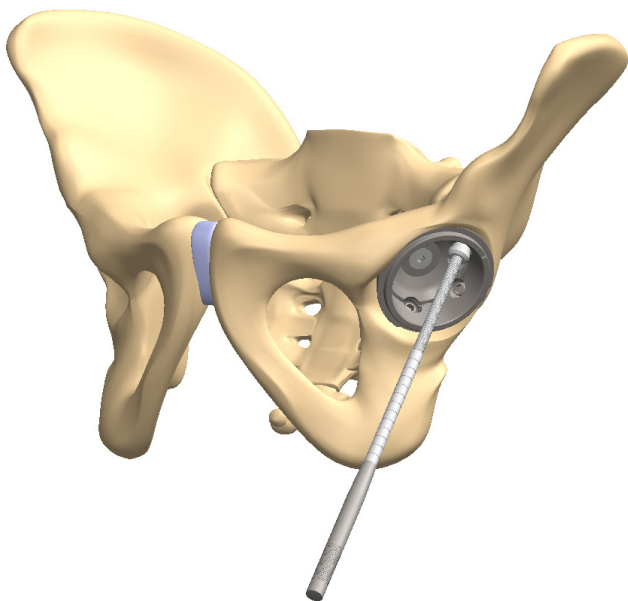
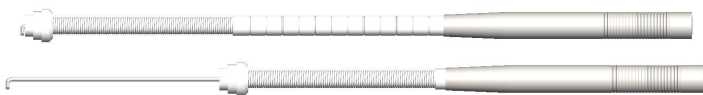

Figure 20

SURGICAL TECHNIQUE

The cancellous screw is inserted into the prepared hole (Fig. 21 and 22). Either a straight or a cardan screwdriver can be used.

Make sure that the head of the cancellous bone screw is completely counter-sunk into the hole of the EcoFit® cup to assure the correct positioning of the cup insert (Fig. 23).

The stability of the implant fit is checked by exercising pressure to the rim of the cup. This stability test must not show any visible motion of the EcoFit® cup.

If the primary stability is still uncertain, an additional fixation of the screw or the use of a cemented acetabular component shall be considered.

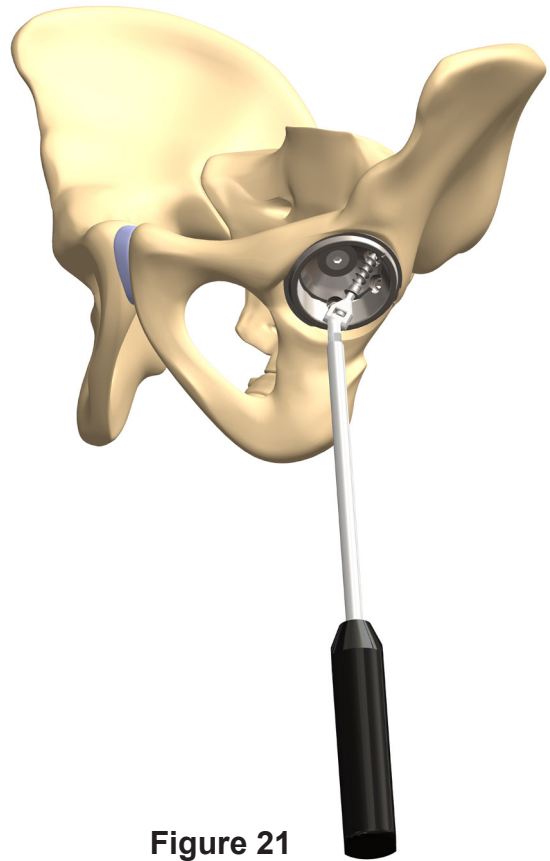

Figure 21

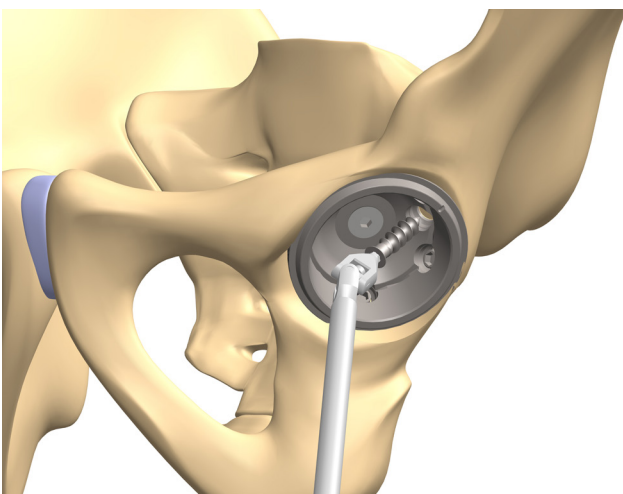
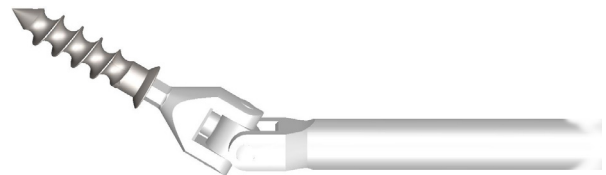

Figure 22

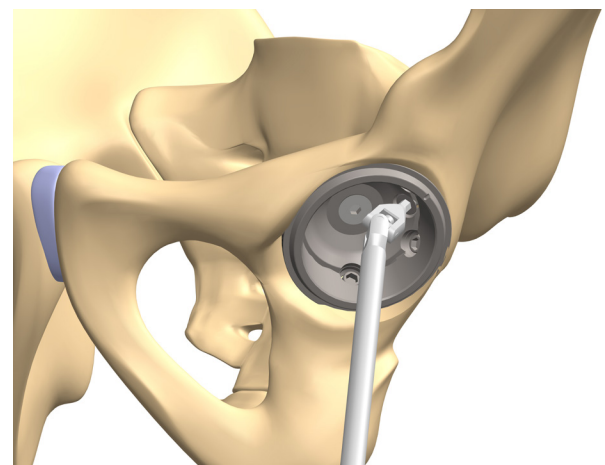
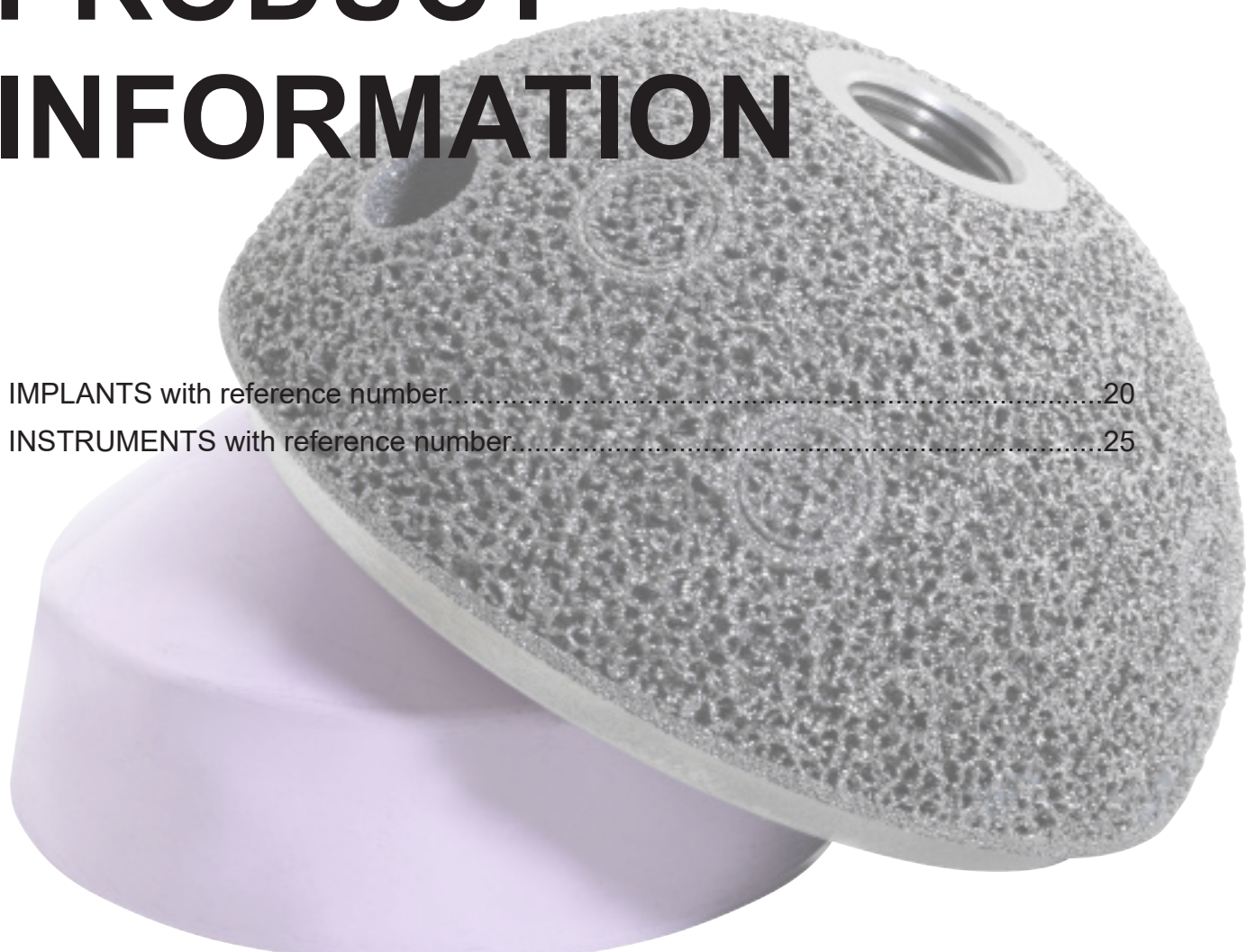

Figure 23

EcoFit[®] EPORE[®] cup

PRODUCT- INFORMATION



IMPLANTS with reference number.....	20
INSTRUMENTS with reference number.....	25

IMPLANTS

EcoFit® cup EPORE®, cementless incl. central hole cover

TiAl₆V₄ with EPORE®



REF standard	size	REF NH-version
0220-0742	42mm	0220-0942
0220-0744	44mm	0220-0944
0220-0746	46mm	0220-0946
0220-0748	48mm	0220-0948
0220-0750	50mm	0220-0950
0220-0752	52mm	0220-0952
0220-0754	54mm	0220-0954
0220-0756	56mm	0220-0956
0220-0758	58mm	0220-0958
0220-0760	60mm	0220-0960
0220-0762	62mm	0220-0962
0220-0764	64mm	0220-0964
0220-0766	66mm	0220-0966
0220-0768	68mm	0220-0968
0220-0770	70mm	0220-0970
0220-0772	72mm	0220-0972

EcoFit® cup EPORE® multihole, cementless incl. central hole cover

TiAl₆V₄ with EPORE®



REF multihole	size
0220-0642	42mm
0220-0644	44mm
0220-0646	46mm
0220-0648	48mm
0220-0650	50mm
0220-0652	52mm
0220-0654	54mm
0220-0656	56mm
0220-0658	58mm
0220-0660	60mm
0220-0662	62mm
0220-0664	64mm
0220-0666	66mm
0220-0668	68mm
0220-0670	70mm
0220-0672	72mm

IMPLANTS

EcoFit® cup EPORE® /TCP, cementless* incl. central hole cover

TiAl₆V₄ with EPORE®, with TCP-coating

REF standard	size	REF NH-version
0220-2042	42mm	0220-7042
0220-2044	44mm	0220-7044
0220-2046	46mm	0220-7046
0220-2048	48mm	0220-7048
0220-2050	50mm	0220-7050
0220-2052	52mm	0220-7052
0220-2054	54mm	0220-7054
0220-2056	56mm	0220-7056
0220-2058	58mm	0220-7058
0220-2060	60mm	0220-7060
0220-2062	62mm	0220-7062
0220-2064	64mm	0220-7064
0220-2066	66mm	0220-7066
0220-2068	68mm	0220-7068
0220-2070	70mm	0220-7070
0220-2072	72mm	0220-7072



EcoFit® cup EPORE® / TCP multihole, cementless* incl. central hole cover

TiAl₆V₄ with EPORE®, with TCP-coating

REF multihole	size
0220-6042	42mm
0220-6044	44mm
0220-6046	46mm
0220-6048	48mm
0220-6050	50mm
0220-6052	52mm
0220-6054	54mm
0220-6056	56mm
0220-6058	58mm
0220-6060	60mm
0220-6062	62mm
0220-6064	64mm
0220-6066	66mm
0220-6068	68mm
0220-6070	70mm
0220-6072	72mm



* only available on special request

IMPLANTS

spongiosa screw flat head Ø 6,5mm

implatan®, TiAl₆V₄ acc. to ISO 5832-3



REF	length
0280-1015	15mm
0280-1020	20mm
0280-1025	25mm
0280-1030	30mm
0280-1035	35mm
0280-1040	40mm
0280-1045	45mm

The spongiosa screws are included in the shipment till length 50mm. We are providing lengths till 80mm on request.

BIOLOX® delta-cup insert

BIOLOX® delta ceramic Al₂O₃ and ZrO₂
acc. to ISO 6474-2



REF	size
0220-2835	28/35 (cup 42-44mm)
0220-3239	32/39 (cup 46-48mm)
0220-3244	32/44 (cup 50-54mm)
0220-3644	36/44 (cup 50-54mm)
0220-3248	32/48 (cup 56-58mm)
0220-3648	36/48 (cup 56-58mm)
0220-4048*	40/48 (cup 56-58mm)
0220-3252	32/52 (cup 60-72mm)
0220-3652	36/52 (cup 60-72mm)
0220-4052*	40/52 (cup 60-72mm)

PE cup insert 0°

UHMWPE acc. to ISO 5834-2



REF	size
0280-2039	28/39 (cup 46-48mm)
0280-2044	28/44 (cup 50-54mm)
0280-3444	32/44 (cup 50-54mm)
0280-2048	28/48 (cup 56-58mm)
0280-3448	32/48 (cup 56-58mm)
0280-4448	36/48 (cup 56-58mm)
0280-2052	28/52 (cup 60-72mm)
0280-3452	32/52 (cup 60-72mm)
0280-4452	36/52 (cup 60-72mm)

*only available on request

IMPLANTS

PE cup insert 10°

UHMWPE acc. to ISO 5834-2

REF	size
0280-2139	28/39 (cup 46-48mm)
0280-2144	28/44 (cup 50-54mm)
0280-3144	32/44 (cup 50-54mm)
0280-2148	28/48 (cup 56-58mm)
0280-3148	32/48 (cup 56-58mm)
0280-4548	36/48 (cup 56-58mm)
0280-2152	28/52 (cup 60-72mm)
0280-3152	32/52 (cup 60-72mm)
0280-4552	36/52 (cup 60-72mm)



implacross® PE cup insert 0°

crosslinked UHMWPE

REF	size
0223-2839	28/39 (cup 46-48mm)
0223-3239	32/39 (cup 46-48mm)
0223-2844*	28/44 (cup 50-54mm)
0223-3244	32/44 (cup 50-54mm)
0223-3644	36/44 (cup 50-54mm)
0223-2848*	28/48 (cup 56-58mm)
0223-3248	32/48 (cup 56-58mm)
0223-3648	36/48 (cup 56-58mm)
0223-2852*	28/52 (cup 60-72mm)
0223-3252	32/52 (cup 60-72mm)
0223-3652	36/52 (cup 60-72mm)



implacross® PE cup insert 10°

crosslinked UHMWPE

REF	size
0224-2835	28/35 (cup 42-44mm)
0224-2839	28/39 (cup 46-48mm)
0224-3239	32/39 (cup 46-48mm)
0224-2844*	28/44 (cup 50-54mm)
0224-3244	32/44 (cup 50-54mm)
0224-3644	36/44 (cup 50-54mm)
0224-2848*	28/48 (cup 56-58mm)
0224-3248	32/48 (cup 56-58mm)
0224-3648	36/48 (cup 56-58mm)
0224-2852*	28/52 (cup 60-72mm)
0224-3252	32/52 (cup 60-72mm)
0224-3652	36/52 (cup 60-72mm)

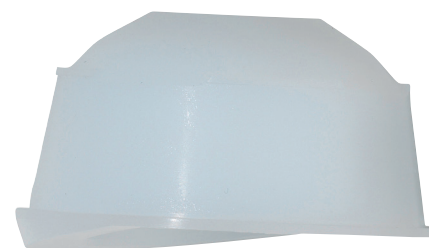

IMPLANTS

EcoFit® insert TiN

implavit® CoCrMo acc. to ISO 5832-12
with TiN coating*

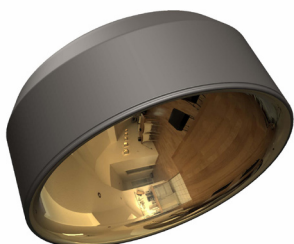

REF	size (inner-Ø/outer-Ø)
0220-3844	38/44mm
0220-4248	42/48mm
0220-4652	46/52mm

EcoFit® insert

implavit® CoCrMo acc. to ISO 5832-12



REF	size (inner-Ø/outer-Ø)
0223-3844	38/44mm
0223-4248	42/48mm
0223-4652	46/52mm

2M implacross® E head

implacross® E, crosslinked UHMWPE with Vitamin E

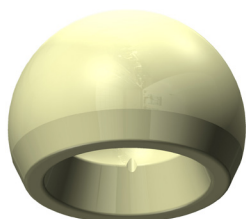

REF	size (inner-Ø/outer-Ø)
2905-2238	22/38mm
2905-2842	28/42mm
2905-2846	28/46mm

EcoFit® 2M head

UHMWPE acc. to ISO 5834-2

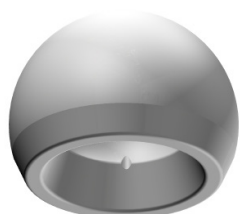

REF	size (inner-Ø/outer-Ø)
2906-2238	22/38mm
2906-2842	28/42mm
2906-2846	28/46mm

* EcoFit® insert with TiN coating is only available on request as a special product!

INSTRUMENTS

0220-0036
EcoFit® cup EPORE® container
(top)

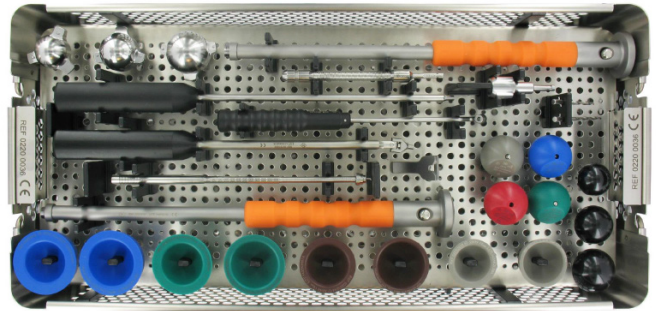

0220-0036
EcoFit® cup EPORE® container
(bottom)

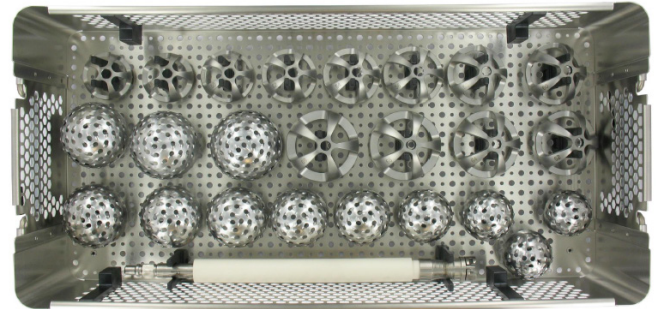

0220-0336
EcoFit® Cup EPORE® container
(top)

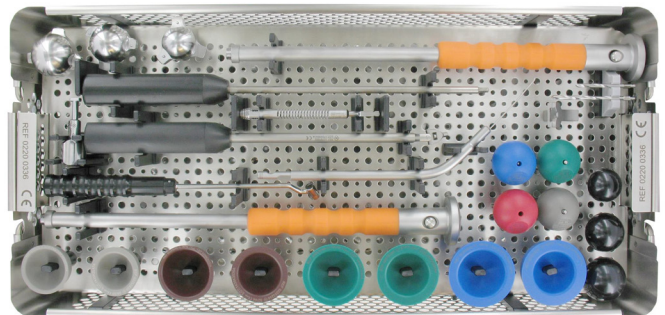

0220-0336
EcoFit® Cup EPORE® container
(bottom)

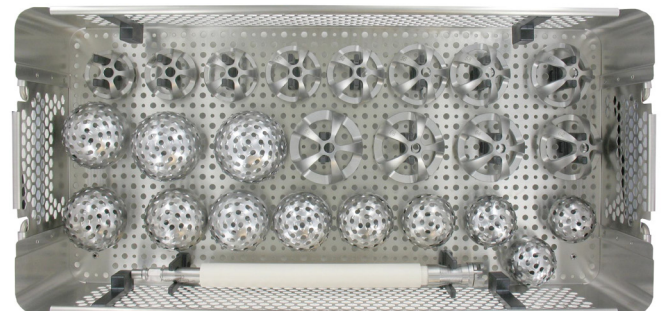

0220-2020
container for EcoFit® insert

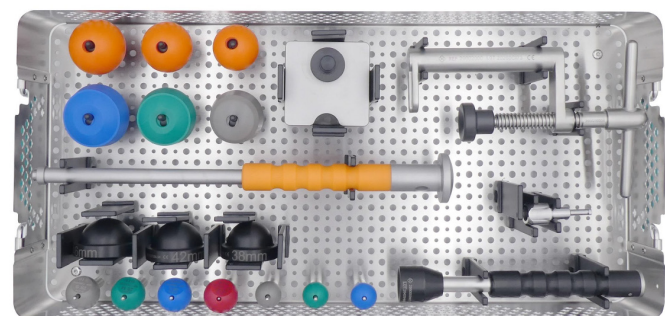

INSTRUMENTS

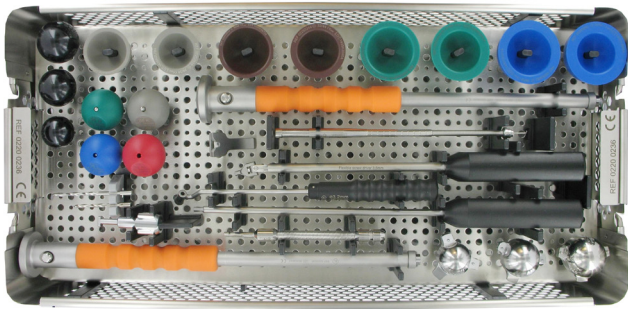

0220-0236
EcoFit® Cup GIS® container 36mm
(top)

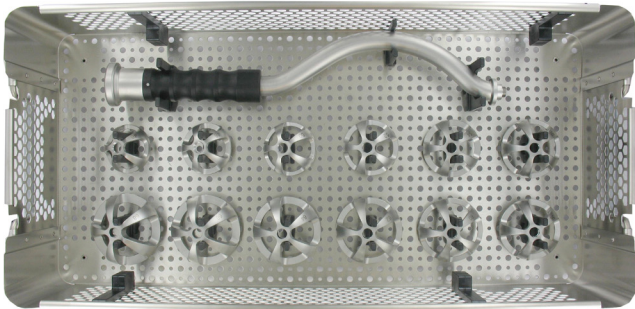

0220-0236
EcoFit® Cup GIS® container 36mm
(bottom)

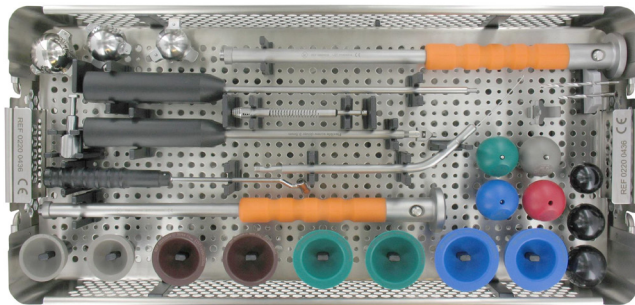

0220-0436
EcoFit® Cup EPORE® container GIS®
(top)

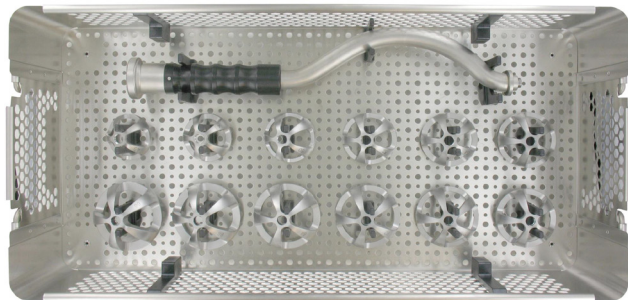

0220-0436
EcoFit® Cup EPORE® container GIS®
(bottom)

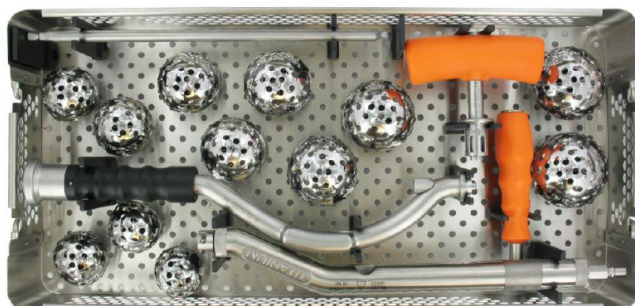

7999-0800
GIS® acetabulum reamer container
with curved cup impactor

NOTE: The containers 0220-0236 and 0220-0436 have always to be used with container 7999-0800.

INSTRUMENTS

0220-0037
EcoFit® cup EPORE® NH container
(top)

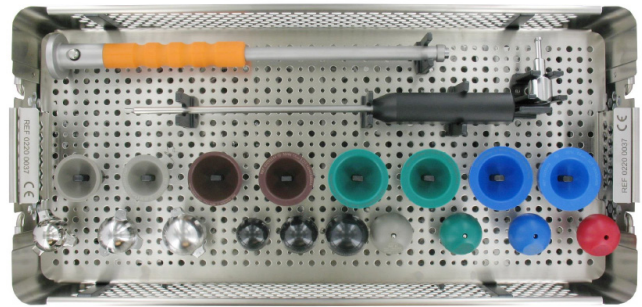

0220-0037
EcoFit® cup EPORE® NH container
(bottom)

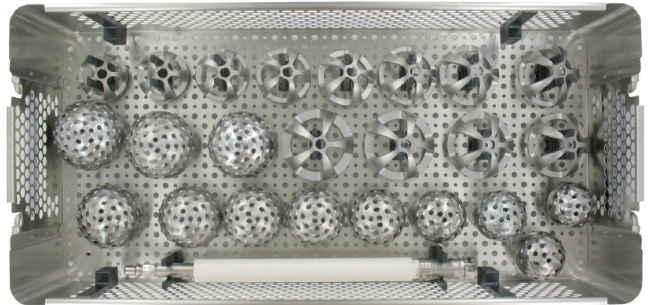

0220-0136
EcoFit® Cup EPORE® container
42-44mm

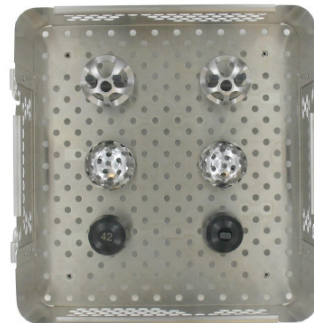

0220-0138
EcoFit® cup EPORE® container
70-72mm

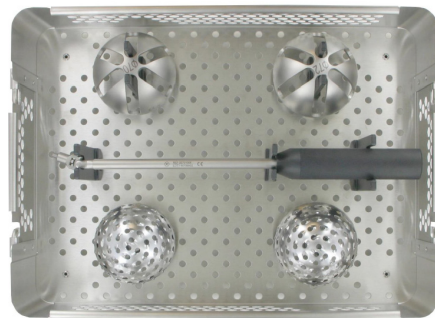

0220-0040
Trial container for ceramic insert 40mm
only available on request

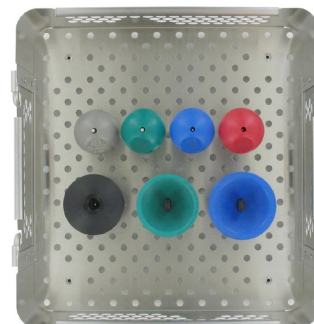

Instruments are delivered non-sterile. The relevant information on reprocessing must be observed.

INSTRUMENTS

CONTAINER 0220-0036 / -0336 / -0236 / -0436 / -0037



acetabulum reamer low profile (not in container 02200236 and 02200436)

2950-3046 / 2960-3046	Ø 46mm
2950-3048 / 2960-3048	Ø 48mm
2950-3050 / 2960-3050	Ø 50mm
2950-3052 / 2960-3052	Ø 52mm
2950-3054 / 2960-3054	Ø 54mm
2950-3056 / 2960-3056	Ø 56mm
2950-3058 / 2960-3058	Ø 58mm
2950-3060 / 2960-3060	Ø 60mm
2950-3062 / 2960-3062	Ø 62mm
2950-3064 / 2960-3064	Ø 64mm
2950-3066 / 2960-3066	Ø 66mm
2950-3068 / 2960-3068	Ø 68mm

The acetabulum reamer low profile are available in 1mm steps on request.



handle for acetabulum reamer (not in container 02200236 and 02200436)

2950-2010



EcoFit® trial cup

0220-3046	Ø 46mm
0220-3048	Ø 48mm
0220-3050	Ø 50mm
0220-3052	Ø 52mm
0220-3054	Ø 54mm
0220-3056	Ø 56mm
0220-3058	Ø 58mm
0220-3060	Ø 60mm
0220-3062	Ø 62mm
0220-3064	Ø 64mm
0220-3066	Ø 66mm
0220-3068	Ø 68mm



handle curved (only in container 02200236 and 02200436)

7512-2202



positioner PE Liner 10°

0282-0003	Ø 28mm
0282-0004	Ø 32mm
0282-0036	Ø 36mm

INSTRUMENTS

shell impactor (2x; in container 02200037 1x)
0282-0030



impactor for cup insert

0282-0002 Ø 28mm
0282-0007 Ø 32mm
0282-0009 Ø 36mm

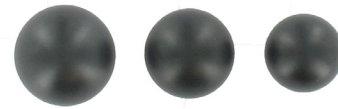

trial head snap taper 12/14mm

7962-3600 / 7965-3600 Ø 36mm short
7962-3605 / 7965-3605 Ø 36mm medium
7962-3610 / 7965-3610 Ø 36mm long
7962-3615 / 7965-3615 Ø 36mm extra long

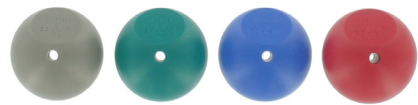

trial insert 0°

0225-2839 Ø 28/39mm
0225-3239 Ø 32/39mm

0225-3244 Ø 32/44mm
0225-3248 Ø 32/48mm
0225-3252 Ø 32/52mm

0225-3644 Ø 36/44mm
0225-3648 Ø 36/48mm
0225-3652 Ø 36/52mm

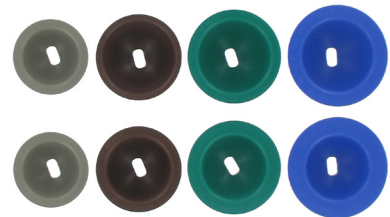

drill bit 3.2mm (not in container 02200037)

0282-1005 56mm (container 02200036 and 02200236)
0282-1070 70mm (container 02200036 and 02200236)

0282-3240 40mm (container 02200336 and 02200436)
0282-3260 60mm (container 02200336 and 02200436)

alternative: drill Ø 3.2mm with depth marking

0232-0040 40mm
0232-0060 60mm

flexible drill shaft (not in container 02200037)

0282-1000 (container 02200036 and 02200236)
0282-2110 (container 02200336 and 02200436)

alternative: flexible drill shaft ic

0282-2120



INSTRUMENTS

COMBINATION FLEXIBLE DRILL SHAFT AND DRILL BIT

REF	REF	REF
0282-2110	0282-1000	0282-2120
0282-3240	0282-1005	0232-0040
0282-3260	0282-1070	0232-0060



depth gauge
(only in container 02200036 and 02200236)
0282-1007



depth gauge two-piece
(only in container 02200336 and 02200436)
0282-1009



trial insert extractor
1260-0009



screw driver long 3,5mm
0280-1006



flexible screw driver 3,5mm
(not in container 02200037)
0270-1002



angled drill guide 3,2mm
(not in container 02200037)
0282-1001



plug remover (not in container 02200037)
0220-2011

INSTRUMENTS

CONTAINER 0220-2020

trial head taper 12/14

- 7965-2200 Ø 22mm short
- 7965-2205 Ø 22mm medium
- 7965-2210 Ø 22mm long
- 7965-2800 Ø 28mm short
- 7965-2805 Ø 28mm medium
- 7965-2810 Ø 28mm long
- 7965-2815 Ø 28mm x-long

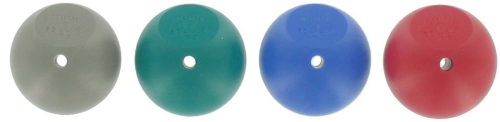

femoral head impactor

2950-0039



ic head assembling tool

2900-2000



2M trial head

- 2950-2238 22/38mm
- 2950-2842 28/42mm
- 2950-2846 28/46mm

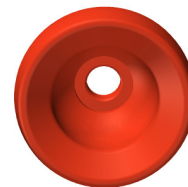

trial for EcoFit® insert

- 0225-3844 38/44mm
- 0225-4248 42/48mm
- 0225-4652 46/52mm



impactor for EcoFit® insert

- 0282-0038 38mm
- 0282-0042 42mm
- 0282-0046 46mm



trial insert extractor

1260-0009



INSTRUMENTS

CONTAINER 7999-0800



cup impactor curved constrained
2950-0606



ic-T-handle Zimmer-Jakobs
4223-0023



ic adapter with hexagon ball 8mm
7512-3608



offset handle for acetabular reamer GIS®
7512-1700



acetabulum reamer solid profile

7512-1746	Ø 46mm
7512-1748	Ø 48mm
7512-1750	Ø 50mm
7512-1752	Ø 52mm
7512-1754	Ø 54mm
7512-1756	Ø 56mm
7512-1758	Ø 58mm
7512-1760	Ø 60mm
7512-1762	Ø 62mm
7512-1764	Ø 64mm
7512-1766	Ø 66mm
7512-1768	Ø 68mm

INSTRUMENTS

CONTAINER 0220-0136

impactor 42mm
0220-4042

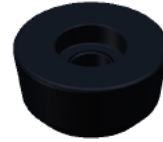

trial insert 0°
0225-2835 Ø 28/35mm



acetabulum reamer low profile
2950-3042 / 2960-3042 Ø 42mm
2950-3044 / 2960-3044 Ø 44mm



EcoFit® trial cup
0220-3042 Ø 42mm
0220-3044 Ø 44mm

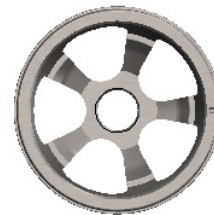

CONTAINER 0220-0138

acetabulum reamer low profile
2960-3070 Ø 70mm
2960-3072 Ø 72mm



trial shell open
2950-2370 Ø 70mm
2950-2372 Ø 72mm



flexible screw driver 3,5mm
0270-1008



INSTRUMENTS

CONTAINER 0220-0040

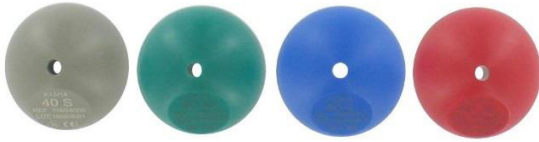

trial head taper 12/14

7965-4000	Ø 40mm S
7965-4005	Ø 40mm M
7965-4010	Ø 40mm L
7965-4015	Ø 40mm XL



trial insert 0°

0225-4048	Ø 40/48mm
0225-4052	Ø 40/52mm



impactor for cup insert

0282-0040	Ø 40mm
-----------	--------

Only available on request!

ADDITIONAL SINGLE INSTRUMENT

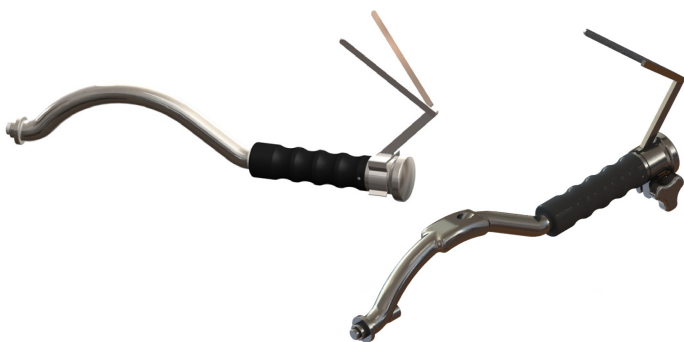

alignment guide

7512-2203 for curved handle
(current version: with screw)

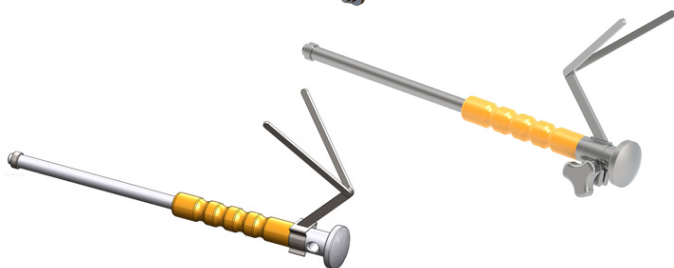

alignment guide

7512-2204 for shell impactor straight
(current version: with screw)

Only available on request!

PRE- / POST-OPERATIVE INSTRUCTIONS

Intended Use

The EcoFit® cups EPORE® are acetabular components intended to be used in combination with an acetabular cup insert to replace the natural acetabulum in total hip arthroplasty.

The EcoFit® cups EPORE® are intended for cementless, press-fit fixation.

PE insert 0°, PE insert 10°, implacross® PE insert 0° and implacross® PE insert 10° are acetabular cup inserts intended to articulate with a femoral head prosthesis.

The BIOLOX® delta cup insert is intended for insertion into a modular acetabular cup to provide the articulating surface with an ic-head BIOLOX® as part of a total hip arthroplasty.

EcoFit® inserts are acetabular cup inserts intended to articulate with the convex (outer) spherical surface of the 2M polyethylene head (EcoFit® 2M Head / 2M implacross® E Head) in Dual Mobility total hip arthroplasty.

Pre-operative Instructions

A pre-operative planning is mandatory for optimal results. Before surgery a surgical planning with regard to the dimensions of the prosthetic model and the positioning of the implant components in the bone has to be carried out by the surgeon.

For this purpose, x-ray templates are available:

Digital templates: Digital templates are included in the data base of the common planning systems. For missing templates, please contact the provider of the planning software and request for these templates.

Radiographic templates: Alternatively, radiographic templates are available in various scale factors, which can be obtained from your local representative.

The surgeon must ensure that:

- all needed components are available during surgery. An adequate number of all necessary implant components will be available during surgery. It should be determined whether the implantation should be done cemented or cementless.
- all instruments necessary will be present for surgery and that they match the implants being used. Only instruments designed for use with the implant system by implantcast GmbH should be used. An exception are exclusively the standardized instruments used during surgery.
- The correct sized instruments are used during surgery to prevent damage to the implants.

Post-operative Instructions

Post-operative patient care, patient instructions and warnings are of the utmost importance.

The use of an external support of the operated limb for a limited period is recommended.

Active and passive movements of the patient should be monitored.

The post-operative regime should be aimed at the prevention of overloading of the joint and stimulation of the healing process.

Regular monitoring of the position and condition of the prosthetic components and the surrounding bone is recommended.

INDICATIONS / CONTRAINDICATIONS

Indications

The decision for replacement of the joint should be based on careful evaluation. The indication for this type of surgery should only be made when all other conservative or surgical alternatives are less promising.

Danger of post-operative complications can be limited by careful evaluation of the individual anatomical and load conditions, the condition of the soft tissues and the condition of the bone bed for the implants.

The provision of prostheses is generally indicated only in patients whose skeleton is fully grown.

Before intervention, preoperative examinations should be performed. The examinations depend on the patient's history.

Under consideration of these conditions, the hip joint replacement applies to the following indications:

- Non-inflammatory degenerative joint disease including osteoarthritis and avascular necrosis,
- Post-traumatic osteoarthritis,
- Treatment of fractures that are unmanageable using other surgical techniques,
- Rheumatoid arthritis
- Revision hip arthroplasty (EcoFit® cups EPORE®).

The EcoFit® Inserts are only to be used in conjunction with the EcoFit® 2M or 2M implacross® E heads in Dual Mobility Hip Arthroplasty. The EcoFit® insert is indicated for patients with an increased risk of dislocation.

Contraindications

The longevity of an orthopaedic joint replacement device can be reduced by biological aspects, material characteristics and biomechanical factors. Patient selection and indication should be carefully monitored especially in patients who are overweight, patients with high physical activity levels and patients younger than 60 years.

Hip joint replacement is contraindicated in cases of:

- Allergy to one of the implant materials (The label on the secondary packaging of the respective component indicates the materials used. It is strongly recommended to perform an allergy test.)
- Ongoing infections.
- Physiological or anatomic conditions, which preclude or are not expected to maintain an adequate bony support of the implant or do not allow the implantation of a sufficiently large prosthesis.
- Bone tumors in the implant fixation area.
- Untreated vascular diseases which limit blood supply to the affected limb.
- Metabolic disorders that may impair bone formation.
- Severe neuromuscular diseases that strongly impair the affected limb.

In case of insufficient quantity and quality of bone stock, an alternative prosthetic treatment allowing for sufficient bony fixation should be considered.

Notes to indications and contraindications

- Using a BIOLOX® delta insert in combination with an acetabular shell left in situ in a revision surgery is contraindicated. In this case, a polyethylene insert may be used.
- In the event of the fracture of a ceramic component, a combination of metal (ball head) with plastic (insert) as well as metal with metal is contraindicated in a revision.

INDICATIONS / CONTRAINDICATIONS

Risk factors

The following risk factors may affect the success of the hip joint replacement:

- Excessive loading of the operated joint by strong physical work and/or inappropriate sports,
- Severe deformities, which lead to an impairment of bone fixation or the exact positioning or the function of the implant,
- Therapies that may affect bone quality,
- Muscle insufficiency,
- Neuromuscular disease of the affected limb,
- Conditions that restrict the patient's ability or willingness to comply with medical instructions, especially during the healing process,
- Obesity,
- Nicotine and/or drug abuse,
- Alcoholism,
- Previous surgeries on the affected limb,
- Conditions after infection,
- Diabetes,
- Psoriasis.



implantcast

implantcast GmbH
Lüneburger Schanze 26
21614 Buxtehude
Germany
phone: +49 4161 744-0
fax: +49 4161 744-200
e-mail: info@implantcast.de
internet: www.implantcast.de



Your local distributor:

