

CUSTOMER:
 CHISINAU
 MOLDOVA

DESCRIPTION:
 CHILD PACK <6 KG

PRODUCT CODE: CK-ML026

DRAWING TYPE: PRODUCTION

Total Priming Volume:

DRAWN BY: STEPHEN ELYNN

ISSUED: 08/12/2016

ISSUE No.: 5

INT. AMEND: 29/09/2017-SF

AMENDED: 16/04/2019-SF

SHEET No.: 1/5

THIS DOCUMENT IS THE PROPERTY OF TERUMO EUROPE AND MAY NOT BE COPIED BY ANY THIRD PARTY.



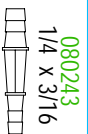

7.

080520 PEEL POUCH 100 X 150 MM

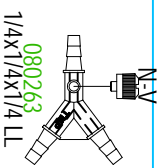

8.

080523 PEEL POUCH 100 X 200 MM

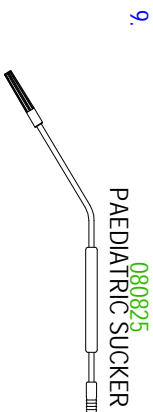

9.

LENGTH CUT TO - 50 cm
080509 VIEWREEL 100 mm

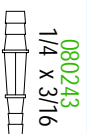

10.

080520 PEEL POUCH 100 X 150 MM



11.

080520 PEEL POUCH 100 X 150 MM

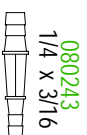

12.

080520 PEEL POUCH 100 X 150 MM

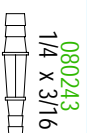

13.

080520 PEEL POUCH 100 X 150 MM

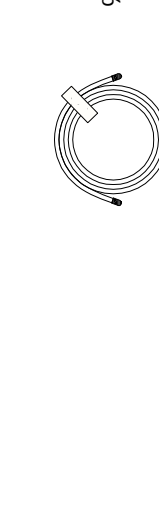
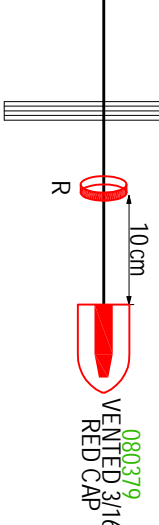
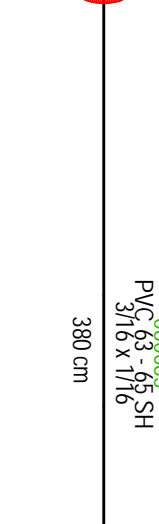
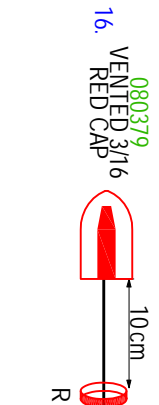
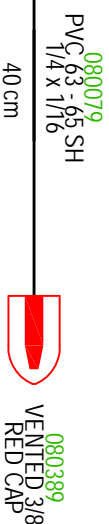
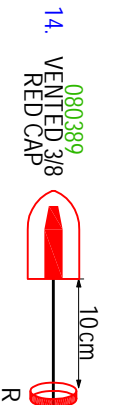

CUSTOMER:

CHISMAU
MOLDOVA

DESCRIPTION:

CHILD PACK -6 KG

PRODUCT CODE:

CX-ML026

DRAWING TYPE:

PRODUCTION

Total Priming Volume:

DRAWN BY: STEPHEN FLYNN

INT. AMEND: 29/09/2017-SF

ISSUED: 08/7/2016

AMENDED: 16/04/2019-SF

ISSUE No.: 5

SHEET No.: 2/5

THIS DOCUMENT IS THE PROPERTY OF TERUMO EUROPE AND MAY NOT BE COPIED BY ANY THIRD PARTY.



17.

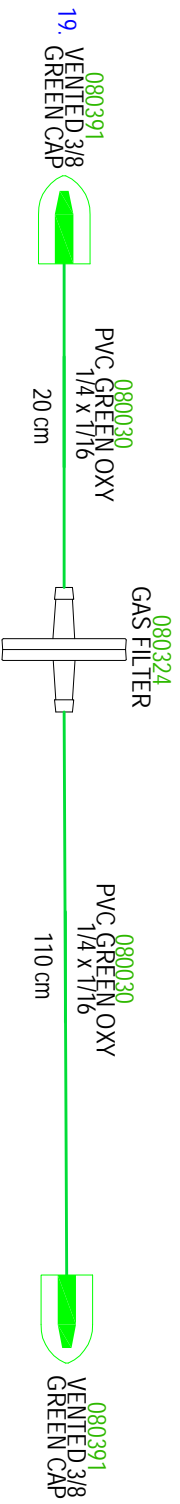
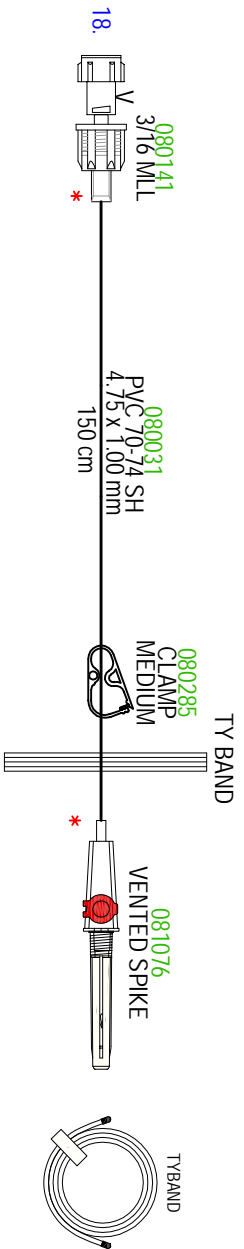

CUSTOMER:

CHISIMAU
MOLDOVA

DESCRIPTION:

CHILD PACK <6 KG

PRODUCT CODE:

CX-ML026

DRAWING TYPE:

PRODUCTION

Total Priming Volume:

DRAWN BY: STEPHEN FLYNN

INT. AMEND: 29/09/2017-SF

ISSUED: 08/12/2016

AMENDED: 16/04/2019-SF

ISSUE No.: 5

SHEET No.: 3/5

THIS DOCUMENT IS THE PROPERTY OF TERUMO EUROPE AND MAY NOT BE COPIED BY ANY THIRD PARTY.



20. **NO CAP**
080243
3/16 x 1/4
PVC 63 - 65 SH
1/4 x 1/16
10 cm
NO CAP

21. **NO CAP**
080243
3/16 x 1/4
PVC 63 - 65 SH
1/4 x 1/16
10 cm
NO CAP

22. **NO CAP**
080243
3/16 x 1/4
PVC 63 - 65 SH
1/4 x 1/16
10 cm
NO CAP

23. **NO CAP**
080243
3/16 x 1/4
PVC 63 - 65 SH
1/4 x 1/16
10 cm
NO CAP

080510 PEEL POUCH 200 X 275 MM

080483 GAS POUCH 508 X 648 X 165 MM

CUSTOMER:

CHISINAU
MOLDOVA

DESCRIPTION:

CHILD PACK <6 KG

PRODUCT CODE:

CX-ML026

DRAWING TYPE:

PRODUCTION

Total Priming Volume:

DRAWN BY: STEPHEN FLYNN

ISSUED: 08/12/2016

ISSUE No.: 5

INT. AMEND: 29/09/2017-SF

AMENDED: 16/04/2019-SF

SHEET No.: 4/5

THIS DOCUMENT IS THE PROPERTY OF TERUMO EUROPE AND MAY NOT BE COPIED BY ANY THIRD PARTY.



CP LAYER PAD
080856
0.25

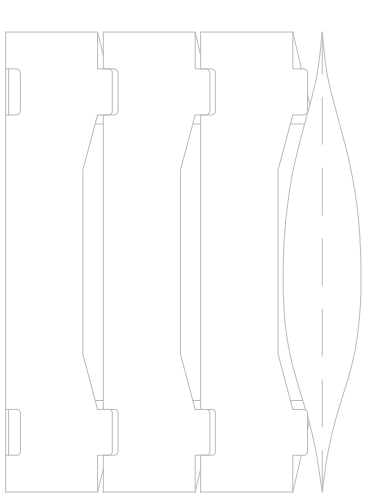

PACKING INFORMATION

EACH GAS POUCH IS TO BE PACKED IN A
CARDBOARD TRAY, ONE ON TOP OF
ANOTHER. 4 PACKS PER BOX

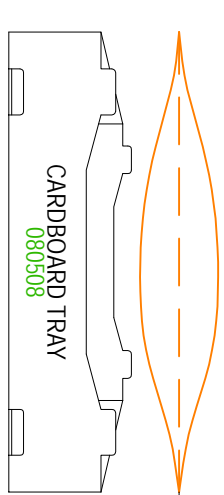

PACK LABEL EXAMPLE

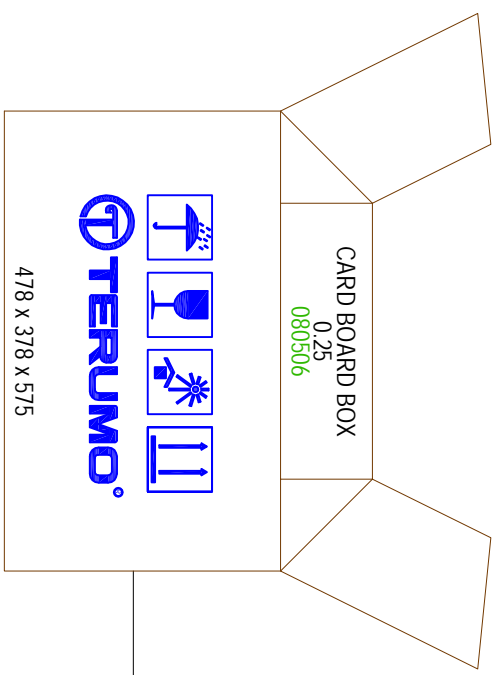

BOX LABEL EXAMPLE

CUSTOMER:	DESCRIPTION:
CHISINAU	CHILD PACK <6 KG
MOLDOVA	
PRODUCT CODE:	Total Priming Volume:
CX-ML026	
DRAWING TYPE:	
PRODUCTION	

DRAWN BY:	STEPHEN FLYNN	ISSUED:	08/7/2016	ISSUE No.:	5
INT. AMEND:	29/09/2017-SF	AMENDED:	16/04/2019-SF	SHEET No.:	5/5
THIS DOCUMENT IS THE PROPERTY OF TERUMO EUROPE AND MAY NOT BE COPIED BY ANY THIRD PARTY.					