





Laparoscopy



**ENDOMED**

# Laparoscopy

## Content

<b>Endoscopes</b>	<i>page</i>
<i>Laparoscopes</i>	06
<i>Fiber Light Cables and adapters</i>	07

---

<b>Trocars</b>	<i>page</i>
<i>Trocar sheaths, plastic body</i>	8-9
<i>Not detachable Trocars</i>	10
<i>Small Trocar sheaths Ø 3,5mm</i>	12
<i>Trocars</i>	11
<i>Security Trocars</i>	14-15
<i>Hasson Cones</i>	13
<i>Reducers, Trocar stops, Reducer sheaths</i>	16
<i>Dilatation sets</i>	17

---

<b>Suction and irrigation</b>	<i>page</i>
<i>Handles with trumpet valve</i>	18-19
<i>Suction-Irrigation cannulas, with 1,2 or 3 stopcocks and L-L connectors</i>	20-21
<i>Palpation probes, graduated - Verress</i>	22
<i>Suction-Irrigation Pistol Handle, Insufflation needles, Ovary needles</i>	23
<i>Knot pushers</i>	24
<i>Cleaning brushes, Tubing connectors- luer connectors</i>	25

<b>Laparoscopic Forceps</b>	<i>page</i>
<i>Handles</i>	26
<i>Dissecting and grasping forceps, Ø5mm</i>	27-39
<i>Biopsy and grasping forceps, Ø5mm</i>	37-38
<i>Scissors, Ø5mm/ Ø10mm</i>	40-42
<i>Dissecting and grasping forceps, Ø10mm</i>	43-45
<i>Biopsy forceps, Scissors, Ø10mm</i>	46
<i>Biopsy / grasping forceps, Scissors, Ø3mm</i>	47
<i>Needleholders</i>	48-49
<i>Wound Closures, Suturing instruments for sub cutaneous closure</i>	48
<i>Bipolar Coagulation Forceps, Ø5mm</i>	50-51
<i>Endo retractors</i>	52
<i>Endo Liver retractors</i>	53
<b>Instruments for Gynecology</b>	<i>page</i>
<i>Uterine manipulator</i>	55-56
<i>Myoma Drills, Tube Dilators</i>	57
<i>Cohen Intrauterine probe</i>	57
<b>Electrodes</b>	<i>page</i>
<i>Mono and Bipolar electrodes</i>	58
<i>Suction &amp; Irrigation Handles, Electrodes</i>	59
<b>Electrodes</b>	<i>page</i>
<i>Mono and Bipolar connection cables and adapters</i>	60
<b>Cleaning instruments</b>	<i>page</i>
<i>Cleaning Pistol with 8 adapters - Cleaning brushes</i>	61

# Laparoscopy

## Endoscopes

*Laparoscopes  
High Definition, wide angle  
Autoclavable, max. 134° C / 2,3 bar / 5 min*



10mm optical system are filled with azoto to avoid condensation inside

Medici Endoscope-line consists of high quality telescopes which have been developed according to the most modern technology and production standards. A new generation optic system assures a unique color, contrast and highly defined details reproduction, both in the middle of the image and at the edges. A particularly true color reproduction and a markable depth of focus guarantee a natural picture. Distal and proximal sapphire windows provide an extremely high level of scratches resistance.

Ordering n°	Diameter	Viewing Angle	Working length
10 200 PA.HD	5,0 mm	0°	200mm
10 300 PA.HD	5,0 mm	0°	300mm
10 300 PE.HD	5,0 mm	30°	300mm

Ordering n°	Diameter	Viewing Angle	Working length
10 314 UA.HD	10,0 mm	0°	314mm
10 314 UE.HD	10,0 mm	30°	314mm
10 314 UF.HD	10,0 mm	45°	314mm

Ordering n°	Diameter	Viewing Angle	Working length
10 310 UA.4K	10,0 mm	0°	310mm
10 310 UE.4K	10,0 mm	30°	310mm

# Laparoscopy

## Fiber Light Cables

### Fiber Light Cables, Xenon Safe, Led White Light

Medici Optical Fiber Cable is made to resist and to shield against very high thermic energies especially in the use of **Xenon** light sources due to the fusion of light fibers in the cable itself.

This guarantees **20%** light more in the operating field.



**New High Performances White Line-LED Light Cables**  
New «WhiteLine» LED series Optical Fibers Light Cables have been designed and made up to be used with cutting edge LED Light Sources. By enhancing the transmission effectiveness of an already well-established and first-choice optical fibers light cable, light output and illumination, when operating with a LED light source together with a modern HD telescope, can be visibly and considerably increased.

### 3,5mm diameter, xenon safe, for Ø 4,0 - 2,9mm scopes

Xenon	LED	Working length	Xenon	LED	Working length
49 180 X	49 180 XL	1800mm	49 300 X	49 300 XL	3000mm
49 230 X	49 230 XL	2300mm	49 400 X	49 400 XL	4000mm
49 250 X	49 250 XL	2500mm	49 500 X	49 500 XL	5000mm

### 4,9mm diameter, xenon safe, for Ø 10,00mm scopes

Xenon	LED	Working length	Xenon	LED	Working length
49 180 P	49 180 PL	1800mm	49 300 P	49 300 PL	3000mm
49 230 P	49 230 PL	2300mm	49 400 P	49 400 PL	4000mm
49 250 P	49 250 PL	2500mm	49 500 P	49 500 PL	5000mm

### Adapters for optic fiber light cable

Ordering n°	Projector end	Description	Ordering n°	Instrument end
49 110 A		Medici/Storz	49 010 A	
49 110 B		Acmi/Stryker	49 010 B	
49 110 C		Wolf/Dyonics	49 010 C	
49 110 D		Olympus/Acme		
49 110 F		Olympus new	49 010 F	

# Laparoscopy

## Trocars



*Trocar sheaths, Smooth **Metal** tube, with or without stopcock*

Ø	WL 70 MM		WL 100MM		WL 140MM	
	with stopcock	without stopcock	with stopcock	without stopcock	with stopcock	without stopcock
5,5mm	120502Q	120508Q	120501Q	120507Q	120503Q	120509Q
11,0mm			120501Z	120507Z	120503Z	120509Z
12,5mm			120501Z1	120507Z1		



*Trocar sheaths, Threaded **Metal** tube, with or without stopcock*

Ø	WL 70 MM		WL 100MM		WL 140MM	
	with stopcock	without stopcock	with stopcock	without stopcock	with stopcock	without stopcock
5,5mm	120514Q	120520Q	120513Q	120519Q	120515Q	120521Q
11,0mm			120513Z	120519Z	120515Z	120521Z
12,5mm			120513Z1	120519Z1		



# Laparoscopy

## Trocars

*Trocar sheaths, Smooth **Plastic** tube, with or without stopcock*



Ø	WL 70 MM		WL 100MM		WL 140MM	
	with stopcock	without stopcock	with stopcock	without stopcock	with stopcock	without stopcock
5,5mm	120505Q	120511Q	120504Q	120510Q	120506Q	120512Q
11,0mm			120504Z	120510Z	120506Z	120512Z
12,5mm			120504Z1	120510Z1		

*Trocar sheaths, Threaded **Plastic** tube, with or without stopcock*



Ø	WL 70 MM		WL 100MM		WL 140MM	
	with stopcock	without stopcock	with stopcock	without stopcock	with stopcock	without stopcock
5,5mm	120517Q	120523Q	120516Q	120522Q	120518Q	120524Q
11,0mm			120516Z	120522Z	120518Z	120524Z
12,5mm			120516Z1	120522Z1		

# Laparoscopy

## Trocars



*Trocar sheaths, Smooth **Metal** tube, with or without stopcock, not detachable*

Ø	WL 70 MM		WL 100MM		WL 140MM	
	with stopcock	without stopcock	with stopcock	without stopcock	with stopcock	without stopcock
5,5mm	120602Q	120608Q	120601Q	120607Q	120603Q	120609Q
11,0mm			120601Z	120607Z	120603Z	120609Z
12,5mm			120601Z1	120607Z1		



*Trocar sheaths, Threaded **Metal** tube, with or without stopcock, not detachable*

Ø	WL 70 MM		WL 100MM		WL 140MM	
	with stopcock	without stopcock	with stopcock	without stopcock	with stopcock	without stopcock
5,5mm	120605Q	120611Q	120604Q	120610Q	120606Q	120612Q
11,0mm			120604Z	120610Z	120606Z	120612Z
12,5mm			120604Z1	120610Z1		



Ø	Grey sealing cap	Inner sealing cap	SET
5,5mm	1223Q	1224Q	1225Q
11,0mm	1223Z	1224Q	1225Z
12,5mm	1223Z1	1224Q	1225Z1

# Laparoscopy

## Trocars



WL 100mm



Ø	Triangular point	Conical point	Conical blunt	Hollow grinding
5,5mm	120701Q	120704Q	120707Q	120710Q
11,0mm	120701Z	120704Z	120707Z	120710Z
12,5mm	120701Z1	120704Z1	120707Z1	120710Z1

WL 70mm

Ø	Triangular point	Conical point	Conical blunt	Hollow grinding
5,5mm	120702Q	120705Q	120708Q	120711Q

WL 140mm

Ø	Triangular point	Conical point	Conical blunt	Hollow grinding
5,5mm	120703Q	120706Q	120709Q	120712Q
11,0mm	120703Z	120706Z	120709Z	120712Z

# ENDOMED

# Laparoscopy

## Trocars

Trocar sheaths, Ø3,5 mm Metal tube

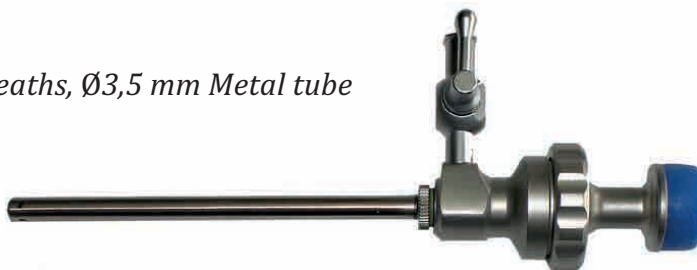







Trocar, Ø3,5 mm Trocar



Trocar tubes



	Ordering n°	Description	Working length
	120542H	Trocar sheath, 3,5 mm Metal tube <b>with</b> stopcock	70mm
	120543H	Trocar sheath, 3,5 mm Metal tube <b>without</b> stopcock	70mm
	120544H	Trocar tube <b>only</b>	70mm
	120546H	Trocar, conical tip	70mm
	120547H	Trocar, blunt tip	70mm
	120550H	Trocar, lunated tip	70mm
	120552H	Trocar, triangular tip	70mm
	1219H	3,5mm Sealing cap	
	1208X	3,5mm O-Ring for tubes	

## Hasson Cones



Ø	threaded	threaded with thread holder	threaded plastic
5,5mm	12023Q	12024Q	12025Q
11,0mm	12023Z	12024Z	12025Z
12,5mm	12023Z1	12024Z1	12025Z1



Ø	threaded plastic with thread holder	threaded	threaded with thread holder
5,5mm	12026Q	12027Q	12028Q
11,0mm	12026Z	12027Z	12028Z
12,5mm	12026Z1	12027Z1	12028Z1



Ø	Sealing cap for hasson cones
5,5mm	1237P
11,0mm	1237Z
12,5mm	1237Z1

# Laparoscopy

## Security Trocars



*Security trocars, oblique*

Ø	WL 70 MM	WL 100MM	WL 140MM
5,5mm	121011Q	121010Q	121012Q
11,0mm		121010Z	121012Z
12,5mm		121010Z1	



*Security trocars, blunt*

Ø	WL 70 MM	WL 100MM	WL 140MM
5,5mm	121014Q	121013Q	121015Q
11,0mm		121013Z	121015Z
12,5mm		121013Z1	

# Laparoscopy

## Security Trocars

*Security trocars*



*Security trocars, short version*



Ø	WL 70 MM		WL 100MM		WL 140MM	
	standard	short version	standard	short version	standard	short version
5,5mm	121002Q	121005Q	121001Q	121004Q	121003Q	121006Q
11,0mm			121001Z	121004Z	121003Z	121006Z
12,5mm			121001Z1	121004Z1		

*Security trocars, oblique, short version*



Ø	WL 70 MM		WL 100MM		WL 140MM	
	standard	short version	standard	short version	standard	short version
5,5mm		121008Q		121007Q		121009Q
11,0mm				121007Z		121009Z
12,5mm				121007Z1		

# Laparoscopy

## Reducers / Trocar stops



Reducers



Ø	Reducer	Sealing cap for reducer
11,0 - 5,5mm	1238ZQ	1201P
12,5 - 5,5mm	1238Z1Q	1201P

Trocar stops



Ø	Thread length 20 mm	Thread length 50 mm	Sealing cap for trocar stop
5,5mm	1239Q	1210Q	1241P
11,0mm	1239Z	1210Z	1241Z
12,5mm	1239Z1	1210Z1	1241Z1



Ø	WL 180MM	WL60MM	Sealing cap
5,0 - 3,0 mm	12042PM		1206X
10,0 - 5,0mm	12042UP	12043UP	1201P
11,0 - 5,5mm	12042ZQ	12043ZQ	1201P
12,5 - 5,5mm	12042Z1Q	12043Z1Q	1201P
12,5 - 10,0mm	12042Z1U	12043Z1U	1201U



# Laparoscopy

## Dilatation sets

*Dilatation set consisting  
of dilatation sheath and 500mm dilator*



Ø	WL 180mm
5,0 - 10,0mm	12047PU
5,0 - 11,0mm	12047PZ
5,0 - 12,5mm	12047PZ1

Dilatation sheath	Ø	WL 180mm
	5,0 - 10,0mm	12049PU
	5,0 - 11,0mm	12049PZ
	5,0 - 12,5mm	12049PZ1



Ø	Sealing cap for dilator	500mm dilator
5,0mm	1201P	12051P
10,0mm	1201U	12051U
11,0mm	1201Z	12051Z

# Laparoscopy

## Suction and irrigation handles with trumpet valves



Handles with large trumpet valves and 9,5mm tube connector

Connector side	Luer-Lock-tube	Luer-Lock	Tube
	140101	140102	140103

### Ø 5,0mm suction tubes



Description	L 330mm	L 450mm
4x4 drilling, rotatable	140115P	140116P
4x4 drilling	140104P	140108P
4x1 drilling	140105P	
2x1 drilling	140106P	
with punctation needle Ø1,2mm	140107P	140109P

### Ø 10,0mm suction tubes



Description	L 300mm	L 330mm	L 360mm	L 450mm
4x4 drilling		140110U		140114U
6x4 drilling	140117U	140111U	140119U	140120U
6x4 drilling, curved 30°, rotatable		140121U		
2x1 drilling		140112U		
Pool type		140113U		
Pool type, rotatable		140118U		

Description	
O-Ring	1204Y



## Small Suction and irrigation handles with trumpet valves



Handles with small trumpet valves and 9,5mm tube connector

Connector side	Luer-Lock-tube	Luer-Lock	Tube
	140122	140123	140124



Description	L 330mm
Ø 3,0 mm, 2x1 drilling	140125M
Ø 3,5 mm, 4x4 drilling	140126X



Description	L 330mm	L 450mm
Ø 5,0 mm, 4x4 drilling	140127P	140130P
Ø 5,0 mm, 4x1 drilling	140128P	
Ø 5,0 mm, with punction needle Ø1,2mm	140129P	140131P



Description	L 330mm	L 450mm
Ø 10,0 mm, 6x4 drilling	140132U	140133U
Ø 10,0 mm, 4x4 drilling		140134U





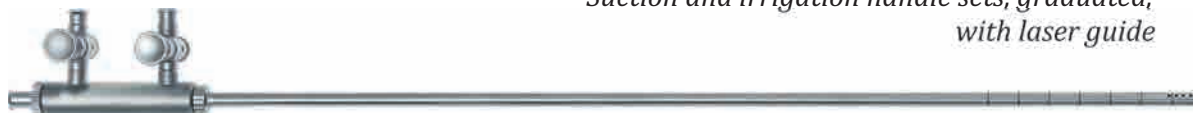

Description	
O-Ring	1204P

# Laparoscopy

## Suction-irrigation tubes, set



*Suction and irrigation handle sets, graduated,  
with laser guide*

Description	Ordering n°	
Set	140135	
consisting of:		
Handle	140136	
Tube, Ø 5,0mm, 330mm, 4x4Ho	140137P	
Laser guide	140138	
Lock cap	140139	

Description	Ordering n°	
Spare parts O-Ring	1204P	



*Suction and irrigation cannulas,  
with lever valves and tubing connector*



Description	Ordering n°
Lever valve handle, tube, connector	140140
Ø 3,0mm Tube, 330mm, 2x1Ho	140142P
Ø 3,5mm Tube, 200mm, 4x1Ho	140143X
Ø 5,0mm Tube, 330mm, 4x4Ho	140144P
Ø 5,0mm Tube, 330mm, 4x4Ho, curved 30°	140147P
Ø 5,0mm Tube, 330mm, 4x1Ho	140145P
Ø 5,0mm Tube, 330mm, 4x1Ho, curved 30°	140148P
Ø 5,0mm Tube, With punction needle, Ø 1.2, 20mm	140146P
Ø 5,0mm Tube, With punction needle, Ø 1.6, 20mm, Curved 30°	140149P
Ø 10,0mm Tube, 330mm, 6x4Ho	140150U
Ø 10,0mm Tube, 330mm, 4x1Ho	140151U

Description	Ordering n°	
Spare parts O-Ring	1204P	

## Suction-irrigation cannulas

Suction and irrigation cannulas with one, two or three stopcocks and Luer-Lock connectors

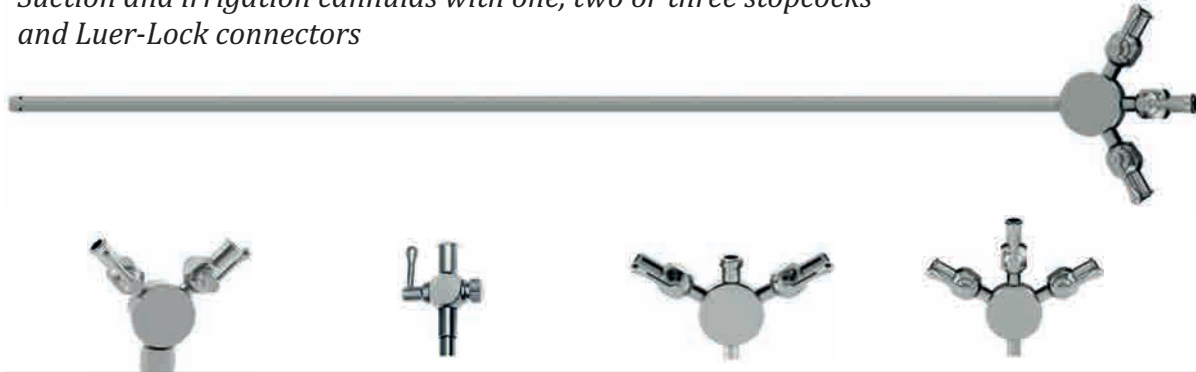

Two-way-valves with Luer-Lock connector	Suction cannula with stopcock 4X4HL	with 2 stopcocks 4X1HL	with 3 stopcocks 4X1HL
140201	140154P	140153P	140152P

Suction tube with Luer-Lock connector



Ø	WL	Ordering n°
5,0mm	330MM	140155P

Suction and irrigation handle with small, Ø6,5mm, trumpet valves, and Luer-Lock tube connector



Small suction and irrigation handle for Luer-Lock tube
140156S



Adapter for HF electrodes
140157HF

# Laparoscopy

## Insufflation needles / Palpation probes



*Ovary curved needles, with Luer-Lock connector*

Ø	Ø Needle	L	Ordering n°
5,0mm	0,7mm	450mm	140215p

*Verress, Insufflation needles, Ø 2,0 / 2,7 mm, with Luer-Lock connector*



Ø 2,0mm	WL	Ordering n°	Ø 2,7mm	WL	Ordering n°
	55mm	140301C		100mm	140313G
	70mm	140302C		120mm	140314G
	80mm	140303C		150mm	140315G
	100mm	140304C		170mm	140316G
	120mm	140305C			
	130mm	140306C			
	140mm	140307C			
	150mm	140308C			
	170mm	140309C			
	180mm	140310C			
	200mm	140311C			
	230mm	140312C			

*Graduated palpation probes*



Ø	200mm	330mm	360mm	400mm	450mm
4,5mm	140401J	140402J	140403J	140404J	140405J
5,0mm	140406P	140407P	140408P	140409P	140410P
10,0mm	140411U	140412U	140413U	140414U	140415U

## Suction-Irrigation, Ovary needles

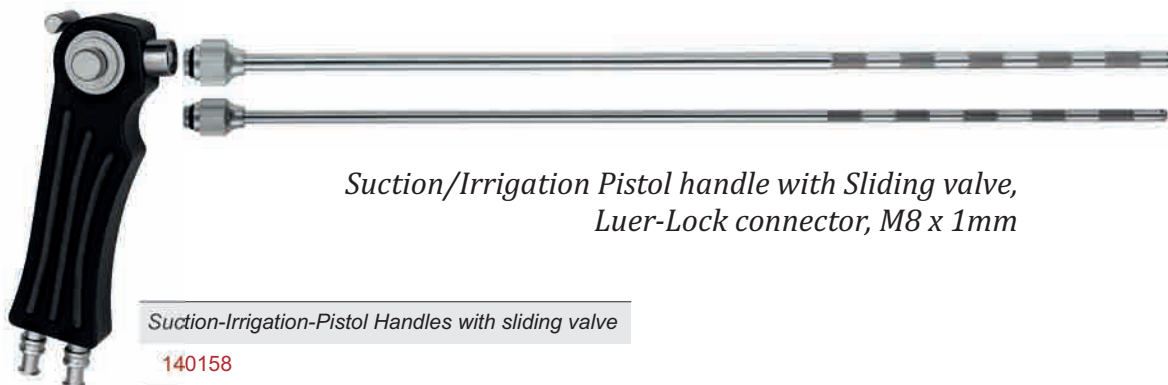

*Suction/Irrigation Pistol handle with Sliding valve,  
Luer-Lock connector, M8 x 1mm*

Suction-Irrigation-Pistol Handles with sliding valve

140158

Adaptable Suction/Irrigation tubes	Ordering n°
4 hols, Ø 3 mm	140159
4 hols, Ø 5 mm	140160
4 hols, Ø 10 mm	140161
4x4 hols, Ø 3 mm	140162
4x4 hols, Ø 5 mm	140163
4x4 hols, Ø 10 mm	140164

### *Ovary needles, with Luer-Lock connector*



Ø	Ø Needle	L	Ordering n°	Ø	Ø Needle	L	Ordering n°
3,0mm	1,0mm	330mm	140202M	5,0mm	1,2mm	450mm	140209P
3,0mm	1,2mm	330mm	140203M	5,0mm	1,4mm	330mm	140210P
3,0mm	1,4mm	330mm	140204M	5,0mm	1,6mm	330mm	140211P
3,5mm	1,2mm	200mm	140205X	5,0mm	1,8mm	345mm	140212P
5,0mm	0,7mm	345mm	140206P	5,0mm	1,8mm	415mm	140213P
5,0mm	1,2mm	330mm	140207P	5,0mm	1,8mm	450mm	140214P
5,0mm	1,2mm	360mm	140208P				

# Laparoscopy

## Knot pushers

*Knot pushers, closed and open versions*



	Ø 3,0 mm	Ø 4,0 mm	Ø 5,0 mm	Ø 3,0 mm	Ø 4,0 mm	Ø 5,0 mm
330mm	140501M	140507N	140513P	140504M	140510N	140516P
400mm	140502M	140508N	140514P	140505M	140511N	140517P
450mm	140503M	140509N	140515P	140506M	140512N	140518P

*Knot pushers, curved, open, WL 330mm*



	Ø 3mm	Ø 4,0mm
Knot pusher, curved open	140525M	140531N

*Knot pusher with slot, for extra corporeal, WL 330mm*



	Ø 4,5mm
Knot pusher with slot	140557J



## *Cleaning brushes / Tubing connector - Luer connector*



L	Ø 2,5mm	Ø7,0mm	Ø11,0mm
380mm	140601F	140603Y	140605Z
500mm	140602F	140604Y	140606Z

### *Tubing connectors and Luer connectors, small*



Tubing connector	Tubing connector	Luer Connector	Luer Connector
1252	1253	1254	1255

### *Tubing connectors and Luer connectors, big*



Luer Connector	Luer Connector	Luer Connector	Luer Connector
1256	1257	1258	1259

# Laparoscopy

## Forceps Handles



Description	Ordering n°
<i>Ergonomic Laparoscopic plastic-handle, rotatable, with HF-connection, without Ratchet</i>	15004



Description	Ordering n°
<i>Laparoscopic plastic-handle, rotatable, with HF-connection, with Ratchet</i>	15002



Description	Ordering n°
<i>Laparoscopic insulated sheath, WL 330mm.</i>	15006
<i>Laparoscopic insulated sheath, WL 420mm</i>	15006L

# Laparoscopy

Ø 5,0 mm, 330mm/420mm  
360° Rotatable and detachable

## Dissecting and Grasping Forceps

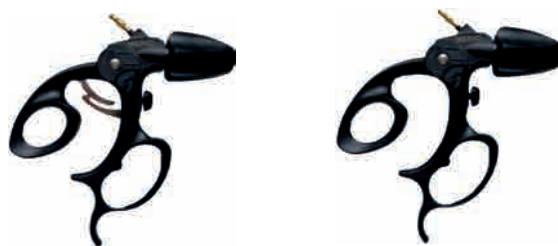

WL	Insert only	Complete	Complete
330mm 420mm 	15007PI 15007PIL	15007P2 15007P2L	15007P4 15007P4L
MARYLAND, curved, double action			
330mm 420mm 	15008PI 15008PIL	15008P2 15008P2L	15008P4 15008P4L
MARYLAND, long, slightly curved, double action			
330mm 420mm 	15009PI 15009PIL	15009P2 15009P2L	15009P4 15009P4L
MARYLAND, Ø3,5mm jaws, curved, double action			
330mm 420mm 	15011PI 15011PIL	15011P2 15011P2L	15011P4 15011P4L
MIXTER, double action			
330mm 420mm 	15012PI 15012PIL	15012P2 15012P2L	15012P4 15012P4L
MIXTER, cross serrated, Ø4,0mm jaws, double action			
330mm 420mm 	15013PI 15013PIL	15013P2 15013P3L	15013P4 15013P4L
MIXTER, Ø3,5mm jaws, double action			
330mm 420mm 	15014PI 15014PIL	15014P2 15014P2L	15014P4 15014P4L
OVERHOLT, cross serrated, double action			
330mm 420mm 	15015PI 15015PIL	15015P2 15015P2L	15015P4 15015P4L
OVERHOLT, diagonal serrated, double action			

# Laparoscopy

## Dissecting and Grasping Forceps

Ø 5,0 mm, 330mm/420mm  
360° Rotatable and detachable

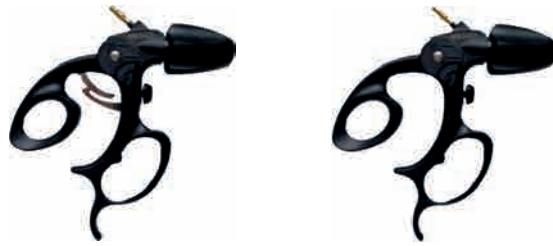

WL	Complete	Complete	Insert only
330mm 420mm	15016P2 15016P2L	15016P4 15016P4L	15016PI 15016PIL
	Grasping forceps, straight, serrated, double action		
330mm 420mm	15017P2 15017P2L	15017P4 15017P4L	15017PI 15017PIL
	DOLPHIN, straight, double action		
330mm 420mm	15018P2 15018P2L	15018P4 15018P4L	15018PI 15018PIL
	DOLPHIN, curved, double action		
330mm 420mm	15020P2 15020P2L	15020P4 15020P4L	15020PI 15020PIL
	DOLPHIN, long beak with spoon, double action		
330mm 420mm	15021P2 15021P2L	15021P4 15021P4L	15021PI 15021PIL
	DOLPHIN, short beak with spoon, double action		
330mm 420mm	15022P2 15022P2L	15022P4 15022P4L	15022PI 15022PIL
	Grasping forceps, conical, atraumatic, single action		
330mm 420mm	15023P2 15023P2L	15023P4 15023P4L	15023PI 15023PIL
	Grasping forceps, conical, atraumatic, double action		
330mm 420mm	15024P2 15024P2L	15024P4 15024P4L	15024PI 15021PIL
	DOLPHIN, atraumatic, double action		

# Laparoscopy

Ø 5,0 mm, 330mm/420mm  
360° Rotatable and detachable

## Dissecting and Grasping Forceps

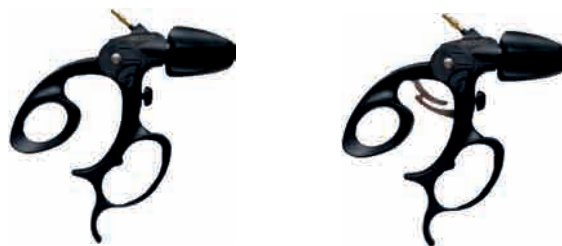







WL	Insert only	complete	complete
330mm 420mm	15025PI 15025PIL	15025P4 15025P4L	15025P2 15025P2L
	KELLY, atraumatic, curved, double action		
330mm 420mm	15026PI 15026PIL	15026P4 15026P4L	15026P2 15026P2L
	KELLY, slightly curved, single action		
330mm 420mm	15028PI 15028PIL	15028P4 15028P4L	15028P2 15028P2L
	Grasping forceps, cross serrated, 3,5mm jaws, double action		
330mm 420mm	15029PI 15029PIL	15029P4 15029P4L	15029P2 15029P2L
	Grasping forceps, curved 90°, double action		
330mm 420mm	15030PI 15030PIL	15030P4 15030P4L	15030P2 15030P2L
	Grasping forceps, strong curved, double action		
330mm 420mm	15031PI 15031PIL	15031P4 15031P4L	15031P2 15031P2L
	Grasping forceps, strong curved, single action		
330mm 420mm	15032PI 15032PIL	15032P4 15032P4L	15032P2 15032P2L
	Grasping forceps, slim, strong curved, single action		
330mm 420mm	15033PI 15033PIL	15033P4 15033P4L	15033P2 15033P2L
	Suture grasping forceps, double action		

# Laparoscopy

## Dissecting and Grasping Forceps

Ø 5,0 mm, 330mm/420mm  
360° Rotatable and detachable



WL	Complete	Complete	Insert only
330mm 420mm	15034P2 15034P2L	15034P4 15034P4L	15034PI 15034PIL
	REDDICK-OLSEN, 3,5mm jaws, double action		
330mm 420mm	15035P2 15035P2L	15035P4 15035P4L	15035PI 15035PIL
	REDDICK-OLSEN, short, double action		
330mm 420mm	15036P2 15036P2L	15036P4 15036P4L	15036PI 15036PIL
	REDDICK-OLSEN, long, double action		
330mm 420mm	15037P2 15037P2L	15037P4 15037P4L	15037PI 15037PIL
	COOLEY, 3,5 mm jaws, double action,		
330mm 420mm	15038P2 15038P2L	15038P4 15038P4L	15038PI 15038PIL
	BULL NOSE, fine serrated, double action		
330mm 420mm	15042P2 15042P2L	15042P4 15042P4L	15042PI 15042PIL
	Resano, with blood groove, single action		
330mm 420mm	15043P2 15043P2L	15043P4 15043P4L	15043PI 15043PIL
	Resano, with blood groove, long, double action		
330mm 420mm	15044P2 15044P2L	15044P4 15044P4L	15044PI 15044PIL
	Resano, with blood groove, short, double action		

# Laparoscopy

Ø 5,0 mm, 330mm/420mm  
360° Rotatable and detachable

## Dissecting and Grasping Forceps

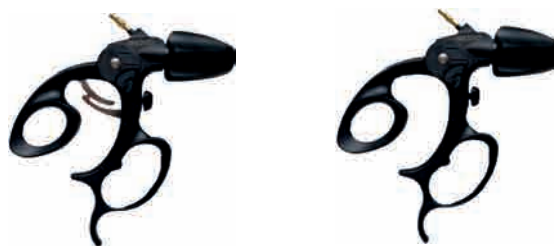



W L	Insert only	Complete	Complete
330mm 420mm	15045PI 15045PIL	15045P2 15045P2L	15045P4 15045P4L
	Grasping forceps, 1x2 teeth, single action		
330mm 420mm	15046PI 15046PIL	15046P2 15046P2L	15046P4 15046P4L
	Grasping forceps, 1x2 teeth, double action		
330mm 420mm	15047PI 15047PIL	15047P2 15047P2L	15047P4 15047P4L
	COBRA, 2x4 teeth, single action		
330mm 420mm	15048PI 15048PIL	15048P2 15048P2L	15048P4 15048P4L
	COBRA, 2x4 teeth, double action		
330mm 420mm	15050PI 15050PIL	15050P2 15050P2L	15050P4 15050P4L
	Grasping forceps, 3x3 teeth, double action		
330mm 420mm	15051PI 15051PIL	15051P2 15051P2L	15051P4 15051P4L
	ALLIS grasping forceps, double action		
330mm 420mm	15053PI 15053PIL	15053P2 15053P2L	15053P4 15053P4L
	ALLIS grasping forceps, heavy, single action		
330mm 420mm	15054PI 15054PIL	15054P2 15054P2L	15054P3 15054P3L
	LONG ALLIS, with diagonal groove, double action		

# Laparoscopy

## Dissecting and Grasping Forceps

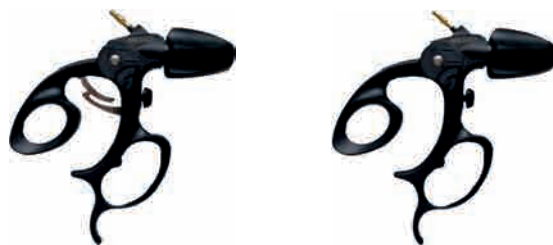
Ø 5,0 mm, 330mm/420mm  
360° Rotatable and detachable



WL	Complete	Complete	Insert only
330mm 420mm	15055P2 15055P2L	15055P4 15055P4L	15055PI 15055PIL
	DE BAKEY grasping forceps, 2x1 teeth, double action		
330mm 420mm	15056P2 15056P2L	15056P4 15056P4L	15056PI 15056PIL
	Grasping forceps, long, atraumatic, double action		
330mm 420mm	15057P2 15057P2L	15057P4 15057P4L	15057PI 15057PIL
	Grasping forceps, atraumatic, cross serrated, double action		
330mm 420mm	15058P2 15058P2L	15058P4 15058P4L	15058PI 15058PIL
	Grasping forceps, smooth, double action		
330mm 420mm	15059P2 15059P2L	15059P4 15059P4L	15059PI 15059PIL
	Grasping forceps, smooth, blunt, double action		
330mm 420mm	15060P2 15060P2L	15060P4 15060P4L	15060PI 15060PIL
	Grasping forceps, serrated, grooved, single action		
330mm 420mm	15061P2 15061P2L	15061P4 15061P4L	15061PI 15061PIL
	Grasping forceps, arched, jaws 3,5mm, double action		



# Laparoscopy

Ø 5,0 mm, 330mm/420mm  
360° Rotatable and detachable

## Dissecting and Grasping Forceps

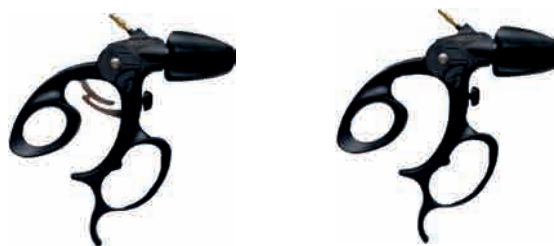

WL	Insert only	Complete	Complete
330mm 420mm	15064PI 15064PIL	15064P2 15064P2L	15064P4 15064P4L
	Grasping forceps, atraumatic, double action		
330mm 420mm	15065PI 15065PIL	15065P2 15065P2L	15065P4 15065P4L
	DE BAKEY forceps, 1x2 teeth, short, double action		
330mm 420mm	15066PI 15066PIL	15066P2 15066P2L	15066P4 15066P4L
	DE BAKEY, 1x2 teeth, curved up, double action		
330mm 420mm	15067PI 15067PIL	15067P2 15067P2L	15067P4 15067P4L
	DE BAKEY, 1x2 teeth, L=24mm, double action		
330mm 420mm	15068PI 15068PIL	15068P2 15068P2L	15068P4 15068P4L
	DE BAKEY, 1x2 teeth, 3,5mm jaws, double action		
330mm 420mm	15069PI 15069PIL	15069P3 15069P3L	15069P4 15069P4L
	DE BAKEY MARYLAND, 1x2 teeth, long, double action		
330mm 420mm	15070PI 15070PIL	15070P2 15070P2L	15070P4 15070P4L
	DE BAKEY, 3x2 teeth, L=40mm, double action		
330mm 420mm	15071PI 15071PIL	15071P2 15071P2L	15071P4 15071P4L
	Grasping forceps, fenestrated, Ø3,5mm jaws, double action		

# Laparoscopy

## Dissecting and Grasping Forceps

Ø 5,0 mm, 330mm/420mm  
360° Rotatable and detachable

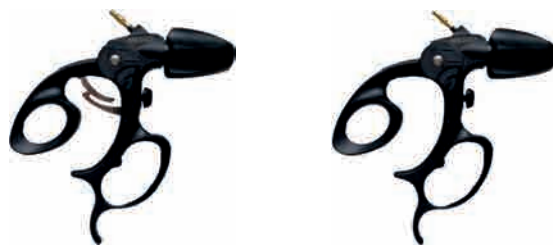

WL	Complete	Complete	Insert only
330mm 420mm	15073P2 15073P2L	15073P4 15073P4L	15073PI 15073PIL
Fenestrated grasping forceps JOHAN, short, double action			
330mm 420mm	15074P2 15074P2L	15074P4 15074P4L	15074PI 15074PIL
Fenestrated grasping forceps, JOHAN, double action			
330mm 420mm	15075P2 15075P2L	15075P4 15075P4L	15075PI 15075PIL
Fenestrated grasping forceps, JOHAN, 16mm jaws, single action			
330mm 420mm	15076P2 15076P2L	15076P4 15076P4L	15076PI 15076PIL
Fenestrated grasping forceps, JOHAN, Ø25mm jaws, double action			
330mm 420mm	15077P2 15077P2L	15077P4 15077P4L	15077PI 15077PIL
Fenestrated grasping forceps, JOHAN, 39mm jaws, double action			
330mm 420mm	15078P2 15078P2L	15078P4 15078P4L	15078PI 15078PIL
Fenestrated grasping forceps, JOHAN, 25mm jaws, single action			
330mm 420mm	15079P2 15079P2L	15079P4 15079P4L	15079PI 15079PIL
Fenestrated grasping forceps, JOHAN, 39mm jaws, single action			
330mm 420mm	15121P2 15121P2L	15121P4 15121P4L	15121PI 15121PIL
Croce Olmi grasping forceps, double action			

# Laparoscopy

Ø 5,0 mm, 330mm/420mm  
360° Rotatable and detachable

## Dissecting and Grasping Forceps

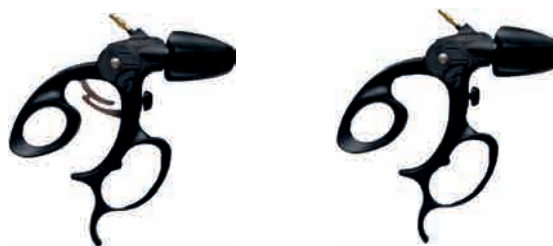

WL	Insert only	Complete	Complete
330mm 420mm	15081PI 15081PIL	15081P2 15081P2L	15081P4 15081P4L
	BABCOCK grasping forceps, fenestrated, single action		
330mm 420mm	15082PI 15082PIL	15082P2 15082P2L	15082P4 15082P4L
	BABCOCK DE BAKEY grasping forceps, double action		
330mm 420mm	15083PI 15083PIL	15083P2 15083P2L	15083P4 15083P4L
	BABCOCK, cross grooved serrated, double action		
330mm 420mm	15084PI 15084PIL	15084P2 15084P2L	15084P4 15084P4L
	Grasping forceps with notch, double action		
330mm 420mm	15085PI 15085PIL	15085P2 15085P2L	15085P4 15085P4L
	ENDOCLINCH grasping forceps, double action		
330mm 420mm	15086PI 15086PIL	15086P2 15086P2L	15086P4 15086P4L
	MC KEARNAN, 21mm LONG, fenestrated, double action		
330mm 420mm	15087PI 15087PIL	15087P2 15087P2L	15087P4 15087P4L
	MC KEARNAN, fenestrated, double action		
330mm 420mm	15088PI 15088PIL	15088P2 15088P2L	15088P4 15088P4L
	BABCOCK grasping forceps, double action		

# Laparoscopy

## Dissecting and Grasping Forceps

Ø 5,0 mm, 330mm/420mm  
360° Rotatable and detachable

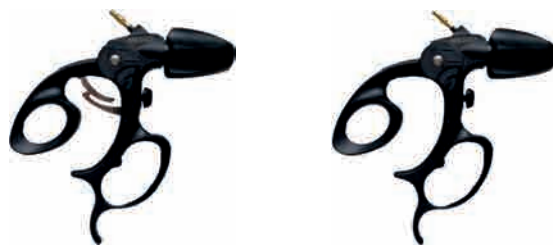

WL	Complete	Complete	Insert only
330mm 420mm	15089P2 15089P2L	15089P4 15089P4L	15089PI 15089PIL
	ENDOCLINCH grasping forceps, 3,5mm jaws, double action		
330mm 420mm	15090P2 15090P2L	15090P4 15090P4L	15090PI 15090PIL
	RIPPLE BULLNOSE grasping forceps, single action		
330mm 420mm	15091P2 15091P2L	15091P4 15091P4L	15091PI 15091PIL
	RIPPLE BULLNOSE grasping forceps, double action		
420mm	15092P2 15092P2L	15092P4 15092P4L	15092PI 15092PIL
	Grasping forceps, short jaws with cup, smooth, double action		
330mm 420mm	15093P2 15093P2L	15093P4 15093P4L	15093PI 15093PIL
	Grasping forceps, short jaws with cup, serrated, double action		
330mm 420mm	15094P2 15094P2L	15094P4 15094P4L	15094PI 15094PIL
	Grasping forceps, long jaws with cup, serrated, double action		
330mm 420mm	15095P2 15095P2L	15095P4 15095P4L	15095PI 15095PIL
	Grasping forceps conical, jaws with cup, serrated, double action		
330mm 420mm	15096P2 15096P2L	15096P4 15096P4L	15096PI 15096PIL
	Retrograde grasping forceps, long, double action		

# Laparoscopy

Ø 5,0 mm, 330mm/420mm  
360° Rotatable and detachable

## Biopsy and Grasping Forceps

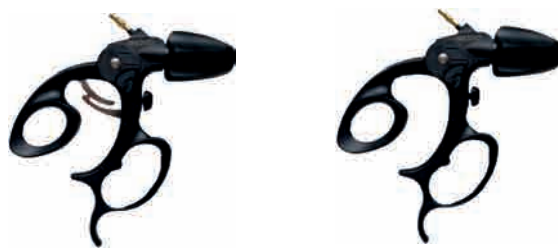

WL	Insert only	Complete	Complete
 330mm 420mm	15097PI 15097PIL	15097P2 15097P2L	15097P4 15097P4L
Retrograde Grasping forceps, double action			
 330mm 420mm	15098PI 15098PIL	15098P2 15098P2L	15098P4 15098P4L
Retrograde Grasping forceps, spooned, double action			
 330mm	15100PI 15100PIL	15100P2 15100P2L	15100P4 15100P4L
Biopsy forceps, L10mm, double action			
 330mm 420mm	15101PI 15101PIL	15101P2 15101P2L	15101P4 15101P4L
Biopsy forceps, L15mm, single action			
 330mm 420mm	15102PI 15102PIL	15102P2 15102P2L	15102P4 15102P5L
Biopsy forceps, L11mm, single action			
 330mm 420mm	15103PI 15103PIL	15103P2 15103P2L	15103P4 15103P4L
Biopsy forceps, L 8mm, single action			
 330mm 420mm	15104PI 15104PIL	15104P2 15104P2L	15104P4 15104P4L
Biopsy forceps, 45° angled, single action			
 330mm 420mm	15105PI 15105PIL	15105P2 15105P2L	15105P4 15105P4L
Biopsy forceps with pins, L 7,2mm, double action			

# Laparoscopy

## Biopsy and Grasping Forceps

Ø 5,0 mm, 330mm/420mm  
360° Rotatable and detachable

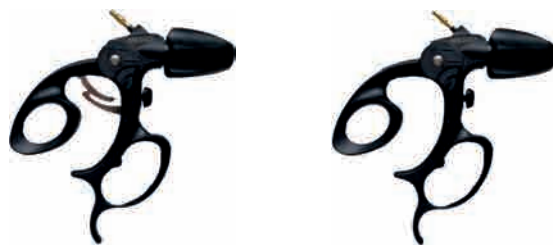

WL	complete	complete	Insert type
330mm 420mm	15106P2 15106P2L	15106P4 15106P4L	15106PI 15106PIL
	Biopsy forceps with pins, L 8mm, double action		
330mm 420mm	15107P2 15107P2L	15107P4 15107P4L	15107PI 15107PIL
	Biopsy forceps with pins, L 10,2mm, double action		
330mm 420mm	15108P2 15108P2L	15108P4 15108P4L	15108PI 15108PIL
	Biopsy forceps with pins, L 8mm, single action		
330mm	15109P2 15109P2L	15109P4 15109P4L	15109PI 15109PIL
	Biopsy forceps with pins, L 11mm, single action		
330mm 420mm	15110P2 15110P2L	15110P4 15110P4L	15110PI 15110PIL
	Biopsy forceps with pins, L 15mm, single action		
330mm 420mm	15111P2 15111P2L	15111P4 15111P4L	15111PI 15111PIL
	WEIL BLAKESLY, Biopsy forceps, single action		
330mm 420mm	15112P2 15112P2L	15112P4 15112P4L	15112PI 15112PIL
	Claw grasper, 2x3 teeth, single action		
330mm 420mm	15113P2 15113P2L	15113P4 15113P4L	15113PI 15113PIL
	Ripple claw grasper, 2x3 teeth, double action		

# Laparoscopy

Ø 5,0 mm, 330mm/420mm  
360° Rotatable and detachable

## Biopsy and Grasping Forceps

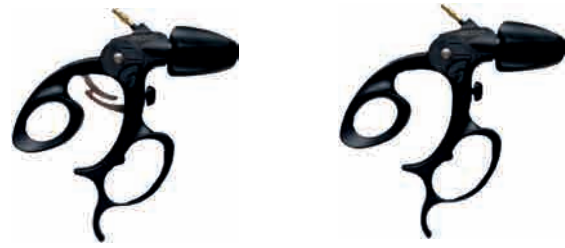

WL	Insert type	complete	complete
330mm 420mm	15114PI 15114PIL	15114P2 15114P2L	15114P4 15114P4L
	Ripple claw grasper, 2x3 teeth, single action		
330mm 420mm	15115PI 15115PIL	15115P2 15115P2L	15115P4 15115P4L
	TENACULUM Grasping forceps, 25mm jaws, double action		
330mm 420mm	15116PI 15116PIL	15116P2 15116P2L	15116P4 15116P4L
	Uterine-manipulator, double action		
330mm 420mm	15117PI 15117PIL	15117P2 15117P2L	15117P4 15117P4L
	NONIUS		
330mm 420mm	15118PI 15118PIL	15118P2 15118P2L	15118P4 15118P4L
	Thread catcher, single action		
330mm 420mm	15119PI 15119PIL	15119P2 15119P2L	15119P4 15119P4L
	Basket forceps		
330mm 420mm	15120PI 15120PIL	15120P2 15120P2L	15120P4 15120P4L
	Biopsy punch, rounded jaws, single action		

# Laparoscopy

## Scissors

Ø 5,0 mm, 330mm/420mm  
360° Rotatable and detachable

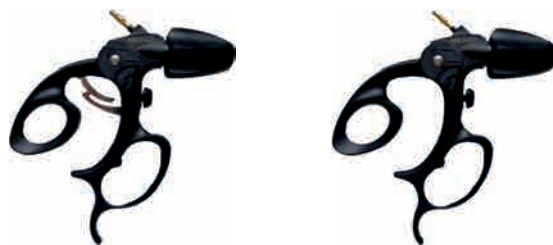

WL	Complete	Complete	Insert only
330mm 420mm	13001P2 13001P2L	13001P4 13001P4L	13001PI 13001PIL
	Peritoneal scissors, straight, serrated, single action		
330mm 420mm	13002P2 13001P2L	13002P4 13002P4L	13002PI 13002PIL
	METZENBAUM scissors, straight, double action		
330mm 420mm	13003P2 13003P2L	13003P4 13003P4L	13003PI 13003PIL
	METZENBAUM scissors, curved, double action		
330mm 420mm	13004P2 13004P2L	13004P4 13004P4L	13004PI 13004PIL
	Mini METZENBAUM scissors, short, straight, double action		
330mm 420mm	13005P2 13005P2L	13005P4 13005P4L	13005PI 13005PIL
	Mini METZENBAUM scissors, short, curved, double action		
330mm 420mm	13006P2 13006P2L	13006P4 13006P4L	13006PI 13006PIL
	Scissors, small, straight MULTICUT, double action		
330mm 420mm	13007P2 13007P2L	13007P4 13007P4L	13007PI 13007PIL
	Scissors, small, curved, MULTICUT, double action		



# Laparoscopy

## Scissors

Ø 5,0 mm, 330mm/420mm  
360° Rotatable and detachable





WL	Insert type	Complete	Complete
330mm 420mm	13010PI 13010PIL	13010P2 13010P2L	13010P4 13010P4L
	Scissors, straight, Ø4,5 mm jaws, single action		
330mm 420mm	13011PI 13011PIL	13011P2 13011P2L	13011P4 13011P4L
	Scissors, straight, single action		
330mm 420mm	13012PI 13012PIL	13012P2 13012P2L	13012P4 13012P4L
	Scissors, straight, double action		
330mm 420mm	13014PI 13014PIL	13014P2 13014P2L	13014P4 13014P4L
	Scissors, straight, double action		
330mm 420mm	13009PI 13009PIL	13009P2 13009P2L	13009P4 13009P4L
	Micro dissecting scissors, curved, Ø3,5mm jaws, single action		
330mm 420mm	13008PI 13008PIL	13008P2 13008P2L	13008P4 13008P4L
	Micro dissecting scissors, straight, Ø3,5mm jaws, single action		

# Laparoscopy

## Scissors

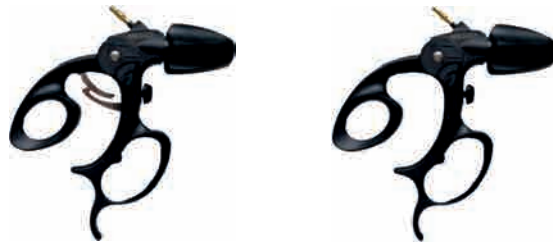
Ø 10,00 mm, 330mm/420mm  
360° Rotatable and detachable



WL	Complete	Complete	Insert only
330mm 420mm	13015U2 13015U2L	13015U4 13015U4L	13015UI 13015UIL
Scissors, curved, double action			

330mm 420mm	13016U2 13016U2L	13016U4 13016U4L	13016UI 13016UIL
Scissors, strong curved, double action			

330mm 420mm	13017U2 13017U2L	13017U4 13017U4L	13017UI 13017UIL
Hook scissors, short, 6mm, single action			

330mm 420mm	13013U2 13013U2L	13013U4 13013U4L	13013UI 13013UIL
Hook scissors, long, 7mm single action			



15006U Insulated sheath, Ø10mm, 330mm  
15006UL Insulated sheath, Ø10mm, 420mm

Ø 10,0 mm, 330mm/420mm  
360° Rotatable and detachable

# Laparoscopy

## Grasping Forceps







WL	Insert only	complete	complete
330mm 420mm	15121UI 15121UIL	15121U2 15121U2L	15121U4 15121U4L
	MARYLAND, curved, double action		
330mm 420mm	15122UI 15122UIL	15122U2 15122U2L	15122U4 15122U4L
	Claw grasper, 2x3 teeth, single action		
330mm 420mm	15123UI 15123UIL	15123U2 15123U2L	15123U4 15123U4L
	Myoma Claw grasper, 2x3 teeth, single action		
330mm 420mm	15124UI 15124UIL	15124U2 15124U2L	15124U4 15124U4L
	Retrograde Grasping forceps, double action		
330mm 420mm	15125UI 15125UIL	15125U2 15125U2L	15125U4 15125U4L
	PENNINGTON, double action		
330mm 420mm	15126UI 15126UIL	15126U2 15126U2L	15126U4 15126U4L
	DORSEY, L 30mm jaws, double action		
330mm 420mm	15127UI 15127UIL	15127U2 15127U2L	15127U4 15127U4L
	DORSEY, L 40 mm jaws, double action		
330mm 420mm	15128UI 15128UIL	15128U2 15128U2L	15128U4 15128U4L
	DORSEY, L 50 mm jaws, double action		

# Laparoscopy

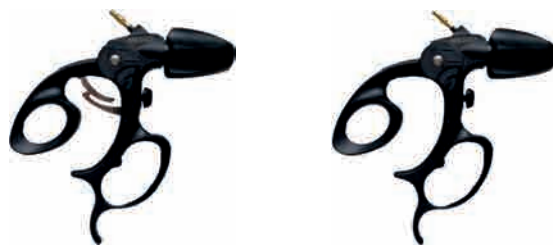
## Grasping Forceps

Ø 10,00 mm, 330mm/420mm  
360° Rotatable and detachable



WL	Complete	Complete	Insert only
330mm 420mm	15129U2 15129U2L DORSEY, L 60 mm jaws, double action	15129U4 15129U4L	15129UI 15129UIL 
330mm 420mm	15130U2 15130U2L DE BAKEY - ALLIS, double action	15130U4 15130U4L	15130UI 15130UIL 
330mm 420mm	15131U2 15131U2L DE BAKEY, L 30 mm jaws, double action	15131U4 15131U4L	15131UI 15131UIL 
330mm 420mm	15132U2 15132U2L DE BAKEY, L 40 mm jaws, double action	15132U4 15132U4L	15132UI 15132UIL 
330mm 420mm	15133U2 15133U2L DE BAKEY, L 50 mm jaws, double action	15133U4 15133U4L	15133UI 15133UIL 
330mm 420mm	15134U2 15134U2L DE BAKEY, L 60 mm jaws, double action	15134U4 15134U4L	15134UI 15134UIL 
330mm 420mm	15136U2 15136U2L MARYLAND, double action	15136U4 15136U4L	15136UI 15136UIL 
330mm 420mm	15139U2 15139U2L PENNINGTON-ALLIGATOR, double action	15139U4 15139U4L	15139UI 15139UIL 

Ø 10,0 mm, 330mm/420mm  
360° Rotatable and detachable

# Laparoscopy

## Grasping Forceps

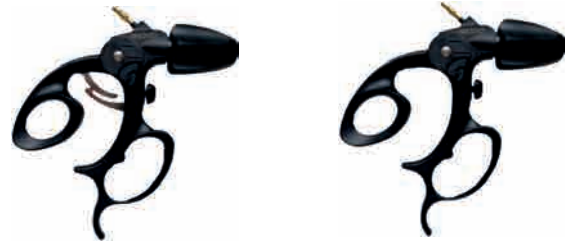



WL	Insert only	Complete	Complete
330mm 420mm 	15140UI 15140UIL	15140U2 15140U2L	15140U4 15140U4L
PENNINGTON-ALLIS (DUVAL) , double action			
330mm 420mm 	15142UI 15142UIL	15142U2 15142U2L	15142U4 15142U4L
ALLIGATOR GRASPING, jaws with spoon, single action			
330mm 420mm 	15143UI 15143UIL	15143U2 15143U2L	15143U4 15143U4L
MIXTER, double action			
330mm 420mm 	15144UI 15144UIL	15144U2 15144U2L	15144U4 15144U4L
ALLIS, double action			
330mm 420mm 	15145UI 15145UIL	15145U2 15145U2L	15145U4 15145U4L
Dissecting and grasping forceps long and curved, double action			
330mm 420mm 	15151UI 15151UIL	15151U2 15151U2L	15151U4 15151U4L
BABCOCK-DE BAKEY, double action			
330mm 420mm 	15154UI 15154UIL	15154U2 15154U2L	15154U4 15154U4L
Fenestrated, round, grooved and short, double action			
330mm 420mm 	15155UI 15155UIL	15155U2 15155U2L	15155U4 15155U4L
Fenestrated, oval, double action			

# Laparoscopy

## Biopsy Forceps / Scissors

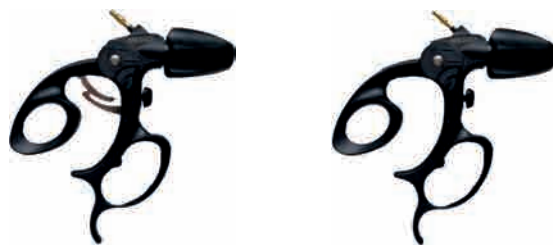

Ø 10,00 mm, 330mm/420mm  
360° Rotatable and detachable



WL	complete	complete	Insert type
330mm 420mm	15165U2 15165U2L	15165U4 15165U4L	15165UI 15165UIL
Spoon forceps, Ø25mm jaws, single action			
330mm 420mm	15138U2 15138U2L	15138U4 15138U4L	15138UI 15138UIL
Spoon forceps, Ø19mm jaws, single action			
330mm 420mm	15137U2 15137U2L	15137U4 15137U4L	15137UI 15137UIL
Scissors, straight, serrated, single action			
330mm 420mm	15135U2 15135U2L	15135U4 15135U4L	15135UI 15135UIL
Scissors, curved, serrated, single action			

## Biopsy Forceps

Ø 3,0 mm, 210mm/330mm  
360° Rotatable and detachable







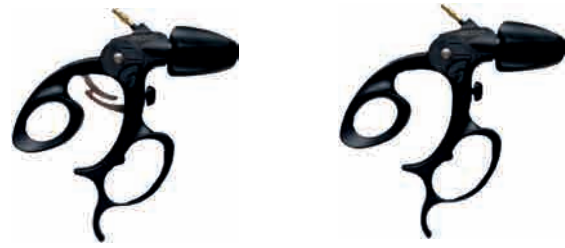

WL	complete	complete	Insert - Tube
210mm 330mm	15016M2 15016M2L	15016M4 15016M4L	15016MI 15016MIL
Grasping forceps, straight, serrated, double action			
230mm 330mm	15038M2 15038M2L	15038M4 15038M4L	15038MI 15038MIL
BULL NOSE, fine serrated, double action			
230mm 330mm	15083M2 15083M2L	15083M4 15083M4L	15083MI 15083MIL
BABCOCK, cross grooved serrated, double action			

# Laparoscopy

Ø 3,0 mm, 210mm/330mm  
360° Rotatable and detachable

## Dissecting and Grasping Forceps



WL	Insert + Tube	complete	complete
210mm 330mm	15190MI 15190MIL	15190M2 15190M2L	15190M4 15190M4L
	Claw Grasping forceps, 2x3 teeth, 10mm, single action		
210mm 330mm	15191MI 15191MIL	15191M2 15191M2L	15191M4 15191M4L
	Grasping forceps, Jaws with spoon, serrated, 11mm, single action		
230mm 330mm	15183MI 15183MIL	15183M2 15183M2L	15183M4 15183M4L
	Grasping Forceps, short, 8mm jaws, single action		
230mm 330mm	15107MI 15107MIL	15107M2 15107M2L	15107M4 15107M4L
	MARYLAND, curved, double action		
230mm 330mm	15193MI 15193MIL	15193M2 15193M2L	15193M4 15193M4L
	Dissecting and grasping forceps, double action		
230mm 330mm	15192MI 15192MIL	15192M2 15192M2L	15192M4 15192M4L
	Biopsy forceps, with pins, double action		
230mm 330mm	15194MI 15194MIL	15194M2 15194M2L	15194M4 15194M4L
	Fenestrated, grasping forceps, double action		
230mm 330mm	15195MI 15195MIL	15195M2 15195M2L	15195M4 15195M4L
	Fenestrated, grasping forceps, single action		
230mm 330mm	15196MI 15196MIL	15196M2 15196M2L	15196M4 15196M4L
	METZENBAUM, Scissors, double action		

# Laparoscopy

## TC Needleholders







Ø 5,00 mm, 330mm/420mm  
360° Rotatable and detachable



Ergonomic Steel Handle



Ergonomic Plastic Handle

Insert type	WL330mm	WL420mm		WL330mm	WL420mm
	18002M1	18002M1L	With stainless Type insert, straight	18002M2	18002M2L
	18003M1	18003M1L	With stainless Type insert, right curved	18003M2	18003M2L
	18004M1	18004M1L	With stainless Type insert, left curved	18004M2	18004M2L
	18001M1	18001M1L	<b>SERRATED</b>	18001M2	18001M2L
	18005M1	18005M1L	<b>PSITTACTUS</b>	18005M2	18005M2
	18006M1	18006M1L	<b>Self Riding Jaw 'self-adjust' needleholder, diamond jaw</b>	18006M2	18006M2

## Wound Closure

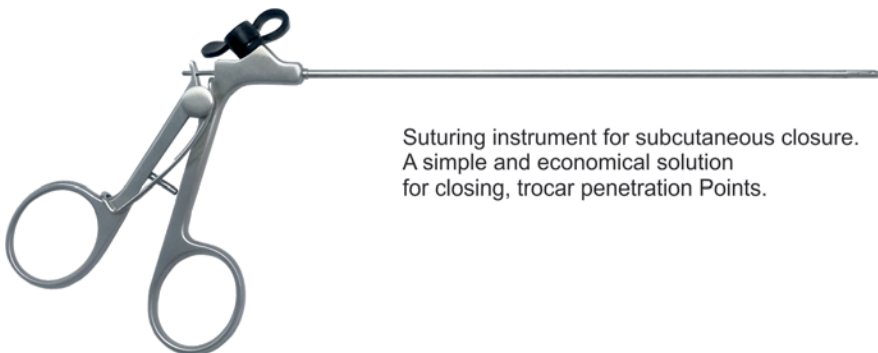

Suturing instrument for subcutaneous closure.  
A simple and economical solution  
for closing, trocar penetration Points.



complete

18027

"Wound closure" Forceps, Ø 3 mm, Working length 170 mm



# Laparoscopy

## TC Needleholders

Ø 5,0/3,0 mm, WL 330/210mm  
360° Rotatable and detachable

Only 180g







Anodized and Teflon coated Hig Tech Aluminium axial Handle with Luer-Lock irrigation connector



Axial Handle



Ergonomic Handle

Insert type	Ø 3 mm	Ø 5 mm	Ø 3 mm	Ø 5 mm	
	18011M1	18007M1	18011M2	18007M2	With stainless Type 1.4021 insert, straight
	18012M1	18008M1	18012M2	18008M2	With stainless Type 1.4021 insert, right curved
	18013M1	18009M1	18013M2	18009M2	With stainless Type 1.4021 insert, left curved
	18014M1	18010M1	18014M2	18010M2	Serrated, straight





# Laparoscopy

## Bipolar Coagulation Forceps with rotating handle

Ø 5,00 mm, 330mm/420mm  
360° Rotatable and detachable

With rotating handle for more comfort in all working process



	Insert type
DUCKBILL large grasping forceps, fenestrated	2403401 
Grasping forceps, fenestrated, curved	2403402 
MARYLAND dissector, curved	2403404 
METZENBAUM scissors, curved	2403403 
Sheath, Ø 5mm, WI340mm	2403400 
Handle, rotation lockable	2400001
Handle, unlockable	2400000

Bipolar cables at page 60

360° Rotatable and detachable

## Bipolar Coagulation Forceps / Scissors

- Quick exchange of electrodes insert in a few seconds
- Detachable in 3 parts for easy cleaning

360° Rotating



Ø 5,0mm, WL 330mm



Ø 3,0mm, WL 290mm

Insert type Ø 5,0mm		Insert type Ø 3,0mm
2393401	Large grasping forceps, fenestrated	2390006
2393406	MARYLAND dissector, curved	2390003
2393402	Delicate, serrated tips, curved	
2393404	Grasping forceps, fenestrated, curved	
2393403	DELTA grasper, fenestrated	2390004
2393405	Claw forceps	KELLY CLAMP
2393407	METZENBAUM scissors, curved	2390005
2393400	Sheath, Ø 5mm, WL340mm	2390002
2390000	Handle	2390001

Bipolar cables at page 60

# Laparoscopy

## Endo Retractors



*Ø5mm, 340mm, with irrigation device*

Description	Ordering n°
3 fingers Endo Retractor, Ø5mm, rigid, WL 340mm	1934032

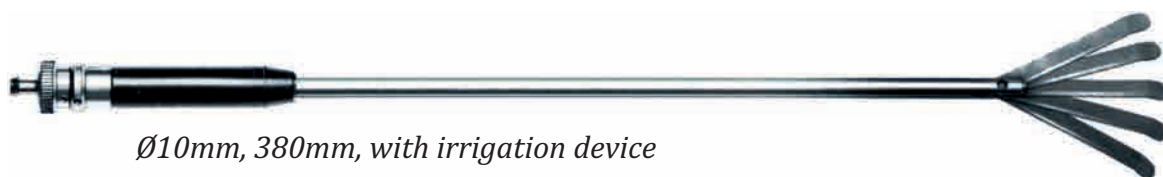

*Ø10mm, 380mm, with irrigation device*

Description	Ordering n°
5 fingers Endo Retractor, Ø10mm, rigid, WL 380mm	1938033



*Ø5mm, 340mm, with irrigation device*

Description	Ordering n°
3 fingers Endo Retractor, Ø5mm, angleable, WL 340mm	1934034



*Ø10mm, 380mm, with irrigation device*

Description	Ordering n°
5 fingers Endo Retractor, Ø10mm, angleable, WL 380mm	1938035

# Laparoscopy

## Endo Liver Retractors



*Offers superior strength and rounded edges causing minimum damage to the liver. Can be folded using outside knob.*

Description	Ordering n°
<i>Flexible Liver Retractor for Ø5mm trocar</i>	<b>1900036</b>



*Stand holder*

Description	Ordering n°
<i>Stand holder for Liver Retractor</i>	<b>1900037</b>
<i>Table clamp</i>	

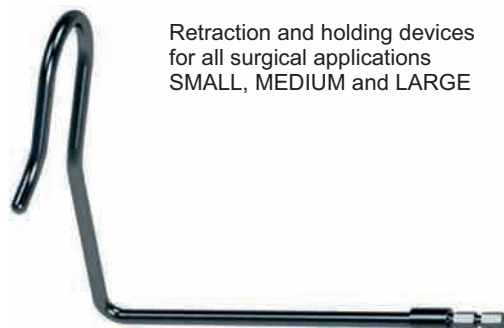

Retraction and holding devices for all surgical applications  
SMALL, MEDIUM and LARGE



Articulated arm with triple clamping, with Quick-connector, 360° rotatable

Description	Ordering n°
<i>Liver retractor SMALL, with Quick-connector</i>	<b>1900137</b>
<i>Liver retractor MEDIUM, with Quick-connector</i>	<b>1900237</b>
<i>Liver retractor LARGE, with Quick-connector</i>	<b>1900337</b>
<i>Insulated Scope holder with Quick-connector</i>	<b>1900437</b>
<i>Standard Instrument Connector with Quick-connector</i>	<b>1900537</b>
<i>Table clamp, heavy duty</i>	<b>1900637</b>
<i>Articulated arm with triple clamping, with Quick-connector, 360° rotatable</i>	<b>1900737</b>
<i>Articulated arm (2 arm design) with triple clamping, with double connection possibility and Quick-connector</i>	<b>1900837</b>

# Laparoscopy

## *Instruments for Gynecology*



Uterine Manipulator

The Uterine Manipulator was developed for the manipulation and presentation of the uterus during a complete laparoscopic hysterectomy, as well as protecting the bladder, ureter, and rectum during the electrosurgical resection of the uterus. The reusable instrument is fully modular and can fit all anatomical conditions as vaginal delineating tubes and intrauterine elements of various sizes are available. Once the instrument is in place the uterus can be moved in all directions, thus providing optimal exposure of all anterior, posterior and lateral aspects of the uterus.

The vaginal delineating tube, is slipped over the instrument shaft in a forward direction and thus allows the separation of the vagina whilst offering protection to the bladder, ureter and rectum. The electrosurgical resection can be easily and safely accomplished around the ceramic ring. The ceramic ring does not deteriorate when electrosurgical energy is applied and thus can be reused many times.

The vaginal delineating tube, is available in 3 different sizes to fit the specific anatomical conditions. The assembled instrument is comparatively light in weight and well balanced -this reduces effort during use.

With the tenaculum forceps tightly fixed to the cervix, the uterus can now easily be moved for presentation and preparation purposes.

The complete instrument set consists of several components which can be easily dismantled, cleaned, sterilized and reassembled. The high-grade materials are very durable and sterilization is trouble-free.

### Uterine Manipulator

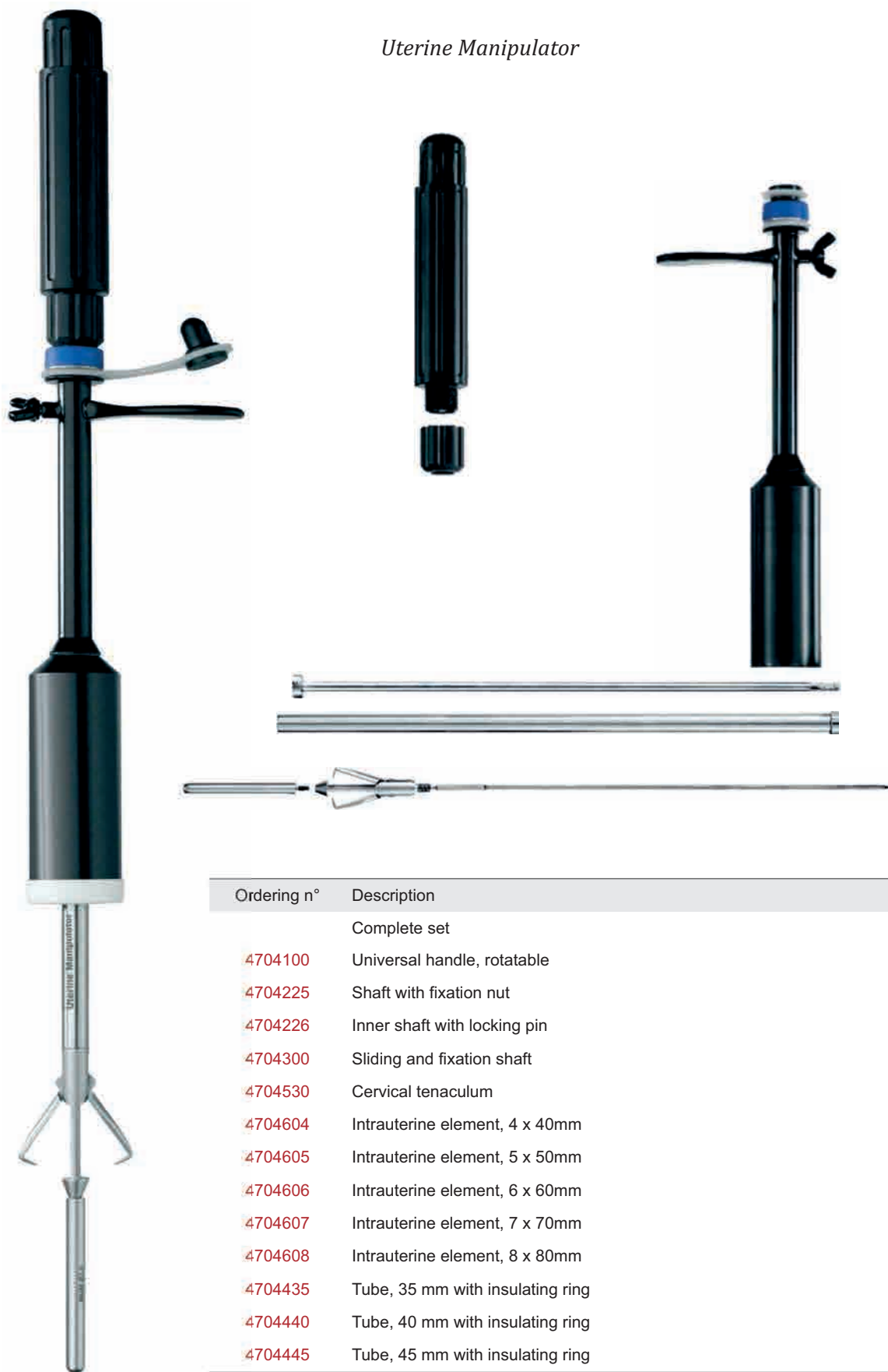

Ordering n°	Description
	Complete set
4704100	Universal handle, rotatable
4704225	Shaft with fixation nut
4704226	Inner shaft with locking pin
4704300	Sliding and fixation shaft
4704530	Cervical tenaculum
4704604	Intrauterine element, 4 x 40mm
4704605	Intrauterine element, 5 x 50mm
4704606	Intrauterine element, 6 x 60mm
4704607	Intrauterine element, 7 x 70mm
4704608	Intrauterine element, 8 x 80mm
4704435	Tube, 35 mm with insulating ring
4704440	Tube, 40 mm with insulating ring
4704445	Tube, 45 mm with insulating ring







# Laparoscopy

## Instruments for Gynecology



*Uterine Manipulator*

Ordering n°	Description
4704190	Uterine Manipulator complete with six Adapters

Ordering n°	Description	
4704090	Uterine Manipulator	
4704096	Ø 8 x 80 mm Adapter	
4704095	Ø 10 x 100 mm Adapter	
4704094	Ø 3 x 45 mm Adapter	
4704093	Ø 3 x 55 mm Adapter	
4704092	Adapter with short cone	
4704091	Adapter with long cone	



# Laparoscopy

## Instruments for Gynecology



Myoma Drill

Ordering n°	Description	Ø	WL
170-6401-330	Myoma Drill	5,0 mm	320 mm
170-6401-370	Myoma Drill	5,0 mm	370 mm



Cohen Intra Uterine Probe

Ordering n°	Description
4704199	Cohen Intrauterine probe complete
4704099	Cohen Cannula
4704098	Small Portio Adapter
4704097	Large Portio Adapter

# Laparoscopy

## Mono/Bipolar electrodes



*Monopolar Electrodes with Ceramic insulation*



	L - Hook	J - Hook	Spatula
Ø 5mm, 360mm with ceramic tip	2430013	2430015	2430017

*Monopolar HF-Electrodes, with HF - connector, Ø5mm*



	L - Hook	J - Hook	Spatula	Ballpoint	Needle
Ø 5mm, 340mm	141704P	141705P	141706P	141707P	141708P
Ø 5mm, 450mm	142704P	142705P	142706P	142707P	142708P





*SLIMLINE Bipolar Electrodes Ø3mm, WL 340mm*

		Ordering n°	
L-Hook		2423401	
V-Hook		2423402	
Needle electrode		2423403	

Bipolar cables at page 60

## Suction & Irrigation Handles / Electrodes

	Ordering n°	Adaptable Suction/Irrigation tube
	<p>140100HF</p>	<p>Pistol Handle with Sliding Valve for exchangeable electrodes, with rotatable adapter and sidewise HF-Connector, two combined Luer-Lock- /Tube connectors</p>
 <p><i>Monopolar HF-Electrodes with Suction/Irrigation channel</i></p>		

	L - Hook	J - Hook	Spatula	Ballpoint	Needle
<p>Ø 5mm, 340mm</p>	<p>140704P</p>	<p>140705P</p>	<p>140706P</p>	<p>140707P</p>	<p>140708P</p>

# Laparoscopy

## Connection cables

### Non-porous silver plated wires

Bipolar Cable		3m	5m		3m	5m
2-Banana		2373001	2375001	Martin, Berchtold, Aesculap GK 55- Gk60		2373003 2375003
Erbe		2373002	2375002	Valleylab		2373004 2375004
Adapter Medici/Martin		2370017		Medici / 4mm		2370019
Adapter Medici/Erbe		2370018				
Monopolar Cable		3m	5m		3m	5m
Erbe T-Serie, Martin, Berchtold		2373059	2375059	Martin, Berchtold		2373061 2375061
Erbe ACC/ICC		2373062	2375062	Valleylab Bovie Conmed		2373060 2375060
Monopolar adapter Medici / Ø 2-8mm		2370016				
<i>Cables for disposable neutral electrodes</i>						
Plug, generator side		4,5 m			4,5m	
Erbe, Integra KLS Martin,		2370012		Valleylab, Conmed Erbe		2370014
KLS MARTIN		2370013		Valleylab (NON REM) Conmed, Erbe		2370015

# Laparoscopy

## Cleaning instruments



Description	Ordering n°
Cleaning Pistol with 8 adapters	



### Cleaning brushes



L	Ø 2,5mm	Ø7,0mm	Ø11,0mm
380mm	140601F	140603Y	140605Z
500mm	140602F	140604Y	140606Z

# Laparoscopy



*Memo*



**ENDOMIED**

**ENDOMIED**