

AUTO REFRACTOMETER

RM/KR-9600 RM/KR-9800

OPERATOR'S MANUAL

CE₁₂₈₂



| | |
|--|----|
| 1. Introduction..... | 3 |
| 1.1 Product Features and Use Scope..... | 3 |
| 1.2 Classification..... | 3 |
| 1.3 Main performance index..... | 4 |
| 2. Safety precautions..... | 5 |
| 2.1 Safety identification..... | 5 |
| 2.2 Safety precautions before use..... | 5 |
| 2.3 Safety precautions during use..... | 7 |
| 2.4 Safety precautions after use..... | 7 |
| 2.5 Maintenance and check..... | 8 |
| 2.6 Disposal..... | 8 |
| 3. Configuration and Functions..... | 9 |
| 3.1 Device configuration..... | 9 |
| 3.2 Accessories..... | 10 |
| 3.3 Symbols..... | 11 |
| 3.4 Operation flow..... | 12 |
| 3.5 Set screen description..... | 14 |
| 4. Installation and measurement preparation..... | 20 |
| 5. Measurement..... | 21 |
| 5.1 Model eye measurement..... | 21 |
| 5.2 Patient measurement..... | 22 |
| 6. Self-diagnosis and maintenance..... | 23 |
| 6.1 Troubleshooting..... | 23 |
| 6.2 Printer Paper Replacement..... | 23 |
| 6.3 Cleaning and disinfection..... | 23 |
| 6.4 Replace fuse..... | 24 |
| 6.5 Instrument site change..... | 24 |
| 6.6 Preventive inspection and maintenance..... | 24 |
| 6.7 Scrap..... | 25 |
| 7. Outline dimension and other instructions..... | 25 |

| | |
|--|----|
| 7.1 Outline specification, Contraindication..... | 25 |
| 7.2 Service life..... | 25 |
| 7.3 Disclaimer..... | 25 |
| 8. After-sale service..... | 26 |
| 9. Main specifications..... | 26 |
| 10. EMC(Electromagnetic Compatibility) | 27 |

1. Introduction

The Auto-Refractometer (RM-9600, RM-9800)/ Auto ref-keratometer (KR-9600, KR-9800) is used to measure spherical, cylinder, axial, PD, corneal radius and corneal diopter (KR-9600, KR-9800) of the patient's eye.

1.1 Product Features and Use Scope

- a) The classification of equipment according to the type of shock proof: class I, external power supply equipment.
- b) The classification of equipment according to the degree of shock proof: B type.
- c) The classification of equipment according to the ability to prevent liquid entry: ordinary equipment.
- d) Application part of the equipment: chinrest, forehead rest.
- e) The type of device power: single phase, network power supply: 100-240V ~ 50/60Hz 50VA.
- f) Equipment belongs to non AP or APG type.
- g) The operation mode: continuous operation.
- h) Equipment belongs to impermanent installation equipment.

1.2 Classification

The model number is RM-9600/ KR-9600/ RM-9800/KR-9800.

The Auto Ref/keratometer is composed of the host, the base and the bracket (according to the appearance). The bracket material is ABS.

The Auto Ref/keratometer is composed of optical system, electronic system and software, mechanical system, shells (according to the functional system).

The main difference between the main models KR-9000 is the difference in shape. The principle and intended uses are the same.

The classification of appearance according to design serial number: KR/RM-9600 is same. KR/RM-9800 is same.

The classification of functional according to model number: KR-9600/9800 is same. RM--9600/9800 is same. (The Auto Ref/keratometer KR-9600 and KR-9800 can measure corneal curvature)

Transport and transport conditions:

Temperature:-40°C - +55°C

Humidity: ≤80%

Atmospheric pressure: 700hPa - 1060hPa (transport), 500hPa - 1060hPa (transport)

Working environment condition:

Temperature:10°C - 40°C

Humidity: ≤80%

Atmospheric pressure: 760hPa - 1060hPa

Power requirements:

Voltage: 100-240V~、50/60Hz

Input power: 50VA

1.3 Main performance index

1 Measurable range

Spherical power: -25.00 m^{-1} - $+22.00 \text{ m}^{-1}$ 。

Cylindrical power: -10.00 m^{-1} - $+10.00 \text{ m}^{-1}$ 。

Cylindrical axis: 0° - 180°

PD measurement: 10mm - 85mm

Corneal radius: 5mm - 10mm (KR series)

Corneal diopter: 67.50 m^{-1} - 33.75 m^{-1} (KR series)

2 Measurement increments (step)

Spherical power (step): $0.12 \text{ m}^{-1}/0.25 \text{ m}^{-1}$

Cylindrical power (step): $0.12 \text{ m}^{-1}/0.25 \text{ m}^{-1}$

Cylindrical axis (step): 1°

PD measurement (step): 1mm

Corneal radius (step): 0.01mm (KR series)

Corneal diopter (step): $0.12 \text{ m}^{-1}/0.25 \text{ m}^{-1}$ (KR series)

3 Tolerance

The tolerance of the Auto refractometer/ Auto ref-keratometer should meet the requirements of Table 1

Table 1 Tolerance

| | Measurable range | Tolerance |
|---------------------------|--|---------------------------|
| Spherical power | $-10 - +10 \text{ m}^{-1}$ | $\pm 0.25 \text{ m}^{-1}$ |
| | $<-10 \text{ or } >+10 \text{ m}^{-1}$ | $\pm 0.50 \text{ m}^{-1}$ |
| Cylindrical power | $-10 - +10 \text{ m}^{-1}$ | $\pm 0.25 \text{ m}^{-1}$ |
| Corneal refractive radius | $\leq 8.0 \text{ mm}$ | $\pm 0.02 \text{ mm}$ |
| | $> 8.0 \text{ mm}$ | $\pm 0.03 \text{ mm}$ |
| Corneal refractive power | $\leq 43 \text{ m}^{-1}$ | $\pm 0.13 \text{ m}^{-1}$ |
| | $> 43 \text{ m}^{-1}$ | $\pm 0.25 \text{ m}^{-1}$ |

The tolerance of cylindrical axis: $\leq \pm 5^\circ$

The tolerance of PD: $\leq \pm 1 \text{ mm}$

4 General technical requirements

a) The installation of the whole equipment should be firm and isn't obvious loosening. Chinrest should be able to smooth lifting. The rated load of chinrest is 2.5Kg. Shaking the joystick, the device should be flexible to move all around.

b) The surfaces of all optical components shall be clean, free of damage, and no other defects that affect light transmission or imaging.

- c) Display screen should be able to clear imaging.
 - d) Digital display complete, stable, no flicker and print legible. Measurement results should include left and right eye identification, spherical power and cylindrical power, +/-, axis and degree, etc.
 - e) Auto ref/keratometer has the function of printing test results.
 - f) Optical radiation shall comply with the applicable requirements of ISO15004-2.
- 5 Under the working conditions, the noise should not be greater than 55dB (A).
- 6 The surface temperature of the device is not more than 15°C.
- 7 Safety requirements shall comply with the requirements of GB9706.1.
- 8 The test environment shall be consistent with the requirements of the mechanical test environment II group in GB/T14710-1993.
- 9 The Device for external connection with Auto ref/keratometer shall comply with the requirements of GB9706.1.

2. Safety precautions

2.1 Safety identification

In this manual, signal words are used to designate the degree or level of safety alerting. The definitions are as follows.

| | |
|--|--|
|  CAUTION | CAUTION: Indicates a potentially hazardous situation which, if not avoided, may result in minor or moderate injury or property damage accident. |
|--|--|

Even situations indicated by **CAUTION** may result in serious injury under certain conditions. Safety precautions must be strictly followed at all times.

2.2 Safety precautions before use

| | |
|--|---|
|  CAUTION | <ul style="list-style-type: none"> ● The safety precautions and operating procedures must be thoroughly understood prior to operation of the device. Use of the device outside the scope of this manual may cause adverse events. ● Do not open shell and do not touch the interior of the device. This may cause electric shock or instrument failure. ● Install and use the device in an environment that meets the following conditions. <ul style="list-style-type: none"> Temperature: 10°C - 40°C Humidity: ≤80% Atmospheric pressure: 760hPa - 1060hPa A room with low dust and little light A location free from vibration and shock <p>--- If the device is not installed and used under the above conditions, the reliability of</p> |
|--|---|

measured results is impaired, and malfunction may result. In addition, there is a possibility of injury if the device receives shock and falls down.

- Avoid storage the device near water, poisonous gas or liquid. The device may be corrosion or failure.
- Avoid installing the device where it is exposed to direct air-conditioning flow. Changes in temperature may result in condensation inside the device or adversely affect measurements.
- Be sure to use a power outlet which meets the power specification requirements. If the voltage is too high or too low, the device will not perform properly, and fire may occur.
- To avoid the risk of electric shock, the equipment must be connected with the power supply in the case of the protection of grounding equipment. Electric shock or fire may occur if the device malfunction or electric leakage.
- Do not use socket overload. This May cause fire.
- Insert the power plug into the socket. Improper connections may cause a fire.
- Never use a power strip or extension cable to supply the device with power. This may cause failures and fire.
- Do not place heavy objects on the power cord. A damaged power cord may cause fire or electric shock.
- Switch off the power switch and disconnect the power cord from the power outlet before connecting the cable. Otherwise it may result in device failure
- When moving the instrument, be sure to turn off the power switch, unplug the power cord and the power cable, lock the head (with a lock sign),to avoid equipment falling that may cause injury or equipment damage.
- Special packing materials are used to protect the equipment during transportation. Excessive vibration or shock can cause malfunction.
- When installing and operating equipment, observe the following EMC instructions (EMC):
 1. The device can't be used in conjunction with other electronic devices to avoid electromagnetic interference with other electronic devices.
 2. The equipment can't be used in the same room with other devices, including life support devices, other devices that have a significant impact on the lives of patients and the results of treatment and the measurement or treatment devices of small current.
 3. The equipment can't be used in conjunction with portable and mobile radio frequency communication devices because of their electromagnetic interference may adversely affect the operation of the device.
 4. Don't use cables and accessories other than those specified by the company. These may increase the electromagnetic wave emitted by the equipment or system and reduce the electromagnetic interference resistance of the device.

If there is a potential electromagnetic interference between the equipment and other equipments, shielding measures should be taken or the location of the device to be changed to reduce the possible interference.

2.3 Safety precautions during use

CAUTION

- When the equipment is disuse, please turn off the power and cover the dust cover. If the equipment is exposed for a long time, it may have dust, which will affect the accuracy.
- Please check the equipment before the operation. If there is any abnormal, do not use the equipment. The equipment used to abnormal conditions that may affect the accuracy of the data, the unexpected failures or diagnosis errors may cause harm.
- Before measuring each patient, clean the chinrest and forehead rest with clean gauze or absorbent cotton. If necessary, dampen a cloth with rubbing alcohol and gently wipe them off. If you use a Chinrest paper, a replacement for each patient.
- Keep the measuring window free of fingerprints and dust. Also confirm that it is not dirty before use, or else measurement accuracy may decrease substantially.
- In the event of smoke or strange odors, immediately turn off the device and disconnect the power plug from the power outlet. After it is certain that the smoke has stopped, contact MSOC or your authorized distributor.
- The continued use of the equipment under unusual circumstances may cause a fire or electric shock. In case of fire, use a dry powder (ABC) fire extinguisher.
- Never press on the LCD with a hard object such as a ball-point pen. Keep magnetic objects away from the LCD. Malfunction of the device may result.
- Do not operate the LCD screen with wet hands. Water infiltration devices may cause malfunction of the equipment
- There may be a few dead or constantly-lit pixels on the LCD. This does not represent failure of the LCD. It is due to the structure of the LCD.
- Only after training qualified personnel can operate the instrument, or operate under its guidance.

2.4 Safety precautions after use

CAUTION

- If the device is a long period of disuse, disconnect the power supply. Dust may collect moisture that may cause short circuit or fire.
- Occasionally use a dry cloth to clean the tip of the power supply plug. If the dust falls on the tip, water may be collected, resulting in a short circuit or fire.
- Don't jerk when pulling out power line. This will destroy the metal line and may cause electric shock, short circuit or fire.
- Maintain the following environmental conditions during transport and storage of the device.
 - Temperature: -40°C - $+55^{\circ}\text{C}$
 - Humidity: $\leq 80\%$
 - Atmospheric pressure: 700hPa - 1060hPa(transport)、500hPa - 1060hPa(storage)
 - A location with low dust
 - A location not exposed to direct sunlight

- Special packing materials are used to protect the equipment during transportation. Excessive vibration or shock can cause malfunction.

2.5 Maintenance and check

CAUTION

- Do not wipe any part of the instrument with a solvent or a strong cleaning solution. Otherwise the instrument may be damaged.
- Do not use organic solvents such as paint thinner to clean the outside of the device. Otherwise the surface of the equipment may be damaged.
- Avoid touching the optical components of the instrument to prevent performance degradation caused by fingerprints or grease stains on the lens set.
- Any repairs and services to this instrument must be carried out by personnel or dealers trained by MSOC.
- Adjustments must be made by the technical service personnel of MSOC or other authorized personnel.
- The battery of the instrument must be replaced by the technical service personnel of MSOC or other authorized personnel.
- When the equipment is returned to the company for repair or maintenance, use a clean cloth dipped in the alcohol disinfection device (especially the area of patient contact).
- When there is a big difference between the results of the Auto ref/keratometer measurements and the subjective measurements, please contact MSOC or the dealer to determine whether the current equipment requires calibration of the measurement accuracy.

2.6 Disposal

CAUTION

- Follow local governing ordinances and recycling plans regarding disposal or recycling of device components.
It is recommended to deal with industrial waste by the designated contractor.
Deal with packaging material in accordance with local laws and regulations.

3. Configuration and Functions

3.1 Device configuration

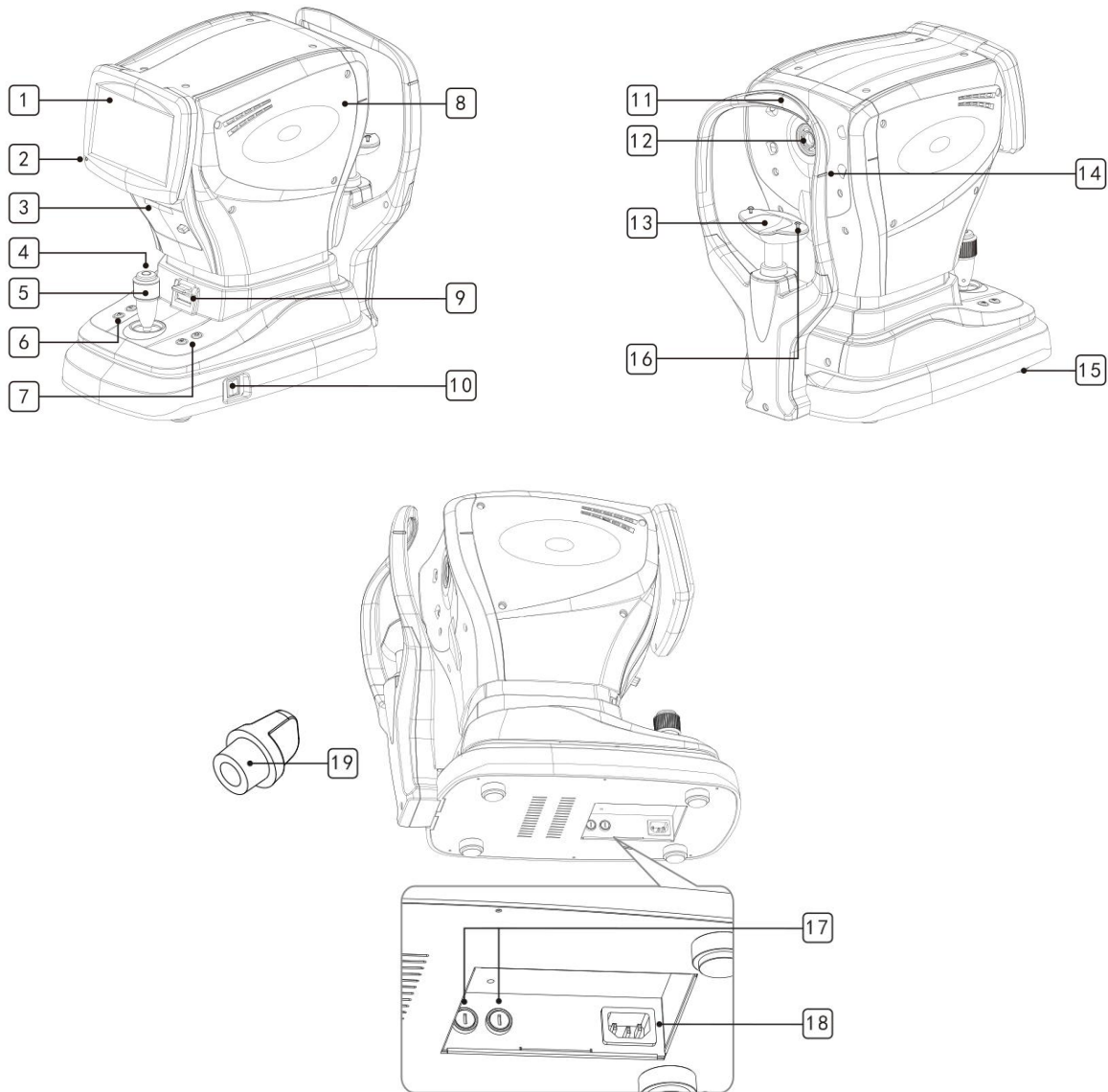



Figure 1 instrument view

1. 7 inch resistive screen: Display measurement results. The screen can adjust angle.
2. Power pilot lamp: When the instrument is working, the indicator light is bright.
3. Printer: print measurement results.
4. Measurement button: When the measurement button is pressed, measurement starts.
5. Joystick: Adjust the measuring window position forward and backward/ Left and right / up and down.

6. Chinrest up/down button ( / ) :Realize the function of lifting the chinrest.

7. Reset print key () : Reset print function.
8. Measuring unit: It is functional unit.
9. Locking lever: Fixation the main body to the base.
10. Power switch: Turn on or off the instrument power switch.
11. Forehead rest: Here on the forehead.
12. Measuring window: Measurement of retinal imaging
13. Chinrest: Fixed chin.
14. Eye level marker: The height of the chinrest should be adjusted so that the patient's eye roughly aligns with this line.
15. Adjust the foundation: Support the instrument to adjust the level of equipment.
16. Fixing pins: Fix the model eye and chinrest paper.
17. Fuse holder: 2 fuses installed inside.
18. Power inlet: Connect ~220V, 50Hz AC.
19. The cover of measuring window

3.2 Accessories

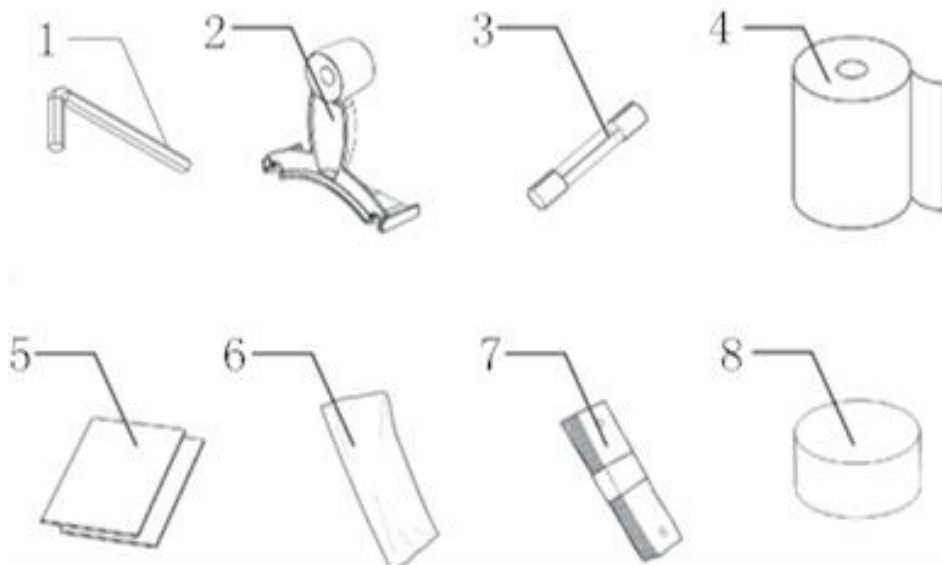

















1. Socket head wrench: Unlock plug screw.
2. Model eye: Use to proofreading accuracy.
3. Fuse wire: To prevent short circuit.
4. Printing paper: Measurement of retinal imaging.
5. Operator's manual: Instructions for use of this device.
6. Dust cover: When not using the instrument, dustproof.
7. Chinrest paper: Customer put on the chinrest.
8. Horizontal bubble: Display instrument level.



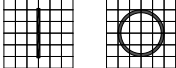

 **WARNING**

The instrument accessories are provided by MSOC, and the accessories of other manufacturers need to be verified and confirmed before use.

3.3 Symbols

The following symbols are applied to the device.

| | |
|---|---|
|  | Equipment is to meet the basic requirements of the EU MDD 93/42/EEC. |
|  | Indicates that this equipment is to prevent moisture. |
|  | Reading operator's manual. |
|  | Indicates that the degree of protection against electric shock is of a Type B Applied Part. |
|  | Indicates the requirements for disposal of electronic and electrical equipment. |
|  | Indicates the equipment manufacturers. |
|  | EU authorized representative. |
|  | Indicates the year of manufacture. |
|  | Warning, please read the operator's manual before using. |
|  | Indicates the device serial number. |
|  | " "and "O" respectively represent the power switch on and off. |
|  | Alternating current. |
|  | Fuse indication. |
|  | 3V CR1220 button battery. |
|  | Push down to lock the mobile body .Push up to unlock the mobile body. |
|  | Joystick: For the front and back / left and right / upper and lower to adjust the measurement window position. The window rises when the joystick is turned |

| | |
|---|---|
| | clockwise. The window drops when the joystick is turned counterclockwise. Press the button when the focus is completed. |
|  | Button for chinrest up. |
|  | Button for chinrest down. |
|  | Button for reset. |
|  | Button for print. |

3.4 Operation flow

The design block diagram of the software and user interface is shown below. Through the operating interface, the user can achieve the measurement, data display, image analysis, the parameters and functions of the modification.

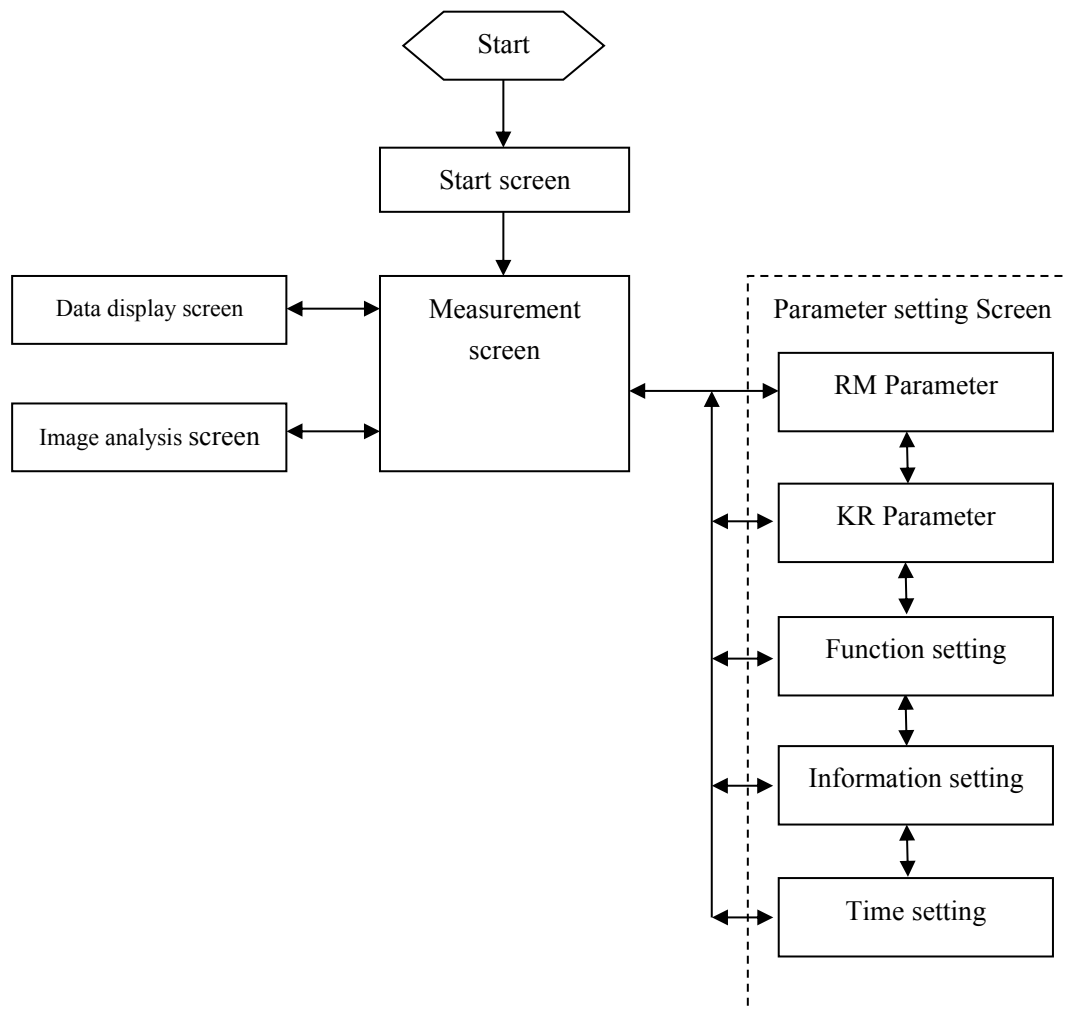

Operation screen flow chart

1.Measurement screen

As shown in the figure:

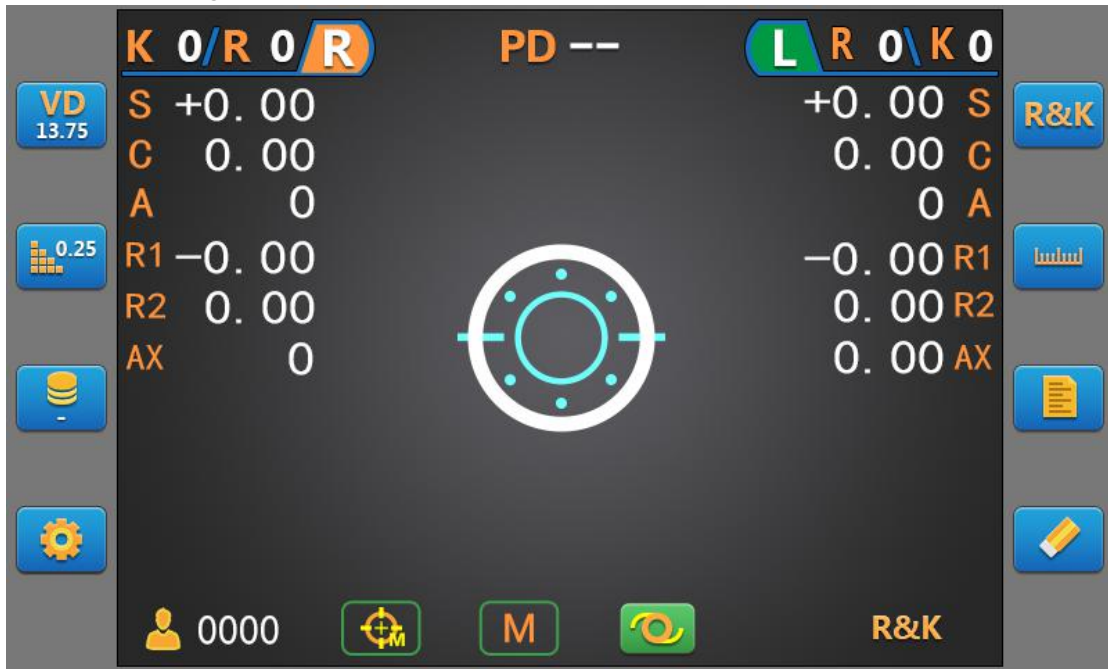

The function buttons on the screen and the display of each region are as follows:



Set button: Press this button to enter the parameter settings interface, specific in the chapter.



Clear button: Press this button to clear the test record in memory.



Display history data button: Press this button to display the measured historical data.



Display the symbol of the cylinder: touch this button can be cycle switch.



PD Measurement button: Touch this button to enter the PD Measurement screen.



Measurement mode switch: Touch this key to circularly switch measurement mode.



The show step of the Sphere and cylinder: Touch the key to circularly switch the step.



VD display: Touch this key to circularly switch VD value.



Count the times of left and right measurement: "L" means "left". The second letter R represents the measurement of REF. The third is the times of measurement. The fourth letter K represents the measurement of KER. The last is the times of measurement.



Count the times of left and right measurement: The first letter K represents the measurement of KER. The second is the times of measurement. The third letter R represents the measurement of REF. The fourth is the times of measurement. The last "R" means "right".



The value of PD display: When left and right eye measurements are completed and PD switch turn "ON", the PD value will be displayed. Otherwise displayed "--".



For REF data display Three forms of corneal curvature data display



Serial number of patients



Manual / automatic mode: Touch this button to switch measurement mode between manual and automatic.



Manual / auto alignment method: Touch this key to switch up and down alignment between manual alignment and automatic alignment.



IOL switch button: Touch this key to switch IOL mode.

3.5 Set screen description

Touching the setting button in the measurement interface, you can enter the parameter settings screen.

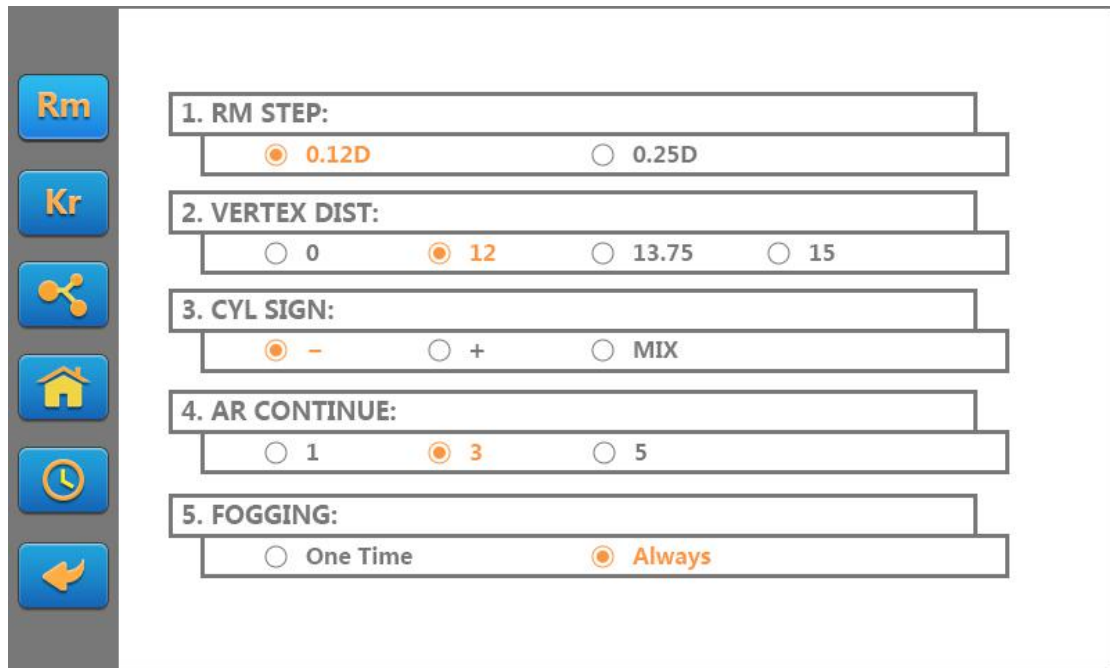

The buttons on the left side of the screen are all kinds of function parameters:



Touch this button to display the REF function parameters.



Touch this button to display the KER function parameters.



Touch this button to display the function setting parameters.



Touch this button to display the information setting parameters.



Touch this button to display the time setting parameters.

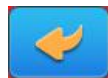

Touch this button to return to the measurement screen.

The Description of functional parameters is as follows:

1. REF functional parameter:

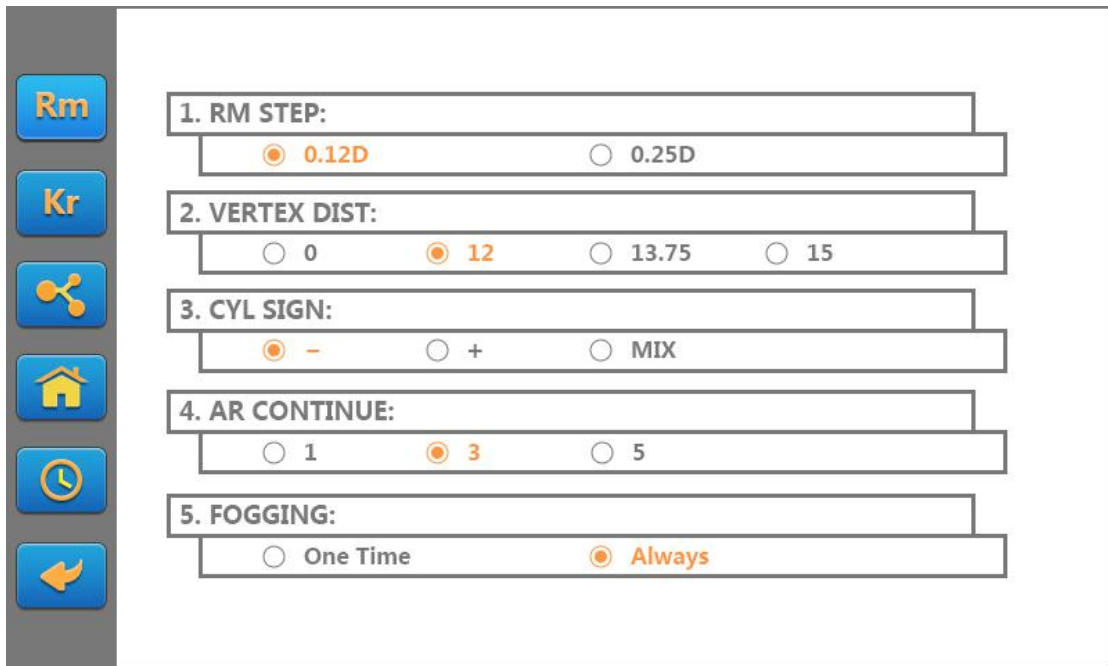

1. RM STEP:
 0.12D 0.25D

2. VERTEX DIST:
 0 12 13.75 15

3. CYL SIGN:
 - + MIX

4. AR CONTINUE:
 1 3 5

5. FOGGING:
 One Time Always

RM step: 0.12D / 0.25D
 VERTEX DIST: 0 / 12 / 13.5 / 15
 CYL SIGN: - / + / MIX
 AR CONTINUE: 1 / 3 / 5
 FOGGING: one time / always

2. KER functional parameter:

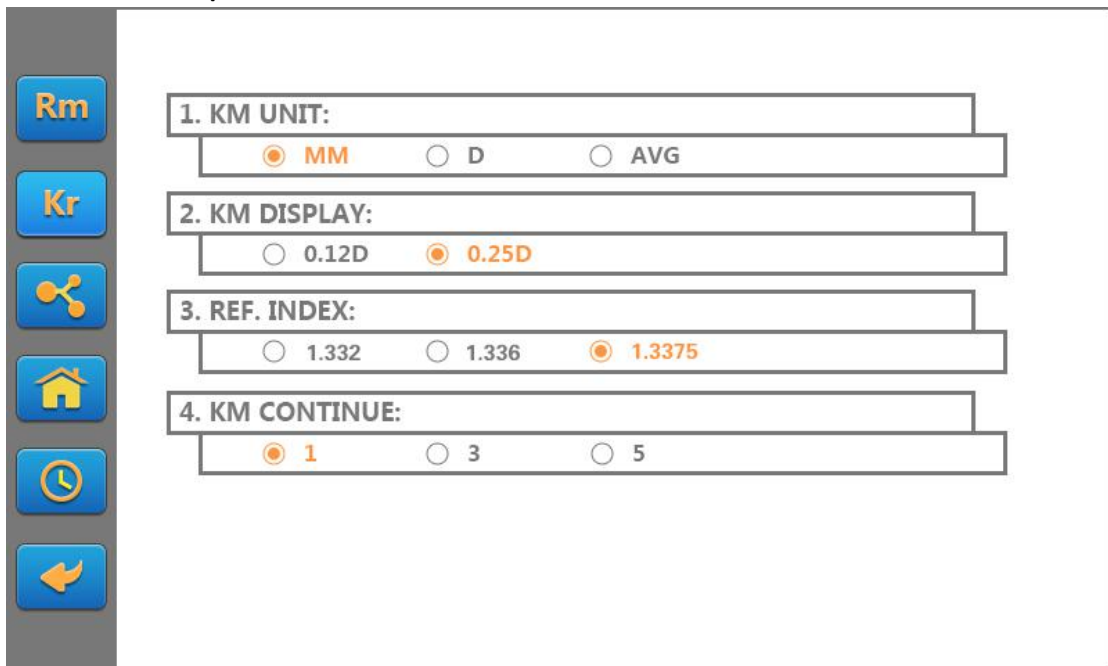

1. KM UNIT:
 MM D AVG

2. KM DISPLAY:
 0.12D 0.25D

3. REF. INDEX:
 1.332 1.336 1.3375

4. KM CONTINUE:
 1 3 5

KM unit: MM / D / AVG
 KM Display: 0.12D / 0.25D
 REF INDEX: 1.332 / 1.336 / 1.3375
 KM CONTINUE 1 / 3 / 5

3. Function setting:

Rm

Kr

1. LANGUAGE:
 English 中文

2. PD DISPLAY:
 OFF ON

3. SCREEN SLEEP:
 OFF 5MIN 15MIN

4. BEEP JOB:
 OFF ON

5. AUTO PRINT:
 OFF ON

Rm

Kr

6. RM PRINT:
 OFF AVG STD

7. KR PRINT:
 OFF AVG STD

8. EYE PRINT:
 OFF ON

9. RS232C OUTPUT:
 OLD NEW

10. BAUD RATE:
 115200 9600 4800 2400

Language: English / Chinese

PD display: OFF / ON

Screen Sleep: OFF / 5MIN / 15MIN

Beep job: OFF / ON

Auto print: OFF / ON

RM print: OFF / AVG / STD

KR print: OFF / AVG / STD

Eye Print: OFF / ON

RS232C output: OLD / NEW

baud rate: 115200 / 9600 / 4800 / 2400

4. Information setting

Set information 1 and information 2. Information 1 and information 2 will be printed on the top and foot of the prescription list.

5. Time & Date setting

Set the date and time of the instrument.

| 0000 PD -- RL | | | | | | |
|---------------|---|---|----|---|---|---|
| S | C | A | | S | C | A |
| | | | 1 | | | |
| | | | 2 | | | |
| | | | 3 | | | |
| | | | 4 | | | |
| | | | 5 | | | |
| | | | 6 | | | |
| | | | 7 | | | |
| | | | 8 | | | |
| | | | 9 | | | |
| | | | 10 | | | |
| | | | | | | |

Button in the left of the screen respectively expressed:



Touch this key to show that REF measures the last ten sets of historical data.



Touch this key to show that KER measures the last ten sets of historical data.



Touching this button, according to the function set print REF and KER measurement data.



Touch this key to clear all the measurement data. The measurement process reset.



Touch this button to return to the measurement screen.

The icons above the title bar:



Serial number of patients



The value of PD display: When left and right eye measurements are completed and PD switch turn "ON", the PD value will be displayed. Otherwise displayed "--".

4. Installation and measurement preparation

1. Unlock

First, turn “9. Locking lever” up

Then, Use inner hexagon spanner of appendix to turn the screw in Figure 6 anticlockwise.

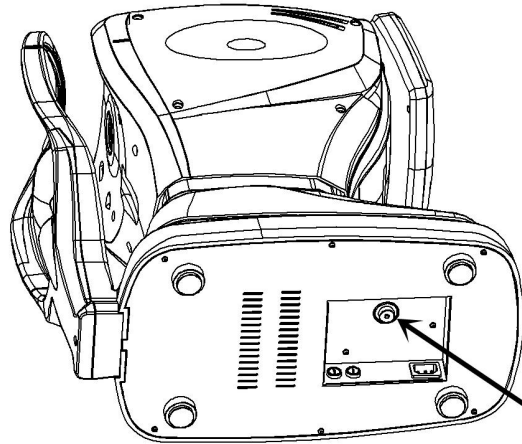

Figure 6 unlock

2. Connect power cord

Place the instrument on a horizontal table;

Make sure that the power switch is turned off. Then connect the power cord plug to the “18.power inlet”

3. Set chinrest paper

Pull out “16. Fixing pins” of two sides.

The “16. Fixing pins” is inserted into the hole of chinrest paper.

Install chinrest paper on “13.Chinrest”.

4. Set new printer paper

The installation sequence of the printer paper refers to Section 6.2 in this manual.

5. Check setting parameters

Before the measurement, please check the parameters of each setting screen.

If necessary, the hospital name, address and other information can be entered into the memory of the instrument in advance. The method of input information refers to Section 3.5 in this manual.



CAUTION

Before the formal measurement, please check the setting parameters in Section 3.5 to confirm the parameters for the required value. Because different settings parameters will cause changes in the measurement

| | |
|--|----------|
| | results. |
|--|----------|

5. Measurement

5.1 Model eye measurement

1. Turn on main body power switch

Connect main body to power inlet by power cord, turn on the power.

2. Set model eye

Removing the chinrest paper, adjust the position of the model eye seat hole and the chinrest hole to insert the fixing pins after alignment.

3. Adjust the measurement position and focus

After setting model eye, adjust joystick to focus until model eye circle focus (the clearest position).

Adjust the joystick until appear a yellow aligned symbol, as shown in the following figure.

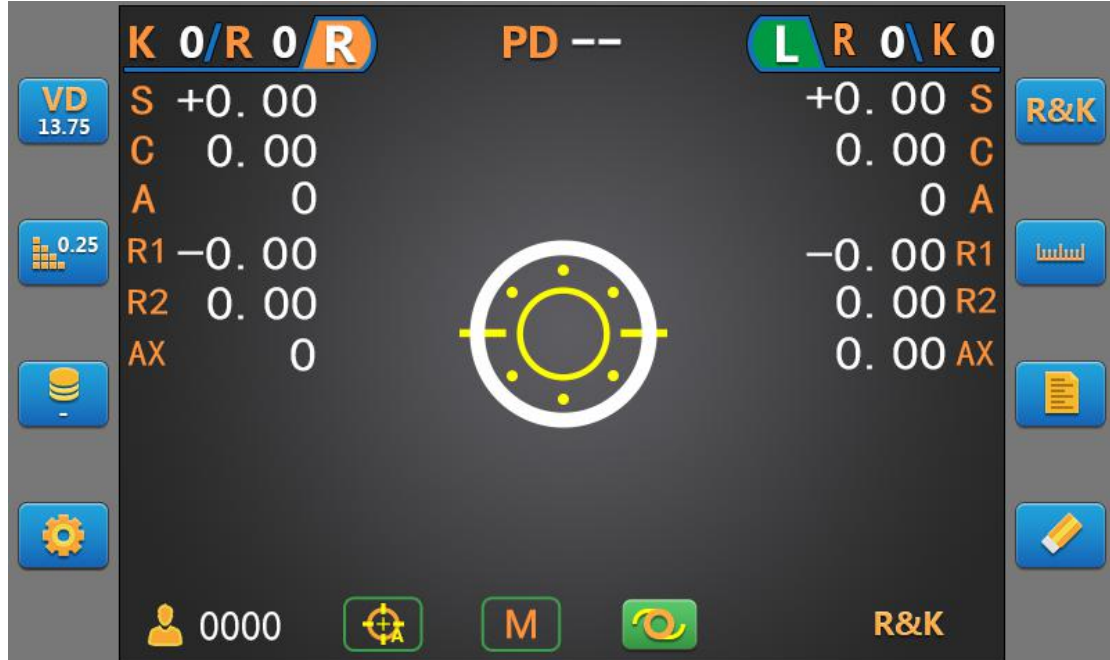

Figure 7 focus image

- A. Height adjustment: By rotating the "5.Joystick" and "6.Chinrest up/down button" to adjust.
- B. Moving the "5.Joystick" left and right to move the small bright spot around.
- C. Focus adjustment: Tilt joystick front and rear, so that the mark of focus adjustment clearly

displayed on the bright spot.

4. Measurement

As mentioned above, adjust the position and focus with the model eye.

Press the measurement button.

| | |
|---|---|
|  WARNING | <p>If the following things happen, please turn off the power supply in a timely manner, unplug the AC power line and contact the dealer of MSOC.</p> <ul style="list-style-type: none">● Instrument smoke, smell or noise.● When liquid or metal enters the instrument.● When the instrument is dropped or damaged. |
|---|---|

| | |
|---|--|
|  CAUTION | <p>In the state of power, the device will automatically enter the power saving mode within 5 minutes without operation. In the power saving mode by pressing any key will switch to the ready measurement state.</p> |
|---|--|

5.2 Patient measurement

1. Turn on the power switch

Connect main body to power inlet by power cord.

2. Postural adjustment

Let the patient to sit in the chair, place their forehead on forehead rest and their chin on chinrest.

Relax eyes and look at the icon

3. Adjust the measurement position and focus

Adjust joystick to focus until appear the clearest circular ring.

Adjust the joystick until appear a yellow aligned symbol, as shown in the following figure. The method of adjustment and focus is the same as that of the model eye.

4. Measurement

Adjust the position and focus with the model eye. Press the measurement button.

6. Self-diagnosis and maintenance

6.1 Troubleshooting

When the instrument is abnormal, please try to trouble shoot following the table.

| When | Remedy |
|---|--|
| Turning on power switch, The machine has no response. | ·Make sure the power plug is connected to the power inlet. ·Make sure the fuse is installed and not broken. |
| The screen disappears suddenly. | ·The instrument has entered the screensaver mode. Press any button to return to normal display state. |
| Button failure | ·There may be an exception. Please try to restart the instrument. |
| Printing does not start | ·Please replace the printer paper. ·Make sure the printer paper is installed correctly |

If you can't trouble shoot according to the table, please contact the dealer.

6.2 Printer Paper Replacement

When a red line appears along the edge of the printer paper, please replace the new printer paper.

- ① Open the printer cover.
- ② Remove the printer paper roll.
- ③ When install the paper to the printer, leave the appropriate length of the printer paper on the outside.
- ④ Close the printer cover.

6.3 Cleaning and disinfection

Make sure to turn off the power before cleaning and disinfecting.

Cleaning:

- ① Keep the product cleaning. Don't use strong volatile solvents, diluents or benzene as a cleaning agent.
- ② Wipe the product with a soft cloth dipped in soapy water and wring dry.
- ③ When wipe the lens and the mirror, firstly blow off the dust on the surface and then wipe with a soft dry cloth.

| | |
|---|---|
|  WARNING | <ul style="list-style-type: none"> ● Do not spray the liquid into the inspection head, otherwise it will cause damage to the instrument. ● Alcohol and acetone are forbidden. Strong solvents can cause damage. |
|---|---|

Disinfection:

① Before each patient was tested, the contact area of the patient should be cleaned and disinfected with medical alcohol (Forehead rest and Chinrest). If you use the chinrest paper, replace a new chinrest paper for each patient.

6.4 Replace fuse

- ① Turn off the power and unplug the power cord
- ② Open the fuse cover in the power socket, the Auto ref/keratometer has two fuses, please see “17.Fuse holder”.
- ③ Replace the fuse.
- ④ Install the fuse.

| | |
|---|--|
|  WARNING | The Auto ref/keratometer uses F1AL250V fuse. |
|---|--|

6.5 Instrument site change

- ① Turn off the power and unplug the power cord.
- ② Tighten the screw in Figure 6 in clockwise.
- ③ Pull down the “9.Locking lever” to lock.
- ④ When move , hold the base of product to maintain the level.

| | |
|---|---|
|  WARNING | When the product is carried out and the site is changed, be sure to lock the “screw” and the “Locking lever”. |
|---|---|

6.6 Preventive inspection and maintenance

- ① Adjust the level of the instrument with a horizontal bubble. Set the measurement step of spherical to 0.12D. Then measure according to the steps of the 5.1 model eye measurement in this manual. The measurement results are in accordance with the requirements of Table 1. When the measurement results do not meet the requirements, must report after-sales service department of MSOC to recalibrate.
- ② General technical inspection accord to the instructions section 1.3, item 4, a)-e). Visual inspection must be in full compliance.
- ③ When do not meet the requirements, must report after-sales service department of MSOC to

recalibrate or maintain.

④ Once every six months.

⑤ The maintenance shall be carried out at least once a month according to the requirements of cleaning in the section 6.3 in this manual.

6.7 Scrap

| | |
|--|---|
|  <p>CAUTION</p> | <p>① The disposal of scrap products and accessories comply with the relevant laws and regulations of local government. The product or lithium battery, especially lithium batteries may cause pollution to the environment.</p> <p>② The disposal of waste packaging materials shall comply with the relevant laws and regulations of the local government.</p> |
|--|---|

7. Outline dimension and other instructions

7.1 Outline specification, Contraindication

Outline specification:

Main body: 487mm×262mm×467mm; Net weight: 17kg

Power:100-240V~ 50/60Hz,50VA

Contraindication: Nothing

7.2 Service life

The life time of the Auto Refractometer is 8 years.

7.3 Disclaimer

The manufacturer shall be responsible for the safety. Reliability and performance of the product meet the following conditions:

(1) Install according to the instruction manual.

(2) Use and maintain according to the instruction manual and service manual.

The manufacturer shall not be held responsible for any problems caused by the alteration of

the instrument without permission. The altered instrument will not be within the scope of the manufacturer's commitment.

8. After-sale service

If there are problems during use the machine and still not resolved after communication with the agent. Please fill table according to the following requirements and projects and issued to the agents of MSOC.

- ① Product model name: RM-9600/KR-9600 RM-9800/KR-9800
- ② Serial number: The number and text recorded on the nameplate
- ③ Problem Description: A detailed description of the problem

9. Main specifications

| | |
|---------------------------------------|---|
| Diopter measurement | |
| VD | 0, 12, 13.5, 15mm |
| Spherical power (S) | -25.00— +22.00DS (Step 0.12/0.25D) |
| Cylindrical power (C) | 0.00— ±10.00DC (Step 0.12/0.25D) |
| Cylinder axis (A) | 0—180° (Step 1°) |
| Astigmatism symbol (CYL:) | “—”, “+”, “±” |
| PD | 10 ~ 85 mm |
| Corneal curvature radius: (KR) | 5mm - 10mm (Step 0.01mm) |
| Corneal refractive power: (KR) | 67.50 m ⁻¹ - 33.75 m ⁻¹ (0.12 m ⁻¹ /0.25 m ⁻¹) |
| Data storage | |
| Each eye can store 10 measured values | |
| Hardware specifications | |
| Printer | Thermal printer |
| Power saving mode | 5 minutes or 15 minutes optional, automatic power saving mode |
| Display | 7 inch color LCD |
| Voltage, frequency | 100-240V~, 50/60Hz |
| Power | 50VA |
| Chinrest bearing | 2.5kg |

10. EMC(Electromagnetic Compatibility)

Special precautions for electromagnetic compatibility are required for this equipment. And must be installed and used in accordance with the electromagnetic compatibility information specified in this specification.

Portable and mobile radio frequency communications equipment may have an impact on the device

You must use the cable and accessories provided by this equipment. Cable information is as follows:

| Cable name | Model | Length |
|------------|-------|--------|
| Power cord | / | 2.1m |

In addition the cable to being sold as spare parts of internal components, use of non-specified accessories and cables may result in reduced immunity to equipment or systems.

The equipment or system should not be used or stacked with other equipment. If it is necessary to be close or stacked use, it should be verified that it can normally operate in its configuration.

Basic performance for normal operation:

| Name | Specific description |
|------------------|--|
| Normal operation | The device can run normally during the test. |

| Guidance and manufacturer's declaration - electromagnetic emissions | | |
|---|-------------------|--|
| The device is intended for use in the electromagnetic environment specified below. The customer or the user of the device should assure that it is used in such an environment. | | |
| Emissions test | Compliance | Electromagnetic environment - guidance |
| RF emissions GB 4824 | Group 1 | The device uses RF energy only for its internal function. Therefore, its RF emissions are very low and are not likely to cause any interference in nearby electronic equipment. |
| RF emissions GB 4824 | Class A | The equipment is suitable for use in all facilities, including household directly connected to the public low-voltage power supply network that supplies buildings used for domestic purposes. |
| Harmonic emissions GB 17625.1 | Not applicable | |
| Voltage fluctuations/ Flicker GB 17625.2 | not applicable | |

| Guidance and manufacturer's declaration - electromagnetic immunity | | | |
|---|--|--|--|
| The device is intended for use in the electromagnetic environment specified below. The customer or the user of the device should assure that it is used in such an environment. | | | |
| Immunity test | IEC60601 test level | Compliance level | Electromagnetic environment - guidance |
| Electrostatic Discharge (ESD) GB/T 17626.2 | ±6kV contract ±8kV air | ±6kV contract ±8kV air | Floor should be wood, concrete or ceramic tile. If floors are covered with synthetic material, the relative humidity should be at least 30%. |
| Electrical fast transient/burst GB/T 17626.4 | ±2kV for power supply lines ±1 kV for input/output lines | ±2kV for power supply lines Not applicable | Mains power quality should be that of a typical commercial or hospital environment. |
| Surge GB/T 17626.5 | ±1kV Line to line ±2kV Line to ground | ±1kV Line to line ±2kV Line to ground | Mains power quality should be that of a typical commercial or hospital environment. |
| Voltage dips, short interruptions and voltage variations on power supply input lines GB/T 17626.11 | < 5% UT, for 0.5 cycle(> 95% dip in UT) 40% UT, for 5 cycles (60% dip in UT) 70% UT, for 25 cycles (30% dip in UT) < 5% UT, for 5 sec (> 95% dip in UT) | < 5% UT, for 0.5 cycle(> 95% dip in UT) 40% UT, for 5 cycles (60% dip in UT) 70% UT, for 25 cycles (30% dip in UT) < 5% UT, for 5 sec (> 95% dip in UT) | Mains power quality should be that of a typical commercial or hospital environment. If the user of the device requires continued operation during power mains interruptions, it is recommended that the device be powered from an uninterruptible power supply or a battery. |
| Power frequency (50/60Hz) GB/T 17626.8 | 3 A/m | 3 A/m | Power frequency magnetic fields should be at levels characteristic of a typical location in a typical commercial or hospital environment. |
| NOTE: UT is the a.c. mains voltage prior to application of the test level. | | | |

| Guidance and manufacturer's declaration - electromagnetic immunity | | | |
|---|---|-------------------------|---|
| The device is intended for use in the electromagnetic environment specified below. The customer or the user of the device should assure that it is used in such an environment. | | | |
| Immunity test | IEC60601 test level | Compliance level | Electromagnetic environment - guidance |
| Electromagnetic environment - | 3 V (Effective value) 150kHz - 80MHz | 3 V (Effective value) | Portable and mobile RF communications equipment |

| | | | |
|--|---------------------------------|--------------|--|
| <p>guidance GB/T 17626.6</p> <p>Radiated RF GB/T 17626.3</p> | <p>3 V/m 80MHZ - 2.5GHZ</p> | <p>3 V/m</p> | <p>should be used no closer to any part of the device, including cables, the recommended separation distance calculated from the equation applicable to the frequency of the transmitter.</p> <p>Recommended separation distance</p> <p>$d = 1.2\sqrt{P}$ 150kHz-80MHz</p> <p>$d = 1.2\sqrt{P}$ 80MHz-800MHz</p> <p>$d = 2.3\sqrt{P}$ 800MHz-2.5GHz</p> <p>Where P is the maximum output power rating of the transmitter in watts (W) according to the transmitter manufacturer and <i>d</i> is the recommended separation distance in meters (m).</p> <p>Field strengths from fixed RF transmitters, as determined by an electromagnetic site survey, ^a should be less than the compliance level in each frequency range. ^b</p> <p>Interference may occur in the vicinity of equipment marked with the following symbol:</p>  |
|--|---------------------------------|--------------|--|

NOTE1: At 80 MHz and 800 MHz, the higher frequency range applies.

NOTE2: These guidelines may not apply in all situations. Electromagnetic propagation is affected by absorption and reflection from structures, objects and people.

^a Field strengths from fixed transmitters, such as base stations for radio (cellular/cordless) telephones and land mobile radios, amateur radio, AM and FM radio broadcast and TV broadcast cannot be predicted theoretically with accuracy. To assess the electromagnetic environment due to fixed RF transmitters, an electromagnetic site survey should be considered. If the measured field strength in the location in which the device is used exceeds the applicable RF compliance level above, the device should be observed to verify normal operation. If abnormal performance is observed, additional measures may be necessary, such as reorienting or relocating the device.

^b Over the frequency range 150 kHz to 80 MHz, field strengths should be less than 3 V/m.

Recommended separation distances between portable and mobile RF communications equipment and the device

The device is intended for use in an electromagnetic environment in which radiated RF disturbances are controlled. The customer or the user of the device can help prevent electromagnetic interference by maintaining a minimum distance between portable and mobile RF communications equipment (transmitters) and the device as recommended below, according to the maximum output power of the communications equipment.

| Rated maximum output power of transmitter (W) | Separation distance according to frequency of transmitter (m) | | |
|---|---|---------------------------------------|--|
| | 150kHz - 80MHz $d = 1.2\sqrt{(P)}$ | 80MHz - 800MHz $d = 1.2\sqrt{(P)}$ | 800MHz - 2.5GHz $d = 2.3\sqrt{(P)}$ |
| 0.01 | 0.12 | 0.12 | 0.23 |
| 0.1 | 0.38 | 0.38 | 0.73 |
| 1 | 1.2 | 1.2 | 2.3 |
| 10 | 3.8 | 3.8 | 7.3 |
| 100 | 12 | 12 | 23 |

For transmitters rated at a maximum output power not listed above, the recommended separation distance d in meters (m) can be estimated using the equation applicable to the frequency of the transmitter, where P is the maximum output power rating of the transmitter in watts (W) according to the transmitter manufacturer.

NOTE 1: At 80 MHz and 800 MHz, the separation distance for the higher frequency range applies.

NOTE 2: These guidelines may not apply in all situations. Electromagnetic propagation is affected by absorption and reflection from structures, objects and people.