

**mindray**

## WATO EX-65 Pro

Anesthesia system



[www.mindray.com](http://www.mindray.com)

P/N:ENG-WATO EX-65 Pro-210285X8P-20210407  
©2021 Shenzhen Mindray Bio-Medical Electronics Co.,Ltd. All rights reserved.

**mindray**  
healthcare within reach

Since 2006 Mindray has successfully installed over 50,000 anesthesia machines for customers all over the globe. We are glad and proud that every few seconds a clinician somewhere on this planet happily switches on a Mindray anesthesia machine.

For the last decade, Mindray has continued to work closely with clinicians across the globe, to recognize and understand the clinical challenges encountered every day and overcome them with new innovative and intuitive solutions. With this in mind, Mindray is now proud to bring you the flagship of the WATO series, the WATO EX-65 Pro.



## More Precise

With new integrated innovative functions, the WATO EX-65 Pro enables you to precisely control the system for different types of patient easily.

## More Visible

With a 15-inch high-resolution display and intuitive touch user interface, the WATO EX-65 Pro makes the anesthesia process more visible.

## More Cost Effective

As a multifunctional anesthesia system, the WATO EX-65 Pro is designed with cost in mind.



## More Precise

### Enjoy Optimal Performance at Every Stage of Anesthesia

A full range of ICU grade ventilation modes meet your requirements through all the stages of anesthesia, enabling precise ventilation care for the critically ill patient.

- VCV
- PCV
- PCV-VG
- SIMV-VC
- SIMV-PC
- SIMV-VG
- PSV + Apnea (with I:E setting)
- CPAP/PS
- APRV

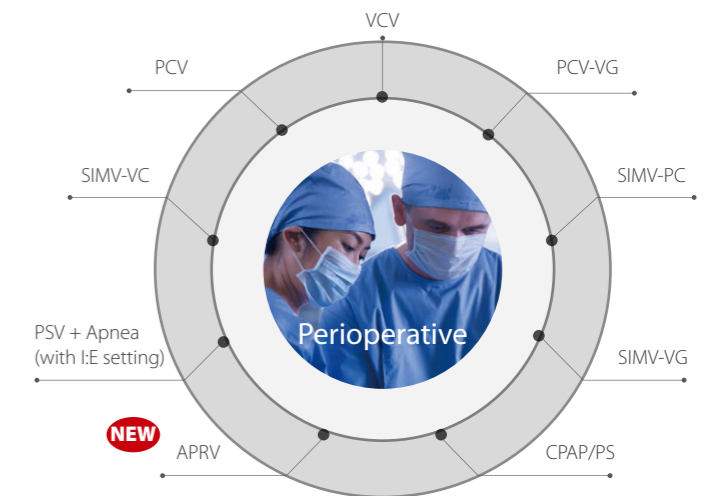

### Integrated HFNC for Better Perioperative Management

High flow nasal cannula (HFNC) plays an important role in maintaining safe oxygen saturation in patients as it extends the safe apnoeic oxygenation time during induction. HFNC can help clinicians intubate more easily, especially for patients with poor oxygen saturation such as bariatric, pediatric, or critically ill patients, or those with a difficult airway.





## More Visible

### 15-inch Touchscreen with Intuitive UI

With a high-resolution, 15-inch capacitive touch-screen users are able to view and configure parameters as required. The intuitive layout and simple flat-menu structure ensure all parameters are clearly displayed and only two steps are required to set the ventilation mode.



### Visual System Check

The System Check can be visualized with graphs and charts to simplify complicated operation steps.

- Automatic self-test
- Manual leak test with step by step graphic instructions
- Recommended solution for failed steps using written instructions and graphics

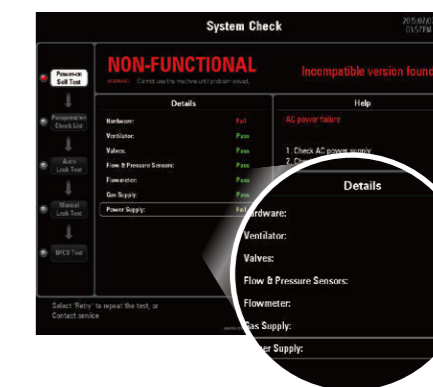

### Smart Alarm

The Smart Alarm provides the real-time graphic information, enabling quicker correction of potentially fatal errors.

- More alarm information: access to alarm log
- Alarm limit setting directly from the alarm message
- Picture indication of potential issues

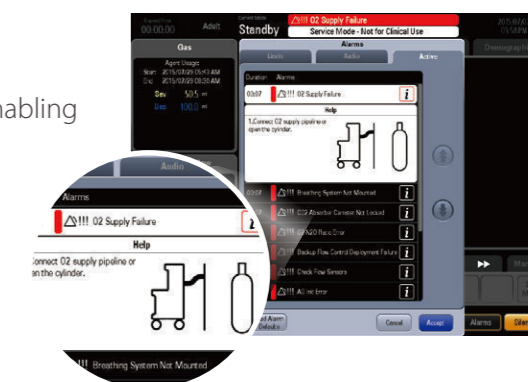

### Lung Recruitment

The new Lung Recruitment function induces improvements in gas exchange and respiratory mechanics, and can reduce the incidence of postoperative pulmonary complications.

- Two optional maneuvers: stepwise PEEP or sustained inflation
- Multiple criteria to evaluate recruitment effectiveness

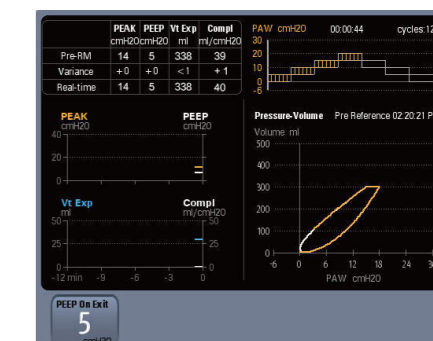

### Precise Digital Gas Mixer with Safe Low Flow by Optimizer

The digital gas mixer makes fresh gas flow settings easier and more precise.

The fresh gas flow Optimizer indicates the recommended fresh gas flow setting against your current setting value and the minimum O<sub>2</sub> needed by the patient. It ensures a safe low flow and minimizes the waste of anesthetic agents and medical gases.

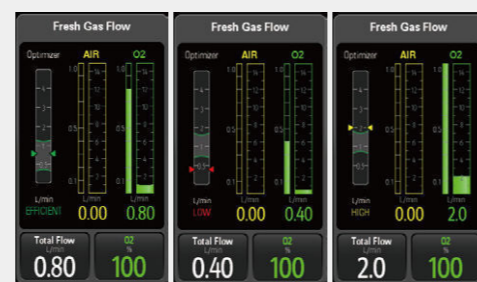

### Precise Monitoring

Mindray Plug-and-Play Multi-Gas modules provide comprehensive breath-by-breath analysis of O<sub>2</sub>, CO<sub>2</sub>, N<sub>2</sub>O, and auto-detection of five anesthetic agents, as well as BIS.





# More Cost Effective

## Saves Anesthetic Agents

The low flow Optimizer provides real time guidance for cost-effective optimization of the fresh gas flow, and thus the anesthetic agent. During general inhalation anesthesia, the Optimizer continuously informs users whether the fresh gas flow is too high, appropriate, or too low.

Using the Optimizer results in a large reduction in anesthetic consumption, saving money and reducing environmental pollution.

AA Measurement: The new anesthetic agent calculation software enables you to monitor real-time anesthetic agent consumption and keep costs in mind.

With AA prediction, it is possible to display both previous and current values of FiAA, EtAA as well as MAC, and even forecast their future trends.

<p><b>LOW FLOW</b></p> <p><b>Price</b> Dependent on fresh gas flow</p> <p><b>Pollution</b> Operation room, environment</p> <p><b>Patient</b> Temperature, humidity</p>	<p><b>Fresh Gas Flow</b></p> <p>AA 0 10 100 0 ml/h</p> <p>O2 0.36 L/min</p> <p>AIR 0.85 L/min</p> <p>Optimizer</p> <p>Total Flow 1.2 L/min</p>	<p><b>Waveforms Prediction</b></p> <p>MAC</p> <p>FiAA</p>
<p><b>Why low flow?</b></p>	<p><b>Optimizer</b></p> <p><b>AA Measurement</b></p>	<p><b>AA prediction</b></p>

## Modular Design

The Plug-and-Play monitoring modules are compatible with the Mindray modular patient monitor. The modular design not only saves money, but also makes maintenance of your devices easier.



## Flow Sensors Which Users Could Calibrate

Flow sensors are always a challenge for users of anesthesia machines. They need changing every couple of months, and sometimes will become inaccurate and affect the precision of Tidal Volume. And normally they have to be calibrated by a service technician.

The WATO EX-65 Pro is different. As well as the two flow sensors in the expiration and inspiration ports for dynamic tidal volume compensation, the WATO EX-65 Pro comes with a built-in 3rd flow sensor as a benchmark. The benchmark flow sensor is used to calibrate the flow sensors in the expiration and inspiration ports to ensure the flow sensors maintain accuracy while extending their life span. Users can even calibrate the sensors themselves.

- 3rd benchmark flow sensor
- User calibration
- Extended life span



# WATO EX-65 Pro

## Anesthesia System

### Physical Specifications

#### Dimensions and Weight

Height	1370 mm
Width	780 mm (not including breathing system) 945 mm (including breathing system)
Depth	690 mm
Weight	<145 kg (without vaporizers and cylinders)

#### Top Shelf

Weight limit	30 kg
Width	305 mm
Length	545 mm

#### Work Surface

Height	850 mm
Area	1635 cm <sup>2</sup>

#### Drawer (3Xdrawers, Internal Dimension)

Height	130 mm
Width	415 mm
Depth	320 mm

#### Bag Arm

Height	1150 mm
Length	312 mm
Connection	ISO 22mm OD, 15mm ID

#### Casters

Diameter	125 mm
Brakes	Center brake system with Lock / Unlock icons

### Ventilator Specifications

#### Modes of Ventilation

- Manual/Spontaneous Ventilation/Bypass
- Volume Control Ventilation (VCV) with PLV function
- Pressure Control Ventilation (PCV) with/without volume guarantee (VG)
- Synchronized Intermittent Mandatory Ventilation (SIMV-Volume Controlled and SIMV-Pressure Controlled)
- Pressure Support Ventilation (PS) with apnea backup
- Synchronized Intermittent Mandatory Ventilation Volume Guarantee (SIMV-VG)
- Continuous Positive Airway Pressure/Pressure Support Ventilation (CPAP/PS)
- Airway Pressure Release Ventilation (APRV)

#### Compensation

Circuit gas leakage compensation and automatic compliance compensation

#### Ventilation Parameters Range

Patient Size	Adult, Pediatric, Neonate
Tidal volume	10~1500 mL (Volume Mode) 5~1500 mL (Pressure Mode)
Pinsp	5~80 cmH <sub>2</sub> O
Plimit	10~100 cmH <sub>2</sub> O
ΔPsupp	3~60 cmH <sub>2</sub> O 0, 3~60 cmH <sub>2</sub> O (CPAP/PS)
Rate	2~100 bpm
I:E	4:1 - 1:8
Inspiratory pause (Tip:Ti)	OFF, 5% - 60%
Inspiratory time (Tinsp)	0.2 - 10.0 s
Trigger window	5% - 90%
Flow trigger	0.2 ~ 15 L/min
Pressure trigger	-20~ -1 cmH <sub>2</sub> O
Expiration termination level	5% - 80%
Minimum Rate	2 - 60 bpm



Tslope	0.0 - 2.0 s
Apnea I: E	4:1~1:8
ΔPapnea	3 - 60 cmH <sub>2</sub> O
Phigh	3 - 80 cmH <sub>2</sub> O
Plow	OFF, 3 to 30 cmH <sub>2</sub> O
Thigh	0.2 to 10.0s
Tlow	0.2 to 10.0s

#### Positive End Expiratory Pressure (PEEP)

Type	Integrated, electronic controlled
Range	OFF, 3~30 cmH <sub>2</sub> O

#### Ventilator Performance

Driving pressure	280 kPa to 600 kPa
Peak gas flow	180 L/min + Fresh Gas Flow

#### Monitoring Parameters

Minute volume	0 ~ 100 L/min
Tidal volume	0~3000 ml
Inspired oxygen (FiO <sub>2</sub> )	18% ~ 100%
Airway pressure	-20 ~ 120 cmH <sub>2</sub> O
I:E	50:1 ~ 1:50
Rate	0 ~ 120 bpm
PEEP	0 ~ 70 cmH <sub>2</sub> O
Resistance (R)	0 ~ 600 cmH <sub>2</sub> O/(L/s)
Compliance (C)	0 ~ 300 ml/cmH <sub>2</sub> O
Elasticity (E)	0.003 to 10 hPa/mL(cmH <sub>2</sub> O/mL)

#### Control Accuracy

Volume delivery	5 mL to 60 mL: ±10 mL 60 mL to 210 mL: ±15 mL 210 mL to 1500 mL: ± 7% of the set value
Pressure	Pinsp, Plimit, ΔPsupp, ΔPapnea, Phigh, Plow ± 2.5 cmH <sub>2</sub> O or ± 7% of the set value, whichever is greater
PEEP	OFF: ± 3.0 cmH <sub>2</sub> O 3 to 30 cmH <sub>2</sub> O: ± 2.0 cmH <sub>2</sub> O, or ± 8% of the set value, whichever is greater
Rate	± 1bpm or ± 10% of the set value, whichever is greater
I:E	2:1 to 1:4: ± 10% of the set value Other range: ± 25% of the set value
Tip:Ti	± 8%
Tinsp	± 0.2s
Thigh	± 0.2s or ± 10% of the set value, whichever is greater
Tlow	± 0.2s or ± 10% of the set value, whichever is greater
Trigger Window	± 10%
Flow Trigger	± 1L/min
Pressure Trigger	± 2cmH <sub>2</sub> O
Exp%	± 10%

## Monitoring Accuracy

Volume monitoring	0 to 60 mL: $\pm 10$ mL 60 to 210 mL: $\pm 15$ mL 210 to 3000 mL: $\pm 7\%$ of the real reading
Pressure monitoring	$\pm 2.0$ cmH <sub>2</sub> O or $\pm 4\%$ of the real reading, whichever is greater
Rate	$\pm 1$ bpm or $\pm 5\%$ of the real reading, whichever is greater
I:E	2:1 to 1:4: $\pm 10\%$ of the reading Other range: no defined.
MV	$\pm 0.1$ L/min or $\pm 8\%$ of the real reading, whichever is greater
O <sub>2</sub> concentration	$\pm (2.5\%$ of volume percentage + $2.5\%$ of gas concentration)

## Trend Graph

Continuous trend information with time discrete events for the latest 48 hours

## Trend Table

Continuous trend information together with time discrete events for the latest 48 hours

## Alarm Log Book

500 events storage, first in first out

## Alarm setting

Tidal volume	Low: 0 ~ 1595 ml High: 5 ~ 1600 ml
Minute volume	Low: 0 ~ 99 L/min High: 0.2 ~ 100 L/min
Inspired oxygen	Low: 18% ~ 98% High: OFF, 20% ~ 100%
Apnea alarm	VTe < 10ml measured in 20s Paw < (PEEP + 3) cmH <sub>2</sub> O in 20s
Airway pressure low	0 ~ 98 cmH <sub>2</sub> O
Airway pressure high	2 ~ 100 cmH <sub>2</sub> O
Sustained airway pressure alarm:	15s
Subatmospheric pressure alarm:	Paw < -10 cmH <sub>2</sub> O
Alarm silence countdown timer:	120 to 0 seconds

## Lung Recruitment Tool

Maneuver	Multi-Step and One-Step Recruitment
One-Step Recruitment	Pressure Hold: 20 to 60 cmH <sub>2</sub> O Hold Time: 10 to 40s PEEP on Exit: Off, 3 to 30 cmH <sub>2</sub> O
Multi-Step Recruitment	Increasing PEEP progressively (with a maximum of 7 stages)

## Ventilator Components

### Flow Sensor

Type	Variable orifice flow sensor
Location	Inspiratory and expiratory port

### Oxygen Sensor

Type	Galvanic fuel cell
FiO <sub>2</sub> displayed	18% to 100%
Accuracy	$\pm$ (volume fraction of 2.5 % + 2.5 % gas level)
Response Time	$\leq 20$ seconds

### Ventilator Screen

Display type	Color capacitive touch screen
Display size	15 inch
Pixel format	1024 x 768
Brightness	Adjustable
Screen display	configurable
Display parameters	All setting and alarm parameters (including Breath rate, I/E ratio, Tidal volume, Minute volume, PEEP, MEAN, PEAK, PLAT, and O <sub>2</sub> concentration, EtCO <sub>2</sub> , N <sub>2</sub> O, Aesthesia gas concentration, BIS)
Display waveforms	P-T, F-T, V-T, CO <sub>2</sub> , BIS, O <sub>2</sub> , Anesthetic gas, N <sub>2</sub> O
Spirometry loops	P-V, F-V and F-P

Timer	On screen timer
-------	-----------------

## Communication Ports

One RS-232C connector and one DB9 connector
Ethernet (RJ-45)
USB
VGA

## Vaporizers

Vaporizer	Mindray V60 Anesthetic Vaporizer or Penlon Sigma Delta Anesthetic Vaporizer
Support agents	Halothane, Enflurane, Isoflurane, Sevoflurane
Position	MAX.2
Mounting mode	Selectatec®, with interlocking function Plug-in®, with interlocking function

## Modules

### Anesthesia Gas (AG) Module

Monitor gases	CO <sub>2</sub> , N <sub>2</sub> O, Halothane, Enflurane, Isoflurane, Sevoflurane, Desflurane, MAC, Paramagnetic O <sub>2</sub> (optional)
Warm-up time	45 s (ISO accuracy mode) 10min (full accuracy mode)
Pump rate	Adu/Ped: 150, 180, 200 ml/min Neo: 100, 110, 120 ml/min
Range	CO <sub>2</sub> : 0% ~ 10% Des: 0% ~ 18 % Sev: 0% ~ 8% Enf, Iso, Hal: 0% ~ 5% O <sub>2</sub> /N <sub>2</sub> O: 0% ~ 100%

### Carbon Dioxide (CO<sub>2</sub>) Modules

Method	Infrared absorption
Module type	Mindray side-stream Capnostat mainstream Oridion micro-stream (optional)
Work mode	Standby or measurement
Displayed numerics	EtCO <sub>2</sub> , FiCO <sub>2</sub>
Waveform	Capnography

### Side-Stream Carbon Dioxide (CO<sub>2</sub>) Module

Measurement range	0 ~ 152 mmHg
Accuracy	$\pm 2$ mmHg (0 ~ 40 mmHg) $\pm 5\%$ of the real reading (41 ~ 76 mmHg) $\pm 10\%$ of the real reading (77 ~ 152 mmHg))
Resolution	1 mmHg
Pump rate	Neonatal: 100 mL/min or 120 mL/min Adult/children: 120 mL/min or 150 mL/min
Warming-up time	< 1 min, enter the ISO accuracy mode After 1 min, enters the full accuracy mode
Response time	< 5 s@100 mL/min < 5 s@120 mL/min Measured by using neonatal watertrap and 2.5 m neonatal sampling line < 6.5 s@120 mL/min < 6 s@150 mL/min Measured by using adult watertrap and 2.5 m adult sampling line

### Mainstream CO<sub>2</sub> Module

Measurement range	0 ~ 150 mmHg
Accuracy	$\pm 2$ mmHg (0 ~ 40 mmHg) $\pm 5\%$ of the reading (41 ~ 70 mmHg) $\pm 8\%$ of the reading (71 ~ 100 mmHg) $\pm 10\%$ of the reading (101 ~ 150 mmHg)
Resolution	1 mmHg
Response time	< 2 s
Alarm limit	EtCO <sub>2</sub> High: OFF, 2 ~ 150 mmHg

	EtCO <sub>2</sub> Low: OFF, 0 ~ 148 mmHg FiCO <sub>2</sub> High: OFF, 1 ~ 150 mmHg
<b>Micro-stream CO<sub>2</sub> Module</b>	
Measurement range	0 ~ 99 mmHg
Accuracy	0 ~ 38 mmHg: ± 2 mmHg 39 ~ 99 mmHg: ± (5 % of the reading + 0.08 % of (the reading minus 38 mmHg))
Sampling rate	50 ml/min
Sampling accuracy	-7.5 ml/min ~ + 15 ml/min
Initialization time	30s
Response time	≤2.9s
Rising time	≤190 ms
Alarm range	EtCO <sub>2</sub> High: OFF, 2 ~ 99 mmHg EtCO <sub>2</sub> Low: OFF, 0 ~ 97 mmHg FiCO <sub>2</sub> High: OFF, 1 ~ 99 mmHg

<b>BIS Module</b>	
Measured parameters	EEG
BIS/BIS L, BIS R	0 ~ 100
Sweep speed	6.25 mm/s, 12.5 mm/s, 25 mm/s or 50 mm/s
Alarm limit	BIS high: 2 ~ 100 BIS low: 0 ~ 98
Calculated parameters	SQI/SQI L, SQI R; EMG/EMG L, EMG R; SR/SR L, SR R; SEF/SEF L, SEF R; TP/TP L, TP R; BC/BC L, BC R; sBIS L, sBIS R; sEMG L, sEMG R; ASYM

<b>Agent consumption calculation</b>	
Calculation range	0 to 3000 ml
Accuracy	± 2 mL, or ± 15% of the real reading, whichever is larger

<b>Agent consumption speed</b>	
Anesthetic agents	Desflurane, Enflurane, Isoflurane, Sevoflurane and Halothane
Consumption speed	Desflurane: 0 ~ 900 ml/h Sevoflurane: 0 ~ 450 ml/h Enflurane, Isoflurane and Halothane: 0 ~ 250 ml/h
Accuracy	± 2ml/h or ±15% of the real reading, whichever is greater

<b>Anesthetic Prediction</b>	
Patient Type	Height: 150 to 200 cm Weight: 40 to 140 kg Age: 18 to 90 years old
Anesthetic Agents	Desflurane, Enflurane, Isoflurane, Sevoflurane and Halothane
Prediction trend and waveform	The system displays 8 waveforms: dynamic short trend waveforms of FiAA, EtAA, FiO <sub>2</sub> and EtO <sub>2</sub> in the last 10 min and prediction trend waveforms of FiAA, EtAA, FiO <sub>2</sub> and EtO <sub>2</sub> in the next 20 min.
Prediction deviation	EtAA=0: less than volume fraction of 0.05 % EtAA≠0: - 20 % to 30 % of the measured EtAA, or - 5 % to 7.5 % of the vaporizer maximum setting, whichever is greater EtO <sub>2</sub> : - 10 % to 15 % of the measured EtO <sub>2</sub> , or volume fraction of - 5 % to 7.5 %, whichever is greater

## Electrical Specifications

<b>Current Leakage</b>	
100 ~ 240V	< 500 µA

## Power and Battery Backup

Power input	220-240 V, 50/60 Hz, 6A 100-120 V, 50/60 Hz, 7A 100-240 V, 50/60 Hz, 7A
Auxiliary electrical outlets	Up to 4 outlets (3A for each, total 5A)

Battery backup	150 minutes in case of two batteries (powered by new fully-charged batteries with 25°C ambient temperature)
Battery type	Build-in Li-ion battery, 9000 mAh (two batteries)
Safety feature	In case of electricity and battery failure, manual ventilation, gas delivery and agent delivery are possible

## Pneumatic Specifications

### ACGO (Auxiliary Common Gas Outlet, Integrated)

Connector	ISO 22 mm OD and 15 mm ID
-----------	---------------------------

### Pipeline Supply

Gas type	O <sub>2</sub> , N <sub>2</sub> O and Air
Pipeline input range	280 to 600 kPa
Pipeline connections	DISS or NIST

### Pipeline Supply Pressure Gauges

Display type	Electronic or Mechanical
Ranges	0 to 1000kPa
Accuracy	± (4% of the full scale reading + 8% of the actual reading)

### Cylinder Supply

Cylinder Supply	E Cylinder (American style or UK style)
O <sub>2</sub> Input Range	6.9 to 20 MPa
N <sub>2</sub> O Input Range	4.2 to 6 MPa
Air Input Range	6.9 to 20 MPa
Cylinder Connections	Pin-Index Safety System (PISS)
Yoke Configuration	O <sub>2</sub> , N <sub>2</sub> O, Air

### Cylinder Supply Pressure Gauges

Display type	Electronic or Mechanical
Air Range	0 to 25 MPa
O <sub>2</sub> Range	0 to 25 MPa
N <sub>2</sub> O Range	0 to 10 MPa
Accuracy	± (4% of the full scale reading+8% of the actual reading)

### O<sub>2</sub> Controls

Method	N <sub>2</sub> O shut off with loss of O <sub>2</sub> pressure
Supply failure alarm	≤ 220.6 kPa ± 34.2kPa
O <sub>2</sub> Flush	25 ~ 75 L/min

### Auxiliary O<sub>2</sub> Flowmeter

Range	0 ~ 15 L/min
Indicator	Flow tube

### High Flow Nasal Cannula Oxygen (HFNC)

Range	0 ~ 60 L/min
Indicator	Flow tube

## Electronic Flow control system (Electronic Mixer)

### Direct Flow Control Mode

O <sub>2</sub> flow range	0 to 15 L/min
Air flow range	0 to 15 L/min
N <sub>2</sub> O flow range	0 to 12 L/min
O <sub>2</sub> flow accuracy	± 50 ml/min or ± 5% of setting value, whichever is greater
Balance gas (Air/N <sub>2</sub> O) flow accuracy	± 50 ml/min or ±5% of setting value, whichever is greater

### Total Flow Control Mode

Total flow range	0.2 to 18 L/min
Total flow accuracy	± 100 ml/min or ± 5% of setting value, whichever is greater

### O<sub>2</sub> concentration

Range	21% to 100% (The balance gas is Air) or 26% to 100% (The balance gas is N <sub>2</sub> O)
Accuracy	± 5% V/V for flows < 1 L/min or 5% setting for flows ≥ 1 L/min

### Optimizer

Only available when AG or CO<sub>2</sub> Module is loaded

### Flow Pause

The fresh gas flow and ventilation will be paused for 1 minute at default. (Maximum 2 minutes)

### Backup Flow Control System

#### Control Type

Mechanical (Control Needle Valve and Knob)

#### Total flow meter

Control Range (O <sub>2</sub> )	1 +/- 0.25 to 10 L/min
Indicator	Flow tube
Indicator accuracy	± 10% of the indicated value for flows (between 10% and 100% of full scale with oxygen)

### Environmental Specifications

#### Operating

Temperature	10 ~ 40°C
Relative humidity	15% ~ 95% (noncondensing)
Barometric (Kpa)	70 ~ 106 kPa

#### Storage

Temperature	-20 ~ 60°C for main unit, -20 ~ 50°C for O <sub>2</sub> sensor
Relative humidity	10% ~ 95% (noncondensing)
Barometric	50 ~ 106 kPa

#### Electromagnetic Compatibility

Immunity	Complies with all requirements of IEC 60601-1-2
Emissions	Complies with all requirements of IEC 60601-1-2

### Breathing System Specification

#### Breathing system volume (Pre-pak)

Automatic ventilation	2850 ml
Manual ventilation	1800 ml

#### Breathing system volume (Non Pre-pak)

Automatic ventilation	2600 ml
Manual ventilation	1800 ml

#### System Components

Carbon dioxide absorbent canister	Absorbent capacity: 1500 mL
Integrated expiratory limb water trap	Capacity: 6 mL

#### Breathing Circuit Parameters

System leakage	≤ 60 mL/min at 3 kPa
Compliance	≤ 4 mL/100Pa (Manual mode) Automatically compensates for compression losses within the breathing circuit in mechanical mode
Expiration resistance	< 6.0 cm H <sub>2</sub> O @60 L/min
Inspiration resistance	< 6.0 cm H <sub>2</sub> O @60 L/min

### System Pressure Gauge

Range	-20 ~ 100 cmH <sub>2</sub> O
Accuracy	± (2% of the full scale reading + 4% of the actual reading)

### Ports and Connectors

Exhalation	22 mm OD / 15 mm ID conical
Inhalation	22 mm OD /15 mm ID conical
Manual bag port	22 mm OD /15 mm ID conical

### Bag-to-Ventilator Switch

Type	Bi-stable
Control	Switch between manual and mechanical ventilation

### Integrated Adjustable Pressure Limiting (APL) Valve

Range	SP, 5 ~ 70 cmH <sub>2</sub> O
Tactile knob indication at	above 30 cmH <sub>2</sub> O
Accuracy	± 3 cmH <sub>2</sub> O or ± 15% of the setting value, which is greater, but is not more than + 10 cmH <sub>2</sub> O

### Anesthetic Gas Scavenging System (AGSS)

Size (H x W x D)	430 x 132 x 114 mm
Type of disposal system	Active: High-flow or Low-flow Passive
Applicable standard	ISO 80601-2-13
Pump rate	75 ~ 105 L/min (High-flow) 25 ~ 50 L/min (Low-flow)

Pressure relief device: Pressure compensation opening to the air  
State indication of the disposal system: The float falls below the "MIN" mark on the sight glass when the disposal system does not work or the pump rate is lower than 25 L/min (Low-flow) or 75 L/min (high-flow).  
Connector of the disposal system: ISO 9170-2

### Materials

All materials in contact with exhaled patient gases are autoclavable, except flow sensors (being not capable of being autoclaved), O<sub>2</sub> sensor, and mechanical pressure gauge.  
All materials in contact with patient gas are latex free.

### Suction Device

#### Venturi Suction Regulator

Gas source	Air, from system gas source
Minimum flow	20 L/min
Maximum vacuum	≥72 kPa at supply gas pressure of 280 kPa; ≥73 kPa at supply gas pressure of 600 kPa

#### Continuous Suction Regulator

Supply	Negative Pressure Suction
Maximum vacuum	517.5 mmHg to 540 mmHg (69 kPa to 72 kPa) with external vacuum applied of 540 mmHg and 40 L/min free flow
Maximum flow	39 L/min to 40 L/min with external vacuum applied of 540mmHg and 40 L/min free flow
Minimum flow	20 L/min

-----  
Please contact your local Mindray sales representative for the most current information.

[www.mindray.com](http://www.mindray.com)

P/N: ENG-WATO EX-65 Pro datasheet-210285X4P-20210330

©2021 Shenzhen Mindray Bio-Medical Electronics Co.,Ltd. All rights reserved.

**mindray**  
healthcare within reach

**WATO EX-65 Pro**

**Anesthesia System**

**Operator's Manual**





© 2021 Shenzhen Mindray Bio-Medical Electronics Co., Ltd. All rights Reserved. For this Operator's Manual, the issue date is March, 2021.

---

## 2.2 Equipment Appearance

The anesthesia system can be configured with two types of breathing systems. Anesthesia system with breathing system compatible with Pre-Pak and anesthesia system with breathing system not compatible with Pre-Pak are defined here.

### 2.2.1 Front View

#### — Display and control panel

Anesthesia system with breathing system compatible with Pre-Pak:

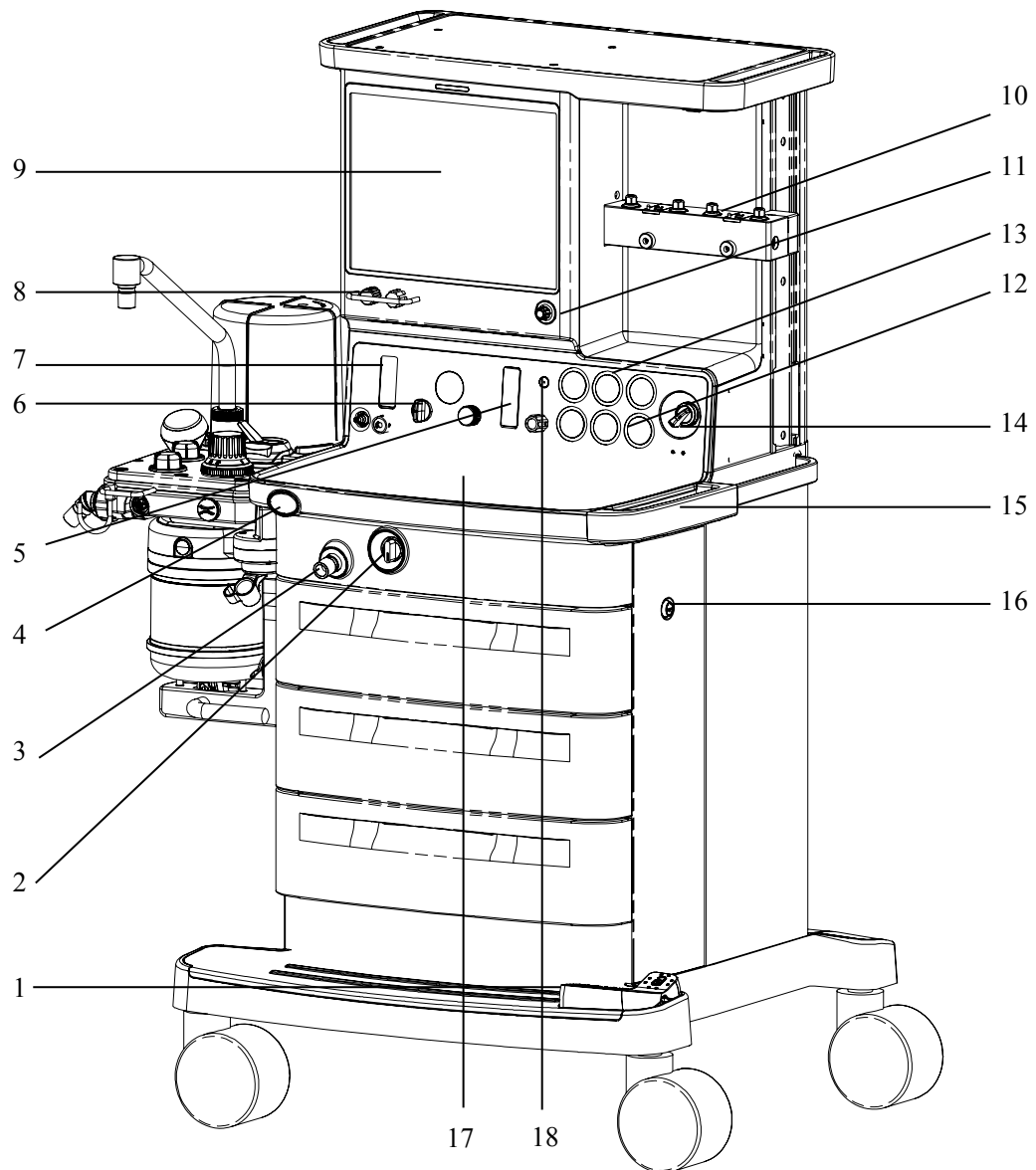

---

Anesthesia system with breathing system not compatible with Pre-Pak:

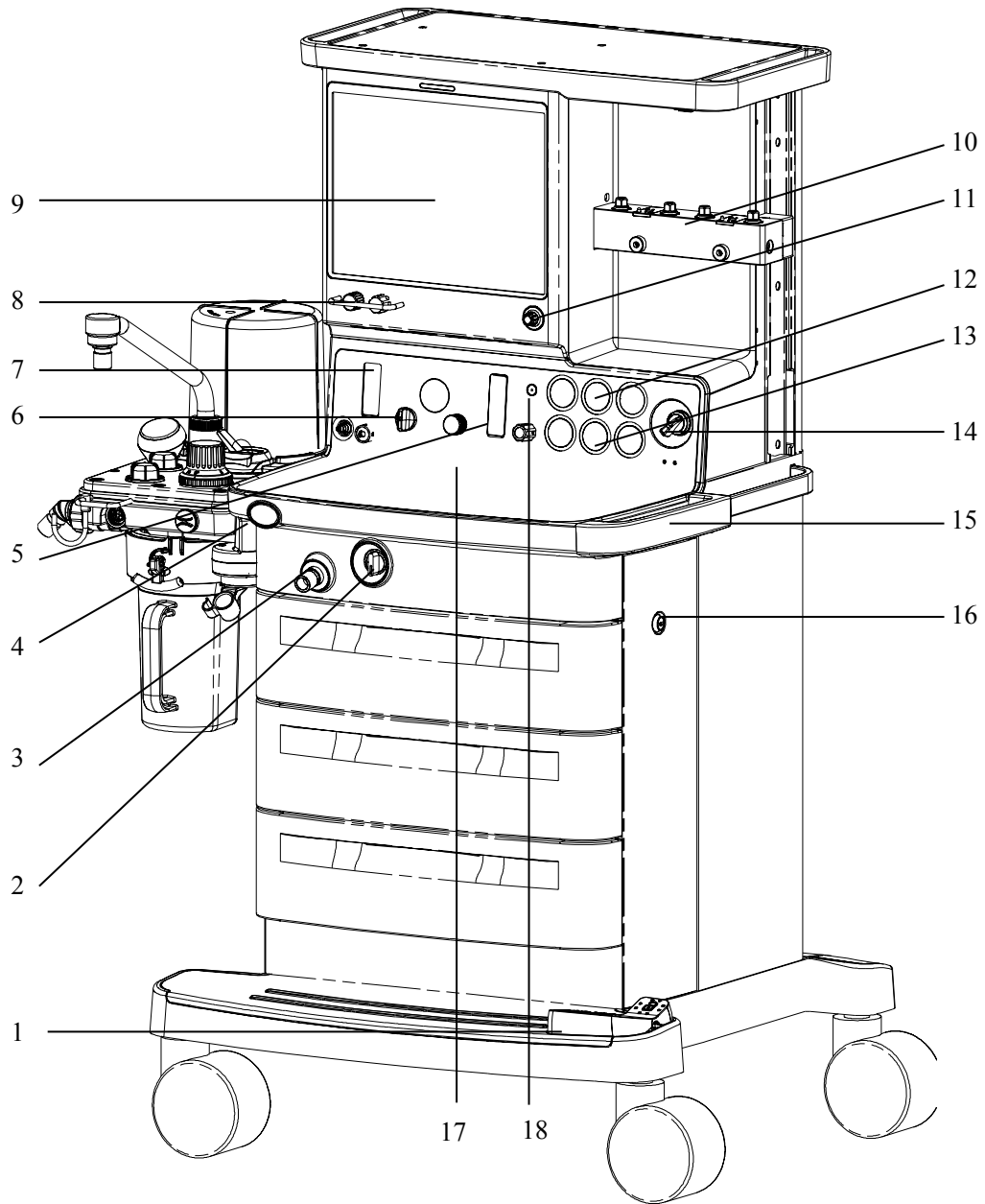

1. Brake
2. ACGO (Auxiliary Common Gas Outlet) switch



- ◆ Set the switch to the  position to stop mechanical ventilation. Then, fresh gas is sent to the externally connected manual breathing system through the ACGO. The system monitors airway pressure and O<sub>2</sub> concentration instead of volume.

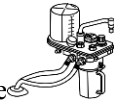

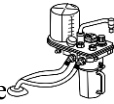
- ◆ Set the switch to the  position to apply mechanical or manual ventilation to the patient through the breathing system.

3. ACGO separate outlet
4. O<sub>2</sub> flush button

Push **O<sub>2</sub>+** to supply high flows of O<sub>2</sub> to the breathing system.

5. Total flowmeter

The middle of the float in the flow tube indicates the current flow of the mixed gas.

6. Negative pressure suction control panel

7. Auxiliary flowmeter/High-flow nasal cannula oxygen (HFNC)

The middle of the float in the flow tube indicates the current flow of auxiliary O<sub>2</sub> supply or high flow O<sub>2</sub> supply.

The flow control of the flowmeter controls the flow as follows:

- ◆ Turn the control counterclockwise to increase the gas flow.
- ◆ Turn the control clockwise to decrease the gas flow.

8. Flow control (s)

When the system switch is set to the ON position:

- ◆ Turn the control counterclockwise to increase the gas flow.
- ◆ Turn the control clockwise to decrease the gas flow.

9. Display

10. Vaporizer V60

A. Concentration control

Push the button and turn the concentration control to set the concentration of anesthetic agent.

B. Locking lever

Turn the locking lever clockwise to lock the vaporizer in position.

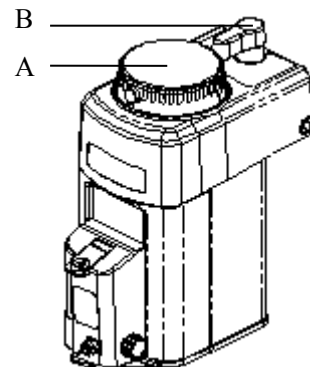

11. Control knob

# 3 System Controls and Basic Settings

## 3.1 Display Control

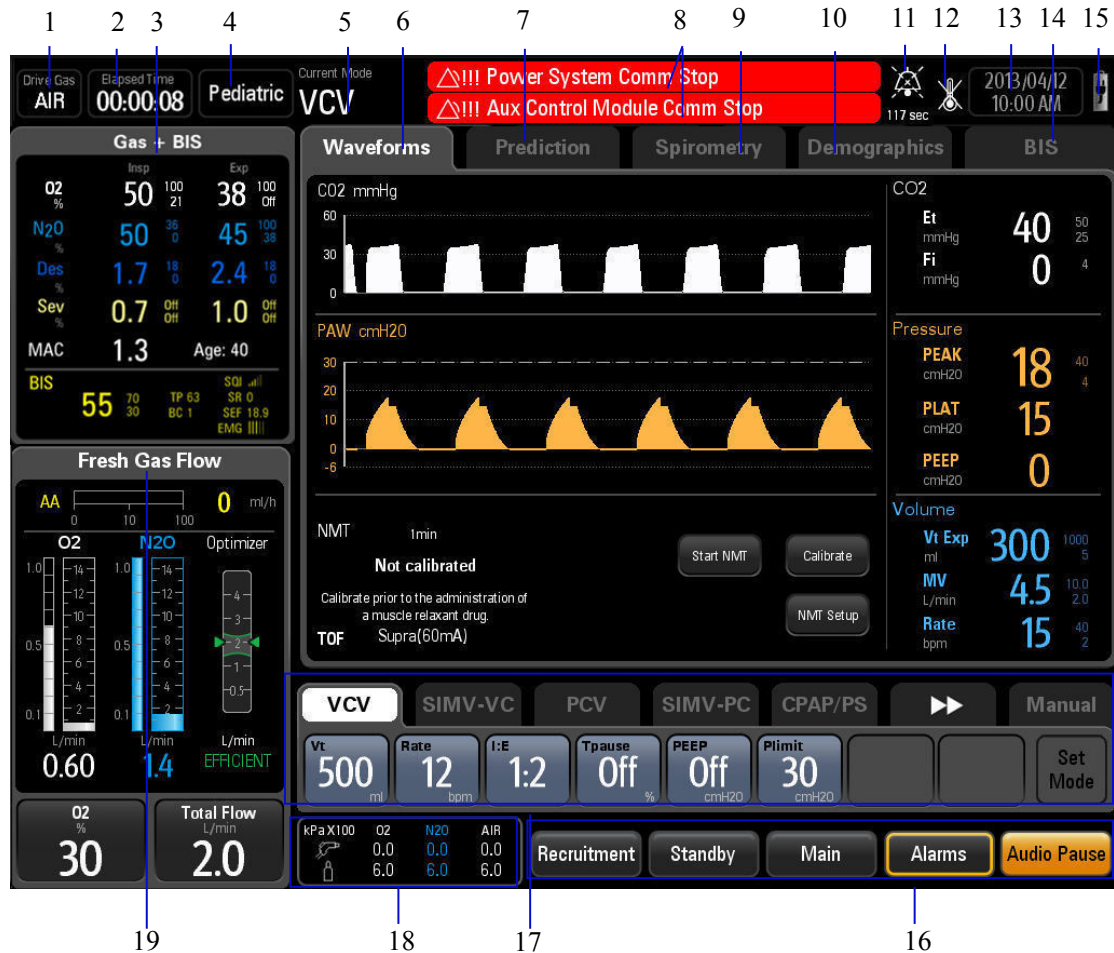

1. Drive Gas  
Displayed if configured with Drive Gas Auto Switch function. It displays current drive gas type. When the primary drive gas pressure is low and the temporary drive gas pressure is normal, select [Yes] from the pop-up dialog box to switch to the temporary drive gas. When the primary drive gas pressure resumes, select [Yes] from the pop-up dialog box to switch to the primary drive gas. When the area displays the temporary drive gas or the primary drive gas pressure is low, you can select the area to open the [Drive Gas] menu and set the drive gas in the menu.
2. Elapsed Timer  
Displays elapsed time. Select to start, stop, or reset the timer.
3. Gas and/or BIS Area  
Displayed when AG module and/or BIS module is connected. It displays real-time inspiratory and expiratory levels of gas concentration.

---

## 4.4 Input Fresh Gas

### 4.4.1 Set O<sub>2</sub>, N<sub>2</sub>O and Air Inputs

Safety systems within the anesthesia system work to prevent hypoxic mixtures from being delivered to the patient. Nitrous oxide will not be delivered unless oxygen flow is present.

All units are designed to maintain a safe O<sub>2</sub>:N<sub>2</sub>O ratio by allowing nitrous oxide to be set to a flow rate that is proportional to a previously adjusted flow of oxygen. The N<sub>2</sub>O flow is limited by the flow of O<sub>2</sub> so that a safe ratio of no less than 25% oxygen can be maintained.

1. Connect the gas supplies correctly and ensure adequate gas pressure.
2. Set the O<sub>2</sub> and balance gas through EFCS or set the O<sub>2</sub> flow through BFCS.

#### NOTE

---

- **This anesthesia system can be used alone as a ventilator. You can adjust O<sub>2</sub> concentration in the breathing system through the O<sub>2</sub> flow control.**
  - **The O<sub>2</sub> concentration in the fresh gas may be quite different from that in the breathing system.**
  - **The total flowmeter is calibrated based on 100% O<sub>2</sub>. The accuracy of the flowmeter may degrade with other gas or mixed gas.**
  - **When viewing the readings on the total flowmeter, keep your visual angle at the same level as the level of the float. The reading of a same scale may vary when viewed at a different angle.**
  - **If the readings shown on the electronic flowmeters differ from that on the total flowmeter, the former shall prevail and the latter is an approximate value.**
- 

### 4.4.2 Set Anesthetic Agent

#### NOTE

---

- **You do not need to perform this operation if inspiratory anesthetic agent is not used.**
  - **This anesthesia system can be mounted with vaporizers corresponding with Halothane, Enflurane, Isoflurane, Sevoflurane and Desflurane. Only one of the two mounted vaporizers can be opened at a time because the vaporizers are featured with interlock.**
-

---

## 5.5 Gas Monitoring

### 5.5.1 Display Gas Parameter

The gas monitored parameter group consists of the following parameters (available with the AG module):

- Fraction of inspired carbon dioxide and End-tidal carbon dioxide (FiCO<sub>2</sub> and EtCO<sub>2</sub>)
- Fraction of inspired oxygen and End-tidal oxygen (FiO<sub>2</sub> and EtO<sub>2</sub>)
- Fraction of inspired nitrous oxide and End-tidal nitrous oxide (FiN<sub>2</sub>O and EtN<sub>2</sub>O)
- Fraction of inspired anesthetic agent and End-tidal anesthetic agent (FiAA and EtAA, AA stands for anesthetic agent)
- Minimum alveolar concentration (MAC)
- Age

The gas monitored parameter group consists of the following parameters (available with the CO<sub>2</sub> module):

- Fraction of inspired carbon dioxide and End-tidal carbon dioxide (FiCO<sub>2</sub> and EtCO<sub>2</sub>)
- Breath rate (Rate) (display only when the system is in the ACGO or Monitor mode)

If the parameter data is out of range, it is displayed as ---.

#### NOTE

- 
- **The high alarm limit is displayed to the top right of the reading. The low alarm limit is displayed to the bottom right of the reading.**
- 

### 5.5.2 Display Gas Waveform



The Y-axis of the CO<sub>2</sub> vs. Time waveform is labeled CO<sub>2</sub>. The unit of measure is mmHg, kPa, or %. You can adjust the scales of the Y-axis.

---

## 6.4 Leak and Compliance Tests

### 6.4.1 Automatic Circuit Leak and Compliance Test

#### NOTE

---

- The system records the result of the last **Automatic Circuit Leak & Compliance Test** in the [General] tab, including if the test had passed, failed, or was skipped. To access this information, from the main screen, select the [Main] softkey → [General] tab.
  - If fresh gas is detected by the system before proceeding with the **Automatic Circuit Leak & Compliance Test**, a [Fresh gas flow detected! Adjust all flowmeters to zero].
- 

1. Start to test.

- From power up:

If the System is being powered on, the system automatically initiates a system self-test. The system self-test includes the **Automatic Circuit Leak & Compliance Test**.

- From the main screen:

Select the [Main] softkey → [General] tab → [Test Leak/Compliance] button.

2. Follow the instructions on the screen:

- (1) Seal the Y-piece.
- (2) Ensure that the sample line port of the breathing circuit is occluded.
- (3) Ensure the vaporizers are locked and closed.
- (4) (If mechanical ACGO is configured) Turn off the ACGO switch.
- (5) Set the Auto/Manual switch to the  position

Select [Continue] button to proceed with the Automatic Circuit Leak Test.

#### NOTE

---

- The [Continue] button can be selected only when the Auto/Manual switch is set to the  position and when no fresh gas is detected.
- 

3. Proceed to operate based on the self-test results.

---

## 6.4.2 Manual Circuit Leak Test

### NOTE

---

- If fresh gas is detected by the system before proceeding with the **Manual Circuit Leak Test**, a **[Fresh gas flow detected! Adjust all flowmeters to zero]** message is displayed on the screen.
- 

1. Start to test.

- From power up:

If the System is being powered on, the system automatically initiates a system self-test. The system self-test includes the **Manual Circuit Leak Test**.

- From the main screen:

Select the **[Main]** softkey → **[General]** tab → **[Test Leak/Compliance]** button.

2. Follow the instructions on the screen:

- (1) Adjust the **APL** to the 50 cmH<sub>2</sub>O position.
- (2) Install the manual bag.

- (3) Set the Auto/Manual switch to the  position.

Select **[Continue]** button to proceed with the **Manual Circuit Leak Test**.

Or,

Select **[Skip]** button to go directly to operational mode.

### NOTE

---

- The **[Continue]** button can be selected only when the Auto/Manual switch is set to the  position and when no fresh gas is detected.
- 

3. Proceed to operate based on the self-test results.

# 12 Alarms

---

---

## 12.1 Introduction

Alarms, triggered by a vital sign that appears abnormal or by technical problems of the anesthesia system, are indicated to the user by visual and audible alarm indications.

### NOTE

---

- **The System performs a self-test of its alarm system when powered on. The self-test includes the alarm LED and speaker. During the self-test, the alarm LED will illuminate in sequence the colors red, yellow, and cyan for approximately 1 second each color. The system speaker will produce one tone after the alarm light is in self-test.**
  - **If the equipment power failure lasts for not more than 60 s, the alarm settings prior to the power failure are restored when the equipment is powered on again.**
  - **The auditory alarm signal A-weighted sound pressure level is within 45 to 85 dB.**
  - **When multiple alarms of different levels occur simultaneously, the anesthesia system will select the alarm of the highest level and give visual and audible alarm indications accordingly.**
  - **When multiple alarms of same levels occur simultaneously, the alarm messages are displayed in order of time of occurrence.**
- 

### 12.1.1 Types of Alarms and Messages

By nature, the anesthesia system's alarms fall into three categories: physiological alarms, technical alarms and prompt messages.

#### 1. Physiological alarms

Physiological alarms, also called patient status alarms, are triggered by a monitored parameter value that violates set alarm limits or an abnormal patient condition.

Physiological alarm messages are displayed in the physiological alarm area.

#### 2. Technical alarms

Technical alarms, also called system status alarms, are triggered by a device malfunction or a patient data distortion due to proper operation or mechanical problems. Technical alarm messages are displayed in the technical alarm area.







#### 3. Prompt messages

As a matter of fact, prompt messages are not alarm messages. Apart from the physiological and technical alarm messages, the anesthesia system will show some messages telling the system status. Messages of this kind are included into the prompt message category and usually displayed in the prompt message area.

## 12.1.2 Alarm Indicators

The system provides the following alarm indicators:

- **An alarm LED located on top of the LCD monitor.** The LED can illuminate red, yellow, cyan, or OFF depending on the alarm condition. The following table describes the alarm behavior of different alarm types and different alarm priority labels. If multiple alarms occur simultaneously, the audio and LED behavior will follow the highest priority active alarm.
- **Colored alarm messages displayed on the Main Screen.** High priority messages are red. Medium priority messages are yellow. Low priority messages are cyan. Prompt messages are white. Messages are displayed according to priority and time.
- **Alarm audio through the system alarm speaker.** The following table lists the audio behavior for each type of alarm.

Alarm Type	Alarm Priority	Audio Behavior	Message Behavior	Alarm LED Color
Physiological Alarm	High	Play high priority alarm sound file, the interval between each play is $5 \pm 1$ s.	White text red background, high priority icon  .	Red
	Medium	Play medium priority alarm sound file, the interval between each play is $5 \pm 1$ s.	Black text yellow background, medium priority icon  .	Yellow
	Low	Play low priority alarm sound file, the interval between each play is $17 \pm 1$ s.	White text cyan background, low priority icon  .	Cyan
Technical Alarm	High	Play high priority alarm sound file, the interval between each play is $5 \pm 1$ s.	White text red background, high priority icon  .	Red
	Medium	Play medium priority alarm sound file, the interval between each play is $5 \pm 1$ s.	Black text yellow background, medium priority icon  .	Yellow
	Low	Play low priority alarm sound file, the interval between each play is $17 \pm 1$ s.	White text cyan background, low priority icon  .	Cyan
Prompt Message	None	None	Black text white background	Off

---

## 12.2 Display Alarms

On the LCD monitor screen, alarm messages are automatically displayed at the top area of the Main Screen when alarm conditions occur. Additionally, a list of all active alarms and an alarm log can be found in the **[Alarms]** window.

Each message is displayed with an associated priority symbol as follows:

- High priority:     △!!!
- Medium priority:  △!!
- Low priority:     △!

To display a list of all active alarms:

1. On the Main Screen, select the **[Alarms]** softkey or touch the Alarm Message area at the top of the screen.

The **[Alarms]** window is displayed.

2. Select the **[Active]** tab.

A list of all active alarm messages is displayed. Alarms are displayed in order of priority and time.

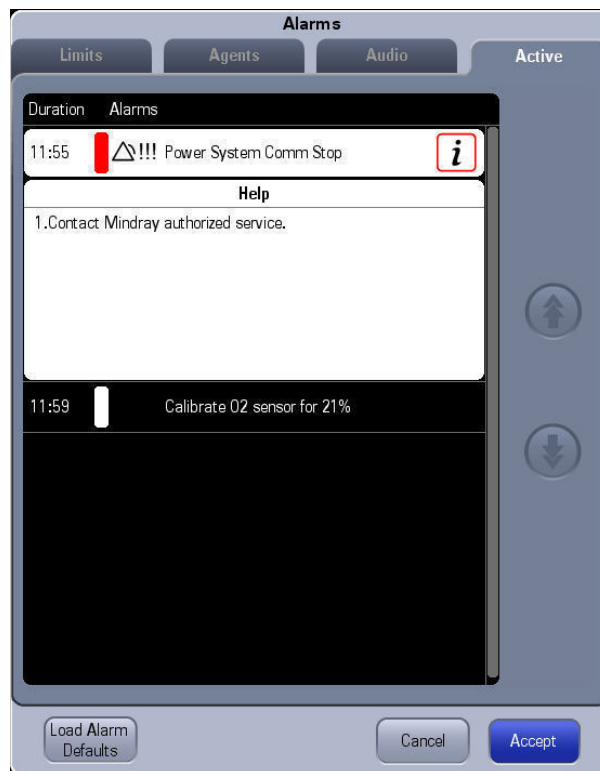

---

## NOTE

---

- Only high priority alarms offer help information.
  - Active alarms are ordered by alarm priority and time. The most recent and highest alarm is shown first.
- 

## 12.3 Displayed Order of Alarm Messages

Alarm messages are displayed in order of priority and time of occurrence. The alarm messages list divided into two areas.

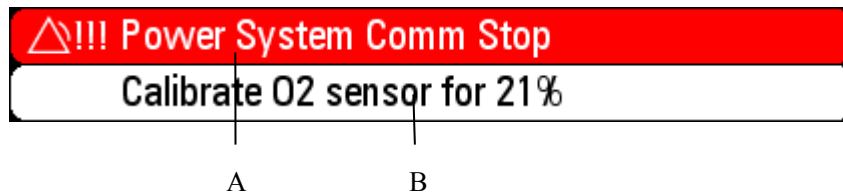

A: Area A (Highest priority and most recent alarm)

B: Area B (Less priority or less recent alarms)

- To be in Area A, an alarm must be both the highest priority and the most recent (Area A does not cycle). The remaining active alarms and prompt messages cycle in Area B.
- New Alarms with less priority than alarms in Area A are displayed immediately in Area B, and the cycle proceeds from that position in the list.
- Alarms cycling in Area B are grouped and displayed in the following order: high priority, medium priority, low priority, and prompt messages. In each group, the most recent alarm is displayed first.
- If the alarm in Area A is removed, then the most recent and highest priority alarm from Area B is moved to Area A.

## 12.4 Set Alarm Volume

Users can set the audio level of alarms and system alerts by selecting the [**Alarms**] softkey on the Main Screen to display the [**Alarms**] window.

The [**Alarms**] volume settings adjust the audio level of all high, medium, and low Priority sounding alarms. The [**System Alerts**] volume settings adjust the audio level of all sounding pop-up prompts and non-confirmed ventilation mode alerts.



To set the Alarm Volume:

1. On the Main Screen, select the [**Alarms**] softkey.

The [**Alarms**] window is displayed.

2. Select the [**Audio**] tab.

Volume controls for [**Alarms**] and [**System Alerts**] are displayed.

- 
3. Adjust the volume by selecting the  (increase) or  (decrease) buttons.
    - ◆ The Alarms volume has 10 levels of adjustment. Default level is 5.
    - ◆ The System Alerts volume has 10 levels of adjustment. Default level is 2.
  4. Select [**Accept**] button to activate your changes and exit the [**Alarms**] window.  
(Selecting [**Cancel**] button will discard your changes and exit the [**Alarms**] window.)

---

## **WARNING**

- **Do not rely exclusively on the audible alarm system when using the anesthesia system. Adjustment of alarm volume to a low level may result in a hazard to the patient. Always keep the patient under close surveillance.**

---

## 12.5 Set Alarm Limits

---

### **WARNING**

- **Set ALARM LIMITS to extreme values can render the ALARM SYSTEM useless.**

---



### **NOTE**

- **An alarm is triggered when the parameter value is higher than the [High Limit] or lower than the [Low Limit]. The background of this parameter flashes. Click the flashing parameter to open the [Alarms] menu, to set the alarm limit quickly.**
- **When using the anesthesia system, always keep an eye to whether the alarm limits of a specific parameter are set to the appropriate values.**
- **When the machine is powered on after system power is off, the configuration to be loaded should be determined according to the power off duration. If the power off duration is equal to or longer than 120 seconds then the user default configurations should be loaded into Current configurations. If the power off duration is equal to or shorter than 60 seconds then the latest configurations should be loaded into the Current configurations. When the anesthesia system is powered on 60 seconds to 120 seconds after the previous power-off, either the latest current configuration or the user default configuration may be loaded. This is unspecified due to precision error of power-off duration saved in the system.**

---

## 12.5.1 Set Ventilator Alarm Limits

Users can set the alarm limits of Paw, MV, Vt Exp, Rate, FiO<sub>2</sub>, EtO<sub>2</sub>, FiN<sub>2</sub>O, EtN<sub>2</sub>O, FiCO<sub>2</sub> and EtCO<sub>2</sub> to create alarm conditions consistent with patient needs. The alarm is then triggered when the parameter value is greater than the High Limit or lesser than the Low Limit.

1. On the Main Screen, select the [**Alarms**] softkey.  
The [**Alarms**] window is displayed.
2. Select the [**Limits**] tab or [**Agents**] tab.
3. Select a parameter softkey. The softkey is highlighted when selected.
4. Use the on-screen keypad to enter the desired parameter value, or press down the   
or  button to increase or decrease the parameter value, or turn the control knob to set the value. For each parameter, the range of values is displayed above the keypad.
5. Optionally, to restore the default values, select the [**Load Alarm Defaults**] button. This restores the high and low values for the parameters to the user default values.
6. Repeat Steps 3 and 4 for each parameter value.
7. Select [**Accept**] button to save the change (or select [**Cancel**] button to not save).

## 12.5.2 Set CO<sub>2</sub> Alarm Limits

1. On the Main Screen, select the [**Alarms**] softkey → [**Limits**] tab.
2. Set [**High Limit**] and [**Low Limit**] respectively for each parameter.
3. Select [**Accept**] button to save the change (or select [**Cancel**] button to not save).

## 12.5.3 Set AG Alarm Limits

1. On the Main Screen, select the [**Alarms**] softkey → [**Agent**] tab.
2. Set [**High**] and [**Low**] respectively for each parameter.
3. Select [**Accept**] button to save the change (or select [**Cancel**] button to not save).

---

## 12.5.4 Set BIS Alarm Limits

1. On the Main Screen, select the [**Alarms**] softkey → [**BIS**] tab.
2. Set [**High**] and [**Low**] respectively for each parameter.
3. Select [**Accept**] button to save the change (or select [**Cancel**] button to not save).

## 12.5.5 Auto Alarm Limits

The Auto Alarm Limits function uses an algorithm based on measured values. The relationship is shown in the table below.

The [**Auto Alarm Limits**] button is disabled when the system is in Standby mode, Manual mode or Monitor mode. The [**Auto Alarm Limits**] button is also disabled when the current mode is PS, SIMV-VC, or SIMV-PC.

Alarm Limit	Adjust Formula
Paw High	PEAK+5 or PLAT+10, whichever is greater minimum 35 cmH <sub>2</sub> O
Paw Low	(PLAT-PEEP) × 0.6 + PEEP - 1 minimum 3 cmH <sub>2</sub> O maximum Paw High - 1
MV High	MV × 1.4 minimum 2.0 L/min
MV Low	MV × 0.6 minimum 0.3 L/min maximum MV High - 0.1
Vt Exp High	Vt Exp × 1.4 maximum 1600 mL
Vt Exp Low	Vt Exp × 0.6 minimum 0 mL
Rate High	Rate × 1.4 maximum 100 bpm
Rate Low	Rate × 0.6 minimum 2 bpm

---

The parameters in the formula are all measured parameters. The new alarm limits for Paw are calculated on the basis of average values for PEAK, PLAT, and PEEP. The value used for average uses the value of the last four ventilation cycles or the value in one minute, whichever is smaller. Spontaneous breaths by the patient are not taken into account.

If there is not a valid measured MV, the corresponding MV alarm limits will not be adjusted.

If the average value for PEAK, PLAT, and PEEP cannot be calculated, the corresponding alarm limits will not be adjusted.

If the calculated alarm limit is more than the high threshold of setting range or less than the low threshold, the corresponding threshold is used as the auto alarm limit.

## 12.6 Alarm Audio Pause

### 12.6.1 Set Alarm Audio Pause

When an alarm condition occurs and the alarm audio is heard, the user can select the [**Audio Pause**] softkey to pause the alarm audio. In audio paused status, all the alarm indicators work normally except audible alarm tones.

Select [**Audio Pause**] softkey to pause all currently sounding alarm tones. The icon on the

left of the alarm message changes to . It indicates the alarm audio has been paused. The

alarm audio pause icon  and 120 s countdown time appear at the top of the screen.

### NOTE

- 
- **The alarm audio will be heard, if an alarm condition occurs when the system is in an audio-off state. Select [Audio Pause] softkey, the new alarm tone will be paused for 120 s.**
  - **When the 120 s countdown time is up, the 120 s alarm audio paused status will be finished and audible alarm tones restored.**
-

---

## 12.6.2 Cancel Alarm Audio Pause

In the alarm audio paused status, pressing [**Audio Pause**] softkey or triggering a new alarm will finish the current paused status and restore audible alarm tones. Besides, the alarm audio

pause icon  and 120 s countdown time will disappear from the upper right corner of the screen.

## 12.7 When an Alarm Occurs

When an alarm occurs, do as follows:

1. Check the patient's condition.
2. Determine the alarming parameter or alarm category.
3. Identify the alarm source.
4. Take proper actions to eliminate the alarm condition.
5. Ensure the alarm condition is corrected.

For details about how to troubleshoot alarms, refer to *D Alarm and Prompt Messages*.

1	Bellows housing	12	Leak test plug
2	Bag arm	13	Expiration connector
3	Auto/Manual switch	14	Inspiration connector
4	APL valve	15	Water collection cup
5	Inspiratory check valve	16	Drive gas connector
6	Expiratory check valve	17	Guide pin hole
7	O <sub>2</sub> sensor	18	Locking catch retainer
8	Hook	19	Pressure sampling connector
9	CO <sub>2</sub> absorbent canister	20	APL valve gas outlet
10	Handle for CO <sub>2</sub> absorbent canister	21	Fresh gas inlet
11	Airway pressure gauge	22	ACGO connector

### 13.1.1.2 Circuit Adapter Diagram

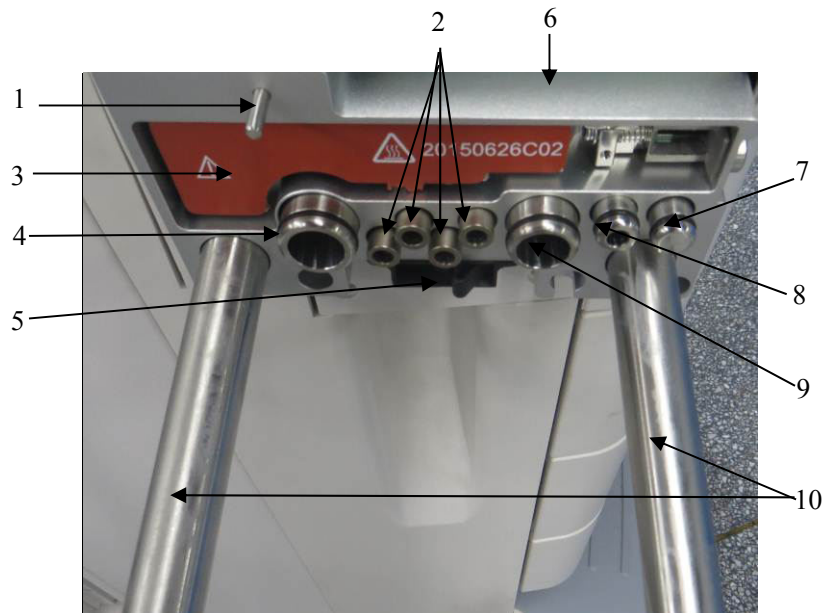

1	Auto/Manual ventilation linked switch	6	Circuit adapter base
2	Pressure sampling connector	7	ACGO connector
3	Heating module	8	Fresh gas inlet
4	Drive gas connector	9	APL valve gas outlet
5	Circuit switch	10	Circuit support guide

### NOTE

- The heating module does not work when the anesthesia system is battery powered.
- Do not overbear the bag arm, such as depressing it forcibly or hanging heavy objects onto it.
- When the difference between the reading on the airway pressure gauge and the Paw value displayed on the screen is great, please contact us.

---

### 13.1.1.3 Install the Breathing system

1. Align the guide pin holes on the circuit block with the matching guide pins on the circuit adapter.

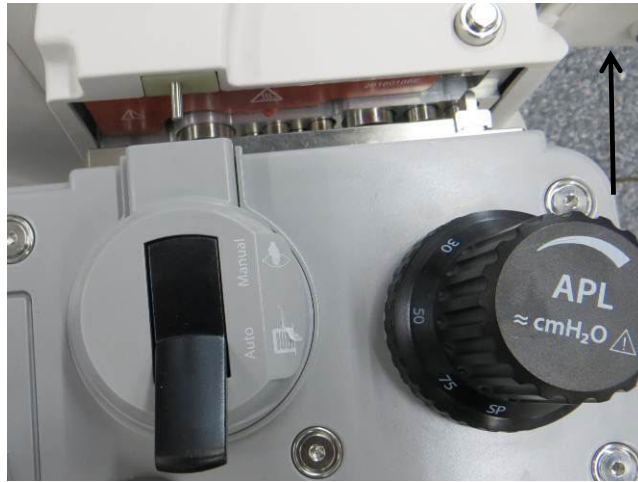

2. Push the breathing system into the circuit adapter with force to allow the breathing system to be connected to the adapter seamlessly.



3. Lock the breathing system. Refer to *13.1.1.8 Install the CO<sub>2</sub> Absorbent Canister* for operation steps. The process of installing the CO<sub>2</sub> absorbent canister is the process of locking the breathing system.

---

### WARNING

- After the breathing system is installed onto the circuit adapter, ensure that the breathing system is firmly locked. If not, the breathing system will be disconnected from the circuit adapter during use, which can cause serious fresh gas leak and inaccurate tidal volume measurement.
-

AGSS receiving hosing, (35G-WAGD-DS/FG2-3), from AGSS assembly to vacuum system	082-001372-00
AGSS British-standard connection material kit	115-020745-00
AGSS kit, low flow, high vacuum	115-030332-00
AGSS kit, high flow, low vacuum	115-030333-00
AGSS Assembly, high-flow, low vacuum	115-017375-00
AGSS Assembly, low-flow, high vacuum	115-017376-00
<b>Patient Monitor Bracket Assembly</b>	
Top shelf mounting kit for Beneview T5	115-004004-00
Top shelf mounting kit for Beneview T8	115-004003-00
GCX bracket kit for monitor PM7000, 8000	115-015769-00
GCX bracket kit for Beneview T5, PM 9000	115-015770-00
GCX bracket kit for Beneview T8	115-015783-00
GCX bracket kit for Beneview T5, with module rack mounting pole	115-015771-00
GCX bracket kit for Beneview T8, with module rack mounting pole	115-015784-00
GCX bracket kit for iMEC, iPM	115-015786-00
GCX Bracket for N12/15/17/ePM15, fixed height	115-066028-00
GCX Bracket for N12/15/17, variable	115-066029-00
GCX Bracket for ePM10/12/uMEC, fixed height	115-070011-00
GCX Bracket for ePM10/12/uMEC, variable height	115-070768-00
Top shelf mounting kit for N15/17	115-070794-00
Top shelf mounting kit for N12	115-074073-00
GCX external auxiliary work surface	115-073384-00
Flexible bag arm assembly	115-048035-00
<b>Gas Source Hose</b>	
O2 supply hose, British standard, NIST, 5m, 34I-OXY-BS/NS-5	082-001209-00
Air supply hose, British standard, NIST, 5m, 34I-AIR-BS/NS-5	082-001210-00
N2O supply hose, British standard, NIST, 5m, 34I-N2O-BS/NS-5	082-001211-00
O2 supply hose, Germany standard, NIST, 5m, 34I-OXY-GS/NS-5	082-001212-00
Air supply hose, Germany standard, NIST, 5m, 34I-AIR-GS/NS-5	082-001213-00
N2O supply hose, Germany standard, NIST, 5m, 34I-N2O-GS/NS-5	082-001214-00
O2 supply hose, Australian standard, NIST, 5m, 34I-OXY-SIS/NS-5	082-001215-00
Air supply hose, Australian standard, NIST, 5m, 34I-AIR-SIS/NS-5	082-001216-00
N2O supply hose, Australian standard, NIST, 5m, 34I-N2O-SIS/NS-5	082-001217-00
O2 supply hose, French standard, NIST, 5m, 34I-OXY-FS/NS-5	082-001218-00
Air supply hose, French standard, NIST, 5m, 34I-AIR-FS/NS-5	082-001219-00
N2O supply hose, French standard, NIST, 5m, 34I-N2O-FS/NS-5	082-001220-00
O2 supply hose, US standard, DISS, 5m, 34U-OXY-DS/DS-5	082-003443-00
N2O supply hose, US standard, DISS, 5m, 34U-N2O-DS/DS-5	082-003444-00
Air supply hose, US standard, DISS, 5m, 34U-AIR-DS/DS-5	082-003445-00
O2 supply hose, British Standard, DISS, 5m, 34U-OXY-BS/DS-5	082-001227-00
Air supply hose, British Standard, DISS, 5m, 34U-AIR-BS/DS-5	082-001228-00

Alarm settings			
Parameter		Setting range	Remark
FiO <sub>2</sub>	High Limit	OFF, 20 to 100 %	The specified high limit shall be 2% greater than the low limit.
	Low Limit	18 to 98 %	
V <sub>t</sub>	High Limit	5 to 1600 mL	The specified high limit shall be 5 mL greater than the low limit.
	Low Limit	0 to 1595mL	
MV	High Limit	0.2 to 100L/min	When the alarm setting range is 0 to 15L/min, the specified high limit shall be 0.2 L/min greater than the low limit. When the alarm setting range is 15 to 100L/min, the specified high limit shall be 1 L/min greater than the low limit.
	Low Limit	0 to 99L/min	
Rate	High Limit	4 to 100 bpm	The specified high limit shall be 2 bpm greater than the low limit.
	Low Limit	2 to 98 bpm	
Paw	High Limit	2 to 100 cmH <sub>2</sub> O	The specified high limit shall be 2 cmH <sub>2</sub> O greater than the low limit.
	Low Limit	0 to 98cmH <sub>2</sub> O	

## B.10 Anesthetic Vaporizer

Anesthetic vaporizer (for details, refer to the vaporizer Instructions for Use)	
Type	Penlon Sigma Delta anesthetic vaporizers. Four types of vaporizers with anesthetic agents halothane, enflurane, isoflurane, sevoflurane are available. Mindray-made V60 vaporizer. Four types of anesthetic agents are optional, which are Enflurane, isofluane, halothane, and sevoflurane. Drager D-Vapor Desflurane vaporizer
Selectatec® vaporizer manifold	
Vaporizer position	Single or double vaporizer positions (optional)
Mounting mode	Selectatec®, with interlocking function (Selectatec® is registered trademark of Datex-Ohmeda Inc.)
Plug-in® vaporizer manifold	
Vaporizer position	double vaporizer positions
Mounting mode	Plug-in ®, with interlocking function

# D Alarm and Prompt Messages

---

This chapter lists physiological and technical alarm messages, and prompt message.

For each alarm message, corresponding actions are given instructing you to troubleshoot problems. If the problem persists, contact your service personnel.

## D.1 Physiological Alarm Messages

### NOTE

- The Disable in Manual and Cardiac Bypass mode column indicates how this alarm is controlled by the alarm on/off button and the cardiac bypass mode button in manual mode.
- The Disable in Standby mode column indicates which physiological alarms will be disabled automatically in Standby mode.

### D.1.1 VCM Physiological Alarm List

Message	Alarm Priority	Cause	Disabled when Alarm is off	Disabled in Standby mode
Apnea	Medium	Two triggering conditions are met simultaneously: 1. Paw < (PEEP+3) cmH <sub>2</sub> O for more than 20 s. 2. Vt < 10 mL for more than 20 s.	Yes	N/A
Volume Apnea >2 min	High	No breath has been detected within the last 120 s.	Yes	N/A
Paw Too High	High	Paw ≥ high alarm limit setting.	No	N/A
Paw Too Low	High	Paw ≤ low alarm limit setting for 20 s.	Yes	N/A
Pressure Limiting	Low	Paw ≥ Plimit.	N/A	N/A
FiO <sub>2</sub> Too High	Medium	FiO <sub>2</sub> > high alarm limit setting.	No	N/A
FiO <sub>2</sub> Too Low	High	FiO <sub>2</sub> < low alarm limit setting.	No	N/A
Vt Too High	Medium	Vt > high alarm limit setting.	Yes	N/A

Vt Too Low	Medium	Vt < low alarm limit setting.	Yes	N/A
MV Too High	Medium	MV > high alarm limit setting.	Yes	N/A
MV Too Low	Medium	MV < low alarm limit setting.	Yes	N/A
Rate Too High	Low	Rate > high alarm limit setting.	Yes	N/A
Rate Too Low	Low	Rate < low alarm limit setting.	Yes	N/A
Continuous Airway Pressure	High	Paw in the breathing circuit > sustained airway pressure alarm limit for 15 s.	No	N/A
Negative Pressure	High	Paw < -10 cmH <sub>2</sub> O for 1 second.	No	N/A

## D.1.2 AG Physiological Alarm List

Message	Alarm Priority	Cause	Disabled when Alarm is off	Disabled in Standby mode
EtCO <sub>2</sub> Too High	Medium	EtCO <sub>2</sub> > high alarm limit setting.	No	Yes
EtCO <sub>2</sub> Too Low	Medium	EtCO <sub>2</sub> < low alarm limit setting.	No	Yes
FiCO <sub>2</sub> Too High	Medium	FiCO <sub>2</sub> > high alarm limit setting.	No	Yes
EtN <sub>2</sub> O Too High	Medium	EtN <sub>2</sub> O > high alarm limit setting.	No	Yes
EtN <sub>2</sub> O Too Low	Medium	EtN <sub>2</sub> O < low alarm limit setting.	No	Yes
FiN <sub>2</sub> O Too Low	Medium	FiN <sub>2</sub> O > high alarm limit setting.	No	Yes
EtHal Too High	Medium	EtHAL > high alarm limit setting.	No	Yes
EtHal Too Low	Medium	EtHAL < low alarm limit setting.	No	Yes
FiHal Too High	Medium	FiHAL > high alarm limit setting.	No	Yes
FiHal Too Low	Medium	FiHAL < low alarm limit setting.	No	Yes
EtEnf Too High	Medium	EtENF > high alarm limit setting.	No	Yes
EtEnf Too Low	Medium	EtENF < low alarm limit setting.	No	Yes
FiEnf Too High	Medium	FiENF > high alarm limit setting.	No	Yes
FiEnf Too Low	Medium	FiENF < low alarm limit setting.	No	Yes
EtIso Too High	Medium	EtISO > high alarm limit setting.	No	Yes
EtIso Too Low	Medium	EtISO < low alarm limit setting.	No	Yes
FiIso Too High	Medium	FiIso > high alarm limit setting.	No	Yes
FiIso Too Low	Medium	FiIso < low alarm limit setting.	No	Yes
EtSev Too High	Medium	EtSev > high alarm limit setting.	No	Yes
EtSev Too Low	Medium	EtSev < low alarm limit setting.	No	Yes
FiSev Too High	Medium	FiSev > high alarm limit setting.	No	Yes

FiSev Too Low	Medium	FiSev < low alarm limit setting.	No	Yes
EtDes Too High	Medium	EtDes > high alarm limit setting.	No	Yes
EtDes Too Low	Medium	EtDes < low alarm limit setting.	No	Yes
FiDes Too High	Medium	FiDes > high alarm limit setting.	No	Yes
FiDes Too Low	Medium	FiDes < low alarm limit setting.	No	Yes
EtO <sub>2</sub> Too High	Medium	EtO <sub>2</sub> > high alarm limit setting.	No	Yes
EtO <sub>2</sub> Too Low	Medium	EtO <sub>2</sub> < low alarm limit setting.	No	Yes
FiO <sub>2</sub> Too High	Medium	FiO <sub>2</sub> > high alarm limit setting.	No	Yes
FiO <sub>2</sub> Too Low	Medium	FiO <sub>2</sub> < low alarm limit setting.	No	Yes
Apnea CO <sub>2</sub>	High	No breath is detected and Apnea time $\geq$ Apnea alarm time.	No	Yes
MAC Too High	Medium	MAC > high alarm limit setting.	No	Yes
MAC Too Low	Medium	MAC < low alarm limit setting.	No	Yes

### D.1.3 BIS Physiological Alarm List

Message	Alarm Priority	Cause	Disable when Alarm is off	Disabled in Standby mode
BIS Too High	Medium	BIS > high alarm limit setting.	No	Yes
BIS Too Low	Medium	BIS < low alarm limit setting.	No	Yes
BIS L Too High	Medium	BIS L > high alarm limit setting.	No	Yes
BIS L Too Low	Medium	BIS L < low alarm limit setting.	No	Yes
BIS R Too High	Medium	BIS R > high alarm limit setting.	No	Yes
BIS R Too Low	Medium	BIS R < low alarm limit setting.	No	Yes

### D.1.4 CO<sub>2</sub> Physiological Alarm List

Message	Alarm Priority	Cause	Disable when Alarm is off	Disabled in Standby mode
EtCO <sub>2</sub> Too High	Medium	EtCO <sub>2</sub> > high alarm limit setting.	No	Yes
EtCO <sub>2</sub> Too Low	Medium	EtCO <sub>2</sub> < low alarm limit setting.	No	Yes
FiCO <sub>2</sub> Too High	Medium	FiCO <sub>2</sub> > high alarm limit setting.	No	Yes
Apnea CO <sub>2</sub>	High	No breath is detected and Apnea time $\geq$ Apnea alarm time.	No	Yes

Flow	Adu: 5.0 s Ped: 2.7s Inf: 2.0s
------	--------------------------------------

### F.5.10 Manual

PARAMETER	FACTORY DEFAULT
Alarms	On
Bypass	Off
Monitor	Off
CO <sub>2</sub> Alarms	On

### F.5.11 Standby

OBJECT	PARAMETER	FACTORY DEFAULT
Standby Dialog	Restore default settings	Off

## F.6 Ventilation Parameter Relationships

VENTILATION MODE	PARAMETER	PARAMETER RELATIONSHIP EQUATION(S)
VCV	Rate	$Rate \leq 300 \times \frac{I:E}{1+I:E}$ $Rate \leq 150 \times \frac{1}{1+I:E}$ $2 \leq Rate \leq 100$
	Vt	$Vt \leq 1833 \times \frac{60 \times \left( \frac{I:E}{1+I:E} \right) * (1-TP)}{Rate}$ $Vt \geq 10 \times \frac{60 \times \left( \frac{I:E}{1+I:E} \right) (1-TP)}{Rate}$ $10 \leq Vt \leq 1500$
	Plimit	$Plimit \geq PEEP+5$ $10 \leq Plimit \leq 100$
SIMV-VC	Rate	$Rate \leq \frac{60}{T_{insp} + 0.4}$ $2 \leq Rate \leq 100$
	Vt	$10 \times T_{insp} (1-TP) \leq Vt \leq 1833 \times T_{insp} (1-TP)$ $10 \leq Vt \leq 1500$

	$\Delta P_{\text{supp}}$ (in VCV or PCV-VG mode)	$\Delta P_{\text{supp}} \leq P_{\text{limit}} - \text{PEEP}$ $3 \leq \Delta P_{\text{supp}} \leq 60$
	Plimit	$P_{\text{limit}} \geq \text{PEEP} + 5$ $P_{\text{limit}} \geq \Delta P_{\text{supp}} + \text{PEEP}$ $10 \leq P_{\text{limit}} \leq 100$
PCV	Rate	$\text{Rate} \leq 300 \times \frac{I : E}{1 + I : E}$ $\text{Rate} \leq 150 \times \frac{1}{1 + I : E}$ $2 \leq \text{Rate} \leq 100$
	Pinsp	$P_{\text{insp}} \geq \text{PEEP} + 5$ $5 \leq P_{\text{insp}} \leq 80$
SIMV-PC	Rate	$\text{Rate} \leq \frac{60}{T_{\text{insp}} + 0.4}$ $2 \leq \text{Rate} \leq 100$
	$\Delta P_{\text{supp}}$	$3 \leq \Delta P_{\text{supp}} \leq 60$
	Pinsp	$P_{\text{insp}} \geq \text{PEEP} + 5$ $5 \leq P_{\text{insp}} \leq 80$
SIMV-VG	Rate	$\text{Rate} \leq \frac{60}{T_{\text{insp}} + 0.4}$ $2 \leq \text{Rate} \leq 100$
	$\Delta P_{\text{supp}}$ (in VCV or PCV-VG mode)	$\Delta P_{\text{supp}} \leq P_{\text{limit}} - \text{PEEP}$ $3 \leq \Delta P_{\text{supp}} \leq 60$
	Plimit	$P_{\text{limit}} \geq \text{PEEP} + 5$ $P_{\text{limit}} \geq \Delta P_{\text{supp}} + \text{PEEP}$ $10 \leq P_{\text{limit}} \leq 100$
CPAP/PS	Min Rate	$0.2 \leq \frac{60}{\text{MinRate}} \times \frac{\text{Apnea I : E}}{1 + \text{Apnea I : E}} \leq \frac{60}{\text{MinRate}} - 0.5$
	Apnea I:E	$\frac{60}{\text{MinRate}} \times \frac{\text{Apnea I : E}}{1 + \text{Apnea I : E}} \leq 10$
	Apnea Ti	$\frac{60}{\text{MinRate}} - \text{Apnea Ti} \geq 0.5$
PCV-VG	Rate	$\text{Rate} \leq 300 \times \frac{I : E}{1 + I : E}$ $\text{Rate} \leq 150 \times \frac{1}{1 + I : E}$ $2 \leq \text{Rate} \leq 100$
	Plimit	$P_{\text{limit}} \geq \text{PEEP} + 5$ $10 \leq P_{\text{limit}} \leq 100$
APRV	Phigh	$P_{\text{high}} \geq P_{\text{low}} + 3 \text{ cmH}_2\text{O}$
	Plow	

# **V60 Anesthetic Vaporizer**

## **Operator's Manual**

---

© 2009-2016 Shenzhen Mindray Bio-Medical Electronics Co., Ltd. All rights Reserved.  
For this Operator's Manual, the issue date is September, 2016.

# 11 Theory of Operation

---

## 11.1 Operating Principle

The following image illustrates the operating principle of the vaporizer.

Control dial position above 0--Vaporizer switched on:

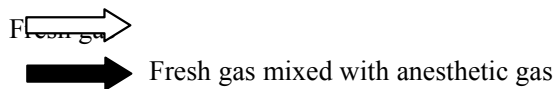
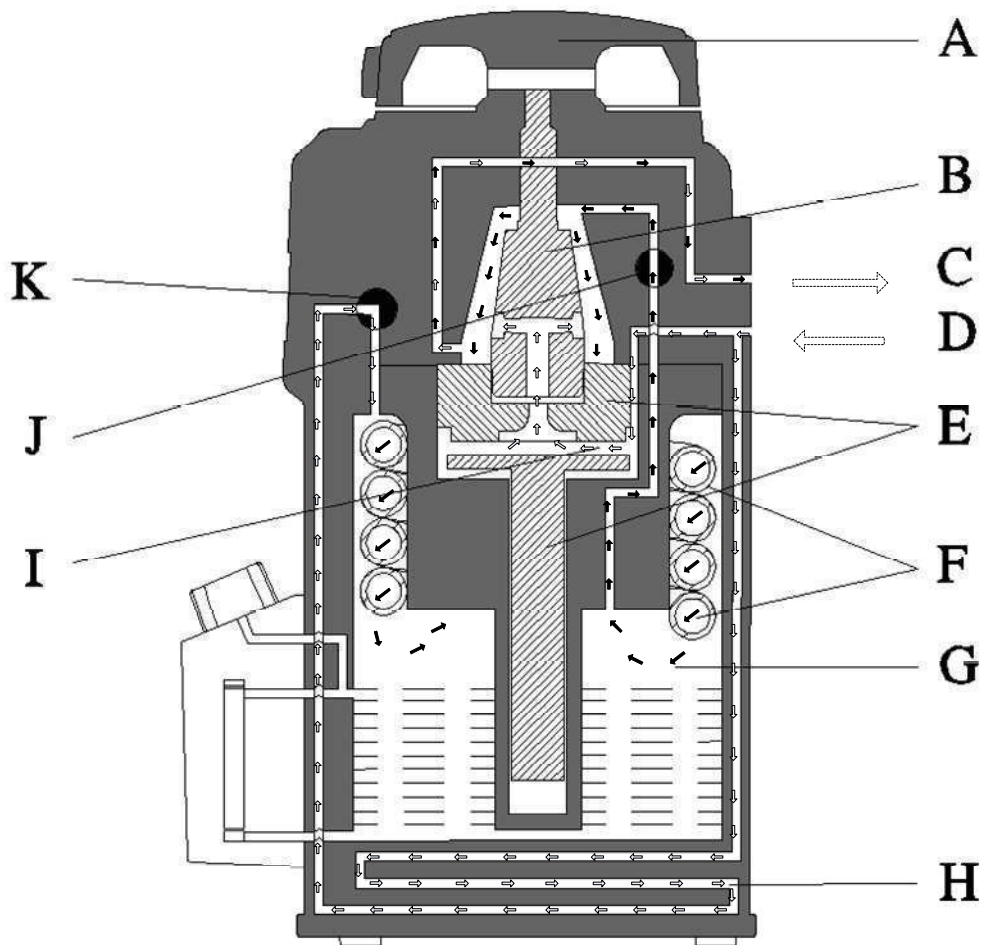

The fresh gas is routed through valves J and K, which are linked to the control dial A, and through the vaporizing chamber G.

Fresh gas enters by the inlet D. Some of the fresh gas is routed through the vaporizing chamber G, and charged with anesthetic agent in soaked wick F. The rest of the fresh gas is routed past the airway I and through the temperature compensator E.

---

The two flows are mixed in the space behind the two flow controls (cone valve B), and routed to the outlet C.

The output concentration control of anesthetic agent vapor is important.

1. The concentration is influenced by the temperature compensator E, which makes use of the thermal expansion characteristics of different materials to expand or contract, based on heating or cooling, the airway I. This process compensates for the influence of temperature on the saturation concentration.
2. The pressure compensating system H effectively reduces the pumping effect.

Control dial position at 0—Vaporizer switched off

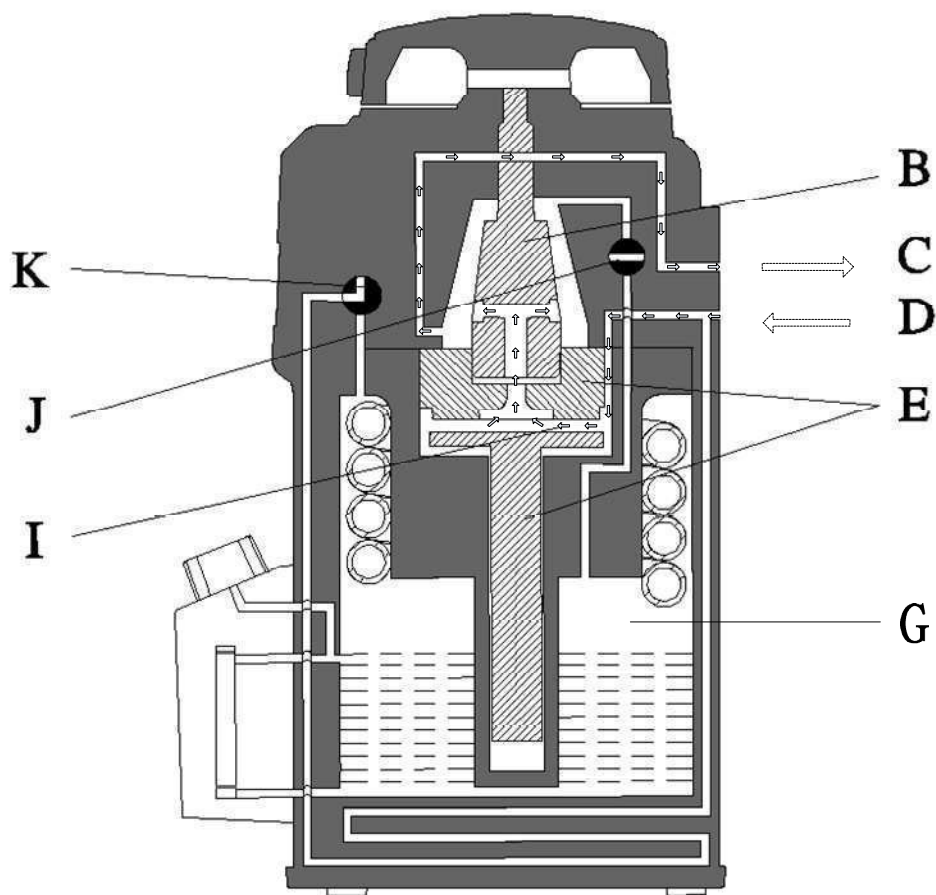

Fresh gas flows from the inlet D to the airway I, and then passes the temperature compensator E and the cone valve B, finally flows out from the outlet C.

The vaporizing chamber G is completely shut off from the gas flow by valves J and K. No anesthetic-agent can escape from the vaporizing chamber G.



---

## Anesthesia accessory

CATALOGUE

2022.06

---

[www.mindray.com](http://www.mindray.com)

P/N:ENG-Anesthesia accessory catalogue-210210X64P-20220606  
©2022 Shenzhen Mindray Bio-Medical Electronics Co.,Ltd. All rights reserved.





## CONTENTS

<b>01</b>	<b>Anesthesia mask, bag, breathing circuit</b>	2
<b>02</b>	<b>Vaporizer</b>	14
<b>03</b>	<b>Module &amp; Sensor</b>	20
<b>04</b>	<b>AGSS, Suction unit, Gas supply</b>	33
<b>05</b>	<b>Mounting solution</b>	47
<b>06</b>	<b>Other accessories</b>	53

### Finding the Right Part

This catalog has been designed to make finding the right part easy. Chapters are organized by specific accessory categories. Simply locate the type of part you are looking for under the appropriate category.

### Note:





This catalog is not an Operating Instructions Manual. This catalog will assist you in identifying the correct parts and accessories to connect to your Mindray Anesthesia machine, please refer to the Operating Instructions Manual. Warnings, Precautions and Notes can also be found in the Operating Instructions.

## Anesthesia Mask



### Disposable Anesthesia Mask

- Single patient use to avoid cross-infection
- Ergonomic design for convenient one-hand operation
- Adjustable air cushion design for optimal comfort and tightness
- Transparent design for optimal visibility
- Materials in accordance with ISO-10993:10993 biological compatibility requirements
- Complete range of models with color-coded hook for easier identification

Picture	Part No.	Description	Apply to
	040-001817-00	Aircushion mask, disposable, size #0	All
	040-001818-00	Aircushion mask, disposable, size #1	All
	040-001819-00	Aircushion mask, disposable, size #2	All
	040-001820-00	Aircushion mask, disposable, size #3	All

Picture	Part No.	Description	Apply to
	040-001821-00	Aircushion mask, disposable, size #4	All

	040-001822-00	Aircushion mask, disposable, size #5	All
-----------------------------------------------------------------------------------	---------------	--------------------------------------	-----





### Reusable Anesthesia Mask

- Ergonomic design for convenient one-hand operation
- Transparent design for optimal visibility
- Materials in accordance with ISO-10993:10993 biological compatibility requirements
- Full range of models for different clinical applications

Picture	Part No.	Description	Apply to
	040-001835-00	Silicon face mask, reusable, size #0	All

	040-001836-00	Silicon face mask, reusable, size #1	All
-------------------------------------------------------------------------------------	---------------	--------------------------------------	-----

	040-001837-00	Silicon face mask, reusable, size #2	All
--------------------------------------------------------------------------------------	---------------	--------------------------------------	-----

	040-001841-00	Silicon face mask, reusable, size #3	All
---------------------------------------------------------------------------------------	---------------	--------------------------------------	-----

Picture	Part No.	Description	Apply to
	040-001842-00	Silicon face mask, reusable, size #4	All

	040-001843-00	Silicon face mask, reusable, size #5	All
-----------------------------------------------------------------------------------	---------------	--------------------------------------	-----

## Breathing Bag

### Disposable breathing bag

- Single patient use to avoid cross-infection
- Standard 22F connector compatible with all conventional devices
- Latex free materials to prevent latex allergy
- Full range of models for different clinical applications



Part No.	Description	Apply to
040-001827-00	Latex-free breathing bag, disposable, 0.5L	All
040-001828-00	Latex-free breathing bag, disposable, 1L	All
040-001829-00	Latex-free breathing bag, disposable, 2L	All
040-001830-00	Latex-free breathing bag, disposable, 3L	All

### Reusable breathing bag

- Use of innocuous medical grade materials
- Standard 22F connector compatible with all conventional devices
- Full range of models for different clinical applications





Part No.	Description	Apply to
040-001856-00	Silicon breathing bag, reusable, 0.5L	All
040-001857-00	Silicon breathing bag, reusable, 1L	All
040-001858-00	Silicon breathing bag, reusable, 2L	All
040-001859-00	Silicon breathing bag, reusable, 3L	All

## Anesthesia Breathing Circuit





### Disposable breathing circuit

- Single patient use to avoid cross-infection
- Use of innocuous medical grade materials
- Good compliance and low flow resistance
- Transparent design for optimal visibility
- Light weight to easy operation
- Standardized and air-tight connectors for innovative assembly
- Elbow connector with air sampling and monitoring



Picture	Part No.	Description	Apply to
	040-001876-00	<b>Disposable breathing circuit package, Adult, Including:</b> <ul style="list-style-type: none"> <li>- Adult circuit with Y-piece, 1.5 m, diameter 22mm, 22F, 1 pcs</li> <li>- Elbow connector with Luer lock port, 1 pcs</li> <li>- Straight connector, 22M-22M, 1 pcs</li> <li>- Bacteria filter, 1 pcs</li> <li>- Extension tube, 0.5 m, 22F, 1 pcs</li> <li>- Latex-free breathing bag, 3L, 1 pcs</li> </ul>	All
	040-001878-00	<b>Disposable breathing circuit package, Child, Including:</b> <ul style="list-style-type: none"> <li>- Child circuit with Y-piece, 1.5m, diameter 15 mm, 22F, 1 pcs</li> <li>- Elbow connector with Luer lock port, 1 pcs</li> <li>- Straight connector, 22M-22M, 1 pcsz</li> <li>- Bacteria filter, 1 pcs</li> <li>- Extension tube, 0.5m, diameter 15 mm, 22F, 1 pcs</li> <li>- Latex-free breathing bag, 1L, 1 pcs</li> </ul>	All
	040-001831-00	Bacteria Filter, disposable, 1 pcs Bacterial removal: >99.9995% Viral removal: >99.995% Pressure Drop: <0.15kPa @ 30 L/min Dead space: 25.5 ml Connectors: 22F/15M-22M/15F	All

Part No.	Description	Apply to
115-030717-00	<b>Disposable breathing circuit accessory kit with mask, Adult, including:</b> - 040-001876-00 Disposable breathing circuit package, Adult (circuit with Y-piece 1.5m, Extension tube 0.5m, Elbow connector, Straight connector, Bacteria filter, Breathing bag 3L), 1 pcs - 040-001822-00 Aircushion mask, disposable, size #5, 1 pcs	All
115-030718-00	<b>Disposable breathing circuit accessory kit with mask, Child, including:</b> - 040-001878-00 Disposable breathing circuit package, Child, (circuit with Y-piece 1.5m, Extension tube 0.5m, Elbow connector, Straight connector, Bacteria filter, Breathing bag 1L), 1 pcs - 040-001819-00 Aircushion mask, disposable, size #2, 1 pcs	All

### Open Circuit

Picture	Part No.	Description	Apply to
	040-001704-00	<b>Mapleson C circuit, Adult open circuit, including:</b> - Breathing tube, 1.8m, 1 pcs - Connector, 22/15M, 1 pcs - Latex-free breathing bag, 2L, 1 pcs - APL valve, 1 pcs	All
	040-001703-00	<b>T-piece system circuit, Child open circuit, including:</b> - Breathing tube, 1.8m, 1 pcs - Connector, 22/15M, 1 pcs - Latex-free breathing bag, 0.5L, 1 pcs - APL valve, 1 pcs	All



### HFNC Circuit





Picture	Part No.	Description	Apply to
	040-006057-00	Single tube for HFNC, disposable, ID 22 mm, length 1.8 m	A9/ A8/ WATO EX-65 Pro
	040-006058-00	Tubing kit for HFNC, disposable, with heated wire, ID 22 mm, length 1m, 1.5m	A9/ A8/ WATO EX-65 Pro
	040-002376-00	Nasal cannula for HFNC (OPT842-small size)	A9/ A8/ WATO EX-65 Pro
	040-002377-00	Nasal cannula for HFNC (OPT844-medium size)	
	040-002378-00	Nasal cannula for HFNC (OPT846-large size)	

## Reusable breathing circuit

- Use of innocuous medical grade materials
- Good compliance and low flow resistance
- Transparent design for optimal visibility
- Standardized and air-tight connectors for innovative assembly
- Y-piece with port for temperature and pressure monitoring



Picture	Part No.	Description	Apply to
	115-031780-00	<b>Reusable breathing circuit accessory kit, Adult, including:</b> <ul style="list-style-type: none"> <li>- 040-001850-00 Breathing tube, silicon, adult, 1.5m, 2 pcs</li> <li>- 040-001859-00 Silicon breathing bag, 3L, 1 pcs</li> <li>- 040-001843-00 Silicon face mask, size #5, adult large, 1 pcs</li> <li>- 040-001866-00 connector, Y-piece, with sample port, 1pcs</li> <li>- 040-001868-00 connector, L type (Elbow), 22M/15F, 22F, 1pcs</li> </ul>	All
	115-031781-00	<b>Reusable breathing circuit accessory kit, Child, including:</b> <ul style="list-style-type: none"> <li>- 040-001851-00 Breathing tube, silicon, child/infant, 1.5m, 2 pcs</li> <li>- 040-001857-00 Silicon breathing bag, reusable, 1L, 1 pcs</li> <li>- 040-001837-00 Silicon face mask, size #2, child, 1 pcs</li> <li>- 040-001866-00 connector, Y-piece, with sample port, 1pcs</li> <li>- 040-001868-00 connector, L type (Elbow), 22M/15F,22F, 1pcs</li> </ul>	All
	040-001850-00	Breathing tube, silicon, reusable, Adult, 1.5m	All





Picture	Part No.	Description	Apply to
	040-001851-00	Breathing tube, silicon, reusable, Child/infant, 1.5m	All
	040-001854-00	Breathing tube, silicon, reusable, Adult, 0.45m	All
	040-001866-00	connector, Y-piece, reusable, with sample port	All
	040-001868-00	connector, L type (Elbow), reusable, 22M/15F,22F	All





## Vaporizer







- Large capacity
- Highly compatible supporting different anesthetic agents
- Automatic flow, temperature, pressure compensation
- Maintenance-free design

## Mindray V60 Vaporizer





Picture	Part No.	Description	Apply to
	115-005348-00	Mindray V60 vaporizer, Isoflurane, Pour fill	All except A9
	115-005345-00	Mindray V60 vaporizer, Isoflurane, Key filler, with Key filler adapter	All except A9
	115-005349-00	Mindray V60 vaporizer, Sevoflurane, Pour fill	All except A9
	115-005346-00	Mindray V60 vaporizer, Sevoflurane, Key filler, with Key filler adapter	All except A9





Picture	Part No.	Description	Apply to
	115-005350-00	Mindray V60 vaporizer, Sevoflurane, Quik-Fil	All except A9
	115-014139-00	Mindray V60 vaporizer, Halothane, Pour fill	All except A9
	115-014138-00	Mindray V60 vaporizer, Halothane, Key filler, with Key filler adapter	All except A9
	115-017631-00	Vaporizer parking position (the third vaporizer position)	A8/A7/A5/ WATO EX-65 Pro/ EX-55 Pro/ EX-65/ EX-55/ EX-35

## Mindray V90 Vaporizer



Picture	Part No.	Description	Apply to
	115-063020-00	Mindray V90 vaporizer, Isoflurane, Safety Filling, with adapter	A9
	115-063018-00	Mindray V90 vaporizer, Sevoflurane, Safety Filling, with adapter	A9
	115-063017-00	Mindray V90 vaporizer, Sevoflurane, Quik-Fil	A9
	115-063022-00	Mindray V90 vaporizer, Desflurane, Safe-T-Fil	A9

## Adapter for Vaporizer





Picture	Part No.	Description	Apply to
	040-000065-00	Key filler Adapter for filling the vaporizer, Isoflurane	V60
	040-000066-00	Key filler Adapter for filling the vaporizer, Sevoflurane	V60
	115-026747-00	Quik-Fil Adapter for filling the vaporizer, Sevoflurane	V60, V90
	040-000067-00	Quik-Fil Drain Funnel adapter for draining the vaporizer, Sevoflurane	V60

Picture	Part No.	Description	Apply to
	040-000063-00	Key filler adapter for filling the vaporizer, Halothane	V60
	115-064147-00	Safety filling adapter for filling the Mindray V90 vaporizer, Isoflurane	V90
	115-064146-00	Safety filling adapter for filling the Mindray V90 vaporizer, Sevoflurane	V90
	115-082300-00	Filling converter for Sevoflurane	V60, V90





## Flow sensor

Picture	Part No.	Description	Apply to
	0601-30-69700	Inspiration flow sensor, 1 pcs	WATO EX-65 Pro/ EX-55 Pro/ EX-65/EX-55/ EX-35/EX-30/ EX-20
	0601-30-78894	Expiration flow sensor, 1 pcs	
	115-001366-00	<b>Flow sensor kit, including:</b> - Inspiration flow sensor, 1 pcs 0601-30-69700 - Expiration flow sensor, 1 pcs 0601-30-78894	
	115-008262-00	Inspiration Flow sensor, 1 pcs	A7/A5
	115-008263-00	Expiration Flow sensor, 1 pcs	
	115-008264-00	<b>Flow sensor kit, including:</b> - Inspiration Flow sensor, 1 pcs 115-008262-00 - Expiration Flow sensor, 1 pcs 115-008263-00	
	115-041519-00	<b>Flow sensor kit, autoclavable, including:</b> - Inspiration flow sensor, 1 pcs 115-041507-00 - Expiration flow sensor, 1 pcs 115-041508-00	All

## O<sub>2</sub> monitoring accessory

Picture	Part No.	Description	Apply to
	115-009958-00	<b>Oxygen monitoring kit, including:</b> Oxygen sensor Medcel MOX-2 and Oxygen sensor mounting kit	A7/A5/ WATO EX-65 Pro/ EX-55 Pro/EX-65/ EX-55/EX-35 with Pre-Pak circuit
	115-034487-00	<b>Oxygen monitoring kit, including:</b> Oxygen sensor OOM102-1 and Oxygen sensor cable	WATO EX-35 without Pre-Pak circuit WATO EX-30/EX-20
	115-065993-00	<b>Oxygen monitoring kit, including:</b> Base for Oxygen sensor and Oxygen sensor MOX-2	A9/A8
	115-016612-00	<b>Oxygen sensor position choke plug kit, including:</b> - 043-003033-00 Oxygen sensor position cap, 1 pcs - 115-016612-00 Oxygen sensor position choke plug, 1 pcs	A7/A5

## O<sub>2</sub> monitoring accessory



Picture	Part No.	Description	Apply to
	0611-10-45654	Oxygen sensor, Medical MOX-2, 1 pcs	A9/A8/A7/A5/ WATO EX-65 Pro/ EX-55 Pro WATO EX-65/EX-55 WATO EX-35 with pre-pak circuit
	040-000898-00	Oxygen sensor, OOM102-1, 1pcs	WATO EX-35 without pre-pak circuit WATO EX-30/EX-20
	043-000616-00	Oxygen sensor cable	A7/A5/ WATO EX-65 Pro/ EX-55 Pro/ EX-65/EX-55/ EX-35
	115-064181-00	Base for Oxygen sensor	A9/A8

## CO<sub>2</sub> module and accessory





### Sidestream CO<sub>2</sub> module and accessory

- Sampling lines are disposable
- Water trap can be reused (Should be replaced every month)
- Latex free
- Good biocompatibility

Picture	Part No.	Description	Apply to
	115-030418-00	Sidestream CO <sub>2</sub> module, without accessory	A7, A5
	120-013811-00	Sidestream CO <sub>2</sub> module, without accessory	WATO EX-65 Pro/ EX-55 Pro/ EX-65/ EX-55/ EX-35
	115-024752-00	<b>Sidestream CO<sub>2</sub> accessory kit, Adult/Pediatric, including:</b> - Dryline airway adapter, straight, Adu/Ped, 2 pcs - DRYLINE II Water Trap, Adu/Ped, 2 pcs - Sampling line, Adu/Ped, 2.5 m, 2pcs - Quick connector for gas return, 1 pcs	A7/A5/ WATO EX-65 Pro/ EX-55 Pro/ EX-65/ EX-55/ EX-35



Picture	Part No.	Description	Apply to
	115-024753-00	<b>Sidestream CO<sub>2</sub> accessory kit, Neonate, including:</b> - Airway adapter, Neonate, 2 pcs - DRYLINE II Water Trap, Neonate, 2 pcs - Sampling Line, Neonate, 2.5 m, 2 pcs - Quick connector for gas return, 1 pcs	A7/A5/ WATO EX-65 Pro/ EX-55 Pro/ EX-65/ EX-55/ EX-35
	115-024797-00	<b>Sidestream CO<sub>2</sub> module kit, with accessory, Adult/Ped, including:</b> - CO <sub>2</sub> module, 1-slot, 1 pcs - CO <sub>2</sub> accessory kit, Adult/Pediatric	A7/A5
	115-024798-00	<b>Sidestream CO<sub>2</sub> module kit, with accessory, Neonate, including:</b> - CO <sub>2</sub> module, 1-slot, 1 pcs - CO <sub>2</sub> accessory kit, Neonate	A7/A5
	120-015033-00	<b>Sidestream CO<sub>2</sub> module kit, with accessory, Adult/pediatric, including:</b> - Sidestream CO <sub>2</sub> module - Sidestream CO <sub>2</sub> accessory kit, Adult/Pediatric	WATO EX-65 Pro/ EX-55 Pro/ EX-65/ EX-55/ EX-35
	120-015034-00	<b>Sidestream CO<sub>2</sub> module kit, with accessory, Neonate, including:</b> - Sidestream CO <sub>2</sub> module - Sidestream CO <sub>2</sub> accessory kit, Neonate	WATO EX-65 Pro/ EX-55 Pro/ EX-65/ EX-55/ EX-35

Picture	Part No.	Description	Apply to
	115-030421-00	<b>External sidestream CO<sub>2</sub> module, with accessory, Adult/pediatric, including:</b> - External sidestream CO <sub>2</sub> module - External sidestream CO <sub>2</sub> accessory kit, Adult/Pediatric	WATO EX-30
	115-030422-00	<b>External sidestream CO<sub>2</sub> module, with accessory, Neonate, including:</b> - External sidestream CO <sub>2</sub> module - External sidestream CO <sub>2</sub> accessory kit, Neonate	WATO EX-30
	115-002594-00	<b>External sidestream CO<sub>2</sub> accessory kit, Adult/pediatric, including:</b> - Dryline airway adapter, straight, Adu/Ped, 2 pcs - Water trap, Adu/Ped, 2 pcs - Sampling line, Adu/Ped, 2.5 m, 2pcs - Quick connector for gas return, 1 pcs	WATO EX-30
	115-002595-00	<b>External sidestream CO<sub>2</sub> accessory kit, Neonate, including:</b> - Airway adaptor, 2 pcs - Water trap, neonate, 2 pcs - Sampling Line, Neonate, 2.5 m, 2 pcs - Quick connector for gas return, 1 pcs	WATO EX-30

## Mainstream CO<sub>2</sub> module and accessory

- Short response time
- Adapter are disposable
- Latex free
- Good biocompatibility



For A7, A5, WATO EX-65 Pro, EX-55 Pro, EX-65, EX-55, EX-35

Picture	Part No.	Description
	115-030414-00	Mainstream CO <sub>2</sub> module, without accessory
	6800-30-50613	<b>Mainstream CO<sub>2</sub> accessory kit, including:</b> <ul style="list-style-type: none"> <li>- Capnostat CO<sub>2</sub> sensor, with cable 2.4 m, 1 pcs</li> <li>- Airway adapter, Adu/Ped, disposable, 1 pcs</li> <li>- Airway adapter, Neonate, disposable, 1 pcs</li> <li>- Cable Holding Clips, 5 pcs</li> </ul>
	115-030410-00	<b>Mainstream CO<sub>2</sub> module kit, with accessory, including:</b> <ul style="list-style-type: none"> <li>- Mainstream CO<sub>2</sub> module, CAPNOSTAT</li> <li>- Mainstream CO<sub>2</sub> accessory kit</li> </ul>

## AG module and accessory

- Sampling lines are disposable
- Water trap can be reused (Should replaced every month)
- Latex free
- Good biocompatibility



For A9, A8, A7, A5, WATO EX-65 Pro, EX-55 Pro, EX-65, EX-55, EX-35



Picture	Part No.	Description
	115-030368-00	AG+O <sub>2</sub> module, 2-slot, without accessory
	115-030369-00	AG module, 2-slot, without accessory
	115-030385-00	<b>AG accessory kit, including:</b> <ul style="list-style-type: none"> <li>- Dryline airway adapter, straight, Adu/Ped, 2 pcs</li> <li>- Airway adapter, Neonate, 2 pcs</li> <li>- DRYLINE II Water Trap, Adu/Ped, 2 pcs</li> <li>- Sampling line, Adu/Ped, 2.5 m, 2 pcs</li> <li>- DRYLINE II Water Trap, Neonate, 2 pcs</li> <li>- Sampling Line, Neonate, 2.5 m, 2 pcs</li> <li>- Quick connector for gas return, 1 pcs</li> </ul>
	115-030379-00	<b>AG+O<sub>2</sub> module kit, with accessory, including:</b> <ul style="list-style-type: none"> <li>- AG+O<sub>2</sub> module , 2-slot</li> <li>- AG accessory kit</li> </ul>
	115-030380-00	<b>AG module kit, with accessory, including:</b> <ul style="list-style-type: none"> <li>- AG module , 2-slot</li> <li>- AG accessory kit</li> </ul>

## BIS module and accessory

- Flexible design adjusts to different head sizes
- Connector provides secure click-in connection with push button release
- BIS sensor single patient use, avoiding cross-infection
- Latex-free
- Good biocompatibility, avoiding allergic reactions to patient



For A9, A8, A7, A5, WATO EX-65 Pro, EX-65

Picture	Part No.	Description
	115-013194-00	BIS module, 1-slot, without accessory
	6800-30-50761	BIS Measuring Cable Assembly, 4.5 m, 1 pcs

Picture	Part No.	Description
	6800-30-50878	<b>BIS accessory kit, Adult, including:</b> - BIS Measuring Cable Assembly, 4.5 m, 1 pcs - BIS Sensor Quatro 186-0106, Adu, disposable, 5 pcs
	6800-30-50144	<b>BIS accessory kit, Pediatric, including:</b> - BIS Measuring Cable Assembly, 4.5 m, 1 pcs - BIS Sensor Quatro 186-0200, Pediatric, disposable, 5 pcs
	6800-30-50880	<b>BIS module kit, with accessory, Adult, including:</b> - BIS module, 1-slot - BIS accessory kit, Adult
	6800-30-50427	<b>BIS module kit, with accessory, Pediatric, including:</b> - BIS module, 1-slot - BIS accessory kit, Pediatric

## BISx4 module and accessory

For A9, A8, A7, A5, WATO EX-65 Pro, EX-65

Picture	Part No.	Description
	115-005707-00	BISx4 Measuring Cable Assembly, 4.5 m, 1 pcs
	115-005614-00	<b>BISx4 accessory kit, Adult, including:</b> - BISx4 Measuring Cable Assembly, 4.5 m, 1 pcs - BISx4 Sensor Quatro 186-0212, Adult, disposable, 5 pcs
	115-030406-00	<b>BISx4 module kit, with accessory, Adult, including:</b> - BIS module, 1-slot - BISx4 accessory kit, Adult



## AG+BIS module and accessory

For A9, A8, A7, A5, WATO EX-65 Pro, EX-65

Picture	Part No.	Description
	115-030370-00	AG+O <sub>2</sub> +BIS module, 2-slot, without accessory
	115-030371-00	AG+BIS module , 2-slot, without accessory
	115-030381-00	<b>AG+O<sub>2</sub>+BIS module kit, with AG accessory, without BIS accessory, including:</b> - AG+O <sub>2</sub> +BIS module , 2-slot - AG accessory kit
	115-030382-00	<b>AG+BIS module kit, with AG accessory, without BIS accessory, including:</b> - AG+BIS module , 2-slot - AG accessory kit
	115-030383-00	<b>AG+O<sub>2</sub>+BIS module kit, with AG accessory, with BIS accessory, including:</b> - AG+O <sub>2</sub> +BIS module , 2-slot - AG accessory kit - BIS accessory kit, Adult
	115-030384-00	<b>AG+BIS module kit, with AG accessory, with BIS accessory, including:</b> - AG+BIS module , 2-slot - AG accessory kit - BIS accessory kit, Adult

## NMT module and accessory

For A9, A8, A7, A5



Picture	Part No.	Description
	115-020916-00	NMT module, without accessory
	115-018586-00	<b>NMT accessory kit, including:</b> <ul style="list-style-type: none"> <li>- NMT main cable</li> <li>- NMT transducer cable</li> <li>- ECG electrode (3M, 2245), 50 pcs</li> <li>- Bandage for NMT transducer, disposable, 20pcs</li> </ul>
	115-020917-00	<b>NMT module kit, with accessory, including:</b> <ul style="list-style-type: none"> <li>- NMT module, 1-slot</li> <li>- NMT accessory kit</li> </ul>

## Anesthetic gas scavenging system (AGSS)



## Active AGSS assembly and accessory

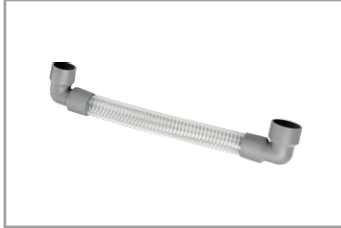

Picture	Part No.	Description	Apply to
	115-017376-00	AGSS Assembly, low-flow, high vacuum	A7/A5/
	115-017375-00	AGSS Assembly, high-flow, low vacuum	WATO EX-65 Pro/ EX-55 Pro EX-65/EX-55 EX-35/EX-30 EX-20

Picture	Part No.	Description	Apply to
	115-006557-00	Waste gas transfer hose, from main unit to AGSS assembly (801-0631-00074-00)	A7/A5/ WATO EX-65 Pro/ EX-55 Pro EX-65/EX-55 EX-35/EX-30 EX-20
	115-009097-00	AGSS high flow receiving hose, from AGSS assembly to hospital's waste gas disposal system	All
	115-009073-00	AGSS low flow receiving hose, from AGSS assembly to hospital's waste gas disposal system	
	082-001372-00	AGSS receiving hosing, (35G-WAGD-DS/FG2-3), from AGSS assembly to vacuum system	

## Active AGSS kit

Part No.	Description	Apply to
115-030332-00	<b>AGSS kit, low flow, high vacuum, including:</b> - AGSS Assembly, low-flow - Waste gas transfer hose, from main unit to AGSS assembly - AGSS low flow receiving hose, from AGSS assembly to hospital's waste gas disposal system - AGSS Three-way connector, from ACGO to AGSS	A7/A5/ WATO EX-65 Pro/ EX-55 Pro EX-65/EX-55 EX-35/
115-030333-00	<b>AGSS kit, high flow, low vacuum, including:</b> - AGSS Assembly, high-flow - Waste gas transfer hose, from main unit to AGSS assembly - AGSS high flow receiving hose, from AGSS assembly to hospital's waste gas disposal system - AGSS Three-way connector, from ACGO to AGSS	A7/A5/ WATO EX-65 Pro/ EX-55 Pro EX-65/EX-55 EX-35/
115-011860-00	<b>AGSS kit, low flow, high vacuum, including:</b> - AGSS Assembly, low-flow - Waste gas transfer hose, from main unit to AGSS assembly - AGSS low flow receiving hose, from AGSS assembly to hospital's waste gas disposal system - AGSS mounting kit	WATO EX-30/ EX-20
115-011859-00	<b>AGSS kit, high flow, low vacuum, including:</b> - AGSS Assembly, high-flow - Waste gas transfer hose, from main unit to AGSS assembly - AGSS high flow receiving hose, from AGSS assembly to hospital's waste gas disposal system - AGSS mounting kit	WATO EX-30/ EX-20

## Passive AGSS accessory

Picture	Part No.	Description	Apply to
	115-002342-00	<b>Passive AGSS accessory kit, including:</b> - Tube, 32mm, 1 pcs - Adaptor, 1 pcs	All
	115-042912-00	AGSS Three-way connector, from ACGO to AGSS	All

## Suction system



### Venturi suction system (External)

Part No.	Description	Apply to
115-009509-00	<b>Venturi suction kit, Air drive, NIST, including:</b> - Suction main unit, venturi - Suction T connector, NIST - Suction liquid collection bottle bracket kit	WATO EX-30/ EX-20
115-011380-00	<b>Venturi suction kit, Air drive, DISS, including:</b> - Suction main unit, venturi - Suction T connector, DISS - Suction liquid collection bottle bracket kit	WATO EX-30/ EX-20

Part No.	Description	Apply to
115-041470-00	<b>Venturi suction kit, Air drive, NIST, including:</b> - Suction main unit, venturi - Suction T connector, NIST - Suction liquid collection bottle bracket kit, for rail	WATO EX-35
115-041471-00	<b>Venturi suction kit, Air drive, DISS, including:</b> - Suction main unit, venturi - Suction T connector, DISS - Suction liquid collection bottle bracket kit, for rail	WATO EX-35
115-015266-00	<b>Venturi suction kit, Air drive, NIST, including:</b> - Suction main unit, venturi - Suction T connector, NIST - Suction liquid collection bottle bracket kit, long, for rail	A5
115-015267-00	<b>Venturi suction kit, Air drive, DISS, including:</b> - Suction main unit, venturi - Suction T connector, DISS - Suction liquid collection bottle bracket kit, long, for rail	A5

### Pipeline continuous vacuum suction system (External)



#### Pipeline continuous vacuum suction kit, including:

















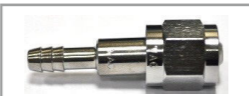

- Suction main unit, vacuum
- Suction liquid collection bottle bracket kit
- Vacuum hose assembly



Part No.	Description	Apply to
115-020734-00	Pipeline continuous vacuum suction kit, US, US/DISS	WATO EX-30/ EX-20
115-020735-00	Pipeline continuous vacuum suction kit, US, DISS/PB	WATO EX-30/ EX-20
115-020736-00	Pipeline continuous vacuum suction kit, US, DISS/Ohmeda	WATO EX-30/ EX-20
115-020737-00	Pipeline continuous vacuum suction kit, US, DISS/Chemetron	WATO EX-30/ EX-20
115-020738-00	Pipeline continuous vacuum suction kit, US, DISS/BS	WATO EX-30/ EX-20
115-020739-00	Pipeline continuous vacuum suction kit, Australian, NIST/SIS	WATO EX-30/ EX-20
115-020740-00	Pipeline continuous vacuum suction kit, French, NIST/FS	WATO EX-30/ EX-20
115-020741-00	Pipeline continuous vacuum suction kit, Germany, NIST/GS	WATO EX-30/ EX-20
115-020742-00	Pipeline continuous vacuum suction kit, Britain, NIST/BS	WATO EX-30/ EX-20

Part No.	Description	Apply to
115-041474-00	Pipeline continuous vacuum suction kit, US, US/DISS	WATO EX-35
115-041475-00	Pipeline continuous vacuum suction kit, US, DISS/PB	WATO EX-35
115-041476-00	Pipeline continuous vacuum suction kit, US, DISS/Ohmeda	WATO EX-35
115-041477-00	Pipeline continuous vacuum suction kit, US, DISS/Chemetron	WATO EX-35
115-041478-00	Pipeline continuous vacuum suction kit, US, DISS/BS	WATO EX-35
115-041479-00	Pipeline continuous vacuum suction kit, Australian, NIST/SIS	WATO EX-35
115-041480-00	Pipeline continuous vacuum suction kit, French, NIST/FS	WATO EX-35
115-041481-00	Pipeline continuous vacuum suction kit, Germany, NIST/GS	WATO EX-35
115-041482-00	Pipeline continuous vacuum suction kit, Britain, NIST/BS	WATO EX-35

## Pipeline Vacuum Hose assembly

- Gas supply: Vacuum, Hose length: 5 m; Apply to all models

Part No.	Specification	Standard	Hose color	Gas outlet (machine)	Gas inlet (wall)
082-001333-00	35U-VAC-DS/DS-5	USA	White	DISS 	DISS 
082-001334-00	35U-VAC-PB/DS-5			DISS 	Puritan-Bennett 
082-001335-00	35U-VAC-OH/DS-5			DISS 	Ohmeda 
082-001336-00	35U-VAC-CH/DS-5			DISS 	Chemetron 
082-001340-00	35U-VAC-BS/DS-5			DISS 	British standard 
082-001341-00	35I-VAC-BS/NS-5	ISO	Yellow	NIST 	British standard 
082-001339-00	35I-VAC-GS/NS-5			NIST 	Germany standard 
082-001337-00	35I-VAC-SIS/NS-5			NIST 	Australian SIS standard 
082-001338-00	35I-VAC-FS/NS-5			NIST 	French standard 

Picture	Part No.	Description	Apply to
	040-001532-00	Vacuum Liquid collection bottle/flask, with overflow protection	All
	040-001533-00	Vacuum Liquid collection bottle/flask, without overflow protection	All
	115-033264-00	Suction tube connect the anesthesia machine and liquid collection bottles, 3m, with filters	All

## Central gas supply hose







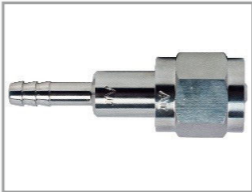
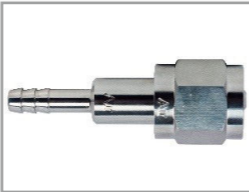

- Hose length 5 m
- Apply to all models



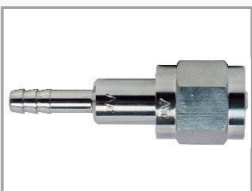
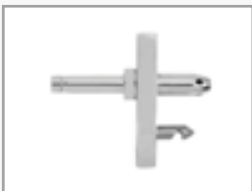













Standard: ISO

Part No.	Specification	Gas supply	Hose color	Gas outlet (machine)	Gas inlet (wall)
082-003443-00	34U-OXY-DS/DS-5	O <sub>2</sub>	Green	DISS	DISS
082-003445-00	34U-AIR-DS/DS-5	Air	Yellow		
082-003444-00	34U-N2O-DS/DS-5	N <sub>2</sub> O	Blue		

Standard: USA

Part No.	Specification	Gas supply	Hose color	Gas outlet (machine)	Gas inlet (wall)
082-001227-00	34U-OXY-BS/DS-5	O <sub>2</sub>	Green	DISS	British standard
082-001228-00	34U-AIR-BS/DS-5	Air	Yellow		
082-001229-00	34U-N2O-BS/DS-5	N <sub>2</sub> O	Blue		
082-001356-00	34U-OXY-CH/DS-5	O <sub>2</sub>	Green	DISS	Chemetron
082-001355-00	34U-AIR-CH/DS-5	Air	Yellow		
082-001354-00	34U-N2O-CH/DS-5	N <sub>2</sub> O	Blue		
082-001376-00	34U-OXY-OH/DS-5	O <sub>2</sub>	Green	DISS	Ohmeda
082-001374-00	34U-AIR-OH/DS-5	Air	Yellow		
082-001373-00	34U-N2O-OH/DS-5	N <sub>2</sub> O	Blue		
082-001375-00	34U-OXY-PB/DS-5	O <sub>2</sub>	Green	DISS	Puritan-Bennett
082-001378-00	34U-AIR-PB/DS-5	Air	Yellow		
082-001377-00	34U-N2O-PB/DS-5	N <sub>2</sub> O	Blue		



Standard: ISO

Part No.	Specification	Gas supply	Hose color	Gas outlet (machine)	Gas inlet (wall)
082-001209-00	34I-OXY-BS/NS-5	O <sub>2</sub>	White	NIST	British standard
082-001210-00	34I-AIR-BS/NS-5	Air	Black & White		
082-001211-00	34I-N2O-BS/NS-5	N <sub>2</sub> O	Blue		
082-001212-00	34I-OXY-GS/NS-5	O <sub>2</sub>	White	NIST	Germany standard
082-001213-00	34I-AIR-GS/NS-5	Air	Black & White		
082-001214-00	34I-N2O-GS/NS-5	N <sub>2</sub> O	Blue		
082-001215-00	34I-OXY-SIS/NS-5	O <sub>2</sub>	White	NIST	Australian SIS standard
082-001216-00	34I-AIR-SIS/NS-5	Air	Black & White		
082-001217-00	34I-N2O-SIS/NS-5	N <sub>2</sub> O	Blue		
082-001218-00	34I-OXY-FS/NS-5	O <sub>2</sub>	White	NIST	French standard
082-001219-00	34I-AIR-FS/NS-5	Air	Black & White		
082-001220-00	34I-N2O-FS/NS-5	N <sub>2</sub> O	Blue		

## Mounting solution



## Mounting solution for patient monitor N19/N22

Picture	Part No.	Description	Apply to
	115-066025-00	GCX Bracket kit for N19/N22, fixed height	A7/A5
	115-066027-00	GCX Bracket kit for N19/N22, variable height	A7/A5
	115-069443-00	GCX bracket kit for N19/N22, fixed height	A9/A8

## Mounting solution for patient monitor N17/N15/N12, ePM15

Picture	Part No.	Description	Apply to
	115-066028-00	GCX Bracket for N17/N15/N12/ePM15, fixed height	A7/A5 WATO EX-65 Pro/ EX-55 Pro/ EX-65/ EX-55/ EX-35/EX-30/EX-20
	115-066074-00	GCX bracket kit for N17/N15/N12/ePM15, fixed height, M series, 8"x8"	A9/A8
	115-066029-00	GCX Bracket for N17/N15/N12/ePM15, variable height	A9/A8/A7/A5 WATO EX-65 Pro/ EX-55 Pro/ EX-65/ EX-55/ EX-35

## Mounting solution for patient monitor ePM10/12, uMEC10/12/15, iPM, iMEC

Picture	Part No.	Description	Apply to
	115-070011-00	GCX Bracket for ePM10/12, uMEC10/12/15, iPM, iMEC, fixed height	A7/A5 WATO EX-65 Pro/ EX-55 Pro/ EX-65/ EX-55/ EX-35/EX-30/EX-20
	115-070767-00	GCX bracket kit for ePM10/ePM12/uMEC, fixed height, M series, 8"x8"	A9/A8
	115-070768-00	GCX Bracket for ePM10/12, uMEC10/12/15, iPM, iMEC, variable height	A9/A8/A7/A5 WATO EX-65 Pro/ EX-55 Pro/ EX-65/ EX-55/ EX-35



## Mounting solution for patient monitor T5/T8



Picture	Part No.	Description	Apply to
	115-015770-00	GCX bracket kit for Beneview T5, PM 9000, fixed height	A7/A5 WATO
	115-015783-00	GCX bracket kit for Beneview T8, fixed height	EX-65 Pro/ EX-55 Pro/ EX-65/ EX-55/ EX-35/EX-30/EX-20
	115-015771-00	GCX bracket kit for Beneview T5, fixed height, with module rack mounting pole	A7/A5 WATO EX-65 Pro/
	115-015784-00	GCX bracket kit for Beneview T8, fixed height, with module rack mounting pole	EX-55 Pro/ EX-65/ EX-55/ EX-35/EX-30/EX-20
	115-069066-00	GCX bracket kit for T5/ePM15, fixed height, M series, 8"x8"	A9/A8
	115-069067-00	GCX bracket kit for T8, fixed height, M series, 8"x8"	
	115-069068-00	GCX bracket kit for T5, fixed height, M series, 8"x8", with SMR module rack mounting pole	A9/A8
	115-069069-00	GCX bracket kit for T8, fixed height, M series, 8"x8", with SMR module rack mounting pole	

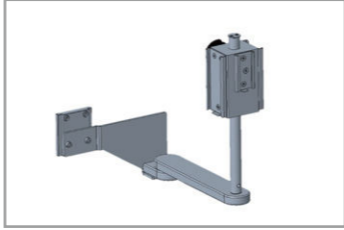

## Top shelf mounting kit

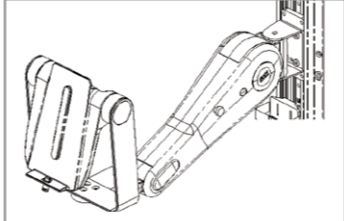
Picture	Part No.	Description	Apply to
	115-004003-00 115-004004-00	Top shelf mounting kit for Beneview T8, not support SMR Top shelf mounting kit for Beneview T5, not support SMR	All
	115-070794-00	Top shelf mounting kit for N15/17, ePM15	All
	115-074073-00	Top shelf mounting kit for N12, ePM12/10	All
	115-069445-00	Top shelf mounting bracket	A9/A8

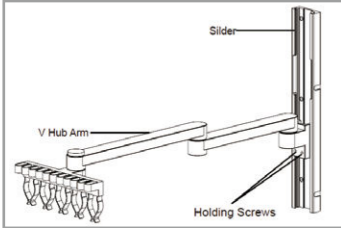

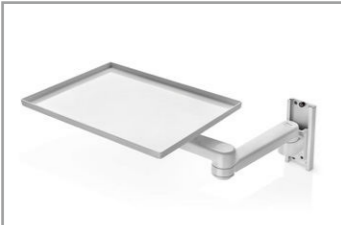

## Other Accessories





Picture	Part No.	Description	Apply to
	115-054836-00	Bracket for liquid collection bottles and humidifier	A9/A8
	115-071657-00	Bracket for humidifier	WATO EX-65 Pro
	115-030486-00	GCX bracket kit for Pumps	A9/A8
	115-069585-00	GCX bracket kit for TE7	A9/A8

Picture	Part No.	Description	Apply to
	115-024614-00	GCX support arm(M series), V Hub Arm kit, for cable management	A9/A8/A7/A5
	115-024461-00	Support arm kit for holding breathing tubes, with tube clip	A9/A8/A7/A5
	115-014961-00	Trolley for Air compressor C3	All
	034-000460-00	GCX external auxiliary work surface, including 12" x 12" tray and articulating arm	A9/A8/A7/A5

Picture	Part No.	Description	Apply to
	043-010620-00	Hook mounting on the handles, for standard breathing tube	A9/A8
	115-011304-00	Tube clip, for coaxial breathing hoses, 1pcs	A9/A8/A7/A5 WATO EX-65 Pro/ EX-55 Pro/ EX-65/ EX-55/ EX-35
	115-017042-00	Quick connector for gas return, from gas module in the anesthesia machine to the AGSS or breathing circuit	A9/A8/A7/A5 WATO EX-65 Pro/ EX-55 Pro/ EX-65/ EX-55/ EX-35

## Breathing system

Picture	Part No.	Description	Apply to
	115-030838-00	Sodalime canister, for WATO EX-55/65/55 Pro/65 Pro, or WATO EX-20/30/35 breathing circuit with bypass	WATO series
	115-034194-00	Sodalime canister, for WATO EX-20/30/35 breathing circuit without bypass	WATO EX-20/ EX-30/ EX-35
	801-0631-00066-00	Sodalime canister, for Pre-pak breathing circuit	A7/A5/ WATO EX-65 Pro/ EX-55 Pro/ EX-65/ EX-55/ EX-35
	115-066324-00	Sodalime canister with handle, for Pre-pak breathing circuit (A9/A8)	A9/A8

Picture	Part No.	Description	Apply to
	040-000358-00	Bellows	A7/A5 WATO Series
	0601-20-78976	Foam pad for soda-lime canister, for WATO EX-55/65/55 Pro/65 Pro, or WATO EX-20/30/35 breathing circuit with bypass , 20 pcs	WATO series
	115-046756-00	Quick Release APL Valve Assembly	A7
	115-048035-00	Flexible bag arm assembly	A9/A8/A7/A5 WATO EX-65 Pro/ EX-55 Pro/ EX-65/ EX-55/ EX-35

Picture	Part No.	Description	Apply to
	045-004527-00	Breathing system cleaning adaptor kit	A9/A8

### Cylinder Accessory

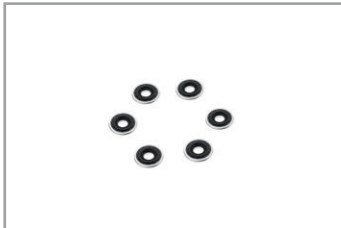
Picture	Part No.	Description	Apply to
	0348-00-0185	Cylinder yoke seal, 6 pcs	All

	115-033063-00	Cylinder yoke spanner	All
------------------------------------------------------------------------------------	---------------	-----------------------	-----

### Battery

Picture	Part No.	Description	Apply to
	115-018011-00	Li-ion Battery Package, 11.1 V, 4400mAh	WATO EX-30/ EX-20

	115-062081-00	Li-ion Bat Pack (10.95V) Li-ion Battery Package	A7/A5 WATO EX-65 Pro/ EX-55 Pro/ EX-65/ EX-55/ EX-35
-------------------------------------------------------------------------------------	---------------	-------------------------------------------------	---------------------------------------------------------------------

