



REPORT

issued by an Accredited Testing Laboratory

Handled by, department
Bertil Jonsson
Energy Technology
+46 10 516 51 60, bertil.jonsson@sp.se

Date
2010-10-26
Rev. date
2010-11-01
Reference
PX04884-01Arev1
Page
1 (2)



Sicom Srl
2 Via Cecilia Danieli
IT-33090 SEQUALS
Italy

Determination of thermal transmittance

(3 appendices)

Work requested

The client supplied drawings of overhead sectional doors of type Flexi-Force with Sicom Secure-Pan 42 mm finger safe for calculation of its U-value. Appendix 4 shows the design of the profile sections.

Calculation and test methods

Calculation of the U-values of the sections was performed using the FRAME 5.1 program. Values of the thermal conductivity are shown in appendix 1. The thermal conductivity value of PUR has been assigned on basis of measurements shown in appendix 2. The accredited part in this report is the determination of thermal conductivity according to EN 12667 (appendix 2).

The air temperature and surface resistance have been taken as $\vartheta_i = +20\text{ °C}$ and $R_{si} = 0.13\text{ m}^2\text{K/W}$ ($0.20\text{ m}^2\text{K/W}$ for inward corners) on the inside and $\vartheta_e = 0\text{ °C}$ and $R_{se} = 0.04\text{ m}^2\text{K/W}$ on the outside.

Calculation results

The U-value of a door (U_{door}) is calculated according to

$$U_{door} = [A^P \cdot U_{1-DIM}^P + (\sum(\psi \cdot L))] / A_{door}$$

where U_{1-DIM}^P = thermal transmittance for the one-dimensional heat flow through the panel, $W/(m^2K)$

ψ = linear thermal transmittance for edge sections. Additional heat flow compared to the one-dimensional heat-flow through panel due to combined thermal effects of panel(s), thermal bridging at the edge and wall position.

L = length, m

A^P, A_1^{door} = area of the panels, windows and door (wall opening)

SP Technical Research Institute of Sweden

Postal address
SP
Box 857
SE-501 15 BORÅS
Sweden

Office location
Västeråsen
Brinellgatan 4
Boras

Phone / Fax / E-mail
+46 10 516 50 00
+46 33 13 55 02
info@sp.se

Laboratories are accredited by the Swedish Board for Accreditation and Conformity Assessment (SWEDAC) under the terms of Swedish legislation. This report may not be reproduced other than in full, except with the prior written approval of the issuing laboratory.

Calculations with a residential door with daylight width (W) = 2.5 m and daylight height (H) 2.61 m;

Supplier	Name	Thermal transmittance, W/(m ² K) U _{door} -
Sicom	Secure-Pan 42 mm finger safe	1.5

Calculations with a industrial door with daylight width (W) = 4 m and daylight height (H) 3.4 m;

Supplier	Name	Thermal transmittance, W/(m ² K) U _{door} -
Sicom	Secure-Pan 42 mm finger safe	1.3

The calculations are shown in greater detail in appendix 3.

SP Technical Research Institute of Sweden
Energy Technology - Building Physics and Indoor Environment

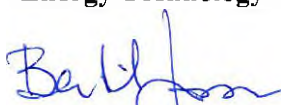

Bertil Jonsson
 Technical Manager/Officer

Appendices

1. Material data
2. Determination of thermal conductivity
3. Calculated results
4. Drawings



Material data

Material	Thermal conductivity, W/(m·K)	Source
Aluminium	160	1
Steel	50	1
PUR	0.026	App. 2
PVC	0.17	1
Gasket	0.06	1
EPDM	0.25	1
Cavity (air)*	Calculated according to SS-EN ISO 10077-2	

* Non rectangular air cavities are transformed into equivalent rectangular air cavities in accordance with SS-EN ISO 10077-2 and the thermal conductivity is then calculated for this equivalent air cavity.

1 = EN 10456

Determination of thermal conductivity according to EN 12667

Product	Sample from door leaf The samples, which consisted of urethane foam sandwiched between sheets of steel, were cut out from door panels immediately before determination of the thermal conductivity.
Manufacturer	Sicom Secure-Pan 42 mm finger safe
Test preparation	Before determination of thermal conductivity the surface sheets were removed and the surface were made even.
Test data	<p>Apparatus: Heat-flow meter apparatus HFM2000 single specimen symmetrical configuration with double heat-flow meters (400 x 400 mm). Last calibration 2010-09-22 with reference specimen IRMM 440 F66d $\lambda = 0.0304 \text{ W/(m}\cdot\text{K)}$</p> <p>Heat-flow: vertical, downwards</p> <p>Mean temperature: $10 \pm 0.3 \text{ }^\circ\text{C}$</p> <p>Ambient temperature: $10 \text{ }^\circ\text{C}$</p>
Test date	2010-10-14—15
Remarks	No thickness or volume changes were observed during the tests
Measurement uncertainty	<p>The uncertainty of the measured thermal conductivity is estimated to $\pm 2 \%$.</p> <p>The measured results only refer to the tested specimen.</p> <p>The increment for aged value according to table C.2, EN 13165 is $0.0015\text{-}0.0025 \text{ W/(m}\cdot\text{K)}$.</p>

Test results

Manufacturer	Sicom
Material	PUR
Density of the specimen, kg/m^3	33.2
Thickness of the specimen, mm	23.0
Mass change during test, kg/kg	0.001
Temperature difference across the sample, $^\circ\text{C}$	16.6
Density of the heat-flow, W/m^2	17.5
Thermal conductivity, $\text{W/(m}\cdot\text{K)}$	0.0218

Calculated results – Sicom – residential, finger safe panel

Area (WxH) wall opening 2.5 m x 2.61 m
 Number of panels 5
 Panel (d=42 mm) $U_{1-DIM}^P = 0.58 \text{ W}/(\text{m}^2 \cdot \text{K})$

No.	Part of the door	Length L, m	ψ -value, $\text{W}/(\text{m} \cdot \text{K})$
1	Top section	2.5	0.61
2	Bottom section	2.5	0.49
3	Side section	5.22	0.41
4	Joint between panels	10.0	0.13

$\Sigma(\psi L) = 6.2 \text{ W/K}$

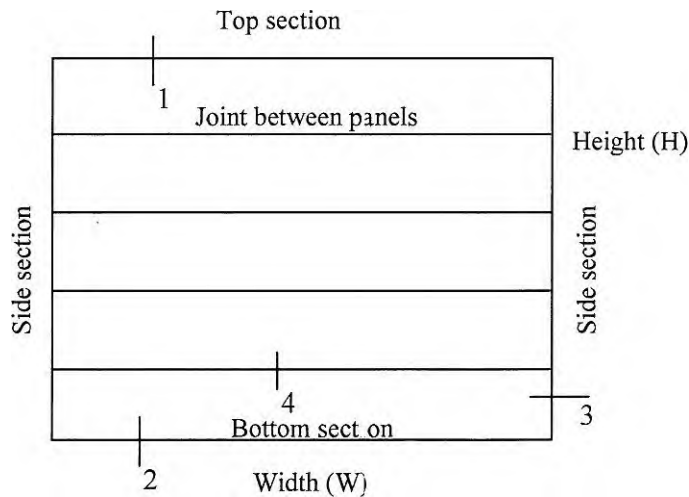

Figure 1. Location of the calculated sections

Calculated results – Sicom – industrial, finger safe panel

Area (WxH) wall opening 4.0 m x 3.4 m

Number of panels 6

Panel (d=42 mm) $U_{1-DIM} = 0.58 \text{ W}/(\text{m}^2\cdot\text{K})$

No.	Part of the door	Length L, m	ψ -value, $\text{W}/(\text{m}\cdot\text{K})$
1	Top section	4.0	0.61
2	Bottom section	4.0	0.58
3	Side section	6.8	0.41
4	Joint between panels	20.0	0.13

$\Sigma(\psi L) = 10.1 \text{ W/K}$

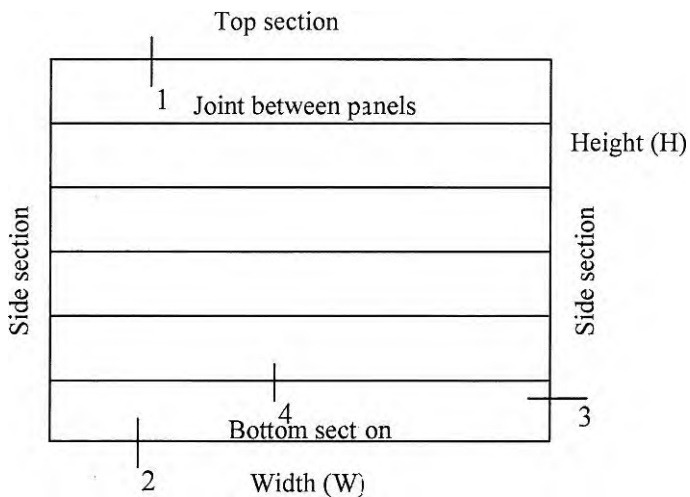
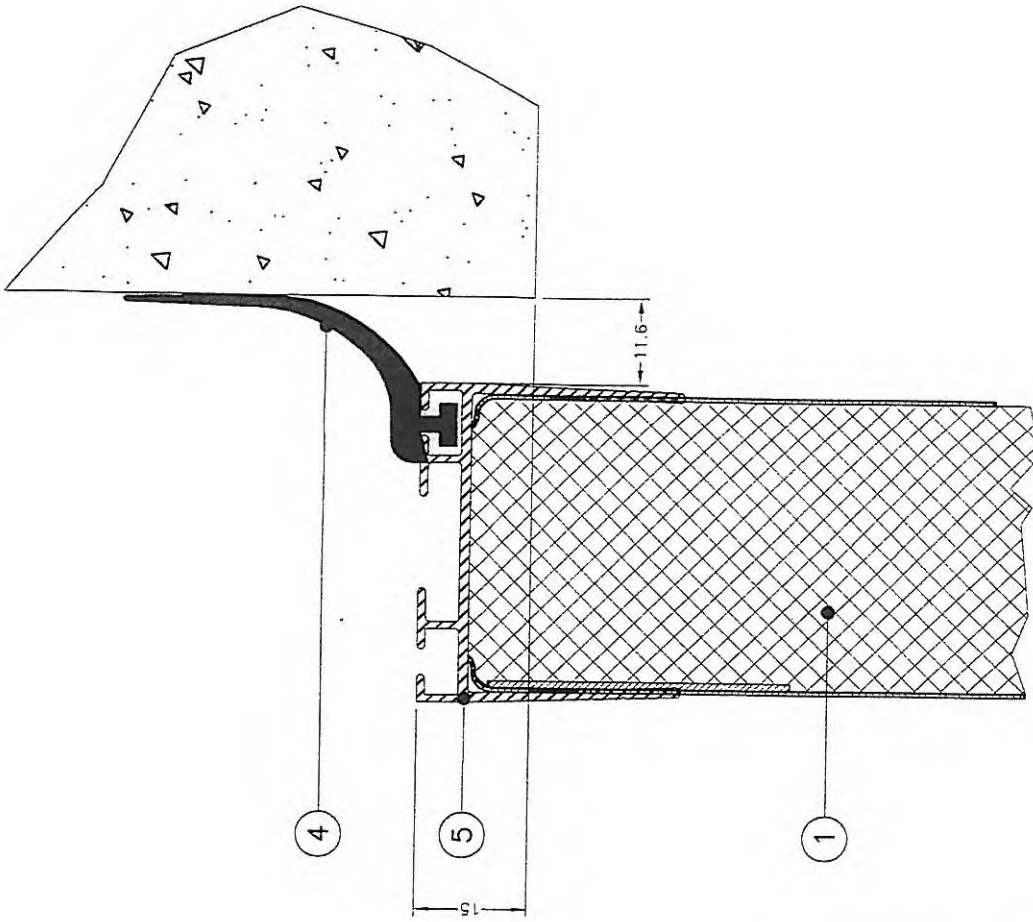
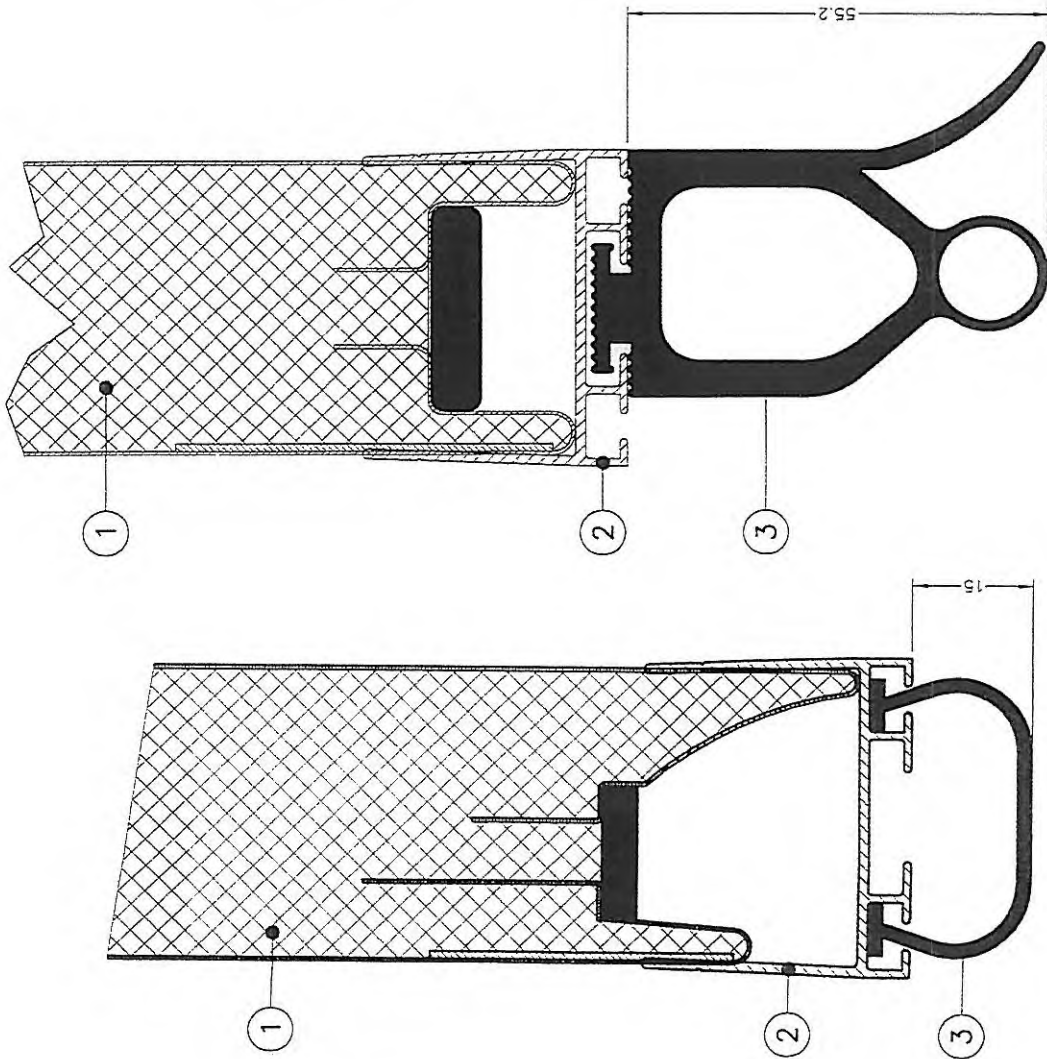

Figure 1. Location of the calculated sections



DETAIL 3



DETAIL 1

DETAIL 1

RESIDENTIAL

INDUSTRIAL

GENERAL ROUGHNESS ✓	UNIT mm	Tolerances unless stated	MEASURE	ANGLE	This drawing is property of Fiat Ferro and contains confidential information. rights strictly reserved. Reproduction, use for production purposes, issue for parties, in any form whatever, is not permitted without written authority from properties	
SCALE 2:1	PROJ. AM ⊕	MATERIAL	TREATMENT			
Vertical View B-B		50 191 00 0		19-11-2004		
NAME : N. Schikis		DATE : 19-11-2004		Overhead door hardware		

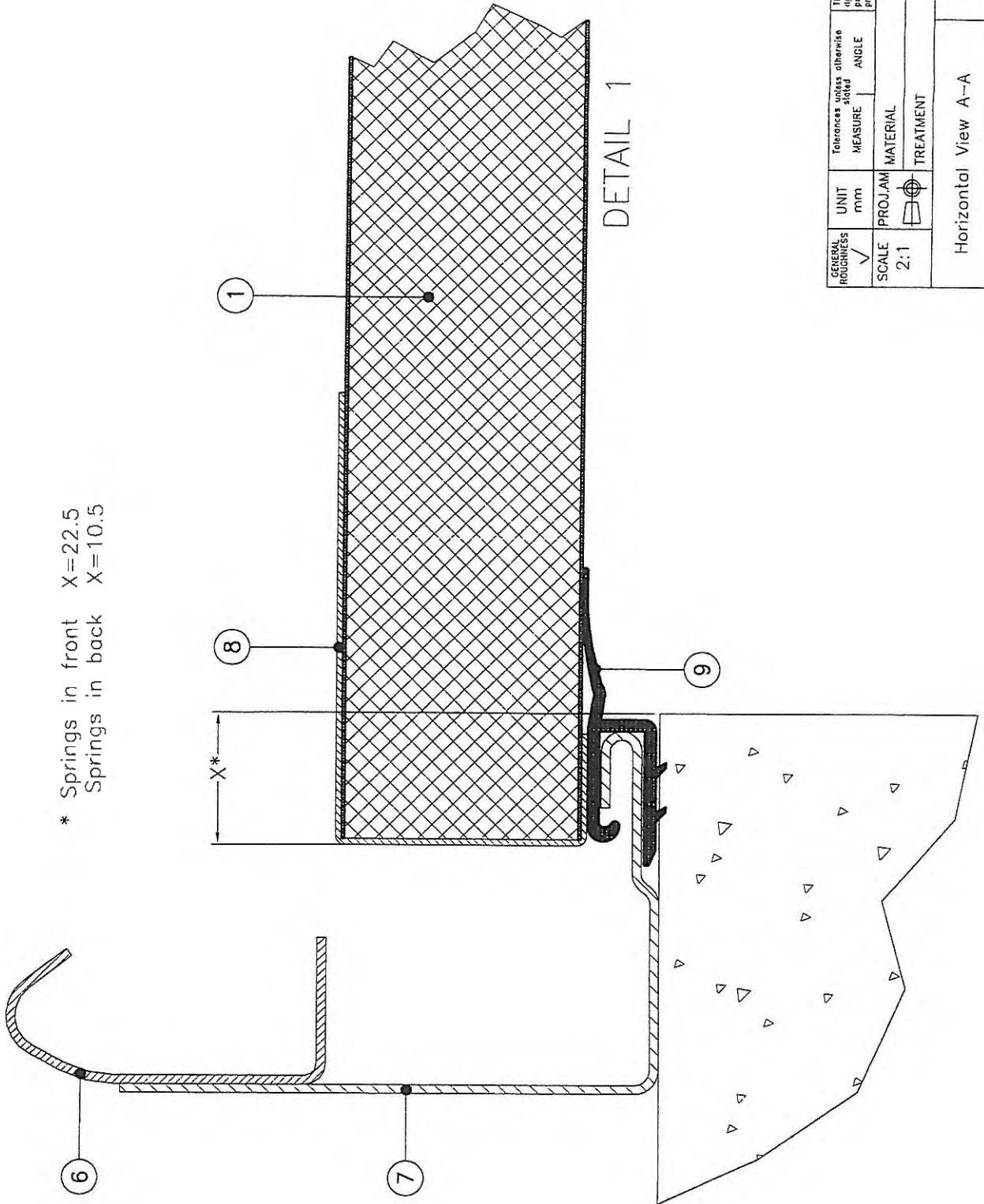

* Springs in front $X=22.5$
 Springs in back $X=10.5$

GENERAL ROUGHNESS ✓	UNIT mm	Tolerances MEASURE	unless OTHERWISE SPECIFIED	ANGLE	This drawing is property of Flavia Force, and contains confidential information. It is to be used only for the purposes for which it was prepared. Any reproduction, in any form whatsoever, is not permitted without the written consent of Flavia Force.
SCALE 2:1	PROJ. AM ⊙	MATERIAL	TREATMENT		
Horizontal View A-A		50 191 00 0	19-11-2004		A
NAME : N.Schils		DATE : 19-11-2004		Flavia Force Overhead door hardware	

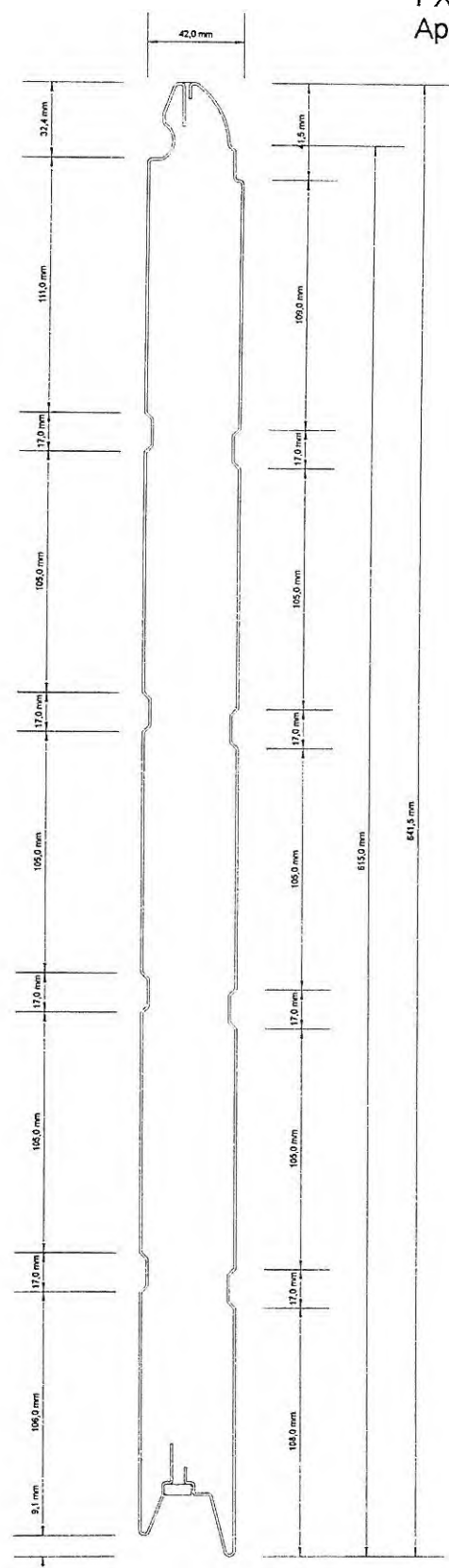
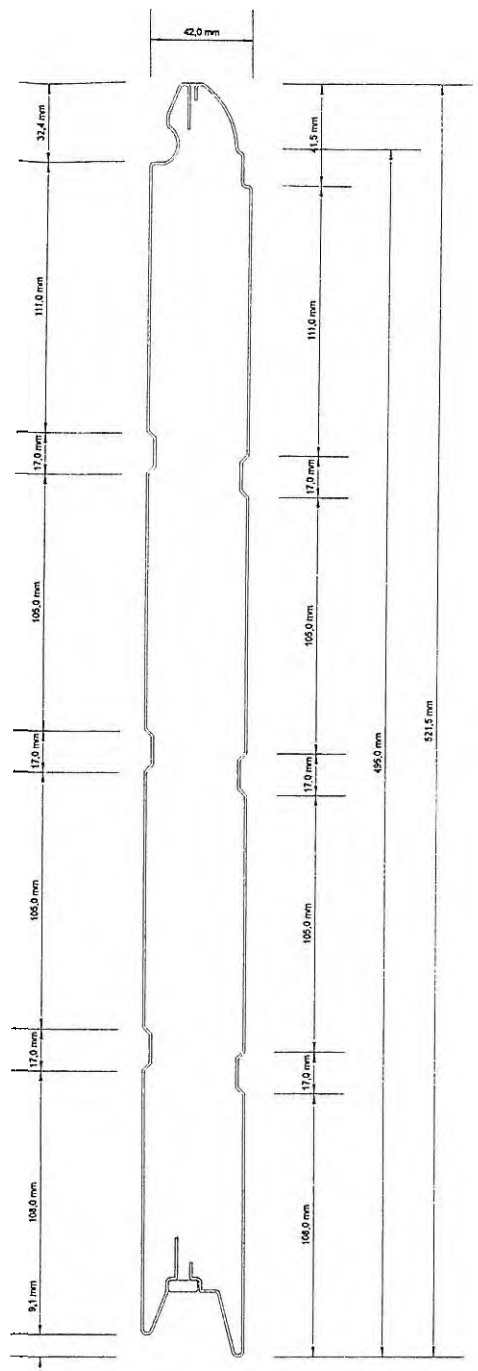

MULTI



Handled by, department
Daniel Andersson
Building Technology and Mechanics
+46 10 516 57 23, daniel.andersson2@sp.se

Sicom Srl
2 Via Cecilia Danieli
I-33090 Sequals
ITALY

Measuring of resistance to wind load, by four point bending test

Table 1 Summary of test results of resistance to wind load of Sicom Srl door panels.

Door Panels	Wind load		Maximum press. [Pa]	Remarks/Fracture
	class	[Pa]		
Sicom 2500	5	2 079	2 859	BoP point of loading
Sicom 4000	3	896	1 232	BoP point of loading
Sicom 5000	2	528	726	BoP between point of loading and centre of panel
Sicom 6000 IND 6000 × 65S Strut	3	716	984	BoP point of loading
Sicom 6000 IND 6000 × 68SC Strut	3	700	963	BoP center of panel
Sicom 7500 IND 7500 × 65S Strut	2	462	635	BoP point of loading
Sicom 8500 IND 8500 × 110S Strut	2	692	951	BoP both loading points

BoP = Buckling of the panel

DoP = Delaminating of the panel

C = Centre of panel

LP = Loading point

1 Introduction

SP has been commissioned by Sicom Srl to perform wind load tests on door panels.

Place of testing Laboratory of SP Building and Mechanics

Test date 2010-08-18—2010-08-20

SP Technical Research Institute of Sweden

Postal address
SP
Box 857
SE-501 15 BORÅS
Sweden

Office location
Västerasen
Brinellgatan 4
Borås

Phone / Fax / E-mail
+46 10 516 50 00
+46 33 13 55 02
info@sp.se

Laboratories are accredited by the Swedish Board for Accreditation and Conformity Assessment (SWEDAC) under the terms of Swedish legislation. This report may not be reproduced other than in full, except with the prior written approval of the issuing laboratory

2 Tested objects

The tested objects consist of doors panels according to Tables 2. The client selected the test specimens without assistance from SP.

Table 2 Description of the tested door panels.

Door Panels	Width mm	Height mm
Sicom 2500	2500	500
Sicom 4000	4000	610
Sicom 5000	5000	500
Sicom 6000 IND 6000 × 65S Strut	6000	610
Sicom 6000 IND 6000 × 68SC Strut	6000	610
Sicom 7500 IND 7500 × 65S Strut	7500	610
Sicom 8500 IND 8500 × 110S Strut	8500	610

3 Test performance

The door panels were subjected to four point bending and tested in accordance with *EN 12444 Resistance to wind load – testing and calculation*. The load was applied as shown in Figure 1. The loading points were symmetrical positioned in the test set-up. The distance between the loading points was half of the distance between the points of support.

The applied load was increased in steps in accordance with the different classes given in *EN 12424 Resistance to wind load – classification*. After each step the deflection of the door panels was measured. The test was performed at ambient temperature.

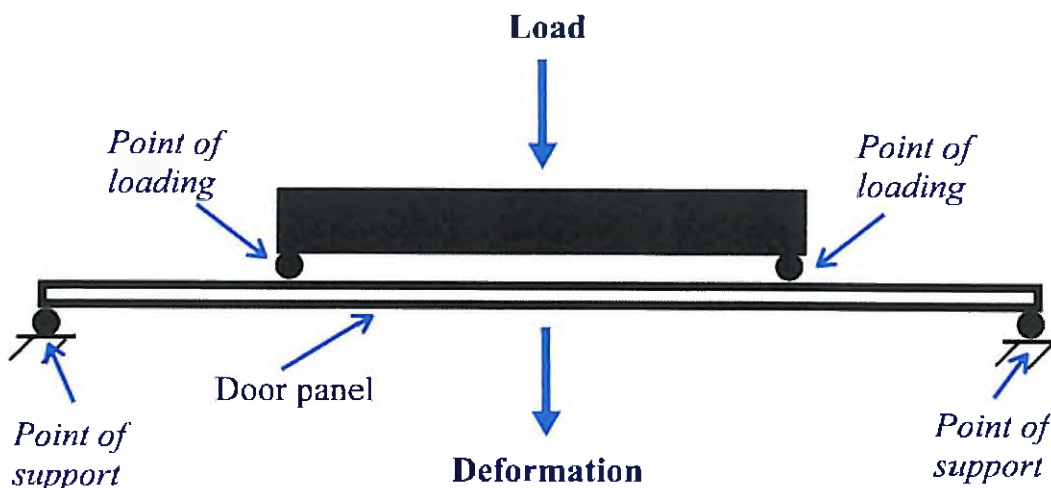

Figure 1 Schematic figure of test set-up

4 Test results

The test results shown in this report refer only to the tested objects. A summary of the test results is shown in Table 1, (see also Table 2 for a description of the panel details). Figures 2 to 15 show wind load vs. displacement curves.

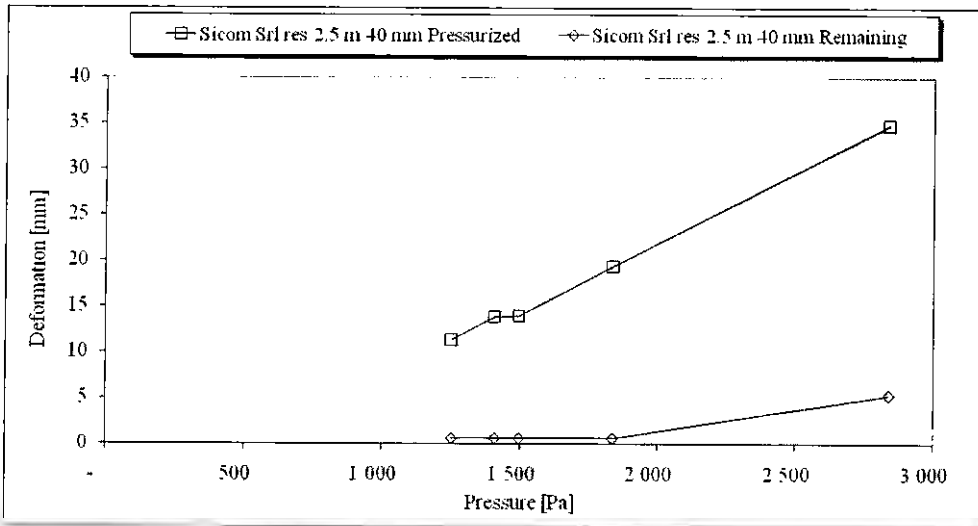

Figure 2 Wind load vs. displacement

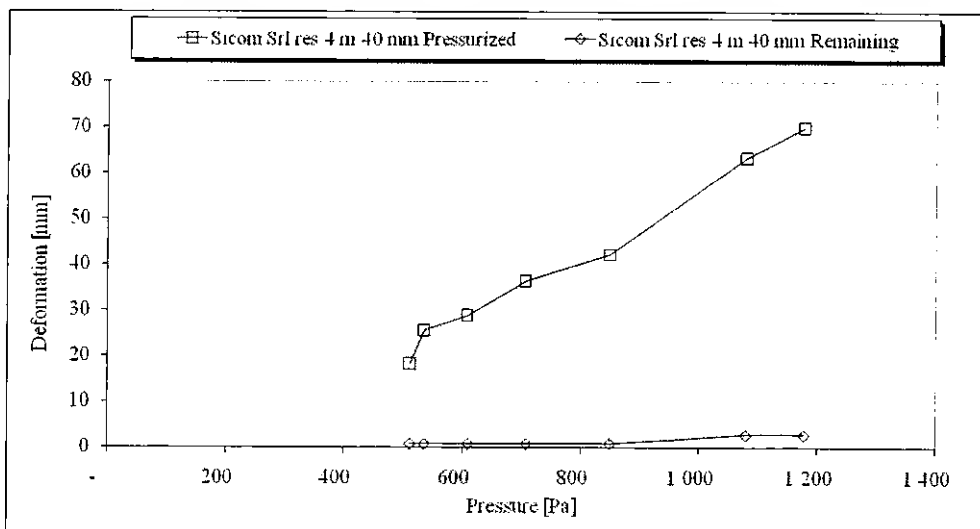

Figure 3 Wind load vs. displacement

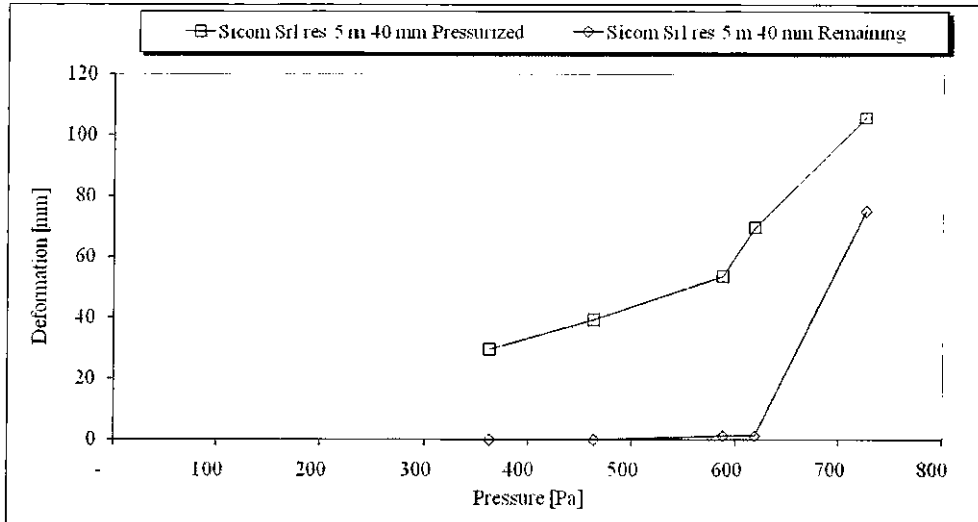

Figure 4 Wind load vs. displacement

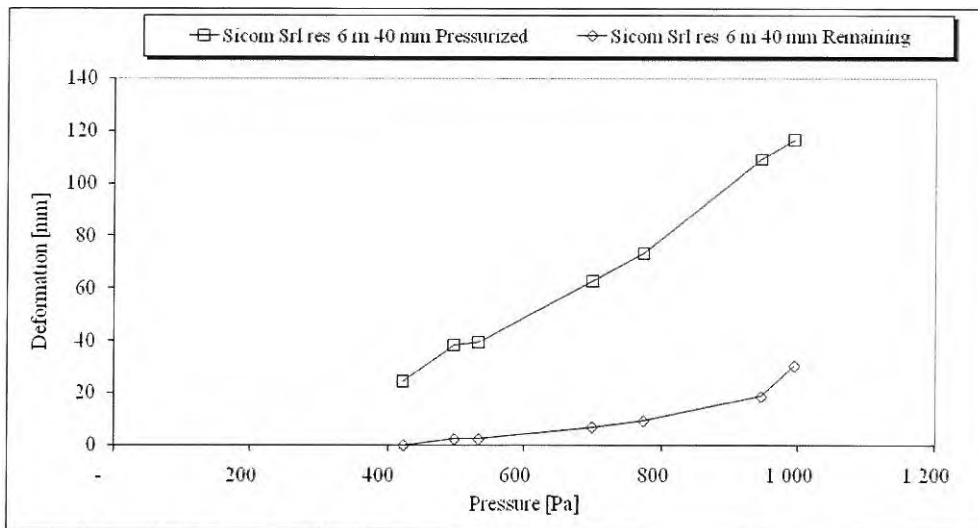

Figure 5 Wind load vs. displacement

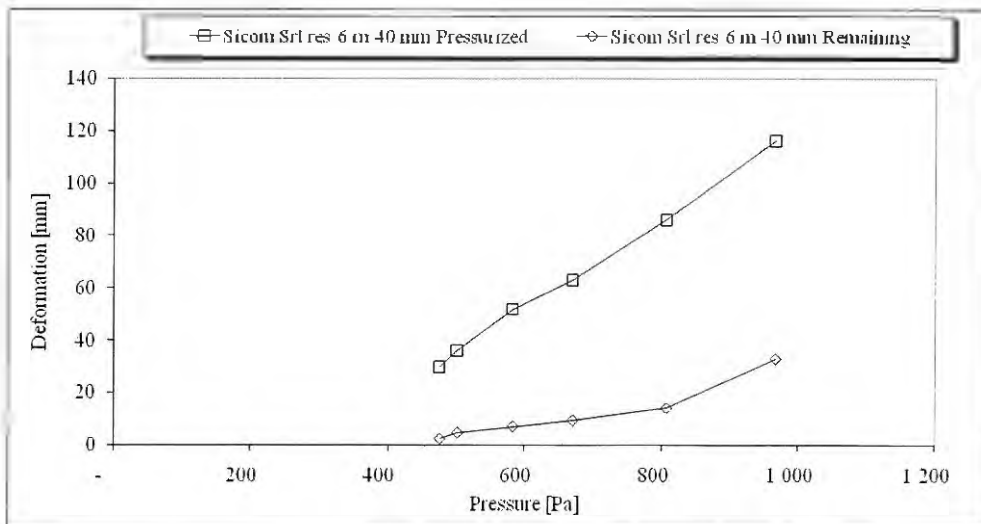

Figure 6 Wind load vs. displacement

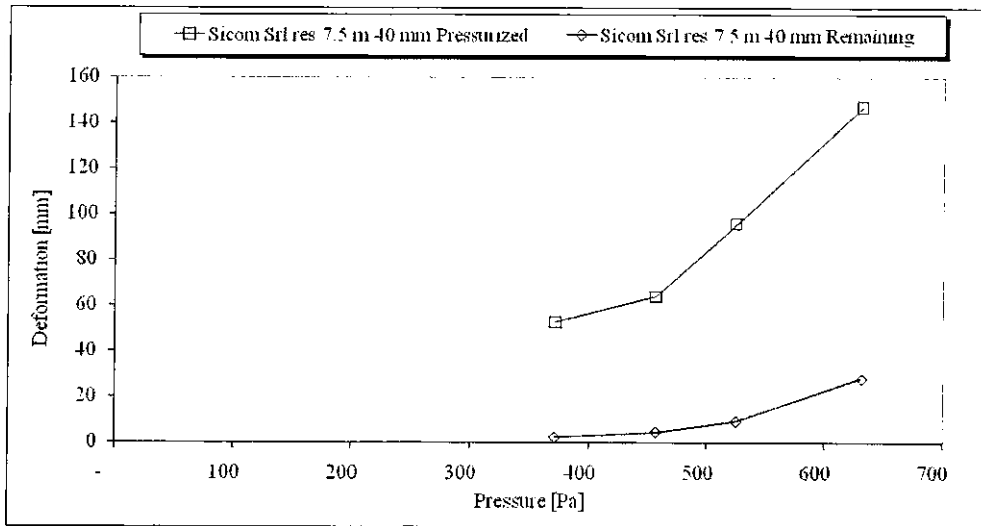

Figure 7 Wind load vs. displacement

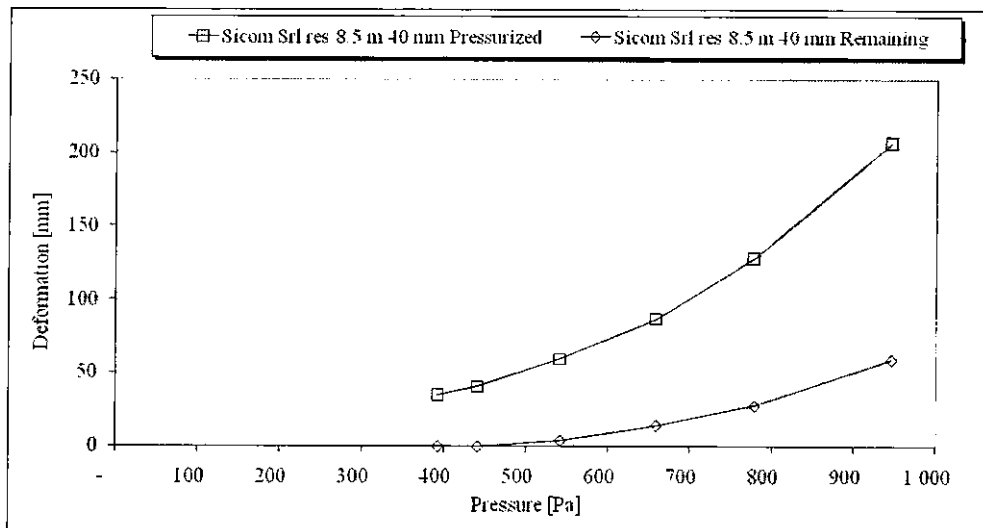
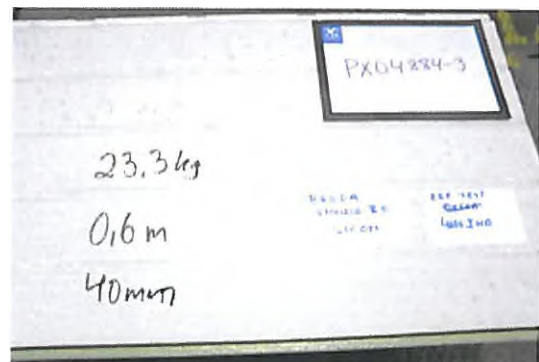

Figure 8 Wind load vs. displacement



Picture 1 Sicom 2500



Picture 2 Sicom 4000

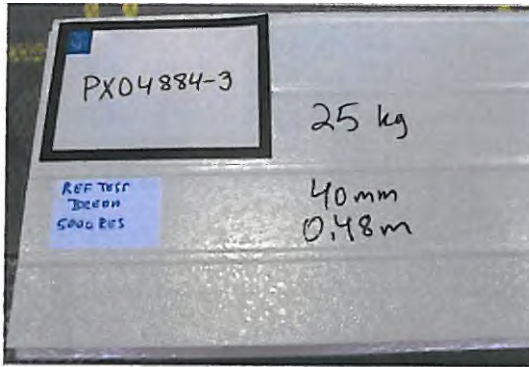

Picture 3 Sicom 5000

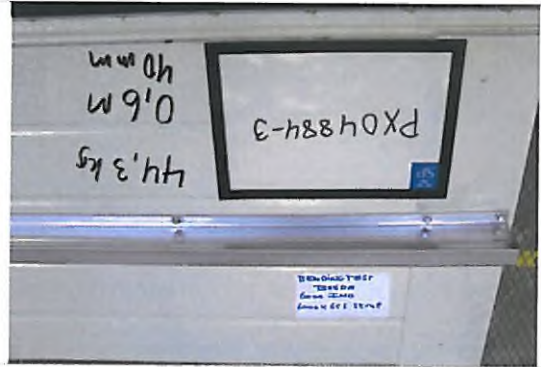

Picture 4 Sicom 6000 IND 6000 x 65S

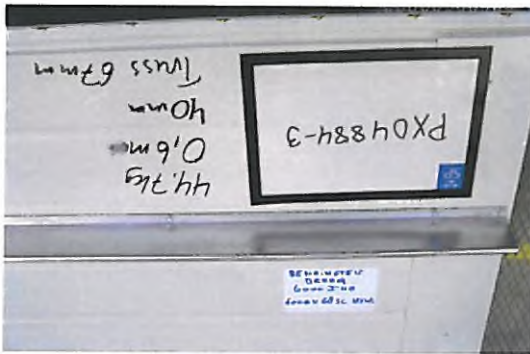

Picture 5 Sicom 6000 IND 6000 x 68SC

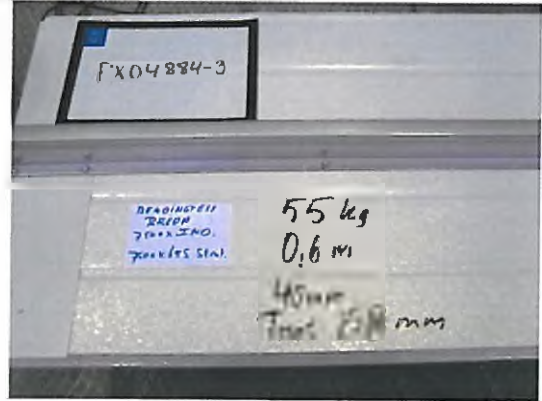

Picture 6 Sicom 7500 IND 7500 x 65S

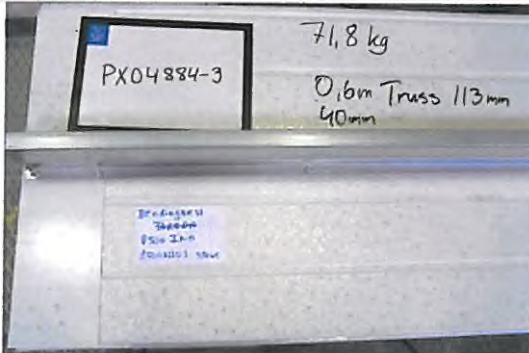

Picture 7 Sicom 8500 IND 8500 x 110S

5 Measurement uncertainty

The total calculated measurement uncertainty is for the wind load $< 1.5\%$ and for the deformations $< 1.5\%$. Reported uncertainty corresponds to an approximate 95 % confidence interval around the measured value. The interval has been calculated in accordance with GUM (The ISO guide to the expression of uncertainty in measurements), which is normally accomplished by quadratic addition of the actual standard uncertainties and multiplication of the resulting combined standard uncertainty by the coverage factor $k=2$.

SP Technical Research Institute of Sweden
Building Technology and Mechanics - Solid Mechanics and Structures



Daniel Andersson
Technical Officer



Lars Andersson
Technical Manager

Handled by, department
Roger Davidsson
Energy Technology
+46 10 516 56 54. roger.davidsson@sp.se

Sicom Srl
2 Via Cecilia Danieli
I-33090 Sequals
Italy

Determination of air permeability, resistance to water penetration and resistance to wind load according to EN 13241-1

(1 appendix)

Test object

Client:	Flexi-Force
Product name:	Sicom
Type of door:	Residential, overhead, sectional door
Daylight size:	Width 2500 mm, height 2610 mm

The door was supplied and installed by the client in the opening of an airtight chamber, with its exterior facing inwards towards the chamber, see figure 2 in appendix 1.

Summary of classification

Air permeability according to EN 12426:	Class 2
Resistance to water penetration according to EN 12425:	Class 3, 110 Pa
Resistance to wind load according to EN 12424:	Class 5, 1400 Pa

Test procedure

Air permeability

A positive air pressure was established in the chamber and the air leakage was measured at 50 Pa.

The tests were carried out in accordance with EN 12427.

Resistance to water penetration

Water was applied through two horizontal rows of nozzles with seven nozzles on each row. The upper row supplied 2 ± 0.2 l/min of water per nozzle. The lower row supplied 1 ± 0.1 l/min of water per nozzle.

The test was carried out in accordance with EN 12489.

Resistance to wind load

The door was tested in accordance with EN 12444 in an air pressure chamber. Before the test measures were taken to minimize air leakage in the door and its supporting construction. The air pressure in the test chamber was increased in steps in accordance with the different classes given in EN 12424.

The test was carried out in accordance with EN 12444.

SP Technical Research Institute of Sweden

Postal address
SP
Box 857
SE-501 15 BORÅS
Sweden

Office location
Västeråsen
Brinellgatan 4
Borås

Phone / Fax / E-mail
+46 10 516 50 00
+46 33 13 55 02
info@sp.se

Laboratories are accredited by the Swedish Board of Accreditation and Conformity Assessment (SWEDAC) under the terms of Swedish legislation. This report may not be reproduced other than in full, except with the prior written approval of the issuing laboratory.

Test results

Air permeability

Leakage at 50 Pa positive pressure: 7,0 m³/h,m²
Classification according to EN 12426: Class 2

Resistance to water penetration

The test was interrupted after 130 Pa and 45 minutes.



Figure 1. The door as seen from inside.

Air pressure (Pa)	Time (min)	Degree of water leakage at location			
		A	B	C	D
0	0-10	0	0	0	0
10	11-15	0	0	0	0
30	16-20	3	0	0	0
50	21-25	3	0	0	0
70	26-30	3	2	0	0
90	31-35	3	3	2	0
110	36-40	3	4	3	0
130	41-45	3	4	3	3

Location of leakage:

- A: Leakage at the end of the bottom sealing
- B: Leakage between the panels at the edge
- C: Leakage between the panels at the edge
- D: Splash of water from leakage B and C

Degree of water leakage:

- 0: No leak
- 1: One clinging drop
- 2: Two or more falling or chain drops
- 3: Runs
- 4: Considerable flow

Failure according to leakage D.

Classification according to EN 12425:

Class 3, 110 Pa

Resistance to wind load

The test was interrupted after the inner pressure step at 1925 Pa. After the test the screws to the side hinges had started to come loose from the panel.

No visible deformations were noted before that.

Classification according to EN 12424:

Class 5, 1400 Pa

Conditions of test

The test results refer only to the tested object.

- Date of test: 2010-08-17
- Place of test: SP Energy Technology, Boras, Sweden
- Equipment used: Measuring equipment no. 202733, 202429, 202214
Test rig no. 200417
- Estimated error margin: Air pressure difference $\pm 2\%$, air flow $\pm 5\%$, water flow $\pm 5\%$
- Ambient climate: Air temperature 22 °C, RH 62 %, atmospheric pressure 981 hPa
- Water temperature: According to the requirements of the standard

SP Technical Research Institute of Sweden
Energy Technology - Building Physics and Indoor Environment



Roger Davidsson
Technical Officer



Hans Brolin
Technical Manager

Description of the door

Product name	Sicom
Daylight size	Width 2500 mm, Height 2610 mm
Type and producer of panels	Secur-Pan finger safe, Sicom
Panel thickness	42 mm
Type of tracks	FlexiForce RES X
Type of rollers	FlexiForce 574 RES
Type of hinges	FlexiForce 420 Series
Type of top sealing	FlexiForce 1036-36
Type of bottom sealing	FlexiForce 1039
Height of bottom sealing	15 mm
Type of side sealing	FlexiForce 1085



Figure 2. Door type FlexiForce RES X with Sicom panels mounted in the test rig, as seen from inside.



Handled by, department
Roger Davidsson
Energy Technology
+46 10 516 56 54. roger.davidsson@sp.se

Sicom Srl
2 Via Cecilia Danieli
I-33090 Sequals
Italy

Determination of air permeability, resistance to water penetration and resistance to wind load according to EN 13241-1

(1 appendix)

Test object

Client:	Flexi-Force
Product name:	Sicom
Type of door:	Industrial, overhead, sectional door
Daylight size:	Width 4000 mm, height 3400 mm

The door was supplied and installed by the client in the opening of an airtight chamber, with its exterior facing inwards towards the chamber, see figure 2 in appendix 1.

Summary of classification

Air permeability according to EN 12426:	Class 3
Resistance to water penetration according to EN 12425:	Class 3, 150 Pa
Resistance to wind load according to EN 12424:	Class 3

Test procedure

Air permeability

A positive air pressure was established in the chamber and the air leakage was measured at 50 Pa.

The tests were carried out in accordance with EN 12427.

Resistance to water penetration

Water was applied through three horizontal rows of nozzles with ten nozzles on each row. The upper row supplied 2 ± 0.2 l/min of water per nozzle. The two lower rows supplied 1 ± 0.1 l/min of water per nozzle.

The test was carried out in accordance with EN 12489.

Resistance to wind load

The door was tested in accordance with EN 12444 in an air pressure chamber. Before the test measures were taken to minimize air leakage in the door and its supporting construction. The air pressure in the test chamber was increased in steps in accordance with the different classes given in EN 12424.

The test was carried out in accordance with EN 12444.

SP Technical Research Institute of Sweden

Postal address
SP
Box 857
SE-501 15 BORÅS
Sweden

Office location
Västeråsen
Brinellgatan 4
Boras

Phone / Fax / E-mail
+46 10 516 50 00
+46 33 13 55 02
info@sp.se

Laboratories are accredited by the Swedish Board for Accreditation and Conformity Assessment (SWEDAC) under the terms of Swedish legislation. This report may not be reproduced other than in full, except with the prior written approval of the issuing laboratory.

Test results

Air permeability

Leakage at 50 Pa positive pressure: 5,5 m³/h,m²
Classification according to EN 12426: Class 3

Resistance to water penetration

The test was interrupted after 170 Pa and 55 minutes.

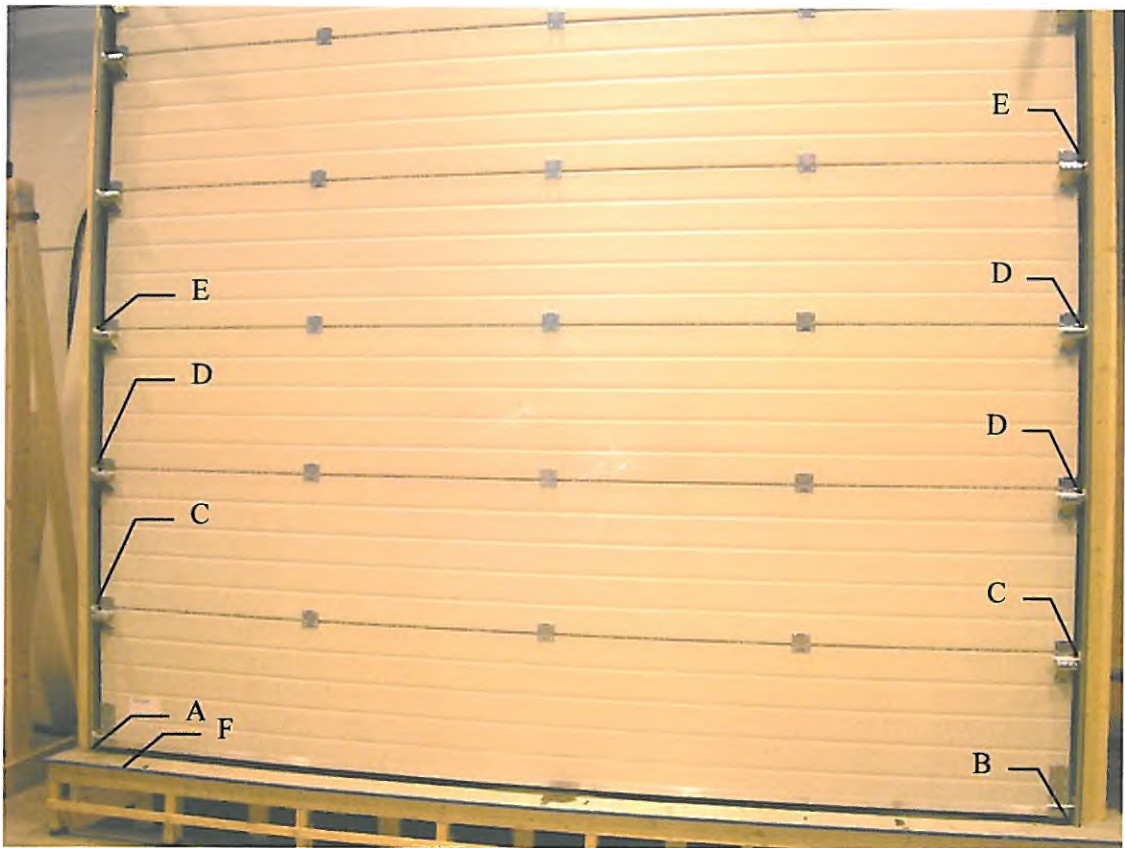

Figure 1. The door as seen from inside.

Air pressure (Pa)	Time (min)	Degree of water leakage at location					
		A	B	C	D	E	F
0	0-10	4	0	0	0	0	0
10	11-15	4	0	0	0	0	0
30	16-20	4	3	0	0	0	0
50	21-25	4	3	3	0	0	0
70	26-30	4	3	3	3	0	0
90	31-35	4	3	3	3	3	0
110	36-40	4	3	3	3	3	0
130	41-45	4	3	3	3	3	0
150	46-50	4	3	3	3	3	0
170	51-55	4	3	3	3	3	3

Location of leakage:

- A: Leakage at the end of the bottom sealing
- B: Leakage at the end of the bottom sealing
- C: Leakage between the panels at the edge
- D: Leakage between the panels at the edge
- E: Leakage between the panels at the edge
- F: Splash of water from leakage C, D and E

Degree of water leakage:

- 0: No leak
- 1: One clinging drop
- 2: Two or more falling or chain drops
- 3: Runs
- 4: Considerable flow

Failure according to leakage F.

Classification according to EN 12425:

Class 3, 150 Pa

Resistance to wind load

The panels collapsed at an inner pressure of about 1075 Pa.

No visible deformations were noted before that.

Classification according to EN 12424:

Class 3

Conditions of test

The test results refer only to the tested object.

- Date of test: 2010-08-16
- Place of test: SP Energy Technology, Boras, Sweden
- Equipment used: Measuring equipment no. 202733, 202429, 202214
Test rig no. 200417
- Estimated error margin: Air pressure difference $\pm 2\%$, air flow $\pm 5\%$, water flow $\pm 5\%$
- Ambient climate: Air temperature 22 °C, RH 58 %, atmospheric pressure 993 hPa
- Water temperature: According to the requirements of the standard

**SP Technical Research Institute of Sweden
Energy Technology - Building Physics and Indoor Environment**



Roger Davidsson
Technical Officer



Hans Brolin
Technical Manager

Description of the door

Product name	Sicom
Daylight size	Width 4000 mm, Height 3400 mm
Type and producer of panels	Secur-Pan finger safe, Sicom
Panel thickness	42 mm
Type of tracks	FlexiForce Standard lift
Type of rollers	FlexiForce 574-60
Type of hinges	FlexiForce 420 Series
Type of top sealing	FlexiForce 1036-36
Type of bottom sealing	FlexiForce 1035
Height of bottom sealing	25 mm
Type of side sealing	FlexiForce 1085



Figure 2. Door type FlexiForce, Standard Lift with Sicom panels mounted in the test rig, as seen from inside.