

RETROGRADE FEMORAL NAIL

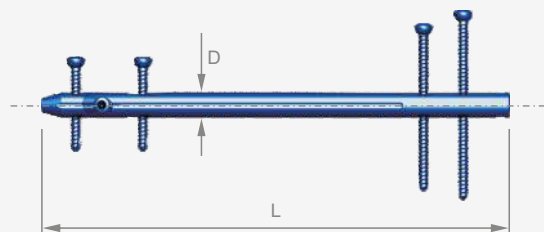

L (mm)	D=9mm	D=10mm	D=11mm	D=12mm	D=13mm
150	X-07-64-150	X-07-65-150	X-07-66-150	X-07-67-150	X-07-68-150
160	X-07-64-160	X-07-65-160	X-07-66-160	X-07-67-160	X-07-68-160
170	X-07-64-170	X-07-65-170	X-07-66-170	X-07-67-170	X-07-68-170
180	X-07-64-180	X-07-65-180	X-07-66-180	X-07-67-180	X-07-68-180
190	X-07-64-190	X-07-65-190	X-07-66-190	X-07-67-190	X-07-68-190
200	X-07-64-200	X-07-65-200	X-07-66-200	X-07-67-200	X-07-68-200
210	X-07-64-210	X-07-65-210	X-07-66-210	X-07-67-210	X-07-68-210
220	X-07-64-220	X-07-65-220	X-07-66-220	X-07-67-220	X-07-68-220
230	X-07-64-230	X-07-65-230	X-07-66-230	X-07-67-230	X-07-68-230
240	X-07-64-240	X-07-65-240	X-07-66-240	X-07-67-240	X-07-68-240
250	X-07-64-250	X-07-65-250	X-07-66-250	X-07-67-250	X-07-68-250
260	X-07-64-260	X-07-65-260	X-07-66-260	X-07-67-260	X-07-68-260
270	X-07-64-270	X-07-65-270	X-07-66-270	X-07-67-270	X-07-68-270
280	X-07-64-280	X-07-65-280	X-07-66-280	X-07-67-280	X-07-68-280
290	X-07-64-290	X-07-65-290	X-07-66-290	X-07-67-290	X-07-68-290
300	X-07-64-300	X-07-65-300	X-07-66-300	X-07-67-300	X-07-68-300
310	X-07-64-310	X-07-65-310	X-07-66-310	X-07-67-310	X-07-68-310
320	X-07-64-320	X-07-65-320	X-07-66-320	X-07-67-320	X-07-68-320
330	X-07-64-330	X-07-65-330	X-07-66-330	X-07-67-330	X-07-68-330
340	X-07-64-340	X-07-65-340	X-07-66-340	X-07-67-340	X-07-68-340
350	X-07-64-350	X-07-65-350	X-07-66-350	X-07-67-350	X-07-68-350
360	X-07-64-360	X-07-65-360	X-07-66-360	X-07-67-360	X-07-68-360
370	X-07-64-370	X-07-65-370	X-07-66-370	X-07-67-370	X-07-68-370
380	X-07-64-380	X-07-65-380	X-07-66-380	X-07-67-380	X-07-68-380
390	X-07-64-390	X-07-65-390	X-07-66-390	X-07-67-390	X-07-68-390
400	X-07-64-400	X-07-65-400	X-07-66-400	X-07-67-400	X-07-68-400
410	X-07-64-410	X-07-65-410	X-07-66-410	X-07-67-410	X-07-68-410
420	X-07-64-420	X-07-65-420	X-07-66-420	X-07-67-420	X-07-68-420
430	X-07-64-430	X-07-65-430	X-07-66-430	X-07-67-430	X-07-68-430
440	X-07-64-440	X-07-65-440	X-07-66-440	X-07-67-440	X-07-68-440

TRAY 1

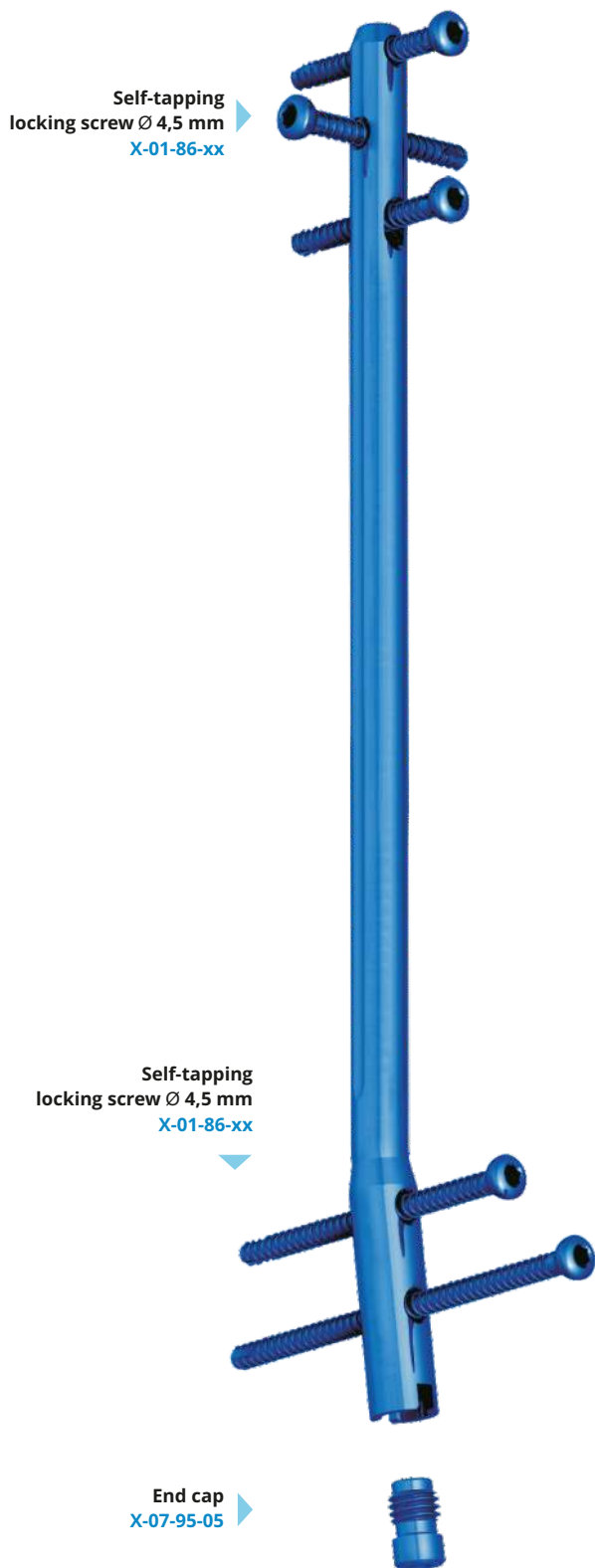
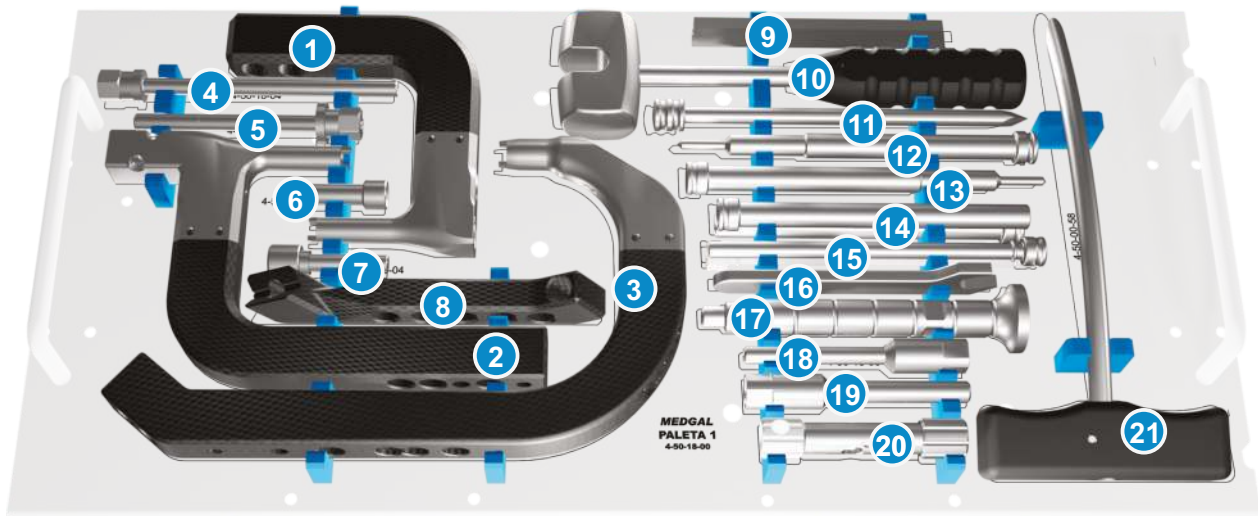

1	Targeting handle for humeral nail	4-50-18-10
2	Targeting handle for tibial nail	4-50-19-01
3	Targeting handle for femoral nail	4-50-17-01
4	Nail holding screw M8 - long	4-50-18-04
5	Nail holding screw M8 - short	4-50-18-05
6	Nail holding screw M10	4-50-17-03
7	Connecting screw	4-50-04-05
8	Targeting adapter for reconstruction holes	4-50-04-04
9	Gauge	4-50-01-12
10	Hammer	4-51-01-16
11	Trocar	4-50-00-07
12	Control Pin Ø 4,6	4-50-00-08
13	Control Pin Ø 4,2	4-50-05-09
14	Protecion sleeve 2 pcs.	4-50-00-06
15	Drill sleeve Ø 3,7 2 pcs.	4-50-00-31
16	Wrench	4-50-00-41
17	Impactor	4-51-01-23
18	Extractor reducer M12/M8	4-50-18-06
19	Extractor reducer M12/M10	4-50-18-07
20	Guide wire handle	4-50-00-18
21	Cannulated awl	4-50-00-58

H = 200 mm
CONTAINER
4-99-100-200



Elements used
for the selected nail



Not used elements



TRAY 2

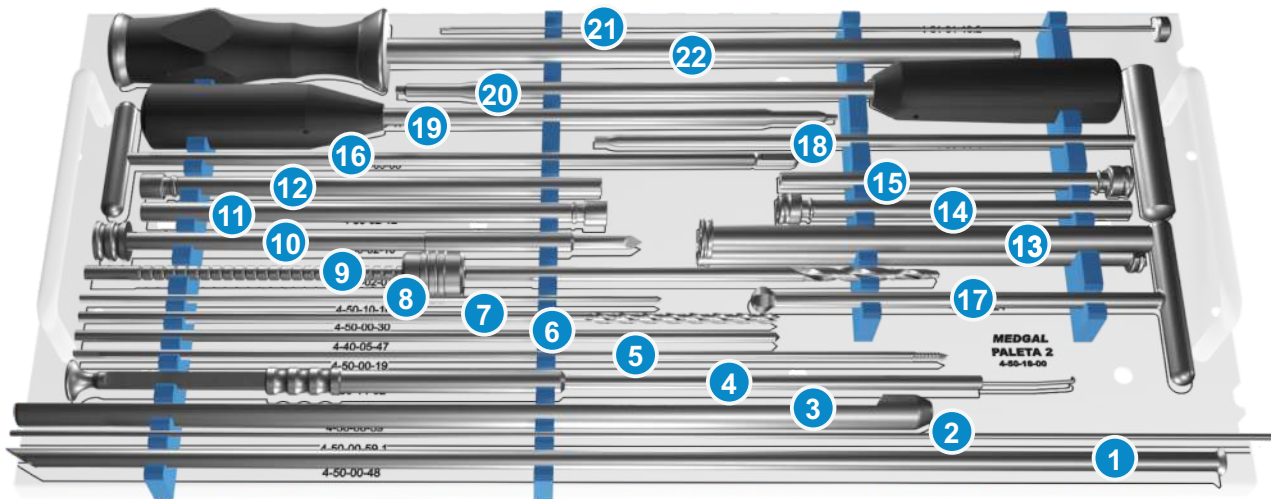

1	Tubular slide	4-50-00-48
2	Guide wire for Nail length gauge	4-50-00-59.1
3	Nail length gauge	4-50-00-59
4	Bone thickness gauge	4-50-14-02
5	Kirschner wire Ø 3 -2 pcs	4-50-00-19
6	Drill Ø 4,7	4-40-05-47
7	Drill Ø 3,7	4-50-00-30
8	Drill Ø 2,5	4-50-10-16
9	Step drill 6,5/4,8	4-50-02-07
10	Trocar	4-50-02-10
11	Drill sleeve Ø 6,5x Ø 9x205mm	4-50-02-12
12	Drill sleeve Ø 3,2x Ø 9x205mm	4-50-02-13
13	Drill sleeve Ø 9/ Ø 12x200mm	4-50-02-11
14	Drill sleeve Ø 4,7/ Ø 8x145mm	4-50-05-10
15	Drill sleeve Ø 6,5x Ø 8x155mm	4-50-05-11
16	Locking set pilot	4-50-05-06
17	Ball-tip screwdriver 10mm	4-51-01-24
18	Screwdriver s3.5 T handle	4-50-00-94
19	Screwdriver s2.5	4-50-10-17
20	Cannulated screwdriver s3,5	4-50-05-12
21	Locking screw of 4-50-05-12	4-51-01-19.2
22	Extractor	4-51-01-47

H = 200 mm
CONTAINER
4-99-100-200



Elements used
for the selected nail



Not used elements



TRAY 3



1	Distal targeting device - femoral nail *	4-50-08-00
2	Distal targeting device - tibial nail *	4-50-25-01
3	Hand targeting device	4-50-00-03
4	Drill sleeve Ø3,7	4-50-00-38
5	Drill sleeve Ø2,5	4-50-10-15
6	Protection sleeve	4-50-00-29
7	Drill sleeve Ø3,7 2 pcs.	4-50-00-371
8	Trocar	4-50-00-57
9	Control pins 2pcs.	4-50-00-22
10	Connecting screw	4-50-18-08



*	Universal distal targeting device - tibial and femoral nail - (4-50-25-01 and 4-50-08-00)	4-50-16-01.M.
---	---	---------------

H = 200 mm
CONTAINER
4-99-100-200



Elements used for the selected nail ■
Not used elements ■



CONTAINED PHRASES ARE NOT DETAILED INSTRUCTION!

CHOOSING THE RIGHT OPERATIVE TECHNIQUE IS RESPONSIBILITY OF THE DOCTOR.

01

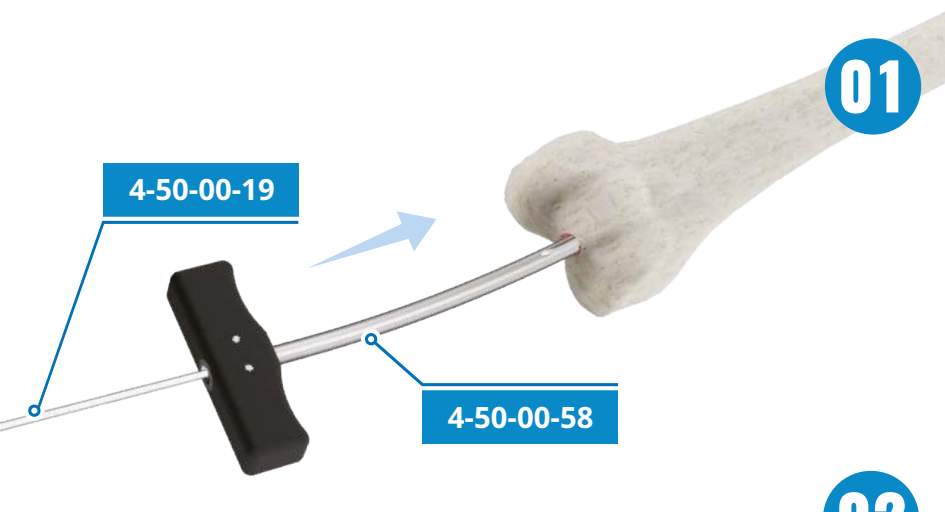

BONE PREPARATION

Insert guide wire **4-50-00-19**.

Open the intramedullary canal using cannulated awl **4-50-00-58**.

02

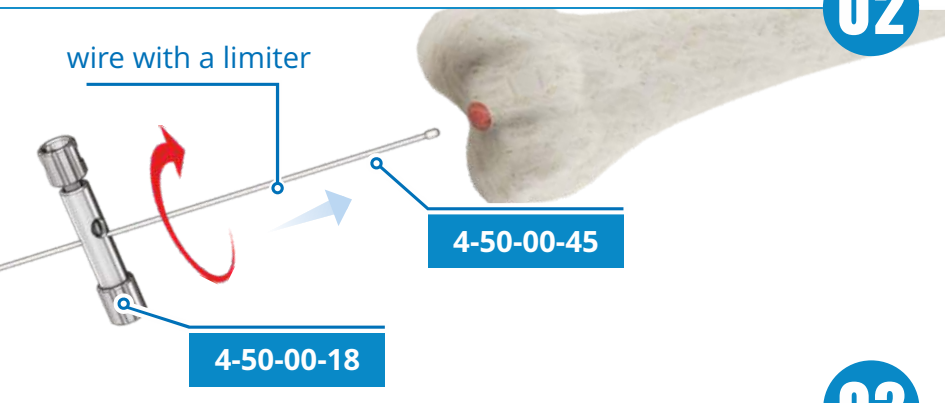

Insert guide wire with a limiter **4-50-00-45** into the intramedullary canal using handle **4-50-00-18**.

03

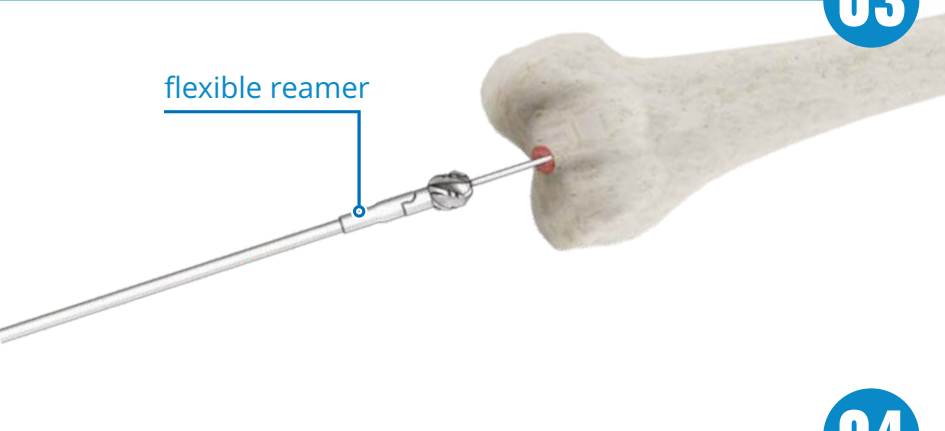

Prepare the intramedullary canal using flexible reamer (starting with the \varnothing 8,0 mm reaming head, ream to a diameter of 1-2 mm greater than the nail diameter. Ream with 0,5 mm increments. Do not force the reamer).

04

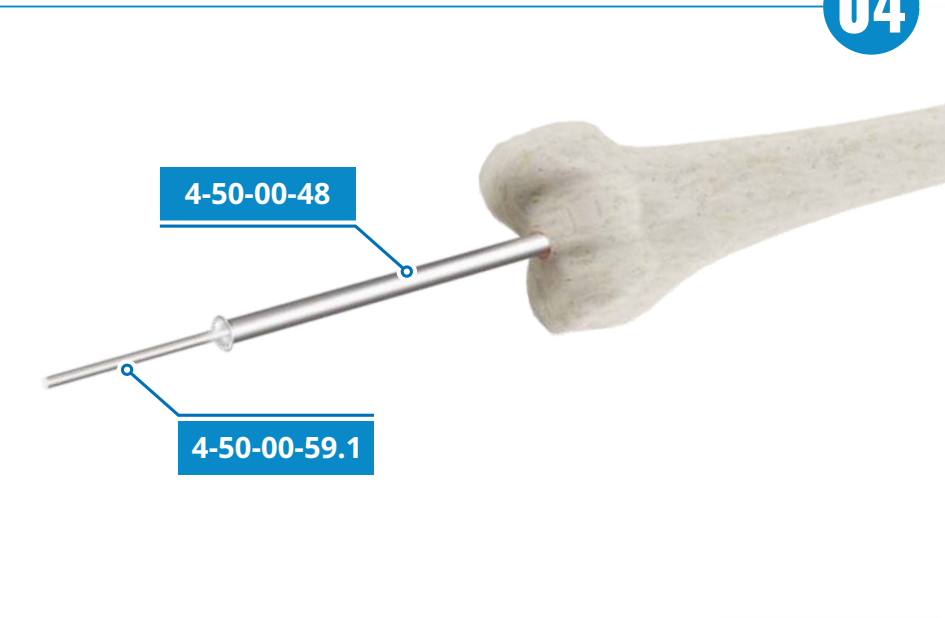

Change guide wire with a limiter **4-50-00-45** to guide wire **4-50-00-59.1** using tubular slide **4-50-00-48**.

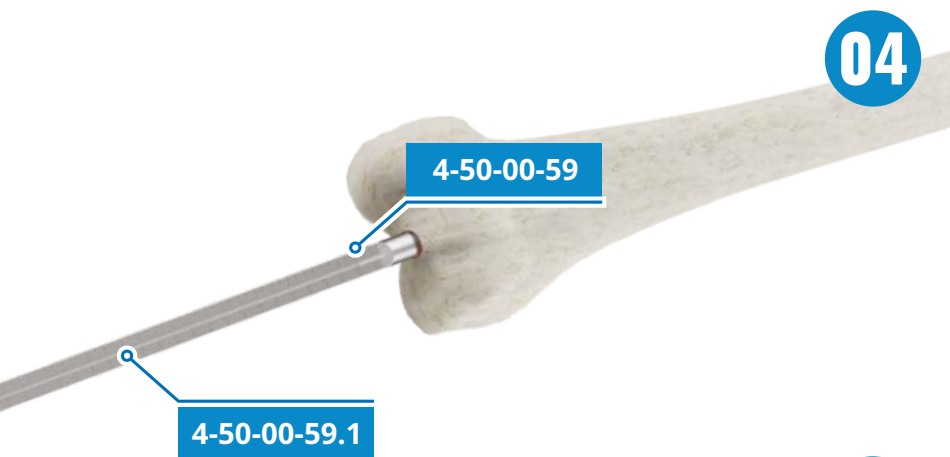

Measure the length of the nail trough the drilled hole using gauge **4-50-00-59** and wire **4-50-00-59.1**.

Change guide wire **4-50-00-59.1** to wire **4-50-00-44** using tubular slide **4-50-00-48**.

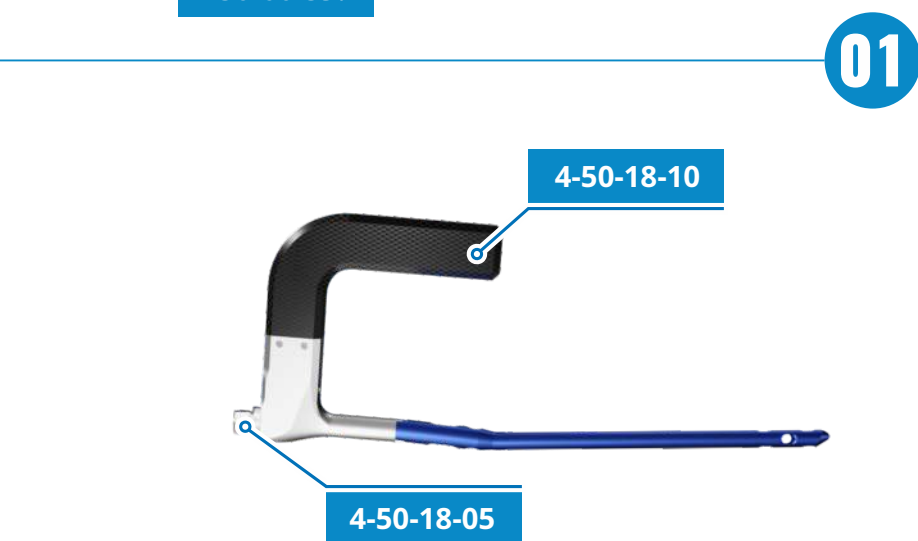

NAIL INSERTION

Assembly targeting device **4-50-18-10** and nail using screw **4-50-18-05** and wrench **4-51-01-24**.



Check holes using control pin **4-50-00-08**.

03



Use impactor **4-51-01-23** and hammer **4-51-01-16** to position the nail.

NOTE :
IMPACTOR SHOULD BE
BLOCKED USING WRENCH **4-50-00-41**
(to prevent damage).

04

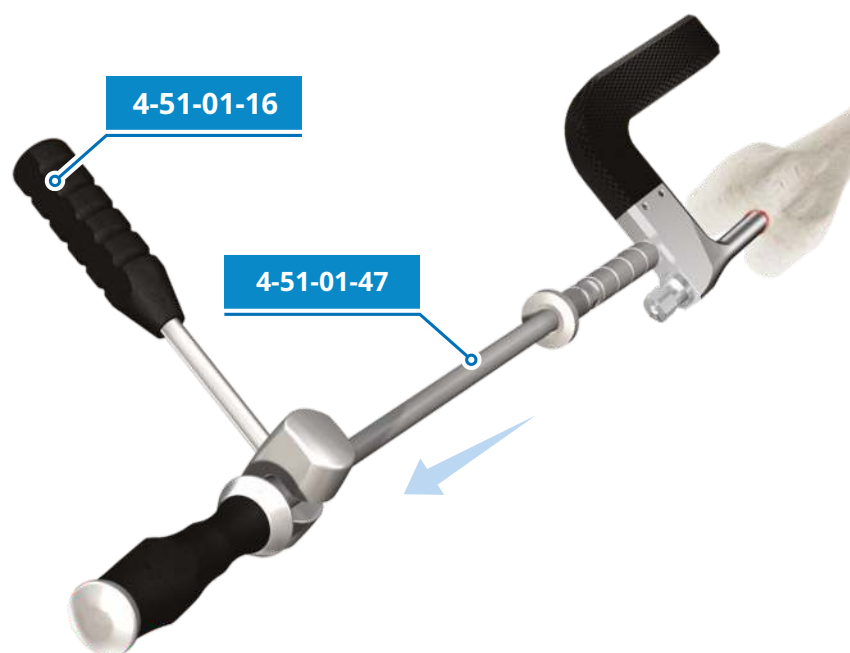

If necessary - use extractor rod **4-51-01-47** to change position of the nail in the bone.

NOTE:
Check the connection between nail
and handle, especially after
hammering.

01

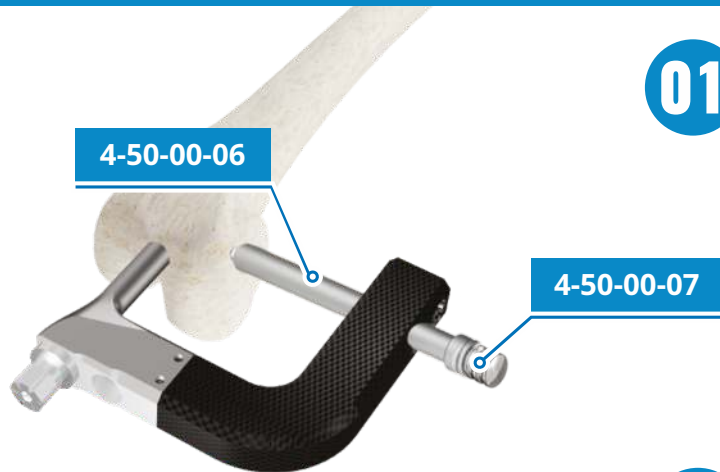

STATIC METHOD

Prepare the cortical bone using the trocar **4-50-00-07** and sleeve **4-50-00-06**.

02

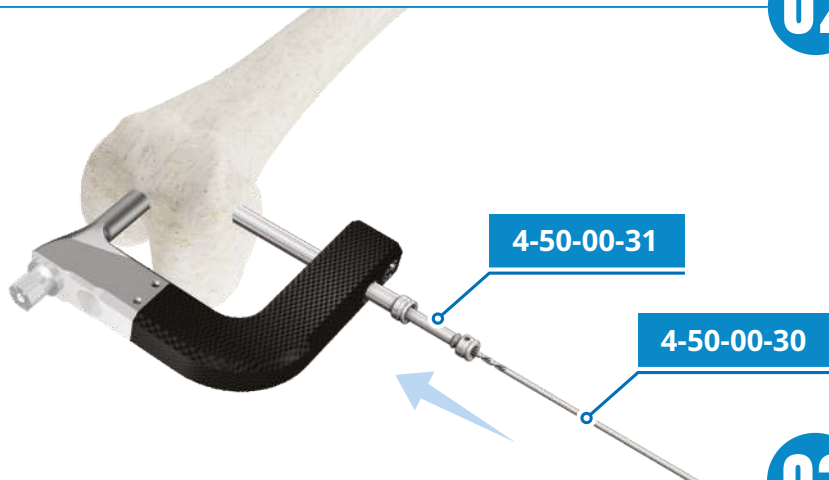

Drill through the compression nail hole using drill **4-50-00-30** and drill sleeve **4-50-00-31**.

03

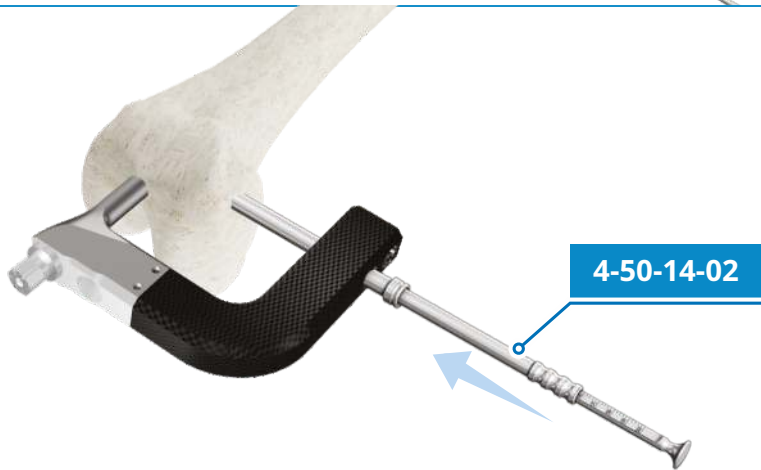

Measure the thickness of the bone through the drilled hole using **4-50-14-02** in order to determine the length of the locking screw.

04



Insert the \varnothing 4,5 mm locking screw using screwdriver **4-50-05-12**.

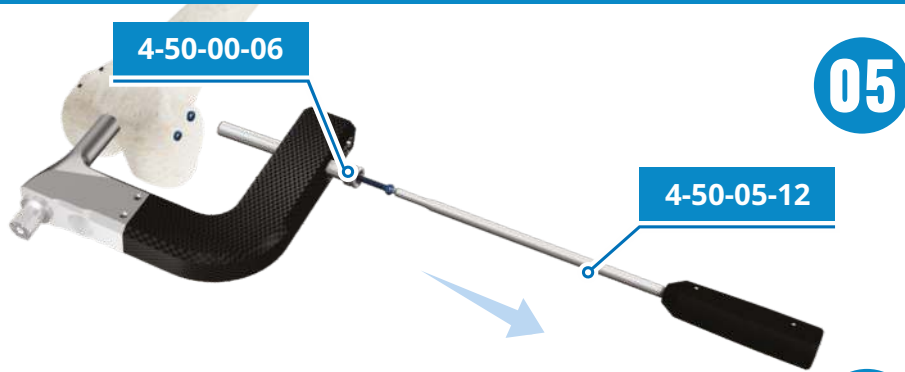

05

Insert the Ø4,5 mm locking screw into the second hole of nail **in the same way** as in the first hole.

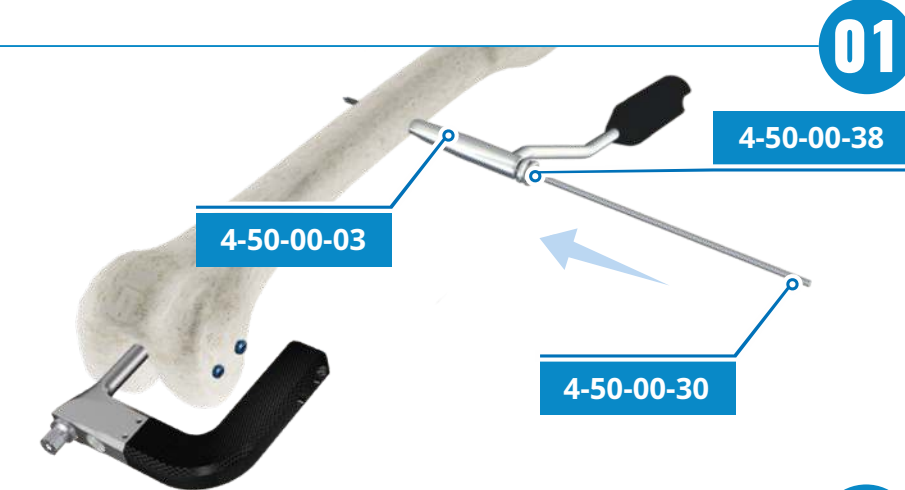

01

FREEHAND LOCKING TECHNIQUE

Drill first distal nail hole using hand targeting device **4-50-00-03** sleeve **4-50-00-38** and drill **4-50-00-30**.

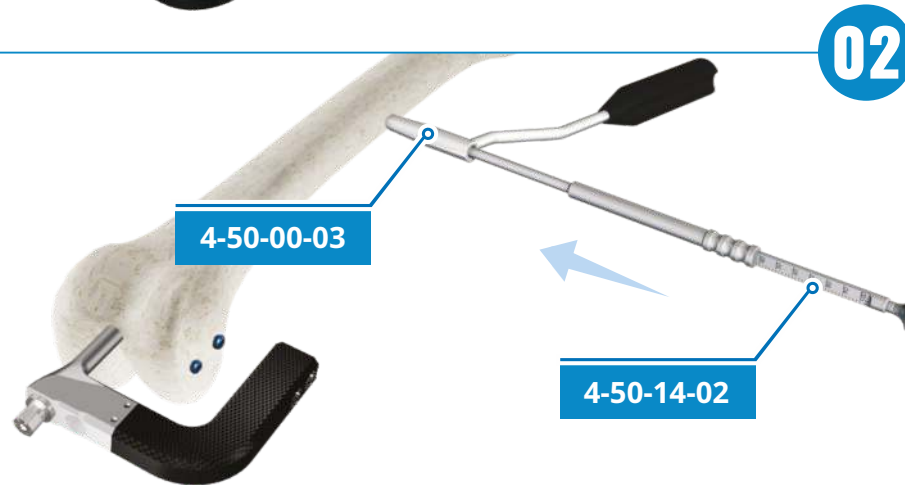

02

Measure the depth of drilling through the drilled hole, with bone thickness gauge **4-50-14-02** in order to determine the length of locking screw.



03

Insert Ø 4,5 mm locking screw in first drilled hole using screwdriver **4-50-05-12**.

Lock other distal holes **in the same way** like the first proximal hole.

01

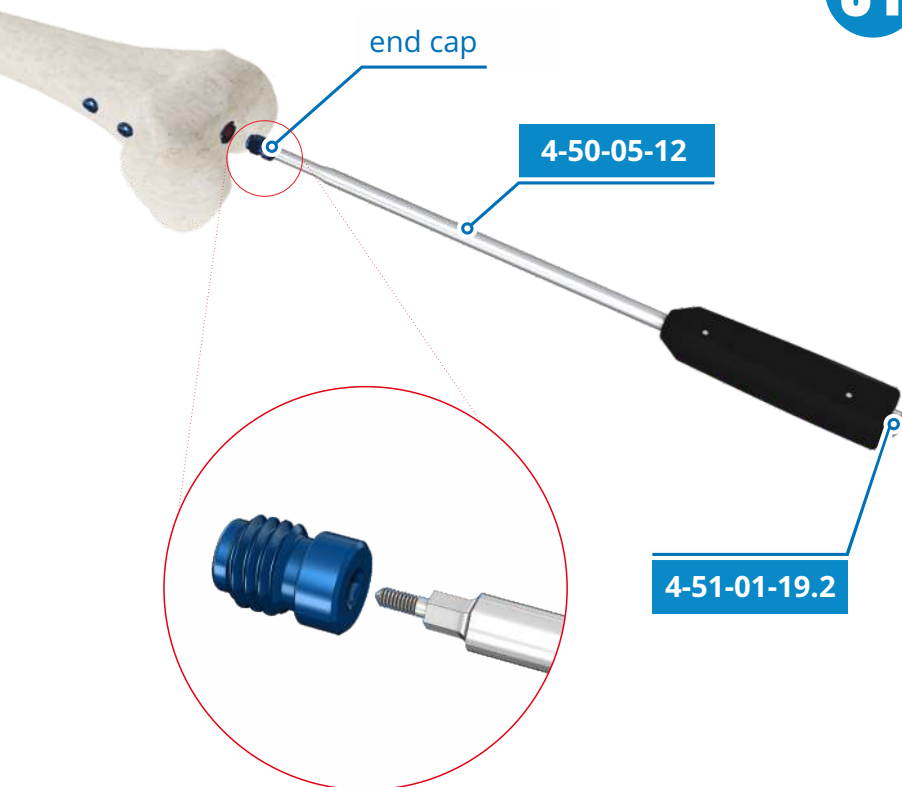

END CAP INSERTION

Insert locking screw **4-51-01-19.2** into screwdriver **4-50-05-12**.

Lock end cap on screwdriver **4-50-05-12** using locking screw **4-51-01-19.2**.

Insert end cap into the nail.
Unscrew the end cap from the screwdriver.

01

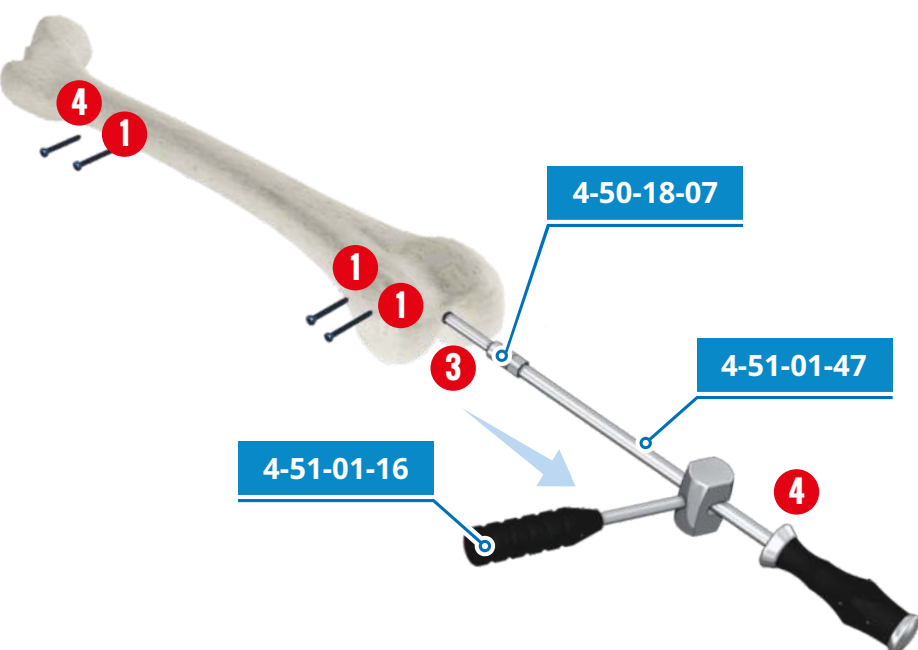

EXTRACTION OF THE NAIL

Clear sockets of end cap and locking screws from any tissue ingrowth.

1. Remove all locking screws except one of the distal locking screw.

2. Remove end cap.

3. Insert extractor reducer **4-50-18-07** into extractor **4-51-01-47**.

Install the set in the nail and remove distal locking screw **(4)**.

Remove the nail using hammer **4-51-01-16**.

RETROGRADE FEMORAL NAIL

with the proximal holes for the Ø 6,5 or for the locking sets.

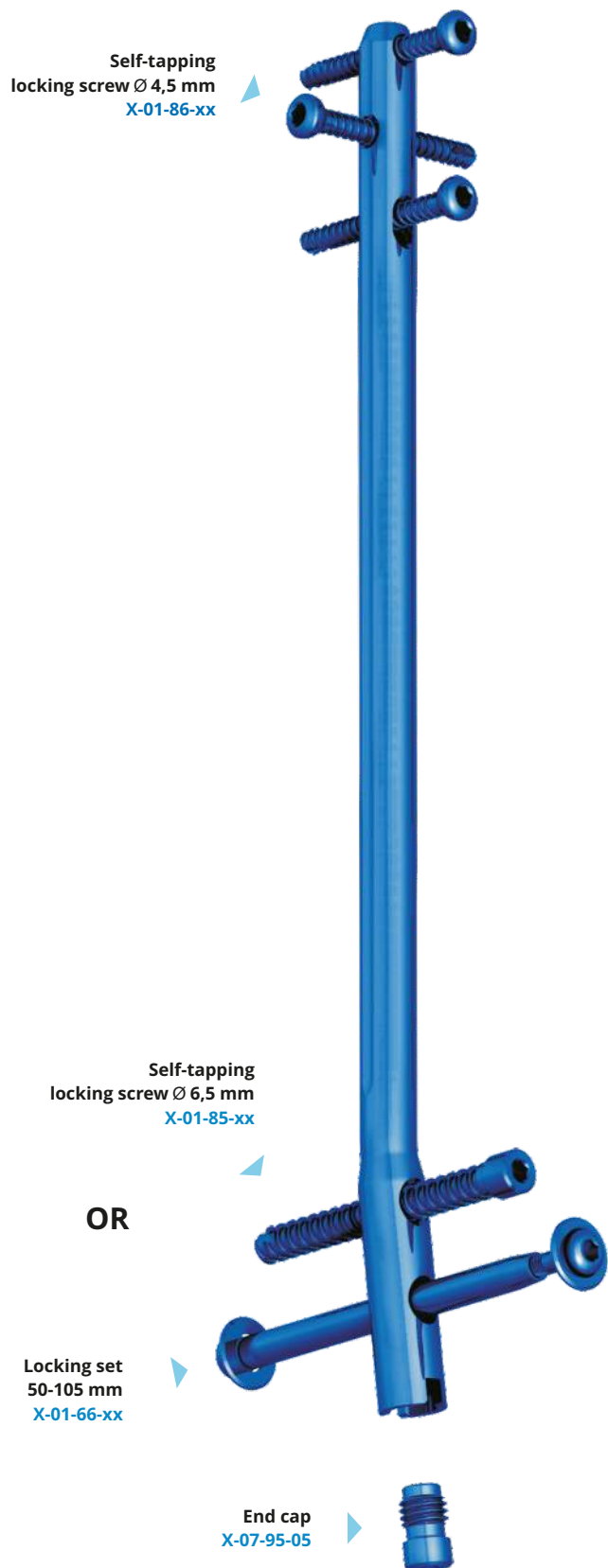

RANGE (mm)	REF
50-60	X-01-66-50
60-75	X-01-66-60
70-85	X-01-66-70
80-95	X-01-66-80
90-105	X-01-66-90

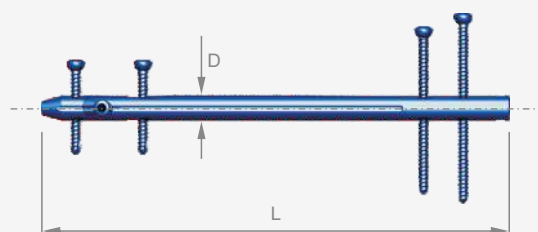

L mm	D=8mm	D=9mm	D=10mm	D=11mm	D=12mm	D=13mm
140	X-07-100-140	X-07-101-140	X-07-102-140	X-07-103-140	X-07-104-140	X-07-105-140
150	X-07-100-150	X-07-101-150	X-07-102-150	X-07-103-150	X-07-104-150	X-07-105-150
160	X-07-100-160	X-07-101-160	X-07-102-160	X-07-103-160	X-07-104-160	X-07-105-160
170	X-07-100-170	X-07-101-170	X-07-102-170	X-07-103-170	X-07-104-170	X-07-105-170
180	X-07-100-180	X-07-101-180	X-07-102-180	X-07-103-180	X-07-104-180	X-07-105-180
190	X-07-100-190	X-07-101-190	X-07-102-190	X-07-103-190	X-07-104-190	X-07-105-190
200	X-07-100-200	X-07-101-200	X-07-102-200	X-07-103-200	X-07-104-200	X-07-105-200
210	X-07-100-210	X-07-101-210	X-07-102-210	X-07-103-210	X-07-104-210	X-07-105-210
220	X-07-100-220	X-07-101-220	X-07-102-220	X-07-103-220	X-07-104-220	X-07-105-220
230	X-07-100-230	X-07-101-230	X-07-102-230	X-07-103-230	X-07-104-230	X-07-105-230
240	X-07-100-240	X-07-101-240	X-07-102-240	X-07-103-240	X-07-104-240	X-07-105-240
250	X-07-100-250	X-07-101-250	X-07-102-250	X-07-103-250	X-07-104-250	X-07-105-250
260	X-07-100-260	X-07-101-260	X-07-102-260	X-07-103-260	X-07-104-260	X-07-105-260
270	X-07-100-270	X-07-101-270	X-07-102-270	X-07-103-270	X-07-104-270	X-07-105-270
280	X-07-100-280	X-07-101-280	X-07-102-280	X-07-103-280	X-07-104-280	X-07-105-280
290	X-07-100-290	X-07-101-290	X-07-102-290	X-07-103-290	X-07-104-290	X-07-105-290
300	X-07-100-300	X-07-101-300	X-07-102-300	X-07-103-300	X-07-104-300	X-07-105-300
310	X-07-100-310	X-07-101-310	X-07-102-310	X-07-103-310	X-07-104-310	X-07-105-310
320	X-07-100-320	X-07-101-320	X-07-102-320	X-07-103-320	X-07-104-320	X-07-105-320
330	X-07-100-330	X-07-101-330	X-07-102-330	X-07-103-330	X-07-104-330	X-07-105-330
340	X-07-100-340	X-07-101-340	X-07-102-340	X-07-103-340	X-07-104-340	X-07-105-340
350	X-07-100-350	X-07-101-350	X-07-102-350	X-07-103-350	X-07-104-350	X-07-105-350
360	X-07-100-360	X-07-101-360	X-07-102-360	X-07-103-360	X-07-104-360	X-07-105-360
370	X-07-100-370	X-07-101-370	X-07-102-370	X-07-103-370	X-07-104-370	X-07-105-370
380	X-07-100-380	X-07-101-380	X-07-102-380	X-07-103-380	X-07-104-380	X-07-105-380
390	X-07-100-390	X-07-101-390	X-07-102-390	X-07-103-390	X-07-104-390	X-07-105-390
400	X-07-100-400	X-07-101-400	X-07-102-400	X-07-103-400	X-07-104-400	X-07-105-400
410	X-07-100-410	X-07-101-410	X-07-102-410	X-07-103-410	X-07-104-410	X-07-105-410
420	X-07-100-420	X-07-101-420	X-07-102-420	X-07-103-420	X-07-104-420	X-07-105-420
430	X-07-100-430	X-07-101-430	X-07-102-430	X-07-103-430	X-07-104-430	X-07-105-430
440	X-07-100-440	X-07-101-440	X-07-102-440	X-07-103-440	X-07-104-440	X-07-105-440

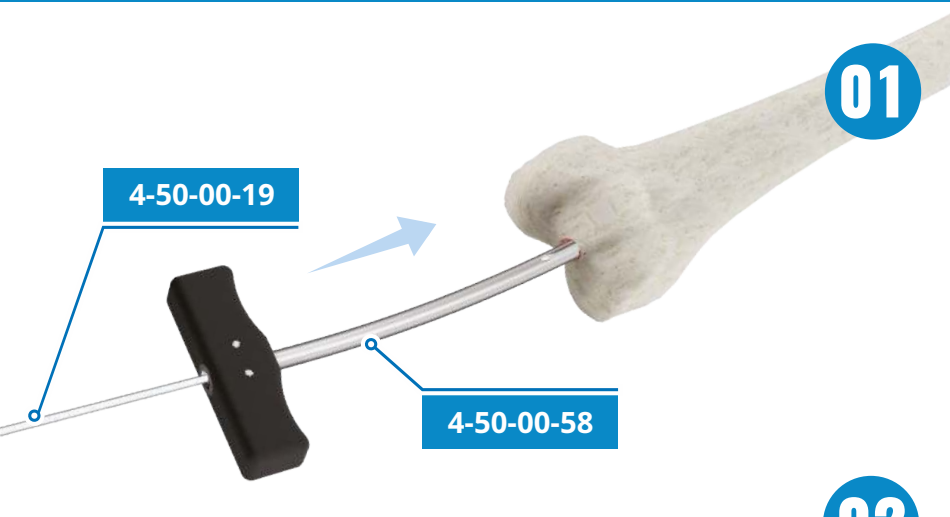

BONE PREPARATION

Insert guide wire **4-50-00-19**.

Open the intramedullary canal using cannulated awl **4-50-00-58**.

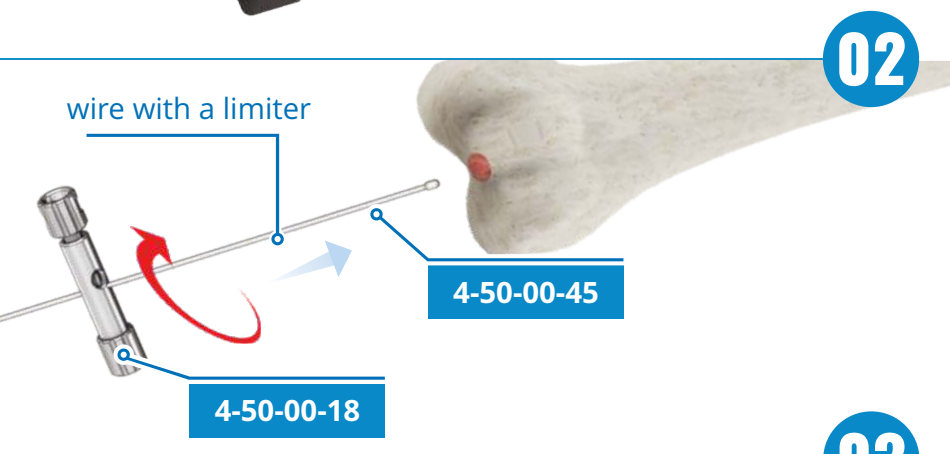

Insert guide wire with a limiter **4-50-00-45** into the intramedullary canal using handle **4-50-00-18**.

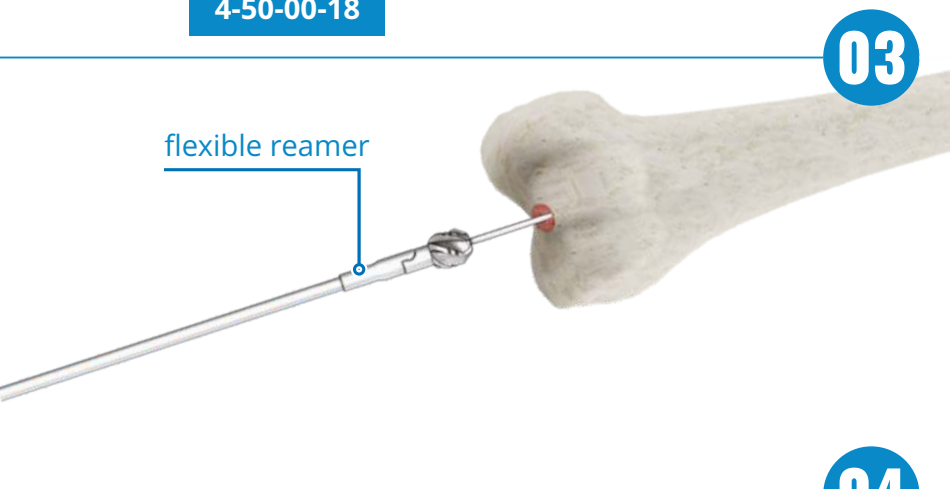

Prepare the intramedullary canal using flexible reamer (starting with the \varnothing 8,0 mm reaming head, ream to a diameter of 1-2 mm greater than the nail diameter. Ream with 0,5 mm increments. Do not force the reamer).

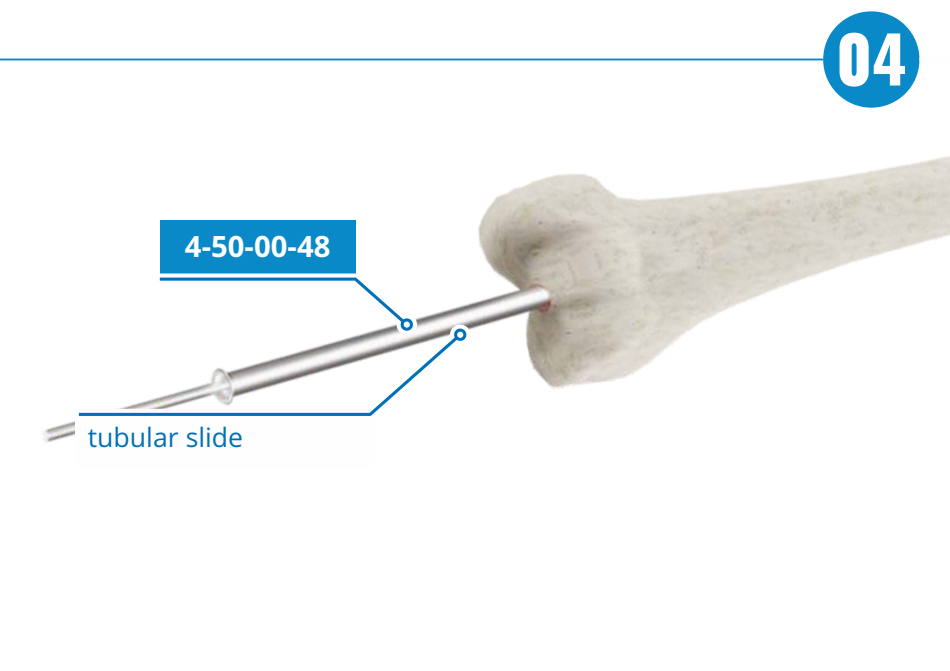

Change guide wire with a limiter **4-50-00-45** to guide wire **4-50-00-59.1** using tubular slide **4-50-00-48**.

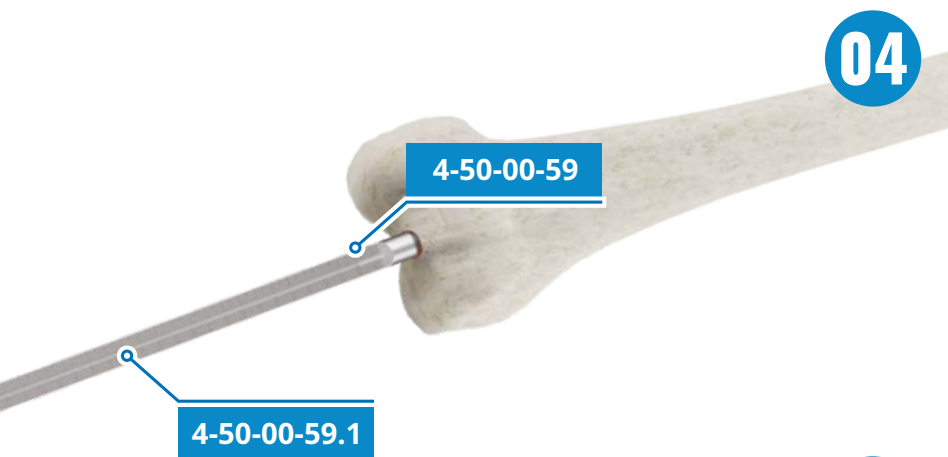

Measure the length of the nail trough the drilled hole using gauge **4-50-00-59** and wire **4-50-00-59.1**.

Change guide wire **4-50-00-59.1** to wire **4-50-00-44** using tubular slide **4-50-00-48**.

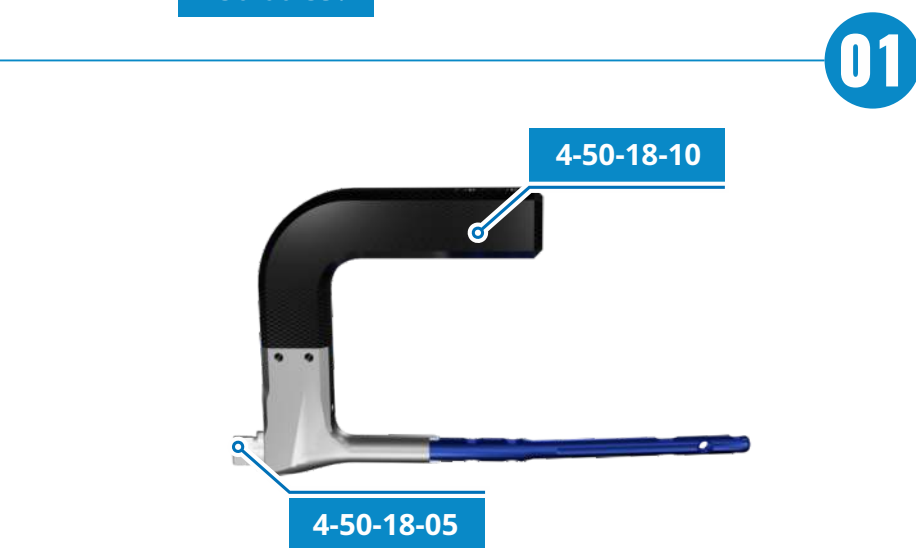

NAIL INSERTION

Assembly targeting device **4-50-18-10** and nail using screw **4-50-18-05** and wrench **4-51-01-24**.

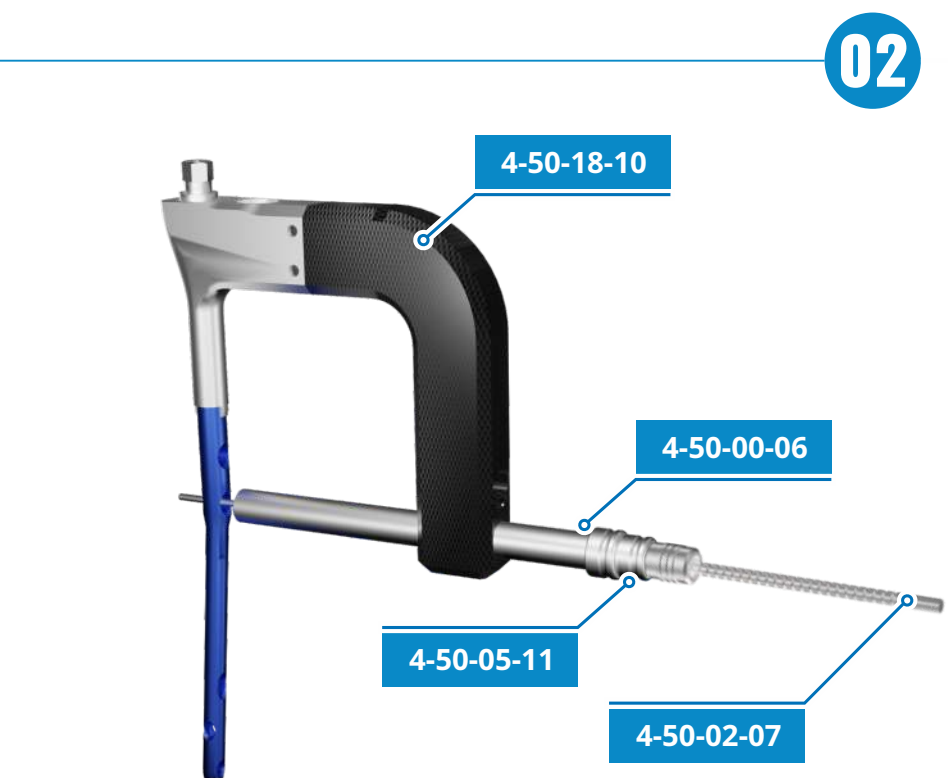

Check holes using sleeve **4-50-00-06**, **4-50-05-11** and drill **4-50-02-07**.

01

STATIC METHOD

Prepare the cortical bone using the trocar **4-50-00-07** and sleeve **4-50-00-06**.

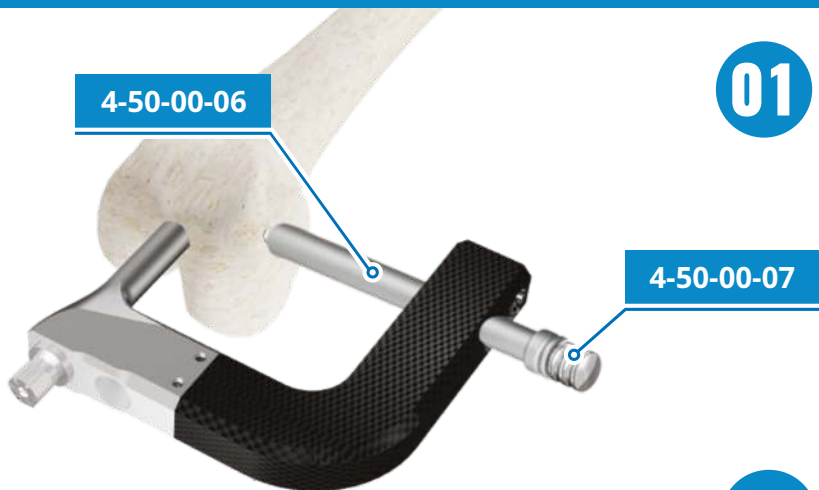

02

Drill through the first nail hole using step drill **4-50-02-07**, sleeve **4-50-00-06** and drill sleeve **4-50-05-11**.



03

Insert the pilot of the locking set **4-50-05-06** through drill sleeve **4-50-05-11**.



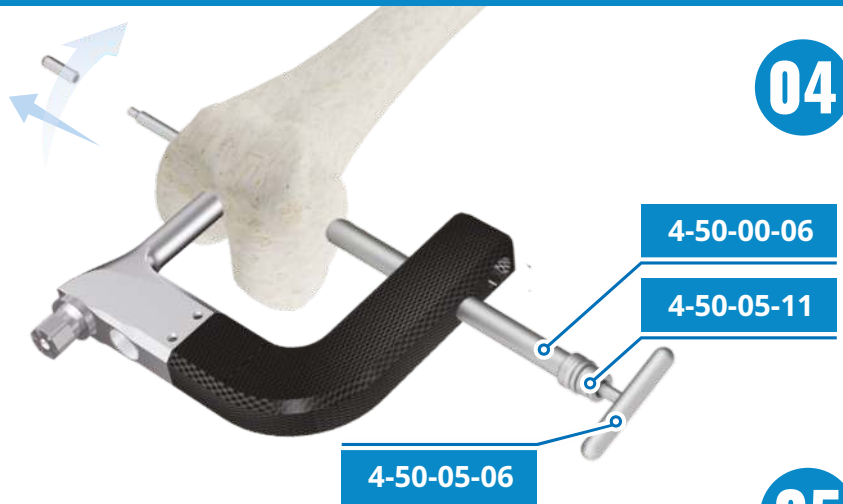

04

Remove ending of the locking set pilot.



05

Fix the pivot **X-01-66-XX** on the pilot **4-50-05-06**.

Implicate the pivot into the drilled hole.



06

Remove the pilot from the locking set pivot. To fix rotation movement of the pilot, use the T-handle screwdriver **4-50-00-94**.

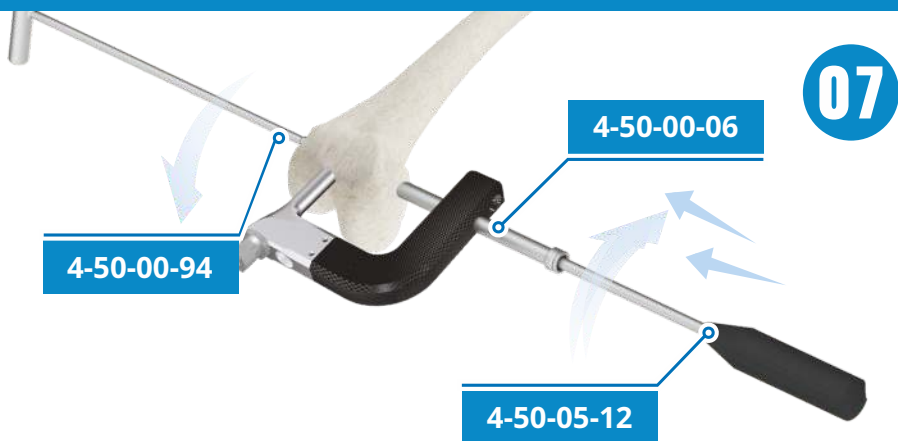

07

Insert screw of the locking set into the pivot using the s 3,5 screwdriver **4-50-05-12** and T- handle screwdriver **4-50-00-94**.

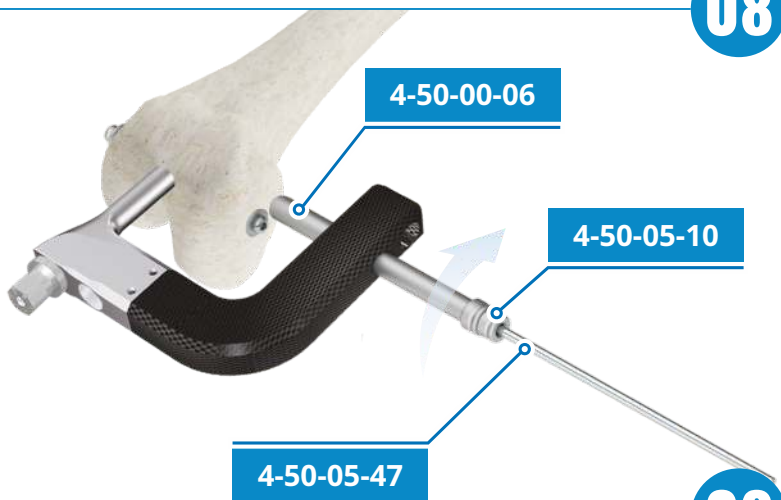

08

Drill through the second nail hole using the Ø 4,7 drill **4-50-05-47**.

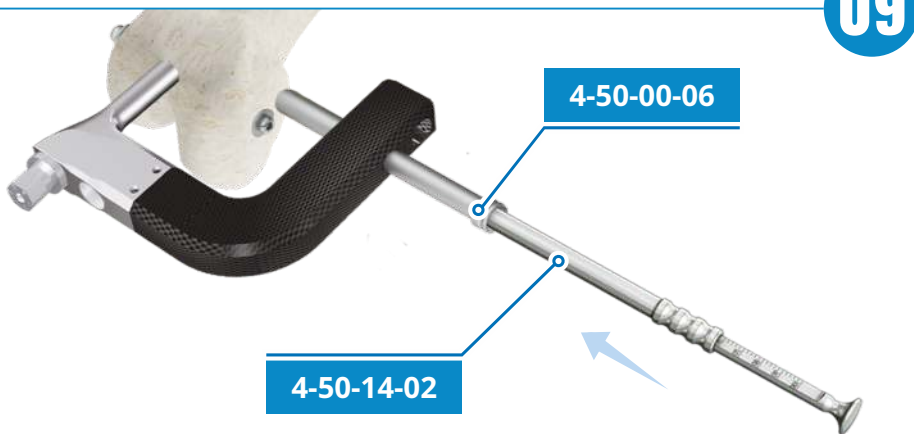

09

Measure the thickness of the bone through the drilled hole, in order to determine the length of the locking screw using **4-50-14-02**.

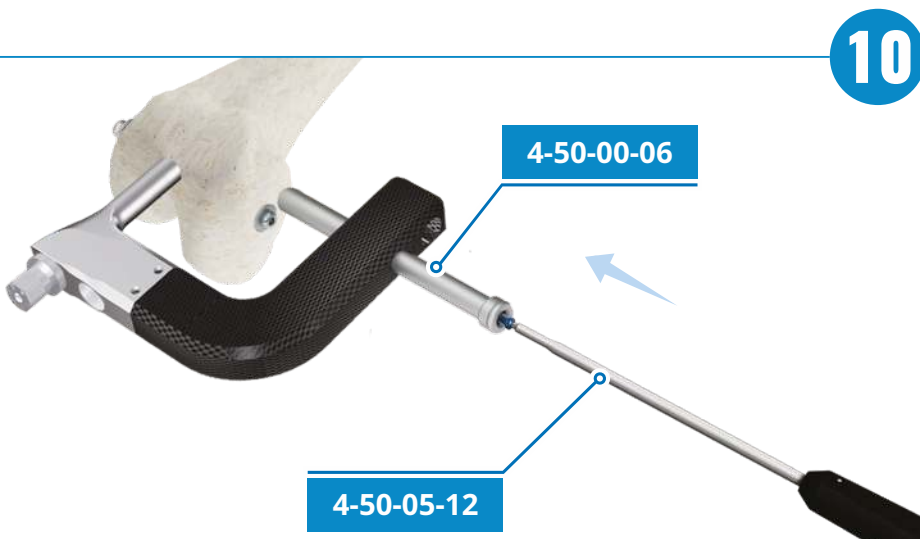

10

Insert the Ø 6,5 molar locking screw using screwdriver **4-50-05-12**.

FREEHAND LOCKING TECHNIQUE

Drill first distal nail hole using hand targeting device **4-50-00-03** sleeve **4-50-00-38** and drill **4-50-00-30**.

Measure the depth of drilling through the drilled hole, with bone thickness gauge **4-50-14-02** in order to determine the length of locking screw.

Insert \varnothing 4,5 mm locking screw in first drilled hole using screwdriver **4-50-05-12**.

EXTRACTION OF THE NAIL

Remove end cup.

Insert extractor reducer **4-50-18-07** into extractor **4-51-01-47**.

Install the set in the nail and remove distal locking screw.

Remove the nail using hammer **4-51-01-16**

4-50-00-03

4-50-00-38

4-50-00-30

01

4-50-00-03

4-50-14-02

02

03

4-50-05-12

4-50-05-12

4-50-18-07

4-51-01-47

4-51-01-16

01