



Revitan®  
Curved

Surgical Technique



Modular Femoral Revision Prosthesis



<b>The Revitan System</b>	4
<b>Goals and Methods of the Revision</b>	6
<b>Preoperative Planning</b>	7
Preparation of the Preoperative Planning Sketch	14
<b>Surgical Approaches and Osteotomies</b>	17
<b>Surgical Techniques</b>	
Removal of the Cement Residue and Preparation of the Implant Bed	21
Preparation of the Femur – Endofemoral Procedure	24
Preparation of the Femur – Transfemoral Procedure	31
Component Assembly	33
Additional Distal Locking	39
<b>Postoperative Treatment</b>	41
<b>Case Studies</b>	
Endofemoral Procedure	42
Transfemoral Procedure	44
<b>Appendix 1</b>	
Use of the Torque Wrench	46
<b>Appendix 2</b>	
Extraction of the Proximal and Digital Components	47
<b>Implants</b>	48
<b>Base Instruments</b>	49
<b>Instruments Proximal Spout</b>	52
<b>Instruments Proximal Cylindrical</b>	52
<b>Instruments Distal Curved</b>	53
<b>Locking Instruments</b>	54
<b>Locking Screws</b>	55

## Revitan Curved

### Modular Femoral Revision Prosthesis

#### Introduction

In the general section of this surgical manual both **Revitan Curved** and **Revitan Straight** are described. However in the chapter “surgical techniques” only the **Revitan Curved** system is discussed. For more detailed information about the **Revitan Straight** system, please see the separate surgical technique instructions.



# The Revitan System

The **Revitan** System (Fig. 1) is a modular cementless revision implant, which, in its entirety, consists of two different proximal and two different distal component series in a range of sizes. This enables the use of the common fixation techniques of cementless revision hip replacement. The proximal component is available in cylindrical

and spout shapes, each of which is available in lengths of 55 to 105 mm in 10 mm increments. The cylindrical proximal component is used for either a purely distal fixation, by using a transfemoral approach, or for an endofemoral implantation technique.

The spout component is generally applied only when the endofemoral implantation technique is used in order to improve the implant/bone contact.

The distal component distinguishes the curved or straight form of the prosthesis, so that the **Revitan** system is divided into **Revitan Curved** and **Revitan Straight** by using the distal component. Both systems – straight and curved – have advantages.

**Fig. 1**  
Sizes and possible combinations of all components

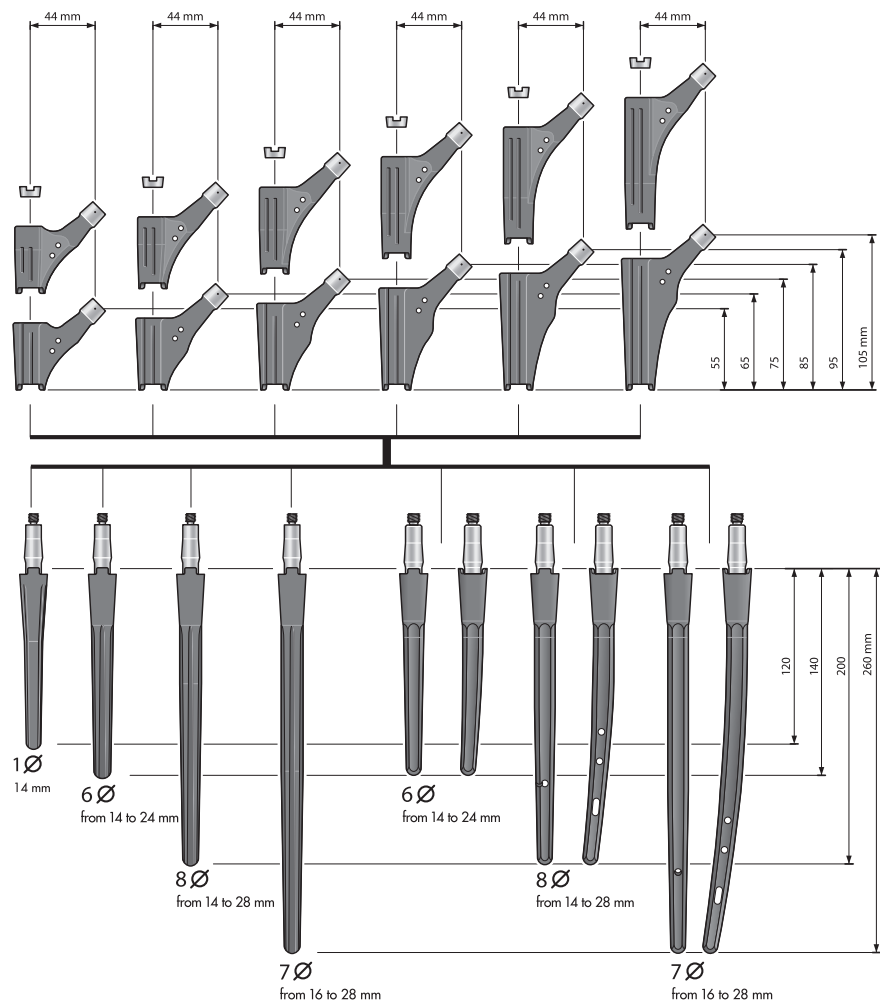

### Revitan Straight

The distal component of **Revitan Straight** is based on the proven fixation principle of the *Wagner SL Revision™* stem. It has a round profile, a spout gradient of 2 degrees, and achieves its rotational stability over 8 longitudinal ribs that cut into the corticalis. Thanks to its round form, the spout anchoring bed in the femur can be prepared with reamers, and the stem can be anchored with maximum press-fit (double-spout fixation). Using the modular proximal parts, the ideal connection to the acetabular component is subsequently achieved. There is only a small risk of later axial migration if the surgical technique is followed precisely.

### Revitan Curved

The curved distal component has an octagonal profile and also a spout gradient of 2 degrees. Its rotational stability is achieved by the corners (longitudinal ribs) of the octagonal profile. The **Revitan Curved** stem, sagittally curved along its longitudinal axis, has a more anatomical shape for the natural antecurvature of the femoral medullary canal. Longer prosthesis stems can hereby be implanted without a femoral osteotomy, i.e., via an endofemoral approach. Most of the time, this does not achieve a distal circular press-fit anchoring, but rather a three surfaces fixation in which the longitudinal ribs of the stem fit closely, over long distances, to 3 sites of the corticalis, whereby the longitudinal ribs cut into the corticalis at different depths. If, on the other hand, one uses a transfemoral approach then, using the curved stem, one can also achieve a distal circular surface fixation in the isthmus region of the femur, similar to the press-fit anchoring of the straight stem.

Due to the octagonal design and the stem's curvature, the femur is not prepared with reamers, as is the case with the straight component, but with rasps.

The distal components are available in standard sizes, both in curved and straight shapes, and in lengths of 140, 200, and 260 mm. The 140 mm component is available in thicknesses of 14 mm to 24 mm; the other two lengths are available up to a thickness of 28 mm each with 2 mm increments. Beginning with a thickness of 18 mm, the curved components of the 200 mm and 260 mm lengths also have holes for locking screws, with the possibility of either static (3 lateral holes and 1 anteroposterior hole) or dynamic locking (1 lateral hole).

In the preoperative planning stage, the surgeon must decide upon one of the four possible component combinations and thus also the fixation method:

#### Revitan Straight

- proximal spout component
- proximal cylindrical component

#### Revitan Curved

- proximal spout component
- proximal cylindrical component

# Goals and Methods of the Revision

## Goals of the Revision

During the revision of a loosened hip prosthesis (Fig. 2), two basic goals should be achieved:

1. long-term implant stability
2. the prevention of further bone loss (which accompanies the loosening of an implant) and, if possible even a promotion of bone re-growth.

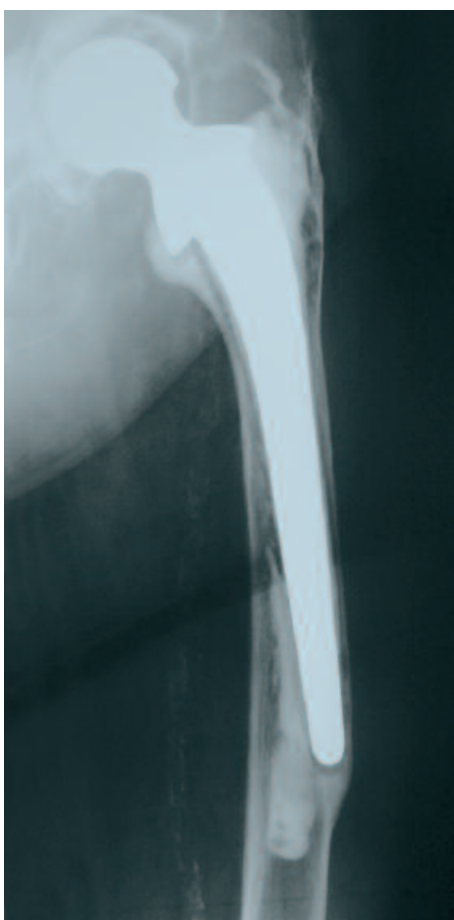

**Fig. 2**  
Loosened cemented hip prosthesis with varization of the loosened stem and loss of cavity, metadiaphyseal bone substance.

## Methods of the Revision

During the revision of a loosened femoral component, it is possible to stabilize the new femoral component either by cemented or by cementless fixation.

The disadvantage of the cemented revision technique is that, due to the loosening of the primary prosthesis, the osseous base of the prosthesis is expanded, thinned, and hardened. This clearly weakens the adhesion of the cement inside the bone. Thus, tests\* have shown that the load capacity of the bone/cement interface for shear strength is reduced in cemented revisions by 79% when compared to a cemented primary implant. This explains the significantly higher re-revision rate of cemented revision prostheses in comparison to cementless revision components. Furthermore, in case of another failure, the cemented revision technique results in further bone loss, which contradicts the second goal of the revision surgery mentioned above. For this reason, many surgeons prefer cementless systems.

\* Source:  
Dohmae Y, Bechthold JI, Sherman RE, Puno RM, Gustilo RB: Reduction in cement bone interface shear strength between primary and revision arthroplasty. Clin Orthop 1988; 36: 214–220.

# Preoperative Planning

**For preoperative planning, one needs X-ray images of the affected femur that are at least 30 to 40 cm long on both planes, depending upon the length of the loosened implant. These X-rays should show at least 6 cm of the femur extending below the prosthesis tip of the loosened implant.**

In addition to determining the sizes of the prosthesis components, the pre-operative planning of **Revitan Curved** is concerned primarily with establishing whether the implantation should be performed endofemorally, with three surfaces fixation, or via a transfemoral approach, with distal circular surface fixation.

For this purpose, the following items must be analyzed during preoperative planning:

- shape of the femur, with possible axial deviations
- mechanical stability of the bone and defect analysis
- necessity of osteotomies (transfemoral approach, double osteotomy of the femur)
- selection of the prosthesis shape (curved or straight)
- selection of the fixation type (metadiaphyseal or distal)
- selection of the component sizes
- selection of the assembly type for both selected components (in-situ assembly or assembly external to the femur)

**Re 1: Analysis of the Shape of the Femur**

The loss of bone substance in the case of an implant loosening can cause curvatures of the femur in the frontal plane, the sagittal plane, and combinations of the two planes (Figs. 3 and 4).

Curvatures in the frontal plane occur as a varization of the metaphyseal bone and a varization of the metadiaphyseal and diaphyseal femur. Varus malalignments of the femur generally require a corrective osteotomy. In the case of minor varus deformities, the transfemoral approach usually suffices for a secure stem implantation; if the varus deformities are pronounced, however, then a double osteotomy is required (Fig. 3).

Curvatures in the sagittal plane occur as diaphysis antecurvata, with a double-curvature of the femur due to a counteracting proximal and diaphyseal concavity, and as a pronounced antecurvaturation of the femur

with an equidirectional dorsal-concave curvature of the proximal and diaphyseal femur. The use of a curved stem does indeed reduce the necessity of a femoral osteotomy, but during pre-operative planning the necessity of a femoral osteotomy must nevertheless be analyzed by comparing the femoral curvature to the curvature of the curved stem (Fig. 4).

Curvatures in the frontal and sagittal planes can basically occur in all combinations.

**Fig. 3**

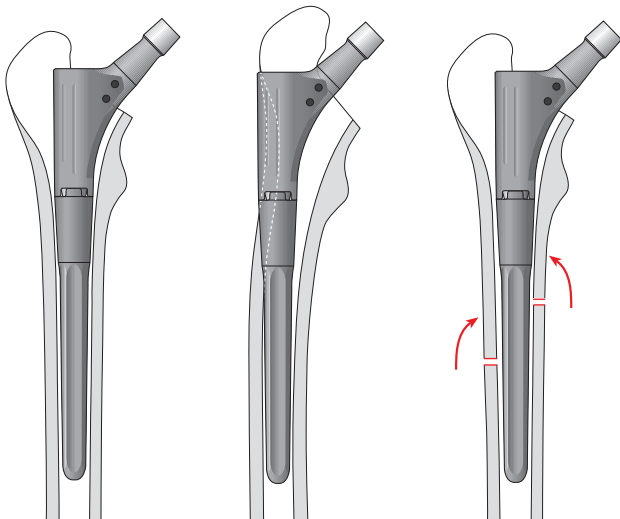

Osteotomies for correcting a varus malalignment in a distally fixed *Revitan* stem.

**Fig. 4**

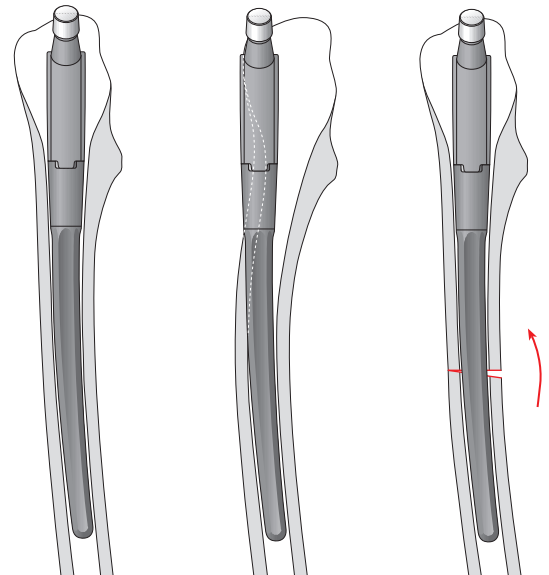

Osteotomies for correcting a progressive curvature in the sagittal plane in a distally fixed *Revitan* stem.



## Re 2: Analysis of the Mechanical Stability of the Femur

The bone quality of the metaphyseal and diaphyseal bones must be analyzed for the mechanical stability of the femur. For this purpose, one must clarify mainly whether the remaining metaphyseal bone is still suitable for absorbing the loads of the three surfaces fixation (Fig. 5).

If it has been weakened by the loosening process, then an endofemoral implantation would further the risk of an intraoperative or a postoperative periprosthetic fracture (primarily avulsion of the greater trochanter) (Fig. 6).

In this case, the distal circular surface fixation is the preferred option over the transfemoral approach.

The distal fixation is performed using a circular surface fixation in the diaphyseal bone – which, if possible, has not been previously damaged – over an average distance of 40 to 70 mm. This anchoring area is generally located below the tip of the prosthesis in the isthmus of the femur. In smaller patients, the isthmus can be quite short.

In an osteoporotic femur, it is often only faintly indicated. In the case of osteoporotic bones with a thinned out corticalis, thicker and longer distal components are required.

In the latter cases, a distal fixation in the curved system (beginning with a stem thickness of 18) can be optimized by the additional placement of locking screws.

For this, it is desirable for the osseous anchoring zone to extend at least 10 mm proximally above the most proximal locking hole.

Fig. 5



Stem loosening in which an endofemoral implant of the cementless revision stem appears to be possible.

Fig. 6



Stem loosening with thinning and cavitary defect of the proximal bone, for which preference shall be given to a distal fixation via a transfemoral approach.

### Re 3: Need for Osteotomies

The transfemoral approach is advisable for uncomplicated removal of stem endoprotheses:

- that are fractured,
- that have an extended, stable cement mantle,
- that, as cementless stems, are only partially loosened (especially in porous surface structures),
- that are located in a weakened bone which is at risk of fracturing, and/or
- in a femur with pronounced curvature in the frontal and/or sagittal plane(s) (Fig. 7).

In the case of more extreme deviations, especially in the frontal plane, double osteotomies of the femur may be necessary to achieve a complete correction. The preoperative planning hereby serves to determine the osteotomy levels and the remaining distal fixation distances.

Furthermore, distal fixation is indicated for periprostheses fractures requiring a change in prosthesis.

A periprostheses fracture should be bridged with the distally fixed implant by at least twice the width of the diaphysis.

### Re 4: Selection of the Prosthesis Shape (curved or straight)

In principle, both prosthesis shapes are suitable for an endofemoral implant, as well as for an implant via a transfemoral approach. The only difference is that the curved version more closely approximates the anatomy of the femur, and therefore a femoral osteotomy, i.e., a transfemoral approach, or a double osteotomy is less frequently required than is the case with the straight-stem version. Without a femoral osteotomy, that is, without a transfemoral approach, short stems of up to a total length of approximately 200 mm can be implanted in both the curved and straight shapes, if the frontal plane of the femur is straight and the sagittal plane does not exhibit significantly increased curvature. In the case of these femora, longer stems can be inserted without an osteotomy, however, only as a curved shape. Straight stems require a transfemoral approach, above all in order to avoid ventral perforations of the femur with the implant tip. Considerable varus deformities and significant curvatures in the sagittal plane require corrective osteotomies for both stem shapes (straight and curved), and, in most cases, even a double osteotomy (Fig. 8).

Fig. 7

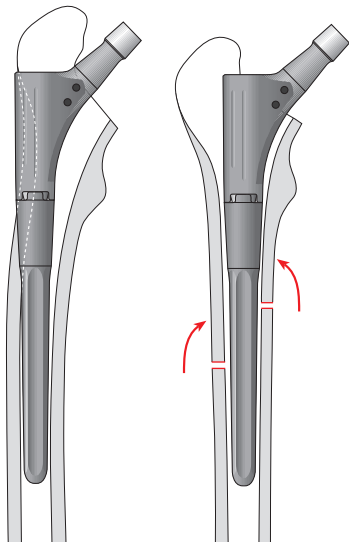

Osteotomies for correcting a varus malalignment in a distally fixed *Revitan* stem.

Fig. 8

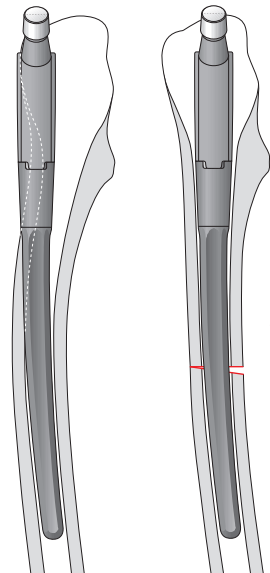

Osteotomies for correcting an increased curvature in the sagittal plane in a distally fixed *Revitan* stem.

**Re 5: Selection of Fixation Type (metadiaphyseal or distal)**

By analyzing the mechanical quality of the bone (Re 2), considering the need for osteotomies (Re 3), and selecting the prosthesis shape (Re 4), the fixation type can now be selected. The **metadiaphyseal three surfaces fixation** via an endofemoral implantation and a curved stem can be selected (Fig. 9) if the metadiaphyseal and diaphyseal bone substance has been maintained, if the frontal plane of the femur is straight, and if there is no need for an osteotomy. Otherwise, the implant should be anchored distally via a transfemoral approach. Likewise, in order to treat a periprosthetic fracture in the presence of a loosened implant, the implantation of a revision endoprosthesis is performed with distal fixation in the unfractured bone.

During preoperative planning, both the fixation type and the respective fixation length are determined, in order to gain an impression of the primary stability that is to be achieved.

The distal fixation is performed in the diaphyseal bone, which, preferably, has not previously been damaged and which generally lies below the old prosthesis bed in the isthmus. If the quality of the cortex is good, a fixation length of 40 to 50 mm is generally sufficient; correspondingly, a shorter distal component can be used (Fig. 10).

If the cortex is thin (due to the cavitory bone loss caused by loosening or by osteoporosis), the prosthesis requires a fixation length of 50 to 70 mm (Fig. 11).

If no secure circular surface fixation can be achieved distally, **Revitan Curved** – beginning with a length of 200 mm and a stem thickness of 18 mm – offers the possibility of optimizing this fixation by an additional placement of locking screws.

Fig. 9

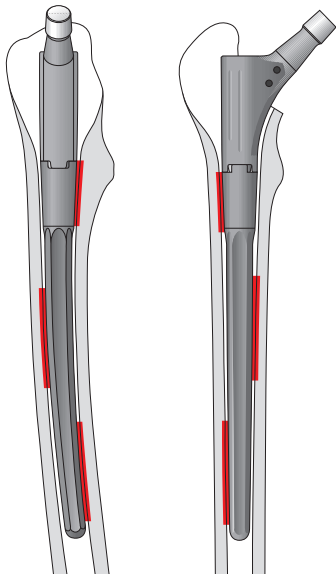

Three surfaces fixation of an endofemorally implanted *Revitan Curved* stem.

Fig. 10

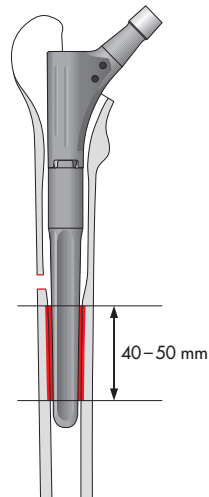

*Revitan*, distal curved (length: 140 mm), proximal cylindrical, with osteotomy, with distal circular surface fixation.

Fig. 11

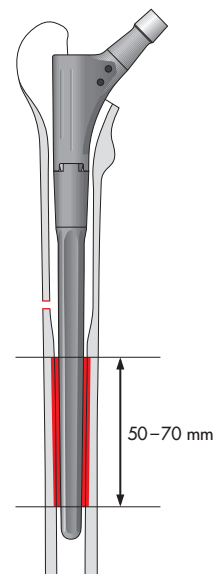

*Revitan*, distal curved (length: 200 mm), proximal cylindrical, with osteotomy, with distal circular surface fixation.

**Re 6: Selection of Component Sizes**

After the morphology and quality of the bone have been analyzed on X-ray images, and after the necessity of a femoral osteotomy has been investigated and the fixation or implant type (endofemoral three surfaces fixation or distal circular surface fixation) selected, the sizes of the components are then determined.

In the case of **endofemoral three surfaces fixation**, that component combination is selected which has a length and thickness that achieves longer cortical contact, over a length of 3 to 4 cm, at each of three sites (both planes included) and with which the center of rotation can be reproduced at the level of the tip of the greater trochanter (Fig. 9). Special attention should be given to the localization of the femoral curvature, so that the curve of the stem prosthesis fits as

optimally as possible into the medullary canal. Correspondingly, shorter or longer proximal components can be selected, in order to achieve the correct femoral ante-curvature or varization with the curved, distal component. Furthermore, the selection of the proximal component type (spout or cylindrical) is also based on the question of which can achieve the best and longest cortical contact in the metaphyseal femoral region. Generally, longer and thinner implants, rather than distal circular surface fixation via the transfemoral approach, are used for endofemoral implantation.

In the case of **distal fixation**, that distal component is selected whose thickness and length achieve a sufficiently circular surface fixation zone in the isthmus region of the femoral diaphysis. If the quality of the cortex is good, a fixation length of 40 to 50 mm is generally adequate; correspondingly, a shorter distal component can be implanted (Fig. 12).

If the cortex is thin (due to the cavity bone loss caused by loosening or by osteoporosis), the prosthesis requires a fixation length of 50 to 70 mm (Fig. 13).

Generally, when selecting the thickness of the distal component, a thicker stem with a shorter fixation length is preferable to a thinner stem with a longer fixation length. If no secure circular surface fixation can be achieved distally, a distal

**Fig. 12**

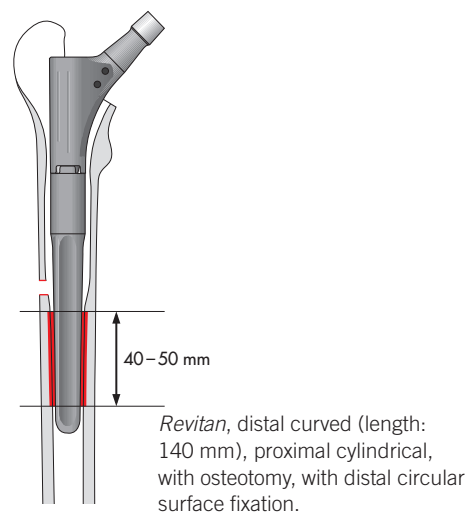

**Fig. 13**

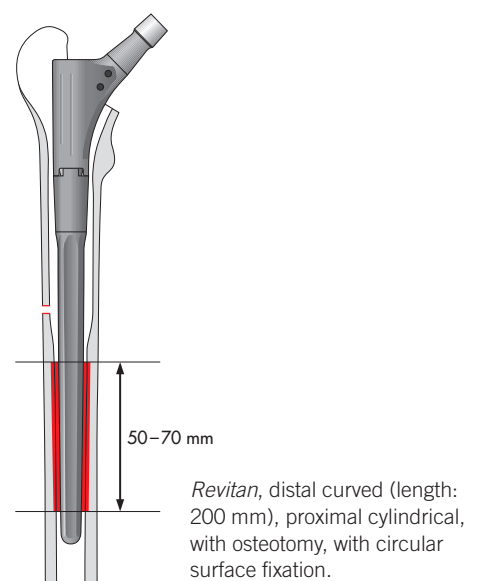

component at least 200 mm long and 18 mm thick is selected, whereby the thickness is determined by the medullary cavity of the femoral diaphysis and should fill this to the greatest extent and length possible. In these exceptional cases, additional stabilization is then achieved with locking screws.

In the case of distal fixation, the cylindrical or spout shape can be alternately selected as the proximal component. In such a case, the spout component serves to enlarge the contact surface of the bone prosthesis. Generally, the cylindrical component is selected. The possibility of using a spout component must be examined preoperatively and intraoperatively, so that no fracture can occur. That length is selected with which the center of rotation of the joint can be adjusted to the level of the greater trochanter or with which identical leg lengths can be achieved.

### Re 7: Selection of Assembly Type for Both Selected Components (In-Situ Assembly or Assembly External to the Femur)

Even if the assembly type cannot always be preoperatively planned and, as in some cases, it becomes clear only during the intraoperative phase which of the two assembly types makes more sense, the preoperative planning can nevertheless generally provide some idea, or even a clear determination, of the two assembly types.

In the case of an endofemoral three surfaces fixation, in-situ assembly makes sense in the cases in which the proximal component is not directly involved in the fixation. The distal curved component can be adjusted more precisely to the antecurvature of the femur. The proximal component is then selected corresponding to an optimal length and antetorsion.

Alternatively, one can perform the assembly of the implant prior to implantation. The preoperative planning provides information on whether the approach into the femur must be prepared in the region of the greater trochanter. This preparation is more necessary for the secure placement of the torque wrench on the proximal component during in-situ assembly than it is during the implantation of the stem mounted outside the femur (Fig. 14).

In the case of distal fixation, the in-situ assembly is advisable for the planned transfemoral approach or even for a double osteotomy, since, following the secure anchoring of the distal component, it enables the testing of the optimal length and position with respect to antetorsion using various proximal trial components.

Fig. 14

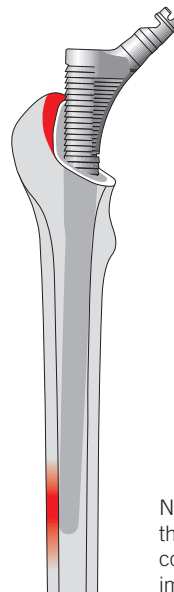

Necessity of preparing the femur in the region of the greater trochanter for correct guidance of the rasp and the implant.

## Preparation of the Preoperative Planning Sketch

The preoperative planning sketch serves to examine and document the aforementioned planning points with respect to plausibility.

It must hereby be emphasized, however, that not all aspects, e.g., bone quality and fixation length, can be determined unequivocally during preoperative planning. These aspects can be determined only intraoperatively. Nevertheless, preoperative planning is absolutely necessary, since it minimizes insecurities during revision surgery and thus helps to prevent complications.

### Step 1: Sketching of the Axes and, if Necessary, the Osteotomies

The medullary axis, which reflects the center of the medullary cavity, is sketched in. At the level of the greater trochanter, a line is drawn perpendicular to the medullary axis as the reference level for the center of the hip joint (Fig. S 1).

Furthermore, if necessary, the distal limit of the transfemoral approach and the level of the medial osteotomy are marked. This determines the level "H1" of the lateral femoral bone flap (from the greater trochanter to the distal end of the femoral flap, Fig. S 2).

The distal end of the femoral flap should hereby lie at the level, or slightly above the level, of the implant tip or at the level of the apex of a varus curve. One must nevertheless ensure that a sufficiently intact stretch of isthmus is maintained, in order to achieve sufficient distal fixation of the revision stem.

Fig. S 1

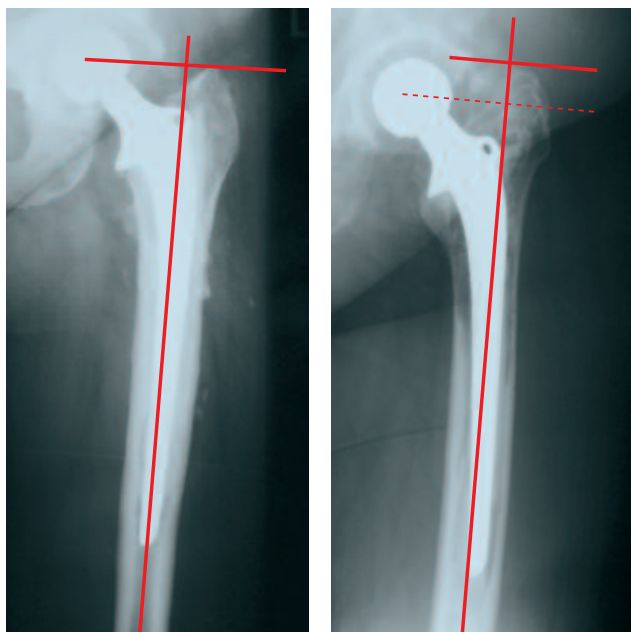
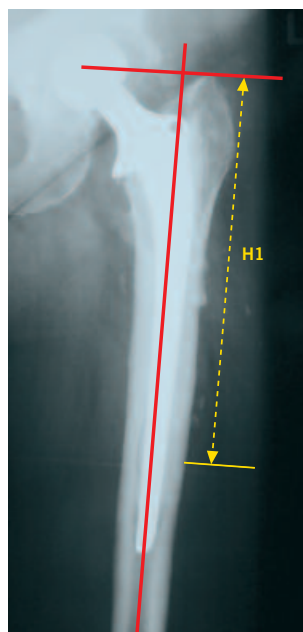

Fig. S 2



**Step 2: Sketching in the Anchoring Zone and the Implants**

In the case of **endofemoral three surfaces fixation**, as mentioned above, those components are selected which have a length and thickness that achieve longer cortical contact, extending over a length of 3 to 4 cm, at each of three sites (both planes included). The length of these three contact sites are drawn into the planning sketch (Fig. S 3).

Finally, the components with which this three surfaces fixation is most successful are sketched in. This should take the localization of the femoral curvations into account, so that the curve of the stem prosthesis fits as well as possible into the medullary cavity. Correspondingly, shorter or longer proximal components can be selected,

in order to achieve the correct femoral antecurvature or varus position with the curved distal component. Using the best possible proximal surface fixation, the shape of the proximal component (spout or cylindrical) is selected and sketched in (Fig. S 4).

In the case of **distal fixation**, the zone of the circular surface fixation in the isthmus of the femur is also now sketched in (Fig. S 5).

If the quality of the cortex is good, a fixation length of 40 to 50 mm is generally adequate; if the cortex is thin, the prosthesis requires a fixation length of 50 to 70 mm. Generally, a thicker stem with a shorter fixation length is preferable to a thinner stem with a longer fixation length.

The distal component is selected on the basis of length and thickness, in order to realize this circular surface fixation. As the proximal component, one sketches in the component that permits the center of rotation to rest at the level of the greater trochanter tip, that is, perpendicular to the centro-medullary axis. Generally, the cylindrical proximal component is hereby selected (Fig. S 6).

Fig. S 3

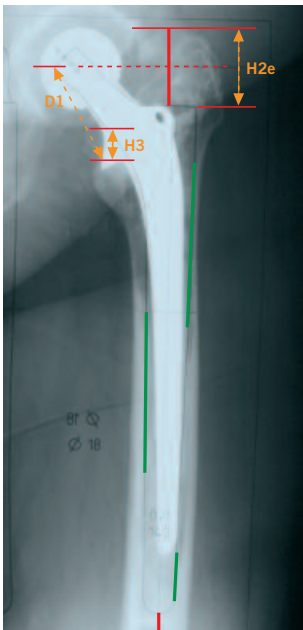

Fig. S 4

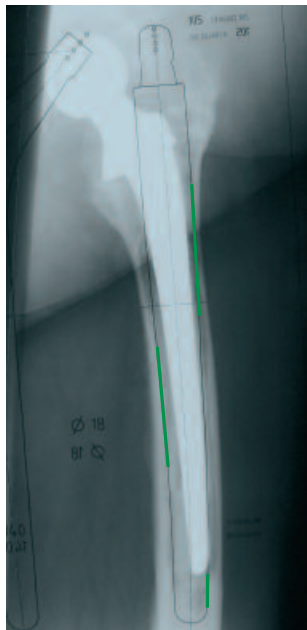

Fig. S 5

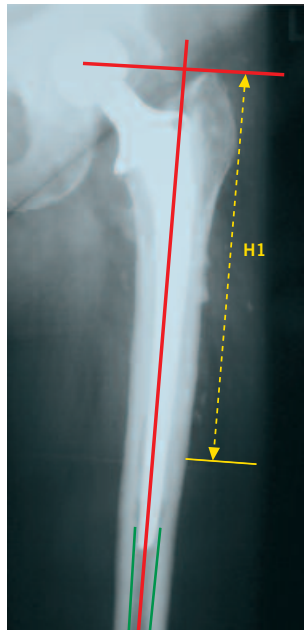
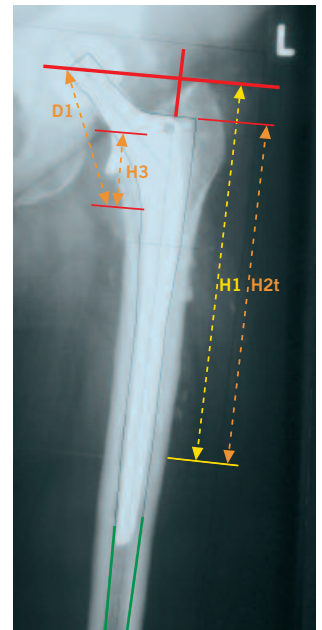

Fig. S 6



**Step 3: Marking Reference Points and Lengths**

These reference points and lengths should aid the intraoperative implementation of the preoperative planning.

For the **endofemoral three surfaces fixation**, the greater and lesser trochanters are selected as reference points. In order to check the penetration depth of the revision stem, the distances of “H2e” (greater trochanter to the lateral shoulder of the prosthesis), “H3” (lesser trochanter to the medial collar of the prosthesis) and “D1” (lesser trochanter to the medial edge of the taper) are marked and measured (Fig. S 7). These distances are initially checked intraoperatively with the rasp.

For the **distal circular surface fixation**, the distal end of the femoral flap and the lesser trochanter are selected as reference points. In order to check the penetration depth of the revision stem, the distances of “H2t” (distal end of the femoral flap to the lateral prosthesis shoulder) and “D1” (lesser trochanter to the medial edge of the taper) is marked and measured (Fig. S 8). These distances are initially checked intraoperatively with the rasp. Depending upon bone quality, however, deviations can exist here which must be taken into account when selecting the implants.

Fig. S 7

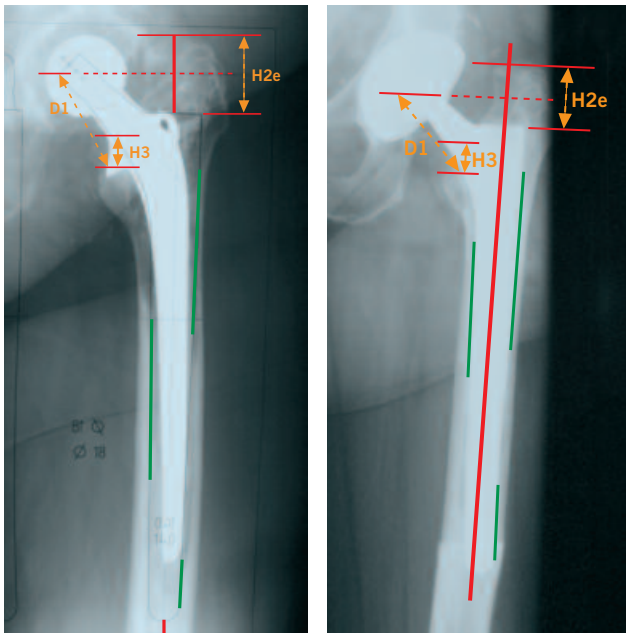
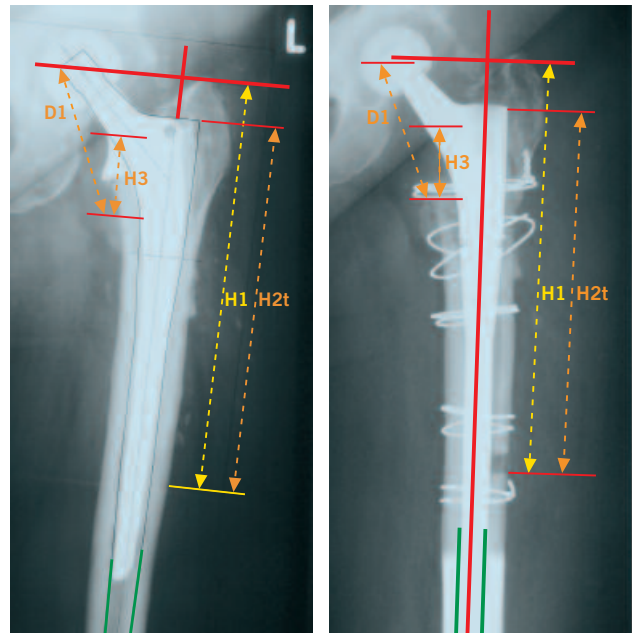

Fig. S 8





# Surgical Approaches and Osteotomies

In principle, several approaches are suitable for revision surgery of the hip joint. Each of them has its advantages and disadvantages. If no osteotomy is required, the surgeon should select the approach with which he or she is most familiar. Please consult the standard surgical and approach manuals for the technique of standard approaches. Of all the standard approaches, the posterolateral approach has the advantage of presenting the acetabulum well.

## The transfemoral approach is indicated for stem endoprostheses:

- that are broken (Fig. S 9/1),
  - that have an extended, stable cement mantle,
  - that, as cementless stems, are only partially loosened (especially with porous surface structures),
  - that are located in a weakened bone that is at risk of fracturing (Fig. S 9/2), and/or
  - in a femur with pronounced curvature in the frontal and/or sagittal plane(s).
- Furthermore, the distal fixation is indicated for periprosthetic fractures requiring a change in prosthesis (Fig. S 9/3), whereby the periprosthetic fracture should be bridged with the distally fixed implant by at least twice the width of the diaphysis.

## The transfemoral approach is indicated for stem endoprostheses:

- better healing of the osteotomy (as compared to the pure trochanteric osteotomy),
- direct approach to the distal stem and, thus, the distal cement portion,
- therefore, less risk of intraoperative femoral perforation or fracture,
- the possibility of changing the abductor tension by means of trochant proximalization or distalization,
- good presentation of the acetabulum, and
- reducing the surgery time in the case of difficult revision situations.

Fig. S 9/1



Fig. S 9/2



Fig. S 9/3



### Transfemoral Approach

The patient is placed in the lateral position. An extended posterolateral approach is then performed toward the distal direction (Fig. 15). Initially, in the septum intermusculare laterale, the lateral attachment of the musculus vastus lateralis to the femur is presented, whereby the perforating veins must be ligated.

After locating the tip of the greater trochanter, the lower end of the flap is marked with the tape measure according to preoperative planning; and, at this spot, the lateral circumference of the femur is exposed from the musculus vastus lateralis. On the lower boundary of the bone flap, a 3.2 mm hole is drilled on both the dorsal and ventral ends of its circumference.

The dorsal incision line of the bone flap is performed with an oscillating saw along the labium externum of the linea aspera while simultaneously receiving a cooling lavage. The same applies to the lateral osteotomy between the two distal bore holes and to the distal end of the ventral osteotomy. The interstitium is initially opened proximo-ventral between the musculus gluteus medius and the musculus vastus lateralis, and the proximo-ventral end of the flap is osteotomized here with a chisel. The ventral osteotomy is then completed from both the distal and proximal directions with the aid of a chisel, which is guided under the musculus vastus lateralis. During this process, it is extremely important for the blood circulation of the bone flap that the fastening of the musculus vastus lateralis to the bone flap remain undamaged.

Finally, the external rotators respectively the scar tissue close to the bone of the proximal bone, between the greater and lesser trochanters major and, are removed. Now the bone flap is carefully opened from the lateral direction with a chisel.

The prosthesis in situ and, if necessary, the cement are completely removed. Via this approach, there is good presentation of the acetabulum respectively the prosthesis cup, which, if necessary, is now revised. After this, it is advisable to apply a double cerclage, with a 1.5 mm cerclage suture, directly distal to the bone flap before drilling, reaming, or rasping the intact distal stem. This should prevent the formation of fissures during drilling, reaming, or rasping, or when impacting in the implant. For better stability, it is advisable to grasp the distal femur with tongs while drilling or reaming. Following implantation of the stem, the bone flap is closed and fixed with a few cerclages. Affixing the flap with sutures alone, as Professor Heinz Wagner described it for the *Wagner SL Revision Stem*, is not advisable due to the higher soft tissue tension with the **Revitan** stem (higher offset and more voluminous proximal design).

Fig. 15

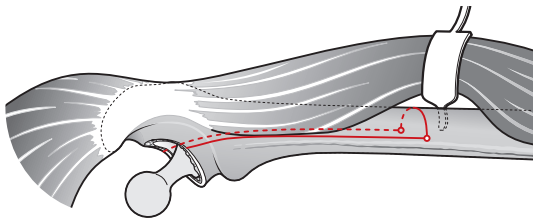

Schematic presentation of the bone flap in the transfemoral approach.

Fig. 16

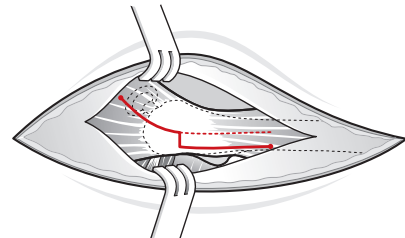

Illustration of the cut when extending a transgluteal approach in a transfemoral approach, a so-called vastus slide.

Professor Heinz Wagner was able to demonstrate that, by using the transfemoral approach which he initiated, the bone callus formation was stimulated and therefore bone remodelling was achieved, which is one of the major goals of the revision procedure (as mentioned before).

It is advisable to use the so-called “vastus slide” for a transfemoral approach via an anterolateral or transgluteal approach. The approach is hereby expanded distally by the L-shaped separation of the musculus vastus lateralis below the tuberculum inominatum of the greater trochanter (Fig. 16).

The lateral attachment of the musculus vastus lateralis to the femur is then presented distally in the septum intermusculare laterale. The subsequent procedure corresponds to the aforementioned transfemoral approach.

### Double Osteotomy

If a significant femoral curvature in the frontal and/or sagittal plane exists, it is advisable to perform a medial osteotomy (Fig. 17) adjacent to the lateral bone flap, in order to achieve better contact between bone and implant.

For better stability of the bone fragments, the medial, transverse osteotomy should lie above the distal end of the lateral bone flap, so that an overall mattress double osteotomy is created (Fig. 17). In this manner, a secondary separation of the bone fragments is prevented by the muscular traction of the M. gluteus medius and the M. iliopsoas. The stability and contact of bone fragments on the implant are further increased by applying cerclages.

Fig. 17

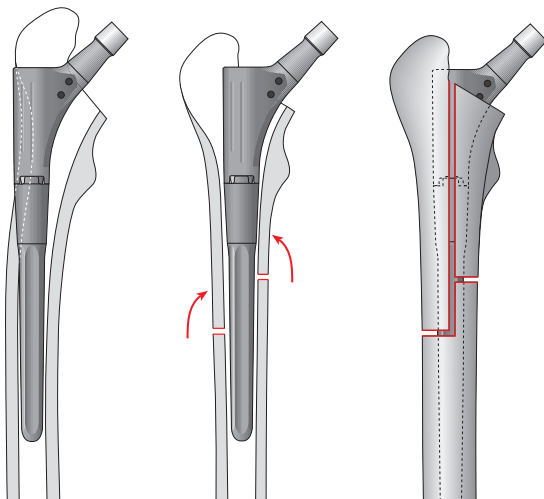

Double osteotomy for correcting a varization malalignment.

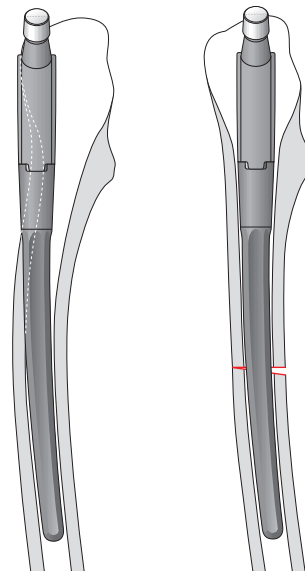

Double osteotomy for correcting an increased curvature in the sagittal plane.

### Distal Bone Window

If the conditions for a transfemoral approach or a double osteotomy do not exist, that is, if there is a cemented stem endoprosthesis without an extensive cement mantle, without weakened bones at risk of fracture, and without more pronounced curvature in the frontal and/or sagittal planes, then the distal cement portion can be removed via a distal, lateral bone window (Fig. 18).

In the case of the distal window technique, the precise location of the obstruction is initially determined. One can use the length of the old prosthesis or an image intensifier for this purpose. Following approach through the soft tissue, each corner of the window is secured with a 3.2 mm drill hole, and the flap is connected using an oscillating saw in a slightly slanted saw position. The slight slant guiding of the saw improves bone contact when the flap is subsequently closed. The bone window comprises  $\frac{1}{4}$  to  $\frac{1}{3}$  of the femoral circumference. It should not include the isthmus portion that is actually planned for the stem anchoring. The medullary canal can be viewed adequately distally through this lateral bone flap, the distal cement can be safely removed, and the prosthesis implantation can be

performed without image intensifier monitoring. One must hereby ensure that the revision implant bridges the bone window over a long distance (at least two times the width of the diaphysis), in order to minimize the risk of fracture.

In order to prevent fissures during the expansion of the medullary canal, a cerclage is applied distal to the window. As an alternative to the distal window technique, the distal cement portion can be drilled and subsequently gradually reamed with a medullary canal reamer. If during this process the central path of the drill cannot be ensured, it is advisable to monitor the distal boring with an image intensifier.

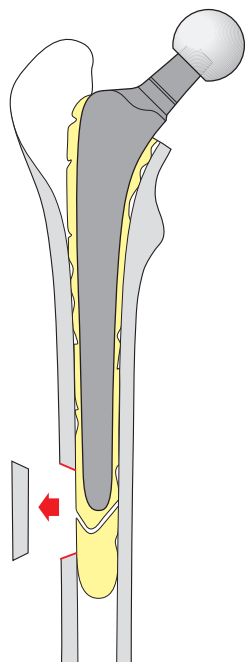

**Fig. 18**

Distal lateral femoral windowing for removing distal cement portions at the level of the prosthesis tip.

# Surgical Procedure

## Removal of the Cement Residue and Preparation of the Implant Bed

It is important to completely remove the cement or a sclerotic endofemoral projection (mostly a pedestal at the prosthesis tip), which would guide the drill or rasp in the direction of the opposite cortex and thus result in a perforation.

If, following the removal of the stem prosthesis, the bone cement cannot be removed endofemorally, one should consider whether to perform a trans-

femoral approach or a distal bone window at the level of the cement base, respectively the cement stopper.

The selection of the procedure depends upon the amount of cement residue or upon other obstacles. The cement residue of the proximal femur is removed with various cement chisels. In principle, there are two possibilities for removing cement residue in the distal femur and preparing the implant bed:

### 1. Use of Medullary Canal Reamers

The first possibility consists of using medullary cavity reamers that are guided by means of a secure, intramedullary-positioned guide wire (see Fig. 19).

Sometimes this initially requires a bore hole through the distal cement or an osseous obstacle made with a long, 6 mm – and subsequently 7 mm or 8 mm – drill. If the central path of the drill cannot be ensured, the drilling process should be monitored by an image intensifier. For the subsequent reaming of the medullary canal, the guide wire for the medullary canal is then conducted through the drilled distal medullary canal opening. Once again, the intramedullary position can be monitored on two (2) levels using the image intensifier. As an alternative, the guide wire can be pushed down the medullary canal up to the condylar region of the distal femur without using the image intensifier.

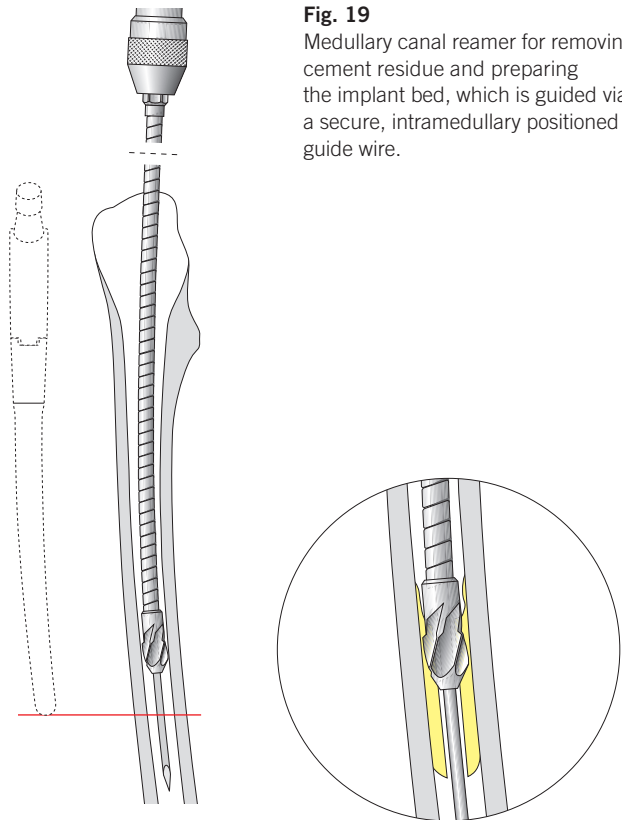

**Fig. 19**

Medullary canal reamer for removing cement residue and preparing the implant bed, which is guided via a secure, intramedullary positioned guide wire.

In the case of a perforation, the rod would run unimpeded into the soft tissue; without a perforation, it is stopped in the condylar region of the distal femur. The cancellous bone in the distal femur can then be probed. Via this secure, intramedullary-positioned guide wire, progressively larger cylindrical reamer heads can be guided on a flexible shaft, and the intramedullary expansion can be performed in 0.5 mm to 1 mm increments.

During the successive reaming of the medullary canal, one should pay attention to the sound of the cortex in the isthmus region. If over a longer distance (4–6 cm) one hears a high cortical sound, then the medullary canal expansion and the preparation of the distal prosthesis site should be stopped. The preoperative planning aids in the selection of the boring diameter. Depending upon the bone quality, the boring should be performed 2–4 mm (i.e., 1 to 2 rasp sizes) less than the diameter of the planned diameter of the implant. The expansion is performed gradually and carefully, in order to prevent a perforation or fracture.

Now the further preparation of the distal prosthesis site is carried out with the **Revitan** rasp. The length of the distal rasp component having increasing diameters is hereby combined with the rasp impactor according to the preoperative planning and the defects to be overcome. One begins with the diameter of the distal component that is smaller than the medullary canal reamer that was used last.

One begins with the rasp to calibrate the corresponding antecurvature and varization of the respective femur and successively uses the next largest rasp. In order to avoid a varus implantation, it may be necessary to rework the lateral trochanter region with the first rasp or a box chisel. For the endofemoral procedure, the three surfaces fixation is prepared using the rasps; for the transfemoral approach, the circular surface fixation.

Since the nominal diameter of the rasp, and thus also the prosthesis, is measured at the approximate middle of the distal component, when the distal fixation technique is used, the rasp must be at least one size larger than the distal reaming.

In order to improve axial force transfer when rasping and to avoid jamming during the rasp extraction, it is advisable to attach a slap hammer to the distal rasp impactor to perform the rasping procedure.

Fig. 20

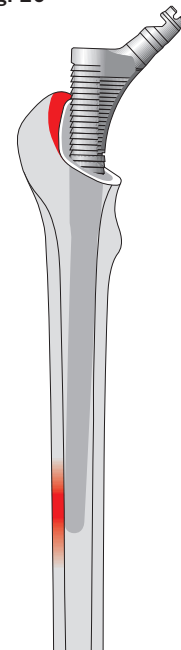

Preparation in the region of the greater trochanter for correct guiding of the rasp and the implant.

**Fig. 21**

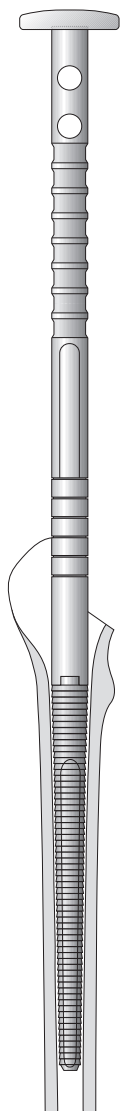

Rasp with rasp impactor (REF 01.00409.501)  
for preparing the prosthesis fixation bed for an  
endofemoral implantation.

## 2. Use of Rasps

The second possibility for preparing the implant bed consists of the exclusive use of rasps. For this, however, it must be ensured that no cement residue or osseous obstacles obstruct the free movement of the rasps. One begins with the rasp that is at least two sizes smaller than the medullary cavity or prosthesis size that was measured during preoperative planning. Alternatively, the rasping process can be started with the smallest rasp size, and then the size is progressively increased. The length of the rasp is selected according to the preoperative planning and the defects that may need to be overcome, whereby the distal rasp component with the increasing diameter is combined and used with the rasp impactor.

After possible obstacles have been eliminated, the preparation of the femoral diaphysis is continued; for this, increasingly thicker distal rasp components are used until the rasp cannot be driven any further. The rasp has then reached a secure position and a “cortical sound” should be heard. Aggressive rasping should be avoided in the case of osteoporotic bones. The measured stem diameter from the preoperative planning is also helpful here.

## Preparation of the Femur – Endofemoral Procedure

For the endofemoral three surfaces fixation, the primary stabilization is effected by extensive bone contact (each time 3 to 4 cm) in three areas of the femur, mostly metaphyseal, metadiaphyseal, and diaphyseal. These three surfaces hereby extend over different areas of the femoral circumference, so that they can be pictured only in X-ray images of both planes. This type of anchoring requires good bone substance in the entire implantation region in each case, and it cannot be reconciled with a deeper trochanteric osteotomy or a transfemoral approach.

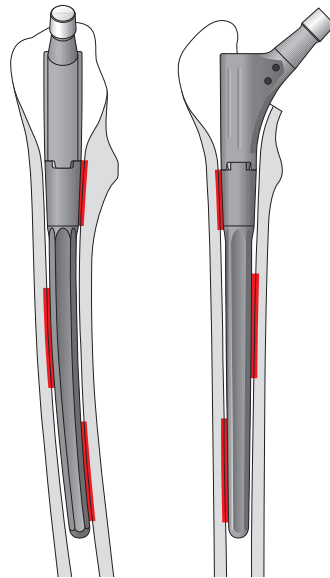

**Fig. 22**  
Fixation surfaces of the three surfaces fixation in the endofemoral implantation.

After the distal prosthesis bed has been prepared with the distal rasp component and the distal rasp cannot be driven further, the proximal rasp size that is to be selected at the level of the greater trochanter (corresponding to the level of the center of rotation) is read from the rasp impactor. The smallest or the largest component (55 mm or 105 mm) should be avoided, in order to ensure more options for when the definitive implant is inserted.

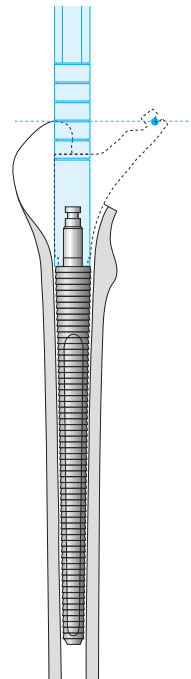

**Fig. 23**  
Reading of the proximal rasp component respectively prosthesis component from the rasp impactor.



If one reads a proximal component of 55 from the rasp impactor, then one must weigh which of the two options should be selected.

1. One continues to rasp with the same distal rasp until a further distal fixation is effected, the distal component is thus further impacted, and the proximal component 65 can be selected (Fig. 24). If the first rasp application results in a very tight fit of the distal component, this is rarely possible.

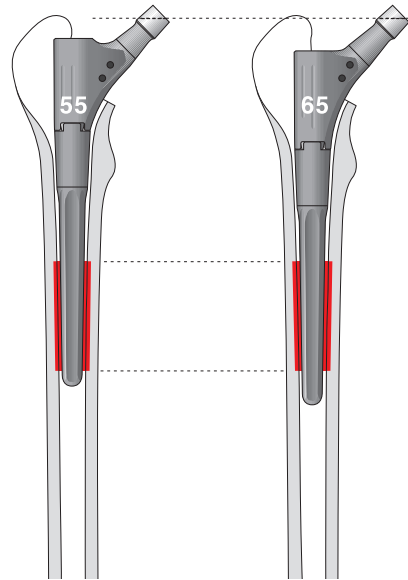

Fig. 24

2. In the case of a distal component of 200 mm, the distal rasp is exchanged for one that has a length of 140 mm and that is one size thicker. Also here, the new fixation quality of the exchanged component combination must be reassessed, since it results in changes to the fixation lengths (Fig. 25).

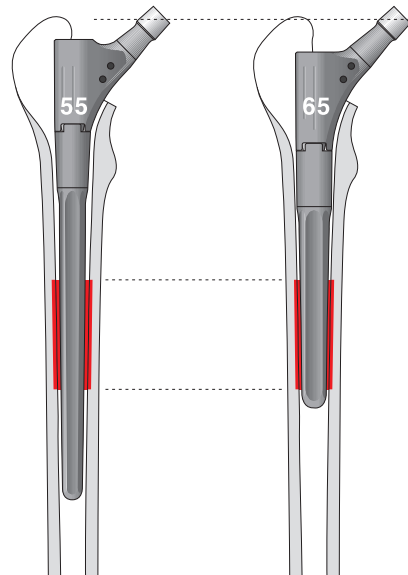

Fig. 25

If, on the other hand, a proximal component of 105 mm is read from the rasp impactor, then one must weigh which of the two options should be selected.

1. The distal component that is one size thicker is selected. This jams further proximally, so that it can be combined with a shorter proximal component part (Fig. 26). Here, the new fixation quality must again be carefully examined and assessed.

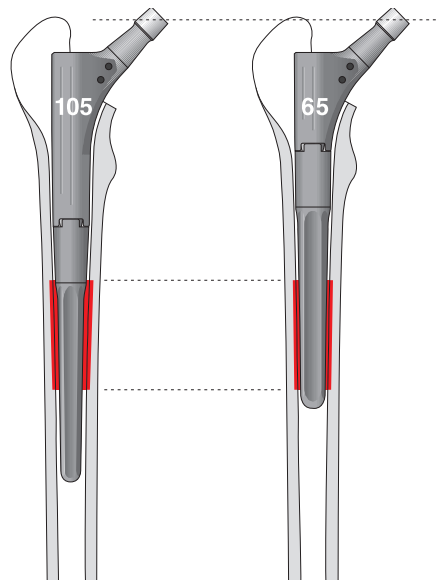

Fig. 26

2. A distal component is selected that is one size longer and has the same thickness. In this way, one can also change to a shorter proximal component (Fig. 27). Once again, one should ensure that the fixation of the newly selected prosthesis components is adequate.

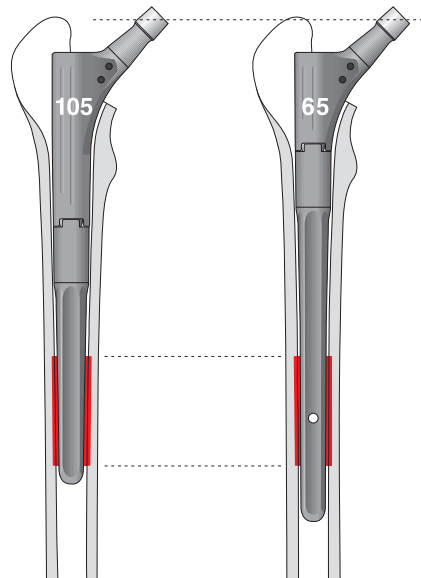
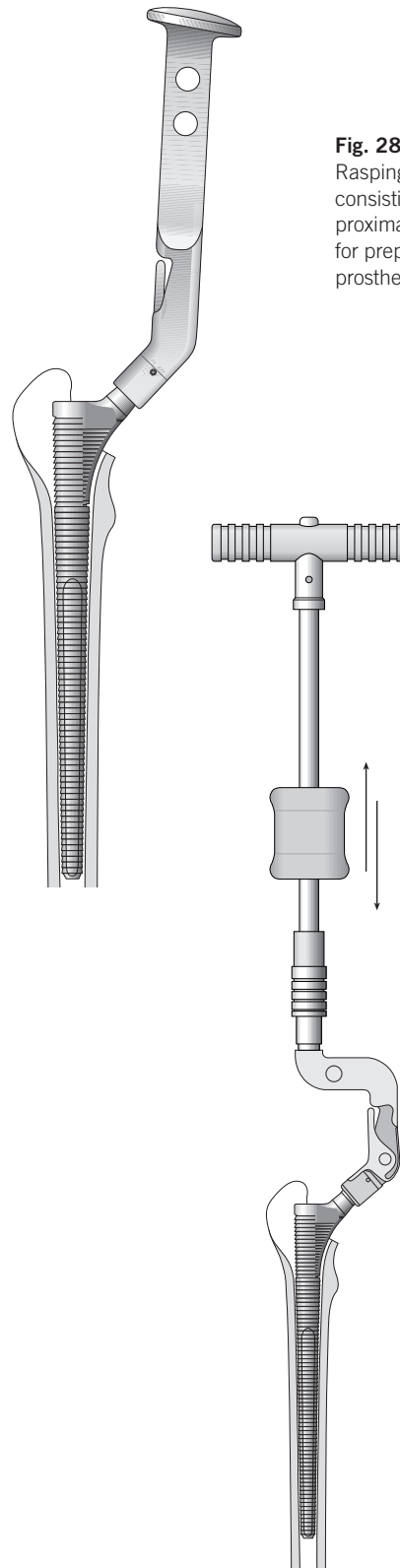

Fig. 27

The rasping is now repeated with the rasp components that were selected and combined last, whereby the proximal prosthesis fit is prepared this time with the rasp. Now at the latest, however, the decision must be made whether a spout or cylindrical proximal component, with their respective rasp, should be used. If the proximal anchoring bed needs to be prepared further, the hand reamer (REF 79.10.46) that was designed for this purpose can be selected.

In order to attain an axial force transfer, during rasping, the slap hammer can be placed onto the proximal rasp component using a rasp adapter (REF 01.00409.083).



**Fig. 28**  
Rasping with a complete rasp, consisting of distal and selected proximal rasp components for preparation also the proximal prosthesis fixation bed.

One should heed whether the approach path for the correct insertion of the rasp, and thus also for the prosthesis, must be further prepared in the region of the greater trochanter. Attention should be paid to the localization and the level of the femoral curvations, in order to attain the correct femoral antecurvature, respectively varus curvature with the curved distal component.

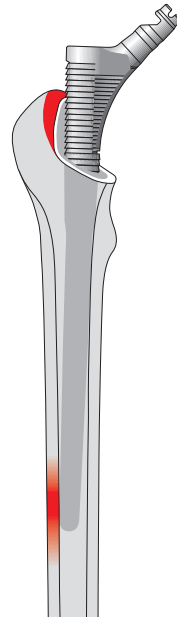

**Fig. 29**

The correct motion of the rasp frequently requires the preparation of the greater trochanter region during the endofemoral procedure.

During this phase of the procedure, attention should be paid to the shape of the femur and to obstacles that can resist the rasp; for example, the ventral cortex can hinder the advancement of the rasp into the femoral axis when there is pronounced sagittal curving. In this case, the rasp is blocked by a three-point support, and either the obstacle must be carefully chiseled or reamed, or one must switch to a transfemoral approach or a corrective osteotomy. If the proximal femoral diaphyseal already blocks the insertion of the first rasp, the proximal prosthesis site can be prepared with the special hand reamer for the proximal component.

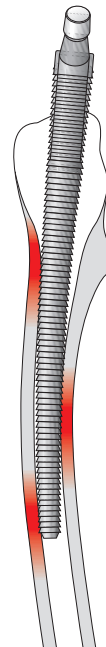

**Fig. 30**

Adverse premature three-point jamming of the rasp, due to a more pronounced sagittal femoral curvature, which necessitates a corrective osteotomy.

Because of the possibility of a perforation or infraction, an overly aggressive procedure should be avoided in the case of existing osteoporosis. The centering of the rasp in the proximal femur should be monitored.

If the rasp components attain the desired anchoring effect, the penetration depth of the rasp is checked by using the distances to the greater and lesser trochanters, and comparison with the preoperative planning indicates whether the length of the proximal component might need to be changed again. Now the rasp can act as a trial prosthesis, and it can be used for the trial reduction (Fig. 31). Using trial heads placed on the neck of the rasp, the leg length can be checked and the joint stability tested. The implant must correspond to the rasp size that was used last.

**Tip 1**

The rasp penetration depth is oriented toward the reference points that were selected during preoperative planning (see introduction, pages 15 and 16).

**Tip 2**

The preoperatively planned stem size is a guiding value, but not a must when determining the size of the implant.

**Tip 3**

Since the antetorsion cannot be changed with the rasp, something, however, that is possible on the trial and original implants, the luxation stability of the rasp does not correspond to that of the implant. During this initial trial reduction, however, one can already assess whether the lengths of the selected components are correct and whether another antetorsion must be adjusted with the proximal trial part and, thus, with the later implantation component.

With the desired leg length, range of motion, and luxation safety, the distal original implant is brought into the desired antetorsion position with light hammer blows until it has attained a secure three surfaces anchorage. This is achieved, using either the appropriate proximal trial component for an in-situ assembly or the combination of the two original components for assembly prior to implantation.

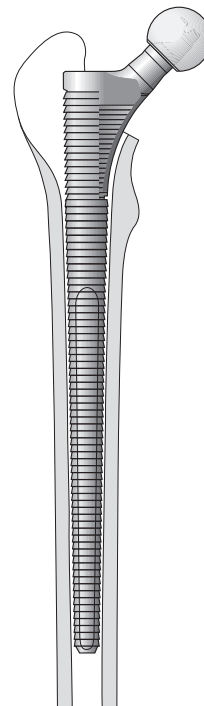

**Fig. 31**  
Use of the rasp with trial head for the initial trial reduction.

An **in-situ assembly** can be performed for endofemoral implantation if an adequate fixation has already been attained with the distal component alone and if the proximal component is not involved in the actual primary stability of the implant, something that is shown in the secure wedging of the distal rasp component. Furthermore, the generally required preparation of the greater trochanter region for the secure placement of the torque wrench on the proximal component may not lead to any mechanical weakening with the risk of avulsion of the greater trochanter. For the in-situ assembly procedure, see page 33.

Alternatively, **assembly prior** to use with implantation of the combined original components must be used. For the assembly prior to implantation procedure, please see page 36.

Alternatively, during a planned in-situ assembly, the distal original component cannot be implanted with the proximal trial component, but rather, by using a component impactor (REF 01.00409.811) (Fig. 32). In this way, one can avoid with certainty that a proximal blocking prevents a secure distal anchoring. Following a secure distal anchoring, the size of the proximal component can, in turn, be read from the component impactor. A hollow reamer (REF 01.00409.812), which prepares the proximal femur for the proximal implant component (Fig. 33), can now be guided over the guiding sleeve (REF 01.00409.802).

This once again ensures that no bones hinder the connection of the components, especially anteriorly and laterally. In such a case, leveraging with the proximal component for the purpose of connecting the two prosthesis

components would create the risk of a trochanter fracture. Afterwards, the in-situ assembly can be facilitated by guiding the proximal component over the premounted threaded rod (REF 01.00409.805) of the stem tensioner (Fig. 34).

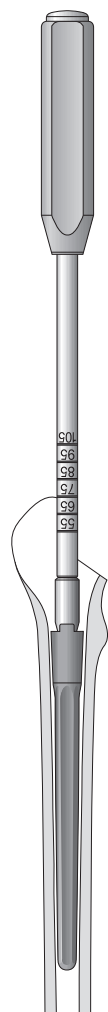

Fig. 32

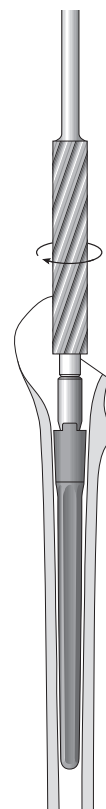

Fig. 33

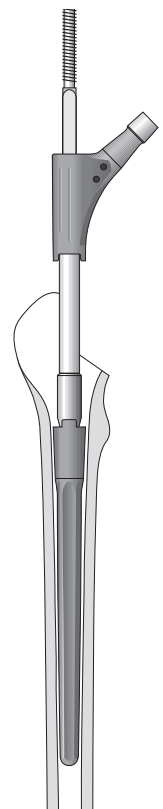

Fig. 34

## Preparation of the Femur – Transfemoral Procedure

In the region of the femoral fixation, the primary anchoring is ensured exclusively by means of the distal component. The proximal component serves only to restore the leg-length and to position and fasten the bone, as well as the attached soft tissue.

In the case of the distal surface fixation via the transfemoral approach, the cylindrical proximal component is generally selected. The use of the spout component shape is principally also possible for distal fixation. The possibility of its use, however, must be checked during preoperative planning and also intraoperatively.

If one has found the appropriate distal rasp that promises a good circular surface fixation in the isthmus, the length of the proximal rasp component is read using the scale of the rasp adapter at the level of the greater trochanter. The smallest (55) or largest proximal component (105) should be avoided, in order to ensure an area of flexibility when inserting the definitive implant (Fig. 35).

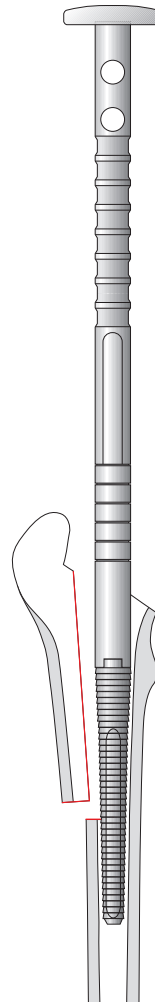

**Fig. 35**

Distal rasp component with a good circular distal fit, with rasp adapter (REF 01.00409.501), on which the proximal component sizes can be read.

Following secure wedging of the distal rasp component, the rasping can now either be repeated with an appropriate proximal rasp component (Fig. 36), or implantation of the distal component can be performed with the appropriate proximal trial part (Fig. 37).

**If a proximal component of 55 or 105 can be read from the rasp impactor, one must again consider which of the two possibilities to perform, which principally correspond to the procedure of the endofemoral implantation. For this, reference is made to page 25.**

A trial reduction can then be performed with the definitive rasp combination, whereby the tips already described in the endofemoral procedure (see page 29) should also be heeded during the transfemoral procedure.

Fig. 36

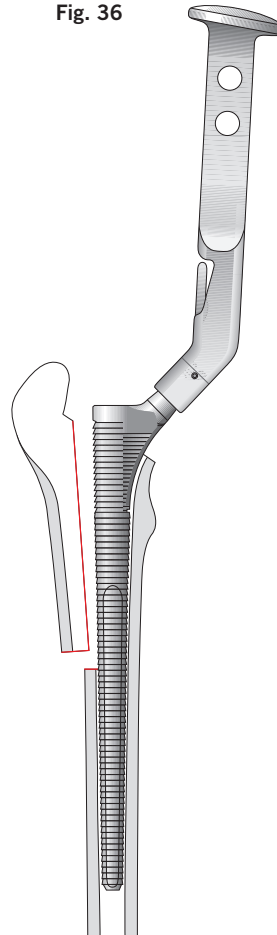
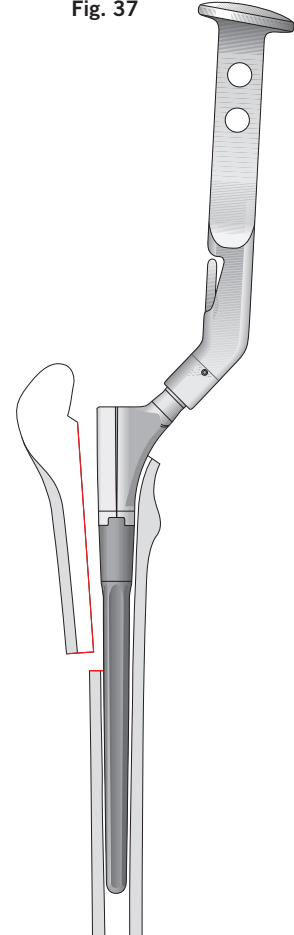

Fig. 37





# Component Assembly

## The following points should generally be heeded prior to the assembly of the original implants and their final implantation:

- A** No perforation or infraction of the femur exists; if necessary, an image intensifier should be used in 2 planes.
- B** The selected stem prosthesis is not too small. Otherwise, there is the risk of subsequent subsidence.
- C** A premature three-point jamming, e.g., resulting from the curvatures of the proximal femur, has not occurred. When this occurs, the prosthesis does not have adequate surface fixation, and there is the risk of subsidence. In addition, at the tip of the prosthesis, the three-point fixation can result in “stress raisers”, which can become the basis for a subsequent femoral fracture.
- D** The prosthesis has been brought into malrotation, which can result in the same complications that were described in C.
- E** The antetorsion of the stem prosthesis can be correctly adjusted, and no limitations exist due to an incorrect positioning of the distal component that could increase the likelihood of a hip dislocation.

## In-Situ Assembly

Following a trial reduction and assessment of the range of motion, the leg length, and the dislocation stability, the definitive distal implant can now be combined with the proximal trial part in the desired antetorsion. The size of the definitive distal component is determined by the size of the rasp last used. The assembly of the distal implant component and the proximal trial part is performed outside of the femur. The proximal trial part is set onto the definitive distal implant component and screwed on with the corresponding nut (REF 01.00079.001) which is screwed onto the connecting

bolt of the implant with the corresponding wrench (REF 01.00079.002). The proximal trial part is supported on the shoulder of the distal implant component, so that no contact to the conical connecting zone exists.

### Tip

The proximal trial part has the same design and the same dimensions as the subsequent definitive proximal implant component.

### Tip

The antetorsion can be adjusted to  $\pm 30^\circ$  (which are marked on the prosthesis). Attention should be given to the right/left marking.

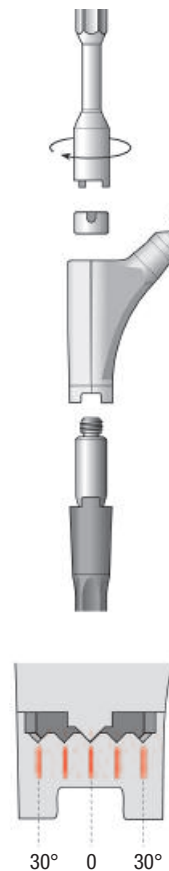

**Fig. 38**

Combination of the distal definitive component with the proximal trial part.

### Insertion of the Distal Implant Component

The combination of the definitive distal component and the proximal trial part with selected antetorsion position is now inserted with light hammer blows until it has achieved the definitive distal circular surface anchorage (Fig. 39). The intensity of the hammer blows should be adjusted to the bone quality. It should be heeded that no resistance in the proximal region or in the trochanter region hinders the insertion of the prosthesis into the distal femur. The penetration depth of the implant is then checked.

Another trial reduction now provides information on the necessity of changing the antetorsion position or the length of the proximal prosthesis component. If this is the case, then the proximal trial part can be exchanged for another size by loosening the nut. Similarly, if necessary, the antetorsion can be readjusted.

The tension of the proximal soft tissues and the leg length can be checked using trial heads of different lengths (Fig. 40). As a rule of thumb one can say that the center of the head should lie at the level of the trochanter tip. After exchanging the proximal trial part, a new trial reduction should be performed. Subsequently, the in-situ assembly is performed with the selected definitive proximal prosthesis component in the selected antetorsion position.

At this point, if necessary, the distal locking on the distal implant component can be previously accomplished with the targeting device (see page 39).

### Placement of the Proximal Implant Component

The proximal trial part is removed, the connecting taper is cleaned and washed thoroughly. The definitive proximal component, which is the same size as the proximal trial part that was last used, is positioned in the desired antetorsion (Fig. 41).

#### Tip

It is very important that the connecting taper be clean and that all tissue residues are removed.

#### Tip

At this time, a correction of the antetorsion according to the markings is still possible.

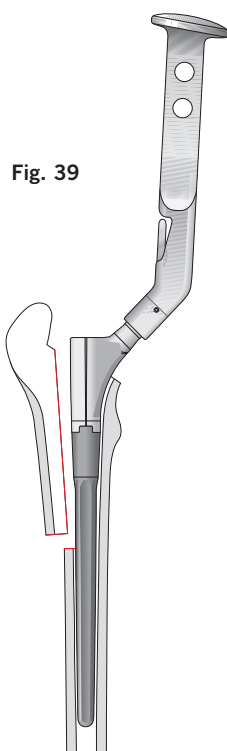
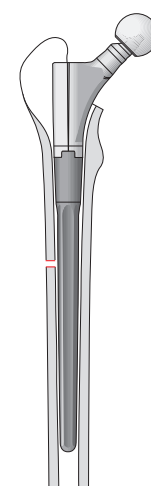

Fig. 39

Implantation of the distal original component with the proximal trial part.

Fig. 40



Trial reduction with a distal original component, proximal trial part, and trial head.

The threaded rod for the stem tensioner (REF 01.00409.805) is screwed onto the thread of the connecting taper. Then, the handle of the stem tensioner (REF 01.00409.804) is guided over the threaded rod and fastened with the nut (REF 01.00409.806). Both of the implant components are connected using the torque wrench (REF 01.00409.808). During this process, the handle of the stem tensioner is firmly gripped, in order to generate a counterforce that can absorb all torque exerted on the femur. Furthermore, the torque can be neutralized using the handle for counter force (REF 01.00409.809). One must ensure that the antetorsion is not readjusted. After tightening the components with the torque wrench, the nut of the stem tensioner is loosened by turning the torque wrench counterclockwise, and the stem tensioner is removed (Fig. 42).

Fig. 41

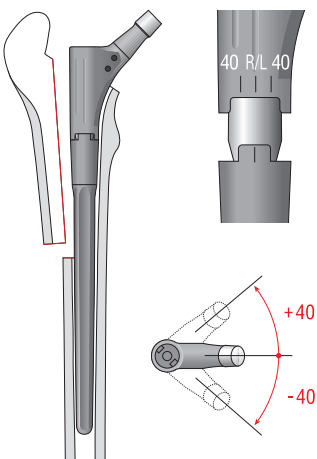

Possible rotation of the proximal component on the distal component for changing the stem antetorsion.

**Tip**

See also Appendix 1 “Use of the Torque Wrench”.

**Important:**

When assembling the proximal with distal implant component you **must not** apply hammer-blows.

Fig. 42

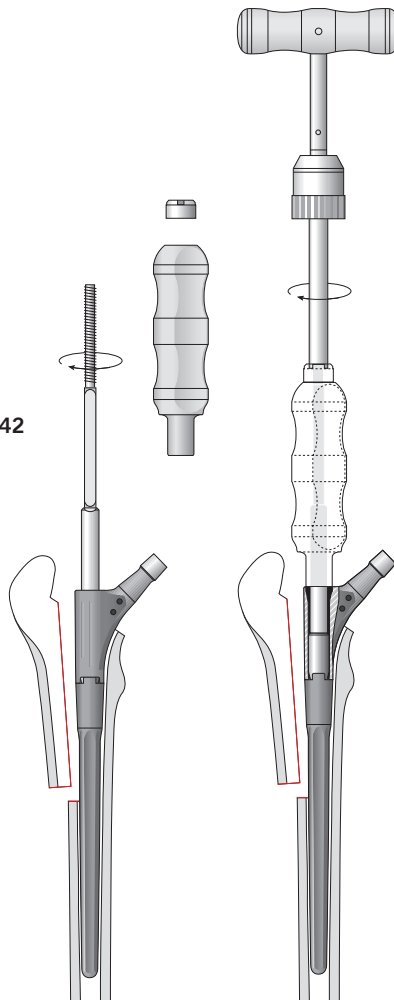

Connection of the two definitive components using the torque wrench in situ.

**Fastening of the Conical nut**

Using the setting instrument, the conical nut is placed onto the connecting taper (REF 79.15.82) and tightened with the torque wrench (Fig. 43).

**Tip**

See also Appendix 1 “Use of the Torque Wrench”.

Again, it is important for the torsional forces generated by the tightening to be neutralised. For this, a force is applied to the implant neck, using the handle for counter force in the direction opposite to the rotation of the conical nut (Fig. 43).

Fig. 43

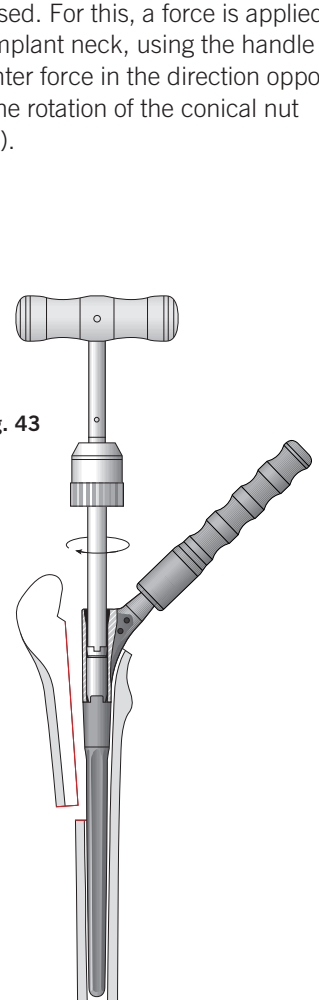

Tightening of the conical nut using the torque wrench and neutralization of the torque using the handle for counter force.

**Assembly Outside of the Femur  
(Assembly prior to implantation)**

Alternatively, the prosthesis can be assembled outside of the femur. Since changes to the proximal components are no longer possible during assembly outside of the femur, all questions regarding the length and position of the prosthesis components must be fully clarified with the rasp (as trial implant) during the trial reduction.

Generally an assembly outside of the femur is used in the case of three surfaces fixation via the endofemoral approach.

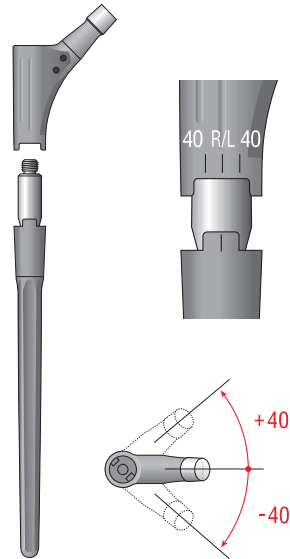

**Fig. 44**  
Rotational possibility of the proximal component, in order to change the stem antetorsion.

**Assembly of the Stem Tensioner**

The threaded rod of the stem tensioner (REF 01.00409.805) is screwed onto the thread of the connecting taper of the implant; then, the handle of the stem tensioner (REF 01.00409.804) is guided over the threaded rod and fastened with the nut (REF 01.00409.806). In this position, the upper end of the stem tensioner is grasped by the palm of the hand.

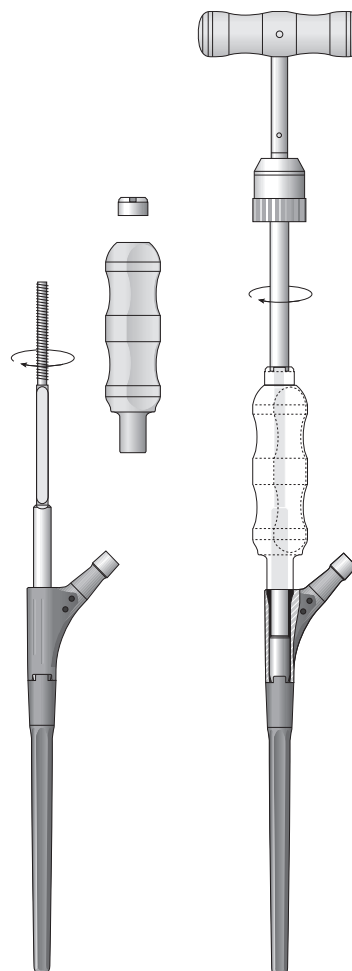

**Fig. 45**  
Connection of the two original components using the torque wrench.

### Connection of the Two Implant Components

The handle of the stem tensioner is firmly gripped and the two parts are connected with the torque wrench. During the connection process, one should watch for a change in the antetorsion (Fig. 46). For additional neutralization of the rotational forces, the stem can be inserted into the stem holder (REF 01.00409.807).

### Tightening of the Counternut

Afterwards, using the setting instrument (REF 79.15.82), the conical nut is placed onto the connecting taper and tightened with the torque wrench. In order to neutralise the rotational forces, the prosthesis is placed in the stem holder (REF 01.00409.807) when applying the conical nut (Fig. 47).

### Insertion of the Implant

The implant is impacted into the prepared bed with the impactor (REF 01.00409.800), which is screwed onto the proximal implant component (Fig. 48). The intensity of the hammer blows should be adjusted to the bone quality. The penetration depth of the implants should be compared with the rasp, which serves as the trial prosthesis (Fig. 48). If there is a degree of uncertainty, an X-ray image intensifier can be used on 2 plans, to ensure a good fit of the implant in the metaphyseal region. Afterwards, the control reduction is performed. Following a satisfactory control reduction, the trial head is changed to the selected definitive head.

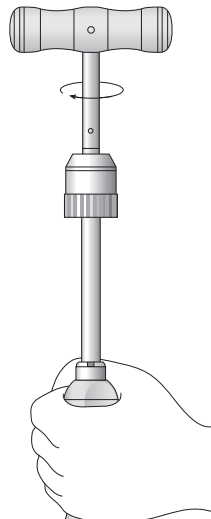

**Fig. 46**  
Combination of the two definitive components using the stem tensioner and the torque wrench.

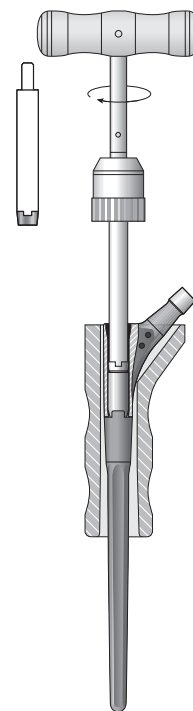

**Fig. 47**  
Insertion of the conical nut using the setting instrument (see left drawing) and tightening of the nut using the torque wrench and the stem holder. For additional neutralization of the rotational forces, the handle for counter force can be placed onto the taper of the prosthesis neck.

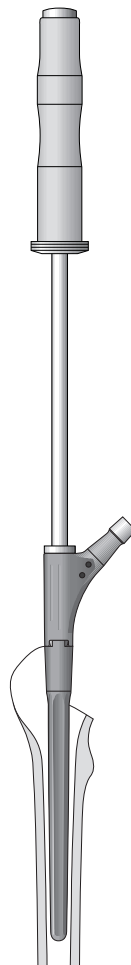

**Fig. 48**  
Impacting of the implant with the impactor

### Important:

When assembling the proximal with distal implant component you **must not** apply hammer-blows.

### Control Reduction and Wound Closure

The definitive implant neck length can be determined using trial heads of different lengths. Following thorough cleaning of the taper, the definitive head is put on with a slight turn and then fastened with a light hammer blow.

During wound closure, it is possible to fasten non-metallic suturing material with 2 bore holes medial to the proximal femur component, which can be helpful for closing proximal bone windows (e.g., during the trans-femoral approach) or for reattaching the trochanter (e.g., during the transtrochanteric approach).

### Tip

We advise against the use of metallic cerclage wires, since these wires can produce undesirable metallic wear particles, or there can be a risk of corrosion of the various metals.

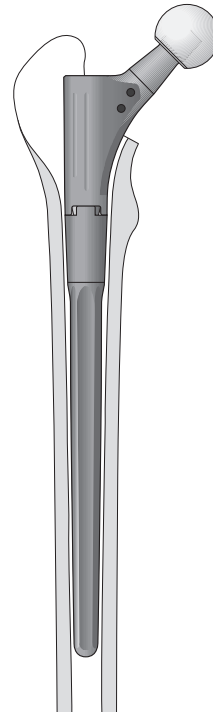

**Fig. 49**  
Completed implantation  
of the definitive prosthesis  
with head.

## Additional Distal Locking

If no secure circular surface fixation can be achieved during a desired distal fixation, it is possible in the case of the **Revitan Curved**, beginning with a stem diameter of 18 mm and a length of 200 mm, to optimize this by the additional placement of locking screws. This can be the case, if, e.g., in the presence of osteoporotic femurs where the medullary canal is expanded and no real isthmus region exists any more for a distal fixation.

Furthermore, an additional distal locking can be indicated in the case of peri-prosthetic fractures with long spiral fractures in or above the isthmus region. Overall, however, an additional distal locking should be viewed as an additive safety measure in exceptional cases. It should not be routinely used, nor does it permit one to dispense with a secure three surfaces fixation or circular surface fixation, if this is technically possible.

### Distal Locking with the Targeting Device (Can be Performed Only in the Case of an In-Situ Assembly)

#### The following stems are lockable:

Lengths of 200 mm and 260 mm, each beginning with a diameter of 18 mm.

The use of the targeting device occurs prior to setting the definitive proximal component onto the distal component that is anchored in the femur.

The targeting module, which corresponds to the length of the inserted distal component (Lengths: 200 mm or 260 mm), is connected with the coupling arm and fastened with the screw. This design represents the so-called targeting device (Fig. 51).

#### Tip

During assembly, pay attention to the right/left marking.

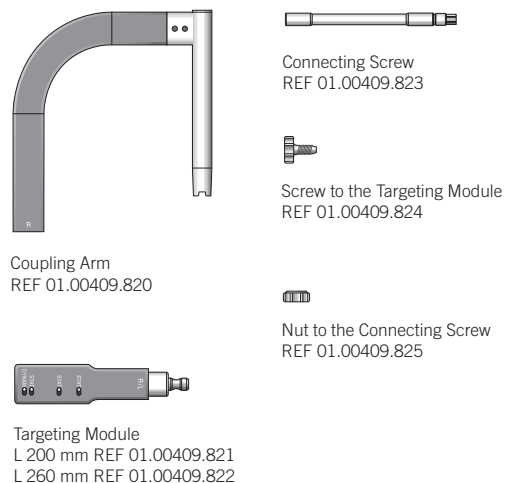

**Fig. 50**  
Components of the Targeting Device.

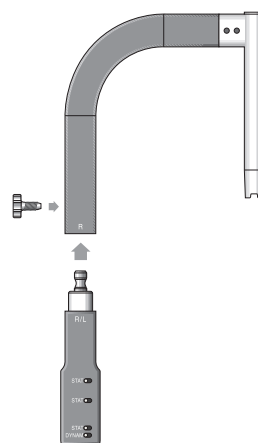

**Fig. 51**  
Assembly of the Targeting Device.

As the next step, the connecting screw is screwed onto the connecting taper of the implant and tightened with the tightening instrument (REF 01.00409.826), and the targeting device is placed onto the distal implant component using the connecting screw (Fig. 52). During this process, the cams of the targeting device must latch precisely into the grooves of the implant component. Using a tightening instrument (REF01.00409.827), this structure is tightened with a nut, which is placed over the connecting screw (Fig. 53).

The distal locking can be performed statically or dynamically. For dynamic locking, only one locking screw is positioned in the elongated hole.

**Tip**

The bore hole on the targeting device that is labeled STAT is used for static locking; the bore hole labeled DYNAM is used for dynamic locking.

The tissue protective sleeve with inserted trocar is guided into the desired target bore hole. The skin is incised at the appropriate location and made blunt up to the bone with scissors or a clamp. The tissue protective sleeve with inserted trocar is inserted in until it bears on the bone (Fig. 54). The trocar is then removed. Using the twist drill (Ø 4.0 mm) that has been placed into the tissue protective sleeve, a bore hole is made through both cortical walls (Fig. 55). The screw length is determined by measuring with the screw-length measuring device (Fig. 56). Alternatively, the screw length can also be read directly from the drill. Thereby the drill tip juts only slightly out of the second corticalis.

The previously determined size of locking screw (Ø 4.9 mm) is inserted through the tissue protective sleeve with the screw-driver (Fig. 57).

Fig. 52

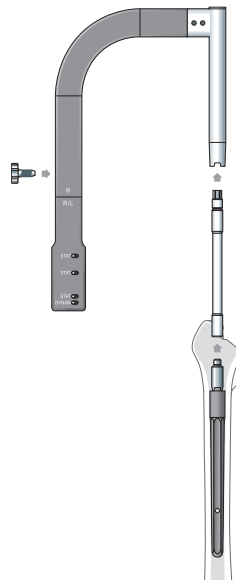

Fig. 53

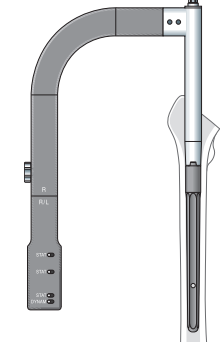

Fig. 54

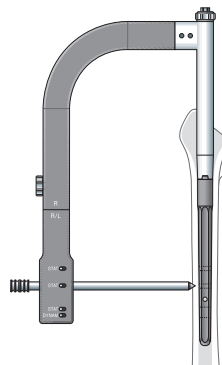

Fig. 55

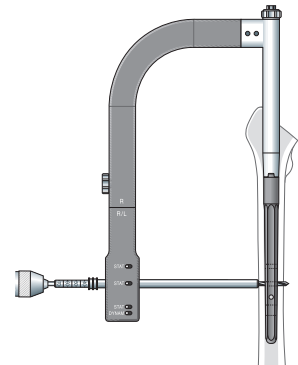

Fig. 56

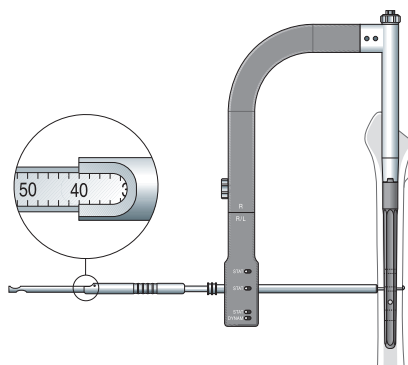
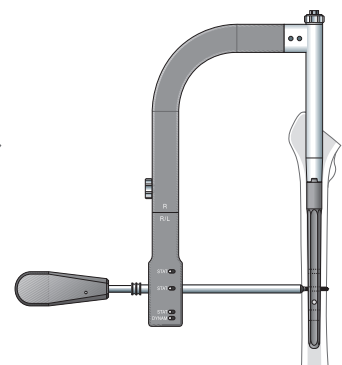

Fig. 57





## Postoperative Treatment

The correct fit of the inserted locking screw should be monitored using image intensifier. The same procedure is to be used for dynamic locking, whereby the bore hole (DYNAM) provided on the targeting device should be used.

**Fig. 58**

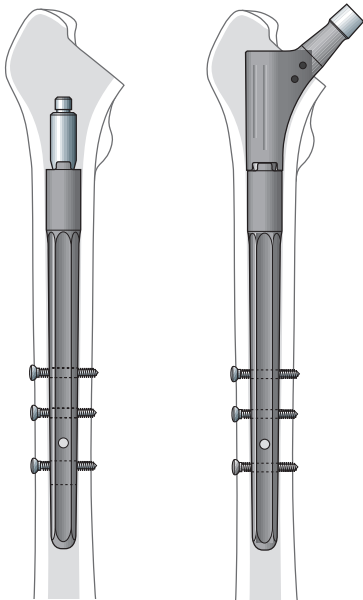

Completed distal locking and subsequent in-situ assembly of the proximal component on the distal original component.

The postoperative follow-up treatment depends, on the one hand, on whether a femoral osteotomy or a transfemoral approach was performed. On the other hand, the bone quality, the patient's age, and the intraoperatively achieved quality of the anchoring also play a role. For this reason, no specific guidelines are quoted in this surgical manual. Generally, however, it is advisable for the patient to put only partial weight on the leg for 6 weeks following surgery. If a transfemoral approach was selected, the load should not exceed 20 kg for these 6 weeks; and the decision on further load increases should be dependent upon follow-up X-rays. Furthermore, in the case of a transfemoral approach, during the first 6 weeks, no extreme bending of more than 70–80 degrees should be performed, so as not to jeopardize the refixation of the bone flap.

## Case Studies

### Endofemoral Procedure

57-year-old male patient with Morbus Bechterew and bilateral change of an infected total endoprosthesis of the hip to a cementless revision endoprosthesis with a **Revitan Curved** stem via an endofemoral approach, right side.



Preoperative AP X-ray.



Postoperative axial X-ray, 6 months  
Following THA-reimplantation with *Revitan*  
stem via endofemoral approach.



Postoperative AP X-ray, 6 months.

75-year-old female patient with coxarthrosis and bilateral change of an infected total endoprosthesis of the hip to a cementless revision prosthesis with **Revitan Curved** stem via endofemoral approach, right side.



Preoperative AP X-ray.



Implanted canalr following THA removal.



Postoperative axial X-ray, 6 months  
Reimplantation of a cementless revision system with a *Revitan Curved* stem via an endofemoral approach.



Postoperative AP X-ray, 6 months.

## Transfemoral Procedure

68-year-old male patient with aseptically loosened cemented stem prosthesis and varization of the femur, which was changed to a **Revitan Curved** stem via a transfemoral approach.



Preoperative  
Left hip with loosened cemented stem prosthesis.



Postoperative, 6 months  
With *Revitan Curved* stem system that was implanted via a transfemoral approach with simultaneous axis correction. Osseous consolidation of the osteotomy flap.

78-year-old male patient with coxarthrosis and aseptically loosened cemented stem with osteolyses at risk of fracture, which was changed to a cementless **Revitan Curved** revision stem via a transfemoral approach.



Preoperative X-ray  
With periprosthetic osteolyses.



Postoperative AP X-ray, 1 month  
With *Revitan Curved* stem, which was implanted  
via a transfemoral approach, in order to prevent  
intraoperative or perioperative fractures.

# Appendix 1

## Use of the Torque Wrench

### Principle of the Torque Wrench

The torque wrench is used for connecting the proximal and the distal implant components using the stem tensioner, as well as for tightening and removing the conical nut during the implantation or extraction of the implant. Thanks to the new system with PE shear pins, the torque wrench does not need to be calibrated; it thus provides the user with a high degree of safety.

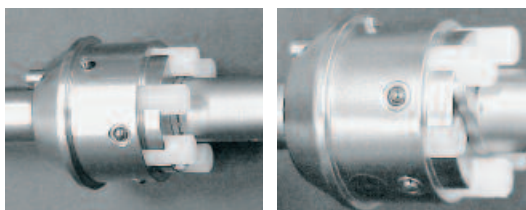
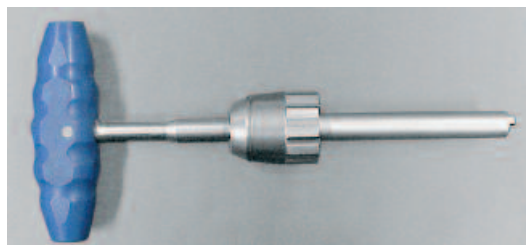

### Loading the Torque Wrench with the Shear Pins

The torque wrench and shear pins must be cooled to room temperature (20°C, 68°F), otherwise, their function can be impaired.

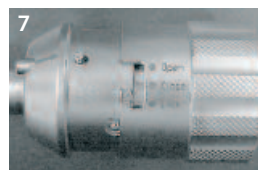
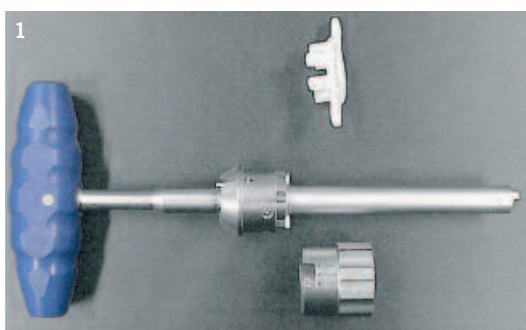

One load of shear pins (6 pcs.) is packed each time with the proximal implant component. The load of pins may neither be implanted nor resterilized. With one load of shear pins, a torque of approx. 10 Nm can be reached three times. This normally suffices for the implantation of a stem. If more shear pins are required, the torque wrench must be reloaded with a separate load of shear pins.

1) Unlock the capsular sleeve and turn to the "Open" position. Then carefully remove the capsular sleeve.

2 and 3) Carefully insert the shear pins axially, including loader, up to the stop in the recess. Turn loader 15° counterclockwise (direction of arrow) and remove.

4) Guide the capsular sleeve into the "Close" position and lock into the "Lock" position.

5) Following successful implantation of the prosthesis and, thus, the successful use of the torque wrench, unlock the capsular sleeve by pressing in the pin.

6) Turn the capsular sleeve to the "Open" position.

7) Open the capsular sleeve and discard and dispose of the unused shear pins. During the sterilization of the torque wrench, no shear pins may be located in the holder.

## Appendix 2

### Extraction of the Proximal and Distal Components

#### Disassembly and Extraction of the Proximal Component

The disassembly and extraction of the proximal component can be indicated in the case of:

- a change of the proximal component
- a change in the antetorsion position of the proximal component
- temporary removal in the case of isolated cup exchange, in order to improve the view onto the cup (at times necessary during anterolateral and transgluteal approach).

#### Important:

The threads of the threaded rod and the disassembly instrument should be treated after cleaning with a water-soluble product (for instance instrument milk or an equivalent lubricant) intended for surgical instruments, which are going to be sterilized (see Manual on Instrument Care 97-5000-170-00). At any rate it is imperative that the threads are moistened with Ringer solution before use.

#### Extraction of the Distal Component

The extraction of the distal component is performed after the proximal component has been removed. The extraction instrument for the distal part (REF 01.00079.011) is screwed onto the connecting taper. The slap hammer is placed onto the extraction instrument, and, with light hammer blows in the axis of the distal implant component, the component can be removed.

#### Important:

If the distal stem cannot be extracted from the femur with a few hammerblows additional measures have to be taken, like longitudinal osteotomies, a window, a flap or the introduction of flat chisels along the stem to facilitate the extraction of the distal component.

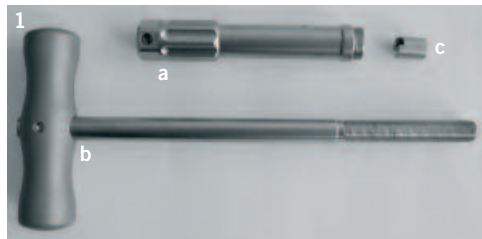

- 1) Disassembly instruments
  - a) Disassembly instrument (REF 01.00409.801)
  - b) Threaded rod for disassembly instrument (REF 01.00409.803)
  - c) Disassembly sleeve (REF 01.00409.816)

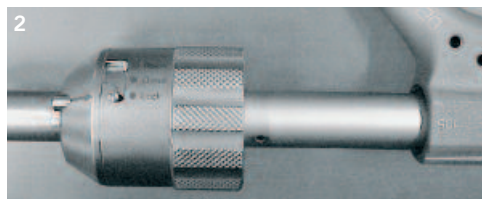

- 2) The torque wrench is in the "Lock" position.



- 3) Removal of the conical nut with the torque wrench.



- 4) Screwing the disassembly sleeve (REF 01.00409.816) onto the distal implant component, using the setting instrument (01.00409.815)



- 5) Screw the disassembly instrument (REF 01.00409.801) into the thread on the shoulder of the proximal component.

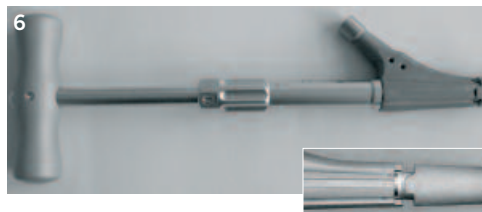

- 6) The threaded rod with T-handle (REF 01.00409.803) is screwed into the disassembly instrument. By firmly turning, the threaded sleeve, and thus the distal implant component is pressed downward; and pressure is exerted simultaneously on the proximal component with the disassembly instrument.



- 7) Decoupling of the proximal component.



- 8) Removal of the disassembly sleeve using the setting instrument.

# Implants

## Revitan® Curved



Proximales Teil, konisch<sup>1)</sup>  
Proximal part, spout<sup>1)</sup>  
Partie proximale, tulipée<sup>1)</sup>



Proximales Teil, zylindrisch<sup>1)</sup>  
Proximal part, cylindrical<sup>1)</sup>  
Partie proximale, cylindrique<sup>1)</sup>



Distales Teil, kurviert  
Distal part, curved  
Partie distale, courbe

Protasul®-100  
Taper 12/14  
uncemented

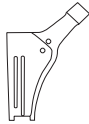

Protasul®-100  
Taper 12/14  
uncemented



Protasul®-100  
Protasul®-21 WF  
uncemented

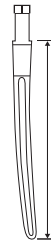

STERILE R

STERILE R

STERILE R

L mm	REF	L mm	REF
55	01.00401.055	55	01.00402.055
65	01.00401.065	65	01.00402.065
75	01.00401.075	75	01.00402.075
85	01.00401.085	85	01.00402.085
95	01.00401.095	95	01.00402.095
105	01.00401.105	105	01.00402.105

∅ mm	L mm	REF
14	140	01.00406.114
16	140	01.00406.116
18	140	01.00406.118
20	140	01.00406.120
22	140	01.00406.122
24	140	01.00406.124*

**Auf Anfrage**  
**On request**  
**Sur demande**



Konusmutter, steril  
Conical nut, sterile  
Ecrou conique, stérile

REF  
01.00405.000

14	200	01.00406.214
16	200	01.00406.216
18	200	01.00406.218 <sup>2)</sup>
20	200	01.00406.220 <sup>2)</sup>
22	200	01.00406.222 <sup>2)</sup>
24	200	01.00406.224 <sup>2)</sup>
26	200	01.00406.226 <sup>2)</sup> *
28	200	01.00406.228 <sup>2)</sup> *
16	260	01.00406.316
18	260	01.00406.318 <sup>2)</sup>
20	260	01.00406.320 <sup>2)</sup>
22	260	01.00406.322 <sup>2)</sup>
24	260	01.00406.324 <sup>2)</sup>
26	260	01.00406.326 <sup>2)</sup> *
28	260	01.00406.328 <sup>2)</sup> *

- <sup>1)</sup> Mit Abscherstiften und Ladehilfe  
verpackt  
<sup>1)</sup> Packed with shear pins loader  
<sup>1)</sup> Emballée avec chargeur de broches  
sécables

- <sup>2)</sup> Verriegelbar  
<sup>2)</sup> Lockable  
<sup>2)</sup> Verrouillable

- <sup>\*</sup>) Auf Anfrage  
<sup>\*</sup>) On request  
<sup>\*</sup>) Sur demande



# Base Instruments

## Revitan® Curved



Sieb Basisinstrumente (komplett)  
Tray for base instruments (complete)  
Plateau pour instruments de base e(complet)  
REF  
ZS 01.00408.100



Sieb Basisinstrumente (leer)  
Tray for base instruments (empty)  
Plateau pour instruments de base (vide)  
REF  
01.00408.101

Einsatz zu Sieb Basisinstrumente (leer)  
Insert for tray for base instruments (empty)  
Insert pour plateau pour instruments de base (vide)  
REF  
01.00408.102

Standard-Siebdeckel, grau  
Standard tray cover, grey  
Couvercle standard pour plateau, gris  
REF  
01.00029.031



Handmarkraumböhrer  
Hand reamer  
Alésoir à main

REF  
79.10.46



Mutter zu Manipulierteil  
Nut for proximal trial part  
Ecrin pour pièce d'essai

REF  
01.00079.001



Griff zu Schaftspanner  
Handle for stem tensioner  
Poignée pour tendeur

REF  
01.00409.804



Haltegriff für Schaft  
Stem holder  
Manche de maintien pour tige

REF  
01.00409.807



Handgriff mit Schnellkupplung  
Handle with quick coupling  
Poignée à verrouillage rapide

REF  
75.00.25



Schlüssel zu Mutter  
Wrench for nut  
Clef pour écrou

REF  
01.00079.002



Gewindestange zu Schaftspanner  
Threaded rod for stem tensioner  
Tige filetée pour tendeur

REF  
01.00409.805



Gegenhalter  
Handle for counter force  
Manche de retenue

REF  
01.00409.809



Steckschlüssel 3,5 mm  
Hexagonal wrench 3.5 mm  
Clef à embout hexagonal 3,5 mm

REF  
79.15.84



Griff für modulare Raspeln  
Handle for modular rasps  
Poignée pour râpes modulaires

REF  
70.00.94



Mutter zu Schaftspanner  
Nut for stem tensioner  
Ecrin pour tendeur

REF  
01.00409.806



Drehmomentschlüssel  
Torque wrench  
Clef dynamométrique à barillet

REF  
01.00409.808

Langer Querstab  
Long bar  
Barre longue

REF  
70.00.01

# Base Instruments

## Revitan® Curved



Setzinstrument für Konusmutter  
Setting instrument for conical nut  
Instrument de pose pour écrou conique  
REF  
79.15.82



Gewindestange für Demontageinstrument  
Threaded rod for disassembly instrument  
Tige filetée pour instrument de démontage  
REF  
01.00409.803



Raspeladapter mit Längenmarkierung  
Rasp adapter with length markings  
Barre graduée pour râpe  
REF  
01.00409.501



Einschläger  
Impactor  
Impacteur  
REF  
01.00409.800



Extraktionsinstrument für distales Teil  
Extraction instrument for distal part  
Pièce de démontage pour partie distale  
REF  
01.00079.011



Führungshülse für Hohlfräser proximal  
Guiding sleeve for hollow reamer proximal  
Manchon de guidage pour fraise creuse proximale  
REF  
01.00409.802



Demontageinstrument  
Disassembly instrument  
Instrument de démontage  
REF  
01.00409.801



Massstab, 30 cm  
Ruler, 30 cm  
Réglette, 30 cm  
REF  
75.11.30



Demontagehülse  
Disassembly sleeve  
Douille de démontage  
REF  
01.00409.816



Manipulierkugelkopf  
Trial ball head  
Tête d'essai  
Grösse/Size/Taille ø mm REF  
S 28 6896  
M 28 6897  
L 28 6898  
XL 28 01.01519.808



Setzinstrument Demontagehülse  
Setting device for disassembly sleeve  
Porte douille de démontage  
REF  
01.00409.815

Grösse/Size/Taille	ø mm	REF
S	32	6836
M	32	6837
L	32	6838
XL	32	01.01519.208

# Base Instruments

## Revitan® Curved

Auf Anfrage  
On request  
Sur demande



Abscherstifte mit Ladehilfe, steril  
Shear pins loader, sterile  
Chargeur de broches sécables, stéril

REF  
01.00409.810



IMT Raspeladapter  
IMT Rasp adapter  
Barre pour râpe avec IMT

REF  
01.00409.813

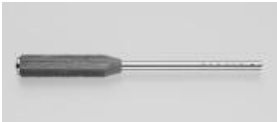

Einschlaginstrument distal  
Impactor distal  
Impacteur distal

REF  
01.00409.811



IMT Raspeladapter proximal  
IMT Rasp adapter proximal  
Connexion pour râpe avec IMT

REF  
01.00049.083



Hohlfräser proximal  
Hollow reamer proximal  
Fraise creuse proximale

REF  
01.00409.812



Manipulierkugelkopf  
Trial ball head  
Tête d'essai

Grösse/Size/Taille	Ø mm	REF
S	36	01.01519.635
M	36	01.01519.636
L	36	01.01519.637
XL	36	01.01519.638

## Instruments Proximal Spout Revitan® Curved



Sieb für Instrumente proximal konisch (komplett)  
Tray for instruments proximal spout (complete)  
Plateau pour instruments proximaux tulipés (complet)

REF  
ZS 01.00408.300

Sieb für Instrumente proximal konisch (leer)  
Tray for instruments proximal spout (empty)  
Plateau pour instruments proximaux tulipés (vide)

REF  
01.00408.301

Kleiner Siebdeckel, grau  
Small tray cover, grey  
Couvercle petit pour plateau, gris

REF  
01.00029.032



Raspel proximal konisch  
Rasp proximal spout  
Râpe proximale tulipée

Grösse/Size/Taille	REF
55	01.00409.155
65	01.00409.165
75	01.00409.175
85	01.00409.185
95	01.00409.195
105	01.00409.105



Manipulierteil proximal konisch  
Trial part proximal spout  
Pièce d'essai proximale tulipée

Grösse/Size/Taille	REF
55	01.00409.156
65	01.00409.166
75	01.00409.176
85	01.00409.186
95	01.00409.196
105	01.00409.106

## Instruments Proximal Cylindrical Revitan® Curved



Sieb für Instrumente proximal zylindrisch (komplett)  
Tray for instruments proximal cylindrical (complete)  
Plateau pour instruments proximaux cylindriques (complet)

REF  
ZS 01.00408.200

Sieb für Instrumente proximal zylindrisch (leer)  
Tray for instruments proximal cylindrical (empty)  
Plateau pour instruments proximaux cylindriques (vide)

REF  
01.00408.201

Kleiner Siebdeckel, grau  
Small tray cover, grey  
Couvercle petit pour plateau, gris

REF  
01.00029.032



Raspel proximal zylindrisch  
Rasp proximal cylindrical  
Râpe proximale cylindrique

Grösse/Size/Taille	REF
55	01.00409.255
65	01.00409.265
75	01.00409.275
85	01.00409.285
95	01.00409.295
105	01.00409.205



Manipulierteil proximal zylindrisch  
Trial part proximal cylindrical  
Pièce d'essai proximale cylindrique

Grösse/Size/Taille	REF
55	01.00409.256
65	01.00409.266
75	01.00409.276
85	01.00409.286
95	01.00409.296
105	01.00409.206

# Instruments Distal Curved

## Revitan® Curved

Sieb distal kurviert (komplett)  
 Tray distal curved (complete)  
 Plateau distal courbe (complet)  
 REF  
 ZS 01.00408.400



	Ø mm	L mm	REF
Sieb distal kurviert (leer) Tray distal curved (empty) Plateau distal courbe (vide)			
REF	14	140	01.00409.612
01.00408.401	16	140	01.00409.613
	18	140	01.00409.614
Standard-Siebdeckel, grau	20	140	01.00409.615
Standard tray cover, grey	22	140	01.00409.616
Couvercle standard pour plateau, gris	24	140	01.00409.617*
REF			
01.00029.031	14	200	01.00409.622
	16	200	01.00409.623
	18	200	01.00409.624
	20	200	01.00409.625
	22	200	01.00409.626
	24	200	01.00409.627
	26	200	01.00409.628*
	28	200	01.00409.629*
	16	260	01.00409.633
	18	260	01.00409.634
	20	260	01.00409.635
	22	260	01.00409.636
	24	260	01.00409.637
	26	260	01.00409.638*
	28	260	01.00409.639*

\*1) Auf Anfrage  
 \*1) On request  
 \*1) Sur demande

# Locking Instruments

## Revitan® Curved

Sieb Zielbügelinstrumentarium  
(komplett)  
Tray targeting device (complete)  
Plateau pour dispositif de verrouillage  
(complet)

REF  
ZS 01.00408.600



Kupplungsarm  
Coupling device for targeting module  
Pièce de raccord pour module de  
visée

REF  
01.00409.820

Sieb Zielbügelinstrumentarium (leer)  
Tray targeting device (empty)  
Plateau pour dispositif de verrouillage  
(vide)

REF  
01.00408.601

Standard Siebdeckel, grau  
Standard tray cover, grey  
Couvercle standard pour plateau, gris

REF  
01.00029.031



Zielmodul  
Targeting module  
Module de visée

L mm REF  
200 01.00409.821  
260 01.00409.822



Mutter zu Verbindungsschraube  
Nut for connecting screw  
Ecrou pour vis de raccord

REF  
01.00409.825



Gewebeschutzhülse  
Tissue protection sleeve  
Douille protectrice

REF  
02.00020.005



Anziehinstrument zu Verbindungs-  
schraube  
Tightening instrument for connecting  
screw  
Instrument de fixation pour vis de  
raccord

REF  
01.00409.826



Trokar  
Trocar  
Trocart

REF  
02.00020.006



Verbindungsschraube für Zielbügel  
Connecting screw for coupling device  
Vis de raccord pour dispositif de  
verrouillage

REF  
01.00409.823



Anziehinstrument  
Tightening instrument  
Instrument de fixation

REF  
01.00409.827



Schraubenlängenmessgerät  
Measuring device for locking screws  
Jauge de longueur pour vis de  
verrouillage

REF  
02.00020.048



Schraube zu Zielmodul  
Screw for targeting module  
Vis pour module de visée

REF  
01.00409.824



Spiralbohrer 3-lippig  
Three-fluted drill bit  
Mèche à 3 tranchants

REF  
01.00409.828



Schraubendreher, gross  
Large hexagonal screwdriver  
Grand tournevis hexagonal

L mm REF  
340 02.00020.112

# Locking Screws Revitan® Curved

Schraubenbox (leer)  
Screw box (empty)  
Plateau pour vis (vide)

REF  
100.99.014/4



Verriegelungsschraube,  
selbstschneidend, *Protasul*®-100  
Locking screw,  
self-tapping, *Protasul*®-100  
Vis de verrouillage,  
autotaraudante, *Protasul*®-100

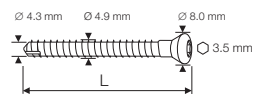

Ø mm	L mm	quantity*	REF
4.9	32	3	02.03149.032
4.9	34	3	02.03149.034
4.9	36	3	02.03149.036
4.9	38	3	02.03149.038
4.9	40	3	02.03149.040
4.9	42	3	02.03149.042
4.9	44	3	02.03149.044
4.9	46	3	02.03149.046
4.9	48	3	02.03149.048
4.9	50	3	02.03149.050
4.9	52	3	02.03149.052
4.9	54	3	02.03149.054



Schraubenpinzette selbsthaltend  
Screw forceps self-holding  
Brucelle autoserrante pour vis

REF  
100.90.005

**Disclaimer**

This document is intended exclusively for physicians and is not intended for laypersons.

Information on the products and procedures contained in this document is of a general nature and does not represent and does not constitute medical advice or recommendations. Because this information does not purport to constitute any diagnostic or therapeutic statement with regard to any individual medical case, each patient must be examined and advised individually, and this document does not replace the need for such examination and/or advice in whole or in part.

Information contained in this document was gathered and compiled by medical experts and qualified Zimmer personnel. The information contained herein is accurate to the best knowledge of Zimmer and of those experts and personnel involved in its compilation. However, Zimmer does not assume any liability for the accuracy, completeness or quality of the information in this document, and Zimmer is not liable for any losses, tangible or intangible, that may be caused by the use of this information.

Contact your Zimmer representative or visit us at [www.zimmer.com](http://www.zimmer.com)



Lit. No. 06.01169.012x – Ed. 08/2009 ZHUB



+H8440601169012X1/\$090801H09%