



surgival
GRUPO COSÍAS

TOTAL KNEE SYSTEM

GENUTECH®

SURGICAL TECHNIQUE

A B C D E



COMPLETE INSTRUMENT SET

FEMORAL 1 UPPER TRAY

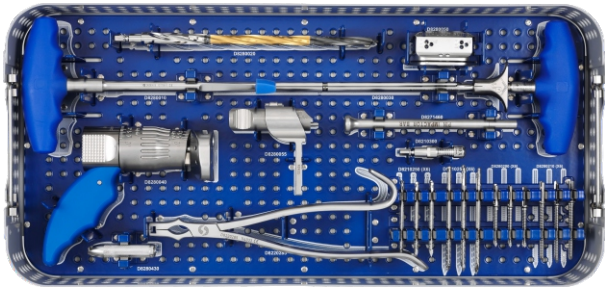

FEMORAL 1 LOWER TRAY

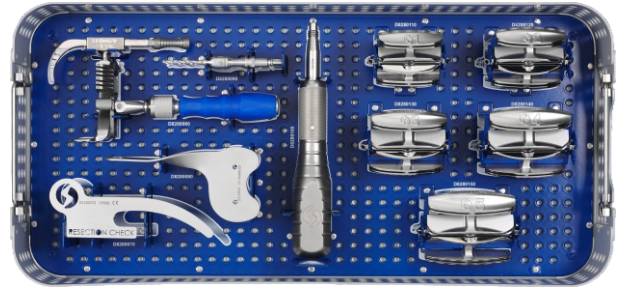

FEMORAL 2 UPPER TRAY

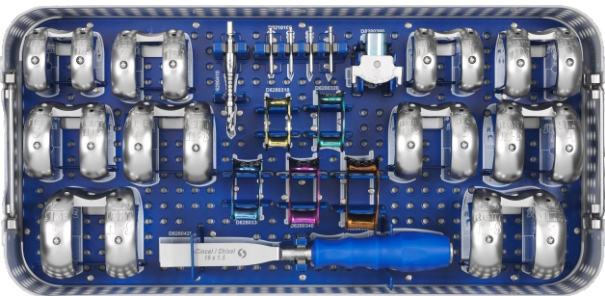

FEMORAL 2 LOWER TRAY

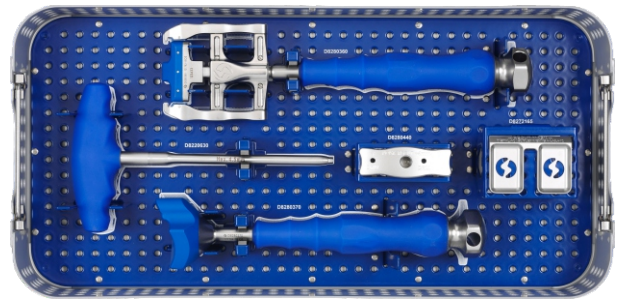

TIBIAL UPPER TRAY

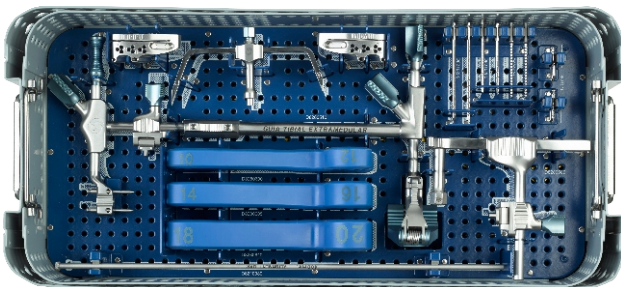

TIBIAL LOWER TRAY

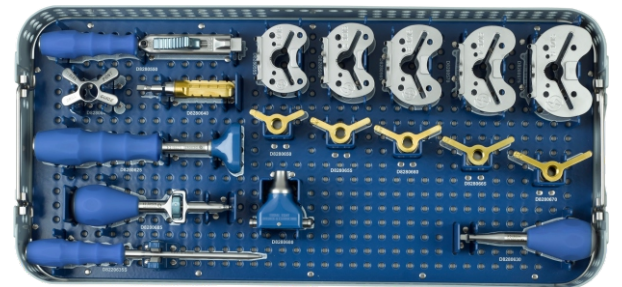

NPS

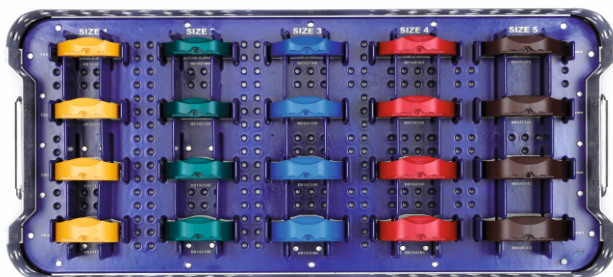

PS



PATELLA



COMPLEX PRIMARY SET *

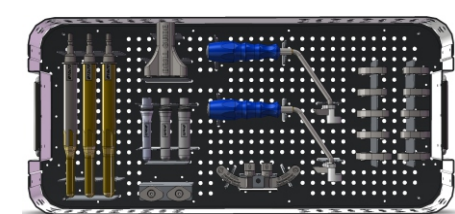

* OPTIONAL. Available upon request. Not compatible with previous versions of GENUTECH instruments

*	<i>T.0. Options: Intramedullary or Extramedullary Tibia</i>	Page 4
A	Femur distal cut and Tibial cut	
	<i>T.1. Tibial cut</i>	Page 6
	<i>F.1. Femur distal cut</i>	Page 10
	* <i>Spacers in extension</i>	Page 13
B	Finishing Femur	
	<i>F.2. Measuring Femoral size</i>	Page 14
	<i>F.3 Anterior and posterior Femoral cuts and bevels</i>	Page 16
	* <i>Spacers in flexion and extension</i>	Page 17
	* <i>Tibial and femoral recuts</i>	Page 17 and 18
	<i>F.4 Trial Femoral component</i>	Page 19
	<i>NPS or PS</i>	
C	Finishing Tibia	
	<i>T.2. Measuring and positioning tibial tray</i>	Page 20
	<i>T.3 Carve the tibial keel space</i>	Page 21
*	<i>Flexo-extension tests with trial components</i>	Page 22
D	Patella	
	<i>P.1. Patellar time</i>	Page 23
E	Femoral, Tibial and Patellar implants	
	<i>F.5 Definitive femoral implant</i>	Page 25
	<i>T.4 Definitive tibial implant</i>	Page 25
	<i>P.2. Definitive patellar implant</i>	Page 25
	PRODUCT REFERENCES	Page 27

T: TIBIA surgical times
P: PATELLA surgical times

F: FEMUR surgical times
* Intermediate surgical times



T.O. EXTRAMEDULLARY TIBIAL GUIDE

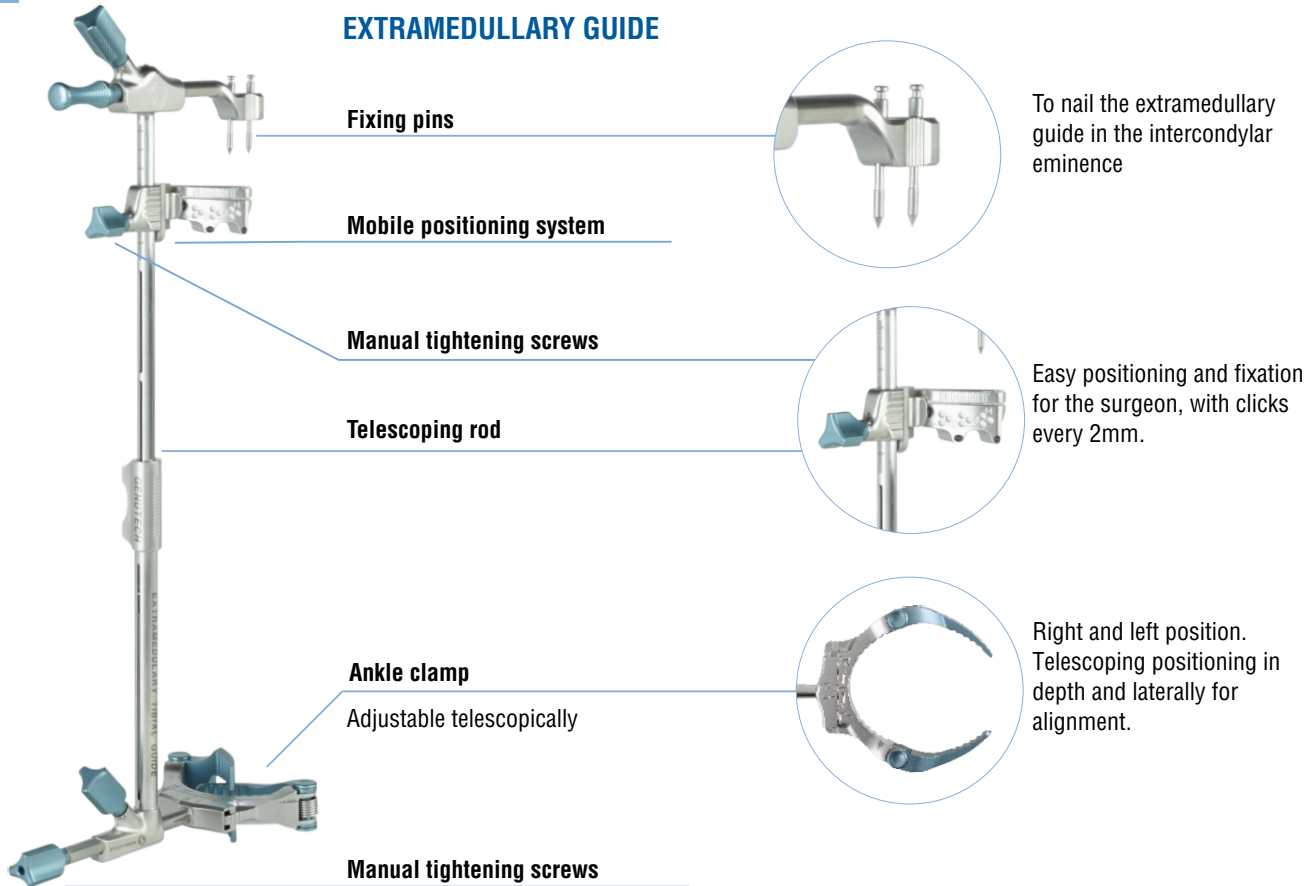

1 *Position the ankle clamp*

2 *Nail the posterior fixation pin and position the extramedullary guide*

In the tibial intercondylar eminence, which leaves the extramedullary guide free to rotate and position correctly (remember alignment references with the 2nd metatarsal and anterior tibial tuberosity and parallel to the tibial anterior border). Once in the desired position, it is fixed by nailing the anterior fixing pin.

3 *Nail the anterior fixing pin*

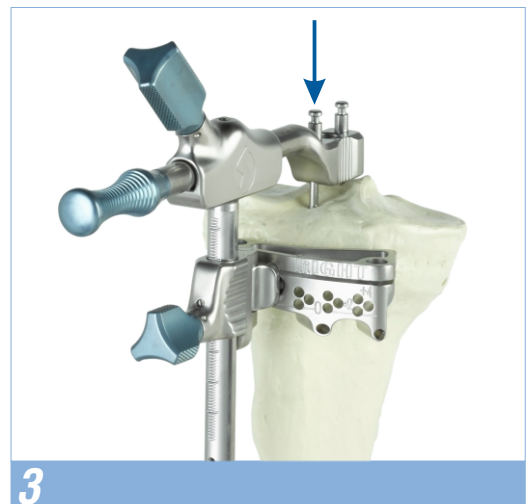
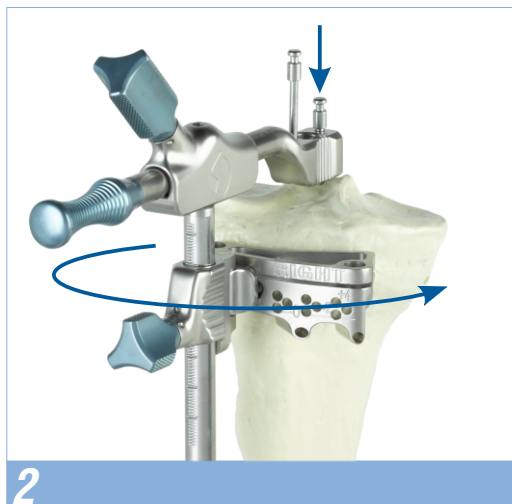

* **T.O. INTRAMEDULLARY TIBIAL GUIDE**

INTRAMEDULLARY GUIDE

Mobile positioning system

Intramedullary rod

Mobile positioning system

Millimetric positioning: 1 click = 2 mm

Manual tightening screw

Probe stylus

Cutting block

1 Initial perforation with the starter awl and/or drill with the starter drill

Perforate the chosen location on the cortical with the starter awl and/or drill with the starter drill to prepare the intramedullary canal for insertion of the intramedullary rod. The whole depth of the drill bit should be used, as the last part opens the canal a little more, to facilitate intramedullary cleaning and prevent thrombus.

Tip Femur can also be drilled to speed up surgery time.

2 Inserting the intramedullary rod

Use the T-handle to insert the intramedullary rod through the hole made. Remove the T-handle to insert the intramedullary guide.

3 Inserting the intramedullary guide: Via the intramedullary rod, until it rests on the tibia.



A T.1. TIBIAL CUT

Intramedullary and extramedullary

TIBIAL CUTTING BLOCK: Design justification

Cutting at 0°:

The cut is perpendicular to the intramedullary rod or extramedullary guide.

Magnetic grip

Easy to attach to the alignment guide.

Anatomic, minimally invasive design
 To avoid soft tissues and patellar tendon.

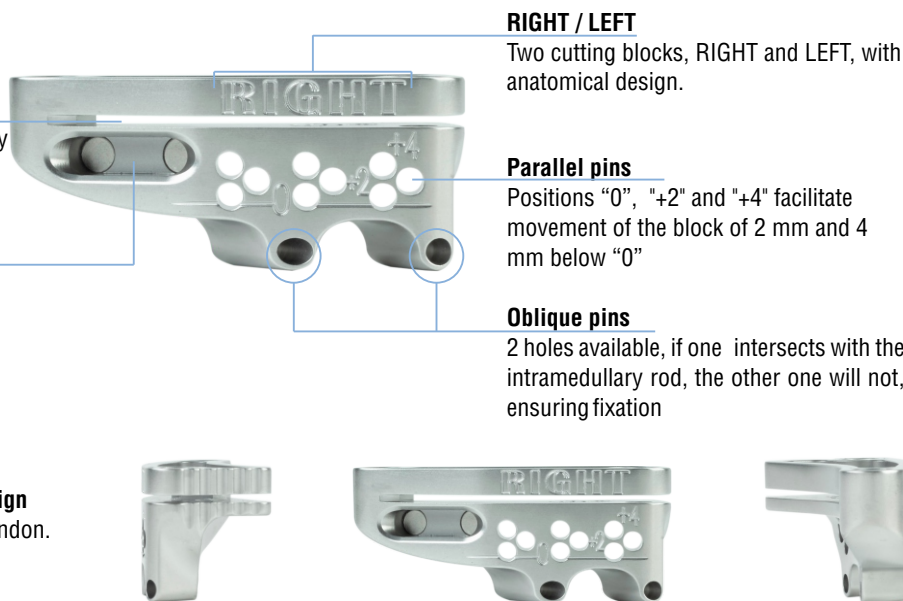

PROBE STYLUS "10/0": Design justification

The probe stylus "10/0" is designed to establish the level at which to perform the tibial cut.

One end is marked with the number "10" and the other with number "0". The probe is inserted in the tibial cutting block with the end "10" contacting the tibia; the cut is made 10 mm below that point.

This 10 mm resection height corresponds to the total thickness of the smallest tibial component (tray + insert).

The "0" end indicates the exact level at which the saw will resect.

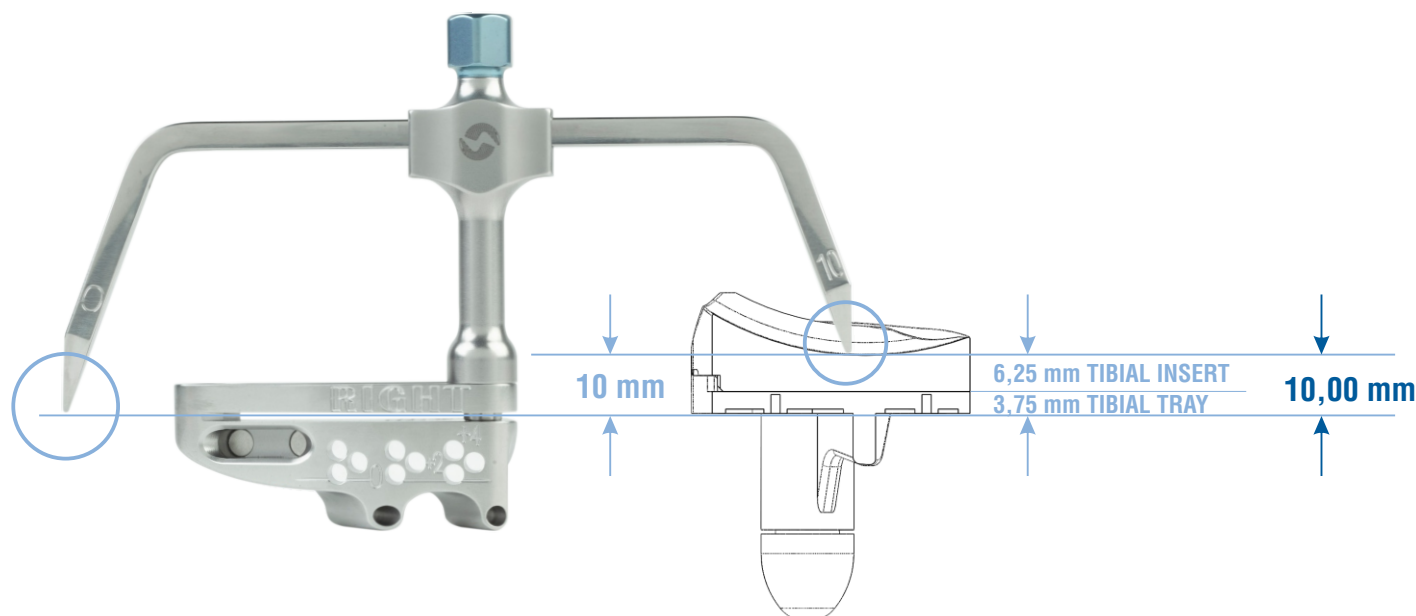

A T.1. TIBIAL CUT

Intramedullary and extramedullary

- 1** **TOUCH with the “10” end of the stylus on the highest tibial plateau**
 Loosen the manual tightening screw of the cutting block to allow the cutting block to move up and down freely on its guide and place the stylus in one of the two housings, then, slide down the cutting block up or down on the cutting guide until the stylus at the “10” end contacts with the highest tibial plateau.
- 2** **TIGHTEN the manual screw to fix the cutting block position on the alignment guide.**
 After the probe at the “10” end is in contact with the highest tibial plateau, tighten the manual tightening screw to fix the position of the cutting block on the cutting guide before the checking with the “0” end.
- 3** **CHECK with the “0” end the level of resection**
 Position the stylus perfectly fitted in one of its housings and remember that the “0” end indicates the level where the saw resects. Try to make contact on the most depressed part of the lowest tibial plateau with the “0” end. There are two possibilities:
 - A** If the “0” end is below the lowest tibial plateau, the cut **WILL** resect that tibial plateau. As the “0” end of the fully positioned stylus indicates the cutting level. Go to point 4.
 - B** If the “0” end is above the lowest tibial plateau, the cut will **NOT** resect that tibial plateau. As the “0” end of the fully positioned stylus indicates the cutting level. Go to point 3B on page 8 to reposition the level of the cutting block.

A **CUT: Go to point 4**

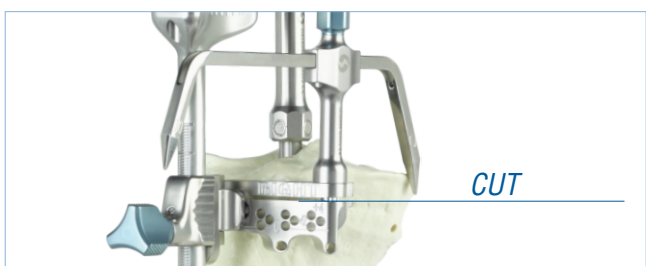

B **NO CUT: Go to point 3B on page 8**

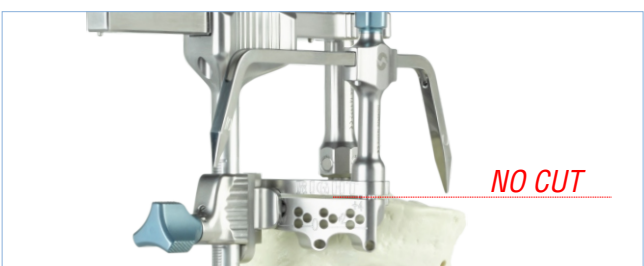

- 4** **Check resection levels with the resection checker.**
- 5** **Fix the cutting block with headless helical pins in the parallel holes “0” and one threaded pin with head in one of the oblique holes.**

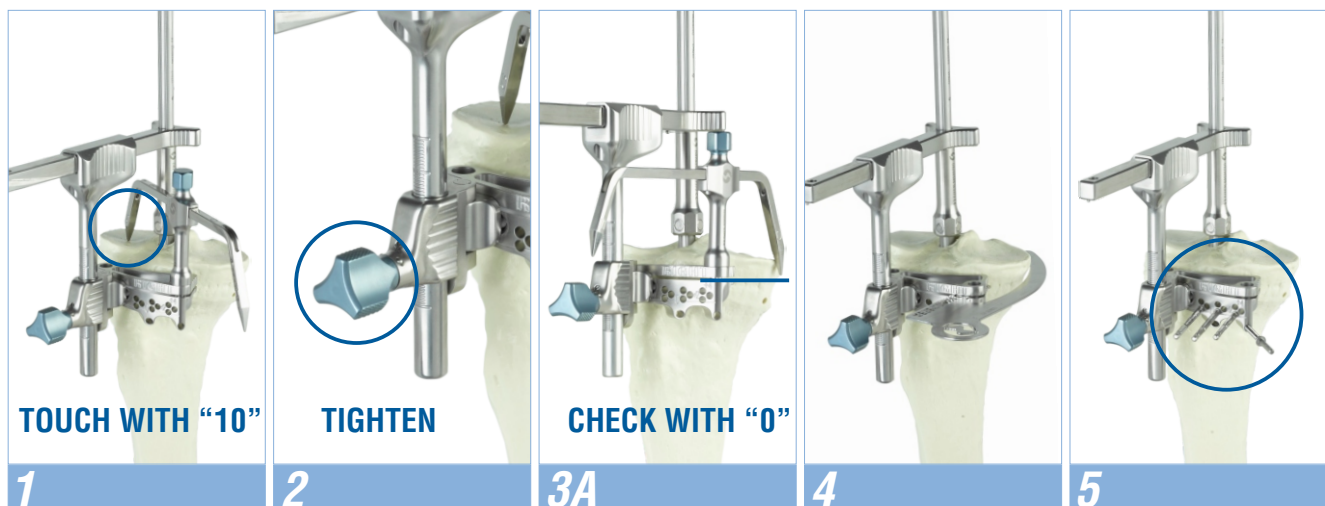

A T.1. TIBIAL CUT

3B As checked before, the “0” end is above the lowest tibial plateau. So **the cutting level must be readjusted** to ensure that the osteotomy completely resects the lower tibial plateau to properly support our tibial tray. Remember that the “0” end of the stylus indicates the exact cutting level.

With the stylus fully inserted in one of its housings, loosen the manual tightening screw and slide down the cutting block on the tibial cutting guide to touch with the “0” end on the most depressed area of the lowest plateau and set the new cutting level.

Tighten the manual screw to fix the cutting block level on the cutting guide.

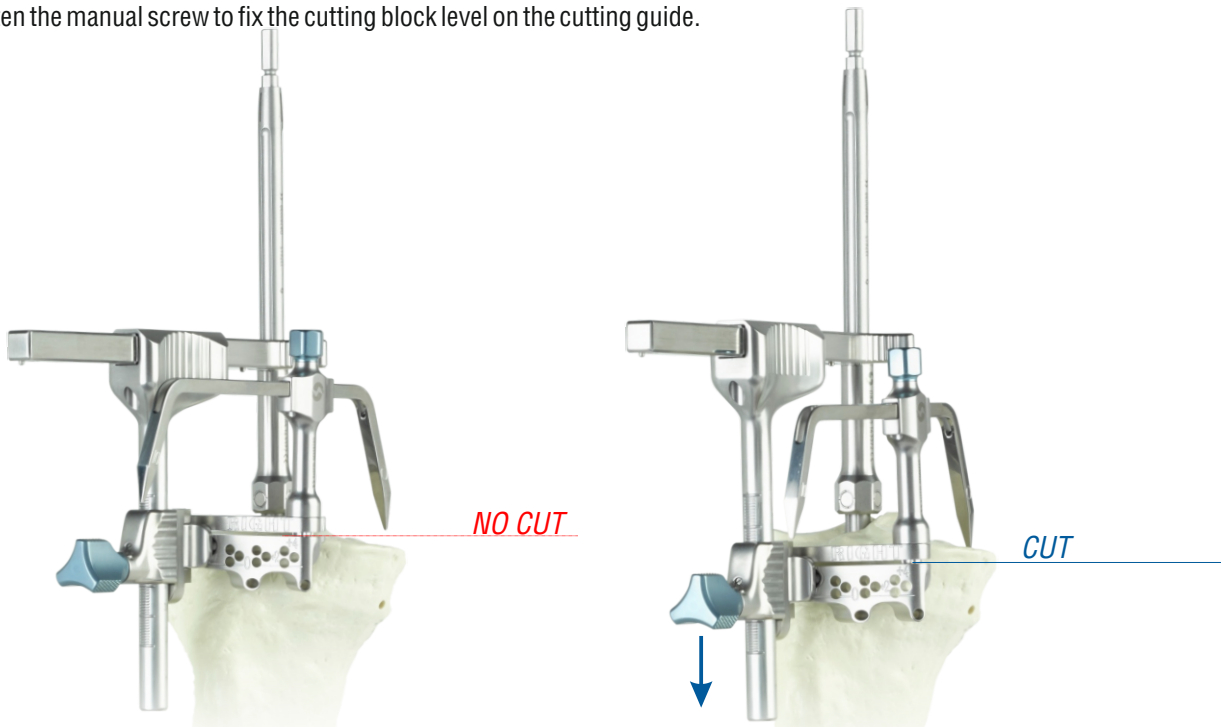

4 Check resection levels with the resection checker.

5 Fix the cutting block with headless helical pins in the parallel holes “0” and one threaded pin with head in one of the oblique holes.

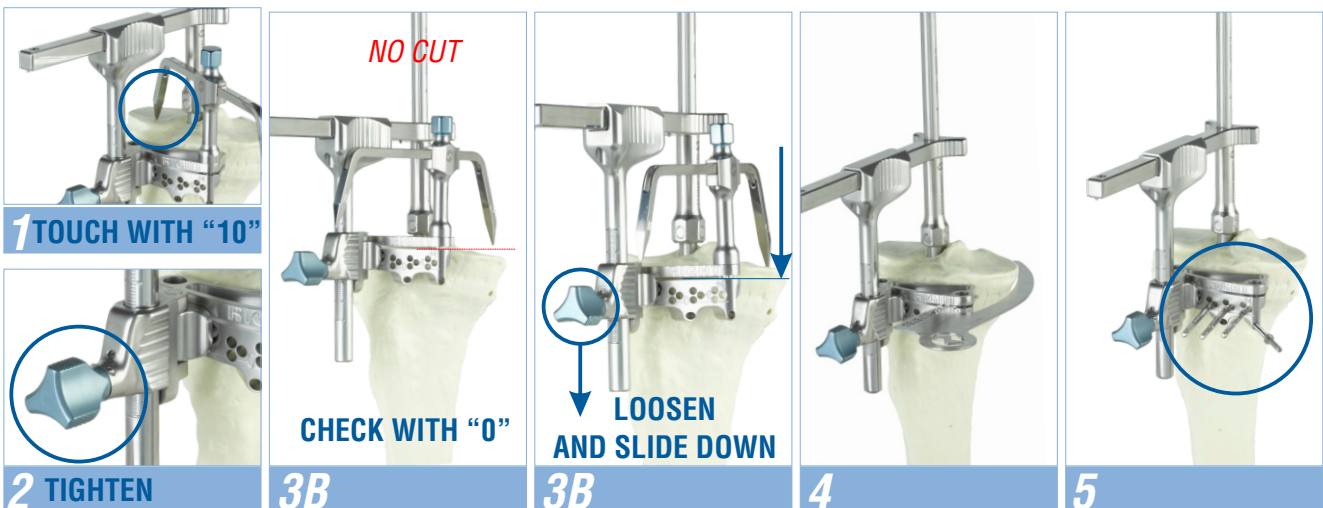

A T.1. TIBIAL CUT

REMOVE THE CUTTING GUIDE AND MAKE THE TIBIAL CUT



HOLES "+2", "+4"

To make a cut 2 mm or 4 mm below "0" level, remove the cutting block and insert it again through the holes marked as "+2" or "+4"

HEADLESS HELICAL PINS



Easy to insert, place in the "0" parallel holes to be able to remove the cutting block through them once the tibial cut has been made. Leave them in position for possible recuts.

THREADED PINS WITH HEAD



They ensure a stronger fixation by compressing the cutting block against the bone with their head. They are inserted into the oblique holes and have to be removed to remove the cutting block. There are two holes available, if one intersects with the intramedullary rod, the other one will not.

A Remove the extramedullary guide

A1 Screw the impactor/extractor handle to the top of the guide and pull upwards to unmail the fixing pins and leave the guide loose.

A2 Separate the magnetic coupling between the guide and the cutting block by pulling it backwards and open the ankle clamp.

B Remove the intramedullary guide

B1 Position the alignment rod T-handle and remove the intramedullary alignment rod.

B2 Separate the magnetic coupling between the guide and the cutting block by pulling it backwards.

3 **Make the tibial cut** (avoid the saw sag that will produce an incorrect cut). The saws must have a thickness of 1.27 mm. A lower thickness implies the risk of making inadequate cuts.

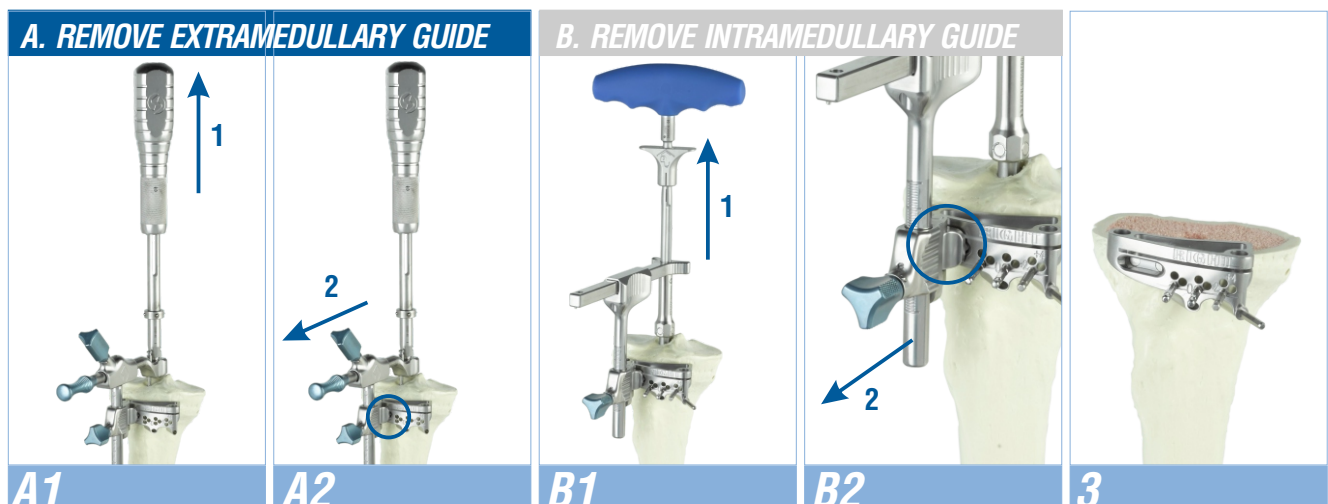

A F.1. FEMUR DISTAL CUT

VARUS-VALGUS ALIGNMENT GUIDE: Design justification

The fully assembled varus-valgus alignment guide has three parts: the ALIGNMENT GUIDE itself, the CUTTING BLOCK SUPPORT and the DISTAL CUTTING BLOCK.

DISTAL CUTTING BLOCK

MAGNETIC COUPLING FOR CUTTING BLOCK

Easy to insert and remove.

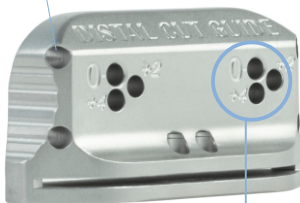

PIN HOLES

Pin holes +2 mm or +4 mm available for distal femur recut.

CUTTING BLOCK SUPPORT

LOCK LEVER "OPEN" / "CLOSED"

The selected position is blocked with the "CLOSED" mark facing up.

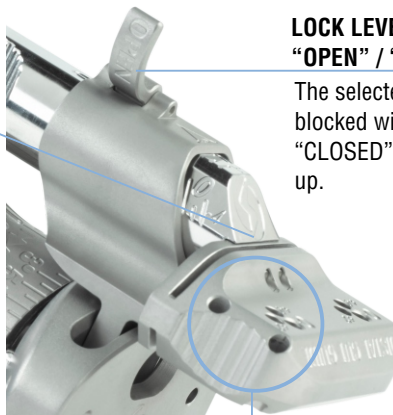

PIN HOLES

Holes for headless pins and oblique holes to fix the cutting block.

POSITION "0"

The "0" position establishes a resection level of 8 mm (equivalent to the thickness of our femoral component).

Adjustable from 4 mm to 16 mm

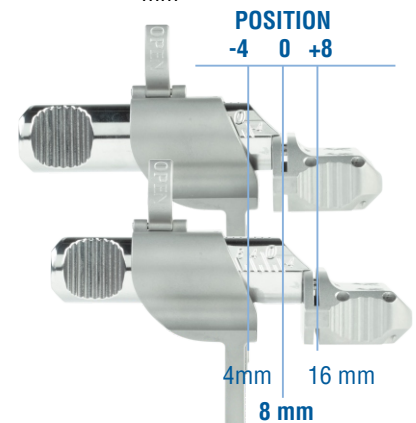

- 1** Set the distal cut value on the distal cutting block support and raise the locking lever to the CLOSED position
 Usually in the "0" position (the "0" position is equivalent to an 8 mm cut, which is the condylar thickness of our femoral implant) and fix that position by putting the locking lever in the CLOSED position.
- 2** Insert the distal cutting block on the support in its magnetic housing
- 3** Insert the cutting block support on the alignment guide slot
- 4** Rotate the barrel and select the RIGHT or LEFT side (depending the leg to operate) and select the varus-valgus alignment value between 0° and 9°.

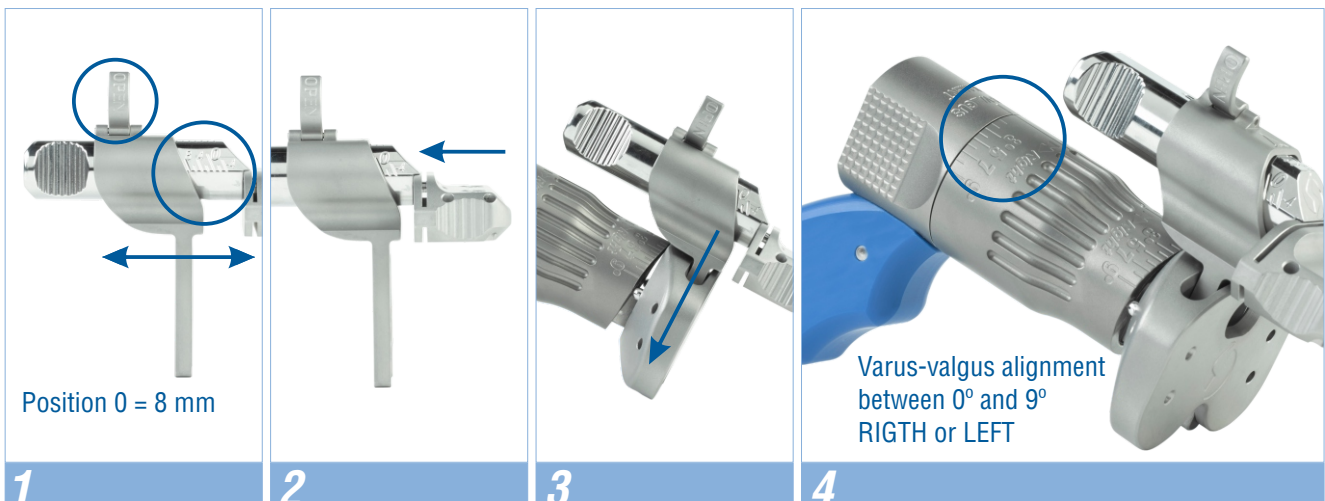

A F.1. FEMUR DISTAL CUT

STARTER DRILL: Design justification



1
 Conical transition from 7 to 9 mm to fix diaphysially the intramedullary rod .

2
 Constant Ø 9 mm diameter zone to guide the intramedullary rod.

3
 Transition from 9 to 11 mm to make a distal opening which facilitates cleaning of the canal and prevent thrombus.

1 Initial drilling

Perforate the entry location on the cortical with the starter awl and/or starter drill to prepare the intramedullary canal for insertion of the intramedullary rod. The whole depth of the drill bit should be used, as the last part opens the canal a little more, to facilitate intramedullary cleaning and prevent thrombus.

Tip *Tibia can also be drilled* to speed up surgery time.

2 Insert the alignment rod no further than the maximum limit mark

Use the T-handle for quick coupling, insert the alignment rod no further than the black mark engraved on the rod. This mark indicates the minimum space of the intramedullary rod needed to insert the varus-valgus alignment guide.

3 Remove the T-handle via its quick coupling.

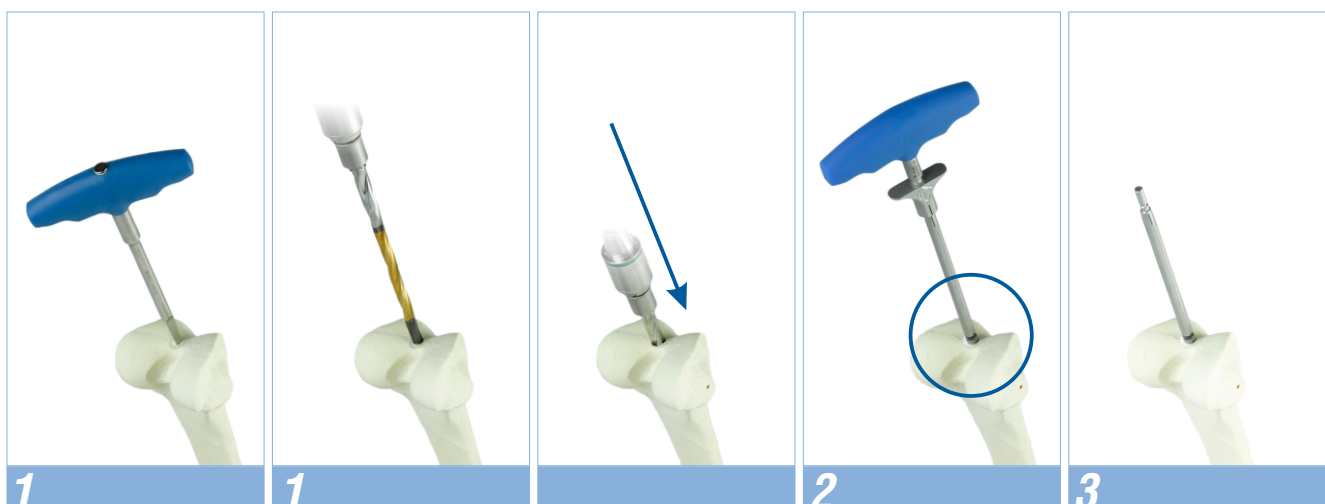

A F.1. FEMUR DISTAL CUT

Insert the varus-valgus alignment guide through the alignment rod until contacting the distal part of the femur. The cutting block will slide over the femur easily and position itself on its anterior part. Check all the settings previously selected before fixing the cutting block with headless pins and the oblique pin.

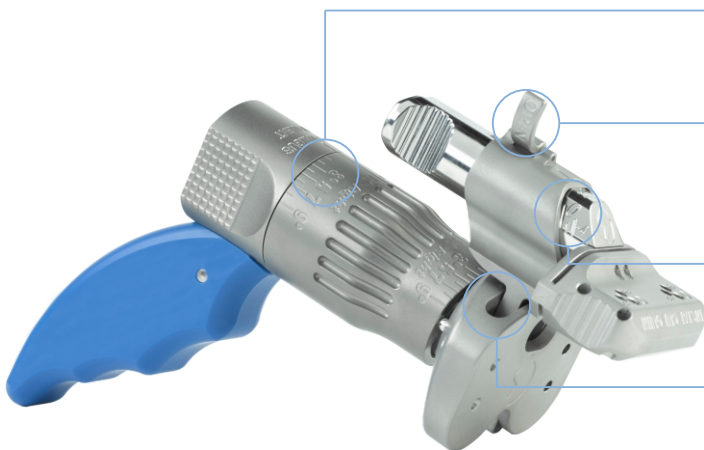

CHECK THE VARUS-VALGUS ALIGNMENT

Choose "RIGHT" or "LEFT" side for the leg you are operating and select between 0° and 9°

LOCK LEVER "CLOSED"

Raise the lever to the CLOSED position to block the desired selection on the cutting block support.

CUTTING BLOCK SUPPORT IN POSITION "0"

At the "0" mark, the distal cut is 8 mm, depth of our implant. Adjustable from 4 mm to 16 mm.

CORRECTLY POSITIONED

Cutting block properly inserted
 Cutting block support properly housed in slot.
 Varus-valgus alignment guide contacting distally.
 Distal cutting block rested on femur.

- 1** *Insert the alignment guide* through the alignment rod until contacting with the femur distally.
- 2** *Fix the distal cutting block with headless pins* in the cutting block holes identified with "0" and an *oblique pin* in one of the holes for oblique pins to ensure the position.
- 3** *Remove the alignment guide*, by holding the alignment rod T-handle with one hand and the alignment guide handle with the other hand. Remove first the alignment rod. Then the varus-valgus alignment guide which is coupled magnetically to the cutting block.
- 4** *Assess the level of resection* with the resection checker.
- 5** *Perform the distal cut* with a 1.27 mm saw. Use the tibial protection plate.



A * **SPACERS IN EXTENSION**



Use the spacers provided to check if there is enough space for our implants with the knee in extension.

In case that the smallest of our spacers can not be introduced, the knee will not have enough space to house our prosthesis and a recut must be done, normally in the tibia.

Note that at this point of the surgery it is easier to make a recut, as all the pins are still inserted in tibia and femur.

The proper alignment of the cuts can also be evaluated by inserting the extra alignment bar provided through one of holes in the spacer.

TIBIA RECUT

To make the tibia recut remove the cutting block from its position through the “0” holes, and position it through the “+2” holes for a 2 mm recut or the “+4” holes for a 4 mm recut.

PINS IN “+2” POSITION (RECUT)



RESECTION LEVEL “+2”

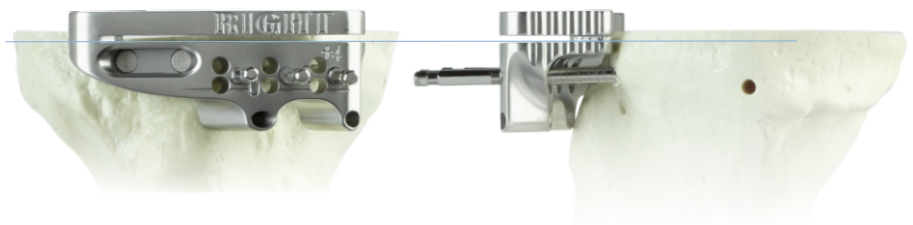

There is also a second option with the cutting block through the “+4” holes.

DISTAL FEMUR RECUT

To make the femur recut remove the cutting block from its position through the “0” holes, and place it through the “+2” holes for a 2 mm recut or through the “+4” holes for a 4 mm recut.

It is important to remember that the femur recuts modify the position of the interline.



B **F.2. MEASURING FEMORAL SIZE**

FEMORAL GAUGE: Design justification

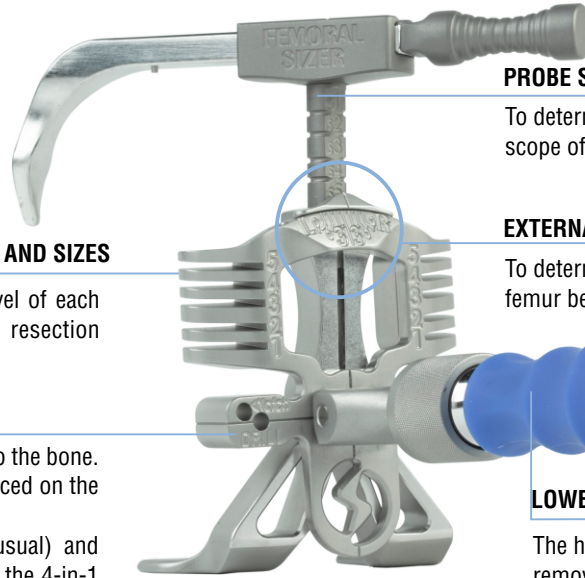

PROBE STYLUS TO SELECT THE SIZE

To determine the implant size and the scope of the anterior resection the implant requires.

EXTERNAL ROTATION

To determine the external rotation of the femur between 0° and 9°, and usually 3°

LOWERABLE AND REMOVABLE HANDLE

The handle is lowered to fix the position and can be removed via the easy extraction mechanism, to give more space for the surgery.

SLOTS TO CHECK ANTERIOR CUT AND SIZES

Evaluate the anterior resection level of each size using these slots with the resection checker.

“DRILL” AND “NOTCH” HOLES

Used to transfer external rotation to the bone. The 4-in-1 cutting block will be placed on the drilled holes.

2 positions available: “DRILL” (usual) and “NOTCH” (would allow to position the 4-in-1 cutting block higher and raise the cuts of each size to avoid notching).

1 *Select the desired external rotation angle on the gauge and secure the position lowering the handle.* With the knee at 90°, position the femoral gauge in contact with the distal cut and both posterior condyles of the femur.

RIGHT | LEFT side depending of the leg to operate and a range from 0° to 9° to perform the external rotation.

Once the external rotation position is fixed, handle can be removed to have more working space.

**Hypo-
plastic
condyle**

In the event of a hypoplastic posterior condyle unable to properly support the gauge, there is a slot to insert the resection checker and align it with the Whiteside's line. If both posterior condyles are damaged, align it with the transepicondylar axis.

The holes are made in the next step.

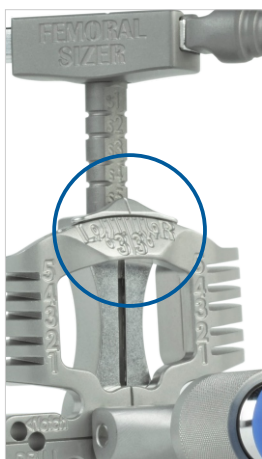

1

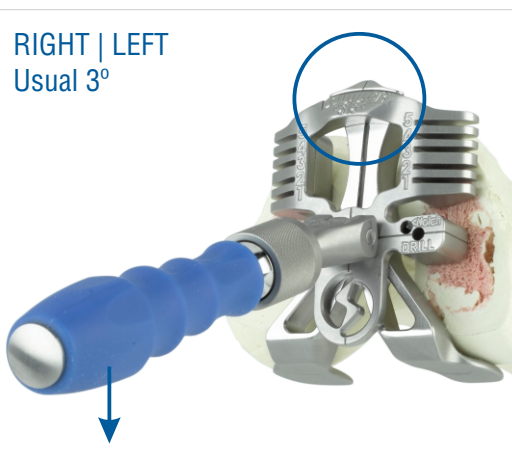

1



Special case for hypoplastic condyle

B F.2. MEASURING FEMORAL SIZE

2 Drill the bone using the holes marked as “DRILL” with the Ø 3.4 mm drill bit included in the instruments. Alternatively, insert two pins through these holes to keep the position of the gauge fixed and facilitate the next step: size selection.

PROBE STYLUS: Design justification

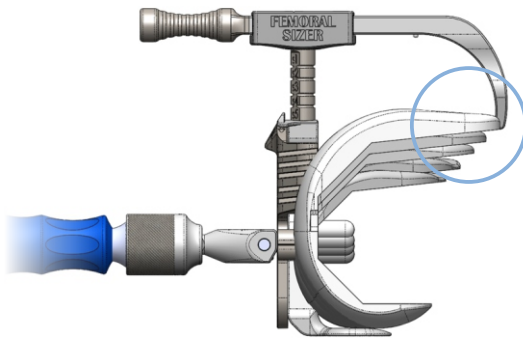

PROBE STYLUS

When setting the same size in the vertical axis and in the horizontal axis of the probe stylus, the tip of the stylus indicates exactly where the antero-external flap of the prosthesis will reach and exactly where the anterior cut will end.

3 Femoral implant size selection

3.1. PLACE THE PROBE IN ITS HOUSING

Place the probe in its housing with the horizontal indicator selecting an intermediate size (3) and the tip resting slightly externalised.

3.2. CHECK VERTICAL AXIS READING

In that position, read the size on the vertical axis, which now has to be transferred to the horizontal axis as a possible size for the femoral component.

3.3. SELECT THE SAME SIZE ON THE HORIZONTAL AXIS

Select on the horizontal axis the size reading of the vertical axis. Now the **two values are the same**, the pointer indicates exactly where the **antero-external flap** of the prosthesis will reach and exactly where the **anterior cut** will end for that size.

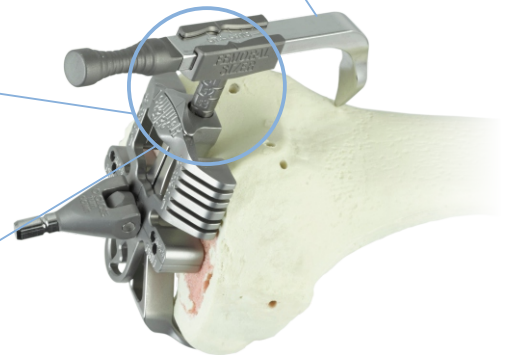

4 Check the level of the anterior cut for the selected size

The resection checker inserted in the selected size slot gives a second reference of the height of the anterior cut. This second assessment is recommended to be done to avoid an anterior cut made too low that could produce femoral notching.

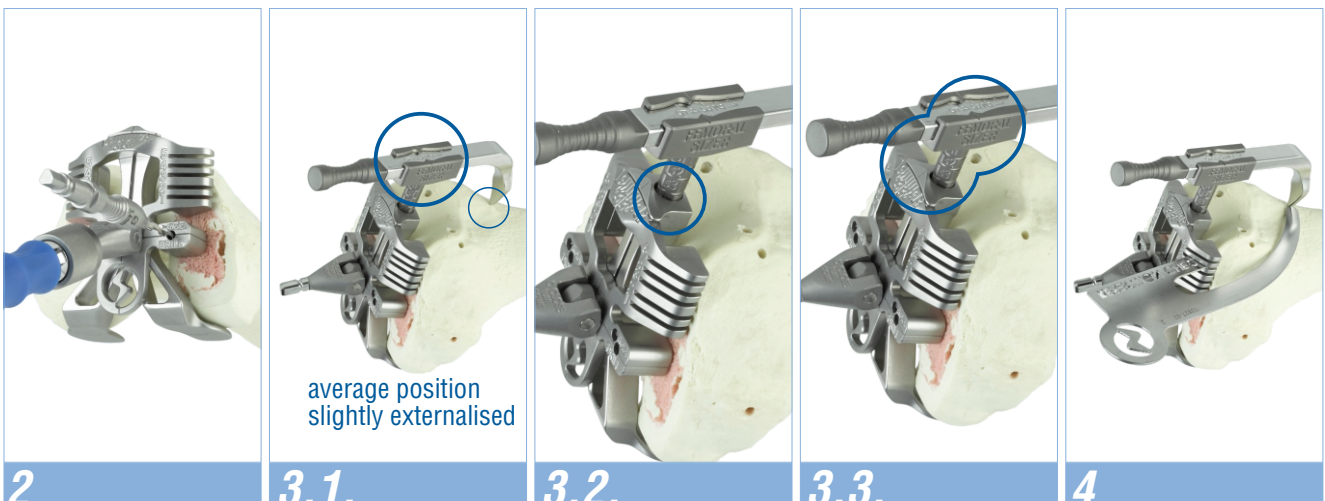

2

3.1.

3.2.

3.3.

4

average position
slightly externalised

B F.3. ANTERIOR AND POSTERIOR CUTS AND BEVELS

4-IN-1 CUTTING BLOCK: Design justification

5 CUTTING BLOCKS FROM SIZES 1 TO 5

The cutting block width is identical to the one of the femoral component of the same size. The height of the cutting block is also corresponding to the component height.

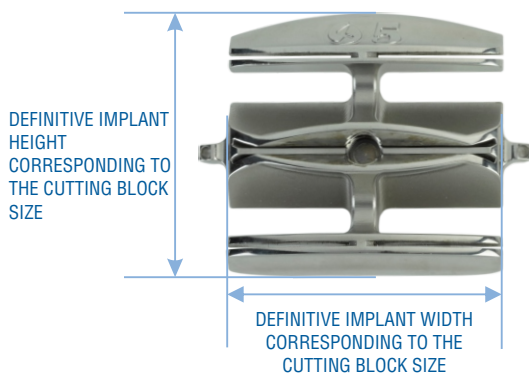

4 CUTS IN A SINGLE CUTTING BLOCK

The cutting block allows the anterior and posterior cuts and the two bevels to be done simply and accurately.



- 1** **Impact the selected size of 4-in-1 cutting block with the impactor/extractor handle**
 The block is inserted into the two holes made previously with the femoral gauge.
- 2** **Check the cut resection levels with the resection checker**
- 3** **Fix the 4-in-1 cutting block with Ø 3.4 mm pins**
- 4** **Perform the anterior, posterior and bevel cuts**
- 5** **Remove the pins and disimpact the 4-in-1 cutting block with the impactor/extractor handle.**

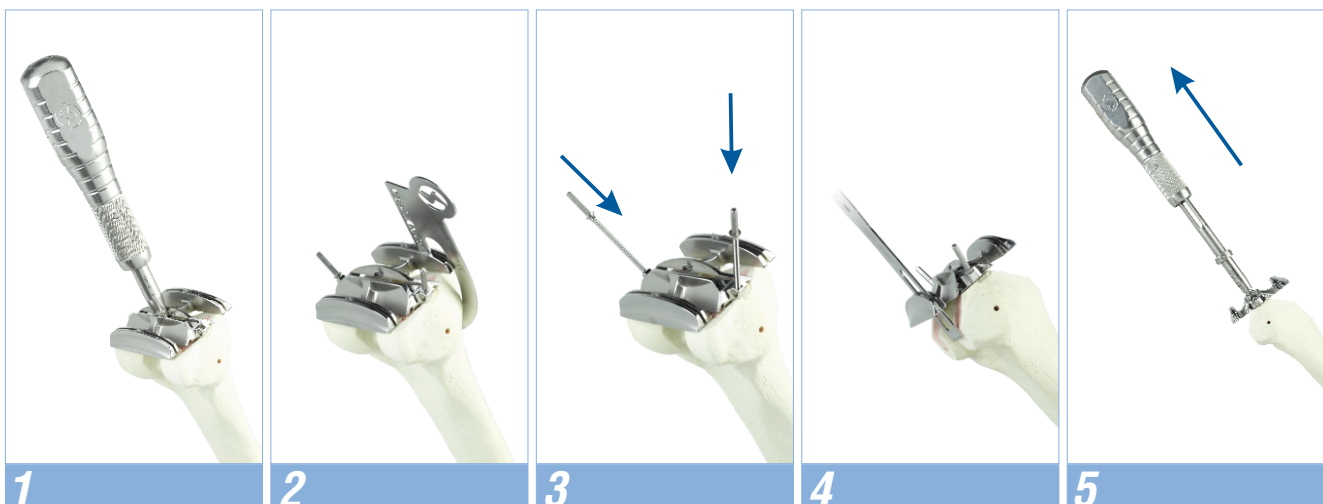

B * SPACERS IN FLEXION AND EXTENSION

Insert the spacers in flexion and extension. With the tibial cut and the femoral cuts performed, a spacer is selected and inserted in flexion and extension to assess the alignment of the limb and the ligament tension in the knee. This spacer height is equivalent to the total height of the prosthesis with an insert of the size marked in the spacer.



PERFORMING THE FEMUR AND TIBIA RECUTS

If the spacers do not fit in flexion or extension, or there is excessive ligament tension in one of the positions, it is advisable to perform a recut, either in the tibia or the femur; there being three possibilities, which are explained in more detail on page 18:

EXTENSION NO / FLEXION NO

TIBIA RECUT

see page 18

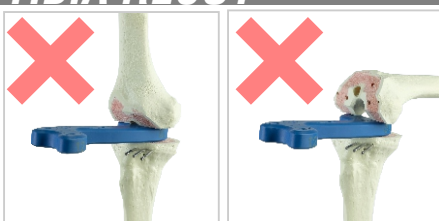

To give more space in flexion and extension, the recut needed will be done on the tibia.

Or DISTAL FEMUR RECUT + POSTERIOR FEMUR RECUT

To give more space in flexion and extension without cutting the tibia, two recuts should be done. A DISTAL FEMUR RECUT followed by a POSTERIOR FEMUR RECUT. (As explained below)

EXTENSION NO / FLEXION YES

DISTAL FEMUR RECUT

see page 18



To give more space only in extension, a distal femur recut is recommended.

After the distal femur recut, the rest of the 4 cuts must be repeated (anterior, posterior and 2 bevels), with the 4-in-one cutting block of the same size.

EXTENSION YES / FLEXION NO

POSTERIOR FEMUR RECUT

see page 18

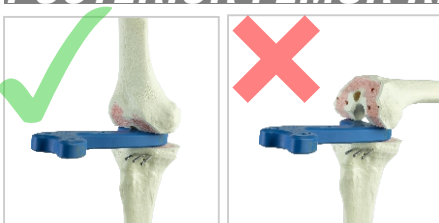

To give more space only in flexion, a posterior femur recut is recommended.

Insert the **posterior recut block +4 mm** into the holes drilled beforehand with the femoral gauge. Drill the new holes of the recut block, and insert the 4-in-1 cutting block of **one size smaller than the one used previously**.

B * RECUTS

TIBIA RECUT

Insert the **tibial cutting block** through the parallel pins marked as “+2” holes for a recut of 2 mm or through the “+4” holes for a recut of 4 mm. Fix the **tibial cutting block** position with an oblique pin and make the new cut.

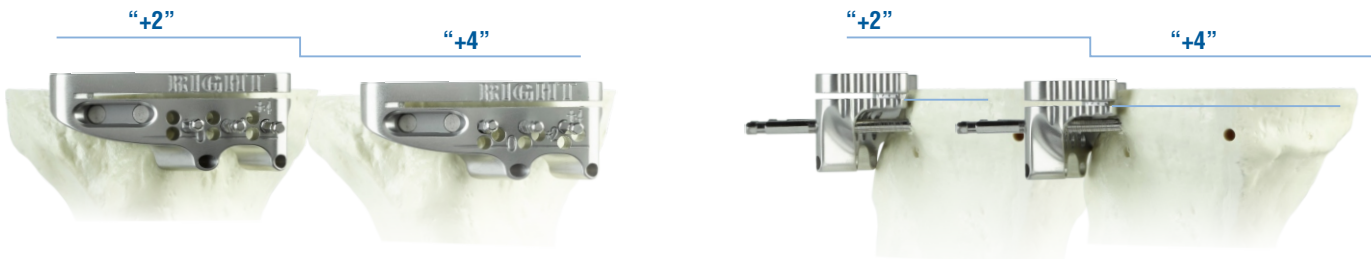

DISTAL FEMUR RECUT

Rest the **distal recut block** on the anterior and distal femur cuts and fix with pins. Make a new distal recut through one of its cutting slots (+2, +4, +8 or +12). Impact the **4-in-1 cutting block of the same size** previously used and fix with pins to make again the 4 cuts (anterior, posterior and bevels)

Note that the distal femur recut will change the interline position. The recut should not be greater than 4 mm.



POSTERIOR FEMUR RECUT

Use the **posterior recut block +4 mm** inserted into the holes already made with the femoral gauge. Once positioned, drill the new holes of the block. **Insert the 4-in-1 cutting block of one size smaller** than the one used previously. Make the anterior, posterior and bevel cuts.



B F.4. TRIAL FEMORAL COMPONENT

NPS (Non Postero Stabilized) or PS (Postero Stabilized)

Impactor / Extractor of femoral components: Design justification

PREPARING IMPACTOR / EXTRACTOR FOR FEMORAL COMPONENTS

Opened position with the fixing tabs separated and the handle unscrewed. Capture the component with the tabs, then manually close them over the femoral component notches.

ADJUST WITH IMPACTOR

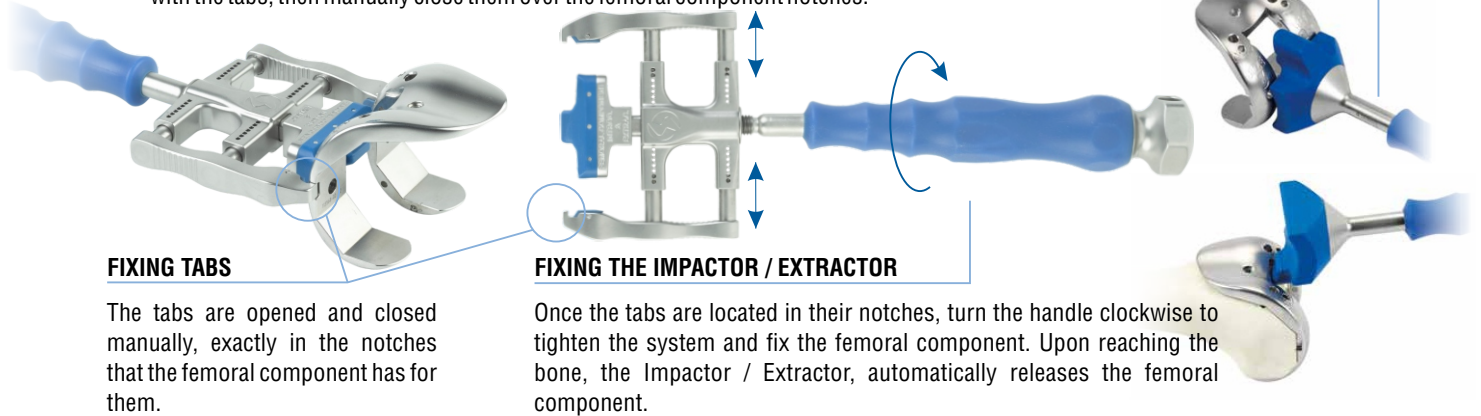

FIXING TABS

The tabs are opened and closed manually, exactly in the notches that the femoral component has for them.

FIXING THE IMPACTOR / EXTRACTOR

Once the tabs are located in their notches, turn the handle clockwise to tighten the system and fix the femoral component. Upon reaching the bone, the Impactor / Extractor, automatically releases the femoral component.

1 *Insert the femoral component* with the femoral component impactor / extractor and impact in its position. **This instrument helps to prevent the femoral component from being inserted in flexion.** The impactor / extractor automatically releases the femoral component when it reaches the bone. If adjustments need to be done, use the femoral component impactor which offers many possibilities for impaction.

2A *To implant a NPS femoral component, make two holes with the Ø 6 mm NPS drill* on the femoral resection plane to accommodate the definitive NPS implant pivots to complete this part

2B *To implant a PS femoral component, position the intercondylar cutting guide in its housing* and secure it with the manual thread. It can be tightened with the screwdriver and the femoral component fixed with pins, if necessary, before making the cuts.

3 Using a narrow saw, *make the cuts to accommodate the intercondylar box.* Use the chisel available in the instruments to perform specific final adjustments. Protect the posterior areas with the tibial protection plate.

4 *Insert the intercondylar box (same size of the femoral component),* sliding and clicking it properly in place. The PS trial femoral component is finished.

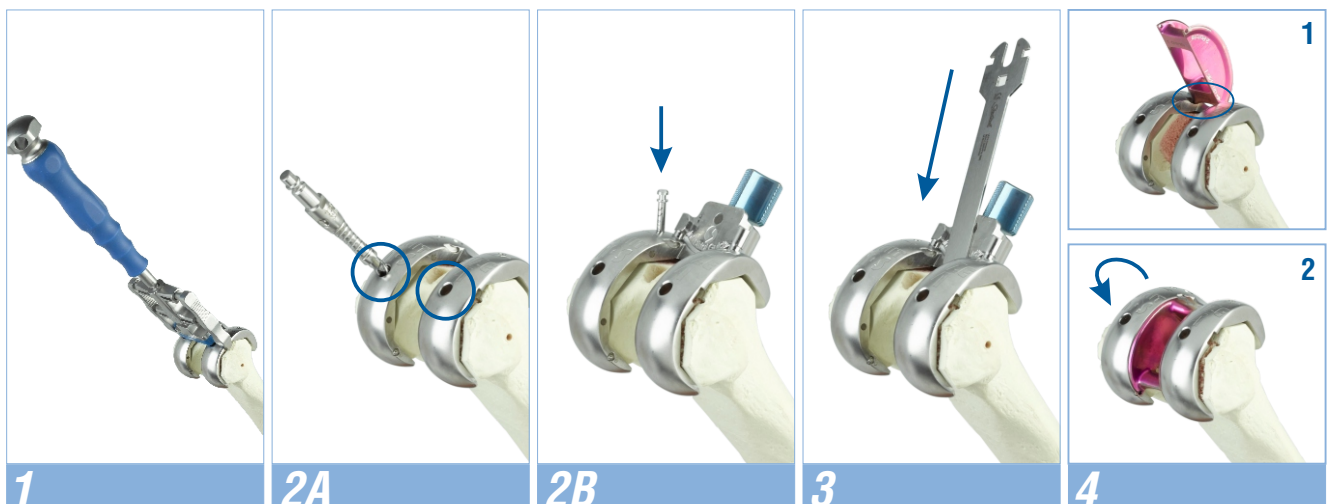

C T.2. MEASURE AND POSITION TIBIAL TRAY

TRIAL TIBIAL TRAY AND TIBIAL TRAY HANDLE: Design justification

TRIAL TIBIAL TRAY

Contains holes for fixing with motorised pins or pins with nailed heads which also allow positioning the tibial insert without removing them. Engraved marks make it easy to reference their positioning.

TIBIAL TRAY HANDLE

Two positions OPEN / CLOSED that allow the tibial tray to be captured and locked to the handle to make the tibial size assessment.

NAILED PINS WITH HEAD

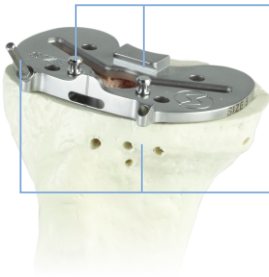

Fix the tibial tray and allow placing the tibial insert. They allow for flexion/extension testing without the patella being everted.

THREADED PINS WITH HEAD

These fix the trial tibial tray in the desired position.



1 Insert the handle in the trial tibial tray and secure it in position **CLOSED**. Place it on the resected tibia to check if it is well supported (it does not protrude and allows proper articulation). There are 5 sizes of trial tibial tray.

2 Attach a tibial insert **OF THE SAME SIZE OF THE TRIAL FEMORAL COMPONENT** and the adequate thickness to the trial tibial tray, either manually or with the impactor.

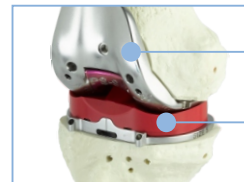

SAME SIZE FEMORAL COMPONENT AND TIBIAL INSERT

3 Place the trial tibial tray and tibial insert in position and assess the joint movement with the trial femoral component to confirm the proper and final position. Mark the position with the scalpel using any of the references marked in the trial tibial tray.

4 Fix the final position with pins and remove the trial tibial insert with the inserts extractor by making a rotational movement (not levering it out).

5 Other pins holes are available to fix the trial tibial tray.

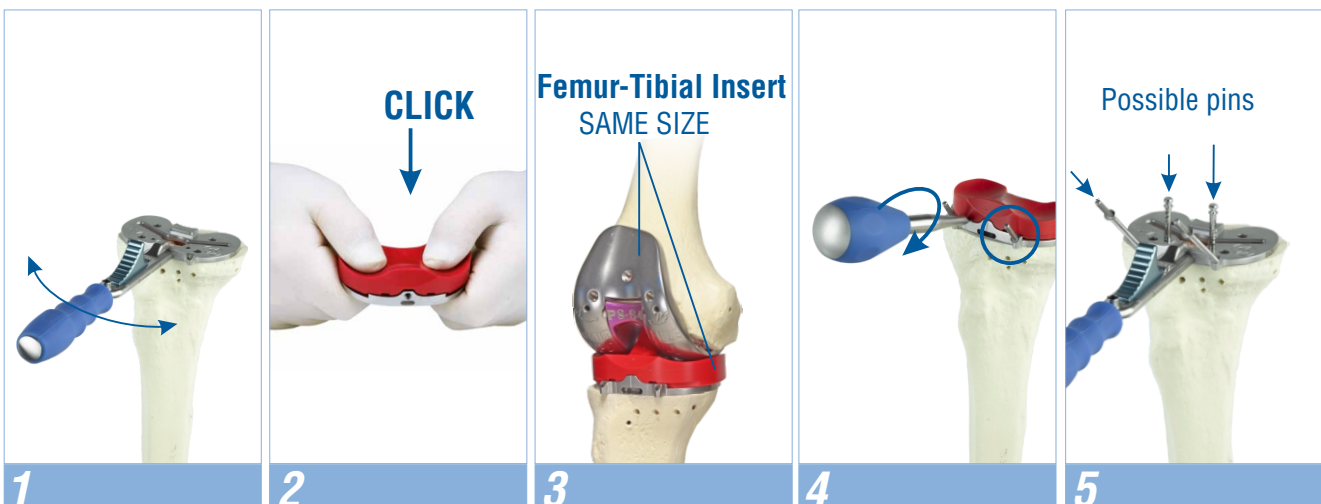

C T.3. CARVE SPACE FOR THE TIBIAL KEEL

TIBIAL KEEL: Design justification

MINIMALLY INVASIVE FLAPS

Anthropometric “W” design in convergent planes, whose implantation by impaction ensures the integrity of the surrounding bone structure.

STANDARD OR LONG CAP (15 mm or 25 mm)

The keel chisel can carve the two lengths of tibial cap: the standard 15 mm or the long 25 mm. For the long plug carving, use the pin impactor on the central cylinder of the keel chisel.



Tip If sclerotic bone is found, start with the saw to mark the entry and the tibial drill to facilitate the later impaction of the keel.



1 Thread the impactor / extractor handle to the tibial keel of the same size of the trial tibial tray. **Impact the tibial keel until is flush with the trial tibial tray.**

1b To carve the long tibial tray cap, **impact with the pin impactor bar through the tibial keel orifice.**

2 Remove the fixing pins

3 Place the tibial insert (same size than the trial femoral component), starting with the posterior part and then the anterior part until it clicks into position, either manually or with the multi-purpose impactor.





FLEXO-EXTENSION TESTS WITH TRIAL COMPONENTS

With the trial components set in place, perform the joint flexion and extension movements to verify proper mobility and stability of the knee.

If satisfactory, prepare the definitive implants to finish the knee replacement.

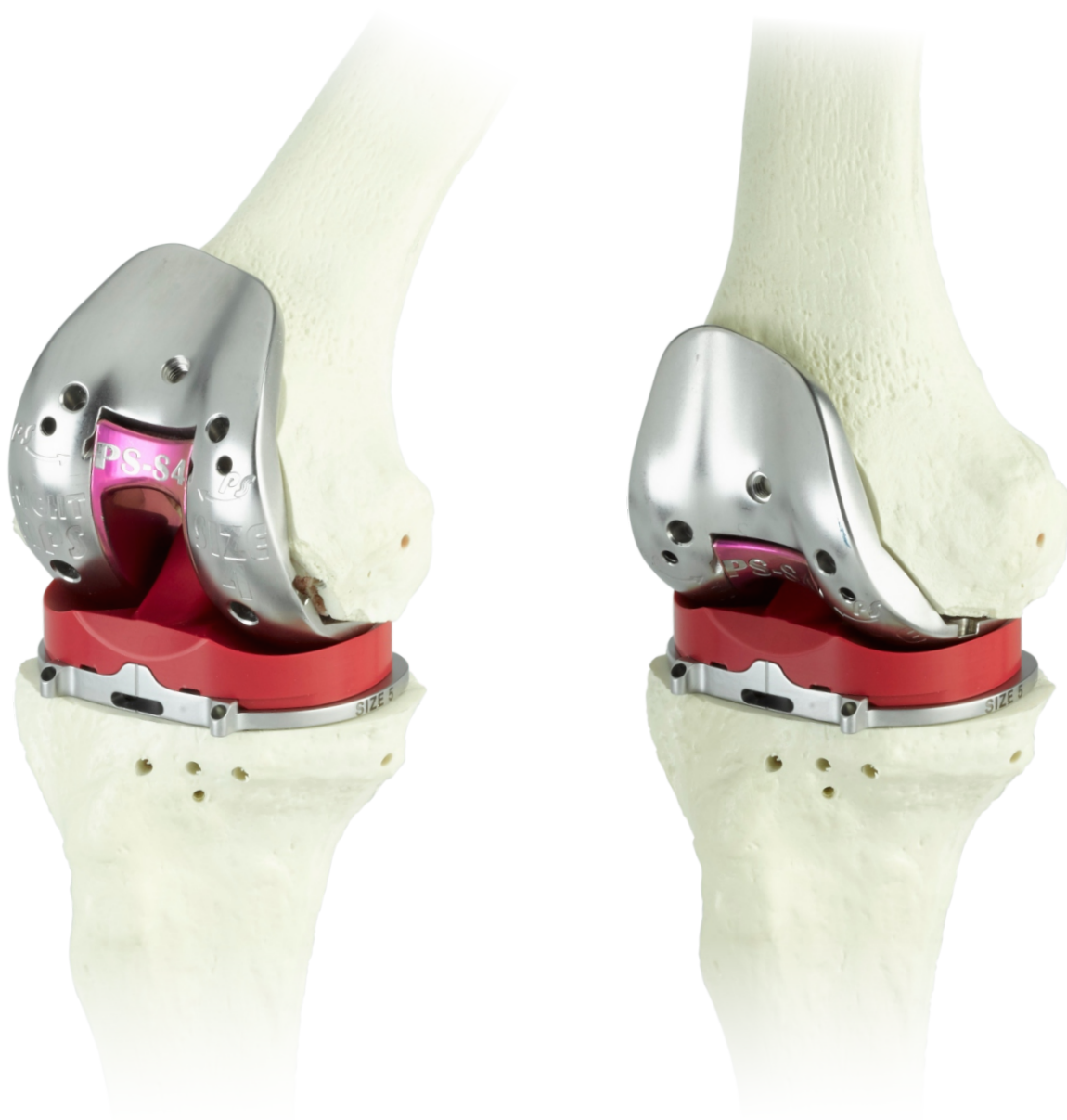

D **P.1. PATELLAR TIME**

PATELLAR RESECTION FORCEPS: Design justification

PATELLAR DIAMETER AND THICKNESS

To recall all available patellar implants and their measures.

RESECTION LEVEL INDICATOR



The manual thread is used to adjust the level of resection, marked in the turret.

MANUAL TIGHTENING

To ensure the patella firmly fixed with the forceps.

PATELLA CUTTING AND HOLDING JAWS

Numerous small and sharp teeth ensure the position of the patella during resection.

PATELLA SUPPORT AREA

Area to place the patella before closing the forceps.

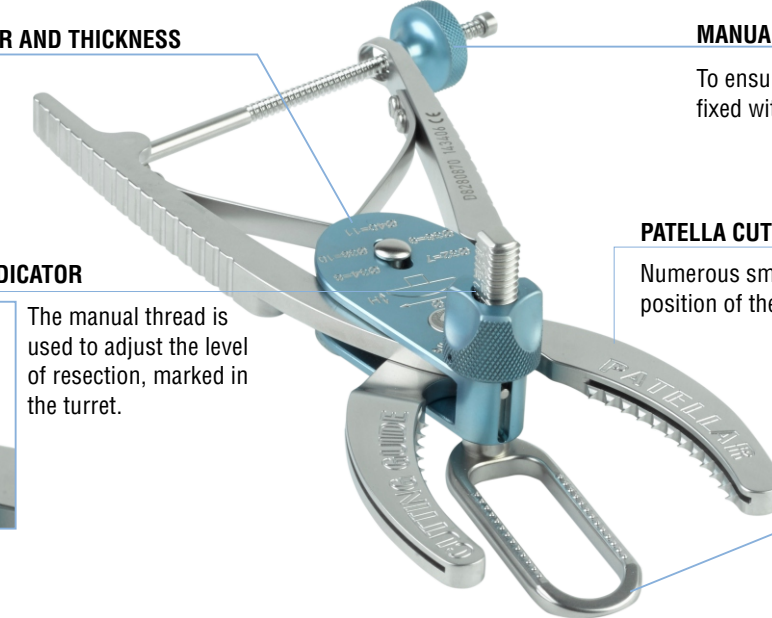

ERGONOMIC PUSHBUTTON

For opening the patella height gauge.

PATELLAR HEIGHT GAUGE: Design justification

GRADUATION AND MEASUREMENT IN MILLIMETRES

Allows to measure the thickness of the patella.

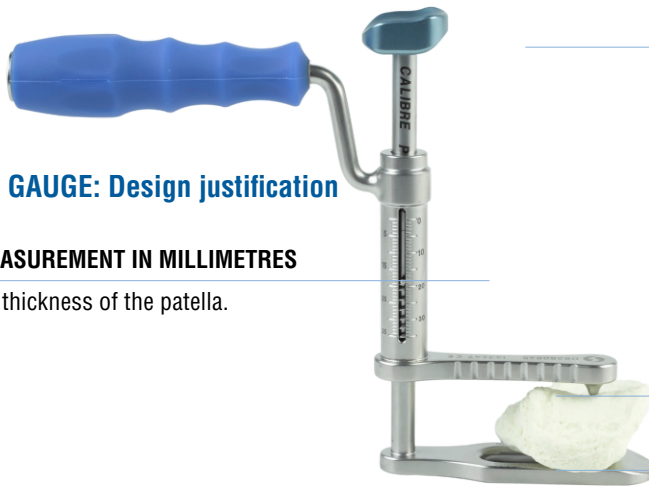

MEASUREMENT TIP

MEASUREMENT SUPPORT AREA

PATELLA THICKNESS MM

HANDLE

Ergonomic handle made of silicone to facilitate its positioning.

PATELLAR PERIMETERS

Visualisation of the patella perimeters to help in centering the implant over the resection.

CLOVERLEAF SHAPE

Allows us to see part of the resected bone to position correctly the patella.

PATELLAR DRILL GUIDE AND PATELLAR DRILL BIT: Design justification

PATELLAR DRILL BIT

Sharp with a limit for the exact drill depth required.

PATELLAR DRILL GUIDE

With spikes to help secure it on the resected plane of the patella.

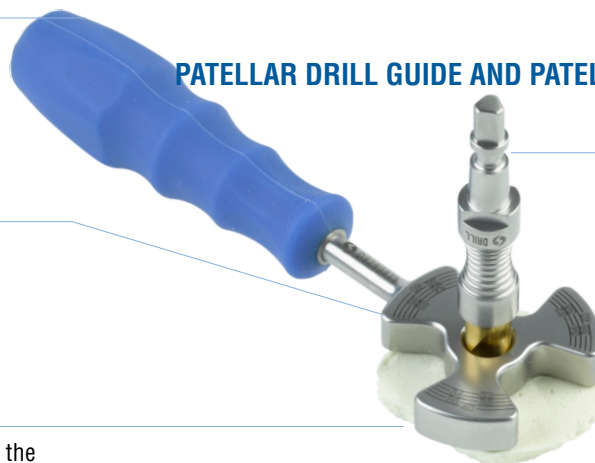

D P.1. PATELLAR TIME



Patella implant height

Choose the appropriate patella size implant to maintain the height of the original patella. 5 heights between 7 mm and 11 mm are available.

Maintain as much bone stock as possible (at least 12-14 mm)

A minimum of 12-14 mm is recommended to reduce the risk of fracture

PATELLA IMPLANTS: Diameters and heights

Diameter	32 mm	34 mm	36 mm	38 mm	40 mm
Height	7 mm	8 mm	9 mm	10 mm	11 mm

Sizes engraved to recall all available patella thickness and their diameters.

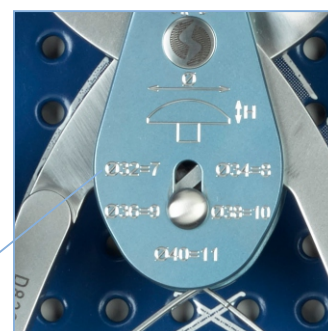

- 1 Measure the height of the patella** with the patellar height gauge included in the instruments. Leave a minimum bone height to reduce the risk of a fracture (12-14 mm).
- 2 Adjust the cutting height** in the resection level indicator of the patellar resection forceps, indicating the height in mm of patella to be maintained from the original patella. A minimum of 12-14 mm is recommended.
- 3 Resection of the patella:** Rest the patella on the patella support area and close the resection forceps jaws on the patella to maintain its position. Tighten manually and perform the resection with a 1.27 mm saw through the cutting slots.
- 4 Drilling the patella.** Centre and position the patellar drill guide by pressing on the resected plane of the patella and drill through its drill guided hole with the patellar drill bit.
- 5 Insert the trial patella**



E DEFINITIVE COMPONENTS

GENUTECH[®] NPS



GENUTECH[®] PS



- 1** **Impact the femoral component into its correct position** using the impactor/extractor for femoral components and with the final femoral implant properly attached. **This instrument helps to prevent the femoral component from being inserted in flexion.** Make final adjustments to the position with the final femoral impactor, if necessary.
- 2** **Fix the cap (standard or long) to the tibial tray selected** with the 4.5 mm screwdriver.
- 3** **Position the tibial tray and impact it correctly on the carved tibia.** The tibial tray holder handle in CLOSED position keeps the tibial implant fixed to it and facilitates impact. Use the multi-purpose impactor for any final adjustments.
- 4** **Position the definitive tibial insert** either manually or with the help of the multi-purpose impactor. Insert the fixing bolt using the fixation bolt handle and finish by tightening it with the 2.5 mm screwdriver.
- 5** **Position the definitive patella implant** cemented in its hole and leave it tightened by the patellar clamp until the cement hardens.

Perform the definitive flexo-extension tests and finish the surgery.



C

COMPLEX TIBIAL CASES

Tibial Stems

When tibial stems or tibial augments are required to ensure stability and support of the tibial tray, the optional TIBIAL COMPLEX PRIMARY SET is available.

STEMS AND TIBIAL AUGMENTS: Design justification

Right / Left 8 mm tibial augments

Resect to allow the tibial tray to be supported by 8 mm augments and ensure the support on the bone.

Straight tibial stems

Available in Ø10, Ø12 or Ø14 mm and 70 mm length (90 mm from the tibial tray resection level).

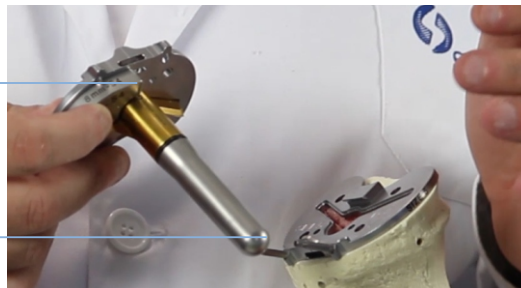

- 1** *Position the reamer guide on the trial tibial tray.* The reamer guide sits on top of the trial tibial tray and stays in position magnetically to guide the reamer aligned with the tibial tray.
- 2** *Use the reamer for the desired stem diameter.* (Ø10, Ø12 or Ø14 mm)
- 3** *Retire the cap of the tibial keel and screw the trial stem to it. Thread the impactor handle to the tibial keel.*
- 4** *Using the hammer, impact the tibial keel with the trial stem until the keel is flushed with the trial tibial tray.*
- 5** *Place the trial tibial insert* (same size than the trial femoral component), starting with the posterior part and then the anterior part until it clicks into position, either manually or with the multi-purpose impactor.



1



2



3



4



5

C

COMPLEX TIBIAL CASES

Tibial augments

TIBIAL AUGMENTS: Design justification

Pin holes

Multiple fixation possibilities for the trial tibial tray. The indicated holes allow the trial tibial insert even with the pins inserted in the tray.

Cutting depth guide "RIGHT" | "LEFT"

8 mm cut to allow the tibial tray to be supported by 8 mm augments.

Fixation of the cutting guide

Oblique pin to fix the correct position of the cutting guide.

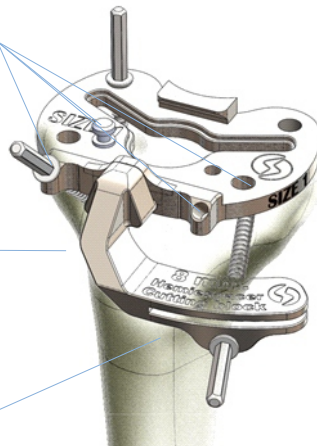

8 mm resection

Resect to allow the tibial tray to be supported by 8 mm augments and ensure the support on the bone.

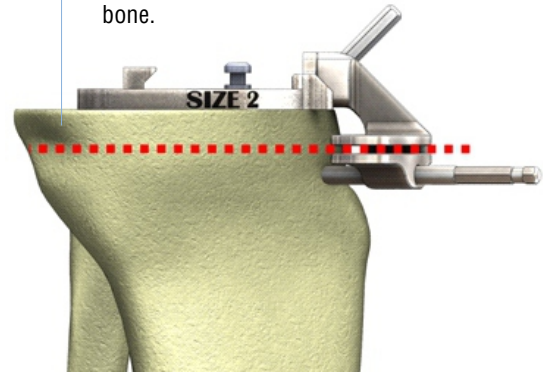

- 1 **Retire the tibial keel and trial stem from the previous step and fix the trial tibial tray with pins** to guarantee fixation and stability for the trial tibial tray and cutting depth guide for the next cutting step of the surgical technique.
- 2 **Introduce the cutting depth guide "RIGHT" | "LEFT" in position and fix it with the oblique pin**
- 3 **Make the cut in the tibia through the cutting slot of the cutting depth guide**
- 4 **Remove the cutting depth guide and the trial tibial tray to use the "RIGHT" or "LEFT" middle cutting reference plane**
 REMOVE THE CUTTING DEPTH GUIDE: Remove the oblique pin and separate the guide from the trial tibial tray.
 REMOVE THE TRIAL TIBIAL TRAY: Remove the pins that keep in position the trial tibial tray and remove it.
 MIDDLE CUTTING REFERENCE PLANE RESECTION: Position the guide in the tibial keel hole to make the coronal plane resection.
- 5 **Place the trial tibial tray with the attached augment and the trial tibial insert.** Place the magnetic trial augment in the trial tibial tray. Impact the tibial keel with the attached trial stem to fix the tibial tray in its position and with the trial tibial insert perform the joint flexion and extension assessment.

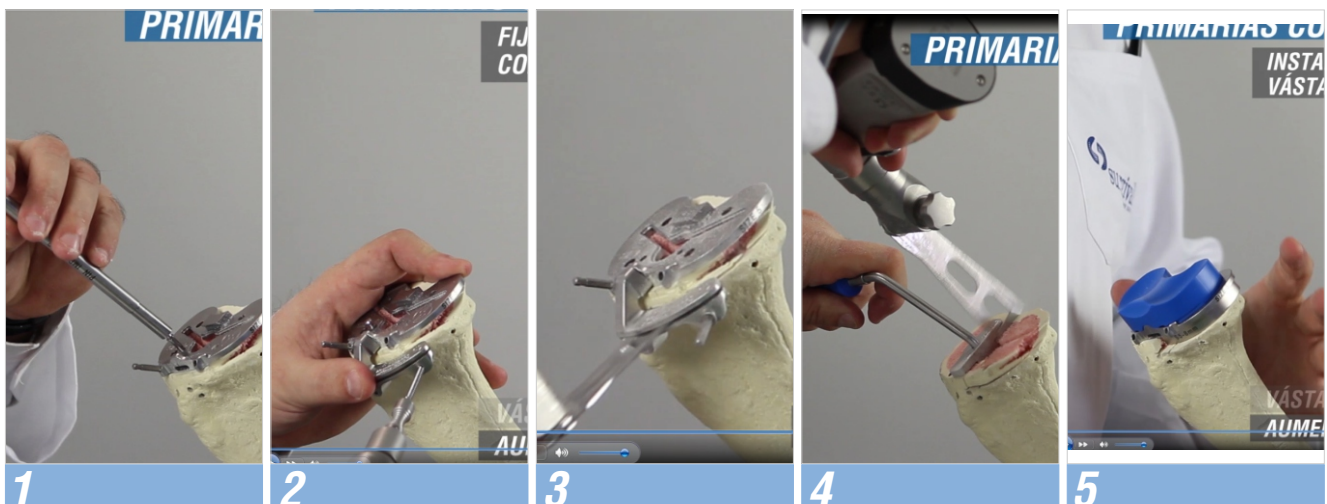

A F.1. Annex. FEMUR DISTAL CUT

VARUS-VALGUS ALIGNMENT GUIDE: Functionality

The flexibility of the barrel in the varus-valgus alignment guide and the angular range from 0° to 9°, allows the surgeon to make accurate adjustments to the desired varus-valgus angle.

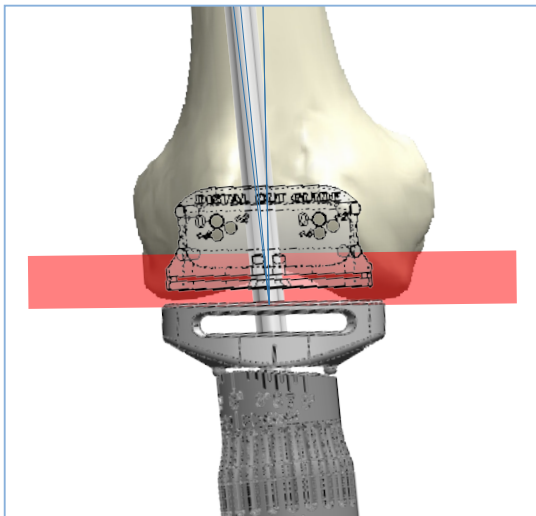

PARALLEL RESECTION

May be decided to **resect at same depth both condyles**, rotate the barrel of the varus-valgus alignment guide until making contact with both condyles. This resection will be parallel to that contact and will make an 8 mm cut in both condyles equivalent to the 8 mm of our femoral component.

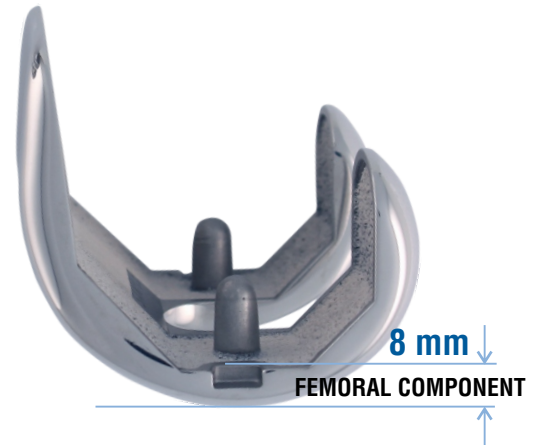

LITTLE ADJUSTMENTS OF THE VARUS-VALGUS ANGLE.

RIGHT KNEE
LATERAL TO MEDIAL

To slightly correct the knee from lateral to medial, adjust the angle to **resect more on the lateral condyle**.

In the varus-valgus alignment guide barrel, **increase degrees** to the (X) angle established by the surgeon in preoperative measurements to **resect more on the lateral condyle**.

RIGHT KNEE
MEDIAL TO LATERAL

To slightly correct the knee from medial to lateral, adjust the angle to **resect more on the medial condyle**.

In the varus-valgus alignment guide barrel, **decrease degrees** to the (X) angle established by the surgeon in preoperative measurements to **resect more on the medial condyle**.

PRODUCT REFERENCES



INNOVATING WITH **PASSION**

D8610000	Genutech® DCF primary knee instrumental complete set	
1	D8602100	Femoral instrumental set 1 DCF
2	D8602200	Femoral instrumental set 2 DCF
3	D8603100	Tibial instrumental set
4	D8402100	NPS instrumental set
5	D8405100	PS instrumental set
6	D8603200	Patellar instrumental set

1 **D8602100** Femoral instrumental set 1 DCF

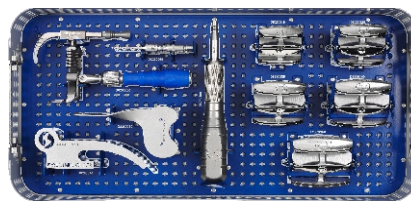
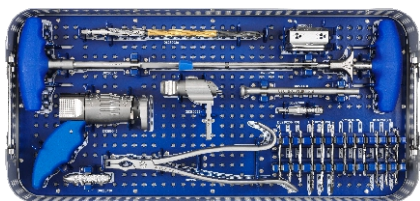

2 **D8602200** Femoral instrumental set 2 DCF

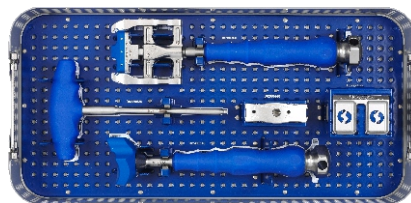
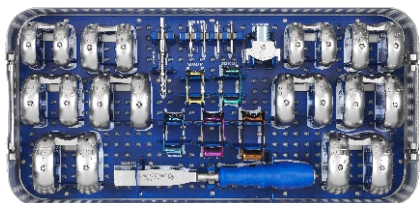

3 **D8603100** Tibial instrumental set

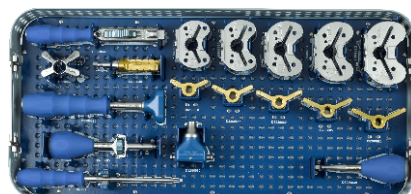
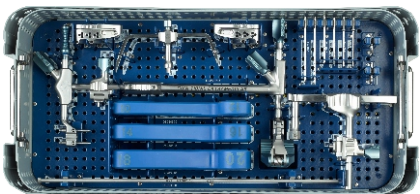

4 **D8402100** NPS instrumental set

5 **D8405100** PS instrumental set

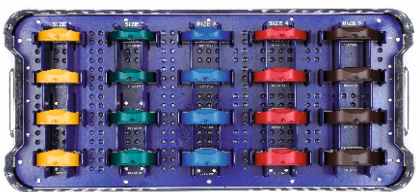

6 **D8603200** Patellar instrumental set

D8603300 Complex primary set *****

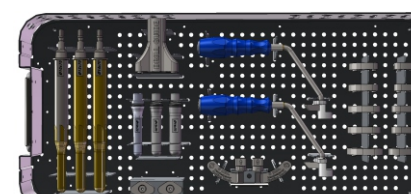

* OPTIONAL. Available under request. Not compatible with previous GENUTECH instrumental.

D8602100

Femoral instrumental set 1 DCF

Femoral instrumental set 1 DCF upper tray

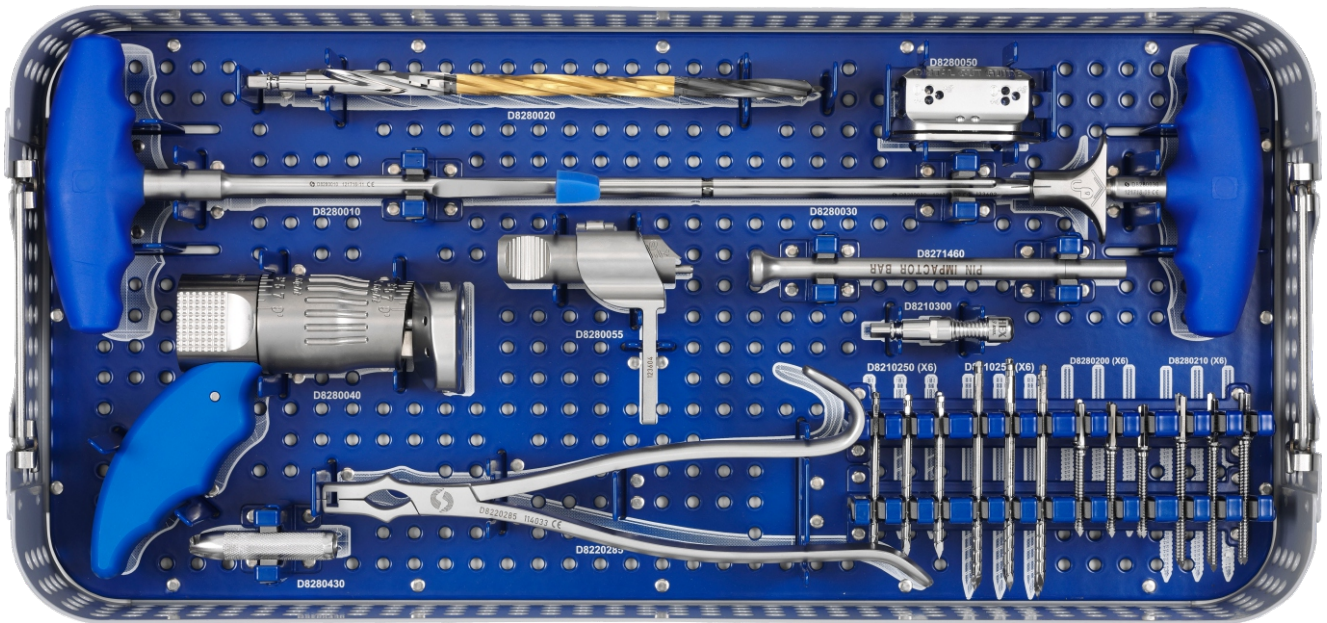

Femoral instrumental set 1 DCF lower tray

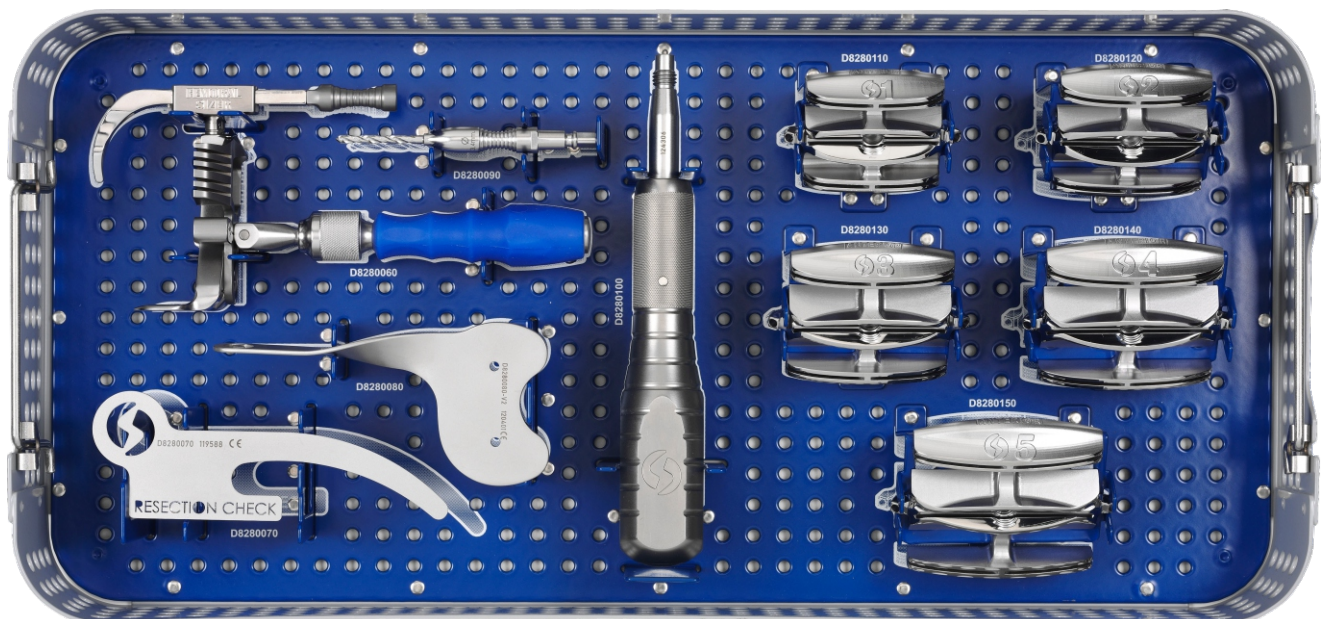

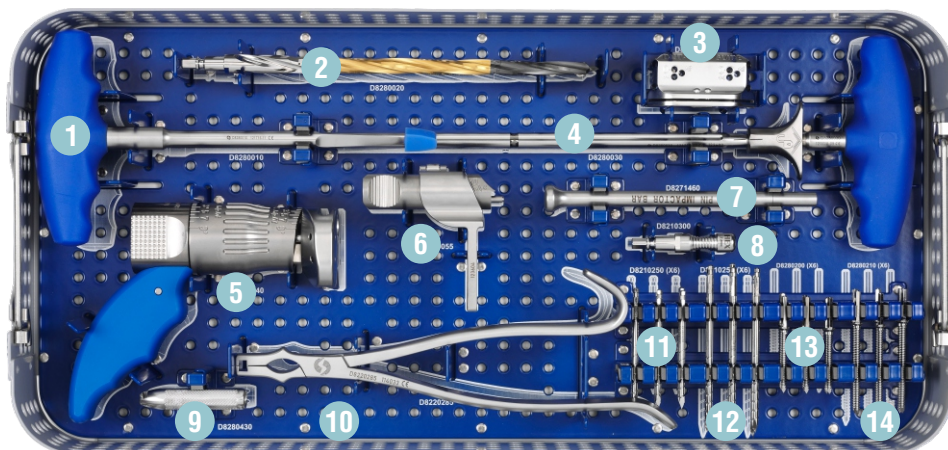

Femoral instrumental set 1 DCF Upper tray

1	D8280010	STARTER AWL	
2	D8280020	STARTER DRILL	
3	D8280050	DISTAL CUTTING GUIDE	
4	D8280030	ALIGNMENT ROD	
5	D8280040	VARUS-VALGUS ALIGNMENT GUIDE	
6	D8280055	CUTTING GUIDE POSITIONER	
7	D8271460	EXTRACTION AUXILIARY BAR / PIN IMPACTOR	
8	D8210300	Ø 3.4 mm MOTOR PIN ADAPTOR TO HUDSON	
9	D8280430	PIN EXTRACTOR TERMINAL Ø 3.4 MM	
10	D8220285	PIN EXTRACTOR CLAMP	6 U
11	D8210250	HELICAL PIN Ø 3.4 x 50 mm	6 U
12	D8210255	HELICAL PIN Ø 3.4 x 75 mm	6 U
13	D8280200	THREADED PIN Ø 3.4 x 35 mm	6 U
14	D8280210	THREADED PIN Ø 3.4 x 50 mm	6 U

D8602100

Femoral instrumental set 1 DCF

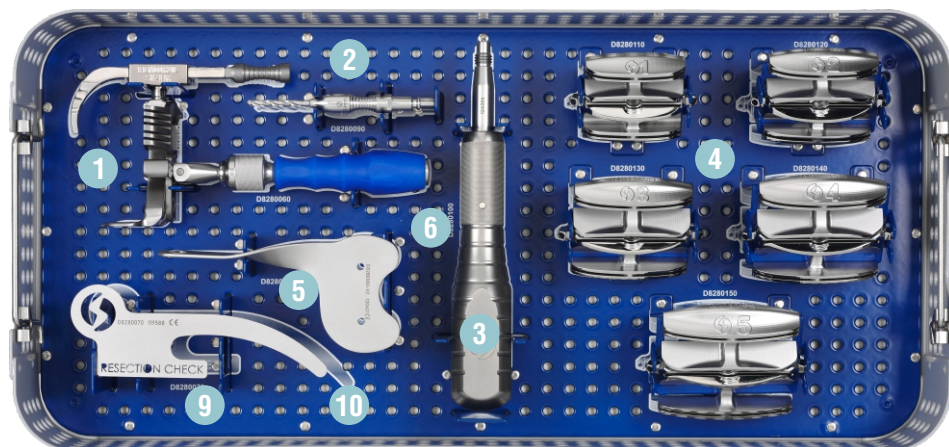

Femoral instrumental set 1 DCF Lower tray

1	D8280060	FEMORAL GAUGE
2	D8280090	DRILL Ø 3.4 mm
3	D8280100	CUTTING BLOCK IMPACTOR / EXTRACTOR
4	D8280110	FEMORAL CUTTING BLOCK SIZE 1
4	D8280120	FEMORAL CUTTING BLOCK SIZE 2
4	D8280130	FEMORAL CUTTING BLOCK SIZE 3
4	D8280140	FEMORAL CUTTING BLOCK SIZE 4
4	D8280150	FEMORAL CUTTING BLOCK SIZE 5
5	D8280080	TIBIAL PROTECTION PLATE
6	D8280070	RESECTION CHECKER

D8602200

Femoral instrumental set 2 DCF

Femoral instrumental set 2 DCF upper tray

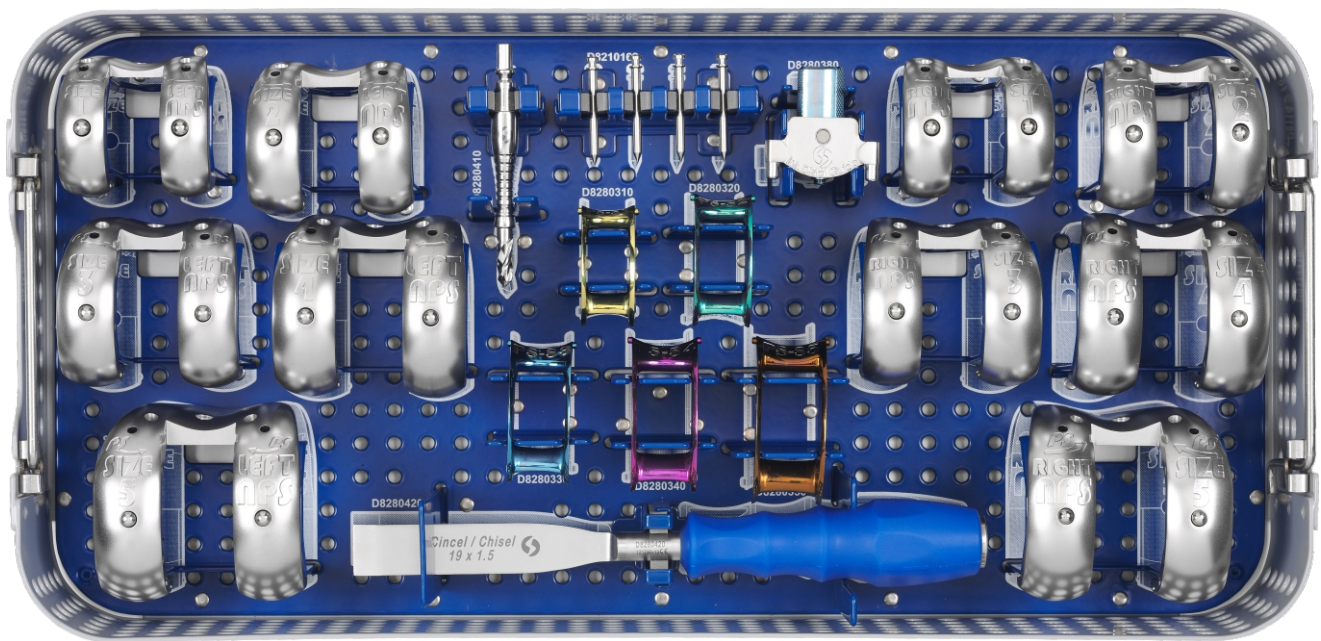

Femoral instrumental set 2 DCF lower tray

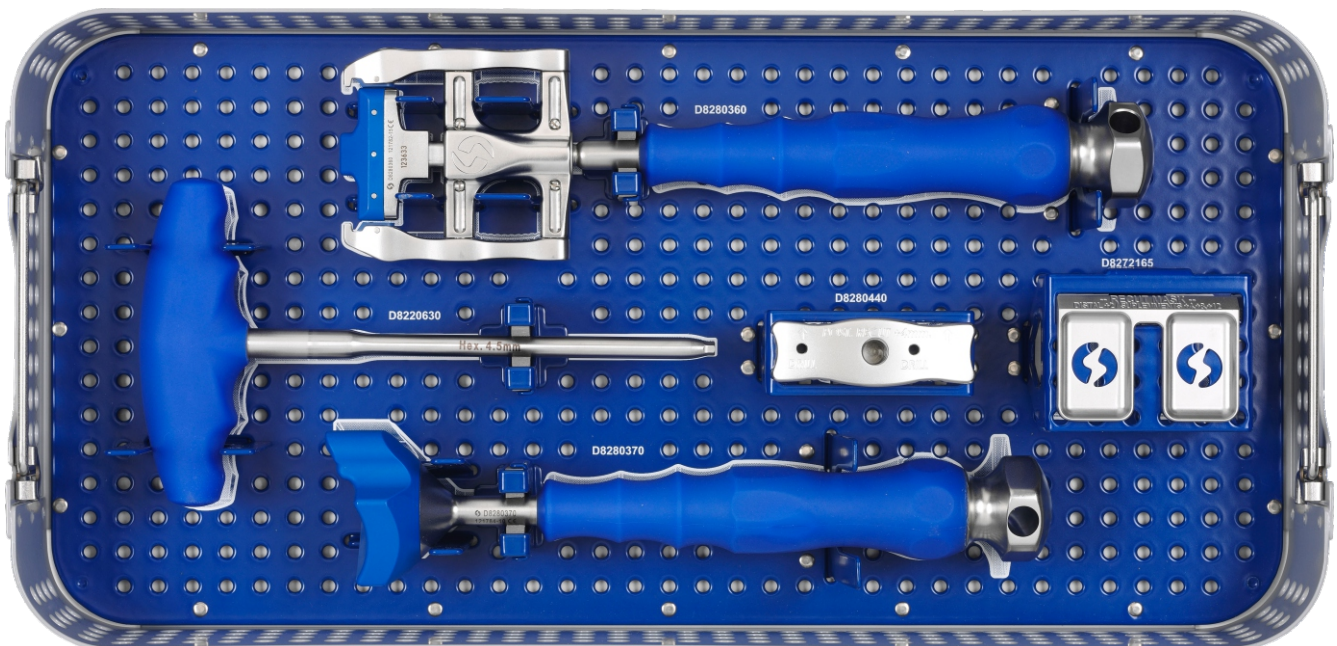

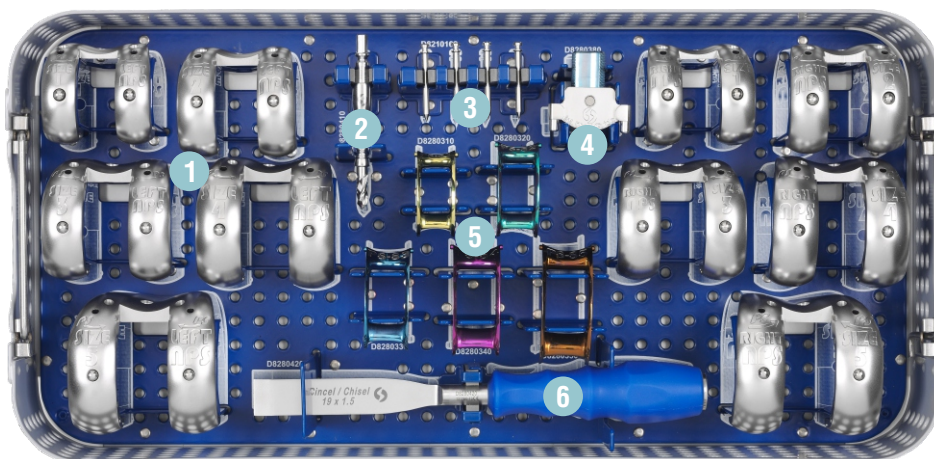

Femoral instrumental set 2 DCF Upper tray

1 TRIAL FEMORAL COMPONENTS

RIGHT		LEFT
D8114110	SIZE 1	D8114120
D8114210	SIZE 2	D8114220
D8114310	SIZE 3	D8114320
D8114410	SIZE 4	D8114420
D8114510	SIZE 5	D8114520

- 2 D8280410 NPS DRILL BIT
- 3 D8210162 PIN WITH HEAD Ø 3.4 mm x 40 mm
- 4 D8280380 INTERCONDYLAR CUTTING GUIDE
- 5 D8280310 PS TRIAL INTERCONDYLAR BOX SIZE 1
- 5 D8280320 PS TRIAL INTERCONDYLAR BOX SIZE 2
- 5 D8280330 PS TRIAL INTERCONDYLAR BOX SIZE 3
- 5 D8280340 PS TRIAL INTERCONDYLAR BOX SIZE 4
- 5 D8280350 PS TRIAL INTERCONDYLAR BOX SIZE 5
- 6 D8280420 CHISEL

4 U

D8602200 Femoral instrumental set 2 DCF

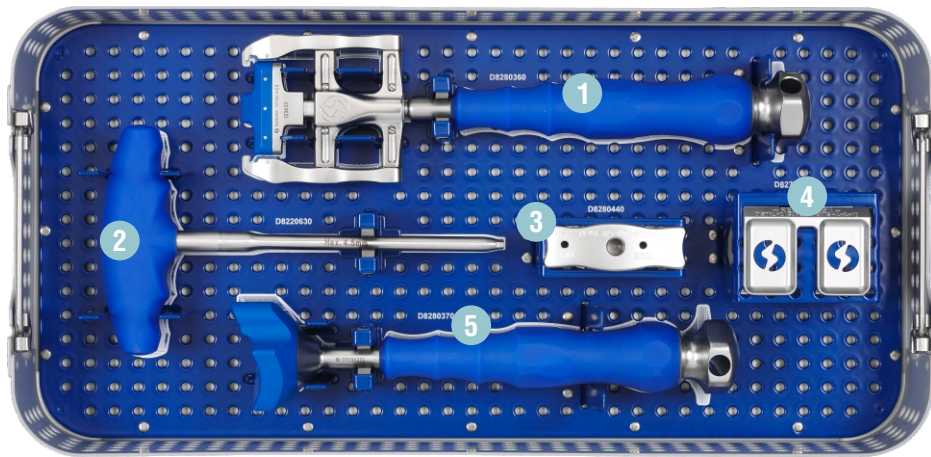

Femoral instrumental set 2 DCF Lower tray

- | | | |
|----------|-----------------|--|
| 1 | D8280360 | IMPACTOR / EXTRACTOR OF FEMORAL COMPONENTS |
| 2 | D8220630 | HEXAGONAL SCREWDRIVER 4.5 mm |
| 3 | D8280440 | POSTERIOR RECUT BLOCK + 4 mm |
| 4 | D8272165 | RE CUTTING DISTAL BLOCK |
| 5 | D8280370 | FEMORAL COMPONENT IMPACTOR |

D8603100

Tibial instrumental set

Upper tray tibial instrumental set Easy Plus

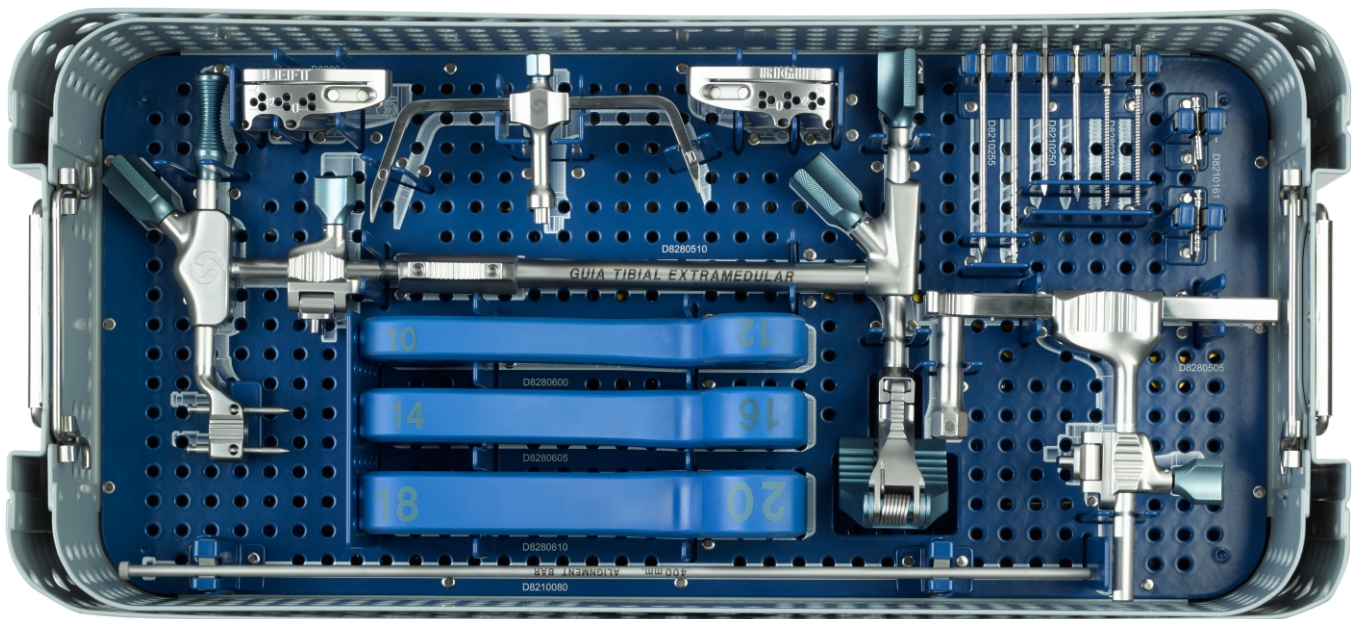

Lower tray tibial instrumental set

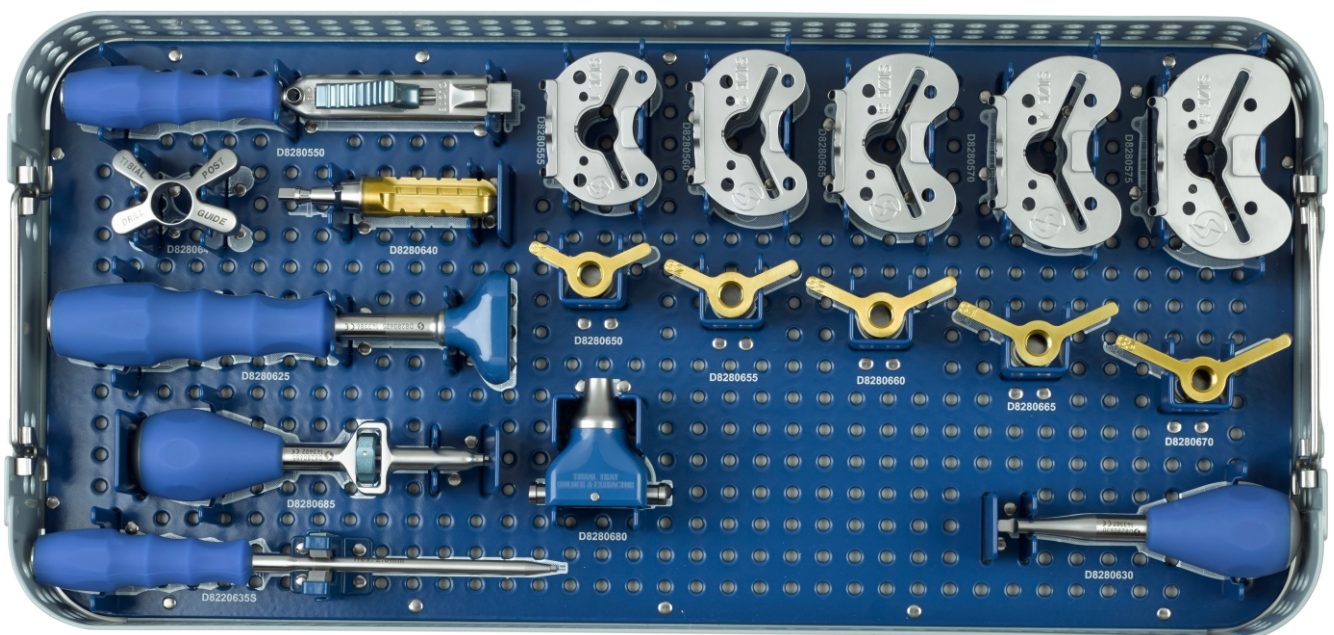

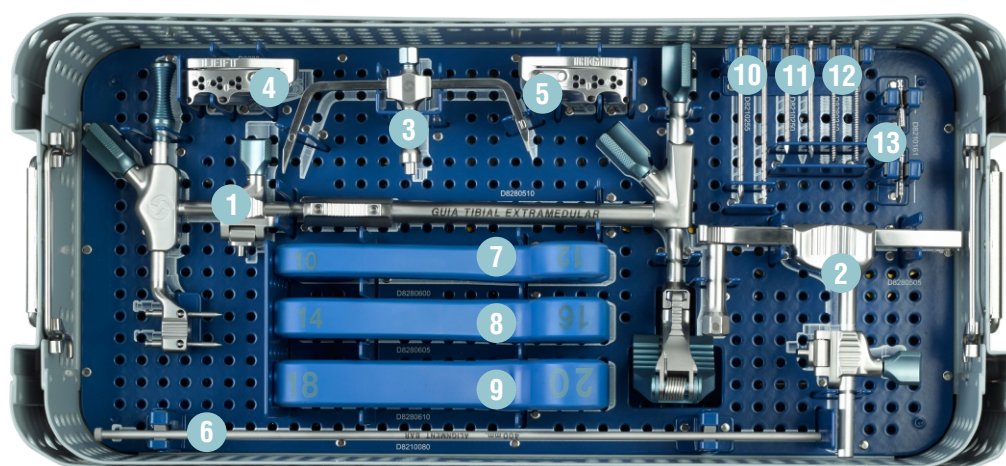

D8603105 Tibial instrumental set Upper tray

1	D8280510	EXTRAMEDULLAR TELESCOPIC GUIDE	
2	D8280505	INTRAMEDULLAR TELESCOPIC GUIDE	
3	D8280520	0-10 TIBIAL STYLUS	
4	D8280530	TIBIAL CUTTING BLOCK RIGHT	
5	D8280525	TIBIAL CUTTING BLOCK LEFT	
6	D8210080	ALIGNMENT SHAFT	
7	D8280600	TRIAL SPACER 10-12 mm	
8	D8280605	TRIAL SPACER 14-16 mm	
9	D8280610	TRIAL SPACER 18-20 mm	
10	D8210255	HELICAL PIN Ø 3.4 x 75 mm	6 U
11	D8210250	HELICAL PIN Ø 3.4 x 50 mm	6 U
12	D8280210	THREADED Ø 3.4 x 50 mm	6 U
13	D8210161	PIN WITH HEAD Ø 3.4 x 30 mm	6 U

D8603100 Tibial instrumental set

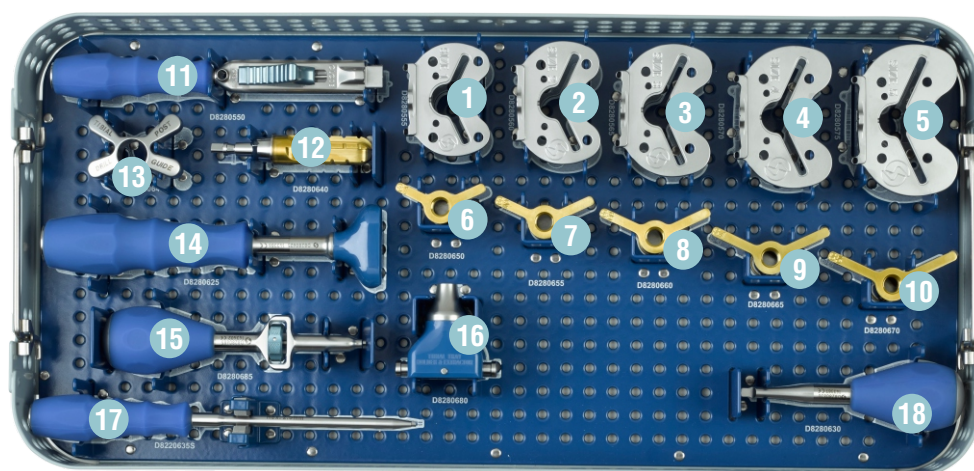

D8603110 Tibial instrumental set Lower tray

- | | | |
|-----------|------------------|--|
| 1 | D8280555 | TIBIAL TEMPLATE SIZE 1 |
| 2 | D8280560 | TIBIAL TEMPLATE SIZE 2 |
| 3 | D8280565 | TIBIAL TEMPLATE SIZE 3 |
| 4 | D8280570 | TIBIAL TEMPLATE SIZE 4 |
| 5 | D8280575 | TIBIAL TEMPLATE SIZE 5 |
| 6 | D8280650 | KEEL CHISEL SIZE 1 |
| 7 | D8280655 | KEEL CHISEL SIZE 2 |
| 8 | D8280660 | KEEL CHISEL SIZE 3 |
| 9 | D8280665 | KEEL CHISEL SIZE 4 |
| 10 | D8280670 | KEEL CHISEL SIZE 5 |
| 11 | D8280550 | TIBIAL TEMPLATE ALIGMENT HANDLE |
| 12 | D8280640 | TIBIAL POST DRILL |
| 13 | D8280645 | TIBIAL POST DRILL GUIDE |
| 14 | D8280625 | TIBIAL INSERT IMPACTOR & MULTIPURPOSE IMPACTOR |
| 15 | D8280685 | FIXING BOLT INTRODUCER |
| 16 | D8280680 | TIBIAL TRAY HOLDER AND TIBIAL IMPACTOR |
| 17 | D8220635S | HEXAGONAL SCREWDRIVER 2.5 mm |
| 18 | D8280630 | TIBIAL INSERT EXTRACTOR |

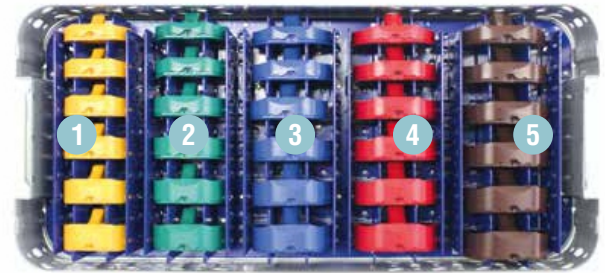
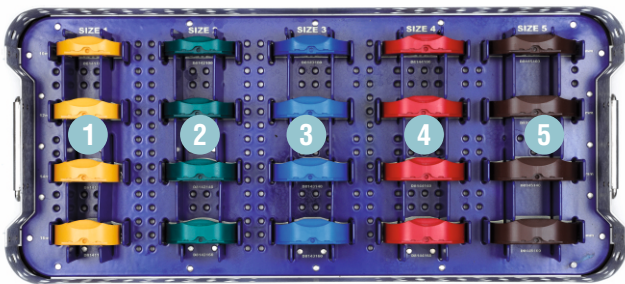

D8402100	NPS instrumental set	D8405100	PS instrumental set
-----------------	-----------------------------	-----------------	----------------------------

SIZE 1

D8141100 SIZE 1 x 10 mm
D8141120 SIZE 1 x 12 mm
1 D8141140 SIZE 1 x 14 mm
D8141160 SIZE 1 x 16 mm

SIZE 2

D8142100 SIZE 2 x 10 mm
D8142120 SIZE 2 x 12 mm
2 D8142140 SIZE 2 x 14 mm
D8142160 SIZE 2 x 16 mm

SIZE 3

D8143100 SIZE 3 x 10 mm
D8143120 SIZE 3 x 12 mm
3 D8143140 SIZE 3 x 14 mm
D8143160 SIZE 3 x 16 mm

SIZE 4

D8144100 SIZE 4 x 10 mm
D8144120 SIZE 4 x 12 mm
4 D8144140 SIZE 4 x 14 mm
D8144160 SIZE 4 x 16 mm

SIZE 5

D8145100 SIZE 5 x 10 mm
D8145120 SIZE 5 x 12 mm
5 D8145140 SIZE 5 x 14 mm
D8145160 SIZE 5 x 16 mm

SIZE 1

D8151100 SIZE 1 x 10 mm
D8151120 SIZE 1 x 12 mm
1 D8151140 SIZE 1 x 14 mm
D8151160 SIZE 1 x 16 mm
D8151180 SIZE 1 x 18 mm
D8151200 SIZE 1 x 20 mm

SIZE 2

D8152100 SIZE 2 x 10 mm
D8152120 SIZE 2 x 12 mm
2 D8152140 SIZE 2 x 14 mm
D8152160 SIZE 2 x 16 mm
D8152180 SIZE 2 x 18 mm
D8152200 SIZE 2 x 20 mm

SIZE 3

D8153100 SIZE 3 x 10 mm
D8153120 SIZE 3 x 12 mm
3 D8153140 SIZE 3 x 14 mm
D8153160 SIZE 3 x 16 mm
D8153180 SIZE 3 x 18 mm
D8153200 SIZE 3 x 20 mm

SIZE 4

D8154100 SIZE 4 x 10 mm
D8154120 SIZE 4 x 12 mm
4 D8154140 SIZE 4 x 14 mm
D8154160 SIZE 4 x 16 mm
D8154180 SIZE 4 x 18 mm
D8154200 SIZE 4 x 20 mm

SIZE 5

D8155100 SIZE 5 x 10 mm
D8155120 SIZE 5 x 12 mm
5 D8155140 SIZE 5 x 14 mm
D8155160 SIZE 5 x 16 mm
D8155180 SIZE 5 x 18 mm
D8155200 SIZE 5 x 20 mm

D8603200

Patellar set

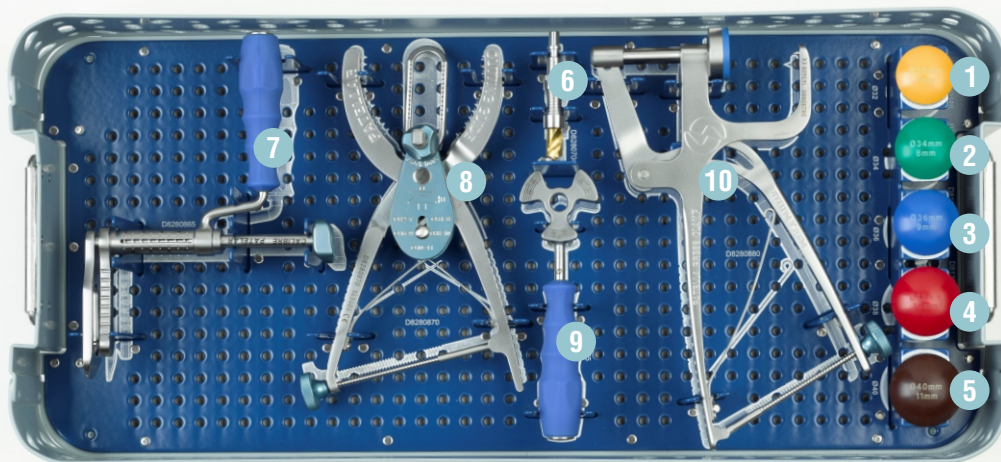

- | | | |
|----|-----------------|--------------------------------|
| 1 | D8130140 | TRIAL PATELLA Ø 32 mm |
| 2 | D8130150 | TRIAL PATELLA Ø 34 mm |
| 3 | D8130160 | TRIAL PATELLA Ø 36 mm |
| 4 | D8130170 | TRIAL PATELLA Ø 38 mm |
| 5 | D8130180 | TRIAL PATELLA Ø 40 mm |
| 6 | D8280700 | PATELLA DRILL |
| 7 | D8280865 | PATELLAR THICKNESS GAUGE |
| 8 | D8280870 | PATELLAR CUTTING GUIDE FORCEPS |
| 9 | D8280875 | PATELLAR DRILLING GUIDE |
| 10 | D8280880 | PATELLAR PRESS |

D8603300

Complex primary set

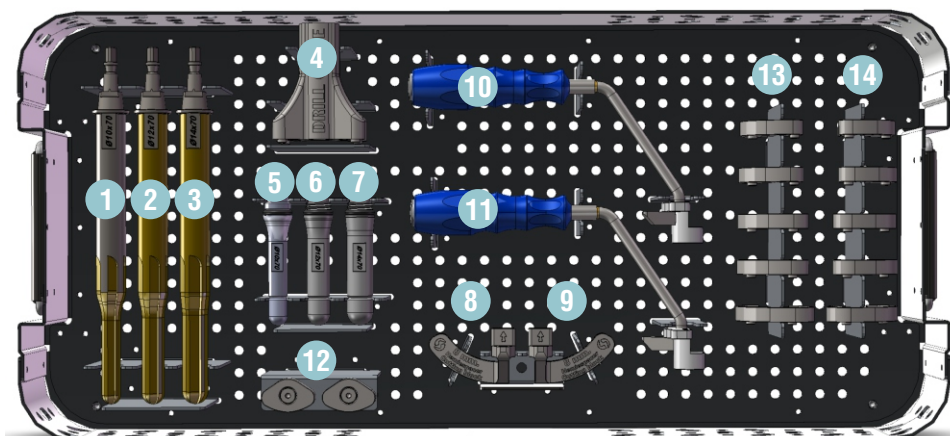

1	D8280750	TIBIAL STEM REAMER Ø 10 mm L 70 mm
2	D8280755	TIBIAL STEM REAMER Ø 12 mm L 70 mm
3	D8280760	TIBIAL STEM REAMER Ø 14 mm L 70 mm
4	D8280765	REAMER GUIDE
5	D8280770	SCREWED TRIAL STEM Ø 10 mm L 70 mm
6	D8280775	SCREWED TRIAL STEM Ø 12 mm L 70 mm
7	D8280780	SCREWED TRIAL STEM Ø 14 mm L 70 mm
8	D8280785	CUTTING DEPTH GUIDE FOR 8 mm LEFT AUGMENTS
9	D8280786	CUTTING DEPTH GUIDE FOR 8 mm RIGHT AUGMENTS
10	D8280855	MIDDLE CUTTING REFERENCE PLANE FOR AUGMENTS RIGHT
11	D8280860	MIDDLE CUTTING REFERENCE PLANE FOR AUGMENTS LEFT
12	D8280790	AUGMENT FOR TIBIAL TRIAL SPACER 8 mm
13	D8280805	TRIAL TIBIAL AUGMENT SIZE 1 LEFT
13	D8280810	TRIAL TIBIAL AUGMENT SIZE 2 LEFT
13	D8280815	TRIAL TIBIAL AUGMENT SIZE 3 LEFT
13	D8280820	TRIAL TIBIAL AUGMENT SIZE 4 LEFT
13	D8280825	TRIAL TIBIAL AUGMENT SIZE 5 LEFT
14	D8280830	TRIAL TIBIAL AUGMENT SIZE 1 RIGHT
14	D8280835	TRIAL TIBIAL AUGMENT SIZE 2 RIGHT
14	D8280840	TRIAL TIBIAL AUGMENT SIZE 3 RIGHT
14	D8280845	TRIAL TIBIAL AUGMENT SIZE 4 RIGHT
14	D8280850	TRIAL TIBIAL AUGMENT SIZE 5 RIGHT

GENUTECH[®]



NPS
Non Postero Stabilized



PS
Postero Stabilized

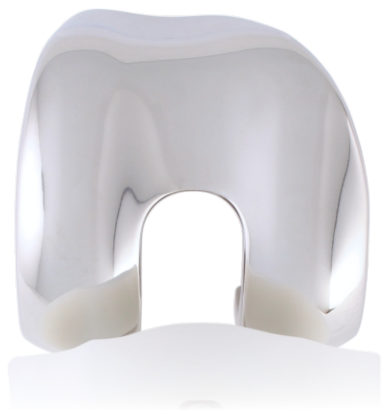

NPS NON CEMENTED femoral component

LEFT	SIZE	RIGHT
D8011120E	1	D8011110E
D8011220E	2	D8011210E
D8011320E	3	D8011310E
D8011420E	4	D8011410E
D8011520E	5	D8011510E

NPS CEMENTED femoral component

LEFT	SIZE	RIGHT
D8021120E	1	D8021110E
D8021220E	2	D8021210E
D8021320E	3	D8021310E
D8021420E	4	D8021410E
D8021520E	5	D8021510E

NPS tibial insert



REFERENCE	SIZE	THICKNESS
D8041100E	1	10 mm
D8041120E	1	12 mm
D8041140E	1	14 mm
D8041160E	1	16 mm
D8042100E	2	10 mm
D8042120E	2	12 mm
D8042140E	2	14 mm
D8042160E	2	16 mm
D8043100E	3	10 mm
D8043120E	3	12 mm
D8043140E	3	14 mm
D8043160E	3	16 mm
D8044100E	4	10 mm
D8044120E	4	12 mm
D8044140E	4	14 mm
D8044160E	4	16 mm
D8045100E	5	10 mm
D8045120E	5	12 mm
D8045140E	5	14 mm
D8045160E	5	16 mm

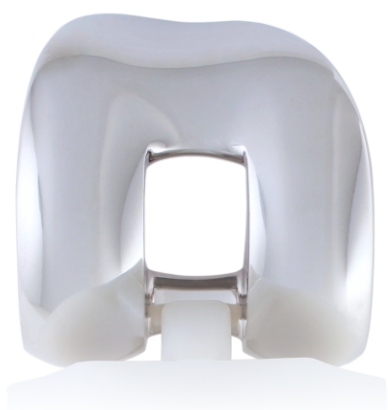

PS NON-CEMENTED component

LEFT	SIZE	RIGHT
D8012120E	1	D8012110E
D8012220E	2	D8012210E
D8012320E	3	D8012310E
D8012420E	4	D8012410E
D8012520E	5	D8012510E

PS CEMENTED component

LEFT	SIZE	RIGHT
D8022120E	1	D8022110E
D8022220E	2	D8022210E
D8022320E	3	D8022310E
D8022420E	4	D8022410E
D8022520E	5	D8022510E

PS tibial insert

REFERENCE	SIZE	THICKNESS
D8051100E	1	10 mm
D8051120E	1	12 mm
D8051140E	1	14 mm
D8051160E	1	16 mm
D8051180E	1	18 mm
D8051200E	1	20 mm
D8052100E	2	10 mm
D8052120E	2	12 mm
D8052140E	2	14 mm
D8052160E	2	16 mm
D8052180E	2	18 mm
D8052200E	2	20 mm
D8053100E	3	10 mm
D8053120E	3	12 mm
D8053140E	3	14 mm
D8053160E	3	16 mm
D8053180E	3	18 mm
D8053200E	3	20 mm
D8054100E	4	10 mm
D8054120E	4	12 mm
D8054140E	4	14 mm
D8054160E	4	16 mm
D8054180E	4	18 mm
D8054200E	4	20 mm
D8055100E	5	10 mm
D8055120E	5	12 mm
D8055140E	5	14 mm
D8055160E	5	16 mm
D8055180E	5	18 mm
D8055200E	5	20 mm





Tibial tray

REFERENCE	SIZE
D8032100E	1
D8032200E	2
D8032300E	3
D8032400E	4
D8032500E	5

Fixation bolt (*Included with tibial tray)

D8220540

Cap for tibial tray

D8032610E	SHORT
D8032620E	LONG



Patellar component

REFERENCE	Ø
D8030140E	32 mm
D8030150E	34 mm
D8030160E	36 mm
D8030170E	38 mm
D8030180E	40 mm



Straight stem for tibia

REFERENCE	SIZE
D8024101E	Ø10X70MM
D8024201E	Ø12X70MM
D8024301E	Ø14X70MM



Tibial supplements 8 mm

REFERENCE	SIZE
D8032710E	Talla 1
D8032720E	Talla 2
D8032730E	Talla 3
D8032740E	Talla 4
D8032750E	Talla 5



INNOVATING WITH **PASSION**



FACTORY / INTERNATIONAL DEPT.

Parque Tecnológico
Leonardo Da Vinci, 12-14
46980 Paterna · Valencia · Spain

NATIONAL DEPT.

Ignacio Iglesias, 70
08950 Esplugues de Llobregat
Barcelona · Spain

www.surgival.com



TOTAL KNEE SYSTEM
GENUTECH®



IRGENUTECHPCTEN / 02-2020 ©

El marcado CE es válido únicamente si también está impreso en la etiqueta del producto