





















## ACA/G and ACZ/G series

- high weighing accuracy
- very good indication readability
- indication backlight
- automatic internal calibration (ACA)
- RS232C, USB-B and USB-A interfaces for printer, computer, label printer, barcode reader and USB flash drive (pendrive)



Laboratory balances ACA/G and ACZ/G series are designed for use in laboratories, pharmacies, jewelry and research institutes where high accuracy of measurement is required.

 external calibration	 products and users database	 unit selection	 animals weighing
 internal calibration	 measurements database	 multilanguage	 density measurement
 GLP compatibility	 date/time	 weighing speed selection	 force measurement
	 printout config.	 threshold/selection	 recipe
	 pieces counting	 max weight	 statistics
	 percentage	 min weight	
	 summation	 alibi memory	

### Options on demand



Under hook weighing

Protective cover

Glass draft shield

ACA hydro set

- hook for hanging weighed object
- protective cover to secure pan
- glass draft shield
- ACA hydro set to measure density of liquids and solids
- LAN or Wi-Fi to work with computer
- barcode reader interface (RS232C+supply)
- computer software : Statistics **freeware** , Communication **freeware** - saving to file, ProCell - export to Excel

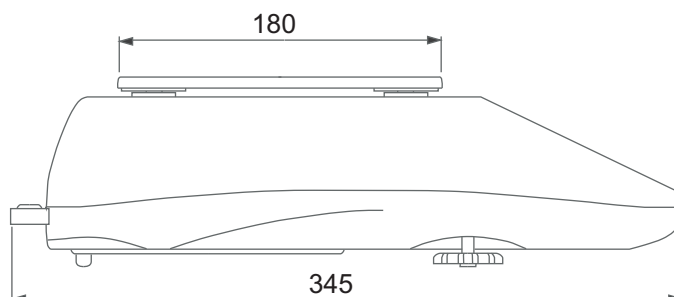
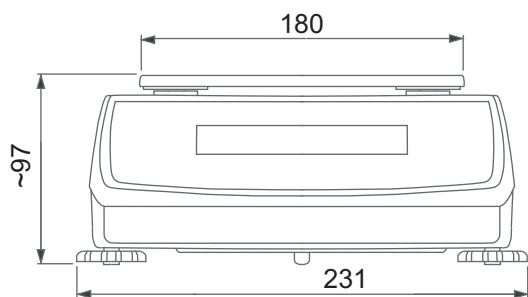
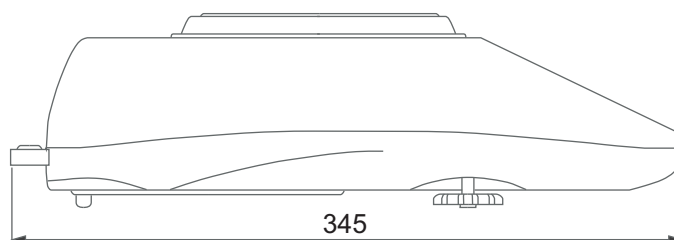
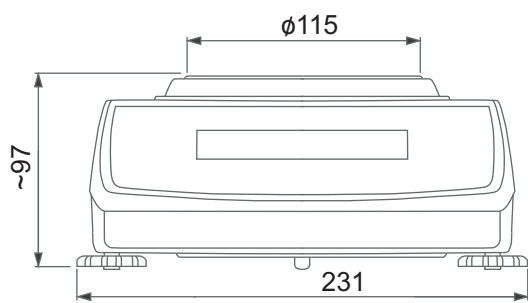

Balances with verification option **M**

## Technical data

Balances with int. calib.	<b>ACA220G</b>	<b>ACA320G</b>	<b>ACA520G</b>	<b>ACA620G</b>	<b>ACA820G</b>	<b>ACA1000G</b>	<b>ACA2200G</b>	<b>ACA3200G</b>	<b>ACA4200G</b>	<b>ACA6200G</b>
Balances without int. calib.	<b>ACZ220G</b>	<b>ACZ320G</b>	<b>ACZ520G</b>	<b>ACZ620G</b>	<b>ACZ820G</b>	<b>ACZ1000G</b>	<b>ACZ2200G</b>	<b>ACZ3200G</b>	<b>ACZ4200G</b>	<b>ACZ6200G</b>
Capacity (Max)	220g	320g	520g	620g	820g	1000g	2200g	3200g	4200g	6200g
Reading unit (d)	0,001g	0,001g	0,001g	0,001g	0,001g	0,001g	0,01g	0,01g	0,01g	0,01g
Verification unit (e)	0,01g	0,01g	0,01g	0,01g	0,01g	0,01g	0,1g	0,1g	0,1g	0,1g
Tare range	-220g	-320g	-520g	-620g	-820g	-1000g	-2200g	-3200g	-4200g	-6200g
Accuracy class	II									
Repeatability	0,001g					0,01g			0,02g	
Linearity	$\pm 0,002g$					$\pm 0,02g$			$\pm 0,02g$	
Working temperature	$+10 \div +40^{\circ}C$									
Weighing time	<3s									
Pan size	115mm					180x180mm				
Display	graphical 110x35mm									
Dimensions (with legs)	231x345x97mm									
Interfaces	RS232, USB-B, USB_A options: LAN or Wi-Fi									
Units	mg, g, kg, ct, lb, oz, ozt, gr, dwt									
Power supply	$\sim 230V$ 50Hz 9VA / $\sim 12V$ 1,2A									
Balance weight	4kg									
Recommended std. of mass	F2 200g		F1 500g			E2 1000g		F2 2000g		F1 5000g