

Anexa Lot IV

Mașina de spălat instrumente

<p>Specificatia tehnica solicitata</p> <p>Masina de spalat - dezinfectare trebuie sa fie suficient de compacta și să îndeplinească pe deplin toate cerințele microbiologice și tehnice.</p>	<p>Specificatia tehnica oferita MELAtherm 10 (Melag/Germania)</p> <p>Dimensiuni / volum externe</p> <p>Lățime: 59,5 cm</p> <p>Înălțime: 82 cm</p> <p>Adâncime: 68 cm</p> <p>Dimensiunile permit montarea într-un cub 60 x 60 x 85 cm (lățime x adâncime x înălțime)</p> <p>Cameră din oțel inoxidabil cu două brațe basculante</p> <p>Adaptoare pentru instrumente goale</p> <p>Capacitate și accesorii</p> <ul style="list-style-type: none"> - principalul suport pentru depozitarea diferitelor coșuri, inclusiv Accesorii. - Sistem încorporat de uscare cu aer cald - Blender de apă încorporat - Pompa dozatoare pentru detergent lichid - Sistem de filtrare - Interfață de rețea pentru documentația procesului tehnologic - Control automat continuu al parametrilor de bază pentru spălare, clătire și uscare- coș principal cu șină injector - coșuri de spălat: G, K, Sp - coș pentru instrumente - carcass încorporat pentru trei casete - carcass încorporat pentru pensete, foarfece etc. - cartușul cu capac <p>Aprox. 80litri</p> <p>Greutate : maxim 80 kg</p> <p>Model</p> <p>Model autonom, cu compartiment inferior</p> <p>Construcție</p> <p>Cameră din oțel inoxidabil, toate celelalte părți din material rezistent la căldură, rezistente la coroziune</p> <p>Spray-uri - cu posibilitatea rotirii și controlului presiunii pulverizării</p> <p>Dispozitiv încorporat pentru uscare rapidă</p> <p>Posibilitatea conectării unui sistem extern de tratare a apei</p> <p>Sistem de dozare încorporat</p> <p>Încărcarea frontală</p> <p>Carcasa ușor dezinfectată.</p> <p>Filtru de control</p>
	<p>Programe</p> <p>90 ° C Program universal</p> <p>Timp ciclu de prelucrare: 37 min. (5 min - timp de menținere) plus min. pentru uscare</p> <p>90 ° C program de procesare rapidă</p> <p>Durata ciclului de procesare: 32 min. (5 min - timp de menținere) plus min. pentru uscare</p> <p>93 ° C program intensiv</p> <p>Durata ciclului de procesare: 45 min. (10 min - timp de menținere) plus 10 min. pentru uscare</p> <p>Program de clătire</p> <p>Programe de testare</p> <p>Posibilitatea modificării parametrilor la fața locului, când noile recomandări necesită modificări</p>

	Posibilitatea de a întrerupe uscarea de către utilizator
	Control
	Control prin microprocesor
	Măsurarea temperaturii cu PT1000 de clasă A
	Informație sub formă de text deschis afișând pe un afișaj alfanumeric, 2 rânduri, din 20 de caractere în limba rusă
	Ușor de folosit; prezența a două butoane - pentru a începe și a termina lucrul
	Detectarea complet automată a calității apei în prezența unui sistem de tratare a apei conectat
	Dispozitivul de spălare și dezinfectare salvează automat informațiile despre ultimele 150 de cicluri, precum și protocoalele privind defecțiunile
	Cititor de carduri de memorie încorporat (cartela CF)
	Interfața
	Interfața de rețea RJ45 pe partea din față și din spate
	Cerințe privind siguranța
	Ușa este blocată în caz de pierdere a puterii
	Ușa este blocată și monitorizată pe tot parcursul ciclului.
	Senzor de temperatură pentru a preveni supraîncălzirea
	Alarmer sonore și vizuale în caz de defecțiuni
	Alimentarea
	220V / 50-60 Hz,
	În conformitate cu următoarele documente și regulamente de reglementare
	EN 15883
	93/42 CEE
	97/23 CEE
	EN 60601-1-2; EMC
	EN 61010-1-2; Siguranță electrică



EC Certificate
Directive 93/42/EEC Annex II, excluding Section 4
Full Quality Assurance System
Medical Devices

Registration No.: HD 60111728 0001

Report No.: 21246570 001

Manufacturer: MELAG Medizintechnik oHG
Geneststr. 6-10
10829 Berlin
Deutschland

Products:

- Active devices for disinfection and sterilization
- Non active medical devices for disinfection, cleaning and rinsing

(see attachment for products included)

Expiry Date: 2021-06-30

The Notified Body hereby declares that the requirements of Annex II, excluding section 4 of the directive 93/42/EEC have been met for the listed products. The above named manufacturer has established and applies a quality assurance system, which is subject to periodic surveillance, defined by Annex II, section 5 of the aforementioned directive. For placing on the market of class III devices covered by this certificate an EC design-examination certificate according to Annex II, section 4 is required.

Effective Date: 2016-07-01

Date: 2016-06-23

Notified Body

Dipl.-Ing. D. Meier

TÜV Rheinland LGA Products GmbH - Tillystraße 2 - 90431 Nürnberg

TÜV Rheinland LGA Products GmbH is a Notified Body according to Directive 93/42/EEC concerning medical devices with the identification number 0197.



TÜV Rheinland
LGA Products GmbH
Tillystraße 2, 90431 Nürnberg

**Attachment to
Certificate**

Registration No.: HD 60111728 0001
Report No.: 21246570 005

Manufacturer: MELAG Medizintechnik oHG
Geneststr. 6-10
10829 Berlin
Deutschland

Product groups included:

Premium-Plus-Class
Pro-Class
S-Class
MELAtronic
Cliniclave
MELAquick
MELAtherm 10
MELAdes

Date: 2017-05-08

Notified Body

[Signature]
Dipl.-Ing. I. Munkler



MELAG
competence in hygiene

The innovative MELAG washer-disinfectors

MELAtherm® 10 / MELAtherm® 10 Evolution

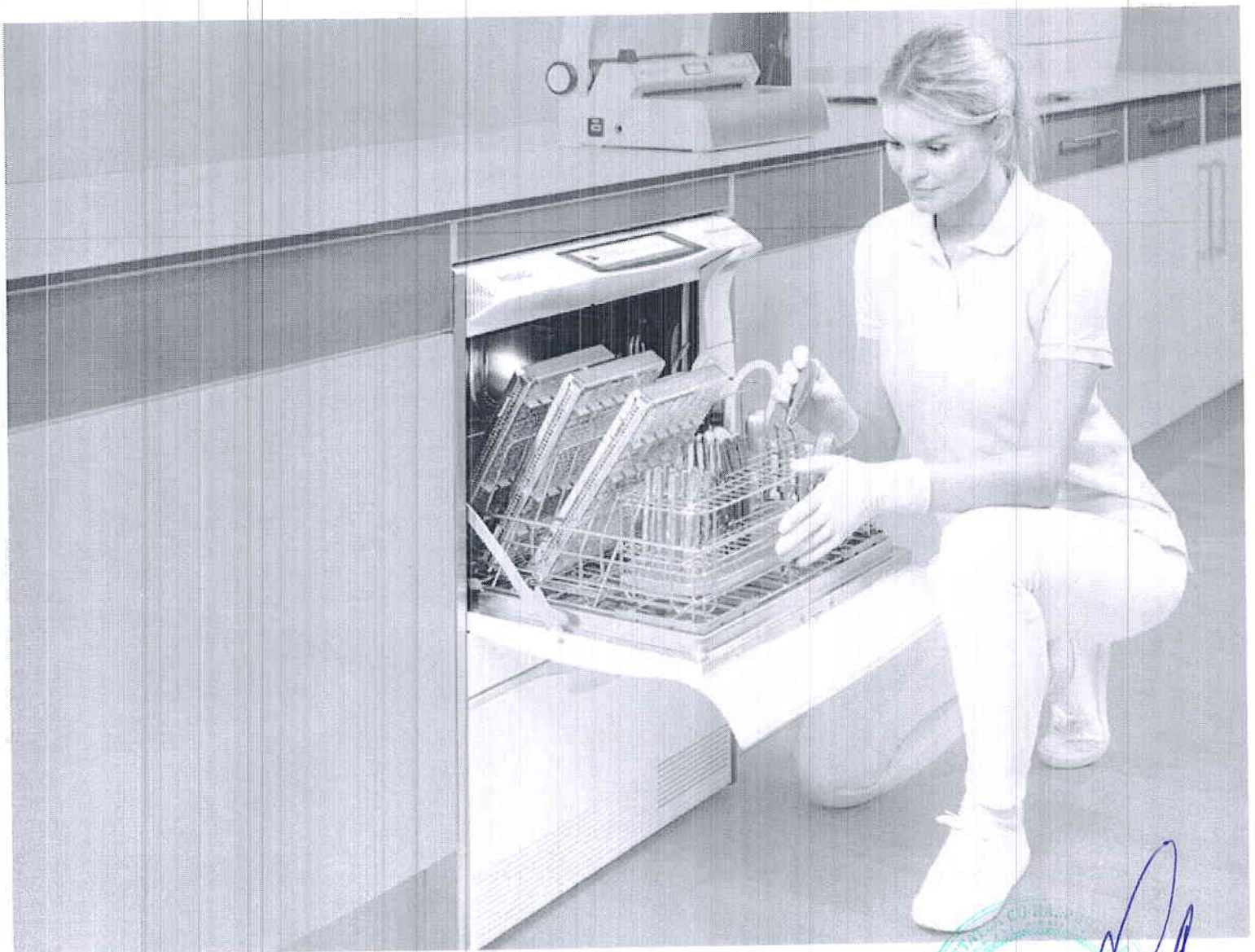

Quality – made in Germany

The MELAG washer-disinfectors

For an optimized workflow in practice and clinic.

Cutting-edge technology for a superior workflow: Cleaning and disinfection with a MELAG washer-disinfector is the safest and most efficient way to ensure reliable instrument decontamination. Benefit from the advantages and protect your patients and team:

 **Efficiency:**
Reducing your workload and saving time and money

 **Safety:**
Improving safety by minimizing staff contact with instruments

 **Legal compliance:**
Logging of the decontamination process ensures reproducibility

 **Process optimization:**
Immediate availability of non-surgical instruments after automatic cleaning and disinfection*

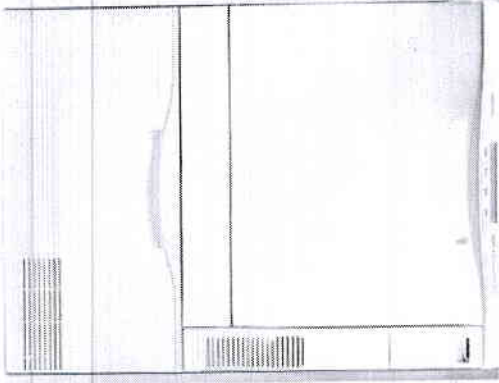

MELATHERM® 10

The product highlights at no extra cost:

- ✓ Active drying
- ✓ Drawer with integrated metering module and process agents
- ✓ Integrated documentation interfaces
- ✓ Practice-optimized washing chamber



NEW

MELATHERM® 10 Evolution

Provides additional new and unique innovations:

- ➕ Large Smart-Touch Display with video tutorials
- ➕ ProControl batch approval
- ➕ AquaBoost Technology
- ➕ MELAconnect interface

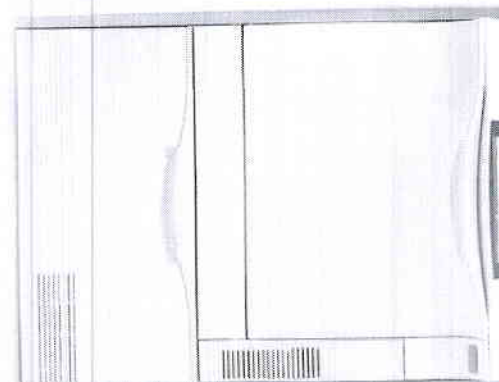

Customer reviews



"MELAG is our preferred partner for infection control. We trust in MELAG's long experience and innovative approach for efficient workflows."

The Linden Tree Dental Lounge
Dunfermline, United Kingdom



"Using the MELAG system and MELATHERM® 10 enables us to satisfy patients' needs and maintain the highest level of safety."

Clinic of Dr. Karolina Jandova
Prague, Czech Republic



"We are delighted with the MELAG system solution! The aligned product line performs the entire decontamination workflow efficiently and quickly - even for 60 patients per day."

Clinic of Kampf and Vieler Kampf
Grieshainstein, Germany

*Please comply with your national standards.

The MELAtherm® 10 product highlights

These advantages are unique.

Our goal is to provide the highest level of efficiency and safety in instrument decontamination. To this end, 180 engineers in the R&D department work at our Berlin headquarters to develop innovative solutions setting benchmarking standards in infection control. Take advantage of the MELAG washer-disinfectors with the unique product highlights:

Active drying



Instruments must be dry, regardless of whether they are re-used immediately after reprocessing in the washer-disinfector or whether they are wrapped and sterilized. The active drying guarantees the best possible workflows, whilst protecting your instruments against recontamination, corrosion and damage.

Only few washer-disinfectors on the market have the active drying technology, which is necessary to achieve these results. Fitted with active drying, MELAtherm® 10 ensures the best drying results at no extra cost.

Integrated metering module and process agents

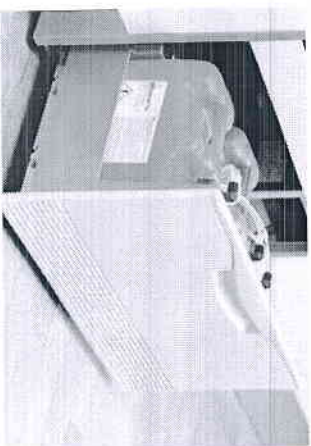

The process agents and the metering module are integrated in the media drawer. The innovative MELAG concept saves space, facilitates ergonomic work and helps to avoid errors.

The metering module of MELAtherm® 10 permits automatic and accurate dosing of the process agents. The MELAtherm® process agents are especially aligned to the requirements of MELAG washer-disinfectors, thereby ensuring the best cleaning outcome with minimum consumption.

Practice-optimized washing chamber

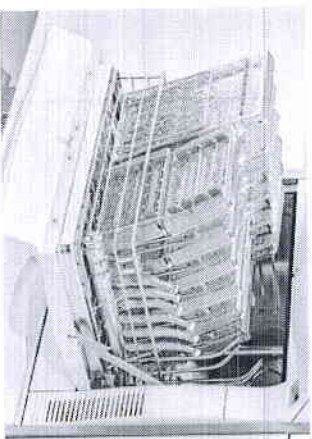

The optimized chamber concept of MELAtherm® 10 allows for economical and ecological instrument decontamination in record time. Instruments are cleaned, disinfected and dried in only about 60 minutes. This top-level performance comes with minimum consumption costs of only about 1,00 €/cycle. Operating larger washer-disinfectors with an insufficient loading wastes energy and water and places an unnecessary burden on the environment.

Benefit from over 80 baskets and accessories to adjust the configuration of the practice-optimized washing chamber to match your reprocessing needs - regardless of the size and specialization of your practice or clinic.

Documentation interfaces

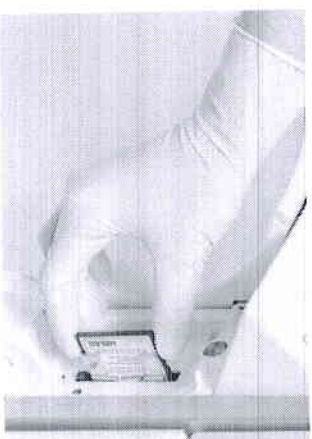

MELAG washer-disinfectors monitor all the relevant process parameters to ensure the highest-possible level of safety. The generated logs provide legal certainty and can be saved via CF card or two network interfaces.

The batch approval ProControl of MELAtherm® 10 Evolution makes your life even easier: Use ProControl to perform a paperless documentation and approval of the cleaning and disinfection process directly on the device at no extra cost.



Find out more about
replacing the process agents
in our video tutorial:



www.melag.com/en/infomedia

Find out more about
the process documentation
in our video tutorial:



www.melag.com/en/infomedia



MELAtherm® 10

Superior quality and innovative features.

MELAtherm® 10 is the solution for fast, safe and above all, cost-effective instrument decontamination. Over 15,000 practices and clinics throughout the world rely on the innovative device concept - join them and take your workflow to a whole new level.

With its **practice-optimized washing chamber** and a wide range of accessories, MELAtherm® 10 permits the cleaning and disinfection of very large quantities of instruments. The subsequent **active drying** ensures hand-warm and dry instruments reprocessed within only about 60 minutes.

All the necessary components required for efficient decontamination procedures are integrated in the washer-disinfector in a space-saving way: The dosing of process agents and the documentation of process parameters are performed automatically by MELAtherm® 10. This saves valuable time and allows your staff to take on other duties in practice and clinic.



Active drying:

Active exterior and interior drying protects the instruments against corrosion and damage.



Integrated process agents:

Integration of metering module and process agents creates extra space, makes working easier and helps to avoid errors.



Practice-optimized washing chamber:

The combination of an innovative chamber concept with a versatile range of baskets helps to save time and money.



Documentation interfaces:

An integrated CF card slot and two network interfaces require no extra tools for documentation.



MELAtherm® 10 Evolution

Impressive performance and intuitive operation.

The MELAG washer-disinfector of the Evolution Series convinces with new unique innovations in addition to the proven product highlights of MELAtherm® 10. MELAtherm® 10 Evolution provides maximum performance and ease of use for an even more efficient instrument decontamination workflow.

MELAtherm® 10 Evolution sets new standards in operation: Its large Smart-Touch Display with helpful video tutorials facilitates intuitive operation. You retain full control even during the program cycle. The new MELAconnect App provides you with access to the device status and program progress from anywhere in your practice or clinic. Finally, take advantage of ProControl to perform a fast and paperless batch approval directly on the Smart-Touch Display.

The new AquaBoost Technology ensures optimal cleaning outcomes:

AquaBoost achieves double rinsing pressure and up to 44 % better cleaning results at the same water consumption as MELAtherm® 10. The increased pressure permits the decontamination of even more instruments. The cleaning, disinfection and drying of 23 handpieces and instruments for up to 40 patients in only 60 minutes is possible only with MELAtherm® 10 Evolution.



Smart-Touch:

Operation and program selection are as easy as never before using the large Smart-Touch Display. Integrated video tutorials covering all relevant issues guarantee a self-explanatory operating concept.



ProControl:

Performing user authentication and batch approval directly on the device saves time and provides legal certainty.



AquaBoost:

The new high-performance circulation pump ensures a 44 % better cleaning outcome and greater capacities. Decontaminate up to 23 handpieces and turbines per cycle!



MELAconnect App:

Smart workflow in instrument decontamination: Monitor the device status and program progress at any time and from anywhere in your practice and clinic using the MELAG mobile app. The MELAconnect App provides even greater convenience: user manuals, video tutorials, troubleshooting and the seal check function ensure a perfect workflow.





MELAtherm® 10 Evolution

Product highlights





Find out more about the advantages of MELAtherm® 10 Evolution in our product video: www.melag.com/en/multimedia

Baskets and adapters for all specialties Perfection in the finest detail.

The practice-optimized washing chamber of MELAG washer-disinfectors guarantees short operating times, ergonomic work, low consumption of process agents and optimal cleaning outcomes.

Benefit from over 80 baskets and adapters to adjust the configuration of the practice-optimized washing chamber to match your needs - regardless of the size and specialization of your practice or clinic. The stackable Flex-baskets and the MELA-store® system represent the best solutions for the decontamination of large quantities of instruments.

Cleanfinity Filter

The protection of hollow body instruments with narrow lumen requires reliable fine filtration of the water. The cleanable central filter and the innovative control indicator of the injector rail guarantee maximum safety and efficiency. If the control pin is not triggered, the filter can be cleaned quickly by using the brush included in the scope of delivery.

Discover our loading configurations:

The preselected loading concepts provide orientation for efficient instrument decontamination in your dental or medical field. For an individual configuration, please get in touch with our international sales team. The contact information of our territory managers is available on our homepage www.melag.com

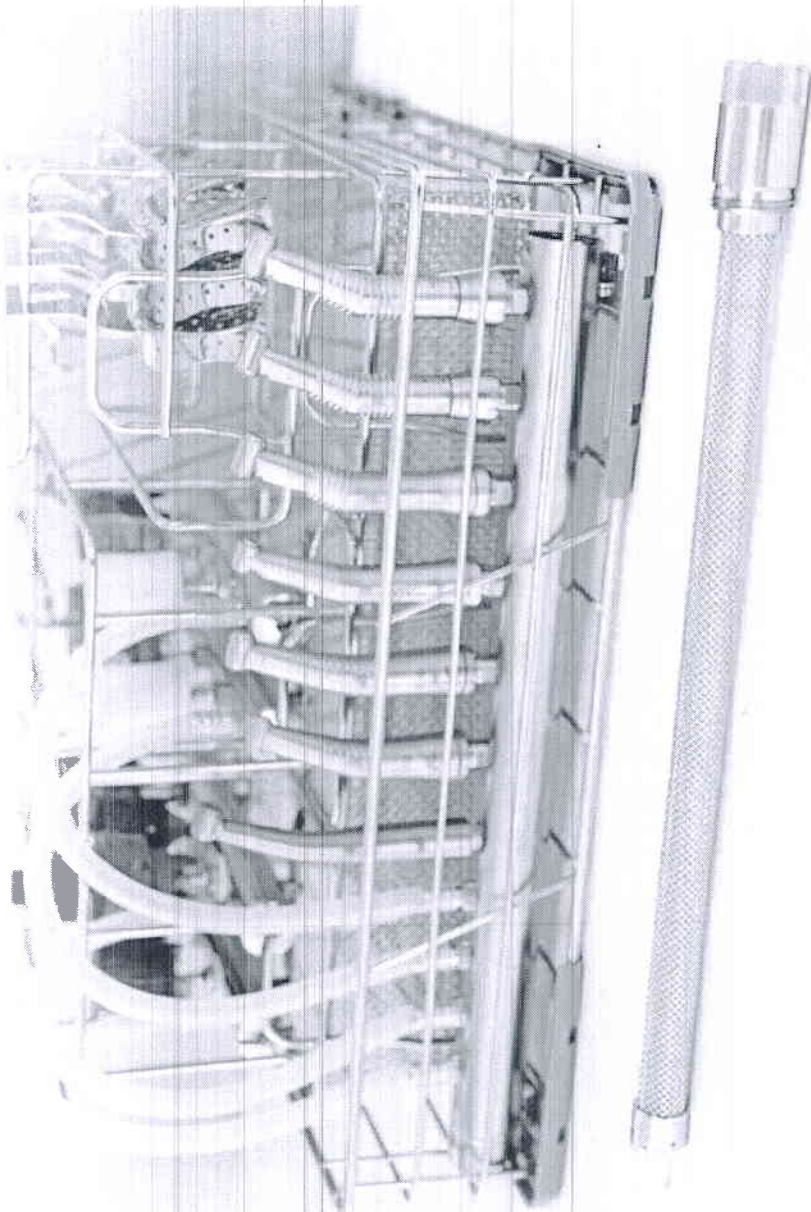

Dental clinic

Instruments for over 40 patients and up to 33 hollow body instruments can be decontaminated in a single cycle in record time. The injector basket Flex 1 represents the safest solution for the decontamination of ultrasonic scaler tips.

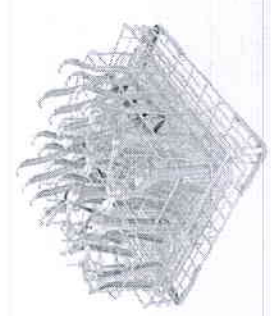

Gynaecological clinic

Up to 32 specula are available for patient treatment after cleaning, disinfection and drying. The Flex basket G provides additional space for further instruments.



ENT clinic

192 ear specula and many other instruments can be cleaned, disinfected and dried in only about 60 minutes. Take advantage of our versatile range of accessories for ENT practices and clinics.

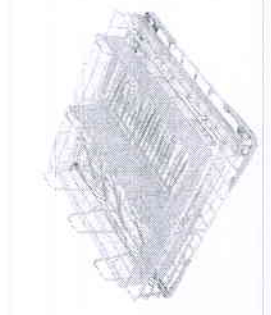

Medical clinic

With a range of stackable Flex baskets, hose connections and adapters for up to 33 hollow body instruments, MELA-therm® 10 perfectly fits the needs of surgical, orthopaedic and urological, dermatological and general practices and clinics.

The MELAstore® system

Re-defining decontamination workflows.

Are you aiming at improving your workflow even further? Enhance the efficiency and quality of your instrument decontamination process with MELAstore®. Available in various sizes, MELAG wash trays and sterilization containers are perfectly aligned to MELAG washer-disinfectors and autoclaves. Benefit from the unique advantages of MELAstore®-Trays and MELAstore®-Boxes:

Saving time:
Save up to 30 minutes per decontamination cycle compared to the individual packaging of instruments

Environmental protection:
Reduce material costs and practice waste through lower consumption of transparent sterilization packaging

Process optimization:
Increase the degree of standardization and quality management

Safety:
Safe fixing of instruments through silicone bars to protect your instruments and personnel.

Decontamination process using MELAstore®

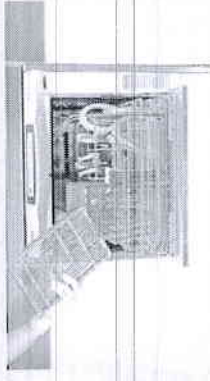

Cleaning and disinfection of MELAstore®-Trays with MELAG washer-disinfectors

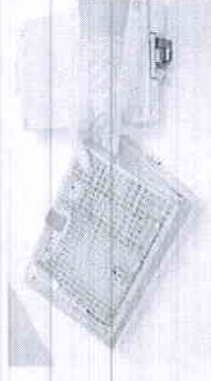

Packaging with MELAstore®-Boxes



Sterilization with MELAG autoclaves

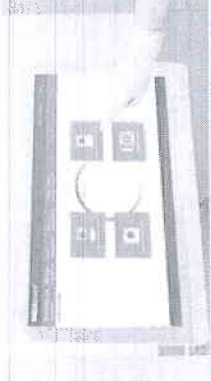

Documentation and approval with MELAtrace®

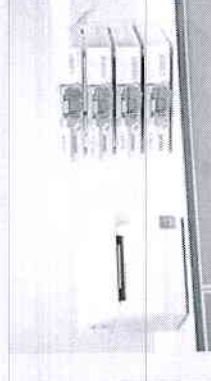

Labelling with MELAprint® 6D



Single instruments vs. MELAstore

MELAG



Discover the advantages of the MELAstore® systems in our video: www.melag.com/germany/melastda

Accessories

Aligned solutions for the MELAtherm® 10 Series.

The optional accessories ensure even greater efficiency and reliability in instrument decontamination. Choose from **MEtherm®** process agents, our **MELAdem® 53** water treatment unit, the **MELAtrace®** documentation and approval software, the **MELAstore®** wash trays and sterilization containers as well as a floor unit to customize and improve your workflow as you need it.



MEtherm® process agents

Developed especially for the MELAG washer-disinfectors, our **MEtherm®** process agents (cleaning agents, neutralizers and rinse aids) guarantee best cleaning and drying outcomes with minimum consumption. Take advantage of a free **MEtherm®** starter set to experience the benefits of the process agents and their perfect alignment with MELAG washer-disinfectors.

+ MELAdem® 53

The water treatment unit performs the final rinse with demineralized water, thereby ensuring the protection and care of your instruments. The high-performance **MELAdem® 53** even permits the connection of additional devices in your decontamination room.

+ MELAtrace®

This user-friendly software solution ensures the paperless documentation, approval and traceability of the entire instrument decontamination process. **MELAtrace®** does not require an annual signature or licence fee.

+ MELAstore®

For increased efficiency and quality in instrument decontamination: The high degree of standardization achieved by **MELAstore®-Trays** and **MELAstore®-Boxes** not only reduces waste, but also realizes remarkable time-savings.

+ MELAG floor unit

It is possible to upgrade the **MELAtherm® 10** with the ergonomically designed **MELAG** floor unit to facilitate loading and unloading for a higher level of convenience. It also provides additional storage space.

Digital tools

Take advantage of our international sales team and of our digital tools on our website to achieve the best possible workflow in your practice setting.



Download center:
Feel free to use our intuitive search engine to access all the required information and documents that you need.

www.melag.com/usa/en/yes/downloadcenter

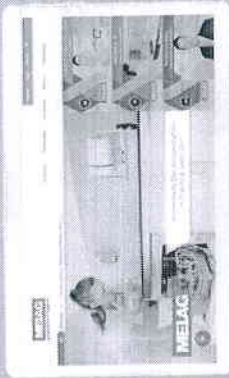

MultiMedia:
From your own 2D videos on our MultiMedia channel to access all relevant documents in minutes, it's all in a matter of seconds.

www.melag.com/usa/en/yes/mobile



Troubleshooting:
Enter the resolution code that you can find right on the machine to access troubleshooting in less than a minute.

www.melag.com/usa/en/yes/troubleshooting

Technical data

Figures and facts at a glance.

MELAG washer-disinfectors are available in the versions 400 Volt (three-phase current, DTA) and 230 Volt (alternating current, DTB). If the installation location permits connection to a 400 Volt supply, we recommend the DTA version due to its significantly shorter operating times.

Programs	MELAtherm® 10		MELAtherm® 10 Evolution	
	DTA / 400 V*	DTB / 230 V*	DTA / 400 V*	DTB / 230 V*
Quick-Program	36 min	53 min	37 min	57 min
Universal-Program	40 min	59 min	42 min	63 min
Intensive-Program	51 min	64 min	54 min	67 min
Ophthalmic-Program	42 min	59 min	43 min	63 min

* All programs plus active drying, which the user can interrupt at any time.

	MELAtherm® 10	MELAtherm® 10 Evolution
Device dimensions (W × H × D)	59,8 × 81,8 (83,6**) × 67,8 cm fits under a 60 cm worktop	
Device dimensions (W × H × D) with floor unit	59,8 × 124 × 67,8 cm	
Washing chamber (W × H × D)	46,5 × 40,5 × 44,8 cm	
Weight	80 kg (86 kg**)	
Weight with floor unit	106 kg	
Electrical connection DTA	3 N AC 400 V, 50 Hz, 3 × 16 A	
Power input DTA	9,3 kW	10,2 kW
Electrical connection DTB	AC 220–240 V, 50 Hz, 1 × 16 A	
Power input DTB	3,3 kW	3,3 kW
Dimensions MELAdem® 53 / 53 C	Ø 24 × 57 cm (61,5 cm inc. connecting bend) / Ø 24 × 44,3 cm (48,8 cm)	

** with cover plate

System solutions, innovation and quality

MELAG was founded in 1951 and is an owner-operated family company, that specializes in products aiming at optimized practice hygiene. The manufacturing and production sites are exclusively located in Germany on a 22.000 m² premises with 450 employees working diligently to maintain MELAG's world leading role in instrument decontamination.

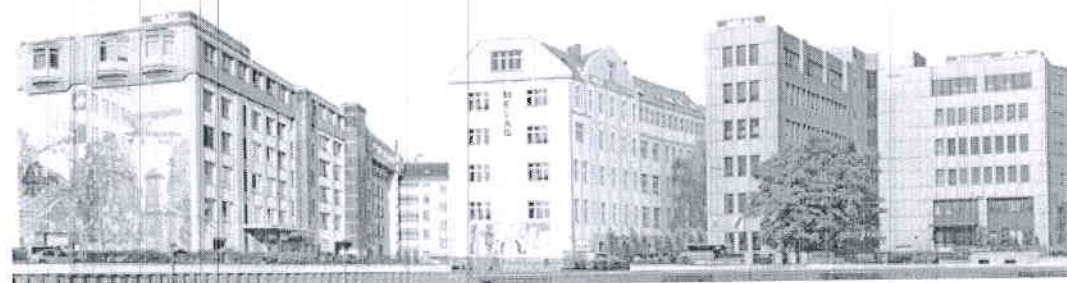

For further information:
www.melag.com

Anexa Lot 7 Sterilizator 80 L GP-80MO

• Sterilizator 80 L		
Descriere	Sterilizator cu aer uscat destinat sterilizării instrumentelor medicale cu construcție interioară din oțel inox	
Parametrul	Specificația solicitată	Specificația oferită
Ventilație	forțată, controlată electronic	forțată, controlată electronic
Construcție interioară	oțel inox	oțel inox
Construcție exterioară	cu acoperire anticorozivă	cu acoperire anticorozivă
Regimuri de sterilizare	programabile	programabile
Protecție la supraîncălzire	analogical digitală	analogical digitală
Alarmer	acustică	acustică
	vizuală	vizuală
Diagnostic automat	cu afișarea codului erorii	cu afișarea codului erorii
Volumul	80 l, ± 5 l	80 l, ± 5 l
Camera sterilizatorului	Să mențină steril instrumentele în interiorul camerei, să nu fie orificii cu acces direct la exterior	Menține steril instrumentele în interiorul camerei, să nu fie orificii cu acces direct la exterior
Temperatura	60 - 200°C	60 - 200°C
Abaterea temperatură	nu mai mare de 3°C	nu mai mare de 3°C
Abatere timp	≤ 1 min	≤ 1 min
Timp de încălzire pînă la 180°C	≤ 45 min	55 min
Regim de sterilizare prestabilite	180°C, 60 min	180°C, 60 min
	160°C, 150 min	160°C, 150 min
	120°C, 45 min	120°C, 45 min
Timpul de răcire	≤ 50 min, pînă la 75°C	≤ 50 min, pînă la 75°C
Deconectare de avariere	la temperatura 205 - 235°C	la temperatura 205 - 235°C
Tipul de funcționare fără întrerupere	≥ 15 ore	≥ 15 ore
Polițe	≥ 2	≥ 2
Alimentare	220V, 50 Hz	220V, 50 Hz
Manual de utilizare în română	Da, se va prezenta la livrare	Da, se va prezenta la livrare
Buletin metrologic	Da, se va prezenta la livrare	Da, se va prezenta la livrare

СТЕРИЛИЗАТОРЫ ВОЗДУШНЫЕ

**ГП- 10 МО, ГП- 20 МО
ГП- 40 МО, ГП- 80 МО**

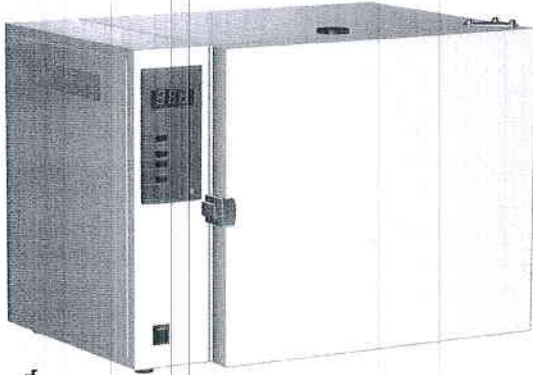

Стерилизаторы воздушные предназначены для стерилизации хирургических инструментов, стеклянной посуды и термостойких шприцев (с отметкой 200°C) и игл к ним. Стерилизаторы могут быть использованы для дезинфекции и сушки медицинских изделий.

Исполнение:

- с опосредованным охлаждением стерилизуемых изделий внутри камеры,
- с естественным охлаждением стерилизуемых изделий внутри камеры.

ОСНОВНЫЕ СВОЙСТВА:

- в стерилизаторах с опосредованным охлаждением применяется дополнительная воздушная рубашка вокруг камеры, система охлаждения работает без подачи холодного воздуха на стерилизуемый материал внутри камеры;
- автоматическая регулировка и поддержание температуры;
- вся необходимая информация о режимах работы и выбранной программе отображается на цифровом дисплее;
- энергонезависимая память для сохранения параметров до 10 программ, которые можно изменять и вызывать для работы;
- равномерное распределение температуры по объему камеры;
- электронные процессорные блоки управления изготавливаются на высококачественном импортном оборудовании с использованием технологии поверхностного монтажа, на основе импортной элементной базы;
- стерилизаторы оснащены высококачественными, надежными электровентильаторами, что исключает поломки и сводит к минимуму затраты на гарантийное и послегарантийное обслуживание;
- устройство защиты от перегрева;
- современный дизайн;
- малое энергопотребление;
- камера и все элементы, контактирующие со стерильным инструментом, выполнены из качественной нержавеющей стали.



ТЕХНИЧЕСКИЕ ХАРАКТЕРИСТИКИ

Наименование	ГП-10МО	ГП-20МО	ГП-40МО	ГП-80МО
Объем камеры, л	10	20	40	80
Габаритные размеры (ШхГхВ) мм, не более	440x450x415	625x450x415	705x510x495	815x580x595
Внутренние размеры (ШхГхВ) мм, не более	150x225x275	330x220x275	410x280x355	520x350x455
Мощность, кВт, не более	1,0	1,3	1,8	2,0
Масса, кг, не более	20	21(24)*	26(31)*	37(43)*
Задаваемые температурные режимы, °С	60...200	60...200	60...200	60...200
Время нагрева стерилизатора до температуры +180°С, мин, не более	30	35	48	55
Задаваемое время выдержки, мин	1...999	1...999	1...999	1...999
Время охлаждения до температуры +75°С, мин, не более*	35	35	35	50
Автоматическая остановка процесса стерилизации при отклонении температуры от заданной, °С, не более	±3	±3	±3	±3
Аварийное отключение стерилизатора от сети при перегреве в камере, °С	205...235	205...235	205...235	205...235
Количество полок стандартное/макс., шт.	2 (4)	2 (4)	2 (4)	2 (4)
Время непрерывной работы в сутки, ч, не более	16	16	16	16
Питание, В/Гц	220/50	220/50	220/50	220/50
Фиксированные программы установленные на заводе	180°С/60мин, 160°С/150мин, 120°С/45мин, 85°С без отсчета времени			

* стерилизаторы с опосредованной системой охлаждения.





ТАМОЖЕННЫЙ СОЮЗ ДЕКЛАРАЦИЯ О СООТВЕТСТВИИ

Заявитель Акционерное общество "Государственный Рязанский приборный завод". ОГРН: 1116234013598.
Место нахождения: 390000, город Рязань, улица Семинарская, дом 32, Российская Федерация. Фактический адрес: 391300, Рязанская область, город Касимов, улица Индустриальная, дом 3, Российская Федерация. Телефон: +74913122921. Факс: +74913122921. Адрес электронной почты: goot@kaspz.ru.

в лице Директора Григорьева Евгения Михайловича
заявляет, что

Стерилизаторы воздушные,
модели: ГП-5 МО, ГП-10 МО, ГП-20 МО, ГП-40 МО, ГП-80 МО. Продукция изготовлена в соответствии с ТУ 9451-026-41457390-2011.

изготовитель Акционерное общество "Государственный Рязанский приборный завод"

Место нахождения: 390000, город Рязань, улица Семинарская, дом 32, Российская Федерация. Фактический адрес: 391300, Рязанская область, город Касимов, улица Индустриальная, дом 3, Российская Федерация

код ТН ВЭД ТС 8419 20 000 0

Серийный выпуск

соответствует требованиям

ТР ТС 020/2011 "Электромагнитная совместимость технических средств"

Декларация о соответствии принята на основании

Протокол испытаний № 2567-10/05-ТС от 28.10.2015 года. Испытательная лаборатория «Испытания и контроль», Регистрационный номер РОСС RU.04ИАИ0.001, срок действия с 20.05.2015 года по 19.05.2018 года, адрес: 125057, город Москва, Ленинградский проспект, дом 75, корпус 1, этаж 1, комната 16.

Дополнительная информация

Срок службы, условия хранения и транспортировки согласно технической и эксплуатационной документации изготовителя. Регистрационное удостоверение № ФСП 2011/10267 от 15.06.2015 года

Декларация о соответствии действительна с даты регистрации по 28.10.2020 включительно.

(подпись)

М.П.

Григорьев Евгений Михайлович

(инициалы и фамилия руководителя организации-заявителя или физического лица, зарегистрированного в качестве индивидуального предпринимателя)

Сведения о регистрации декларации о соответствии:

Регистрационный номер декларации о соответствии: ТС № RU Д-RU.AY37.B.17663

Дата регистрации декларации о соответствии 29.10.2015



e) Dispozitiv electro-chirurgical (diatermocoagulator) mobil cu accesorii specializate

Model: ARC-250, Producător: BOWA, Țara: Germania.

Parametrul			Specificație tehnică solicitată	Specificație tehnică propusă	
Descriere			dispozitiv destinat pentru tăierea și coagularea țesuturilor biologice în procesul actului chirurgical care utilizează curenți electrici de frecvență înaltă		
Frecvența			cuprinsă între 300 KHz și 1 MHz	DA	
Canale de ieșire:	Monopolar		izolat	DA	
	Comutator de mână		inclus	DA	
	Comutator de picior		pedală dublă (taiere, coagulare)	DA	
	Bipolar		da	DA	
Moduri de lucru:	Monopolar:	Tăiere:	Putere maximă- 250 W	DA	
			Tensiune maximă- 950V	DA	
	Coagulare:		Putere maximă- 120 W	DA	
			Tensiune maximă- 470V	DA	
	Bipolar	Coagulare:		Putere maximă- 120 W	DA
				Tensiune maximă- 175V	DA
Regimuri de lucru preselectate	Blend, strong, standart, macro, micro, resection		da	DA	
Posibilitatea de lucru în regim Gastro optional	Argon		Prezentarea dovezii ca permite aceasta optiune - în broșura, manual de utilizare	DA în broșura	
	Gastro loop		Prezentarea dovezii ca permite aceasta optiune - în broșura, manual de utilizare	DA în broșura	
	Gastro cutit		Prezentarea dovezii ca permite aceasta optiune - în broșura, manual de utilizare	DA în broșura	
Funcție de autotestare	la pornire		da	DA	
	continu în timpul manipulării		da	DA	
Canal de ieșire independentă			da	DA	
Indicarea și monitoring a electrodului neutru			da	DA	
Posibilitate de conectarea a electrodului neutru de unica folosinta			da	DA	
Sistem integrat de siguranță			da	DA	
Prezenta modului de control a zonei de carbonizare în regimul de taiere în nivele -			minim 10	da	
Aplicatii disponibile	Ginecologice		da	DA	
	Chirurgicale		da	DA	
	Endochirurgicale/ Gastrice		da	DA	

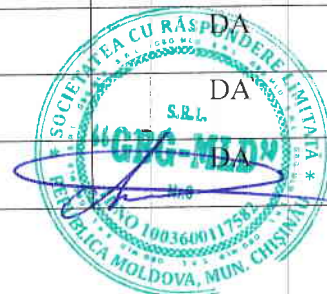

ARC 250
ELEKTROCHIRURGIE-GERÄT
SPEZIALIST DER SPITZENKLASSE

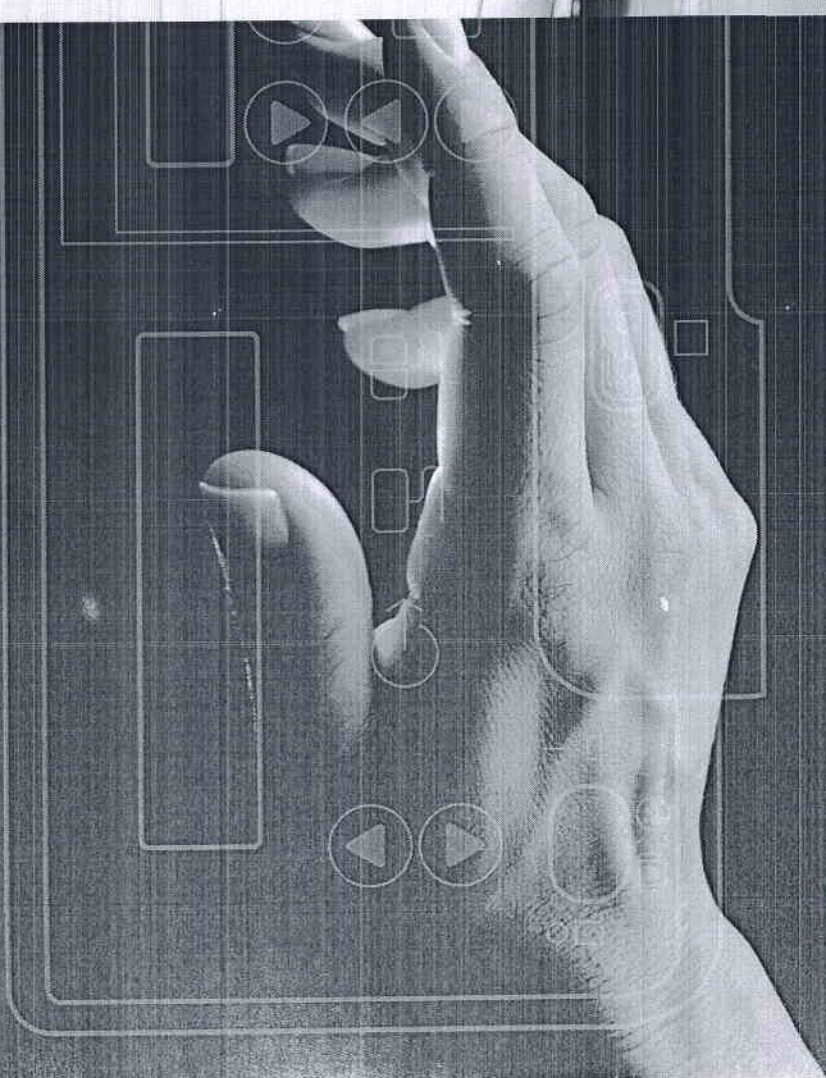

BOWA
ARCO

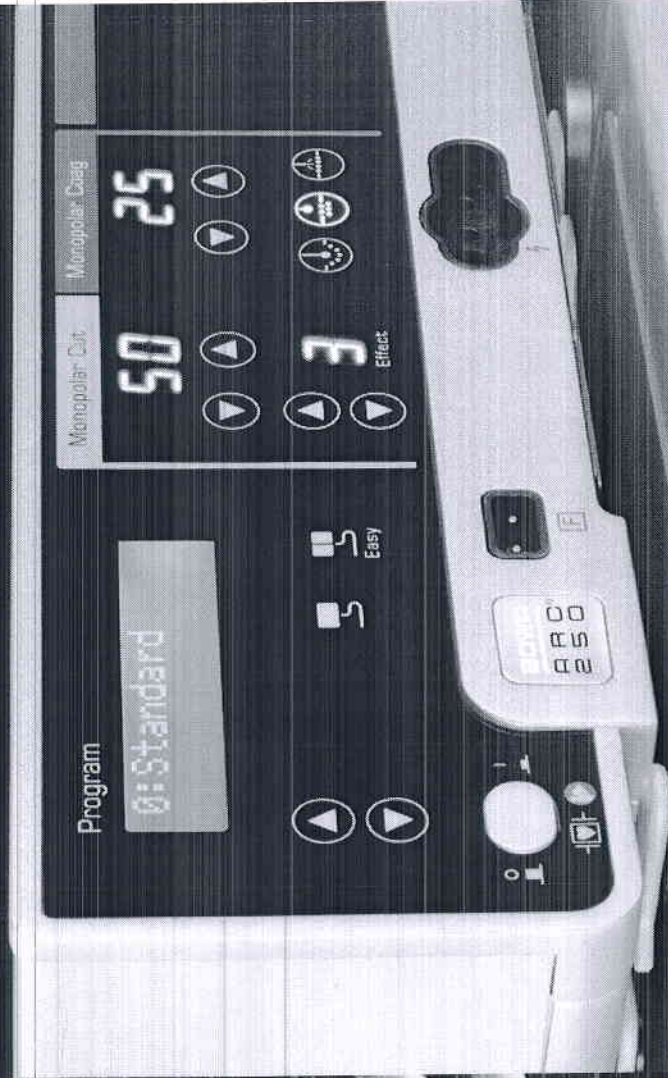

ARC 250 — der Spezialist

Mit dem ARC 250 haben Sie den Spezialisten im Haus, wenn es um elektrophysiotherapeutische Schmalstrom- und konjugierten dar Spitzstromtherapie geht. Er kommt als ein monopolarer und ein bipolarer Instrument für

Einsatz in den Disziplinen Chirurgie, Plastische Chirurgie, HNO, Gastroenterologie, Dermatologie, Urologie und Gynäkologie eingesetzt werden können. Dabei stellen Sie elektrophysiotherapeutischen Grundfunktionen zur Verfügung.

Spitzentechnologie, sinnvoll kombiniert für besondere Anwendungsbereiche

Reproduzierbare Gewebe-Effekte und sichere Leistungssteuerung

Die Leistungsregelung ARC CONTROL passt die Leistungsgabe bei Geweunterschieden und Veränderung von Schnittfläche oder -geschwindigkeit auf das jeweils erforderliche Minimum an. Es wird nur so viel Leistung abgegeben wie tatsächlich für den elektromagnetischen Effekt benötigt wird.

Einfach programmierbar

Der ARC 250 ist einfach programmierbar. Die Einstellung und Benennung Ihrer persönlichen Programme ist auf insgesamt 100 Speicherplätzen möglich. Es stehen zudem verschiedene Programme mit erprobtenen Geräteeinstellungen zur Auswahl.

Intuitive, schnelle Bedienung

Per monochrome und der typische Abgleich werden jeweils über Direktwahlknöpfe eingestellt. Alle Einstellungen werden in der Detailansicht im LCD-Display angezeigt.

Hochtech im Blick

Der ARC 250 bietet alle wesentlichen elektrischen Funktionen wie Standard- und spezielle Funktionen wie AUTOSTART oder Synchronisation sowie EASY Neutralitätsfremdwachstum oder dem integrierten Fehlerspeicher und permanenten Selbstcheck ISSYS.

Ideal für die Resektion

Der ARC 250 bietet mit 230 W die ideale Voraussetzung für Resektionen mit membranloser Resektoskopie und Hysteroskopie. Selbst die Durchleuchtung von Ventralaxonen ist möglich.

ARC 250, Art. 890270



EINFACH SICHER – Immer alle Einstellungen im Blick

Individualisierte Resektions-Effekte, ohne eigene Leistungsabgabe. Einmalige Einstellung für alle Einzel-Resektionen. Einmalige Einstellung für alle Einzel-Resektionen.

Intuitive, schnelle Bedienung. ARC CONTROL passt die Leistungsgabe bei Geweunterschieden und Veränderung von Schnittfläche oder -geschwindigkeit auf das jeweils erforderliche Minimum an.

Hochtech im Blick. Der ARC 250 bietet alle wesentlichen elektrischen Funktionen wie Standard- und spezielle Funktionen wie AUTOSTART oder Synchronisation sowie EASY Neutralitätsfremdwachstum oder dem integrierten Fehlerspeicher und permanenten Selbstcheck ISSYS.

Anwendungsgebiete (Anzeige)	Programme
Gastroenterologie	Gastro LOOP, Gastro KAFFEE, Augen F, EY
Urologie	Resektion
HNC, Plastische und Ästhetische Chirurgie, Mund-, Kiefer-Gesichts-Chirurgie, Neurochirurgie, Knie- und Hüftchirurgie	Standard, Micro
Laparoskopische Chirurgie	Augen

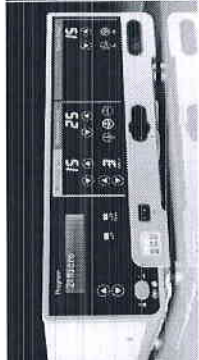

Im Programm-Block können alle registrierten Effekte für den Vollbereich von Micro-Resektoskopie zur Verfügung



Der Programm-Block kann individuell für alle Einzel-Resektionen für alle Einzel-Resektionen zur Verfügung



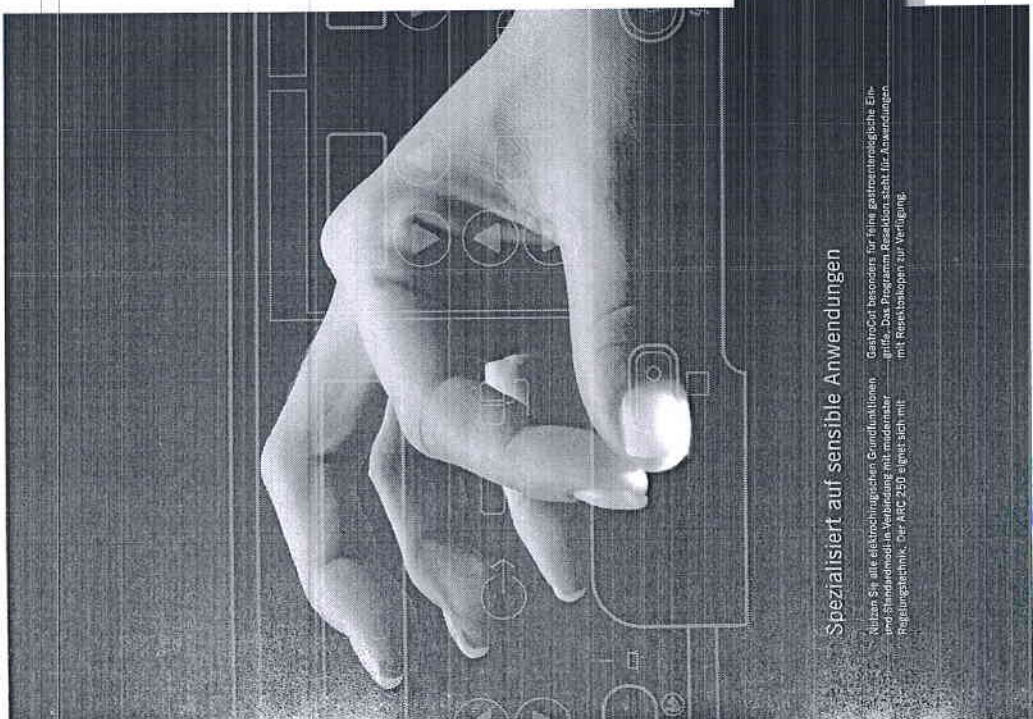

Spezialisiert auf sensible Anwendungen

Nutzen Sie alle elektronischen Grundfunktionen und Schindwehnd in Verbindung mit moderner Regelungstechnik. Die ARC 250 eignet sich mit



Spezialprogramme für die Gastroenterologie

GastroCut für die Gastroenterologie
 Mit dem GastroCut der ARC 250 erzielt der Gastroenterologe ideale Resultate bei der Bekämpfung von Gallen- und Gichtsteinen, Nierensteinen mit Schlingen oder Massenspektren.

Die Pulslänge von Schweiß- und Kasqualemissionen kann der Anwender in drei Geschwindigkeiten „slow“, „medium“ und „fast“ variabel sowie Anlöserungen anpassen.

Jeder Schnitt ist dabei bereits optimiert, den Koagulationseffekt regelt er einfach über die Elektroinstellung in neun Stufen.

Dies ermöglicht sowohl verschiedene Verfahren zur Verengung von Konduktoren als auch zügiges Vorgehen, wenn es sich um Situationen handelt.

StromCut

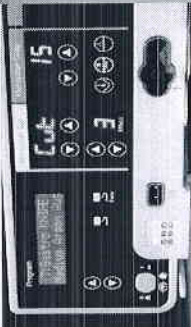

GastroCut EAPF ist für die Arbeit mit Frühstadien oder Papillomen geeignet.



ARC 250 und ARC PLUS – die Endo-Workstation

ARC 250 ist ein vollwertiges Endoskopie-System, das die Arbeit des Endoskopisten erleichtert. Die ARC 250 ist ein vollwertiges Endoskopie-System, das die Arbeit des Endoskopisten erleichtert. Die ARC 250 ist ein vollwertiges Endoskopie-System, das die Arbeit des Endoskopisten erleichtert.



BOWA

EINFACH SICHER

BOWA electronic GmbH & Co. KG
Pfeiferstr. 4-10
72810 Geislingen | Germany

Telefon +49 (0) 7072-6002-0
Telefax +49 (0) 7072-6002-33
Info@bowa.de | bowa@bowa.de



www.bowa.de | 480560-0014 | 1-800-DF | Pinpoint in Germany | Technische und konstruktive Änderungen vorbehalten. Entspricht der BOWA-Standard für Luftschlingen

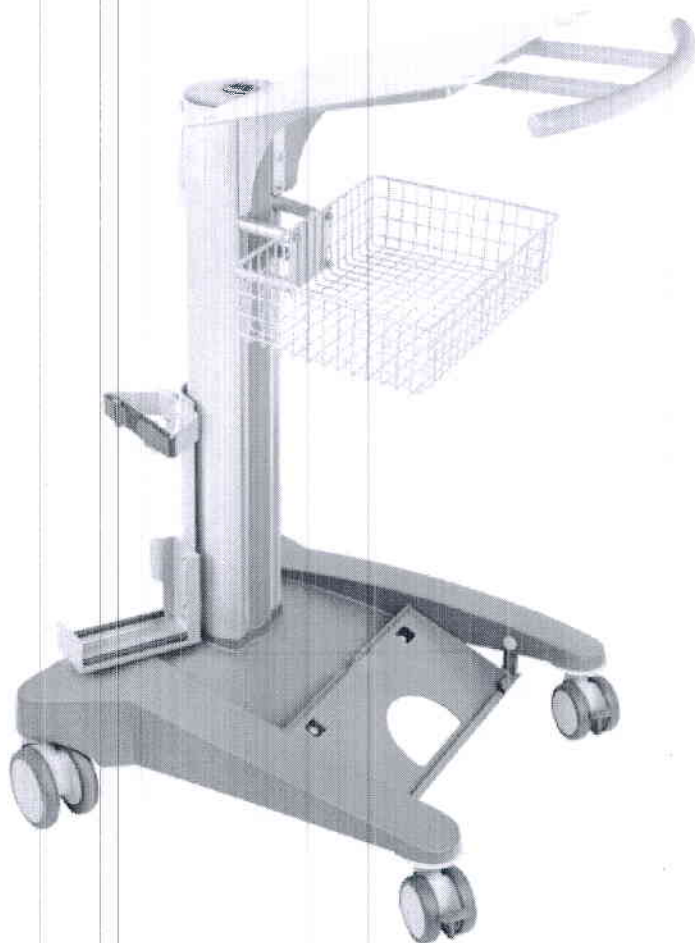

ARC CART with frontal basket, assembled



Certificate for Non-Medical Devices

The below enlisted devices are provide by BOWA-electronic GmbH & Co. KG as non-medical devices, and therefore are not included in the Free Sales Certificate. By declaration of the manufacturer a valid free sales within the country of registration of the other BOWA devices is valid.

Article number	Product description	CoO
050-230	Testing device for electrosurgical accessories	A
050-250	BOWA Service Case	A
050-251	BOWA Service Case (without power measurement)	A
060-012	Electrode container with lid and rack	A
700-099	Sealing cap for LAP electrode with suction / irrigation tube (5 pcs.)	A
723-000	Cleaning brush - Set (4 pcs.)	A
723-020	Sealing spare parts ErgoLAP MONO., LIGATOR, NightKNIFE (1 set)	A
723-050	ERGO 315R, cleaning adapter Set	A
723-051	ERGO 315R, cleaning adapter handle/jaw	A
723-052	ERGO 315R, cleaning adapter push rod	A
750-010	ErgoLAP BIPOLAR, sealing spare parts (1 set)	A
773-980	Container	A
773-981	Rack	A
773-982	ERGO 315R, cleaning tray	A
773-983	ERGO 315R, lid for tray	A
900-401	Dr. Dongle, for ARC 400	A
900-402	USB flash drive for ARC 400 / 350 (REF 900-351)	A
900-450	Basic guidelines, system information for ARC 250 / 303	A
900-451	Cable holder, for ARC 250 / 303	A
900-806	Gas cylinder Argon, 4.8 l, connection DIN477 no. 6, empty	A
900-807	Gas cylinder Argon, 4.8 l, connection DIN477 no. 10, empty	A
900-808	Gas cylinder Argon, 4.8 l, connection CGA no. 580, empty	A
900-809	Gas cylinder Argon, 4.8 l, connection BS 341 no. 3, empty	A

Continuing on page 2

Continued from page 1

Article number	Product description	CoO
902-022	ARC CART Equipment trolley	A
902-050	ARC CART with frontal basket, assembled	A
902-053	ARC CART Equipment trolley with drawer, assembled	A
902-054	ARC CART for SHE SHA, assembled	A
902-900	ARC CART, Gas cylinder attachment	A
902-905	ARC CART, Angled equipment shelf, for ARC PLUS / SHE SHA	A
902-906	ARC CART, Drawer with cover	A
902-908	ARC CART, Closed gas cylinder attachment	A
902-909	ARC CART, Additional drawer	A
902-911	ARC CART, Connector PE-line	A
902-912	ARC CART, Filing basket, front side	A
902-913	ARC CART, Single gas cylinder attachment	A
902-914	ARC CART, Single gas cylinder attachment, closed	A
902-915	ARC CART, Replacement strap for gas cylinder attachment (5 pcs.)	A
902-917	ARC CART, Holder for single-pedal foot switch	A
902-918	ARC CART, Cable and footswitch holder for standard rail	A
902-919	ARC CART, Standard rail	A
902-920	ARC CART, Angled equipment shelf, for SHE SHA (REF 950-001)	A
902-921	ARC CART, handle	A
902-922	ARC CART, Securing kit	A
902-923	ARC CART, handle rear side	A
932-900	Rinsing adapter for flexible Argon probes, with round plug	A
932-910	Rinsing adapter for flexible Argon probes (5 pcs.)	A

CoO (Country of Origin) = A (Germany)

Approval: Gomaringen / Germany, 2017-03-20

BOWA-electronic GmbH & Co.KG

Wolf-Ruediger Fritz
Manager Regulatory Affairs
wolf-ruediger.fritz@bowa.de



Product Service

EC Certificate

Full Quality Assurance System

Directive 93/42/EEC on Medical Devices (MDD), Annex II excluding (4)
(Devices in Class IIa, IIb or III)

No. G1 17 02 16316 019

Manufacturer: **BOWA-electronic GmbH & Co. KG**
Heinrich-Hertz-Strasse 4-10
72810 Gomaringen
GERMANY



Facility(ies): BOWA-electronic GmbH & Co. KG
Heinrich-Hertz-Strasse 4-10, 72810 Gomaringen, GERMANY

Product Category(ies): **Electrosurgical Unit and accessories**
Argon Coagulation Unit and accessories
Electrode handles
Active electrodes and instruments
monopolar and bipolar forceps
endoscopic and laparoscopic instruments
instruments for vessel sealing
neutral electrodes
bipolar scissors

The Certification Body of TÜV SÜD Product Service GmbH declares that the aforementioned manufacturer has implemented a quality assurance system for design, manufacture and final inspection of the respective devices / device categories in accordance with MDD Annex II. This quality assurance system conforms to the requirements of this Directive and is subject to periodical surveillance. For marketing of class III devices an additional Annex II (4) certificate is mandatory. See also notes overleaf.

Report No.: 713102471

Valid from: 2017-03-09
Valid until: 2022-03-08

Date, 2017-03-08

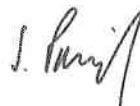
Stefan Preiß



TÜV SÜD Product Service GmbH is Notified Body with identification no. 0123

Page 1 of 1

Zertifizierungsvertrag

Grundlage für die Zertifikatserteilung ist die Prüf- und Zertifizierungsordnung von TÜV SÜD Product Service.

Mit Erhalt des Zertifikates erkennt der Zertifikatsinhaber die jeweils gültige Fassung der Prüf- und Zertifizierungsordnung an (www.tuev-sued.de/ps_regulations) und wird somit Partner im Zertifiziersystem von TÜV SÜD Product Service.

Prinzipielle Voraussetzung für die Gültigkeit des Zertifikates:

- Gültigkeit der zitierten normativen Prüfgrundlage(n) ist gegeben
- und zusätzlich bei Zertifikaten mit Berechtigung zur Verwendung eines Prüfzeichens bzw. bei Zertifikaten für QM-Systeme:
- Voraussetzungen für vorschriftsmäßige Fertigung werden eingehalten.
- Die Fertigungs- bzw. Betriebsstätten werden regelmäßig überwacht.

Certification contract

Certification is based on the TÜV SÜD Product Service Testing and Certification Regulations.

On receipt of the certificate the certificate holder agrees to the current version of the Testing and Certification Regulations (www.tuev-sued.de/ps_regulations) and thus becomes partner in the TÜV SÜD Product Service Certification System.

Requirements for the validity of the certificate in principle:

- Validity of the quoted test standard(s)
- In addition for certificates with the right to use a certification mark and for QM certificates:
- Conditions for an adequate manufacturing are maintained
- Regular surveillance of the facility is performed

Akkreditierungen / Benennungen (Status 14.10.2013) /
Accreditations / notifications (as of 2013-10-14)

Deutschland / Germany

Produktsicherheitsgesetz (ProdSG) /
Product Safety Act (ProdSG)

Europa / Europe

- Niederspannungsrichtlinie 2006/95/EG
- Spielzeugrichtlinie 2009/48/EG
- Richtlinie für aktive medizinische Implantate 90/385/EWG
- Richtlinie für Medizinprodukte 93/42/EWG
- Richtlinie für In-vitro-Diagnostika 98/79/EG
- Richtlinie für Gasverbrauchseinrichtungen 2009/142/EG
- Richtlinie für persönliche Schutzausrüstungen 89/686/EWG
- EMV-Richtlinie 2004/108/EG
- Richtlinie für Sportboote 94/25/EG + 2003/44/EG
- Richtlinie für Maschinen 2006/42/EG
- Richtlinie für Ex-Schutz Geräte 94/9/EG

- Low Voltage Directive 2006/95/EC
- Toys Directive 2009/48/EC
- Directive for Active Implantable Medical Devices 90/385/EEC
- Directive for Medical Devices 93/42/EEC
- Directive on In Vitro Diagnostic Medical Devices 98/79/EC
- Directive for Gas Appliances 2009/142/EC
- Directive for Personal Protective Equipment 89/686/EEC
- EMC Directive 2004/108/EC
- Directive for Recreational Craft 94/25/EC + 2003/44/EC
- Directive for Machinery 2006/42/EC
- Directive for Ex Safe Equipment 94/9/EC

- ENEC Agreement for luminaires, household and IT equipment

USA

- Nationally Recognized Testing Laboratory (NRTL) to 29 CFR 1910.7 by OSHA
- Accredited for FDA 510(k) Third Party Review
- Conformity Assessment Body to the MRA for Medical Devices; FDA QSR Reg Inspections, FDA 510(k) Third Party Review

Asien-Pazifik Region / Asia Pacific

- Recognized Certification Body to Electrical Products (Safety) Regulation; Hong Kong
- Konformitätsbewertungsstelle / Conformity Assessment Body to the MRA for Medical Devices; Australien / Australia
- Konformitätsbewertungsstelle / Conformity Assessment Body to the MRA for Medical Devices; Neuseeland / New Zealand

Weltweit / Worldwide

- NCB im CB-Scheme des IECEE /
NCB in the CB Scheme of IECEE
- ExCB im IECEX-Scheme des IECEE /
ExCB in the IECEX Scheme of IECEE
- Zertifizierstellen durch DAkkS akkreditiert
DE-ZE-11321-01, DE-ZM-11321-09 und DE-ZM-11321-01.
Certification Bodies accredited by DAkkS
DE-ZE-11321-01, DE-ZM-11321-09 and DE-ZM-11321-01.

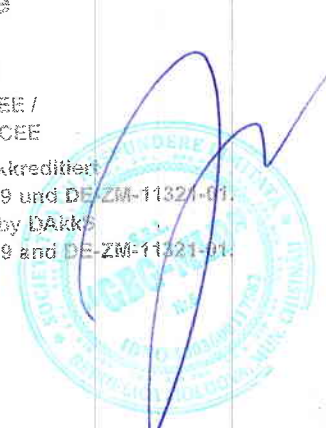

EC DECLARATION OF CONFORMITY

BOWA-electronic GmbH & Co. KG
Heinrich-Hertz Strasse 4-10
72810 Gomaringen / Germany

We hereby declare in sole responsibility that the medical devices listed on the following pages are conform with the essential requirements of the following standard:

Medical Device Directive (Council Directive 93/42/EEC of 14 June 1993)

with applied standards:

EN ISO 14971 / EN 60601-1 / EN 60601-2-2 / EN ISO 10993-1 / EN ISO 13485 / DIN EN 1041

CE Marking

Class I	according to annex VII	CE
Class Is	according to annex II	CE 0123
Class Ila	according to annex II	CE 0123
Class I Ib	according to annex II	CE 0123

Notified Body

TÜV Product Service
Ridlerstr. 65, D-80339 München
Nr. 0123

The declaration of conformity is valid until: 08.03.2022

Gomaringen, 08.03.2017

Quality Management /
Regulatory Affairs

(Wolf-Rüdiger Fritz)



REF	Product description	Class	Rule	UMDNS	GMDN
040-400	Generator trunk, for BOWA ARC (without generator)	IIb	9	15-895	44683
040-401	ARC 400 Starter Set	IIb	9	15-895	44683
040-402	Argon trunk for ARC PLUS (without argon unit)	IIb	9	15-895	44683
050-240	COMFORT BOX (4 mm)	IIb	9	15-895	44683
050-241	COMFORT BOX (2.4 mm)	IIb	9	15-895	44683
050-242	COMFORT BOX	IIb	9	15-895	44683
100-016	Electrode handle, without switches, shaft 4 mm, for Erbe-T, 4.5 m	IIa	6	11-494	44677
101-000	Bipolar cable, E.U. forceps, for Erbe, 4 m	I	1	11-493	35042
101-003	Cable, rubber return plate, for Erbe, 4.5 m	I	1	11-493	35042
101-040	Bipolar cable, BOWA forceps, for Erbe, 4 m	I	1	11-493	35042
101-045	Bipolar cable, U.S. forceps, for Erbe, 4 m	I	1	11-493	35042
101-051	Monopolar cable, 4 mm socket, for Erbe, 4.5 m	I	1	11-493	35042
101-060	Monopolar cable, arthroscopy and LAP electrode, for Erbe, 4.5 m	I	1	11-493	35042
101-140	Bipolar cable, BOWA forceps, COMFORT, 4.5 m	I	1	11-493	35042
101-145	Monopolar cable, ErgoLAP, for Erbe, 4.5 m	I	1	11-493	35042
101-150	Cable, single-use return plate, for ALSA, Eschmann, 4.5 m	I	1	11-493	35042
101-245	Cable, ErgoLAP BIPOLAR, for Erbe, 4.5 m	I	1	11-493	35042
104-045	ErgoPEN slim, 2 switches, shaft 4 mm, for Erbe, cable 4.5 m	IIb	9	11-494	44680
105-045	ErgoPEN slim, 2 switches, shaft 2.4 mm, for Erbe, cable 4.5 m	IIb	9	11-494	44680
106-045	Monopolar cable, 2 mm socket, for Erbe, 4.5 m	I	1	11-493	35042
106-145	Monopolar cable, resectoscope Wolf/Storz, COMFORT, 4.5 m	I	1	11-493	35042
106-245	Monopolar cable, Storz resectoscope, COMFORT, 4.5 m	I	1	11-493	35042
106-345	Monopolar cable, resectoscope Olympus, COMFORT, 4.5 m	I	1	11-493	35042
110-045	ErgoPEN large, 2 switches, shaft 4 mm, for Erbe, cable 4.5 m	IIb	9	11-494	44680
111-000	Adapter bipolar, 3-pin instrument, for Erbe	I	1	16-490	35041
111-001	Adapter monopolar, 2 - 4 mm instrument, for Erbe, footswitched	I	1	16-490	35041
112-045	ErgoPEN large, 2 switches, shaft 4 mm, for Erbe-T, cable 4.5 m	IIb	9	11-494	44680
120-045	JackKNIFE, 2 switches, shaft 2.4 mm, for Erbe, cable 4.5 m	IIb	9	11-494	44680
120-145	JackKNIFE, 2 switches, shaft 4 mm, for Erbe, cable 4.5 m	IIb	9	11-494	44680
131-045	Monopolar cable, endoscopy 2.8 mm socket, for Erbe, 4.5 m	I	1	11-493	35042
131-145	Monopolar cable, endoscopy 2.8 mm socket, COMFORT, 4.5 m	I	1	11-493	35042
132-045	Monopolar cable, endoscopy 4 mm socket, for Erbe, 4.5 m	I	1	11-493	35042
193-008	Rubber return plate, adults, 250 x 150 mm, for Erbe	I	1	11-500	42551
193-016	Rubber return plate, children, 150 x 80 mm, for Erbe	I	1	11-500	42551
194-000	Fixation button for rubber band	I	1	11-429	35709
194-050	Rubber band with fixation button, 50 cm	I	1	11-429	35709
194-075	Rubber band with fixation button, 75 cm	I	1	11-429	35709
194-100	Rubber band with fixation button, 100 cm	I	1	11-429	35709
210-030	Electrode handle, without switches, shaft 4 mm, for Martin, cable 4.5 m	IIa	6	11-494	44677
214-045	ErgoPEN slim, 2 switches, shaft 4 mm, for Martin, cable 4.5 m	IIb	9	11-494	44680
215-045	ErgoPEN slim, 2 switches, shaft 4 mm, for 3-pin, cable 4.5 m	IIb	9	11-494	44680
215-145	ErgoPEN slim, 2 switches, shaft 4 mm, COMFORT, cable 4.5 m	IIb	9	11-494	44680
218-045	ErgoPEN slim, 2 switches, shaft 2.4 mm, for 3-pin, cable 4.5 m	IIb	9	11-494	44680
218-145	ErgoPEN slim, 2 switches, shaft 2.4 mm, COMFORT, cable 4.5 m	IIb	9	11-494	44680
219-030	Electrode handle, without switches, shaft 2.4 mm, Martin, cable 4.5 m	IIa	6	11-494	44677

REF	Product description	Class	Rule	UMDNS	GMDN
220-045	JackKNIFE, 2 switches, shaft 2.4 mm, for 3-pin, cable 4.5 m	IIb	9	11-494	44680
220-145	JackKNIFE, 2 switches, shaft 4 mm, for 3-pin, cable 4.5 m	IIb	9	11-494	44680
220-245	JackKNIFE, 2 switches, shaft 4 mm, for Martin, cable 4.5 m	IIb	9	11-494	44680
220-345	JackKNIFE ARC 100, shaft 2.4 mm with cable for bipolar forceps 4 m	IIb	9	11-494	44680
222-000	Adapter monopolar, 3-pin, for Martin	I	1	16-490	35041
227-045	ErgoPEN large, 2 switches, shaft 4 mm, for Martin, cable 4.5 m	IIb	9	11-494	44680
232-003	Rubber return plate, children, 150 x 80 mm, international	I	1	11-500	42551
242-003	Rubber return plate, adults, 250 x 150 mm, international	I	1	11-500	42551
270-145	Cable, ErgoLAP MONOPOLAR, for Martin, 4.5 m	I	1	11-493	35042
280-031	Monopolar cable, U.K., for 4 mm, 4.5 m	I	1	11-493	35042
280-035	Monopolar cable, arthroscopy and LAP electrode, for 4 mm, 4.5 m	I	1	11-493	35042
280-050	Monopolar cable, 4 mm socket, for 4 mm, 4.5 m	I	1	11-493	35042
285-050	Monopolar cable, for Martin handles, 4.5 m	I	1	11-493	35042
287-040	Bipolar cable, BOWA forceps, for Martin, 4.5 m	I	1	11-493	35042
287-045	Bipolar cable, U.S. forceps, for Martin, 4.5 m	I	1	11-493	35042
287-050	Bipolar cable, E.U. forceps, for Martin, 4.5 m	I	1	11-493	35042
287-245	Cable, ErgoLAP BIPOLAR, for Martin, 4.5 m	I	1	11-493	35042
294-050	Cable, single-use return plate, for Erbe, 4.5 m	I	1	11-493	35042
295-050	Cable, rubber return plate, for Martin, 4.5 m	I	1	11-493	35042
322-045	ErgoPEN large, 2 switches, shaft 4 mm, for 3-pin, cable 4.5 m	IIb	9	11-494	44680
327-045	ErgoPEN large, 2 switches, shaft 2.4 mm, for 3-pin, cable 4.5 m	IIb	9	11-494	44680
330-030	Electrode handle, without switches, shaft 4 mm, for 8 mm, cable 4.5 m	IIa	6	11-494	44677
331-045	Monopolar cable, endoscopy 2.8 mm, for 8 mm Bovie, 4.5 m	I	1	11-493	35042
332-045	Monopolar cable, endoscopy 4 mm socket, for 8 mm Bovie, 4.5 m	I	1	11-493	35042
333-001	Adapter monopolar, 2 - 4 mm instrument, for 8 mm Bovie	I	1	16-490	35041
335-030	Electrode handle, without switches, shaft 2.4 mm, 8mm Bovie, cable 4.5 m	IIa	6	11-494	44677
340-000	Adapter bipolar, 2-pin 28 mm, for Erbe	I	1	16-490	35041
350-245	Cable, ErgoLAP BIPOLAR, for 2-pin 22 mm, 4.5 m	I	1	11-493	35042
351-040	Bipolar cable, BOWA forceps, for 2-pin 28 mm, 4.5 m	I	1	11-493	35042
351-045	Bipolar cable, U.S. forceps, for 2-pin 28 mm, 4.5 m	I	1	11-493	35042
351-051	Bipolar cable, E.U. forceps, for 2-pin 28 mm, 4.5 m	I	1	11-493	35042
351-245	Cable, ErgoLAP BIPOLAR, for 2-pin 28 mm, 4.5 m	I	1	11-493	35042
351-345	Cable, ErgoLAP BIPOLAR, COMFORT, 4.5 m	I	1	11-493	35042
352-145	Bipolar cable, Storz resectoscope, COMFORT, 4.5 m	I	1	11-493	35042
353-040	Bipolar cable, BOWA forceps, for 2-pin 22 mm, 4.5 m	I	1	11-493	35042
353-045	Bipolar cable, U.S. forceps, for 2-pin 22 mm, 4.5 m	I	1	11-493	35042
353-050	Bipolar cable, E.U. forceps, for 2-pin 22 mm, 4.5 m	I	1	11-493	35042
354-145	Bipolar cable, Wolf resectoscope, COMFORT, 4.5 m	I	1	11-493	35042
355-030	Bipolar cable, E.U. forceps, for Valleylab, 3 m	I	1	11-493	35042
355-031	Bipolar cable, BOWA forceps, for Valleylab, 3 m	I	1	11-493	35042
355-145	Bipolar cable, Olympus resectoscope, COMFORT, 4.5 m	I	1	11-493	35042
358-145	Cable, NightKNIFE / LIGATOR, COMFORT, 4.5 m	I	1	11-493	35042
360-050	Monopolar cable, 4 mm socket, for 8 mm Bovie, 4.5 m	I	1	11-493	35042
360-145	Cable, ErgoLAP MONOPOLAR, for 8 mm Bovie, 4.5 m	I	1	11-493	35042
360-245	Cable, ErgoLAP MONOPOLAR, COMFORT, 4.5 m	I	1	11-493	35042

REF	Product description	Class	Rule	UMDNS	GMDN
365-030	Monopolar cable, U.K., for 8 mm Bovie, 4,5 m	I	1	11-493	35042
370-050	Monopolar cable, arthroscopy and LAP electrode, for 8 mm, 4,5 m	I	1	11-493	35042
375-045	Monopolar cable, 2 mm socket, for 8 mm Bovie, 4,5 m	I	1	11-493	35042
378-045	Cable, BiZZER / TissueSeal, 4,5 m	I	1	11-493	35042
378-145	Cable, BiZZER, for Erbe, 4,5 m	I	1	11-493	35042
378-245	Cable, BiZZER, for Martin, 4,5 m	I	1	11-493	35042
380-050	Cable, single-use return plate, international, 4,5 m	I	1	11-493	35042
385-050	Cable, rubber return plate, international, 4,5 m	I	1	11-493	35042
386-050	Cable, single-use return plate, international (NON-REM), 4,5 m	I	1	11-493	35042
401-051	Cable, bipolar scissors, for 2-pin 28 mm, 4,5 m	I	1	11-493	35042
401-052	Cable, bipolar scissors, for Erbe, 4,5 m	I	1	11-493	35042
401-053	Cable, bipolar scissors, for Martin, 4,5 m	I	1	11-493	35042
405-045	Monopolar cable, 2 mm socket, for 4 mm, 4,5 m	I	1	11-493	35042
431-045	Monopolar cable, endoscopy, 2,8 mm socket, for 4 mm, 4,5 m	I	1	11-493	35042
432-045	Monopolar cable, endoscopy, 4 mm socket, for 4 mm, 4,5 m	I	1	11-493	35042
480-145	Cable, ErgoLAP MONOPOLAR, for 4 mm, 4,5 m	I	1	11-493	35042
500-000	Electrode container, 12 standard electrodes, shaft 4 mm	IIb	9	15-895	44683
500-007	Knife electrode, straight, shaft 4 mm (5 pcs.)	IIb	9	11-499	44683
500-008	Knife electrode, angled, rhombic, shaft 4 mm (5 pcs.)	IIb	9	11-499	44683
500-009	Knife electrode, straight, rhombic, shaft 4 mm (5 pcs.)	IIb	9	11-499	44683
500-011	Needle electrode, straight, shaft 4 mm (5 pcs.)	IIb	9	11-499	44683
500-014	Wire loop electrode, Ø 5 mm, shaft 4 mm (5 pcs.)	IIb	9	11-499	44683
500-015	Wire loop electrode, Ø 10 mm, shaft 4 mm (5 pcs.)	IIb	9	11-499	44683
500-016	Wire loop electrode, Ø 14 mm, shaft 4 mm (5 pcs.)	IIb	9	11-499	44683
500-017	Ribbon loop electrode, Ø 10 mm, shaft 4 mm (5 pcs.)	IIb	9	11-499	44683
500-018	Ribbon loop electrode, Ø 17 mm, shaft 4 mm (5 pcs.)	IIb	9	11-499	44683
500-019	Ball electrode, straight, Ø 1.5 mm, shaft 4 mm (5 pcs.)	IIb	9	11-499	44683
500-020	Ball electrode, straight, Ø 2 mm, shaft 4 mm (5 pcs.)	IIb	9	11-499	44683
500-021	Ball electrode, straight, Ø 4 mm, shaft 4 mm (5 pcs.)	IIb	9	11-499	44683
500-022	Ball electrode, straight, Ø 6 mm, shaft 4 mm (5 pcs.)	IIb	9	11-499	44683
500-023	Plate electrode, 8 x 10 mm, shaft 4 mm	IIb	9	11-499	44683
500-024	Plate electrode, straight, 10 x 15 mm, shaft 4 mm	IIb	9	11-499	44683
500-112	Micro needle electrode, tungsten wire, straight, shaft 4 mm	IIb	9	11-499	44683
500-113	Micro needle electrode, tungsten wire, angled, shaft 4 mm	IIb	9	11-499	44683
500-124	Needle electrode, 45° angled, shaft 4 mm (5 pcs.)	IIb	9	11-499	44683
500-125	Lancet electrode, angled, shaft 4 mm (5 pcs.)	IIb	9	11-499	44683
500-126	Lancet electrode, straight, shaft 4 mm (5 pcs.)	IIb	9	11-499	44683
500-127	Knife electrode, thin, straight, shaft 4 mm (5 pcs.)	IIb	9	11-499	44683
500-129	Ball electrode, angled, Ø 1.5 mm, shaft 4 mm (5 pcs.)	IIb	9	11-499	44683
500-130	Ball electrode, angled, Ø 2 mm, shaft 4 mm (5 pcs.)	IIb	9	11-499	44683
500-131	Ball electrode, angled, Ø 4 mm, shaft 4 mm (5 pcs.)	IIb	9	11-499	44683
500-150	Electrode extension, 172 mm, shaft 4 mm	IIb	9	11-499	44683
510-108	Needle electrode, arthroscopy, 90° angled, 1,5 x 0,8 mm	IIb	9	16-206	44683
510-109	Needle electrode, arthroscopy, 90° angled, 4 x 0,8 mm	IIb	9	16-206	44683
510-110	Knife electrode, arthroscopy, 45° angled, 3 x 1,5 mm	IIb	9	16-206	44683

REF	Product description	Class	Rule	UMDNS	GMDN
510-112	Keying electrode, arthroscopy, 90 ° angled, 3 x 1.5 mm	IIb	9	16-206	44683
520-027	Needle electrode, straight, 136 mm, insulated shaft 4 mm	IIb	9	11-499	44683
520-028	Knife electrode, straight, 154 mm, insulated shaft 4 mm	IIb	9	11-499	44683
520-029	Ball electrode, straight, Ø 4 mm, 122 mm, insulated shaft 4 mm	IIb	9	11-499	44683
520-030	Ball electrode, straight, Ø 6 mm, 124 mm, insulated shaft 4 mm	IIb	9	11-499	44683
520-031	Wire loop electrode, straight, Ø 5 mm, 123 mm, insulated shaft 4 mm	IIb	9	11-499	44683
520-032	Wire loop electrode, straight, Ø 10 mm, 128 mm, insulated shaft 4 mm	IIb	9	11-499	44683
520-035	Ball electrode, angled, Ø 6 mm, 124 mm, insulated shaft 4 mm	IIb	9	11-499	44683
520-110	MetraLOOP set	IIb	9	11-499	44683
520-113	MetraLOOP, inner shaft	IIb	9	11-499	44683
520-114	MetraLOOP, outer shaft	IIb	9	11-499	44683
520-115	MetraLOOP set, COMFORT	IIb	9	11-499	44683
520-116	MetraLOOP, COMFORT, inner shaft	IIb	9	11-499	44683
520-117	MetraLOOP, spare loops, Ø 100 mm, single use, sterile (10 pcs.)	IIb	9	11-499	44684
520-118	MetraLOOP, spare loops, Ø 175 mm, single use, sterile (10 pcs.)	IIb	9	11-499	44684
520-122	Needle electrode, angled, 132 mm, insulated shaft 4 mm	IIb	9	11-499	44683
520-123	Knife electrode, angled, rhombic, 142 mm, insulated shaft 4 mm	IIb	9	11-499	44683
520-124	Knife electrode, straight, rhombic, 142 mm, insulated shaft 4 mm	IIb	9	11-499	44683
520-132	Loop electrode, 20 x 20 mm, 138 mm, insulated shaft 4 mm	IIb	9	11-499	44683
520-133	Loop electrode, 20 x 15 mm, 133 mm, insulated shaft 4 mm	IIb	9	11-499	44683
520-134	Loop electrode, 10 x 10 mm, 128 mm, insulated shaft 4 mm	IIb	9	11-499	44683
520-135	Loop electrode, 15 x 15 mm, 133 mm, insulated shaft 4 mm	IIb	9	11-499	44683
520-136	Loop electrode, 25 x 25 mm, 143 mm, insulated shaft 4 mm	IIb	9	11-499	44683
530-000	Electrode container, 12 standard electrodes, shaft 2.4 mm	IIb	9	15-895	44683
530-008	Knife electrode, angled, rhombic, shaft 2.4 mm (5 pcs.)	IIb	9	11-499	44683
530-009	Knife electrode, straight, rhombic, shaft 2.4 mm (5 pcs.)	IIb	9	11-499	44683
530-012	Micro needle electrode, tungsten wire, straight, shaft 2.4 mm	IIb	9	11-499	44683
530-013	Micro needle electrode, tungsten wire, angled, shaft 2.4 mm	IIb	9	11-499	44683
530-014	Wire loop electrode, Ø 5 mm, shaft 2.4 mm (5 pcs.)	IIb	9	11-499	44683
530-015	Wire loop electrode, Ø 10 mm, shaft 2.4 mm (5 pcs.)	IIb	9	11-499	44683
530-016	Wire loop electrode, Ø 14 mm, shaft 2.4 mm (5 pcs.)	IIb	9	11-499	44683
530-017	Ribbon loop electrode, Ø 10 mm, shaft 2.4 mm (5 pcs.)	IIb	9	11-499	44683
530-020	Ball electrode, straight, Ø 2 mm, shaft 2.4 mm (5 pcs.)	IIb	9	11-499	44683
530-021	Ball electrode, straight, Ø 4 mm, shaft 2.4 mm (5 pcs.)	IIb	9	11-499	44683
530-022	Ball electrode, straight, Ø 6 mm, shaft 2.4 mm (5 pcs.)	IIb	9	11-499	44683
530-027	Needle electrode, straight, 140 mm, insulated shaft 2.4 mm	IIb	9	11-499	44683
530-028	Knife electrode, straight, 152 mm, insulated shaft 2.4 mm	IIb	9	11-499	44683
530-029	Ball electrode, Ø 4 mm, 126 mm, insulated shaft 2.4 mm	IIb	9	11-499	44683
530-030	Ball electrode, Ø 6 mm, 128 mm, insulated shaft 2.4 mm	IIb	9	11-499	44683
530-032	Wire loop electrode, Ø 10 mm, 132 mm, insulated shaft 2.4 mm	IIb	9	11-499	44683
530-035	Ball electrode, d=6 mm, angled, 128 mm, insulated shaft 2.4 mm	IIb	9	11-499	44683
530-070	Electrode extension, 105 mm, shaft 2.4 mm	IIb	9	11-499	44683
530-122	Needle electrode, angled, 136 mm, insulated shaft 2.4 mm	IIb	9	11-499	44683
530-123	Knife electrode, angled, rhombic, 146 mm, insulated shaft 2.4 mm	IIb	9	11-499	44683
530-124	Needle electrode, angled, shaft 2.4 mm (5 pcs.)	IIb	9	11-499	44683

REF	Product description	Class	Rule	UMDNS	GMDN
530-125	Lancet electrode, angled, shaft 2.4 mm (5 pcs.)	IIb	9	11-499	44683
530-126	Lancet electrode, straight, shaft 2.4 mm (5 pcs.)	IIb	9	11-499	44683
530-127	Knife electrode, thin, straight, shaft 2.4 mm (5 pcs.)	IIb	9	11-499	44683
530-130	Ball electrode, Ø 2 mm, angled, shaft 2.4 mm (5 pcs.)	IIb	9	11-499	44683
530-132	Loop electrode, 20 x 20 mm, 142 mm, insulated shaft 2.4 mm	IIb	9	11-499	44683
530-133	Loop electrode, 20 x 15 mm, 137 mm, insulated shaft 2.4 mm	IIb	9	11-499	44683
530-134	Loop electrode, 10 x 10 mm, 132 mm, insulated shaft 2.4 mm	IIb	9	11-499	44683
530-135	Loop electrode, 15 x 15 mm, 137 mm, insulated shaft 2,4 mm	IIb	9	11-499	44683
530-136	Loop electrode, 25 x 25 mm, 147 mm, insulated shaft 2,4 mm	IIb	9	11-499	44683
530-150	Electrode extension, 175 mm, shaft 2.4 mm	IIb	9	11-499	44683
530-207	Knife electrode, straight, shaft 2.4 mm (5 pcs.)	IIb	9	11-499	44683
530-211	Needle electrode, straight, shaft 2.4 mm (5 pcs.)	IIb	9	11-499	44683
530-224	Knife electrode, rhombic, 146 mm, insulated shaft 2.4 mm	IIb	9	11-499	44683
530-225	Needle electrode ENT, angled, 124 mm, insulated shaft 2.4 mm	IIb	9	11-499	44683
605-001	Bipolar forceps, angled, 195 mm, 8 mm x 1 mm	IIb	9	11-502	44683
605-002	Bipolar forceps, bayonet, 195 mm, 6 mm x 1 mm	IIb	9	11-502	44683
605-007	Bipolar forceps, angled, 195 mm, 8 mm x 2 mm	IIb	9	11-502	44683
605-011	Bipolar forceps, straight, 160 mm, 6 mm x needle	IIb	9	11-502	44683
605-013	Bipolar forceps, angled, 160 mm, 6 mm x 0.5 mm	IIb	9	11-502	44683
605-014	Bipolar forceps, angled, 160 mm, 6 mm x 1 mm	IIb	9	11-502	44683
605-018	Bipolar forceps, bayonet, 165 mm, 6 mm x 1 mm	IIb	9	11-502	44683
605-019	Bipolar forceps, straight, 110 mm, 6 mm x needle	IIb	9	11-502	44683
605-020	Bipolar forceps, straight, 110 mm, 6 mm x 0.5 mm	IIb	9	11-502	44683
605-021	Bipolar forceps, angled, 110 mm, 6 mm x 0.5 mm	IIb	9	11-502	44683
605-023	Bipolar forceps, angled, 110 mm, 6 mm x needle	IIb	9	11-502	44683
605-024	Bipolar forceps, angled, 220 mm, 8 mm x 1 mm	IIb	9	11-502	44683
605-027	Bipolar forceps, straight, 160 mm, 8 mm x 2 mm	IIb	9	11-502	44683
605-029	Bipolar forceps, straight, 195 mm, 8 mm x 2 mm	IIb	9	11-502	44683
605-030	Bipolar forceps, straight, 220 mm, 8 mm x 2 mm	IIb	9	11-502	44683
605-031	Bipolar forceps, bayonet, 220 mm, 6 mm x 0.5 mm	IIb	9	11-502	44683
605-033	Bipolar forceps, bayonet, 165 mm, 6 mm x 0.5 mm	IIb	9	11-502	44683
605-034	Bipolar forceps, bayonet, 195 mm, 8 mm x 2 mm	IIb	9	11-502	44683
605-036	Bipolar forceps, angled, 160 mm, 6 mm x needle	IIb	9	11-502	44683
605-039	Bipolar forceps, straight, 160 mm, 8 mm x 1 mm	IIb	9	11-502	44683
605-040	Bipolar forceps, straight, 195 mm, 8 mm x 1 mm	IIb	9	11-502	44683
605-041	Bipolar forceps, straight, 220 mm, 8 mm x 1 mm	IIb	9	11-502	44683
605-057	Bipolar forceps, straight, 195 mm, 8 mm x 2 mm, square ruffle	IIb	9	11-502	44683
605-058	Bipolar forceps, angled, 195 mm, 8 mm x 2 mm, square ruffle	IIb	9	11-502	44683
605-059	Bipolar forceps, bayonet, 195 mm, 8 mm x 2 mm, square ruffle	IIb	9	11-502	44683
605-063	Bipolar forceps, bayonet, angled, 220 mm, 6 mm x 1 mm	IIb	9	11-502	44683
605-070	Bipolar forceps, straight, 300 mm, 8 mm x 2 mm	IIb	9	11-502	44683
605-080	Bipolar forceps, straight, 270 mm, 8 mm x 2 mm	IIb	9	11-502	44683
607-001	Bipolar forceps, NON-Stick-Gold, angled, 195 mm, 8 mm x 1 mm	IIb	9	11-502	44683
607-002	Bipolar forceps, NON-Stick-Gold, bayonet, 195 mm, 6 mm x 1 mm	IIb	9	11-502	44683
607-007	Bipolar forceps, NON-Stick-Gold, angled, 195 mm, 8 mm x 2 mm	IIb	9	11-502	44683

REF	Product description	Class	Rule	UMDNS	GMDN
607-014	Bipolar forceps, NON-Stick-Gold, angled, 160 mm, 6 mm x 1 mm	IIb	9	11-502	44683
607-020	Bipolar forceps, NON-Stick-Gold, straight, 110 mm, 6 mm x 0.5 mm	IIb	9	11-502	44683
607-021	Bipolar forceps, NON-Stick-Gold, angled, 110 mm, 6 mm x 0.5 mm	IIb	9	11-502	44683
607-027	Bipolar forceps, NON-Stick-Gold, straight, 160 mm, 8 mm x 2 mm	IIb	9	11-502	44683
607-029	Bipolar forceps, NON-Stick-Gold, straight, 195 mm, 8 mm x 2 mm	IIb	9	11-502	44683
607-030	Bipolar forceps, NON-Stick-Gold, straight, 220 mm, 8 mm x 2 mm	IIb	9	11-502	44683
607-039	Bipolar forceps, NON-Stick-Gold, straight, 160 mm, 8 mm x 1 mm	IIb	9	11-502	44683
607-040	Bipolar forceps, NON-Stick-Gold, straight, 195 mm, 8 mm x 1 mm	IIb	9	11-502	44683
607-080	Bipolar forceps, NON-Stick-Gold, straight, 270 mm, 8 mm x 2 mm	IIb	9	11-502	44683
607-100	Bipo. forceps, NON-Stick-Gold, bayonet, 160 mm, 0,3 mm	IIb	9	11-502	44683
607-101	Bipolar forceps, NON-Stick-Gold, bayonet, 180 mm, 0,3 mm	IIb	9	11-502	44683
607-102	Bipolar forceps, NON-Stick-Gold, bayonet, 200 mm, 0,3 mm	IIb	9	11-502	44683
607-103	Bipolar forceps, NON-Stick-Gold, bayonet, 220 mm, 0,3 mm	IIb	9	11-502	44683
607-105	Bipo. forceps, NON-Stick-Gold, bayonet, 160 mm, 0,6 mm	IIb	9	11-502	44683
607-106	Bipo. forceps, NON-Stick-Gold, bayonet, 180 mm, 0,6 mm	IIb	9	11-502	44683
607-107	Bipo. forceps, NON-Stick-Gold, bayonet, 200 mm, 0,6 mm	IIb	9	11-502	44683
607-108	Bipo. forceps, NON-Stick-Gold, bayonet, 220 mm, 0,6 mm	IIb	9	11-502	44683
607-110	Bipolar forceps, NON-Stick-Gold, bayonet, 180 mm, 1,0 mm	IIb	9	11-502	44683
607-111	Bipolar forceps, NON-Stick-Gold, bayonet, 200 mm, 1,0 mm	IIb	9	11-502	44683
607-112	Bipo. forceps, NON-Stick-Gold, bayonet, 220 mm, 1 mm	IIb	9	11-502	44683
607-113	Bipo. forceps, NON-Stick-Gold, bayonet, 240 mm, 1 mm	IIb	9	11-502	44683
607-115	Bipo. forceps, NON-Stick-Gold, bayonet, 200 mm, 2 mm	IIb	9	11-502	44683
607-116	Bipo. forceps, NON-Stick-Gold, bayonet, 220 mm, 2 mm	IIb	9	11-502	44683
607-120	Bipo. forceps, NON-Stick-Gold, bayonet, angled up, 200 mm, 1 mm	IIb	9	11-502	44683
607-121	Bipo. forceps, NON-Stick-Gold, bayonet, angled up, 220 mm, 1 mm	IIb	9	11-502	44683
607-122	Bipo. forceps, NON-Stick-Gold, bayonet, angled down, 200 mm, 1 mm	IIb	9	11-502	44683
607-123	Bipo. forceps, NON-Stick-Gold, bayonet, angled down, 220 mm, 1 mm	IIb	9	11-502	44683
607-130	Bipolar forceps, NON-Stick-Gold, straight, 220 mm, 0,3 mm	IIb	9	11-502	44683
607-140	Bipo. forceps, NON-Stick-Gold, round handle, bayonet, 180 mm, 0,3 mm	IIb	9	11-502	44683
607-141	Bipo. forceps, NON-Stick-Gold, round handle, bayonet, 200 mm, 0,3 mm	IIb	9	11-502	44683
607-145	Bipo. forceps, NON-Stick-Gold, round handle, bayonet, 180 mm, 0,6 mm	IIb	9	11-502	44683
607-146	Bipo. forceps, NON-Stick-Gold, round handle, bayonet, 200 mm, 0,6 mm	IIb	9	11-502	44683
607-147	Bipo. forceps, NON-Stick-Gold, round handle, bayonet, 225 mm, 0,6 mm	IIb	9	11-502	44683
607-150	Bipo. forceps, NON-Stick-Gold, round handle, bayonet, 180 mm, 1 mm	IIb	9	11-502	44683
607-151	Bipo. forceps, NON-Stick-Gold, round handle, bayonet, 200 mm, 1 mm	IIb	9	11-502	44683
607-152	Bipo. forceps, NON-Stick-Gold, round handle, bayonet, 225 mm, 1 mm	IIb	9	11-502	44683
607-153	Bipo. forceps, NON-Stick-Gold, round handle, bayonet, 250 mm, 1 mm	IIb	9	11-502	44683
607-170	Bipo. forceps, NON-Stick-Gold, round handle, straight, 155 mm, 0,3 mm	IIb	9	11-502	44683
607-171	Bipo. forceps, NON-Stick-Gold, round handle, straight, 180 mm, 0,3 mm	IIb	9	11-502	44683
607-175	Bipo. forceps, NON-Stick-Gold, round handle, straight, 155 mm, 0,6 mm	IIb	9	11-502	44683
607-176	Bipo. forceps, NON-Stick-Gold, round handle, straight, 180 mm, 0,6 mm	IIb	9	11-502	44683
607-177	Bipo. forceps, NON-Stick-Gold, round handle, straight, 200 mm, 0,6 mm	IIb	9	11-502	44683
607-180	Bipo. forceps, NON-Stick-Gold, round handle, straight, 180 mm, 1 mm	IIb	9	11-502	44683
607-181	Bipo. forceps, NON-Stick-Gold, round handle, straight, 200 mm, 1 mm	IIb	9	11-502	44683
607-182	Bipo. forceps, NON-Stick-Gold, round handle, straight, 225 mm, 1 mm	IIb	9	11-502	44683

REF	Product description	Class	Rule	UMDNS	GMDN
607-185	Bipo. forceps, NON-Stick-Gold, round handle, straight, 200 mm, 2 mm	IIb	9	11-502	44683
607-186	Bipo. forceps, NON-Stick-Gold, round handle, straight, 225 mm, 2 mm	IIb	9	11-502	44683
607-190	Bipolar forceps, NON-Stick-Gold, round handle, angled, 225 mm, 1,0 mm	IIb	9	11-502	44683
610-016	Monopolar forceps, bayonet, 195 mm, 8 mm x 2 mm	IIb	9	11-502	44683
610-017	Monopolar forceps, straight, 195 mm, 8 mm x 2 mm	IIb	9	11-502	44683
610-018	Monopolar forceps, straight, 195 mm, 8 mm x 1 mm	IIb	9	11-502	44683
610-019	Monopolar forceps, straight, 220 mm, 8 mm x 2 mm	IIb	9	11-502	44683
610-021	Monopolar forceps, straight, 220 mm, 8 mm x 1 mm	IIb	9	11-502	44683
610-025	Monopolar forceps, straight, 270 mm, 8 mm x 2 mm	IIb	9	11-502	44683
612-018	Monopolar forceps, anatomic, 180 mm, 18 mm x 2 mm	IIb	9	11-502	44683
612-021	Monopolar forceps, anatomic, 200 mm, 18 mm x 2.2 mm	IIb	9	11-502	44683
612-025	Monopolar forceps, anatomic, 250 mm, 18 mm x 2.4 mm	IIb	9	11-502	44683
612-118	Monopolar forceps, surgical, 180 mm, 18 mm x 2 mm	IIb	9	11-502	44683
612-121	Monopolar forceps, surgical, 200 mm, 18 mm x 2.2 mm	IIb	9	11-502	44683
612-125	Monopolar forceps, surgical, 250 mm, 18 mm x 2.4 mm	IIb	9	11-502	44683
700-003	LAP electrode, spatula, 360 mm	IIb	9	16-206	44683
700-004	LAP electrode, strong hook, 360 mm	IIb	9	16-206	44683
700-005	LAP electrode, thin hook, 360 mm	IIb	9	16-206	44683
700-006	LAP electrode, needle, 360 mm	IIb	9	16-206	44683
710-003	LAP electrode, spatula, suction / irrigation tube, sealing cap, 360 mm	IIb	9	16-206	44683
710-004	LAP electr., strong hook, suct. / irrigation tube, sealing cap, 360 mm	IIb	9	16-206	44683
710-005	LAP electr., thin hook, suction / irrigation tube, sealing cap, 360 mm	IIb	9	16-206	44683
710-006	LAP electrode, needle, suction / irrigation tube, sealing cap, 360 mm	IIb	9	16-206	44683
720-000	ErgoLAP MONOPOLAR, handle	IIb	9	11-502	42553
721-301	ErgoLAP MONOPOLAR, jaw, forceps, 360 mm	IIb	9	11-502	42553
721-302	ErgoLAP MONOPOLAR, jaw, DeBakey, 360 mm	IIb	9	11-502	42553
721-303	ErgoLAP MONOPOLAR, jaw, Babcock, 360 mm	IIb	9	11-502	42553
721-304	ErgoLAP MONOPOLAR, jaw, Metzenbaum, 360 mm	IIb	9	11-502	42553
721-306	ErgoLAP MONOPOLAR, jaw, hook scissors, 360 mm	IIb	9	11-502	42553
721-307	ErgoLAP MONOPOLAR, jaw, Dorsey, 360 mm	IIb	9	11-502	42553
721-308	ErgoLAP MONOPOLAR, jaw, Fundus, 360 mm	IIb	9	11-502	42553
721-309	ErgoLAP MONOPOLAR, jaw, Maryland, 360 mm	IIb	9	11-502	42553
721-310	ErgoLAP MONOPOLAR, jaw, Alligator, 360 mm	IIb	9	11-502	42553
722-530	ErgoLAP MONOPOLAR, shaft tube, 360 mm	IIb	9	11-502	42553
736-005	ErgoLAP MONO., handle, shaft tube, sealing spare parts, 360 mm	IIb	9	11-502	42553
741-100	ERGO 320R, handle, COMFORT, cable, 4.5 m	IIb	9	11-502	61873
741-101	ERGO 320R, handle	IIb	9	11-502	61873
741-234	ERGO 320R, shaft tube, ø 5 mm, 340 mm	IIb	9	11-502	61873
741-812	ERGO 320R Set, atraumatic grasping forceps, 340 mm, COMFORT	IIb	9	11-502	61873
741-814	ERGO 320R Set, atraumatic grasping forceps, 340 mm	IIb	9	11-502	61873
741-822	ERGO 320R Set, grasping forceps, fenestrated, curved, 340 mm, COMFORT	IIb	9	11-502	61873
741-823	ERGO 320R Set, grasping forceps, fenestrated, curved, 340 mm	IIb	9	11-502	61873
741-827	ERGO 320R Set, grasping forceps with 2x3 teeth, 340 mm, COMFORT	IIb	9	11-502	61873
741-828	ERGO 320R Set, grasping forceps with 2x3 teeth, 340 mm	IIb	9	11-502	61873

REF	Product description	Class	Rule	UMDNS	GMDN
741-832	ERGO 320R Set, Metzenbaum scissors, 340 mm, COMFORT	IIb	9	11-502	61873
741-833	ERGO 320R Set, Metzenbaum scissors, 340 mm	IIb	9	11-502	61873
741-842	ERGO 320R Set, Maryland dissector, 340 mm, COMFORT	IIb	9	11-502	61873
741-843	ERGO 320R Set, Maryland dissector, 340 mm	IIb	9	11-502	61873
742-106	ERGO 325R, handle, rotatable, with lock	IIb	9	11-502	61873
742-234	ERGO 325R, shaft tube, ø 5 mm, 340 mm	IIb	9	11-502	61873
742-310	ERGO 320R/325R, jaw atraumatic grasping forceps, fenestrated, 340 mm	IIb	9	11-502	61873
742-320	ERGO 320R/325R, jaw grasping forceps, fenestrated, curved, 340 mm	IIb	9	11-502	61873
742-330	ERGO 320R/325R, jaw Metzenbaum scissors, 340 mm	IIb	9	11-502	61873
742-340	ERGO 320R/325R, jaw Maryland dissector, 340 mm	IIb	9	11-502	61873
742-350	ERGO 320R/325R, jaw grasping forceps with 2x3 teeth, 340 mm	IIb	9	11-502	61873
742-816	ERGO 325R Set, atraumatic grasping forceps, 340 mm, rotatable, with lock	IIb	9	11-502	61873
742-826	ERGO 325R Set, grasp. forceps, fenest., curved, 340 mm, rotatable, with lock	IIb	9	11-502	61873
742-829	ERGO 325R Set, grasp. forceps with 2x3 teeth, 340 mm, rotatable, with lock	IIb	9	11-502	61873
742-836	ERGO 325R Set, Metzenbaum scissors, 340 mm, rotatable, with lock	IIb	9	11-502	61873
742-846	ERGO 325R Set, Maryland dissector, 340 mm, rotatable, with lock	IIb	9	11-502	61873
743-100	ERGO 330R, handle, COMFORT, cable, 4.5 m	IIb	9	11-502	61873
743-101	ERGO 330R, handle	IIb	9	11-502	61873
743-225	ERGO 330R, shaft tube, ø 5 mm, 250 mm	IIb	9	11-502	61873
743-234	ERGO 330R, shaft tube, ø 5 mm, 340 mm	IIb	9	11-502	61873
743-325	ERGO 330R, jaw, 250 mm	IIb	9	11-502	61873
743-334	ERGO 330R, jaw, 340 mm	IIb	9	11-502	61873
743-425	ERGO 330R, drive rod, 250 mm	IIb	9	11-502	61873
743-434	ERGO 330R, drive rod, 340 mm	IIb	9	11-502	61873
743-525	ERGO 330R, blade holding tube, 250 mm	IIb	9	11-502	61873
743-534	ERGO 330R, blade holding tube, 340 mm	IIb	9	11-502	61873
743-851	ERGO 330R Set, coagulation forceps with cutting blade, 340 mm, COMFORT	IIb	9	11-502	61873
743-852	ERGO 330R Set, coagulation forceps with cutting blade, 340 mm	IIb	9	11-502	61873
743-853	ERGO 330R Set, coagulation forceps with cutting blade, 340 mm	IIb	9	11-502	61873
743-854	ERGO 330R Set, coagulation forceps with cutting blade, 250 mm	IIb	9	11-502	61873
743-999	ERGO 330R, blade, sterile (20 pcs.)	IIb	9	11-502	61873
744-100	ERGO 335R, handle, COMFORT, cable, 4.5 m	IIb	9	11-502	61873
744-101	ERGO 335R, handle	IIb	9	11-502	61873
744-220	ERGO 335R, Schaftrohr, ø 3 mm, 200 mm	IIb	9	11-502	61873
744-229	ERGO 335R, shaft tube, ø 3 mm, 290 mm	IIb	9	11-502	61873
744-312	ERGO 335R, jaw atraumatic grasping forceps, fenestrated, 200 mm	IIb	9	11-502	61873
744-313	ERGO 335R, jaw atraumatic grasping forceps, fenestrated, 290 mm	IIb	9	11-502	61873
744-342	ERGO 335R, jaw Maryland dissector, 200 mm	IIb	9	11-502	61873
744-343	ERGO 335R, jaw Maryland dissector, 290 mm	IIb	9	11-502	61873
744-812	ERGO 335R Set, atraumatic grasping forceps, ø 3 mm, 290 mm, COMFORT	IIb	9	11-502	61873
744-813	ERGO 335R Set, atraumatic grasping forceps, ø 3 mm, 200 mm, COMFORT	IIb	9	11-502	61873
744-815	ERGO 335R Set, atraumatic grasping forceps, ø 3 mm, 290 mm	IIb	9	11-502	61873
744-816	ERGO 335R Set, atraumatic grasping forceps, ø 3 mm, 200 mm	IIb	9	11-502	61873
744-844	ERGO 335R Set, Maryland dissector, ø 3 mm, 290 mm, COMFORT	IIb	9	11-502	61873
744-845	ERGO 335R Set, Maryland dissector, ø 3 mm, 200 mm, COMFORT	IIb	9	11-502	61873

REF	Product description	Class	Rule	UMDNS	GMDN
744-847	ERGO 335R Set, Maryland dissector, ø 3 mm, 290 mm	IIb	9	11-502	61873
744-848	ERGO 335R Set, Maryland dissector, ø 3 mm, 200 mm	IIb	9	11-502	61873
745-100	Trocar sleeve, metal tube, smooth, insuflation stopcock, ø 3,4 mm, 100mm	IIa	7	14-154	37148
745-120	Silikon valve for trocar sleeve (5 pcs.)	IIa	7	14-154	37148
745-130	Sealing for trocar sleeve (5 pcs.)	IIa	7	14-154	37148
745-200	Trocar, pyramid-shaped, 145 mm	IIa	7	14-154	37148
750-000	ErgoLAP BIPOLAR, handle	IIb	9	11-502	42553
750-033	ErgoLAP BIPOLAR, handle, shaft tube, sealing spare parts, 330 mm	IIb	9	11-502	42553
751-033	ErgoLAP BIPOLAR, jaw, Hirsch, 330 mm	IIb	9	11-502	42553
752-033	ErgoLAP BIPOLAR, jaw, Kleppinger, 330 mm	IIb	9	11-502	42553
753-033	ErgoLAP BIPOLAR, jaw, tweezers, 330 mm	IIb	9	11-502	42553
754-033	ErgoLAP BIPOLAR, jaw, micro-tweezers, 330 mm	IIb	9	11-502	42553
755-033	ErgoLAP BIPOLAR, outer shaft tube, 330 mm	IIb	9	11-502	42553
756-033	ErgoLAP BIPOLAR, inner shaft tube, 330 mm	IIb	9	11-502	42553
760-033	ErgoLAP BIPOLAR, jaw, NON-Stick CUT, knife-shaped, 330 mm	IIb	9	11-502	42553
760-119	TissueSeal PLUS, 190 mm	IIb	9	11-502	42553
760-123	TissueSeal PLUS, 230 mm	IIb	9	11-502	42553
760-128	TissueSeal PLUS, 280 mm	IIb	9	11-502	42553
760-216	TissueSeal PLUS COMFORT, 160 mm, cable 4.5 m	IIb	9	11-502	42553
760-219	TissueSeal PLUS COMFORT, 190 mm, cable 4.5 m	IIb	9	11-502	42553
760-223	TissueSeal PLUS COMFORT, 230 mm, cable 4.5 m	IIb	9	11-502	42553
760-228	TissueSeal PLUS COMFORT, 280 mm, cable 4.5 m	IIb	9	11-502	42553
760-319	TissueSeal handle, COMFORT 190 mm, cable 4.5 m	IIb	9	11-502	42553
760-323	TissueSeal handle, COMFORT 230 mm, cable 4.5 m	IIb	9	11-502	42553
760-328	TissueSeal handle, COMFORT 280 mm, cable 4.5 m	IIb	9	11-502	42553
761-033	ErgoLAP BIPOLAR, jaw, NON-Stick CUT, wedge-shaped, 330 mm	IIb	9	11-502	42553
770-000	NightKNIFE + LIGATOR, handle, COMFORT, cable 4.5 m	IIb	9	11-502	42553
770-036	LIGATOR, handle, shaft tube, sealing spare parts, 360 mm, COMFORT	IIb	9	11-502	42553
770-200	NightKNIFE set, 200 mm, COMFORT	IIb	9	11-502	42553
770-201	NightKNIFE set, exchangeable knife, 200 mm, COMFORT	IIb	9	11-502	42553
770-211	LIGATOR, shaft tube, 110 mm	IIb	9	11-502	42553
770-236	LIGATOR, shaft tube, 360 mm	IIb	9	11-502	42553
770-300	NightKNIFE set, 360 mm, COMFORT	IIb	9	11-502	42553
770-301	NightKNIFE set, exchangeable knife, 360 mm, COMFORT	IIb	9	11-502	42553
770-320	NightKNIFE, shaft tube, 200 mm	IIb	9	11-502	42553
770-336	NightKNIFE, shaft tube, 360 mm	IIb	9	11-502	42553
770-999	NightKNIFE, blade (5 pcs.)	IIb	9	11-502	42553
771-011	LIGATOR, jaw, straight, 110 mm	IIb	9	11-502	42553
771-036	LIGATOR, jaw, straight, 360 mm	IIb	9	11-502	42553
771-120	NightKNIFE, jaw, 200 mm	IIb	9	11-502	42553
771-121	NightKNIFE, jaw, exchangeable knife, 200 mm	IIb	9	11-502	42553
771-136	NightKNIFE, jaw, 360 mm	IIb	9	11-502	42553
771-137	NightKNIFE, jaw, exchangeable knife, 360 mm	IIb	9	11-502	42553
772-011	LIGATOR, jaw, Maryland, 110 mm	IIb	9	11-502	42553
772-036	LIGATOR, jaw, Maryland, 360 mm	IIb	9	11-502	42553

REF	Product description	Class	Rule	UMDNS	GMDN
773-000	NightKNIFE + LIGATOR set, COMFORT	IIb	9	11-502	42553
773-001	NightKNIFE + LIGATOR set, exchangeable knife, COMFORT	IIb	9	11-502	42553
775-000	ERGO 310D, Laparoscopic vessel sealer, Ø 5 mm, 340 mm	IIb	9	11-502	44684
795-145	BiZZER, bipolar scissors, 145 mm, curved, needle tip	IIb	9	13-484	44683
795-180	BiZZER, bipolar scissors, 180 mm, curved, needle tip	IIb	9	13-484	44683
795-545	BiZZER, bip. scissors, 145 mm, curved, needle tip, COMFORT, cable 4.5m	IIb	9	13-484	44683
795-580	BiZZER, bip. scissors, 180 mm, curved, needle tip, COMFORT, cable 4.5m	IIb	9	13-484	44683
796-170	BiZZER, bipolar scissors, 170 mm, curved	IIb	9	13-484	44683
796-570	BiZZER, bipolar scissors, 170 mm, curved, COMFORT, cable 4.5 m	IIb	9	13-484	44683
797-180	BiZZER, bipolar scissors, 180 mm, curved, slight	IIb	9	13-484	44683
797-230	BiZZER, bipolar scissors, 230 mm, curved, slight	IIb	9	13-484	44683
797-280	BiZZER, bipolar scissors, 280 mm, curved, slight	IIb	9	13-484	44683
797-580	BiZZER, bipolar scissors, 180 mm, curved, slight, COMFORT, cable 4.5 m	IIb	9	13-484	44683
797-630	BiZZER, bipolar scissors, 230 mm, curved, slight, COMFORT, cable 4.5 m	IIb	9	13-484	44683
797-680	BiZZER, bipolar scissors, 280 mm, curved, slight, COMFORT, cable 4.5 m	IIb	9	13-484	44683
798-145	BiZZER, bipolar scissors, 145 mm, curved, fine	IIb	9	13-484	44683
798-180	BiZZER, bipolar scissors, 180 mm, curved, fine	IIb	9	13-484	44683
798-230	BiZZER, bipolar scissors, 230 mm, curved, fine	IIb	9	13-484	44683
798-280	BiZZER, bipolar scissors, 280 mm, curved, fine	IIb	9	13-484	44683
798-545	BiZZER, bipolar scissors, 145 mm, curved, fine, COMFORT, cable 4.5 m	IIb	9	13-484	44683
798-580	BiZZER, bipolar scissors, 180 mm, curved, fine, COMFORT, cable 4.5 m	IIb	9	13-484	44683
798-630	BiZZER, bipolar scissors, 230 mm, curved, fine, COMFORT, cable 4.5 m	IIb	9	13-484	44683
798-680	BiZZER, bipolar scissors, 280 mm, curved, fine, COMFORT, cable 4.5 m	IIb	9	13-484	44683
800-000	Tip cleaner, single-use, sterile (50 pcs.)	Is	1	15-271	44684
800-001	NON-Stick knife electrode, shaft 2.4 mm, single-use, sterile (10 pcs.)	IIb	9	11-499	44684
800-002	NON-Stick needle electrode, shaft 2.4 mm, single-use, ster. (10 pcs.)	IIb	9	11-499	44684
800-003	NON-Stick ball electrode, shaft 2.4 mm, single-use, sterile (10 pcs.)	IIb	9	11-499	44684
800-004	NON-Stick knife el., 152 mm, shaft 2.4 mm, single-use, ster. (10 pcs.)	IIb	9	11-499	44684
800-005	NON-Stick ball el., 134 mm, shaft 2.4 mm, single-use, ster. (10 pcs.)	IIb	9	11-499	44684
800-006	Safety holster, single-use, sterile (100 pcs.)	Is	1	16-349	44684
800-007	Knife electrode, shaft 2.4 mm, single-use, sterile (5 pcs.)	IIb	9	11-499	44684
800-011	Needle electrode, shaft 2.4 mm, single-use, sterile (5 pcs.)	IIb	9	11-499	44684
800-021	Ball electrode, shaft 2.4 mm, single-use, sterile (5 pcs.)	IIb	9	11-499	44684
800-028	Knife electrode, 152 mm, shaft 2.4 mm, single-use, sterile (5 pcs.)	IIb	9	11-499	44684
800-030	Ball electrode, 136 mm, shaft 2.4 mm, single-use, sterile (10 pcs.)	IIb	9	11-499	44684
801-030	Handle, r. sw., knife, Ø 2.4 mm, 3-pin, 3 m, s-u, sterile (50 pcs.)	IIb	9	11-494	44681
802-030	Handle, 2 sw., knife, Ø 2.4 mm, 3-pin, 3 m, s-u, sterile (50 pcs.)	IIb	9	11-494	44681
802-032	SHE SHA Handle, 2 sw., knife, 3 m, s-u, sterile (10 pcs.)	IIb	9	11-494	44681
803-030	Handle, no sw., knife, Ø 2,4 mm, 3 m, single-use, ster. (10 pcs.)	IIa	6	11-494	44678
815-040	Neutral electrode, 40 cm ² , non-split (100 pcs)	IIb	9	11-500	11500
815-070	Neutral electrode, 70 cm ² , non-split (100 pcs)	IIb	9	11-500	11500
815-110	Neutral electrode, 110 cm ² , non-split (100 pcs)	IIb	9	11-500	11500
815-140	Neutral electrode, 140 cm ² , non-split (100 pcs)	IIb	9	11-500	11500
816-042	Neutral electrode, 40 cm ² , split, EASY (100 pcs)	IIb	9	11-500	11500
816-071	Neutral electrode, 70 cm ² , split (100 pcs)	IIb	9	11-500	11500

REF	Product description	Class	Rule	UMDNS	GMDN
816-072	Neutral electrode, 70 cm ² , split, EASY (100 pcs)	IIb	9	11-500	11500
816-092	Neutral electrode, 90 cm ² , split, EASY (100 pcs)	IIb	9	11-500	11500
816-112	Neutral electrode, 110 cm ² , split, EASY (100 pcs)	IIb	9	11-500	11500
816-141	Neutral electrode, 140 cm ² , split (100 pcs)	IIb	9	11-500	11500
816-161	Neutral electrode, 160 cm ² , split (100 pcs)	IIb	9	11-500	11500
816-162	Neutral electrode, 160 cm ² , split, EASY (100 pcs)	IIb	9	11-500	11500
817-040	Neutral electrode, 40 cm ² , non-split, with cable 3 m (15 pcs)	IIb	9	11-500	11500
817-070	Neutral electrode, 70 cm ² , non-split, with cable 3 m (15 pcs)	IIb	9	11-500	11500
817-110	Neutral electrode, 110 cm ² , non-split, with cable 3 m (15 pcs)	IIb	9	11-500	11500
817-140	Neutral electrode, 140 cm ² , non-split, with cable 3 m (15 pcs)	IIb	9	11-500	11500
818-042	Neutral electrode, 40 cm ² , split, with cable 3 m, EASY (15 pcs)	IIb	9	11-500	11500
818-071	Neutral electrode, 70 cm ² , split, with cable 3 m (15 pcs)	IIb	9	11-500	11500
818-072	Neutral electrode, 70 cm ² , split, with cable 3 m, EASY (15 pcs)	IIb	9	11-500	11500
818-092	Neutral electrode, 90 cm ² , split, with cable 3 m, EASY (15 pcs)	IIb	9	11-500	11500
818-112	Neutral electrode, 110 cm ² , split, with cable 3 m, EASY (15 pcs)	IIb	9	11-500	11500
818-141	Neutral electrode, 140 cm ² , split, with cable 3 m (15 pcs)	IIb	9	11-500	11500
818-161	Neutral electrode, 160 cm ² , split, with cable 3 m (15 pcs)	IIb	9	11-500	11500
818-162	Neutral electrode, 160 cm ² , split, with cable 3 m, EASY (15 pcs)	IIb	9	11-500	11500
830-000	TissueSeal, electrode tips, straight, toothed, s-u, sterile (5 sets)	IIb	9	11-499	44684
830-001	TissueSeal, electrode tips, straight, single-use, sterile (5 sets)	IIb	9	11-499	44684
830-010	TissueSeal, electrode tips, angled, toothed, s-u, sterile (5 sets)	IIb	9	11-499	44684
830-011	TissueSeal, electrode tips, angled, single-use, sterile (5 sets)	IIb	9	11-499	44684
830-050	ARC PLUS filter set, single-use, sterile (50 pcs.)	IIa	2	11-494	44678
900-000	ARC PLUS Argon coagulation unit for ARC 250 / 303 / 350 (REF 900-350)	IIa	11	17-738	36154
900-001	ARC PLUS Argon coagulation unit, for ARC 400 / 350 (REF 900-351)	IIa	11	17-738	36154
900-030	Equipotential bonding, 0,5 m	I	1	11-496	16902
900-031	Equipotential bonding, 5 m	I	1	11-496	16902
900-035	Equipotential bonding, 1,5 m	I	1	11-496	16902
900-100	Electrosurgical unit ARC 100	IIb	9	11-490	11490
900-250	Electrosurgical unit ARC 250	IIb	9	11-490	11490
900-303	Electrosurgical unit ARC 303	IIb	9	11-490	11490
900-350	Electrosurgical unit ARC 350 (REF 900-350)	IIb	9	11-490	11490
900-351	Electrosurgical unit ARC 350 (REF 900-351)	IIb	9	11-490	11490
900-390	Option LIGATION, for ARC 350 (REF 900-350)	IIb	9	11-490	11490
900-391	Option GastroCut, for ARC 350 (REF 900-351)	IIb	9	11-490	11490
900-392	Option Argon / GastroCut, for ARC 250 / 303	IIb	9	11-490	11490
900-395	Option Bipolar Resection, for ARC 400 / 350 (REF 900-351)	IIb	9	11-490	11490
900-396	Option LIGATION, for ARC 400 / 350 (REF 900-351)	IIb	9	11-490	11490
900-397	Europe Option ARC 303 (ERBE/MARTIN via adapter)	IIb	9	11-490	11490
900-398	Europe Option ARC 250 (ERBE/MARTIN via adapter)	IIb	9	11-490	11490
900-399	Option BipolarSimCOAG, for ARC 400	IIb	9	11-490	11490
900-400	Electrosurgical unit ARC 400	IIb	9	11-490	11490
900-901	Pressure reducer, for ARC PLUS (REF 900-000), DIN 477 no. 6	IIb	9	13-323	37025
900-902	Pressure reducer, for ARC PLUS (REF 900-000), DIN 477 no. 10	IIb	9	13-323	37025
900-903	Pressure reducer, for ARC PLUS (REF 900-000), CGA 580	IIb	9	13-323	37025

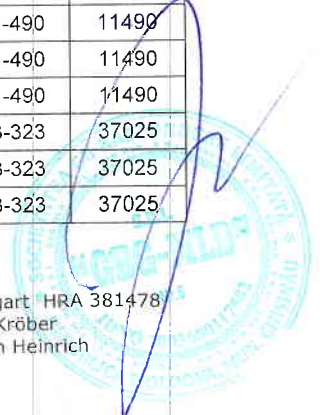

REF	Product description	Class	Rule	UMDNS	GMDN
900-904	Pressure reducer, for ARC PLUS (REF 900-000), BS 341 no. 3	IIb	9	13-323	37025
900-906	Pressure reducer, for ARC PLUS (REF 900-001) and ARC 400, DIN 477 no. 6	IIb	9	13-323	37025
900-907	Pressure reducer, for ARC PLUS (REF 900-001) and ARC 400, DIN 477 no. 10	IIb	9	13-323	37025
900-908	Pressure reducer, for ARC PLUS (REF 900-001) and ARC 400, CGA 580	IIb	9	13-323	37025
900-909	Pressure reducer, for ARC PLUS (REF 900-001) and ARC 400, BS 341 no. 3	IIb	9	13-323	37025
900-911	Mains cable, plug type F, 5 m	I	1	11-496	16902
900-912	Mains cable, plug type G, 5 m	I	1	11-496	16902
900-913	Mains cable, plug type K, 5 m	I	1	11-496	16902
900-914	Mains cable, plug type L, 5 m	I	1	11-496	16902
900-915	Mains cable, plug type N, 5 m	I	1	11-496	16902
900-916	Mains cable, plug type B, 5 m	I	1	11-496	16902
900-917	Mains cable, plug type I, 5 m	I	1	11-496	16902
901-011	Single-pedal footswitch, with switch, cable 4 m	IIb	9	11-009	36336
901-012	Single-pedal footswitch for ARC 100, cable 4 m	IIb	9	11-009	36336
901-021	Double-pedal footswitch, cable 4 m	IIb	9	11-009	36336
901-031	Double-pedal footswitch with switch, cable 4 m	IIb	9	11-009	36336
901-032	Double-pedal footswitch with switch and clip, cable 4 m	IIb	9	11-009	36336
901-045	Interface with fibre optics, for ARC 350, for ARC PLUS (REF 900-000)	I	1	11-496	16902
901-050	Fibre optics, for ARC PLUS (REF 900-000 silver)	I	1	11-496	16902
901-051	Fibre optics, for ARC PLUS (REF 900-001)	I	1	11-496	16902
901-052	Fibre optics, for ARC PLUS (REF 900-000)	I	1	11-496	16902
901-124	Accessory set, 2.4 mm	IIb	9	15-895	44683
901-125	ARC 100 set, 2.4 mm	IIb	9	15-895	44683
901-126	ARC 100 accessory set, 2.4 mm	IIb	9	15-895	44683
901-140	Accessory set, 4 mm	IIb	9	15-895	44683
901-210	Adapter bipolar, Erbe, for BOWA ARC	I	1	16-490	35041
901-220	Adapter bipolar, Martin, for BOWA ARC	I	1	16-490	35041
901-250	Adapter monopolar, Erbe, for BOWA ARC	I	1	16-490	35041
901-270	Adapter monopolar, Martin, for BOWA ARC	I	1	16-490	35041
932-031	Rigid Argon coagulation electrode, 75 mm	IIb	9	11-499	44683
932-032	Rigid Argon coagulation electrode, 150 mm	IIb	9	11-499	44683
932-034	Rigid Argon coagulation electrode, 370 mm	IIb	9	11-499	44683
932-035	Rigid Argon needle cutting and coagulation electrode, 100 mm	IIb	9	11-499	44683
932-036	Rigid Argon needle cutting and coagulation electrode, 150 mm	IIb	9	11-499	44683
932-042	Argon handle COMFORT, cable 3.5 m	IIb	9	11-494	44680
932-045	Cable for flexible Argon probe, round plug, 2.5 m	IIa	2	11-493	35042
932-048	Flexible Argon probe, round pin plug, Ø 1.5 mm, 1.5 m	IIb	9	16-206	44683
932-049	Flexible Argon probe, round pin plug, Ø 2.3 mm, 2.2 m	IIb	9	16-206	44683
932-050	Flexible Argon probe, round pin plug, Ø 3.2 mm, 2.2 m	IIb	9	16-206	44683
932-051	Flexible Argon probe, round pin plug, Ø 1.5 mm, 3 m	IIb	9	16-206	44683
932-052	Flexible Argon probe, round pin plug, Ø 2.3 mm, 3 m	IIb	9	16-206	44683
932-055	Rigid Argon knife cutting and coagulation electrode, 100 mm	IIb	9	11-499	44683
932-058	Rigid Argon knife cutting and coagulation electrode, 150 mm	IIb	9	11-499	44683
932-059	Rigid Argon knife cutting and coagulation electrode, 370 mm	IIb	9	11-499	44683
932-060	Argon coagulation electrode, bendable 170 mm	IIb	9	11-499	44683

REF	Product description	Class	Rule	UMDNS	GMDN
932-061	Argon coagulation electrode, bendable 250 mm	IIb	9	11-499	44683
932-062	Argon coagulation electrode, bendable 370 mm	IIb	9	11-499	44683
932-118	Flexible Argon probe, round pin plug, Ø 2.3 mm, 1 m	IIb	9	16-206	44683
932-146	Cable for flexible Argon probe COMFORT, 2.5 m	IIa	2	11-493	35042
932-148	Flexible Argon probe, Ø 1.5 mm, 1.5 m	IIb	9	16-206	44683
932-149	Flexible Argon probe, Ø 2.3 mm, 2.2 m	IIb	9	16-206	44683
932-150	Flexible Argon probe, Ø 3.2 mm, 2.2 m	IIb	9	16-206	44683
932-151	Flexible Argon probe, Ø 1.5 mm, 3.0 m	IIb	9	16-206	44683
932-152	Flexible Argon probe, Ø 2.3 mm, 3.0 m	IIb	9	16-206	44683
932-153	Flexible Argon probe, 90°, Ø 2.3 mm, 2.2 m	IIb	9	16-206	44683
932-154	Flexible Argon probe, Ø 2.3 mm, 1 m	IIb	9	16-206	44683
932-248	Flexible Argon probe, Ø 1.5 mm, 1.5 m, single-use, sterile (10 pcs.)	IIb	9	11-499	44684
932-249	Flexible Argon probe, Ø 2.3 mm, 2.2 m, single-use, sterile (10 pcs.)	IIb	9	11-499	44684
932-250	Flexible Argon probe, Ø 3.2 mm, 2.2 m, single-use, sterile (10 pcs.)	IIb	9	11-499	44684
932-251	Flexible Argon probe, Ø 1.5 mm, 3 m, single-use, sterile (10 pcs.)	IIb	9	11-499	44684
932-252	Flexible Argon probe, Ø 2.3 mm, 3 m, single-use, sterile (10 pcs.)	IIb	9	11-499	44684
932-253	Flexible Argon probe, 90°, Ø 2.3 mm, 2.2 m, single-use, sterile (10 pcs.)	IIb	9	11-499	44684
952-001	SHE SHA, Hose, for handle, single-use, sterile (10 pcs.)	Is	1	16-262	46483





Product Service

CERTIFICATE

No. Q1N 16 02 16316 018

Holder of Certificate: BOWA-electronic GmbH & Co. KG

Heinrich-Hertz-Strasse 4-10
72810 Gomaringen
GERMANY

Facility(ies):

BOWA-electronic GmbH & Co. KG
Heinrich-Hertz-Strasse 4-10, 72810 Gomaringen,
GERMANY

BOWA Polska Sp. zo. o.
Zlotkowo, ul. Obornicka 10, 60-002 Suchy Las,
POLAND



Certification Mark:



Scope of Certificate:

Design and development, production and distribution of

- Electrosurgical Units and accessories,
- Argon Coagulation Units and accessories,
- electrode handles,
- active electrodes and instruments,
- monopolar and bipolar forceps,
- endoscopic and laparoscopic instruments,
- Instruments for vessel sealing,
- neutral electrodes,
- bipolar scissors

Applied Standard(s):

EN ISO 13485:2012 + AC:2012
Medical devices - Quality management systems -
Requirements for regulatory purposes
(ISO 13485:2003 + Cor. 1:2009)
DIN EN ISO 13485:2012

The Certification Body of TÜV SÜD Product Service GmbH certifies that the company mentioned above has established and is maintaining a quality management system, which meets the requirements of the listed standard(s). See also notes overleaf.

Report No.: 713076068

Valid from: 2016-03-03

Valid until: 2019-02-28

Date, 2016-03-03

S. Preis
Stefan Preis



Page 1 of 1

DAkkS

Deutsche
Akkreditierungsstelle
D-ZM-11321-01-00

Zertifizierungsvertrag

Grundlage für die Zertifikatserteilung ist die Prüf- und Zertifizierungsordnung von TÜV SÜD Product Service.

Mit Erhalt des Zertifikates erkennt der Zertifikatsinhaber die jeweils gültige Fassung der Prüf- und Zertifizierungsordnung an (www.tuev-sued.de/ps_regulations) und wird somit Partner im Zertifiziersystem von TÜV SÜD Product Service.

Prinzipielle Voraussetzung für die Gültigkeit des Zertifikates:

– Gültigkeit der zitierten normativen Prüfgrundlage(n) ist gegeben

und zusätzlich bei Zertifikaten mit Berechtigung zur Verwendung eines Prüfzeichens bzw. bei Zertifikaten für QM-Systeme:

– Voraussetzungen für vorschriftsmäßige Fertigung werden eingehalten.

– Die Fertigungs- bzw. Betriebsstätten werden regelmäßig überwacht.

Certification contract

Certification is based on the TÜV SÜD Product Service Testing and Certification Regulations.

On receipt of the certificate the certificate holder agrees to the current version of the Testing and Certification Regulations (www.tuev-sued.de/ps_regulations) and thus becomes partner in the TÜV SÜD Product Service Certification System.

Requirements for the validity of the certificate in principle:

– Validity of the quoted test standard(s)

In addition for certificates with the right to use a certification mark and for QM certificates:

– Conditions for an adequate manufacturing are maintained

– Regular surveillance of the facility is performed

Akkreditierungen / Benennungen (Status 14.10.2013) /
Accreditations / notifications (as of 2013-10-14)

Deutschland / Germany

Produktsicherheitsgesetz (ProdSG) /
Product Safety Act (ProdSG)

Europa / Europe

- Niederspannungsrichtlinie 2006/95/EG
- Spielzeugrichtlinie 2009/48/EG
- Richtlinie für aktive medizinische Implantate 90/385/EWG
- Richtlinie für Medizinprodukte 93/42/EWG
- Richtlinie für In-vitro-Diagnostika 98/79/EG
- Richtlinie für Gasverbrauchseinrichtungen 2009/142/EG
- Richtlinie für persönliche Schutzausrüstungen 89/686/EWG
- EMV-Richtlinie 2004/108/EG
- Richtlinie für Sportboote 94/25/EG + 2003/44/EG
- Richtlinie für Maschinen 2006/42/EG
- Richtlinie für Ex-Schutz Geräte 94/9/EG

- Low Voltage Directive 2006/95/EC
- Toys Directive 2009/48/EC
- Directive for Active Implantable Medical Devices 90/385/EEC
- Directive for Medical Devices 93/42/EEC
- Directive on In Vitro Diagnostic Medical Devices 98/79/EC
- Directive for Gas Appliances 2009/142/EC
- Directive for Personal Protective Equipment 89/686/EEC
- EMC Directive 2004/108/EC
- Directive for Recreational Craft 94/25/EC + 2003/44/EC
- Directive for Machinery 2006/42/EC
- Directive for Ex Safe Equipment 94/9/EC

- ENEC Agreement for luminaires, household and IT equipment

USA

- Nationally Recognized Testing Laboratory (NRTL) to 29 CFR 1910.7 by OSHA
- Accredited for FDA 510(k) Third Party Review
- Conformity Assessment Body to the MRA for Medical Devices; FDA QSR Reg Inspections, FDA 510(k) Third Party Review

Asien-Pazifik Region / Asia Pacific

- Recognized Certification Body to Electrical Products (Safety Regulation; Hong Kong)
- Konformitätsbewertungsstelle / Conformity Assessment Body to the MRA for Medical Devices; Australien / Australia
- Konformitätsbewertungsstelle / Conformity Assessment Body to the MRA for Medical Devices; Neuseeland / New Zealand

Weltweit / Worldwide

- NCB im CB-Scheme des IECEE /
NCB in the CB Scheme of IECEE
- ExCB im IECEX-Scheme des IECEE /
ExCB in the IECEX Scheme of IECEE
- Zertifizierstellen durch DAkkS akkreditiert
DE-ZE-11321-01, DE-ZM-11321-09 und DE-ZM-11321-01.
Certification Bodies accredited by DAkkS
DE-ZE-11321-01, DE-ZM-11321-09 and DE-ZM-11321-01