

Table of Contents

Section 1	Introduction	1
	Intended Use	1
Section 2	Analyzer Components	2
	Analyzer Component Illustrations	2
Section 3	Initial Startup	3
Section 4	Analyzer Setup	4
	Test Settings	4
	Type of Strip	4
	Mode	5
	Test Number	5
	Continuous Test	6
	Operator ID	6
	Units	6
	Analyzer Configuration	6
	Printer Setup	6
	Sound	7
	Barcode reader	8
	Language	8
	Date/Time	8
	Auto Number Reset	9
	Database	9
	Clear all Records	10
	Locate Record	10
	View Current Record	11
	Self Test	11
	QC Test	11
	QC Setup	11
	Run QC Test	13
	Setting the QC Values	13
	User Login	13
	ID Admin	14
Section 5	Analyzer Operation	17
	Entering Canister Code	19
	Normal Operation, no Barcode reader	20
	Sample/Strip Preparation	20
	Strip Test – Single Test Mode	21
	Strip Test – Continuous Test Mode	22
	Normal Operation, Barcode reader installed	24
	Strip Test – Single Test Mode with Barcode reader	24
	Strip Test – Continuous Test Mode with Barcode reader	25
	Urine Controls QC Testing	27
	Strip Preparation	27
	Urine Control Test Procedures	27
	QC lockout	28
Section 6	Data/Communication	30
	External Printer	30
	Barcode Reader	30
	Service and Support	30
Section 7	Quality Control	31
Section 8	Maintenance	32
	Loading Printer Paper	32
	General Cleaning	33
	Daily Cleaning	33
	Remove the Strip Holder	33
	Clean the Strip Holder	33
	Load the Strip Holder	33
	Return the Strip Holder/Mount to its Internal Position	34
	Sample Deposit Cleaning	34
	Strip Holder Sterilization	34
Section 9	Precautions	36
Section 10	Troubleshooting	37
Appendix 1	Urine Analyzer Specifications	38
Appendix 2	Performance Characteristics of Urinalysis Reagent Strips	39
Appendix 3	URS Parameter Table	41
Appendix 4	Result Print-Out	43
Appendix 5	Barcode Reader	44
Appendix 6	Catalog	45
Appendix 7	Index of Symbols	46
Appendix 8	Warranty	47

Section 1 Introduction

The *Mission*[®] U120 Smart Urine Analyzer reads urine test strips. It stores results and prints reports without the need for special training.

The *Mission*[®] U120 Smart Urine Analyzer runs a self-test each time the power switch is turned on. An optional barcode reader records patient ID. The barcode reader verifies strip canister barcodes. Use only *Mission*[®] Urinalysis Reagent Strips with the canister barcode for correct results.

Intended Use

The *Mission*[®] U120 Smart Urine Analyzer is intended for use in conjunction with the *Mission*[®] Urinalysis Reagent Strips for the semi-quantitative detection of the following analytes in urine: Albumin, Creatinine, Glucose, Bilirubin, Ketone (Acetoacetic acid), Specific Gravity, pH, Blood, Protein, Urobilinogen, Leukocytes, Ascorbic Acid and Calcium, as well as the qualitative detection of Nitrite. The instrument is intended for professional, *in vitro* diagnostic use only. The measurement can be used in general evaluation of health, and aids in the diagnosis and monitoring of metabolic or systemic diseases that affect kidney function, endocrine disorders and diseases or disorders of the urinary tract.

Note: Keys on the Keypad are listed in **bold**. Display items on the screen are listed in ***bold italics*** in the manual.

Section 2 Analyzer Components

Analyzer Component Illustrations

- | | | | |
|---|------------------------|----|--------------------------|
| 1 | Keypad | 9 | Strip Holder Stop |
| 2 | Liquid Crystal Display | 10 | White Calibration Circle |
| 3 | Printer Cover | 11 | Strip Holder Mount |
| 4 | Printer Roller | 12 | USB Port |
| 5 | Printer Paper | 13 | External Printer Port |
| 6 | Printer | 14 | Standard RS232C Port |
| 7 | Strip Holder | 15 | Power Socket |
| 8 | Strip Holder Channel | 16 | Power Switch |

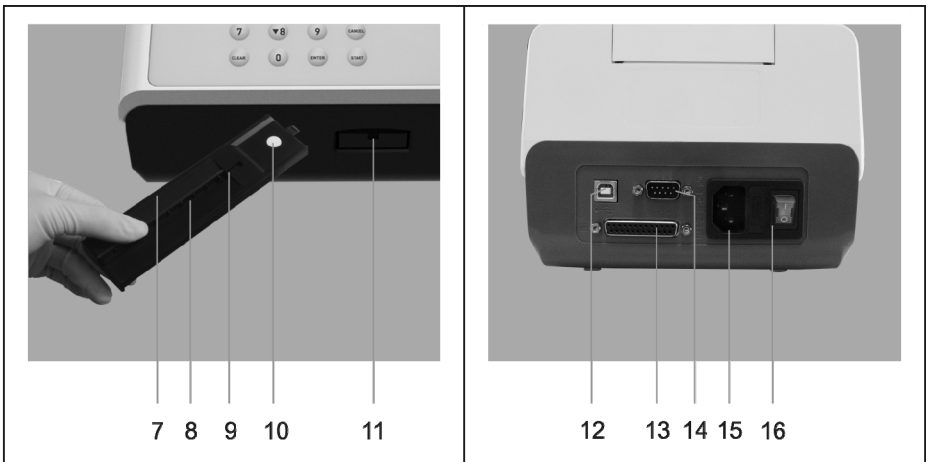
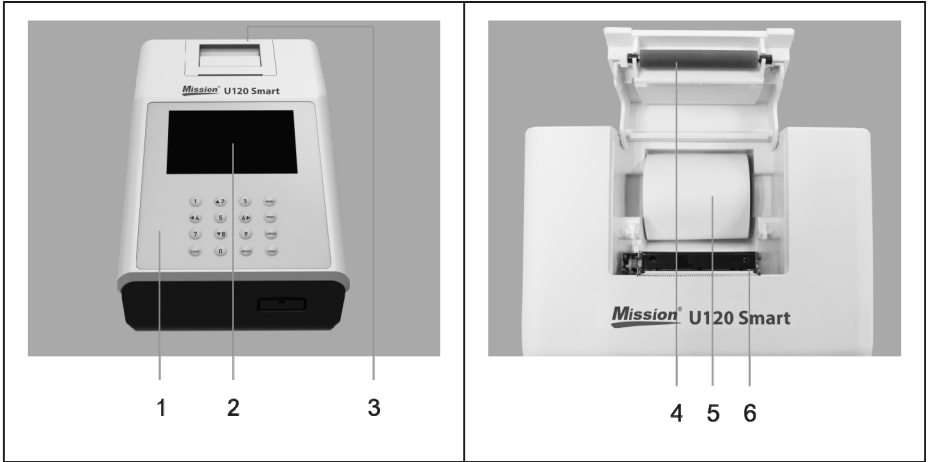

Section 3 Initial Startup

Place the analyzer on a level surface. Allow 80x50 cm on all sides of the analyzer for access.

Plug the power cord into a power outlet. Press the power switch (16) located on the back panel to turn the *Mission*® U120 Smart Urine Analyzer on. The *Mission*® U120 Smart Urine Analyzer will run a Self-Test. The analyzer will display the screen shown below.

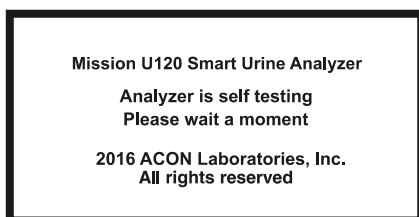

Turn the Power Switch on. If the Self-Test passes, the Initial Screen will be shown.

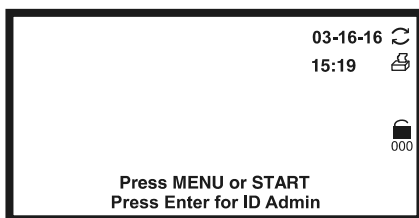

Note: The screen will not display  if Strip Lockout is not included.

If the Self-Test fails, a **Failed** Screen will be displayed. The analyzer cannot be operated. Press the power switch off then on to re-test. Refer to Section 10 Troubleshooting to correct a failure.

Press **MENU** to access the Test Settings, Analyzer Configuration, Database functions, Self-Test and QC Test.

Note: Use the arrow keys on the keypad to select **Exit** or press the **Cancel** key when **Exit** is not available.

Press **START** to begin strip testing. Press **ENTER** for **ID Admin**.

Section 4 Analyzer Setup

Press **Menu** from the Initial Screen to display the screen below.

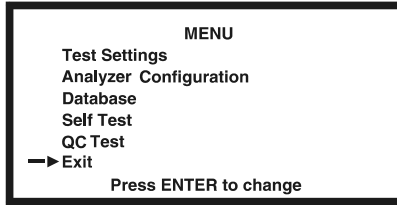

Select options by pressing **▲** or **▼** until the Selection Arrow (→) is next to the option. Press **ENTER** to show the options in a new screen or cycle through the settings below. Select **Exit** and press **ENTER** to return to the Initial Screen.

Test Settings

Select **Test Settings** to display the menu shown below.

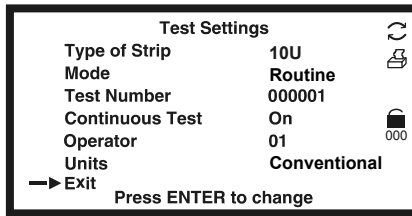

Press **▲** or **▼** to select an option. Press **Enter** to show or change the option settings below. Select **Exit** and press **Enter** to return to the **Main Menu**.

Available settings on the **Test Settings** menu and descriptions are as follows. 10U is an example of Type of Strips.

Type of Strip	10U
Mode	Routine, Stat, QC
Test Number	User selected number
Continuous Test	On, Off (single test)
Operator ID	If User Login is off, Operator ID will be 01 through 10. If User login is enabled, Operator ID will be 11 through 20, and 100 for the Administrator
Units	Conventional Units or Standard International (SI)

Type of Strip

Select **Type of Strip** and press **ENTER** to change the strip type. Each strip type name defines the number of test parameters. If **User Login** is enabled and **Operator ID** is 11 through 20, this setting cannot be changed.

Note: Ensure the type of strip selected corresponds with the strip to be used. If it does not, an error message will be displayed.

Mode

There are three test mode options. Press **ENTER** when **Mode** is selected to change the **Mode**.

Note: The Mode can be changed during normal testing for STAT tests.

Routine Test

Use for normal urine testing. The default test number ranges from 1 to 99999. It resets to 1 every day automatically if **Auto Number Reset** is set to **Yes**.

STAT Test

Use for emergency urine testing. The default test number is from 100001 to 199999. It resets to 100001 each day automatically if **Auto Number Reset** is set to **Yes**. The analyzer will automatically switch to **STAT** test and can not be changed if the QC test has failed.

QC Test

Use to test positive/negative controls. If **QC lockout** is on, this test will be run automatically. The test number ranges from 200001 to 299999. It resets to 200001 every day automatically if **Auto Number Reset** is **Yes**.

Note: Ensure **QC Test** mode is used for testing positive and negative controls. Use of any other mode will report the testing results as a regular specimen and will not display proper "Pass/Fail" QC test results.

Test Number

Select **Test Number** and press **ENTER**.

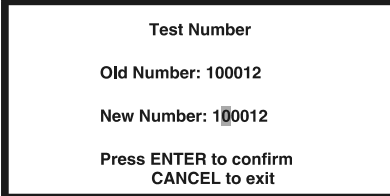

Test Number

Old Number: 100012

New Number: 100012

Press ENTER to confirm
CANCEL to exit

Enter the new **Test Number**. Press **ENTER** to confirm. Press **CANCEL** to delete any changes and keep the existing number.

The first digit in the number will depend on the **Test Mode**. The first digit will be **0** for **Routine**, **1** for **STAT** and **2** for **QC Test**. This first digit is fixed and cannot be changed from this screen. Tests run after this number is changed will be set sequentially from the new number.

Note: Specimens may be assigned the same test number. They will be distinguished by test date and time in the Database.

Continuous Test

Select **Continuous Test** and press **ENTER** to cycle the settings to **Off** or **On**. When the selection is correct, select **EXIT** and press **ENTER** to return to the **Main Menu**.

Continuous Test – Off (Single Test Mode)

Test one strip at a time. **Single Test** Mode performs 60 tests / hour.

Continuous Test - On

Test strips one after another. **Continuous Test** Mode performs up to 120 tests per hour. When **Continuous Test** is on, the  symbol will be displayed.

Operator ID

Select **Operator ID** and press **ENTER** to increase the number by one. After **10**, it reverts back to **01**. If **User Login** is enabled and **Operator ID** is 11 through 20, this setting cannot be changed. Select **EXIT** and press **ENTER** to return to the **Main Menu**.



Units

Select **Units** and press **ENTER** to cycle the units between **Conventional** or **SI** units. If **User Login** is enabled and **Operator ID** is 11 through 20, this setting cannot be changed. Select **EXIT** and press **ENTER** to return to the **Main Menu**.

Note: Arbitrary results will always be printed.

Analyzer Configuration

Select **Analyzer Configuration** from the **Main Menu** to display the screen below.

Analyzer Configuration		
Printer Setup		
Sound :	On	
Barcode reader :	No	
Language :	English	
Date/Time		
Auto Number Reset	Yes	000
→ Exit	Press ENTER to change	

Press **▲** or **▼** to move **→** to make changes. After all changes are made, select **EXIT** and press **ENTER** to save changes and return to the **Main Menu**. If **User Login** is enabled and **Operator ID** is 11 through 20, this **Menu** cannot be changed.

Printer Setup

Select **Printer Setup** to display the screen below.

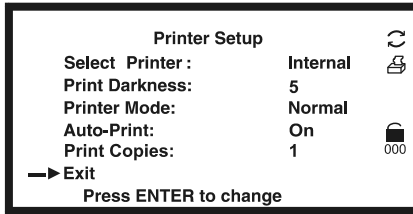

Press ▲ or ▼ to move → to select the options listed below. Press **ENTER** to change the option as shown below.

Select Printer	Internal or External
Print Darkness	1 through 9
Printer Mode	Normal or Expand fonts
Auto-print	On or Off
Print Copies	1 to 3

Select **Exit** and press **ENTER** to save changes. The screen will then return to the previous **Menu**.

Select Printer

Internal prints the results on the internal printer.

External prints the results on an external printer. The symbol **EXT** will display on all screens. Contact your local distributor for a list of printers and printer cables that can be used.



Print Darkness

Print darkness ranges from **1** to **9**. The darkest is **9**. After **9** it reverts back to **1**. The default is **5**.

Printer Mode

Normal prints the standard font size and saves paper. **Expand** prints a larger font size and uses more paper.

Auto-print

Auto-print On prints the results after each test.  is displayed. **Auto-print Off** requires pressing the **Print** key to print the results.  is not displayed.

Print Copies

Print Copies defines the number of result copies printed at one time. **Print Copies** can be set from 1 to 3.

Sound

Select **Sound** and press **ENTER** to cycle the options to **Off**, **On** and **Prompts**. These options function as listed below.

Off – internal speaker is **Off** in all cases.

On – Internal speaker is **On** in all cases (keyboard and prompts).

Prompts – Internal speaker is **On** only for prompts to the operator.

Select **Exit** with → and press **ENTER** to save changes. The screen will return to the **Main Menu**.

Barcode reader

Select **Barcode reader** and press **ENTER** to display **Yes** to allow Barcode reading. Press **ENTER** to cycle between **Yes** or **No**. **Yes** displays prompt for full usage of the Barcode reader. The **Barcode reader** icon  will be shown. If the optional Barcode reader is not present, this setting should be set to **No**.

Select **Exit** with → and press **ENTER** to save changes. The screen will return to the **Main Menu**.

Language

Select **Language** and press **ENTER** to change the current language. Each time **ENTER** is pressed the language changes.

Select **Exit** with → and press **ENTER** to save changes. The screen will return to the **Main Menu**.

Date/Time

Select **Date/Time** and press **ENTER** to display the screen to change the date/time as shown below.

Select **Exit** and press **ENTER** to save changes. The screen will return to the previous **Menu**.

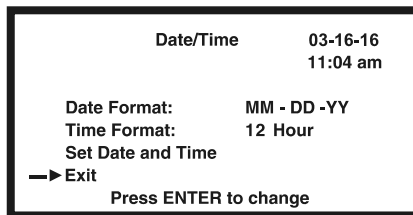

Press ▲ or ▼ to move → to the options listed below. Press **ENTER** to change the selected option.

Date Format

Select **Date Format** and press **ENTER** to cycle to **MM-DD-YY**, **YY-MM-DD** or **DD-MM-YY**.

Time Format

Select **Time Format** and press **ENTER** to cycle to **24 Hour** or **12 Hour**. **12 Hour** displays the time with **am/pm** symbols.

Set Date and Time

Select **Set Date and Time** and press **ENTER** to display a new screen for setting the current date and time.

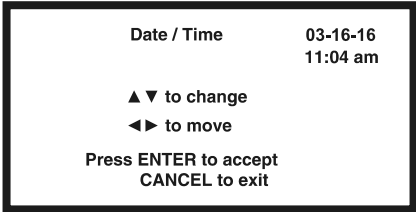

The first digit to be changed in the date will be highlighted. Press **▲** or **▼** to change the number one at a time. Continue to press **▲** or **▼** until the correct number is shown. Press **◀** or **▶** to progress to the next digit to be changed. Press **▲** or **▼** to increase or decrease the number. Change each of the time and date digits/fields in this manner. Press **ENTER** to save the changes and exit the screen. Press **CANCEL** to not accept any changes and exit the screen. Either key will return to the previous screen.

Auto Number Reset

Select **Auto Number Reset** and press **Enter** to cycle to **Yes** or **No**. If **Yes**, the test number will reset to 000001, 100001 or 200001 for **Routine**, **STAT** or **QC** modes each day. If **No** the test number is unaffected by date.

Database

Select **Database** and press **ENTER** to display the screen below.

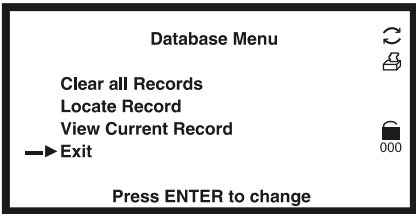

Press **▲** or **▼** to move **→** to enter each screen and make changes. After all changes are made press **ENTER** to save changes and return to the **Main Menu**.

Up to 2000 records can be stored in memory. If **User Login** is enabled and **Operator ID** is 11 through 20, the operator can only review data stored in the analyzer.

Caution: Use a number higher than the previous test number.

If there are 2000 records stored in memory, the oldest record will be erased and replaced.

Records may have the same number but different dates and times.

Clear all Records

Select **Clear all Records** and press **ENTER**. If **User Login** is enabled and **Operator ID** is 11 through 20, the analyzer will not respond.

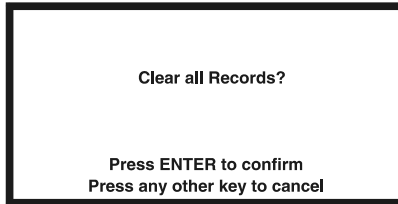

Press **ENTER** to delete all records. A prompt will appear. Once records are deleted they cannot be recovered. The **Test Number** will reset to 000001, 100001 or 200001 depending on the Test Mode. Press any other key to cancel. The screen will return to the **Database Menu**.

Locate Record

Select **Locate Record** and press **ENTER**.

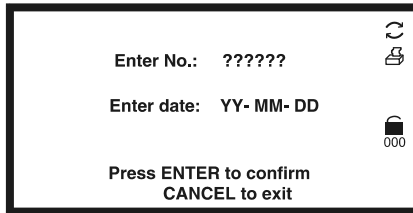

Press the number keys to enter the **Test Number** and/or test **Date**. Press **Enter** to view the results.

If only the **Test Number** is entered records with the current **Date** will be searched.

If there is no **Test Number** with the current **Date**, the latest previous **Date** will be searched. For example, assume the current date is 2017-03-27. There are two records with the same **Test Number** but dates of 2017-03-26 and 2017-03-20. The test from 2017-03-26 will be displayed.

If there is no record found **Record not found** will be displayed. Press any key to return to the **Database Menu**.

Press **Print** to print a record.

Press ▼ to view the previous record. Press ▲ to view the next record.

Press **CANCEL** to return to the previous screen. Additional records can be located, reviewed or printed.

View Current Record

Select **Current Record** and press **ENTER** to show the data from the current or last record.

Press **Print** to print a record once it is displayed.

Press **▼** to view the previous record. Press **▲** to view the next record.

Press **CANCEL** to return to the previous screen.

Self Test

Select **Self-Test** and press **ENTER** to perform self-tests. A results screen will display the results of each test.

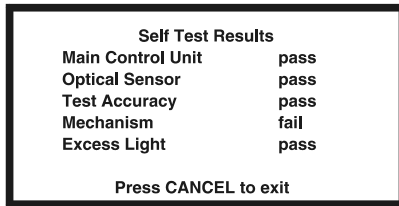

After each test, a **pass** or **fail** is displayed on the screen. If any results **fail**, the unit will not operate. Refer to Section 10 Troubleshooting.

Press **CANCEL** to return to the **Main Menu**.

QC Test

Select **QC Test** and press **ENTER**. If **User Login** is enabled and **Operator ID** is 11 through 20 the operator can only view settings and run a QC test.

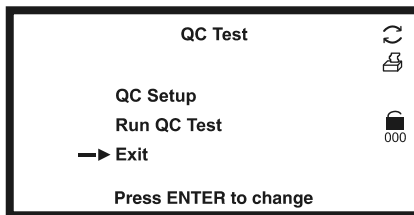

Press **▲** or **▼** to move → to make changes. Select **Exit** and press **ENTER** to save changes.

QC Setup

Select **QC Setup** and press **Enter**.

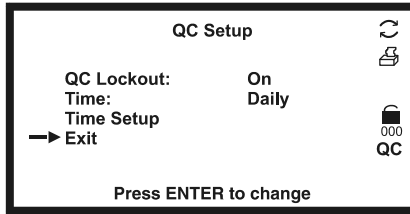

QC Lockout

Select **QC Lockout** and press **ENTER** to cycle the options **Off** or **On**.

Off disables the QC lockout function. The **QC** symbol and Setup Options are not displayed.

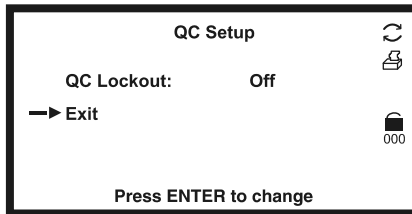

On enables the QC lockout function. The **QC** symbol is displayed. QC Lockout timing can be set for **Every 8 Hours**, **Daily**, **Weekly** or **Monthly**.

Time

Select **Time** and press **ENTER** to set the QC test for **Every 8 Hours**, **Daily**, **Weekly** or **Monthly**.

Time Setup

Select **Time Setup** and press **ENTER**.

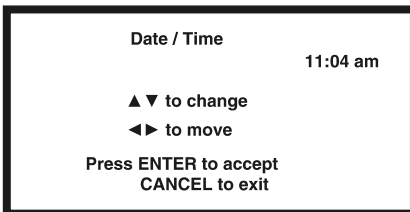

Every 8 Hours / Daily

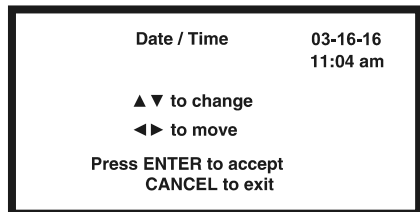

Weekly / Monthly

The first highlighted digit will be changed. Press **▲** or **▼** to change. Continue to press **▲** or **▼** until the correct number is shown. Press **◀** or **▶** to progress to the next digit to be changed. Press **▲** or **▼** to increase or decrease the number. Change each of the time and date digits/fields in this manner until the desired date is shown. Press **ENTER**

to save the changes and exit the screen. Press **CANCEL** to not accept changes and exit.

There is no **Date Setup** if QC tests are set for **Every 8 Hours** or **Daily**.

For the **Monthly** option, **Date** can be set from 01 to 28. 29, 30 and 31 are invalid.

Run QC Test

Select **Run QC Test** and press **ENTER** to perform a QC test before the next scheduled test time.

When a QC test is run for the first time, the analyzer will show the screen below if QC values have not been set up.

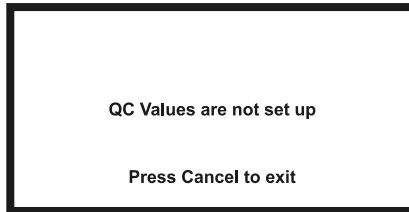

Setting the QC Values

From the Initial Screen, enter the passcode 420024 to show the QC value setup screen.

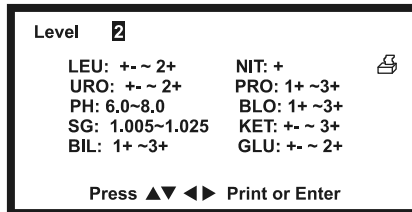

Press **▲** or **▼** to change the highlighted digit. Press **◀** or **▶** to move to the digit to be changed. Press **▲** or **▼** to increase or decrease the value. Change each of the analyte QC values in this manner until the desired values are shown. Press **ENTER** to save the changes and exit the screen. Press **PRINT** to print the current values.

Note: Please set up the QC values, according to the urine control expected values insert. The U120 QC set-up screen recognizes only arbitrary values.

User Login

Press **ENTER** from the Initial Screen to show the Administrator login screen. The Operator ID is preset to 100.

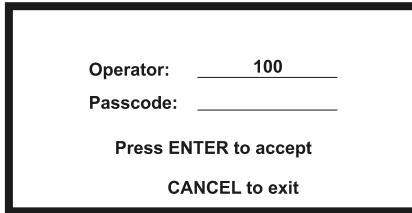

Operator: 100
Passcode: _____
Press ENTER to accept
CANCEL to exit

On entry to this screen for the first time, leave the **Passcode** blank and press **ENTER**. Press **CANCEL** to return to the Initial Screen without enabling User Login.

ID Admin

The Administrator screen is shown.

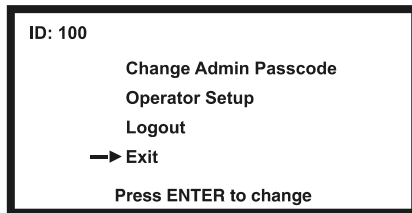

ID: 100
Change Admin Passcode
Operator Setup
Logout
→ Exit
Press ENTER to change

Press **▲** or **▼** to move the **→** to make changes. If Passcode is blank, user login is not yet enabled and only **Change Admin Passcode** can be chosen. Select **Exit** and press **ENTER** to save changes.

Change Admin Passcode

Change the passcode from blank to a valid passcode, select **Change Admin Passcode** and press **ENTER**.

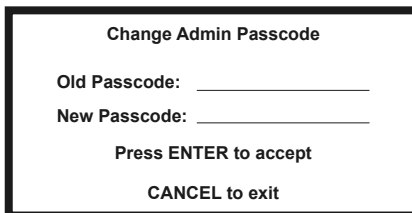

Change Admin Passcode
Old Passcode: _____
New Passcode: _____
Press ENTER to accept
CANCEL to exit

A non-blank passcode must be entered to enable **User Login**. If a blank is entered, a new screen will indicate the passcode is invalid. After 3 seconds, the screen will return to the login screen.

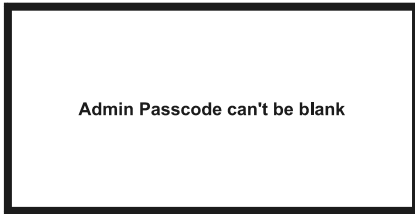

Press **CANCEL** to keep the existing passcode and exit.

Scan or enter a valid **Passcode** and press **ENTER** to accept and exit. **User Login** will be enabled.

Operator Setup

After **User Login** is enabled, select **Operator Setup** and press **ENTER**.

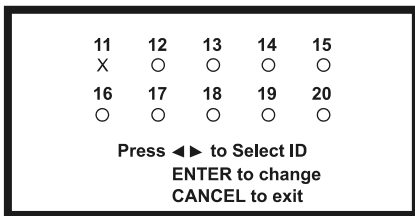

X indicates the ID is enabled. **O** indicates the ID is not enabled

Press ◀ or ▶ to move the cursor to the desired ID. Press **ENTER** for the **Passcode** screen.

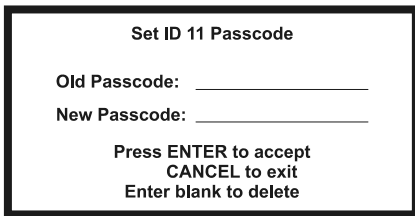

Scan or enter a new **Passcode**. Press **ENTER** to save the settings and exit. Press **CANCEL** to cancel the settings and exit. Enter a blank **Passcode** to disable the ID.

Logout

After the User Login is enabled, select **Logout** and press **ENTER** to log out. The normal Login screen will be shown for a new operator login. See Section 5 for Login procedures.

Operator: _____
Passcode: _____

Press ENTER to accept
CLEAR to clear

Press **CLEAR** from the Initial Screen to logout and display the Login Screen shown above.

If you forgot the passcode, please call 1-800-838-9502 for technical assistance.

Section 5 Analyzer Operation

If **User Login** is not enabled, the Initial Screen will be shown after Self-Test. Refer to Section 3 Initial Startup.

If **User login** is enabled, the analyzer will display a login screen after Self-Test.

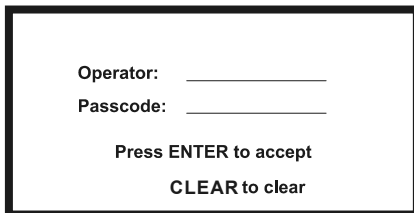

Operator: _____
Passcode: _____

Press ENTER to accept
CLEAR to clear

Enter the **ID** and enter or scan the **Passcode**. Press **ENTER** to run the analyzer. Press **CLEAR** to return to the login screen.

If the **Passcode** is incorrect, the analyzer will indicate a passcode error. After 3 seconds, the screen will return to the login screen.

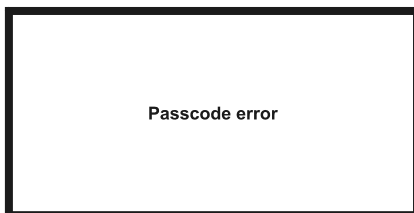

Passcode error

If the **Passcode** is correct, the analyzer will display the Initial Screen. The logged-in ID will be shown (11-20, or 100).

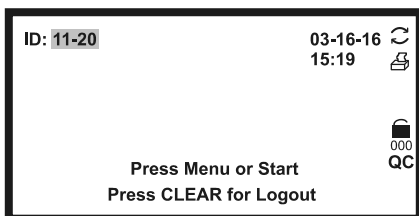

ID: 11-20 03-16-16 15:19

Press Menu or Start
Press CLEAR for Logout

000 QC

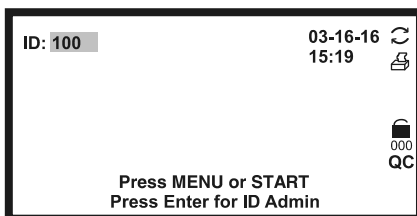

ID: 100 03-16-16 15:19

Press MENU or START
Press Enter for ID Admin





000 QC

The user ID will be 11-20 for Operators. This provides access to operate the analyzer, change test modes and test number, and review settings. Press **CLEAR** from the Initial Screen to logout and display the Login Screen.

The user ID will be 100 for the Administrator. This provides full access to operate the analyzer and change settings. Press **ENTER** from the Initial Screen to display the ID Admin Screen. Press **CLEAR** from the Initial Screen to logout and display the Login Screen.

Press **START** on the Initial Screen to test strips. Check all settings and strip types before testing.

During testing, the screens will display icons showing the status, options available and prompts for testing:

No. 000001	The sequential test number assigned to the next test to be run. In Routine Mode, the first digit will be 0 . In STAT Mode, the first digit will be 1 . In QC Mode, the first digit will be 2 .
10U	Indicates the proper strip to be tested has 10 test pads. Select the strip configuration using the MENU function from the Initial Screen. The strip type must match the strip being used or result will not be displayed.
Mode	Indicates the current mode setting. Available modes are Routine , STAT and QC . Press ENTER from this screen to change the mode. Continue to press ENTER to cycle through each mode. The mode may be changed when this prompt appears.
	When visible, Continuous Test is set to test up to 120 tests per hour. If not, Single Test is set to test one strip at a time up to 60 tests per hour.
	When visible, the printer is set to Auto-print . Test data is sent to the internal printer and data ports after each test. Results are displayed on the screen. If this icon is not visible, press Print to send results to the printer and data port.
	When visible, Auto-Print is On . Test data is sent to the external printer and data ports after each test.
	When visible, indicates the Barcode reader is enabled.
EXT	If only EXT is visible, Auto-Print is Off . Press Print to send test data to the printer and data port.
	Strip Lockout is available. The analyzer will only test strips with correct barcodes. There will be no symbol if Strip Lockout is not an included function.
QC	When visible, indicates QC Lockout is On . When the scheduled test time arrives, this symbol will flash. A beep will be heard to prompt that a QC test is required before performing additional tests.

Entering Canister Code

If the Strip Lockout is included, prior to your first test or when a new canister of strips is required, the analyzer will request that a canister code is entered from the new canister. The code can be entered manually from the keypad, or scanned with the Barcode reader, if installed.

At first startup, the Strip Holder will fully extend. The screen below will be displayed.

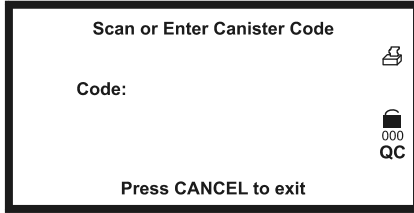

Scan or manually enter the canister code from the strip canister.

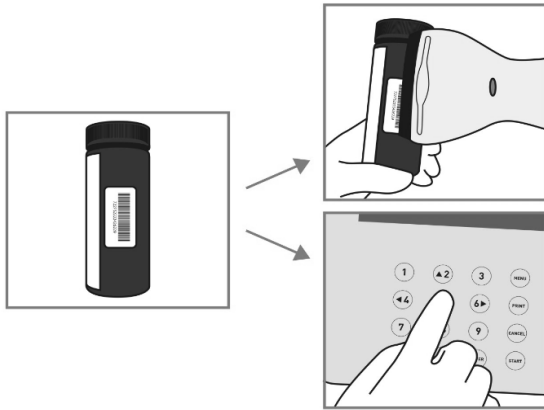

Press **CLEAR** to move the cursor to the proper digit if you entered an incorrect number. Edit the number as needed. After the last digit of the correct code is entered, the next screen will be shown. Press **CANCEL** to cancel the changes and exit the screen.

If the canister code is incorrect, the following screen will show.

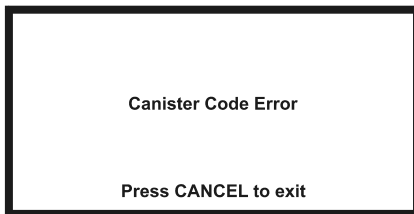

Press **CANCEL** to exit to the previous screen.

If the canister code is correct, the analyzer will proceed to the Initial Screen.

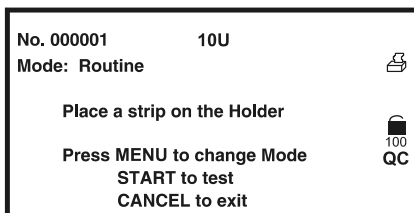

Note: Refer to Section 4, Analyzer Setup, to change the settings.

When there are only 5 strips remaining,  will flash to prompt that a new canister of strips is required. The number of strips left can be seen under .

When the current run is completed, enter the new canister code. The number under  will be increased accordingly.

Note: Refer to the following for more information on the **Strip Lockout function**. Once a canister code is accepted, the analyzer will automatically recognize the Type of Strip and the number of strips per canister should be tested. The analyzer will keep track of the number of strips available for testing and the strips remaining will be displayed under the lock symbol. **Continue testing as usual until the analyzer prompts that a new canister code is required. When the analyzer prompts that a new canister code is required, scan or manually enter a canister code from a new canister to be used, or from the one currently in use.** The analyzer will not accept canister codes that have already been entered and will lockout the user until a new canister code is entered. One canister code can be entered for each Type of Strip, and will be managed independently of other strip types by the analyzer.

Normal Operation, no Barcode reader

Sample/Strip Preparation

Allow the strip, urine specimen, and/or controls to reach room temperature at 15-30°C (59-86°F) prior to testing.

Note: Only *Mission*[®] Urinalysis Reagent Strips work with the *Mission*[®] U120 Smart Urine Analyzer. Use of any other strips will cause inaccurate results.

Remove the strips from the closed canister. Use them as soon as possible. Tightly close the canister after removing the strips.

Strip Test – Single Test Mode

Press **START** for the strip prompt. Wait for the audible triple beep to immerse the strip.

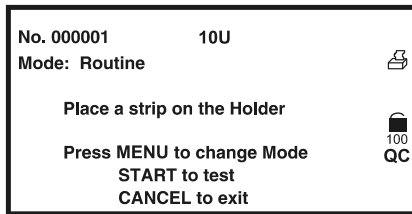

Once **START** is pressed, the screen below will show.

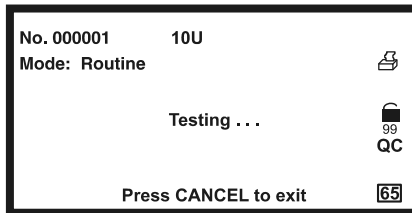

The countdown clock is displayed on the bottom right. The clock will start to count down from **65**. The operator has 3 seconds before the triple beep sounds to immerse the strip into the urine.

Upon hearing the triple beep and/or seeing the countdown clock reach **62**, completely immerse the reagent areas of the strip in fresh, well-mixed urine. Immediately remove the strip to avoid dissolving the reagents.



Run the edge of the strip against the rim of the urine specimen container to remove excess urine. Hold the strip in a horizontal position. Bring the edge of the strip into contact with an absorbent material (e.g. a paper towel). This prevents mixing chemicals from adjacent reagent areas.

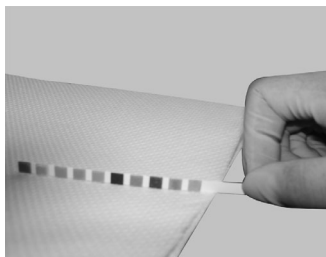

Place the strip with the reagent area facing up, onto the Strip Holder Channel. Make sure the strip end touches the Strip Holder Backstop as shown below.



Note: In order to avoid contamination of the strip holder and/or the optical sensor, make sure that the strip holder is fully extended and at a standstill before placing or removing a urine strip from the strip holder.

When the countdown clock on the display reaches 1, the Strip Holder will carry the strip inside and begin testing.

An automatic calibration is done before each test.

The results will be displayed on the screen and stored in memory after each test. Any abnormal results will be highlighted on the screen and flagged on the print out.

If **Auto-print** is set to **on** the results will be printed. If **Auto-print** is set to **off**, press **Print** to print the results.

Remove the used strip from the Strip Holder when the strip carrier moves out. Discard the used strip according to local regulations.

Repeat the previous steps to test more urine.

Strip Test – Continuous Test Mode

Press **START** when the Strip Holder is fully extended to begin the test. The following screen will be displayed. Wait for the audible triple beep to immerse the strip.

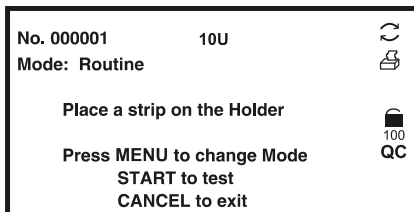

Note: Timing is set up to process a new strip every 30 seconds.

Once **START** is pressed, the screen will change to the following:

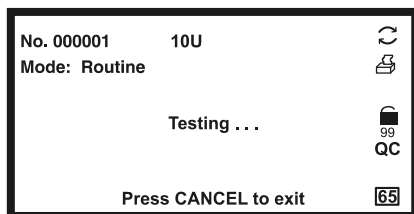

The countdown clock is displayed on the bottom right of the screen. The clock will start to count down from **65**. The operator has 3 seconds before the triple beep sounds to immerse the strip into the urine.

Upon hearing the triple beep and/or seeing the countdown clock reach **62**, completely immerse the reagent areas of the strip in fresh, well-mixed urine. Immediately remove the strip to avoid dissolving the reagents. Handle and test the strips as described in Strip Tests - Single Test Mode above.

Place the first strip onto the Strip Holder Channel. Ensure the reagent pads face up. Make sure the end of the strip touches the Strip Holder Backstop.

Listen for the next triple beep and/or see the countdown clock reach **32**. Immerse a new second strip in fresh, well-mixed urine. Repeat the strip testing steps above. Lay the second urine-exposed strip on a paper towel, with reagent pads up. Wait for the first strip to complete testing and the Strip Holder to move out.

Listen for the next triple beep and/or see the countdown clock reach **2**. Immerse a new third strip in fresh, well-mixed urine. Repeat the strip testing steps above. Lay the third strip on a paper towel with reagent pads up. Wait for the Strip Holder to move out.

Note: When the countdown clock reaches 1, the Strip Holder will carry the first strip inside. The countdown clock also returns to **30**. The results will be displayed on the screen for several seconds and stored in memory. If **Auto-print** is **on**, the results will be printed.

Remove the completed first strip after the Strip Holder moves out. Immediately place the second strip on the Strip Holder before the countdown clock reaches **1**. The Strip Holder will carry the new strip inside for analysis.

Note: The operator has about 8 seconds to discard the used strip and place the next strip on the Strip Holder.

After the first time the countdown clock reaches **1**, it will return to **30** instead of **65**. A triple beep occurs every 30 seconds. This prompts the operator to immerse a new strip.

Discard the used strip according to local regulations.

Repeat the above process for additional urine specimens.

Press **Cancel** to stop testing when all tests are done.

Normal Operation, Barcode reader installed

Plug the RS232C cable from the **Barcode reader** into the **Standard RS232C Port** in the back of the analyzer. Use the cable supplied with the **Barcode reader**. Refer to Appendix 5 **Barcode reader** for specifications and compatibilities.

If both the optional **Barcode reader** and external data transmission capability are used at the same time, use the serial splitter cable to connect both external computer and **Barcode reader** to the analyzer **Standard RS232C port**.

Ensure the analyzer parameters are configured properly as described in **Section 4 Analyzer Setup**, with **Barcode Reader** set to **Yes**. Turn the power switch located at the back panel of the analyzer on.

Strip Test – Single Test Mode with Barcode reader

Press **START** from the Initial Screen.

A prompt to scan the Barcode ID with the reader will display. If a Barcode reader is installed, holding the **Barcode reader** over the barcode on the specimen container, press the Scan button on the **Barcode reader**. A red illuminated line will appear over the barcode to be read. Move the **Barcode reader** to align the red line over the barcode. Position it until the **Barcode reader** beeps, indicating the barcode has been scanned. When the reading has been completed, it will appear next to **ID**. **ID** will reflect the last barcode read by the reader. It will change every time a new barcode is read until **START** is pressed to begin the test.

If a **Barcode reader** is not installed, enter the **ID** manually using the keypad. Press **CANCEL** to clear the input, **START** to begin the test.

Press **MENU** to change the current testing mode.

After the barcode is entered, **ID** will display. Review the ID before testing the strip.

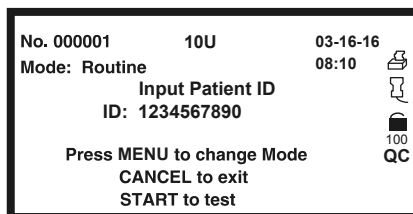

Press **START** after the **ID** has been entered to display the next screen.

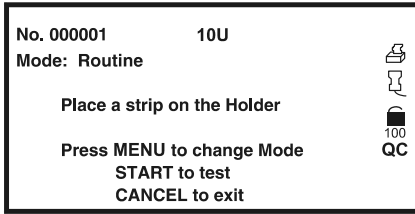

Press **START** again to begin strip testing. The strip is tested the same as other single test modes. The results screen will show the sample ID in the **ID** field.

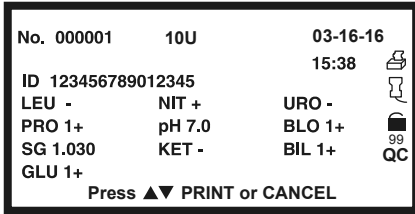

If **Auto-print** is **Off**, press **PRINT** from the results screen to print results. Press **CANCEL** to return to the previous barcode entry screen.

Strip Test – Continuous Test Mode with Barcode reader

If **Barcode reader** is **On** and  is displayed, samples are tested in batch mode. Holding the **Barcode reader** over the barcode on the specimen container, press the Scan button on the **Barcode reader**. A red illuminated line will appear over the barcode to be read. Move the **Barcode reader** to align the red line over the barcode. When the **Barcode reader** beeps the barcode has been scanned. All sample barcode IDs in a batch are read and stored in memory in sequence. Samples must be run in the same sequence as scanned. This ensures IDs and samples correspond. Prompts are displayed to show the next sample to be tested.

Press **START** to begin the batch mode.

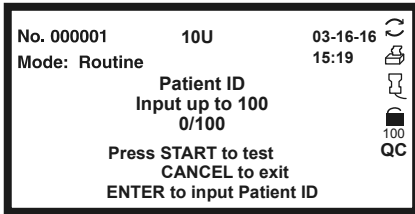

Press **CANCEL** to return to the **Initial screen**.

Press **ENTER** to enter a new screen to edit the Barcode ID.

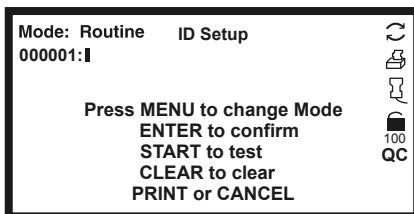

Note: Same patient ID will not be accepted when in continuous input.

Using the keypad or barcode reader to enter the Barcode ID, press **ENTER** to confirm the ID entered and enter the next number.

Press **CLEAR** to clear the entered ID. Press **PRINT** to print the list of IDs. **CANCEL** to exit to the previous screen.

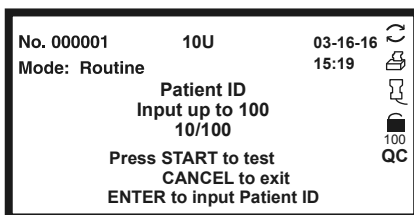

Press **START** to save the IDs and return to the previous screen.

Up to 100 barcodes can be read. The screen will indicate how many barcodes have been read.

Note: Do not change **Barcode reader** or Test number settings before all barcodes have been processed. Otherwise remaining barcodes may be deleted.

Press **START** to begin strip testing. The testing screen will be displayed as shown below. This screen example shows a total of 10 strips to be run. It asks for the first strip to be placed on the Strip Holder.

Note: In order to avoid contamination of the strip holder and/or the optical sensor, make sure that the strip holder is fully extended and at a standstill before placing or removing a urine strip from the strip holder.

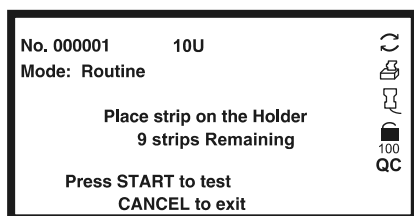

The next screen shows the barcode of the sample to be run and the next sample ID to be run. This reduces the possibility of error and mismatch between the barcode and the sample to be run.

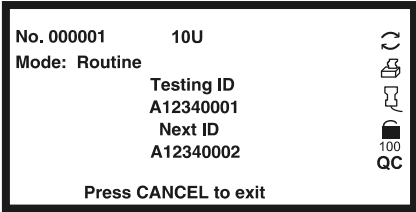

When the test is complete, the **Results Screen** will show briefly. The next strip can be placed on the Strip Holder.

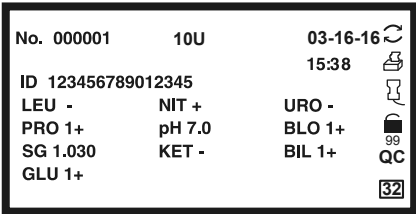

Stop testing by pressing **CANCEL** when the prompt appears. All other testing procedures are the same as testing with no barcode.

Urine Controls QC Testing

Ensure the operating **Mode** is set to **QC**. All test numbers in QC mode will begin with **2**. This allows results to be searched for and found easily.

Strip Preparation

Allow the strip and urine controls to reach room temperature at 15-30°C (59-86°F) prior to testing.

Note: Use *Mission*[®] Urinalysis Reagent Strips for proper functioning and accurate results.

Remove strips from the closed canister and use them as soon as possible. Close the canister tightly immediately after removing the strips.

Urine Control Test Procedures

The urine control test procedures are the same as Normal Operation, no Barcode reader, or Normal Operation, Barcode reader installed. Refer to Section 5 Analyzer Operation.

The results obtained during the Quality Control test will be referenced by the analyzer

with pre-programmed target values and report generated, if **Auto-print** is set to **On**, the result will be printed.

If the QC test "Fails", please contact your local distributor for Technical Support.

QC lockout

When **QC lockout** is turned **On**, the user will be notified when a QC test is required. The following screen will be displayed. The **QC** symbol will flash.

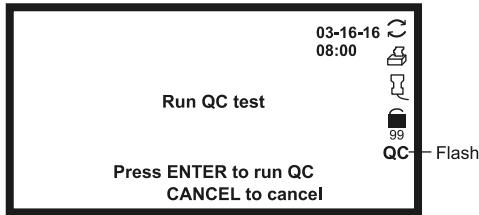

Note: Use *Mission*[®] Urinalysis Reagent Strips for proper functioning and accurate results.

If it is the first time to run the QC test, refer to the section on **Setting the QC Values** to set up QC test values.

Press **CANCEL** to return to the Initial Screen. If canceled, the analyzer will change the test mode to **STAT**. An "E" will be displayed after the test number on all printouts to show QC tests were out of date and pending.

Press **ENTER** to run QC tests.

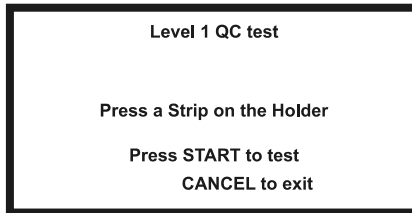

The analyzer will run a Level 1 QC test first. Refer to the Strip Test section for details on testing.

After testing, the analyzer will display the testing results.

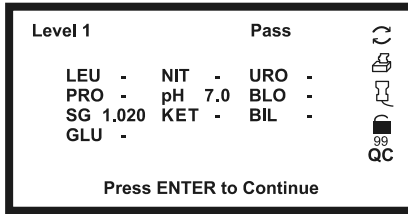

If any parameter is out of range, it will be highlighted and marked with a “*”.

If **Auto-print** is set to **On**, the result will be printed.

Press **ENTER** to test control Level 2. The steps are the same as for Level 1.

When Both QC Tests pass, the “E” at the end of the test number will not be shown.

Date: 2016-03-16	16:54
Operator: 11	
Level 1	Pass
No. 200021	
LEU	- neg
NIT	- neg
URO	- 0.2 mg/dL
PRO	- neg
pH	6.0
BLO	- neg
SG	1.030
KET	- neg
BIL	- neg
GLU	- neg

Date: 2016-03-16	16:54
Operator: 11	
Level 2	Pass
No. 200021	
LEU	2+ 125 Leu/uL
NIT	+ Pos
URO	1+ 2 mg/dL
PRO	3+ 300 mg/dL
pH	8.0
BLO	3+ 200 Ery/uL
SG	1.010
KET	2+ 40 mg/dL
BIL	2+ 2 mg/dL
GLU	2+ 500 mg/dL

Section 6 Data/Communication

The RS232 and USB ports can communicate with an external (optional) PC.

If **Auto-print** is **On**, the printed data on the internal printer is also sent to the RS232 and USB ports. Connect either RS232 or USB cable to the back of the analyzer to a PC with suitable software. All external equipment shall comply with the relevant safety standards.

External Printer

The RS232 port can connect to an optional external printer for printing data.

Barcode Reader

The RS232 port can also connect to an optional Barcode reader. It can read and enter barcoded sample ID information.

Service and Support

Call 1-800-838-9502 for technical assistance regarding details on data transfer, printing data, and/or barcode reader.

Section 7 Quality Control

Each lab should use its own standard and procedures for performance. Test known positive and negative specimens/controls at the following events in accordance with local, state, and/or federal regulations or accreditation requirements.

- A new canister of strips is opened
- A new operator uses the analyzer
- Test results seem inaccurate
- After performing maintenance or service on the analyzer

If the QC tests do not provide expected results, perform the following checks:

- Ensure the strips used are not past their expiration date.
- Ensure strips are fresh from a new canister.
- Ensure the controls are not past their expiration date.
- Repeat the test to ensure no errors were made during the test.

Call 1-800-838-9502 for technical assistance.

Section 8 Maintenance

Loading Printer Paper

Open the printer cover by pulling up on the tab.

Place the new paper roll into the printer paper compartment with the paper unrolling from underneath and towards the compartment wall.

Pull about 4 inches or 10 cm of paper past the top edge of the paper compartment

Note: Do not feed paper underneath the paper roller.

Close the printer paper compartment by clicking the cover back into its original position.

Press the printer cover after you close the cover to ensure that it is closed properly.

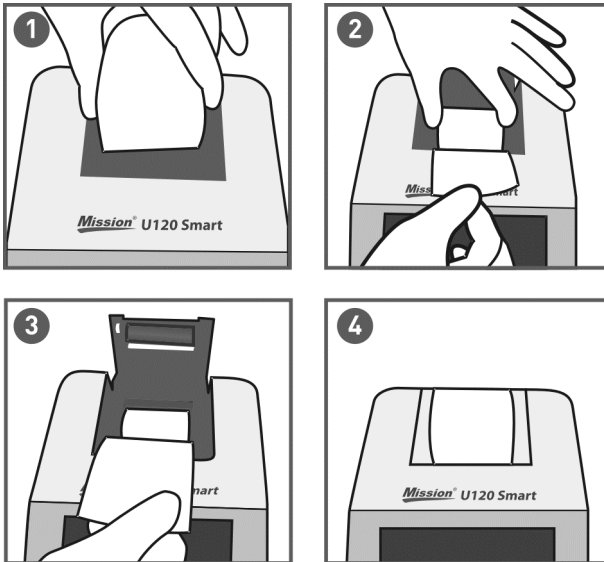

General Cleaning

Keep the surface of the instrument free of dust at all times. If needed, the external surfaces may be cleaned using a damp cloth. Do not use any type of solvent, oil, grease, silicone spray, or lubrication on any part of the instrument.

Daily Cleaning

Remove the Strip Holder

Press **Start** to fully extend the Strip Holder/Mount.

Turn off the Power Switch after the Strip Holder/Mount is fully extended.

Remove the Strip Holder from its mount by pulling out gently by the two sides as shown below.

Clean the Strip Holder

Clean the Strip Holder using a lint free/non-absorbent cotton swab/ball with distilled water. Dry with a clean, dry cotton ball.

Examine the White Calibration Circle to ensure there are no nicks or dirt present. Clean the White Calibration Circle as necessary using a cotton swab or cotton ball with distilled water. Dry with a clean, dry cotton ball.

Note: The White Calibration Circle should be replaced if any nicks or non-removable dirt are found. Call 1-800-838-9502 for technical assistance.

Load the Strip Holder

Grasp the Strip Holder by its sides as shown below. Place the Strip Holder on the Strip Holder Mount with the white Calibration Circle facing up and positioned towards the analyzer. It will slide loosely in the locating channel. Push the Strip Holder in towards the analyzer until it snaps into place. It will be held firmly on the Strip Holder Mount. Ensure the Strip Holder is installed properly. If it is not locked onto the Strip Holder Mount, the Calibration Circle will not be in the correct position. The analyzer will display "Optical Sensor Failed."

Note: When correctly positioned, the Strip Holder will snap into and be locked in place, with the White Calibration Circle not visible. See illustration below.

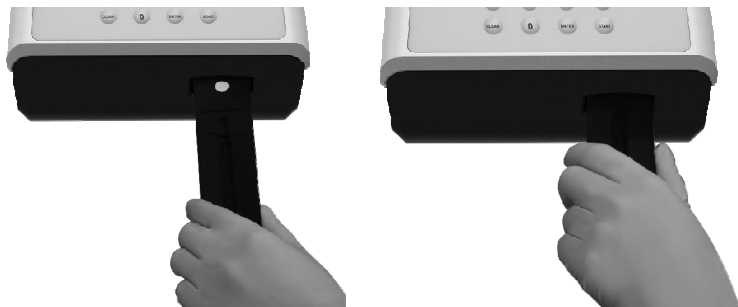

Return the Strip Holder/Mount to its Internal Position

Turn the Power Switch on and wait for the Strip Holder/Mount to move inside the analyzer and stop. Turn the Power Switch off or begin testing strips.

Please refer to Section 5 Analyzer Operation.

Sample Deposit Cleaning

Remove the Strip Holder as above.

Clean the Strip Holder using lint free non-absorbent cotton swab or ball dampened with 0.1 N NaOH.

Warning: Do not allow the NaOH solution to touch the White Calibration Circle.

Clean the excess NaOH from the Strip Holder using a cloth moistened with distilled water.

Dry the Strip Holder with a clean lint free non-absorbent cotton swab or ball.

Replace the Strip Holder and return the Strip Holder/Mount it to its original position as described above.

Strip Holder Sterilization

Remove the Strip Holder and repeat Daily Cleaning above.

Clean the Strip Holder using a lint free non-absorbent cotton swab or ball with one of the following sterilizing solutions:

1. 2% Glutaraldehyde (sufficient density): Refer to detailed instructions on the product label.
2. 0.05% Sodium Hypochlorite Solution: Add 1 mL 5% Sodium Hypochlorite into 99 mL distilled water, or prepare a 1:100 dilution ratio with appropriate final volume.
3. Isopropyl alcohol (70-80%).

Pour the sterilizing solution into a narrow vessel 10 cm (4 inches) high.

Dip the Strip Holder into the sterilizing solution

Caution: Ensure the White Calibration Circle does not touch the solution.

Soak the Strip Holder in the sterilizing solution for 10 minutes.

Remove the Strip Holder, clean and dry it.

Load the Strip Holder and return the Strip Holder/Mount to its original position.

Section 9 Precautions

Follow the precautions listed below for accurate results and operation of the analyzer.

- Equipment should be placed where it is easy to pull the plug from the socket.
- Do not use power cord rated value of which is not sufficient.
- The protection provided by the equipment may be impaired if used in a manner not defined in this user guide.
- Connect to a power connection which contains a working grounding plug.
- Wear gloves to avoid contact with potentially hazardous biological samples during processing strips, or analyzer components.
- Avoid storing or operating the analyzer in direct sunlight, excessive temperature or humidity. Refer to Appendix 1 Urine Analyzer Specifications for operating condition requirements.
- Never place anything within 7 cm of the front of the unit. This will avoid interference with the Strip Holder.
- Keep the unit clean. Wipe it frequently with a soft, clean and dry cloth. Use fresh water when needed.
- Do not clean the unit with substances such as gasoline; paint thinner, benzene compounds or other organic solvents. This will avoid any damage to the Strip Holder, White Calibration Circle, or other components.
- Do not wash the LCD with water. Lightly wipe the LCD with a clean, soft and dry rag.
- The Strip Holder must be kept clean. Wipe the Strip Holder using fresh water daily. Refer to Daily Cleaning in Section 8.
- Follow all local regulations when discarding the unit or its accessories.
- Do not use the unit or the strips outside of the operating temperature ranges listed below.

Analyzer: 0-40°C (32-104°F)

Strips: 15-30°C (59-86°F)

Section 10 Troubleshooting

Problem	Solutions
Strip Position Improper	<ul style="list-style-type: none"> Adjust the strip so the strip end is completely touching the Strip Holder Backstop and centered in the Strip Holder Channel
Strip Missing	<ul style="list-style-type: none"> Insert strip
Strip Error	<ul style="list-style-type: none"> Ensure the type of strip used matches the type of strip setting Ensure the strip brand is compatible with the analyzer Ensure all of the test pads on the strip have been immersed in the specimen
No display on screen	<ul style="list-style-type: none"> Turn the Power Switch on Make sure power is applied to the Analyzer
Printer does not work	<ul style="list-style-type: none"> Make sure Auto-Print is set to On. Refer to Printer Setup instructions Load paper if necessary. Ensure Printer Setup is set for Internal when an external printer is not connected Ensure paper roll is placed correctly. If incorrect, there will be no printout Clean printer roller with ethanol See that the proper side of the thermal paper is inserted in the printer
Main Control Unit Failed	<ul style="list-style-type: none"> Turn the Power Switch off, then on. Perform a Self-Test. Refer to Manual Self-Test section
Optical Sensor Failed	<ul style="list-style-type: none"> Ensure the Strip Holder is locked onto the Strip Holder Mount correctly. The Strip Holder should snap into place and locked onto the Strip Holder Mount. Ensure the white Calibration Circle is clean Clean the Strip Holder and refer to Daily Cleaning section Turn the Power Switch off, then on. Perform a Self-Test. Refer to Manual Self-Test section
Test Accuracy Failed	<ul style="list-style-type: none"> Turn the Power Switch off, then on. Perform a Self-Test. Refer to Manual Self-Test section
Mechanism Failed	<ul style="list-style-type: none"> Remove any obstacles in the path of the Strip Holder Do not touch the Strip Holder when it is moving Turn the Power Switch off, then on. Perform a Self-Test. Refer to Manual Self-Test section
Excess Light Failed	<ul style="list-style-type: none"> Ensure the analyzer is kept away from direct light Ensure the white calibration circle is clean Ensure the Strip Holder is positioned correctly on the Strip Holder Mount. Refer to Daily Cleaning section Turn the Power Switch off, then on. Perform a Self-Test. Refer to Manual Self-Test section
Canister Code Error	<ul style="list-style-type: none"> Ensure the canister code entered is correct Ensure the type of strip used is the same as the analyzer setting.
QC Test Fail	<ul style="list-style-type: none"> Ensure the control is correct Ensure the type of strip is correct Ensure the brand of strip is compatible with the analyzer Ensure all of the reagent pads of the strip have been immersed

Call 1-800-838-9502 for technical assistance.

Appendix 1 Urine Analyzer Specifications

Feature	Specifications
Methodology	Reflectance Photometer
Detection	Photosensitive diode
Throughput	Single Test Mode: 60 tests/hour Continuous Test Mode: 120 tests/hour
Memory	Last 2000 results
Strip Incubation Time	1 minute
Detection Wavelengths	525 nm and 635 nm
Analyzer Ports	Standard RS232C Port for Barcode Reader or Data Transfer, USB Port for Data Transfer, 25 Pin Parallel Port for External Printer
Capabilities	Internal Thermal Printer (included), Optional External Printer (not included), RS232C Barcode Reader (optional), USB or RS232C Data Transfer Cable (optional)
Major Readable Barcodes	See Appendix 5
Available Languages on Screen	English (default in US and select countries) and all available languages
Analyzer Operating Conditions	0-40°C (32-104°F); ≤85% Relative Humidity (non-condensing)
Strip Operating Conditions	15-30°C (59-86°F); ≤85% Relative Humidity (non-condensing)
Power Source	100-240V AC, 50/60Hz, 35 VA
Fuse Type	T2AL250VP
Weight	4.1 lbs. (1.85 Kg)
Dimensions (L X W X H)	27.5 cm x 18.3 cm x 13.9 cm (10.8" X 7.2" X 5.5")
Display Dimensions (L X W)	10.8 cm x 6.5 cm (4.2" X 2.6")

This product complies with EN 61326.

Appendix 2 Performance Characteristics of Urinalysis Reagent Strips

The performance characteristics of the *Mission*[®] Urinalysis Reagent Strips have been determined in both laboratory and clinical tests. The following table indicates performance characteristics for each parameter.

Reagent	Composition	Sensitivity- Visual Reading	Sensitivity – <i>Mission</i> [®] U120 Smart Urine Analyzer Reading
Leukocytes (LEU)	derivatized pyrrole amino acid ester; diazonium salt; buffer; non-reactive ingredients	Detects leukocytes as low as 9-15 white blood cells (Leu/ μ L) in clinical urine.	Detects leukocytes as low as 12-15 white blood cells (Leu/ μ L) in clinical urine.
Nitrite (NIT)	p-arsanilic acid; N-(1-naphthyl) ethylenediamine; non-reactive ingredients	Detects sodium nitrite as low as 0.05-0.1 mg/dL in urine with a low specific gravity and less than 30 mg/dL ascorbic acid.	Detects sodium nitrite as low as 0.05 mg/dL in urine with a low specific gravity and less than 30 mg/dL ascorbic acid.
Urobilinogen (URO)	p-diethylaminobenzaldehyde; buffer and non-reactive ingredients	Detects urobilinogen as low as 0.2-1.0 mg/dL (3.5-17 μ mol/L).	Detects urobilinogen as low as 0.8-1.0 mg/dL (13.6-17 μ mol/L).
Protein (PRO)	tetrabromophenol blue; buffer and non-reactive ingredients	Detects albumin as low as 7.5-15 mg/dL (0.075-0.15 g/L).	Detects albumin as low as 12-15 mg/dL (0.12-0.15 g/L).
pH	methyl red sodium salt; bromthymol blue; non-reactive ingredients	Permits the quantitative differentiation of pH values within the range of 5-9.	Permits the quantitative differentiation of pH values within the range of 5-9.
Blood (BLO)	3,3',5,5'-tetramethylbenzidine (TMB); diisopropylbenzene dihydroperoxide; buffer and non-reactive ingredients	Detects free hemoglobin as low as 0.018-0.060 mg/dL or 5-10 Ery/ μ L in urine specimens with ascorbic acid content of <50 mg/dL.	Detects free hemoglobin as low as 0.018-0.060 mg/dL or 5-10 Ery/ μ L in urine specimens with ascorbic acid content of <50 mg/dL.
Specific Gravity (SG)	bromthymol blue indicator; buffer and non-reactive ingredients; poly (methyl vinyl ether/maleic anhydride); sodium hydroxide	Determines urine specific gravity between 1.000 and 1.030. Results correlate with values obtained by refractive index method within \pm 0.005.	Determines urine specific gravity between 1.000 and 1.030. Results correlate with values obtained by refractive index method within \pm 0.005.
Ketone (KET)	sodium nitroprusside; buffer	Detects acetoacetic acid as low as 2.5-5 mg/dL (0.25-0.5 mmol/L).	Detects acetoacetic acid as low as 4-5 mg/dL (0.4-0.5 mmol/L).
Bilirubin (BIL)	2, 4-dichloroaniline diazonium salt; buffer and non-reactive ingredients	Detects bilirubin as low as 0.4-1.0 mg/dL (6.8-17 μ mol/L).	Detects bilirubin as low as 0.8-1.0 mg/dL (13.6-17 μ mol/L).
Glucose (GLU)	glucose oxidase; peroxidase; potassium iodide; buffer; non-reactive ingredients	Detects glucose as low as 50-100 mg/dL (2.5-5 mmol/L).	Detects glucose as low as 80-100 mg/dL (4-5 mmol/L).

Ascorbic Acid (ASC)	2,6-dichlorophenolindophenol; buffer and non-reactive ingredients	Detects ascorbic acid as low as 5-10 mg/dL (0.28-0.56 mmol/L).	Detects ascorbic acid as low as 8-10 mg/dL (0.45-0.56 mmol/L).
Albumin (ALB)	Ydroxy-5',5"-dinitrophenyl)-3,4,5,6-tetrabromosulfonephthalein; buffer; non-reactive ingredients	Detects albumin as low as 20-30 mg/L	Detects albumin as low as 20-30 mg/L
Creatinine (CRE)	Copper acetate; diisopropylbenzene dihydroperoxide;3,3'5,5'-tetramethylbenzidine; buffer; non-reactive ingredients	Detects urine creatinine between 10 – 300 mg/dL	Detects urine creatinine between 10 – 300 mg/dL
Calcium (CA)	o-Cresolphthalein Complexon; buffer and non-reactive ingredients	Detects urine calcium between 4 mg/dL (1.0 mmol/L) and 40 mg/dL (10mmol/L)	Detects urine calcium between 4 mg/dL (1.0 mmol/L) and 40 mg/dL (10mmol/L)

Note:

- For the parameter arrangement and combination of different Urine Reagent Strips, please refer to the product information on the *Mission*[®] Urinalysis Reagent Strips kit box or canister label.
- Ensure that the type of strip selected corresponds with the strip to be used. If not, it will be detected and display an error.
- Only use *Mission*[®] Urinalysis Reagent Strips with the *Mission*[®] U120 Smart Urine Analyzer for proper functioning and obtaining accurate results.

Appendix 3 URS Parameter Table

Parameter Name (Abbreviation on Display)	Arbitrary	Conventional	SI
Leukocytes (LEU)	-	neg	neg
	±	15 Leu/μL	15 Leu/μL
	1+	70 Leu/μL	70 Leu/μL
	2+	125 Leu/μL	125 Leu/μL
	3+	500 Leu/μL	500 Leu/μL
Nitrite (NIT)	-	neg	neg
	+	pos	pos
Urobilinogen (URO)	-	0.2 mg/dL	3.5 μmol/L
	±	1 mg/dL	17 μmol/L
	1+	2 mg/dL	35 μmol/L
	2+	4 mg/dL	70 μmol/L
	3+	8 mg/dL	140 μmol/L
Protein (PRO)	-	neg	neg
	±	15 mg/dL	0.15 g/L
	1+	30 mg/dL	0.3 g/L
	2+	100 mg/dL	1.0 g/L
	3+	300 mg/dL	3.0 g/L
pH	5.0	5.0	5.0
	5.5	5.5	5.5
	6.0	6.0	6.0
	6.5	6.5	6.5
	7.0	7.0	7.0
	7.5	7.5	7.5
	8.0	8.0	8.0
	8.5	8.5	8.5
Blood (BLO)	-	neg	neg
	±	10 Ery/μL	10 Ery/μL
	1+	25 Ery/μL	25 Ery/μL
	2+	80 Ery/μL	80 Ery/μL
	3+	200 Ery/μL	200 Ery/μL
Specific Gravity (SG)	1.000	1.000	1.000
	1.005	1.005	1.005
	1.010	1.010	1.010
	1.015	1.015	1.015
	1.020	1.020	1.020
	1.025	1.025	1.025
	1.030	1.030	1.030
Ketone (KET)	-	neg	neg
	±	5 mg/dL	0.5 mmol/L
	1+	15 mg/dL	1.5 mmol/L
	2+	40 mg/dL	4.0 mmol/L
	3+	80 mg/dL	8.0 mmol/L
Bilirubin (BIL)	-	neg	neg
	1+	1 mg/dL	17 μmol/L
	2+	2 mg/dL	35 μmol/L
	3+	4 mg/dL	70 μmol/L

Bilirubin (BL) -13CE/14C	-	neg	neg
	1+	1 mg/dL	17 µmol/L
	2+	3 mg/dL	50 µmol/L
	3+	6 mg/dL	100 µmol/L
Glucose (GLU)	-	neg	neg
	±	100 mg/dL	5 mmol/L
	1+	250 mg/dL	15 mmol/L
	2+	500 mg/dL	30 mmol/L
Glucose (GLU) -13CE/14C	3+	1000 mg/dL	60 mmol/L
	-	neg	neg
	±	50mg/dL	2.8 mmol/L
	1+	100 mg/dL	5.6 mmol/L
	2+	250 mg/dL	14 mmol/L
Ascorbic Acid (ASC)	3+	500 mg/dL	28 mmol/L
	4+	1000 mg/dL	56 mmol/L
	-	neg	neg
Albumin (ALB)	1+	10 mg/dL	0.56 mmol/L
	2+	20 mg/dL	1.14 mmol/L
	3+	40 mg/dL	2.28 mmol/L
	-	neg	neg
Creatinine (CRE)	10 mg/L	10 mg/L	10 mg/L
	30 mg/L	30 mg/L	30 mg/L
	80 mg/L	80 mg/L	80 mg/L
	150 mg/L	150 mg/L	150 mg/L
Calcium (CA)	10 mg/dL	10 mg/dL	0.9 mmol/L
	50 mg/dL	50 mg/dL	4.4 mmol/L
	100 mg/dL	100 mg/dL	8.8 mmol/L
	200 mg/dL	200 mg/dL	17.7 mmol/L
	300 mg/dL	300 mg/dL	26.5 mmol/L
A:C	4 mg/dL	4 mg/dL	1.0 mmol/L
	10 mg/dL	10 mg/dL	2.5 mmol/L
	20 mg/dL	20 mg/dL	5.0 mmol/L
	30 mg/dL	30 mg/dL	7.5 mmol/L
	40 mg/dL	40 mg/dL	10 mmol/L
P:C	<30 mg/g Normal Dilute	<3.4 mg/mmol Normal Dilute	<3.4 mg/mmol Normal Dilute
	<30 mg/g Normal	<30 mg/g Normal	<3.4 mg/mmol Normal
	30-300 mg/g Abnormal	30-300 mg/g Abnormal	3.4-33.9 mg/mmol Abnormal
	>300 mg/g High Abnormal	>300 mg/g High Abnormal	>33.9 mg/mmol High Abnormal
	>300 mg/g High Abnormal	>300 mg/g High Abnormal	>33.9 mg/mmol High Abnormal
P:C	<30 mg/g Normal Dilute	<30 mg/g Normal Dilute	<3.4 mg/mmol Normal Dilute
	<30 mg/g Normal	<30 mg/g Normal	<3.4 mg/mmol Normal
	30-150 mg/g Abnormal	30-150 mg/g Abnormal	3.4-17.0 mg/mmol Abnormal
	150-300 mg/g Abnormal	150-300 mg/g Abnormal	17.0-33.9 mg/mmol Abnormal
	300-500 mg/g Abnormal	300-500 mg/g Abnormal	33.9-56.6 mg/mmol Abnormal
>500 mg/g Abnormal	>500 mg/g Abnormal	>56.6 mg/mmol Abnormal	

Appendix 4 Result Print-Out

The printed results are shown below. Arbitrary units will always be printed. Either Conventional or SI unit results will also be printed depending on the units set.

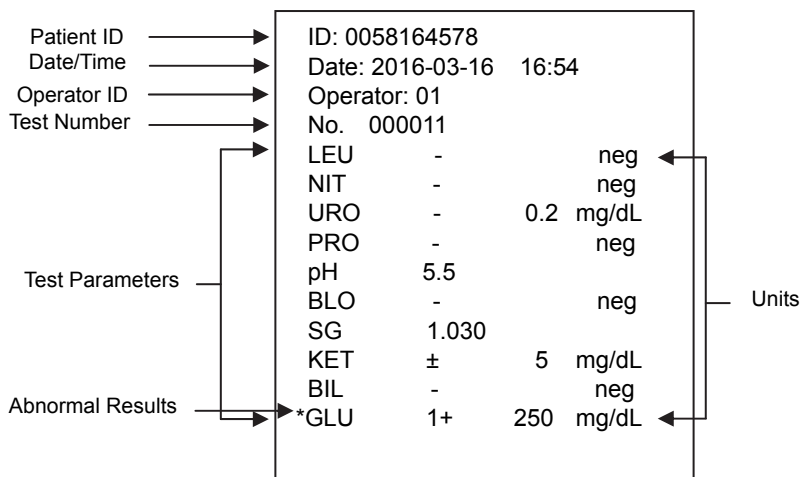

Depending on the type of strip selected, the analyzer recognizes the parameter order and automatically ranks the display and printing sequence of each parameter. Arbitrary results will always be printed automatically. Conventional or SI results will be printed based on the units selected. Abnormal results, or results of pathological significance will be marked with an *.

Arbitrary Results:

- All positive results except pH, Specific Gravity (SG), Albumin (ALB), Creatinine (CRE) and Calcium (CA) will be reported as 1+, 2+, or 3+.
- Positive results for pH, Specific Gravity (SG), Albumin (ALB), Creatinine (CRE) and Calcium (CA) will be reported with the respective data.
- Negative results for Leukocyte, Nitrite, Urobilinogen, Protein, Blood, Ketone, Bilirubin, Glucose and Ascorbic Acid will be reported as "-".

Conventional or SI:

- All positive results except Nitrite (NIT) will be reported with the respective data in front of the units. The positive results of Nitrite will be reported as "pos"
- All negative results except Urobilinogen (URO), Albumin (ALB), Creatinine (CRE) and Calcium (CA) will be reported as "neg." The negative results of Urobilinogen (URO), Albumin (ALB), Creatinine (CRE) and Calcium (CA) will be reported with the respective data in front of the units.

Appendix 5 Barcode Reader

The *Mission*[®] Barcode reader is a laser barcode scanner. The Barcode reader connects to the analyzer to scan the patient (ID) barcode numbers on the specimen containers. The Barcode reader can scan the following:

• Code 39 (Standard/ Full ASCII)	• Codabar (NW-7)	• Code 128
• Italy Pharmacode	• UPCA	• EAN 128
• French Pharmacode	• UPCE	• MSI
• Industrial 25	• EAN8	• Plessey
• Interleave 25	• EAN13	• Telepen
• Matrix 25	• Code 93	• RSS

Note:

A maximum of 20 characters can be read by the barcode reader, displayed, stored, and transmitted by the analyzer.

























Warning: The Barcode reader is a Class 2 LED Product.

DO NOT stare into the beam.

Appendix 6 Catalog

Product Name	Catalog Number	Components	Quantity
<i>Mission</i> [®] U120 Smart Urine Analyzer	U117-101	Urine Analyzer	1
		Printer Paper Rolls	2
		Power Cord	1
		Quick Start Guide	1
		Instruction Manual	1
<i>Mission</i> [®] U120 Smart Urine Analyzer (with Barcode Reader)	U117-111	Urine Analyzer	1
		Printer Paper Rolls	2
		Power Cord	1
		Quick Start Guide	1
		Instruction Manual	1
		Barcode Reader (RS232C)	1
		Serial Splitter Cable (RS232C)	1
Barcode reader	U221-111	Barcode Reader (RS232C)	1
		Serial Splitter Cable (RS232C)	1
Printer Paper Rolls	U121-101	Thermal Paper (0.06 m x 20 m): 200 results/roll	4
		Sticker Paper (0.06 m x 9 m): 100 results/roll; Optional	4
U120 Smart Data Transfer Kit	U127-131	Data Transfer Cable (RS232C or USB)	1
		Package Insert	1

Appendix 7 Index of Symbols

	Attention, see instructions for use		Manufacturer		Authorized Representative
	For <i>In vitro</i> diagnostic use only		Lot Number		Catalog #
	Store between 0-40°C		Tests per Kit		Serial Number
	Keep away from sunlight and heat		Use by	10101	Serial Port
	Keep Dry		Fragile, handle with care		This Side Up
	Continuous Test		Auto-print is on Internal printer is used	EXT	Auto-print is off External printer is used
	Auto-print is on External printer is used		USB Port		25 Pin Parallel External Printer Port
FUSE T2AL250VP	Fuses type		Use only with 250V Fuse		Power Socket
	Grounding	QC	QC Lockout		Barcode reader
	Strip Lockout		Do not dispose along with household waste		

Appendix 8 Warranty

Please complete the warranty card included in the packaging. Mail it to your local distributor to register your purchase.

For your records, write the purchase date of your starter kit here:

Note: This warranty applies only to the analyzer in the original purchase. It does not apply to the other materials included with the analyzer.

ACON Laboratories, Inc. warrants to the original purchaser that this analyzer will be free from defects in materials and workmanship for a period of one year (12 months). The one year starts from the later of the date of original purchase or installation (except as noted below). During the stated one year period, **ACON** shall replace the unit under warranty with a reconditioned unit or, at its option, repair at no charge a unit that is found to be defective. **ACON** shall not be responsible for shipping charges incurred in the repair of such an analyzer.

This Warranty is subject to the following exceptions and limitations:

This warranty is limited to repair or replacement due to defects in parts or workmanship. Parts required which were not defective shall be replaced at additional cost. **ACON** shall not be required to make any repairs or replace any parts that are necessitated by abuse, accidents, alteration, misuse, neglect, failure to operate the analyzer in accordance with the operations manual, or maintenance by anyone other than **ACON**. Furthermore, **ACON** assumes no liability from malfunction or damage to analyzers caused by the use of strips other than strips manufactured by **ACON**. **ACON** reserves the right to make changes in the design of this analyzer without obligation to incorporate such changes into previously manufactured analyzers.

Disclaimer of Warranties

This warranty is expressly made in lieu of any and all other warranties express or implied (either in fact or by operation of law) including the warranties of merchantability and fitness for use, which are expressly excluded, and is the only warranty given by **ACON**.

Limitations of Liability

In no event shall **ACON** be liable for indirect, special or consequential damages, even if **ACON** has been advised of the possibility of such damages.

For warranty service, please contact your local authorized **ACON** distributor.

Mission® U120 Smart Urine Analyzer Warranty Card

Please complete this warranty card and mail it to your local distributor to register your purchase within 30 days of purchase. Refer to **Appendix 8 Warranty** in the Instruction Manual for details and terms of the product warranty.

Date of Purchase	Purchaser	Analyzer Serial Number (e.g. SN 0000000. See label on back of analyzer)
Organization Name		Address
Telephone Number		Email address

