

Plasti-med[®]
"supporting healthy life"



MADE IN TURKEY

RESPIRATORY & ANESTHESIA
Solunum & Anestezi

ABOUT US

Hakkımızda



Plasti-med Company has been established in 1995. Production focuses on disposable medical supplies having main product groups as Respiratory, Anesthesia, Drainage, Urology, Gynecology and general disposables. Plasti-med Company takes place among the biggest producers of medical disposables in Turkey. At the same time exporting its products over 80 countries all over the world.

Our goal is to produce products that comply with the standards, with high quality, competitive prices and our service understanding aimed at customer satisfaction.

Plasti-med has achieved a significant market share in the products in its range. As a result of product development and quality improvement studies according to the needs of the sector, its products have become desirable with the brand "Plasti-med". All of the materials used in production are provided from suppliers that are in compliance with MDD requirements and are recognized and accepted in the sector. Production tools and equipments are selected from among the world well-known and accepted brands of the highest quality in accordance with MDD, GMP and Plasti-med standarts.

Plasti-med has been manufacturing by taking the relevant standards as a guide since its establishment. 93/42/EEC Certificate is available and transition provisions of regulation (EU) 2017/745 are applied. Our quality system has ISO 9001: 2015 Quality Management System Certificate, ISO 13485:2016 Medical Devices Quality Management System Certificate and our products within the scope of Medical Device Regulation have CE Certificate. Plasti-med is a FDA registered company.

In order to maintain the quality targets and service understanding; working with well-educated, experienced personnel who are aware of their work is the basis of Plasti-med's human resources policy.

Plasti-med 1995 yılında kurulmuştur. Solunum, Anestezi, Drenaj, Üroloji, Jinekoloji ve genel kullanıma uygun tek kullanımlık tıbbi malzemeler üretmektedir. Türkiye'nin önemli tek kullanımlık medikal malzeme üreticilerinden birisidir. Dünya genelinde 80'den fazla ülkeye ihracat yapmaktadır.

Hedefimiz yüksek kalitede, rekabet edebilir fiyatlarla ve müşteri memnuniyetini hedef alan hizmet anlayışımızla, standartlara uygun ürünler üretmektir.

Plasti-med, yelpazesinde bulunan ürünlerde ciddi bir pazar payı elde etmiştir. Sektör ihtiyaçlarına göre ürün geliştirme ve kalite yükseltme çalışmaları sonucu, ürünleri "Plasti-med" markası ile istenir duruma gelmiştir. Üretimde kullanılan malzemelerin tamamı MDD gerekliliklerine uygun ve sektörde tanınan ve kabul gören tedarikçilerden sağlanmaktadır. Üretim araç ve gereçleri yine MDD, GMP ve Plasti-med standartları gereği en yüksek kalitede dünyada bilinen ve kabul görmüş markalar arasından seçilmektedir.

Plasti-med kurulduğu günden beri ilgili standartları rehber edinerek üretim yapmaktadır. 93/42/EEC Sertifikası mevcut olup, regulation (EU) 2017/745 geçiş hükümleri uygulanmaktadır. Kalite sistemi ISO 9001:2015 Kalite Yönetim Sistemi Sertifikasına, ISO 13485:2016 Tıbbi Cihazlar Kalite Yönetim Sistemi Sertifikasına ve Tıbbi Cihaz Yönetmeliği kapsamındaki ürünlerimiz CE sertifikasına sahiptir. Plasti-med, FDA kayıtlı firmadır.

Kalite hedeflerini ve hizmet anlayışını sürdürebilmek için iyi eğitim almış, tecrübeli, yaptığı işin bilincinde olan personel ile çalışmak Plasti-med'in insan kaynakları politikasının temelini oluşturur.

Anesthesia & Ventilation Systems Anestezi & Solunum Sistemleri	2-17	Oxygen & Aerosol Therapy Oksijen & Aerosol Terapi	25-27
Anesthesia Circuits - Corrugated Anestezi Devreleri - Koruge		Oxygen Mask Oksijen Maskesi	
Anesthesia Circuits - Smoothbore Anestezi Devreleri - Smoothbore		Nebulizer Set Nebulizer Set	
Anesthesia Circuits - Extendable Anestezi Devreleri - Ayarlanabilir		High Concentration Oxygen Mask Yüksek Konsantrasyonlu Oksijen Maskesi	
Ventilation Circuits- Corrugated Solunum Devreleri - Koruge		Nasal Oxygen Cannula Nazal Oksijen Kanülü	
Ventilation Circuits- Smoothbore Solunum Devreleri - Smoothbore		Nebulizer Sets With Mouthpiece and "T" part Ağızlıklı ve "T" Parçalı Nebulizer Setler	
Ventilation Circuits- Extendable Solunum Devreleri - Ayarlanabilir		Breathing Circuit "T" Tube Solunum Devresi "T" Tüpü	
Anesthesia Circuits - Coaxial Anestezi Devreleri - Koaksiyel			
IPPB (Intermittent Positive Pressure Breathing) Circuits IPPB Devreleri		CPAP & BIPAP Masks CPAP & BIPAP Maskeleri	28-29
Transport Ventilation Circuits Taşınabilir Ventilatör Devreleri		CPAP/BIPAP Mask (Ora-Nasal) CPAP/BIPAP Maskesi (Ağız-Burun)	
		CPAP/BIPAP Mask (Nasal) CPAP/BIPAP Maskesi (Burun)	
Inflatable And Silicone Masks Şişirilebilir ve Silikon Maskeler	18-19	Resuscitator Suni Solunum Balonu	30-31
		Disposable Manuel Resuscitator Tek Kullanımlık Manuel Suni Solunum Balonu	
Filters Filtreler	20-21	Reusable Manuel Resuscitator Tekrar Kullanılabilir Manuel Suni Solunum Balonu	
Catheter Mount - Airway (Guedel Type) Kateter Mount - Airway (Guedel Tip)	22-23	Connectors Konnektörler	32-33
Respiratory Exercise Device With 3 Ball Solunum Egzersiz Cihazı Üç Toplu	24	Components Komponentler	34-35
		Other Products Diğer Ürünler	35

ANESTHESIA & VENTILATION SYSTEMS

Anestezi & Solunum Sistemleri

Plasti-med[®]
"supporting healthy life"



ANESTHESIA CIRCUITS - CORRUGATED

Anestezi Devreleri - Koruge

Plasti-med[®]
"supporting healthy life"

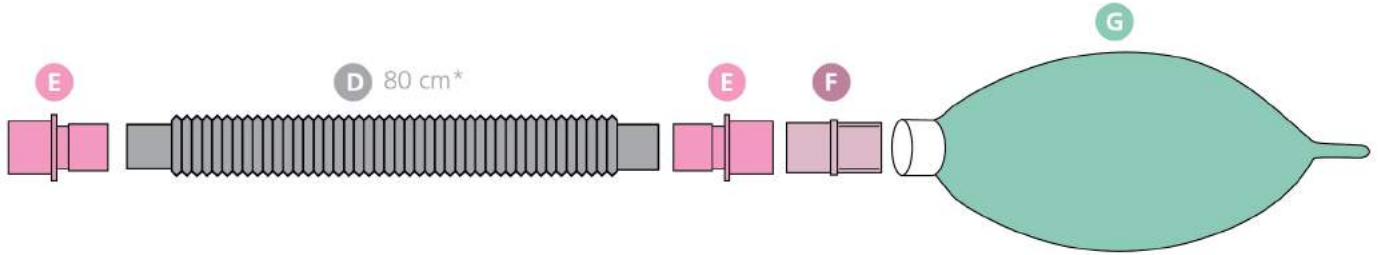
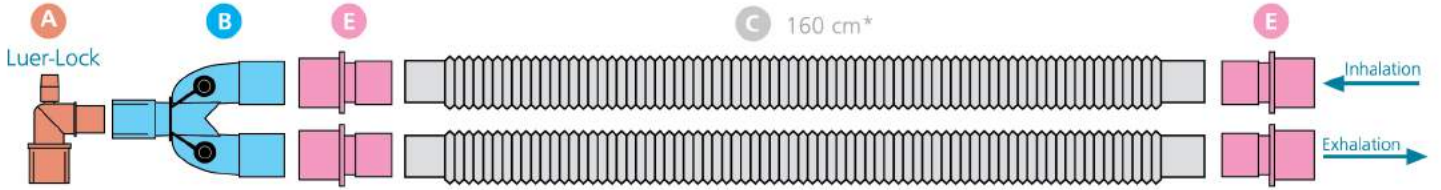

	KOD / CODE	A	B	C	D	E	F	G
YETİŞKİN ADULT (Ø 22mm)	480 001	1	1	2	-	4	-	-
	480 101	1	1	2	1	6	1	-
	480 201	1	1	2	1	6	1	1
PEDIATRİK PEDIATRIC (Ø 15mm)	480 301	1	1	2	-	4	-	-
	480 401	1	1	2	1	6	1	-
	480 501	1	1	2	1	6	1	1

A: Dirsek - Luerlock-Elbow/Luerlock (22M/15F-15M)
 B: Y Konnektör - Yye Connector (22M/15F-22M)
 C: Hortum - Tubing (Ø 22mm, Ø 15mm)
 D: Ara Hortum - Limb (Ø 22mm, Ø 15mm)
 E: Düz Konnektör - Straight Connector (22F-22M)
 F: Düz Konnektör - Straight Connector (22M-22M/15F)
 G: Anestezi Balonu - Breathing Bag (22F) (0.5L, 1L, 2L, 3L)

*Özel uzunluklar isteğe göre üretilmektedir. Tablodaki rakamlar devre içeriklerini göstermektedir.

*Special lengths can be manufactured upon request. The figures in the table show the contents of the circuit.

ANESTHESIA CIRCUITS - SMOOTHBORE

Anestezi Devreleri - Smoothbore

Plasti-med[®]
"supporting healthy life"

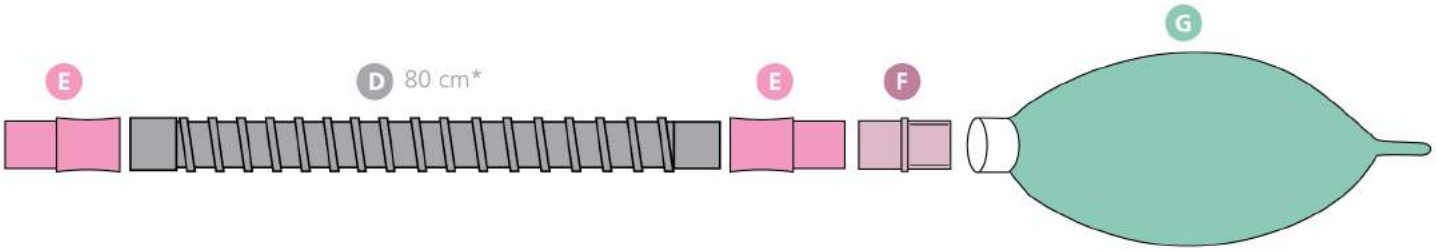
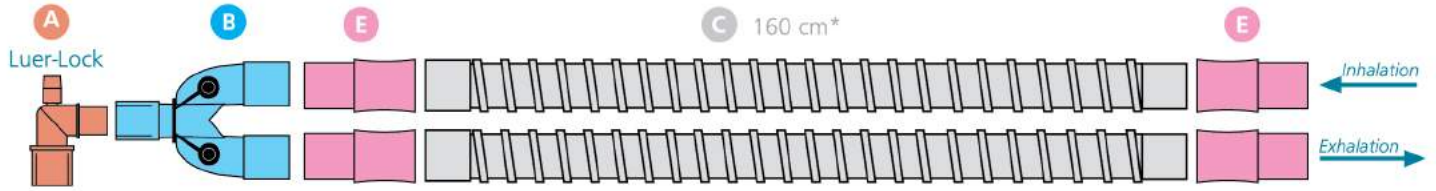

	KOD / CODE	A	B	C	D	E	F	G
YETİSKİN ADULT Ø 19mm	481 001	1	1	2	-	4	-	-
	481 101	1	1	2	1	6	1	-
	481 201	1	1	2	1	6	1	1
PEDİATRİK PEDIATRIC Ø 15mm	481 301	1	1	2	-	4	-	-
	481 401	1	1	2	1	6	1	-
	481 501	1	1	2	1	6	1	1

- A: Dirsek - Luerlock-Elbow/Luerlock (22M/15F-15M)
 B: Y Konnektör - Wye Connector (22M/15F-22M)
 C: Hortum - Tubing (Ø 22mm, Ø 15mm)
 D: Ara Hortum - Limb (Ø 22mm, Ø 15mm)
 E: Düz Konnektör - Straight Connector (22F-22M)
 F: Düz Konnektör - Straight Connector (22M-22M/15F)
 G: Anestezi Balonu - Breathing Bag (22F) (0.5L, 1L, 2L, 3L)

*Özel uzunluklar isteğe göre üretilmektedir. Tablodaki rakamlar devre içeriklerini göstermektedir.

*Special lengths can be manufactured upon request. The figures in the table show the contents of the circuit.

ANESTHESIA CIRCUITS - EXTENDABLE

Anestezi Devreleri - Ayarlanabilir

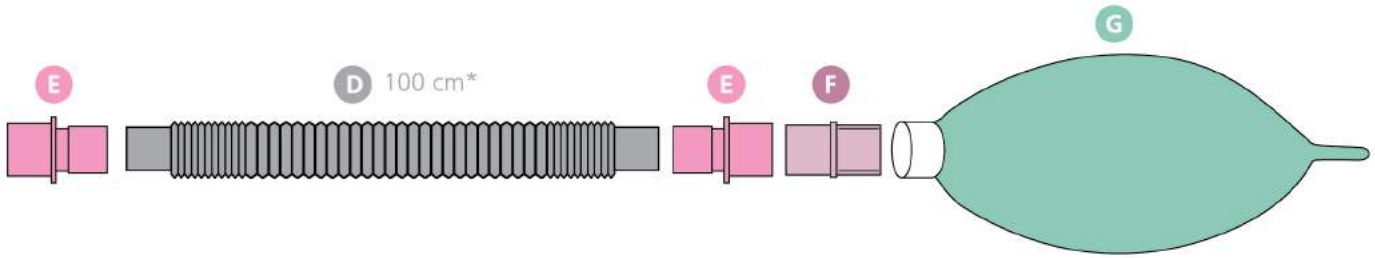
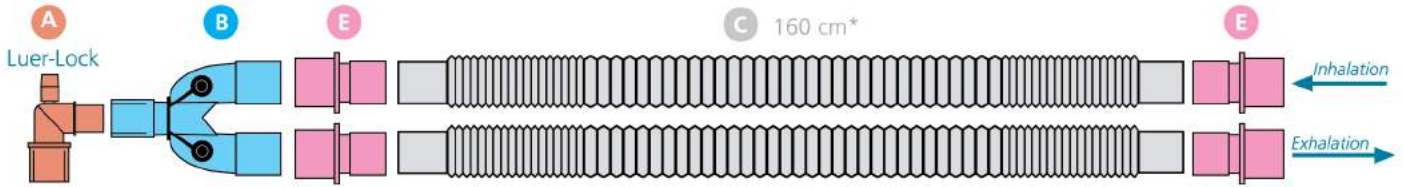

	KOD / CODE	A	B	C	D	E	F	G
YETİŞKİN ADULT (Ø 22mm)	482 001	1	1	2	-	4	-	-
	482 101	1	1	2	1	6	1	-
	482 201	1	1	2	1	6	1	1
PEDİATRİK PEDIATRIC (Ø 15mm)	482 301	1	1	2	-	4	-	-
	482 401	1	1	2	1	6	1	-
	482 501	1	1	2	1	6	1	1

- A: Dirsek - Luerlock-Elbow/Luerlock (22M/15F-15M)
 B: Y Konnektör - Wye Connector (22M/15F-22M)
 C: Hortum - Tubing (Ø 22mm, Ø 15mm)
 D: Ara Hortum - Limb (Ø 22mm, Ø 15mm)
 E: Düz Konnektör - Straight Connector (22F-22M)
 F: Düz Konnektör - Straight Connector (22M-22M/15F)
 G: Anestezi Balonu - Breathing Bag (22F) (0.5L, 1L, 2L, 3L)

*Özel uzunluklar isteğe göre üretilmektedir. Tablodaki rakamlar devre içeriklerini göstermektedir.

*Special lengths can be manufactured upon request. The figures in the table show the contents of the circuit.

ANESTHESIA & VENTILATION SYSTEMS

Anestezi & Solunum Sistemleri

Plasti-med
"supporting healthy life"



VENTILATION CIRCUITS - CORRUGATED

Solumun Devreleri - Koruge

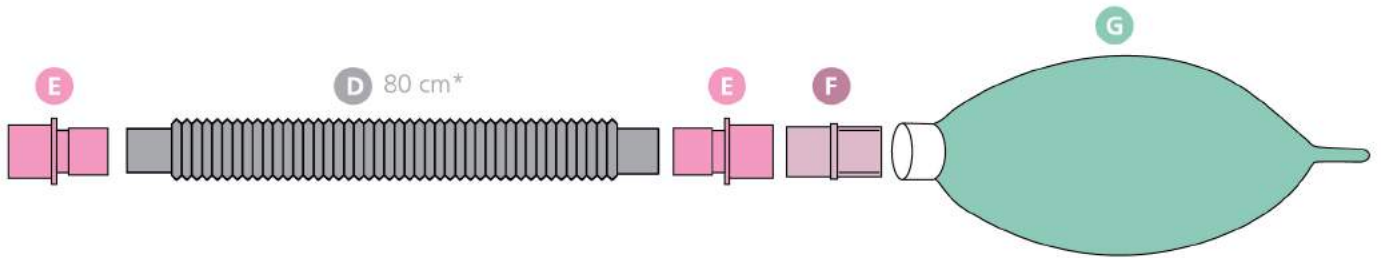
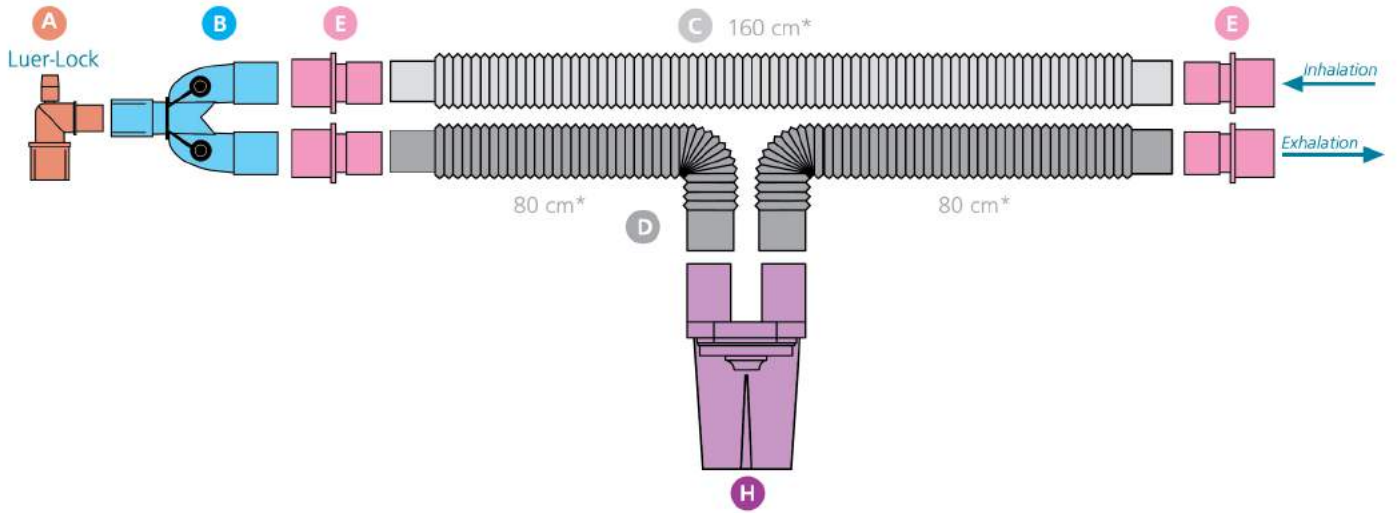

	KOD / CODE	A	B	C	D	E	F	G	H
YETİSKİN ADULT Ø 22mm	483 001	1	1	1	2	4	-	-	1
	483 101	1	1	1	3	6	1	-	1
	483 201	1	1	1	3	6	1	1	1
PEDIATRİK PEDIATRIC Ø 15mm	484 001	1	1	1	2	4	-	-	1
	484 101	1	1	1	3	6	1	-	1
	484 201	1	1	1	3	6	1	1	1

- A: Dirsek - Luerlock-Elbow/Luerlock (22M/15F-15M)
 B: Y Konnektör - Wye Connector (22M/15F-22M)
 C: Hortum - Tubing (Ø 22mm, Ø 15mm)
 D: Ara Hortum - Limb (Ø 22mm, Ø 15mm)
 E: Düz Konnektör - Straight Connector (22F-22M)
 F: Düz Konnektör - Straight Connector (22M-22M/15F)
 G: Anestezi Balonu - Breathing Bag (22F) (0.5L, 1L, 2L, 3L)
 H: Su Tuzağı - Water Trap (22M)

*Özel uzunluklar isteğe göre üretilmektedir. Tablodaki rakamlar devre içeriklerini göstermektedir.

*Special lengths can be manufactured upon request. The figures in the table show the contents of the circuit.

VENTILATION CIRCUITS - SMOOTHBORE

Solumun Devreleri - Smoothbore

Plasti-med
"supporting healthy life"

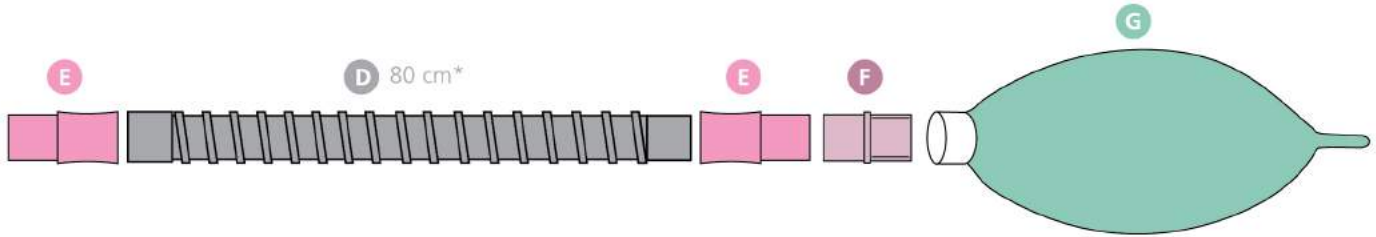
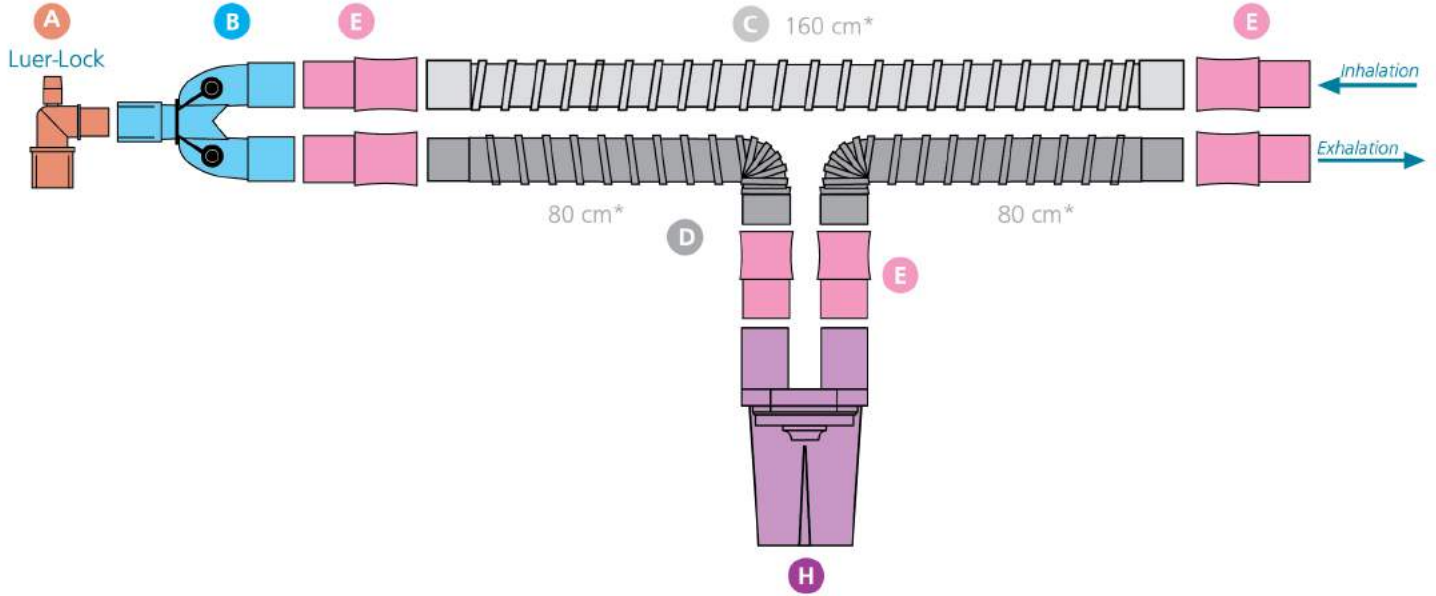

	KOD / CODE	A	B	C	D	E	F	G	H
YETİSKİN ADULT Ø 19mm	485 001	1	1	1	2	6	-	-	1
	485 101	1	1	1	3	8	1	-	1
	485 201	1	1	1	3	8	1	1	1
PEDIATRİK PEDIATRIC Ø 15mm	486 001	1	1	1	2	6	-	-	1
	486 101	1	1	1	3	8	1	-	1
	486 201	1	1	1	3	8	1	1	1

- A: Dirsek - Luerlock-Elbow/Luerlock (22M/15F-15M)
 B: Y Konnektör - Wye Connector (22M/15F-22M)
 C: Hortum - Tubing (Ø 22mm, Ø 15mm)
 D: Ara Hortum - Limb (Ø 22mm, Ø 15mm)
 E: Düz Konnektör - Straight Connector (22F-22M)
 F: Düz Konnektör - Straight Connector (22M-22M/15F)
 G: Anestezi Balonu - Breathing Bag (22F) (0.5L, 1L, 2L, 3L)
 H: Su Tuzağı - Water Trap (22M)

*Özel uzunluklar isteğe göre üretilmektedir. Tablodaki rakamlar devre içeriklerini göstermektedir.

*Special lengths can be manufactured upon request. The figures in the table show the contents of the circuit.

VENTILATION CIRCUITS - EXTENDABLE

Solunum Devreleri - Ayarlanabilir

Plasti-med
"supporting healthy life"

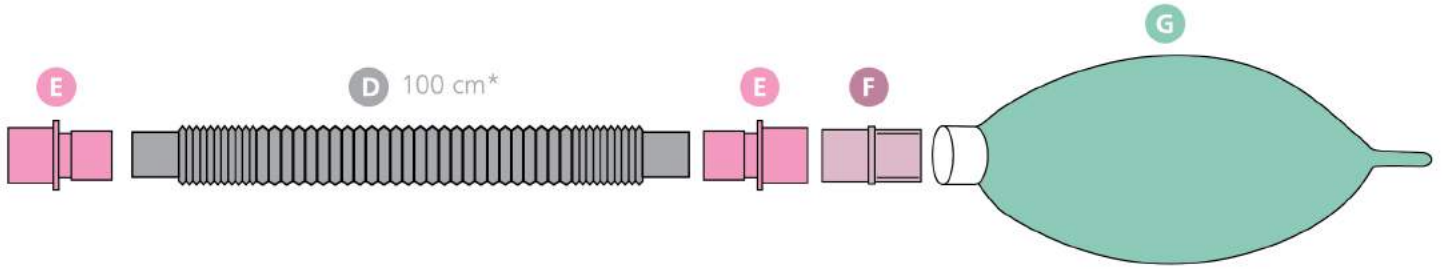
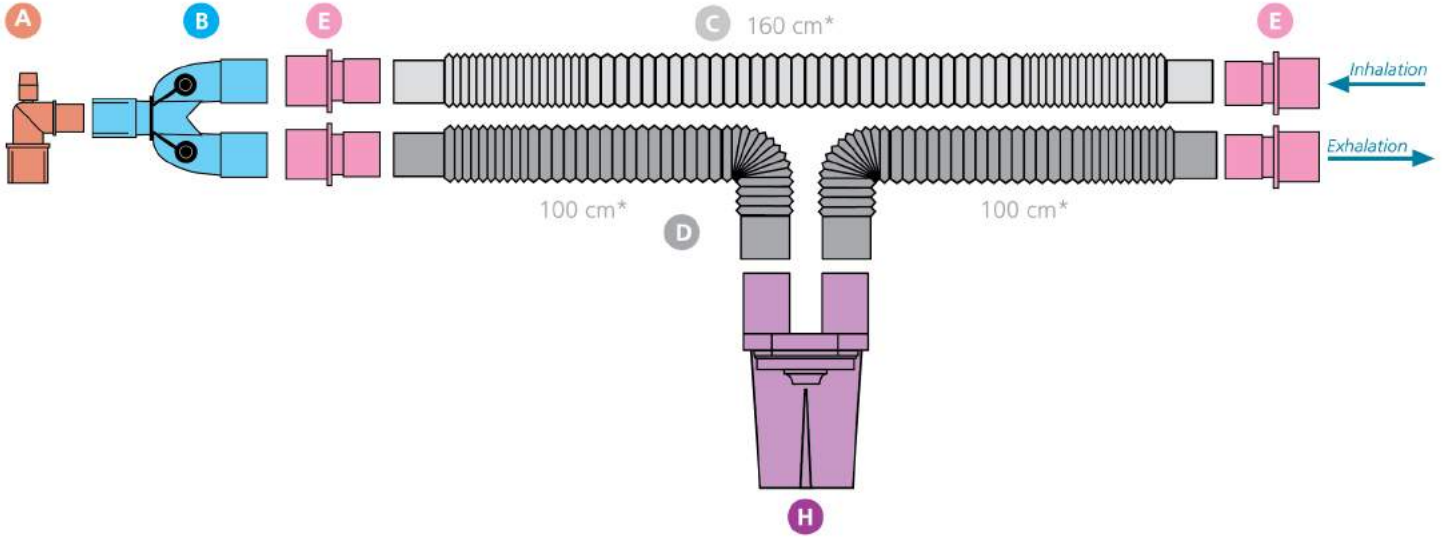

	KOD / CODE	A	B	C	D	E	F	G	H
YETİSKİN ADULT Ø 22mm	487 001	1	1	1	2	4	-	-	1
	487 101	1	1	1	3	6	1	-	1
	487 201	1	1	1	3	6	1	1	1
PEDIATRİK PEDIATRIC Ø 15mm	488 001	1	1	1	2	4	-	-	1
	488 101	1	1	1	3	6	1	-	1
	488 201	1	1	1	3	6	1	1	1

- A: Dirsek - Luerlock-Elbow/Luerlock (22M/15F-15M)
 B: Y Konnektör - Wye Connector (22M/15F-22M)
 C: Hortum - Tubing (Ø 22mm, Ø 15mm)
 D: Ara Hortum - Limb (Ø 22mm, Ø 15mm)
 E: Düz Konnektör - Straight Connector (22F-22M)
 F: Düz Konnektör - Straight Connector (22M-22M/15F)
 G: Anestezi Balonu - Breathing Bag (22F) (0.5L, 1L, 2L, 3L)
 H: Su Tuzağı - Water Trap (22M)

*Özel uzunluklar isteğe göre üretilmektedir. Tablodaki rakamlar devre içeriklerini göstermektedir.

*Special lengths can be manufactured upon request. The figures in the table show the contents of the circuit.

ANESTHESIA & VENTILATION SYSTEMS

Anestezi & Solunum Sistemleri

Plasti-med[®]
"supporting healthy life"



VENTILATION CIRCUITS - CORRUGATED

Solumun Devreleri - Koruge

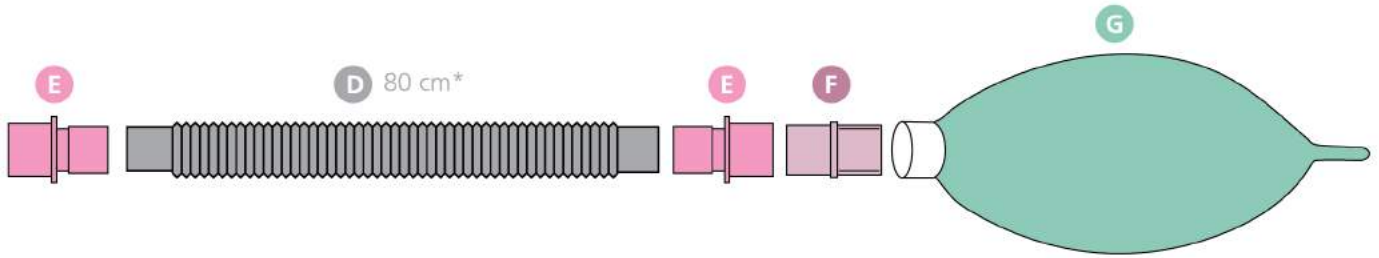
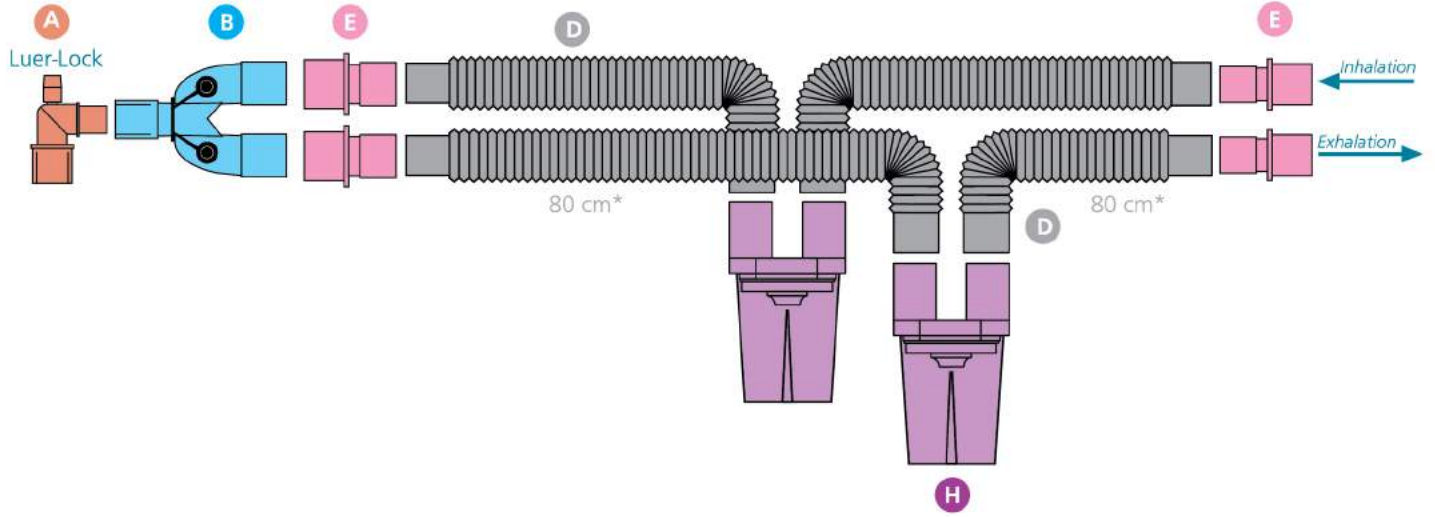

	KOD / CODE	A	B	C	D	E	F	G	H
YETİŞKİN ADULT Ø 22mm	483 301	1	1	-	4	4	-	-	2
	483 401	1	1	-	5	6	1	-	2
	483 501	1	1	-	5	6	1	1	2
PEDIATRİK PEDIATRIC Ø 15mm	484 301	1	1	-	4	4	-	-	2
	484 401	1	1	-	5	6	1	-	2
	484 501	1	1	-	5	6	1	1	2

- A: Dirsek - Luerlock-Elbow / Luerlock (22M/15F-15M)
 B: Y Konnektör - Wye Connector (22M/15F-22M)
 D: Ara Hortum - Limb (Ø 22mm, Ø 15mm)
 E: Düz Konnektör - Straight Connector (22F-22M)
 F: Düz Konnektör - Straight Connector (22M-22M/15F)
 G: Anestezi Balonu - Breathing Bag (22F) (0.5L, 1L, 2L, 3L)
 H: Su Tuzağı - Water Trap (22M)

*Özel uzunluklar isteğe göre üretilmektedir. Tablodaki rakamlar devre içeriklerini göstermektedir.

*Special lengths can be manufactured upon request. The figures in the table show the contents of the circuit.

VENTILATION CIRCUITS - SMOOTHBORE

Solumun Devreleri - Smoothbore

Plasti-med[®]
"supporting healthy life"

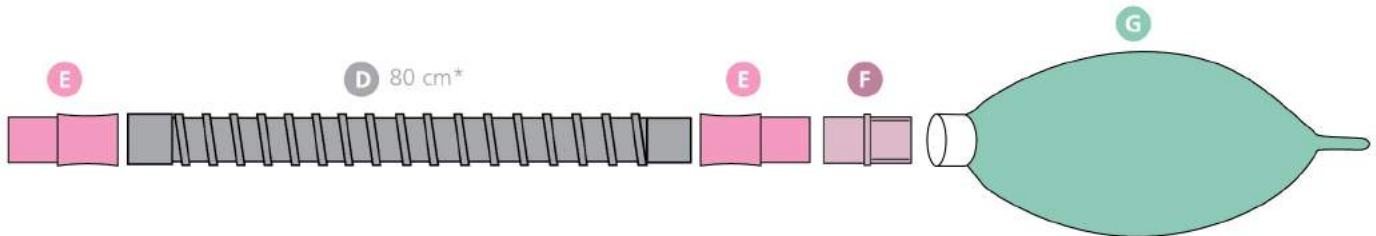
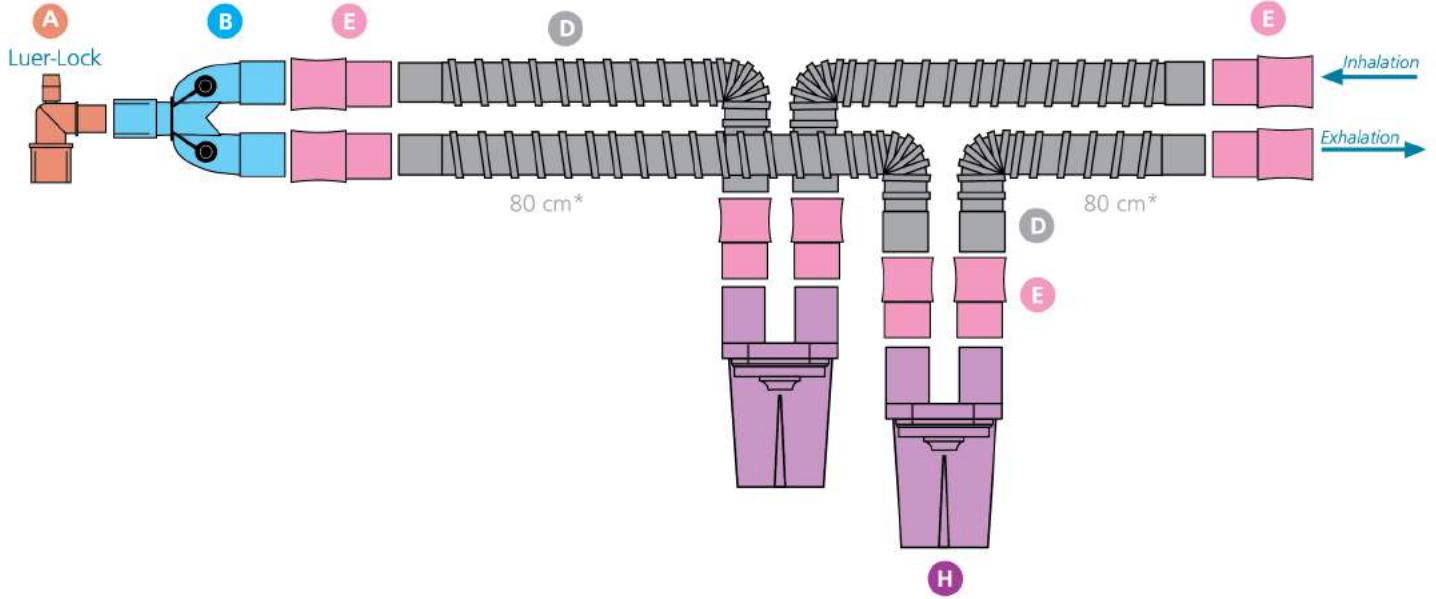

	KOD / CODE	A	B	C	D	E	F	G	H
YETİŞKİN ADULT Ø 19mm	485 301	1	1	-	4	8	-	-	2
	485 401	1	1	-	5	10	1	-	2
	485 501	1	1	-	5	10	1	1	2
PEDIATRİK PEDIATRİK Ø 15mm	486 301	1	1	-	4	8	-	-	2
	486 401	1	1	-	5	10	1	-	2
	486 501	1	1	-	5	10	1	1	2

A: Dirsek - Luerlock-Elbow/Luerlock (22M/15F-15M)
 B: Y Konnektör - Wye Connector (22M/15F-22M)
 D: Ara Hortum - Limb (Ø 22mm, Ø 15mm)
 E: Düz Konnektör - Straight Connector (22F-22M)
 F: Düz Konnektör - Straight Connector (22M-22M/15F)
 G: Anestezi Balonu - Breathing Bag (22F) (0.5L, 1L, 2L, 3L)
 H: Su Tuzağı - Water Trap (22M)

*Özel uzunluklar isteğe göre üretilmektedir. Tablodaki rakamlar devre içeriklerini göstermektedir.

*Special lengths can be manufactured upon request. The figures in the table show the contents of the circuit.

VENTILATION CIRCUITS - EXTENDABLE

Solunum Devreleri - Ayarlanabilir

Plasti-med[®]
"supporting healthy life"

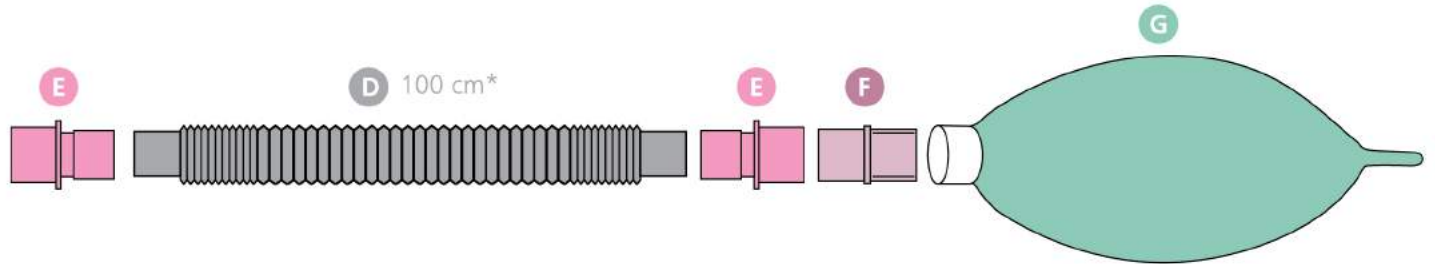
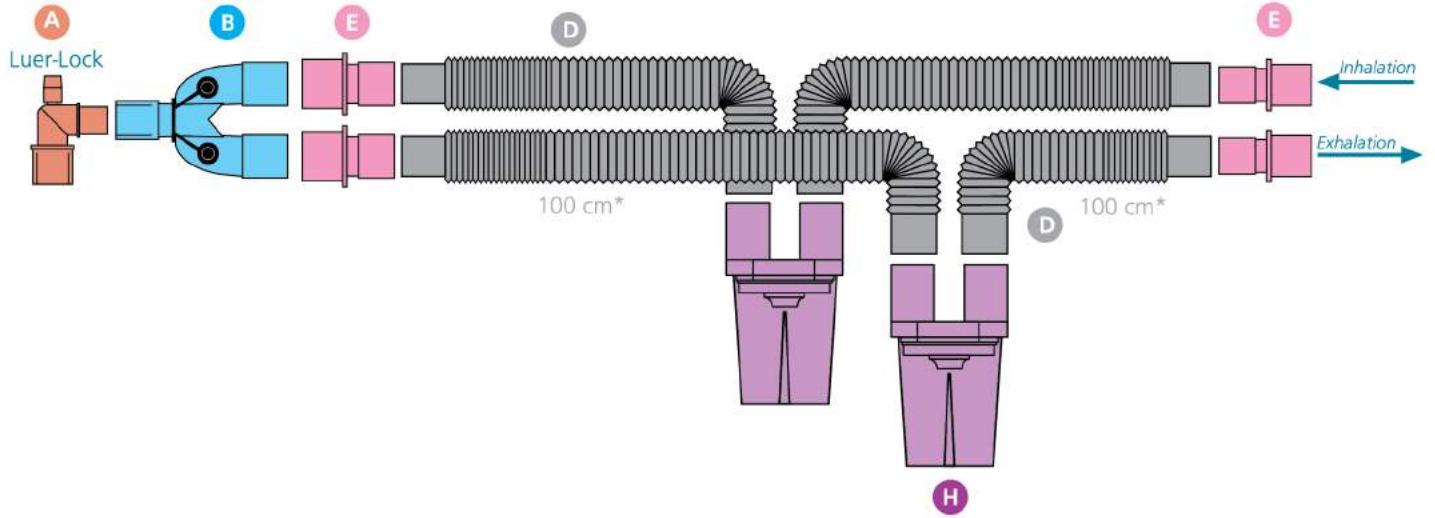

	KOD / CODE	A	B	C	D	E	F	G	H
YETİŞKİN ADULT (Ø 22mm)	487 301	1	1	-	4	4	-	-	2
	487 401	1	1	-	5	6	1	-	2
	487 501	1	1	-	5	6	1	1	2
PEDIATRİK PEDIATRIC (Ø 15mm)	488 301	1	1	-	4	4	-	-	2
	488 401	1	1	-	5	6	1	-	2
	488 501	1	1	-	5	6	1	1	2

- A: Dirsek - Luerlock-Elbow/Luerlock (22M/15F-15M)
 B: Y Konnektör - Wye Connector (22M/15F-22M)
 D: Ara Hortum - Limb (Ø 22mm, Ø 15mm)
 E: Düz Konnektör - Straight Connector (22F-22M)
 F: Düz Konnektör - Straight Connector (22M-22M/15F)
 G: Anestezi Balonu - Breathing Bag (22F) (0.5L, 1L, 2L, 3L)
 H: Su Tuzağı - Water Trap (22M)

*Özel uzunluklar isteğe göre üretilmektedir. Tablodaki rakamlar devre içeriklerini göstermektedir.

*Special lengths can be manufactured upon request. The figures in the table show the contents of the circuit.

ANESTHESIA CIRCUITS - COAXIAL

Anestezi Devreleri - Koaksiyel

Plasti-med[®]
"supporting healthy life"

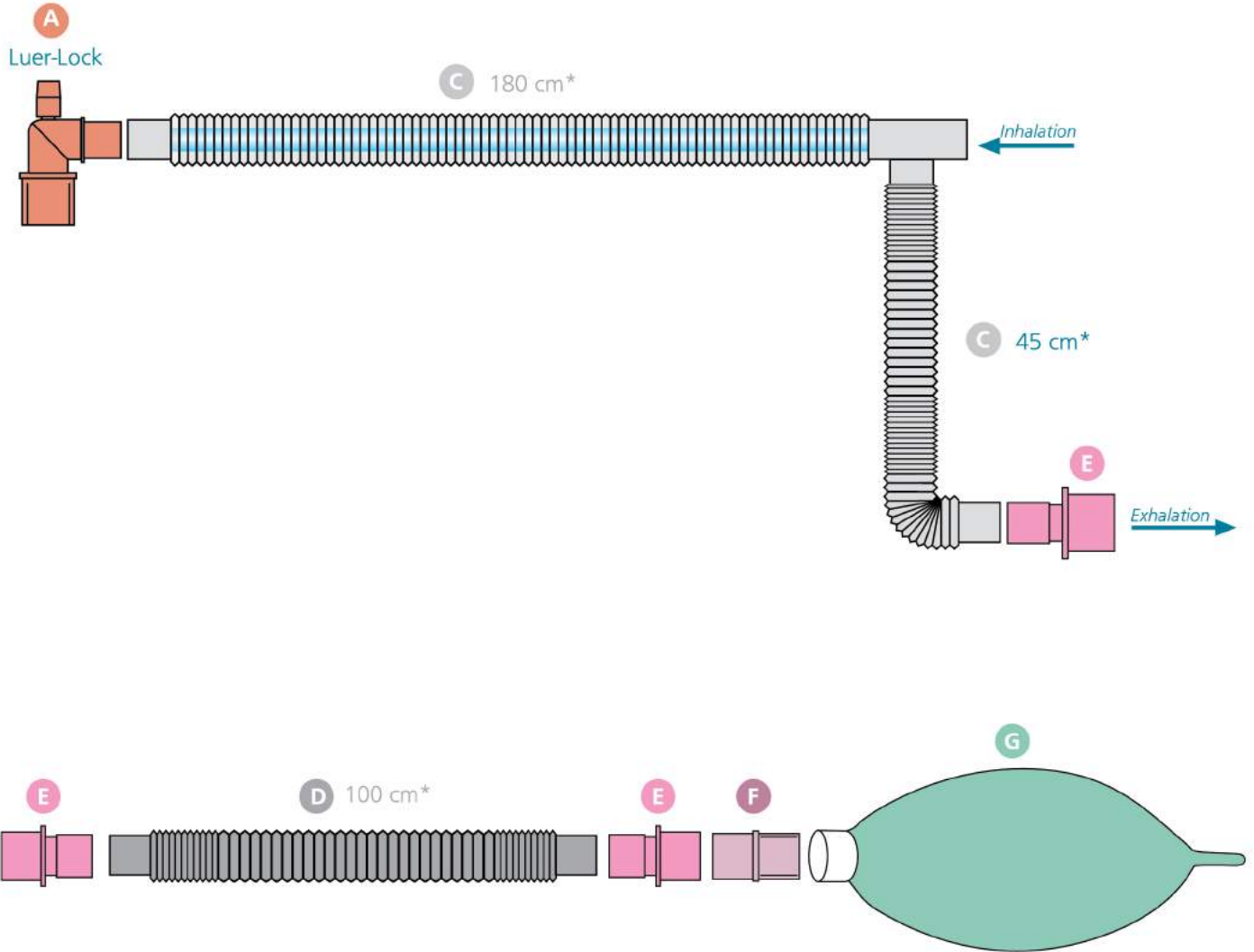

	KOD / CODE	A	C	D	E	F	G
YETİSKİN ADULT (Ø 22 mm)	489 301	1	1	-	1	-	-
	489 302	1	1	1	3	1	-
	489 303	1	1	1	3	1	1
PEDIATRİK PEDIATRIC (Ø 15 mm)	489 311	1	1	-	1	-	-
	489 312	1	1	1	3	1	-
	489 313	1	1	1	3	1	1

- A: Dirsek - Luerlock-Elbow/Luerlock (22M/15F-15M)
 B: Y Konnektör - Wye Connector (22M/15F-22M)
 C: Hortum - Tubing (Ø 22mm, Ø 15mm)
 D: Ara Hortum - Limb (Ø 22mm, Ø 15mm)
 E: Düz Konnektör - Straight Connector (22F-22M)
 F: Düz Konnektör - Straight Connector (22M-22M/15F)
 G: Anestezi Balonu - Breathing Bag (22F) (0.5L, 1L, 2L, 3L)

*Özel uzunluklar isteğe göre üretilmektedir. Tablodaki rakamlar devre içeriklerini göstermektedir.

*Special lengths can be manufactured upon request. The figures in the table show the contents of the circuit.

IPPB (Intermittent Positive Pressure Breathing) CIRCUITS

IPPB Devreleri

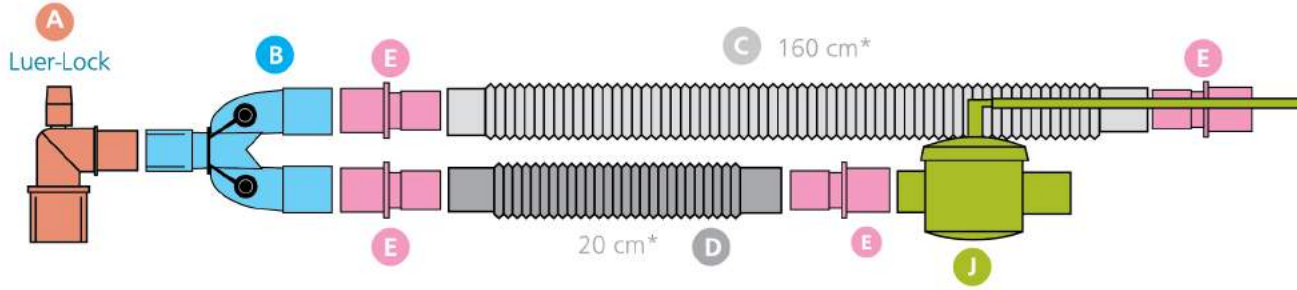

- A: Dirsek - Luerlock-Elbow/Luerlock (22M/15F-15M)
 B: Y Konnektör - Wye Connector (22M/15F-22M)
 C: Hortum - Tubing (Ø 22mm, Ø 15mm)
 D: Hortum - Tubing (Ø 22mm, Ø 15mm)
 E: Düz Konnektör - Straight Connector (22F-22M)
 I: Ekshalasyon Valfi 2 - Exhalation Valve 2 (22M-22M/15F)
 J: Ekshalasyon Valfi 1 - Exhalation Valve 1 (22M-22M/15F)

KOD / CODE		A	B	C	D	E	J
YETİŞKİN ADULT (Ø 22mm)	489 286 (Koruge)	1	1	1	1	4	1
	489 287 (Smoothbore)	1	1	1	1	4	1
	489 288 (Ayarlanabilir)	1	1	1	1	4	1
PEDIATRİK PEDIATRIC (Ø 15mm)	489 289 (Koruge)	1	1	1	1	4	1
	489 290 (Smoothbore)	1	1	1	1	4	1
	489 291 (Ayarlanabilir)	1	1	1	1	4	1



*Özel uzunluklar isteğe göre üretilmektedir. Tablodaki rakamlar devre içeriklerini göstermektedir.
 *Special lengths can be manufactured upon request. The figures in the table show the contents of the circuit.

ANESTHESIA & VENTILATION SYSTEMS

Anestezi & Solunum Sistemleri

Plasti-med[®]
"supporting healthy life"



TRANSPORT VENTILATION CIRCUITS

Taşınabilir Ventilatör Devreleri

Plasti-med[®]
"supporting healthy life"

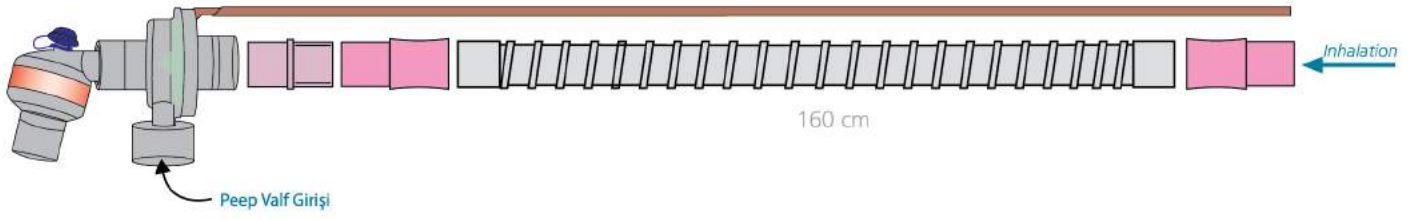

KOD / CODE	TİP / TYPE	KOLI ADEDİ QUANTITY PER BOX
489 292	TRANSPORT VENTİLATOR DEVRESİ TRANSPORT VENTILATION CIRCUIT	10
489 251	SMOOTHBORE IPPB YETİŞKİN DEVRE SMOOTHBORE IPPB ADULT CIRCUIT	10

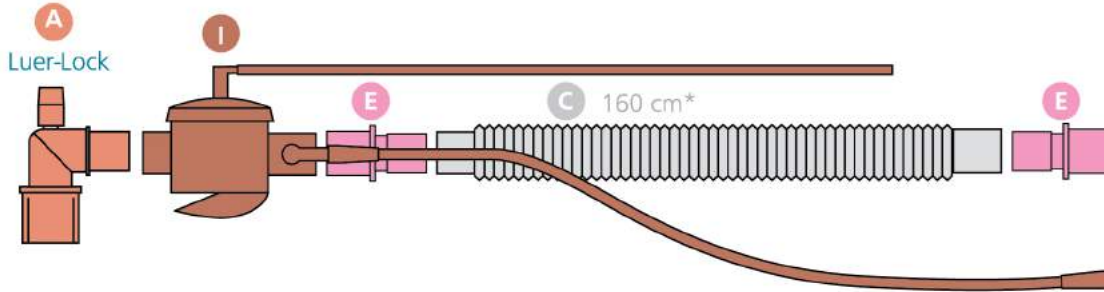

	KOD / CODE	A	C	E	I
YETİŞKİN ADULT (Ø 22mm)	489 241 (Koruge)	1	1	2	1
	489 261 (Smoothbore)	1	1	2	1
	489 281 (Ayarlanabilir)	1	1	2	1
PEDİATRİK PEDIATRIC (Ø 15mm)	489 245 (Koruge)	1	1	2	1
	489 265 (Smoothbore)	1	1	2	1
	489 285 (Ayarlanabilir)	1	1	2	1



* Ambulanslarda bulunan taşınabilir ventilatör cihazları ile uyumlu çalışmaktadır.
* Suitable for portable ventilation machines in Ambulances.



INFLATABLE AND SILICONE MASKS

Şişirilebilir ve Silikon Maskeler

Plasti-med[®]
"supporting healthy life"



INFLATABLE AND SILICONE MASKS

Şişirilebilir ve Silikon Maskeler

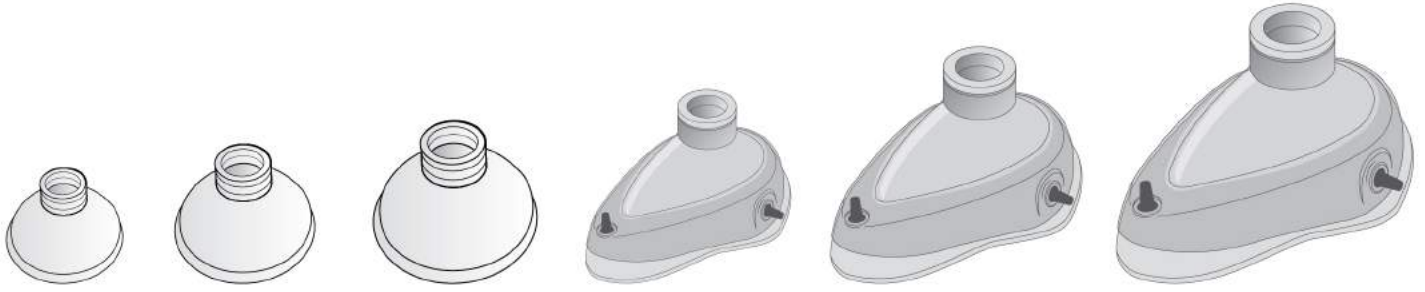

- Silikon malzeme
- 134 °C'ye kadar otoklavlanabilir
- 25 kez steril edilebilir

- *Silicone material*
- *Autoclavable until 134 °C*
- *It can be sterilized for 25 times*

KOD / CODE	NO	Tip / Type	KOLI ADEDİ QUANTITY PER BOX
130 220	0	Neonatal	50
130 221	1	Infant	50
130 222	2	Pediatric	50
130 223	3	Child	50
130 224	4	Adult Small	40
130 225	5	Adult	35

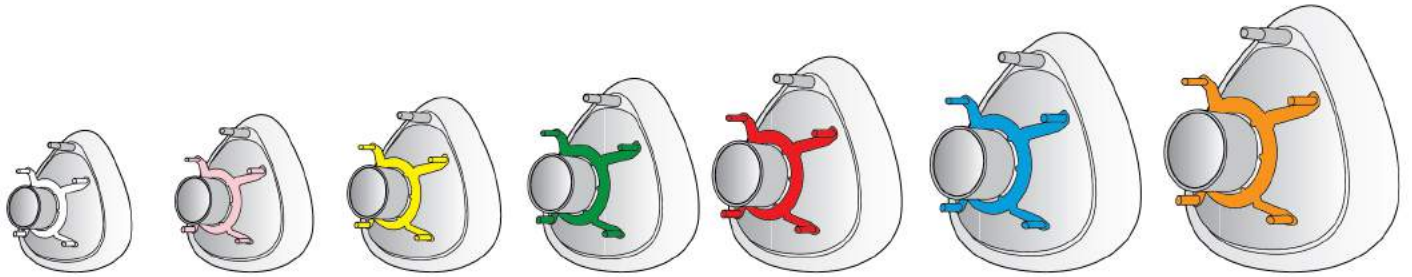

- Şişirilebilir yastıklı
- Renk kodlu

- *Inflatable cushion*
- *Color coded*

KOD / CODE	NO	Tip / Type	KOLI ADEDİ QUANTITY PER BOX
130 210	0	Neonatal	30
130 211	1	Infant	30
130 212	2	Pediatric	30
130 213	3	Child	30
130 214	4	Adult Small	30
130 215	5	Adult	25
130 216	6	Adult Large	25

KOD / CODE	TİP / TYPE	KOLI ADEDİ QUANTITY PER BOX
130 219	SİLİKON BAŞ BANDI HEADSTRAP	1000

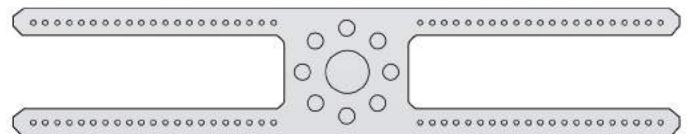

FILTERS

Filtreler



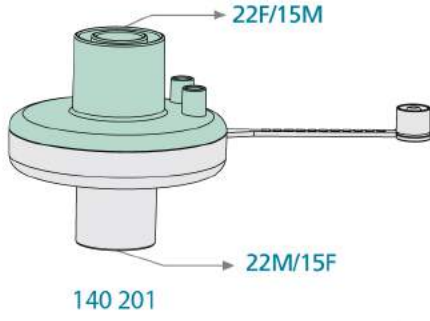

- BFE (Bakteriyel Filtre Etkinliği) %99.99998
- VFE (Viral Filtre Etkinliği) %99.9998
- Gaz Örnek Alma Portu
- Düşük Ölü Boşluk
- Düşük Akış Direnci
- Steril

- BFE (Bacterial Filtration Efficiency) %99.99998
- VFE (Viral Filtration Efficiency) %99.9998
- Gas Sampling Port
- Low Dead Space
- Low Flow Resistance
- Sterile

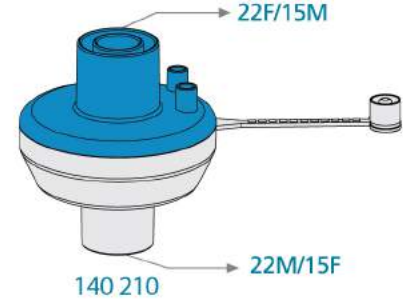

- BFE (Bakteriyel Filtre Etkinliği) %99.99998
- VFE (Viral Filtre Etkinliği) %99.9998
- 500 ml Tidal Hacim ile Nem Çıkış Değeri 33.2 mg/lt
- Gaz Örnek Alma Portu
- Düşük Ölü Boşluk
- Düşük Akış Direnci
- Steril

- BFE (Bacterial Filtration Efficiency) %99.99998
- VFE (Viral Filtration Efficiency) %99.9998
- Moisture Output at 500 ml Tidal Volume 33.2 mg/lt
- Gas Sampling Port
- Low Dead Space
- Low Flow Resistance
- Sterile

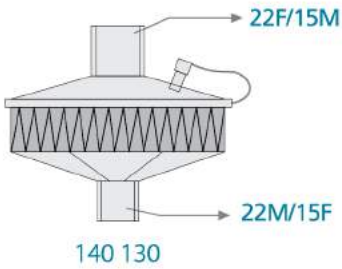

- BFE (Bakteriyel Filtre Etkinliği) %99.9999
- VFE (Viral Filtre Etkinliği) %99.9999
- Gaz Örnek Alma Portu
- Düşük Ölü Boşluk
- Düşük Akış Direnci
- Steril

- BFE (Bacterial Filtration Efficiency) %99.9999
- VFE (Viral Filtration Efficiency) %99.9999
- Gas Sampling Port
- Low Dead Space
- Low Flow Resistance
- Sterile

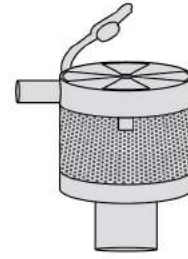

ZF-051

- 500 ml Tidal Hacim ile Nem Çıkış Değeri 24 hr: 28.8 mg/1 lt H₂O
- Aspirasyon Portu
- Oksijen Portu
- Düşük Ölü Boşluk
- Düşük Akış Direnci
- Steril

- Moisture Output at 500 ml Tidal Volume 24 hr: 28.8 mg/1 lt H₂O
- Suction Port
- Oxygen Port
- Low Dead Space
- Low Flow Resistance
- Sterile

KOD / CODE	TIP / TYPE	KOLI ADEDİ QUANTITY PER BOX
140 201	BAKTERİ FİLTRESİ BACTERIAL FILTER	100
140 210	HMEF (BAKTERİ VE NEM) FİLTRE HMEF (BACTERIAL AND MOISTURE) FILTER	100
140 130	HEPA FİLTRE HEPA FILTER	100
ZF-051	TRAKEOSTOMİ HME FİLTRE TRACHEOSTOMY HME FILTER	400

CATHETER MOUNT • AIRWAY (GUEDEL TYPE)

Kateter Mount • Airway (Guedel Tip)



CATHETER MOUNT • AIRWAY (GUEDEL TYPE)

Kateter Mount • Airway (Guedel Tip)

Plasti-med[®]
"supporting healthy life"

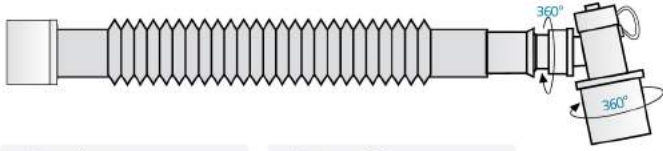

- 15 cm hortum
 - Çift döner konnektör
 - 360° dönme özelliği
 - 22M/15F hasta konnektörü
 - 22F ventilatör konnektörü
- 15 cm tubing
 - Double swivel connector
 - 360° rotatable
 - 22M/15F patient connector
 - 22F ventilator connector

KOD / CODE	HORTUM - TUBING	KOLI ADEDİ QUANTITY PER BOX
489 501	KORUGE - CORRUGATED	150
489 521	SMOOTHBORE - SMOOTHBORE	150
489 541	AYARLANABİLİR - EXTENDABLE	150

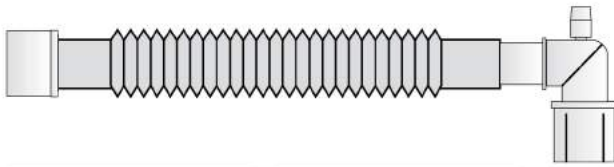

- 15 cm hortum
 - 22M/15F hasta konnektörü
 - 22F ventilatör konnektörü
- 15 cm tubing
 - 22M/15F patient connector
 - 22F ventilator connector

KOD / CODE	HORTUM - TUBING	KOLI ADEDİ QUANTITY PER BOX
489 561	KORUGE - CORRUGATED	150
489 571	SMOOTHBORE - SMOOTHBORE	150
489 581	AYARLANABİLİR - EXTENDABLE	150

SMOOTHBORE 15 cm



CORRUGATED 15 cm

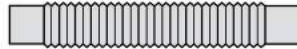

EXTENDABLE 15 cm

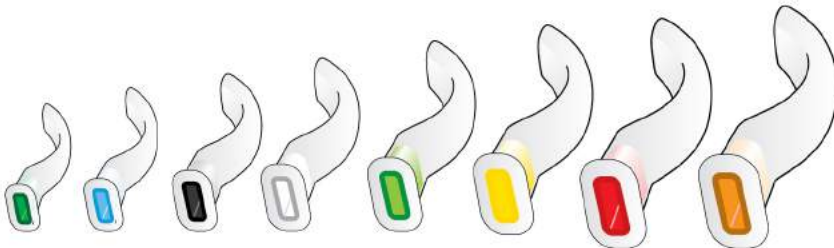

- Anatomik dizayn
- Atravmatik yuvarlatılmış kenarlar
- Renk kodlu ısırma bloğu
- Steril

- Anatomically designed
- Atraumatic soft rounded edges
- Color coded bite block
- Sterile

AIRWAY (GUEDEL TİP) AIRWAY (GUEDEL TYPE)

KOD / CODE	NUMARA NUMBER	KOLI ADEDİ QUANTITY PER BOX
200 102	00/40	1000
200 103	0/50	750
200 104	1/60	600
200 105	2/70	600
200 106	3/80	500
200 107	4/90	400
200 108	5/100	300
200 109	6/110	200

RESPIRATORY EXERCISE DEVICE WITH 3 BALL

Solunum Egzersiz Cihazı Üç Toplu

Plasti-med
"supporting healthy life"



- 600-900-1200ml
- Anatomik dizayn
- Üç toplu

- 600-900-1200ml
- Anatomically designed
- Three balls

KOD / CODE	TIP / TYPE	KOLI ADEDİ QUANTITY PER BOX
180 101	SOLUNUM EGZERSİZ CİHAZI ÜÇ TOPLU RESPIRATORY EXERCISE DEVICE WITH 3 BALL	63

OXYGEN & AEROSOL THERAPY

Oksijen & Aerosol Terapi

Plasti-med[®]
"supporting healthy life"



- Medikal grade PVC malzeme
- Standart konnektör
- 2m kırılmaya-bükülmeye dayanıklı iç kanallı hortum
- Burun maşası
- Latex free

- Medical grade PVC material
- Standard connector
- 2m kink resistant tubing
- Nasal clip
- Latex free

KOD / CODE	TIP / TYPE	KOLI ADEDİ QTY PER BOX
130 103	OKSİJEN MASKESİ / YETİŞKİN OXYGEN MASK / ADULT	125
130 106	NEBULİZER SET / YETİŞKİN NEBULIZER SET / ADULT	100
130 110	YÜKSEK KONSANTRASYONLU OKSİJEN MASKESİ / YETİŞKİN HIGH CONCENTRATION MASK / ADULT	100

KOD / CODE	TIP / TYPE	KOLI ADEDİ QTY PER BOX
130 104	OKSİJEN MASKESİ / PEDIATRİK OXYGEN MASK / PEDIATRIC	150
130 107	NEBULİZER SET / PEDIATRİK NEBULIZER SET / PEDIATRIC	125
130 111	YÜKSEK KONSANTRASYONLU OKSİJEN MASKESİ / PEDIATRİK HIGH CONCENTRATION MASK / PEDIATRIC	125



- Medikal grade PVC malzeme
- Pediatrik yumuşak tip burnu tahriş etmeyen kanul
- Kırılmaya-bükülmeye dayanıklı iç kanallı hortum

- Medical grade PVC material
- Neonatal soft tip curved nasal cannula
- Kink resistant of tubing

KOD / CODE	TIP / TYPE	KOLI ADEDİ QUANTITY PER BOX
130 101	NAZAL OKSİJEN KANÜLÜ YETİŞKİN NASAL OXYGEN CANNULA ADULT	300
130 102	NAZAL OKSİJEN KANÜLÜ PEDIATRİK NASAL OXYGEN CANNULA PEDIATRIC	300
130 113	NAZAL OKSİJEN KANÜLÜ NEONATAL NASAL OXYGEN CANNULA NEONATAL	200
130 105	NAZAL OKSİJEN KANÜLÜ YETİŞKİN - 7 METRE NASAL OXYGEN CANNULA ADULT - 7 METER	100

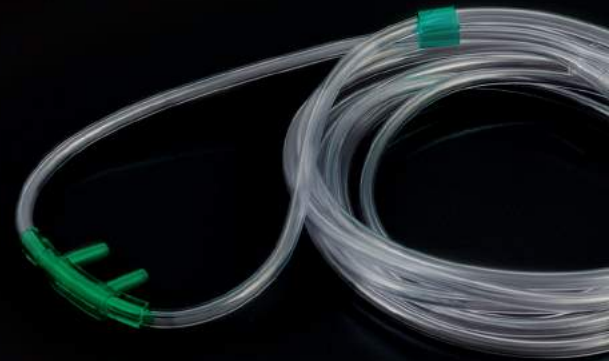

OXYGEN & AEROSOL THERAPY

Oksijen & Aerosol Terapi



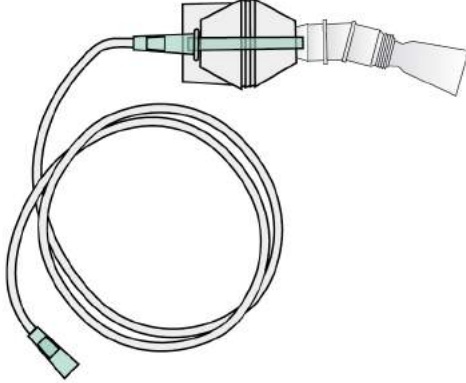

- Medikal grade PVC malzeme
- Standart konnektör
- 2m kırılmaya-bükülmeye dayanıklı iç kanallı hortum
- Nebulizer kap
- Latex free

- Medical grade PVC material
- Standard connector
- 2m kink resistant tubing
- Nebuliser cup
- Latex free

KOD / CODE	TIP / TYPE	KOLI ADEDİ QUANTITY PER BOX
130 108	NEBULİZER SET AĞIZLIKLI YARIM DİRSEKLI NEBULISER SET WITH MOUTPIECE HALF ELBOW	150

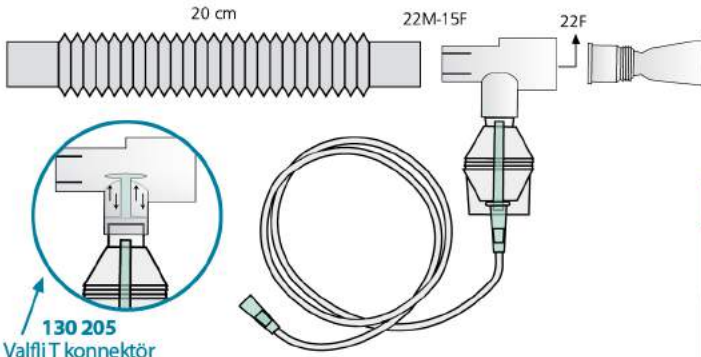

- Medikal grade PVC malzeme
- "T" konnektör
- 2m kırılmaya-bükülmeye dayanıklı iç kanallı hortum
- Nebulizer kap
- Latex free

- Medical grade PVC material
- "T" connector
- 2m kink resistant tubing
- Nebuliser cup
- Latex free

KOD / CODE	TIP / TYPE	KOLI ADEDİ QUANTITY PER BOX
130 109	T PARÇALI NEBULİZER SET NEBULISER SET WITH T PART	150
130 205	NEBULİZER SET - T PARÇALI - VALFİ NEBULISER SET WITH T PART AND VALVE	150

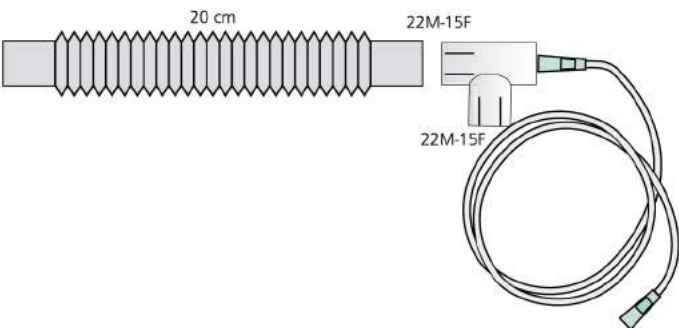

- Medikal grade PVC malzeme
- "T" konnektör
- 2m kırılmaya-bükülmeye dayanıklı iç kanallı hortum
- Latex free

- Medical grade PVC material
- "T" connector
- 2m kink resistant tubing
- Latex free

KOD / CODE	TIP / TYPE	KOLI ADEDİ QUANTITY PER BOX
489 601	SOLUNUM DEVRESİ "T" TÜPÜ BREATHING CIRCUIT "T" TUBE	150

CPAP & BIPAP MASKS

CPAP & BIPAP Maskeleri

Plasti-med[®]
"supporting healthy life"



CPAP & BIPAP MASKS

CPAP & BIPAP Maskeleri

Plasti-med[®]
"supporting healthy life"

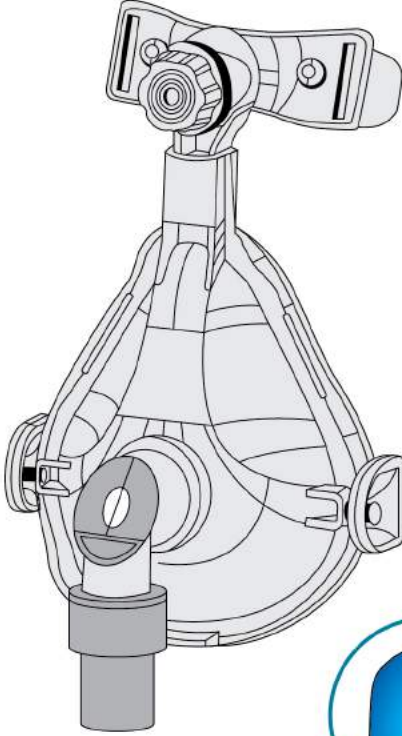

NIV Uygulama için
Non vented connector



KOD / CODE	TIP / TYPE	KOLI ADEDİ QUANTITY PER BOX
130 313	CPAP BPAP MASKESİ (AĞIZ-BURUN) – BÜYÜK CPAP BPAP MASK (ORA-NASAL) - LARGE	25
130 312	CPAP BPAP MASKESİ (AĞIZ-BURUN) – ORTA CPAP BPAP MASK (ORA-NASAL) - MEDIUM	25
130 311	CPAP BPAP MASKESİ (AĞIZ-BURUN) – KÜÇÜK CPAP BPAP MASK (ORA-NASAL) - SMALL	25



- CPAP-BPAP ve NIV modlara uygun tasarımlar
- %100 anti-alerjenik kokusuz medikal silikon
- Kırılmaz esnek polikarbon gövde
- 360° dönebilen hortum konnektörü
- Kaçağı önleyen çift katlı silikon tasarımı
- Silikon yastıklı, ayarlanabilir alın desteği
- Dört noktadan kafa bandı bağlantısı
- Elastik ve ayarlanabilir kafa bandı
- Oksijen girişi
- Klips sistemi ile kolay montaj

- Designs suitable for CPAP-BPAP and NIV modes
- 100% anti-allergenic odorless medical silicone
- Unbreakable flexible polycarbonate body
- 360° rotatable tube connector
- Prevent leakage double-layer silicone design
- Silicone cushion adjustable forehead support
- Four-point headband connection
- Elastic and adjustable headband
- Oxygen input
- Easy assembly by clip system

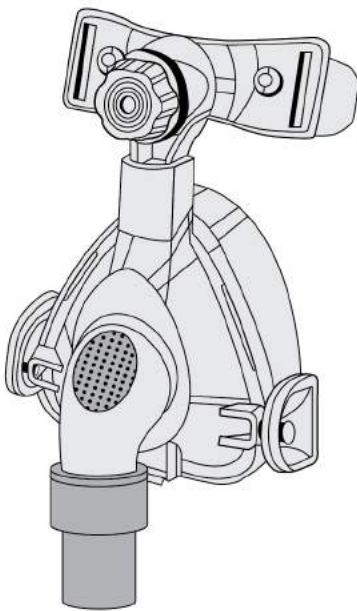

KOD / CODE	TIP / TYPE	KOLI ADEDİ QUANTITY PER BOX
130 323	CPAP BPAP MASKESİ (BURUN) – BÜYÜK CPAP BPAP MASK (NASAL) - LARGE	25
130 322	CPAP BPAP MASKESİ (BURUN) – ORTA CPAP BPAP MASK (NASAL) - MEDIUM	25
130 321	CPAP BPAP MASKESİ (BURUN) – KÜÇÜK CPAP BPAP MASK (NASAL) - SMALL	25



RESUSCITATOR

Suni Solunum Balonu

Plasti-med[®]
"supporting healthy life"



RESUSCITATOR

Suni Solunum Balonu

Plasti-med[®]
"supporting healthy life"



Ambu balonu - Yetişkin
Resuscitator bag - Adult



Ambu balonu- Pediatrik
Resuscitator bag - Pediatric

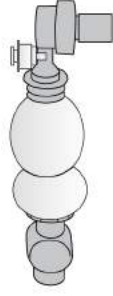

Ambu balonu - Yenidoğan
Resuscitator bag - Neonatal



* PVC rezervuar
PVC reservoir

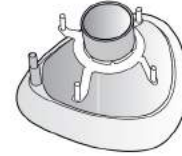

*Şişirilebilir yastıklı maske
Inflatable air cushion mask

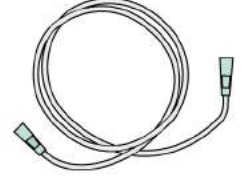

2m oksijen hortumu
2m oxygen tubing

TEK KULLANIMLIK / DISPOSABLE

- Ambu balonu
- PVC rezervuar
- 2m oksijen hortumu
- Şişirilebilir yastıklı maske

- *Resuscitator ballon*
- *PVC reservoir*
- *2m oxygen tubing*
- *Inflatable air cushion mask*

KOD / CODE	TİP / TYPE	KOLI ADEDİ QUANTITY PER BOX
130 255	TEK KULLANIMLIK MANUEL SUNİ SOLUNUM BALONU / YETİŞKİN <i>DISPOSABLE MANUEL RESUSCITATOR / ADULT</i>	20
130 254	TEK KULLANIMLIK MANUEL SUNİ SOLUNUM BALONU / PEDİATRİK <i>DISPOSABLE MANUEL RESUSCITATOR / PEDIATRIC</i>	20
130 253	TEK KULLANIMLIK MANUEL SUNİ SOLUNUM BALONU / INFANT <i>DISPOSABLE MANUEL RESUSCITATOR / INFANT</i>	20

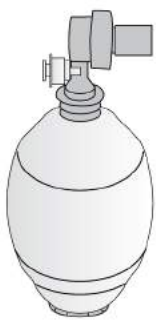

Ambu balonu - Yetişkin
Resuscitator bag - Adult



Ambu balonu - Pediatrik
Resuscitator bag - Pediatric

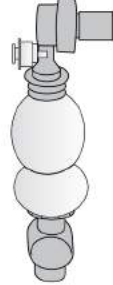

Ambu balonu - Yenidoğan
Resuscitator bag - Neonatal



*PVC rezervuar
PVC reservoir



*Silikon maske
Silicone mask

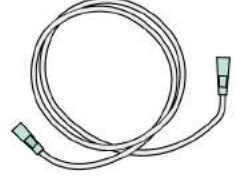

2m oksijen hortumu
2m oxygen tubing

ÇOK KULLANIMLIK / REUSABLE

- Ambu balonu
- PVC rezervuar
- 2m oksijen hortumu
- Silikon maske
- 134 °C'ye kadar otoklavlanabilir
- 25 kez steril edilebilir

- *Resuscitator ballon*
- *PVC reservoir*
- *2m oxygen tubing*
- *Silicone mask*
- *Autoclavable until 134 °C*
- *It can be sterilized for 25 times*

KOD / CODE	TİP / TYPE	KOLI ADEDİ QUANTITY PER BOX
130 252	TEKRAR KULLANILABİLİR MANUEL SUNİ SOLUNUM BALONU / YETİŞKİN <i>REUSABLE MANUEL RESUSCITATOR / ADULT</i>	20
130 251	TEKRAR KULLANILABİLİR MANUEL SUNİ SOLUNUM BALONU / PEDİATRİK <i>REUSABLE MANUEL RESUSCITATOR / PEDIATRIC</i>	20
130 250	TEKRAR KULLANILABİLİR MANUEL SUNİ SOLUNUM BALONU / INFANT <i>REUSABLE MANUEL RESUSCITATOR / INFANT</i>	20

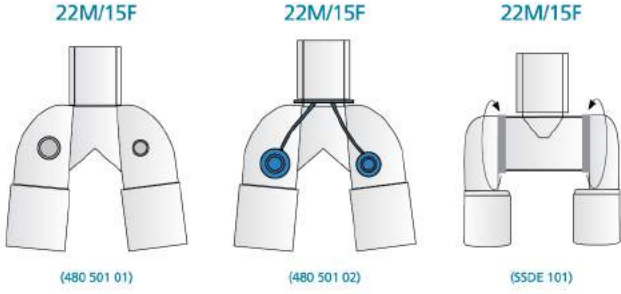

KOD / CODE	TIP / TYPE
480 501 01	Y KONNEKTÖR (PORTSUZ) Y CONNECTOR (WITHOUT PORT)
480 501 02	Y KONNEKTÖR (PORTLU) Y CONNECTOR (WITH PORT)
SSDE 101	Y KONNEKTÖR (AYARLANABİLİR) Y CONNECTOR (SWIVEL)

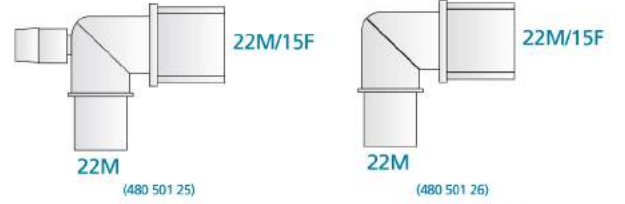

KOD / CODE	TIP / TYPE
480 501 25	DİRSEK KONNEKTÖR (PORTLU) ELBOW CONNECTOR (WITH PORT)
480 501 26	DİRSEK KONNEKTÖR (PORTSUZ) ELBOW CONNECTOR (WITHOUT PORT)

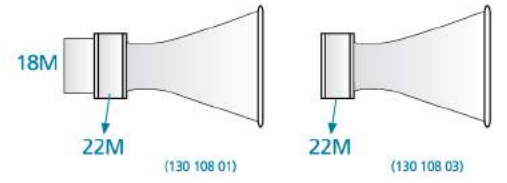
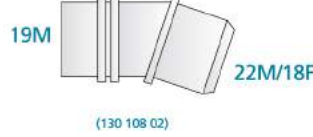
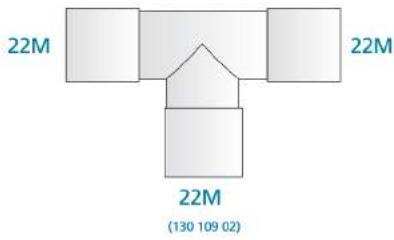

KOD / CODE	TIP / TYPE
130 108 02	MASKE DİRSEĞİ MASK ELBOW
130 056 02	DÖNER BAŞLIKLİ DİRSEK ROTATABLE ELBOW

KOD / CODE	TIP / TYPE
130 108 01	AĞIZLIK MOUTH PIECE
130 108 03	AĞIZLIK (T KONNEKTÖR İÇİN) MOUTH PIECE (FOR T CONNECTOR)

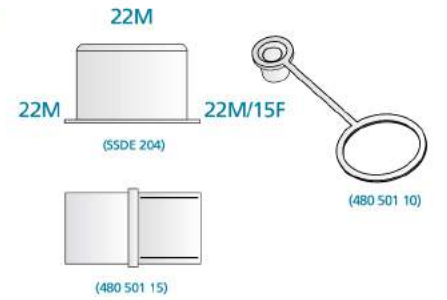
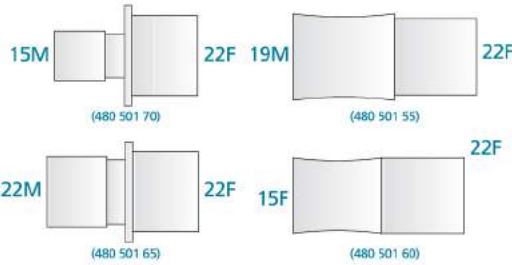
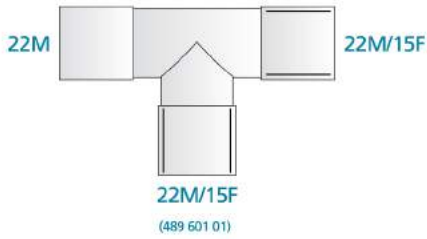

KOD / CODE	TIP / TYPE
130 109 02	T KONNEKTÖR TİP 1 T CONNECTOR TYPE 1
489 601 01	T KONNEKTÖR TİP 2 T CONNECTOR TYPE 2
480 501 75	T KONNEKTÖR TİP 3 T CONNECTOR TYPE 3

KOD / CODE	TIP / TYPE
480 501 70	PEDİATRİK KORUGE KONNEKTÖR PEDIATRIC CORRUGATED CONNECTOR
480 501 65	YETİŞKİN KORUGE KONNEKTÖR ADULT CORRUGATED CONNECTOR
480 501 60	PEDİATRİK SMOOTHBORE KONNEKTÖR PEDIATRIC SMOOTHBORE CONNECTOR
480 501 55	YETİŞKİN SMOOTHBORE KONNEKTÖR ADULT SMOOTHBORE CONNECTOR

KOD / CODE	TIP / TYPE
SSDE 204	MAVİ KORUMA KAPAĞI BLUE PROTECTION CAP
480 501 15	BALON KONNEKTÖRÜ BALLON CONNECTOR
480 501 10	Y KONNEKTÖR PORT KAPAĞI Y CONNECTOR PORT CAP



KOD / CODE	TIP / TYPE
480 501 50	SU TUTUCU 22M WATER TRAP 22M
480 501 51	SU TUTUCU 19M WATER TRAP 19M
480 501 52	SU TUTUCU 15M WATER TRAP 15M

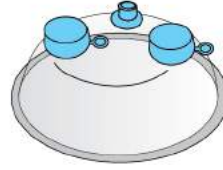
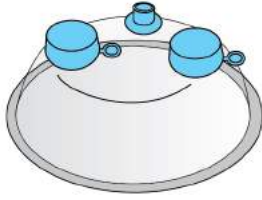

KOD / CODE	TIP / TYPE
SSDE 091	YETİŞKİN CHAMBER
SSDE 092	PEDIATRİK CHAMBER

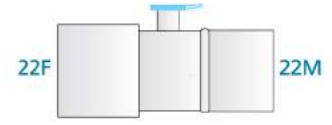
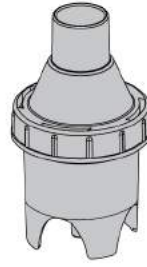
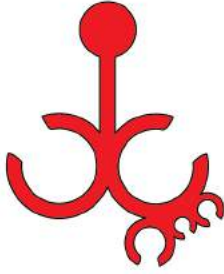

KOD / CODE	TIP / TYPE
480 501 80	ASKI CLIP

KOD / CODE	TIP / TYPE
130 106 09	NEBULİZER KAP NEBULISER CAP

KOD / CODE	TIP / TYPE
SSDE 111	MDI KONNEKTÖR MDI CONNECTOR

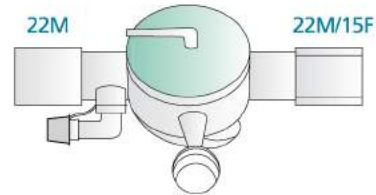
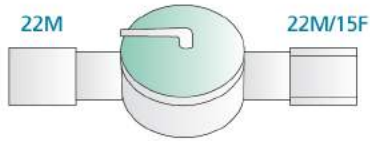

KOD / CODE	TIP / TYPE
SSDE 082	EKSHALASYON VALFİ TİP 1 EXHALATION VALVE TYPE 1

KOD / CODE	TIP / TYPE
SSDE 080	EKSHALASYON VALFİ TİP 2 EXHALATION VALVE TYPE 2

COMPONENTS

Komponentler

Plasti-med[®]
"supporting healthy life"

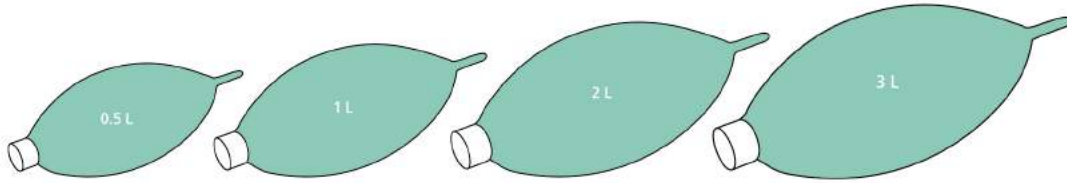

TEK KULLANIMLIK / DISPOSABLE

KOD / CODE	TIP / TYPE	KOD / CODE	TIP / TYPE
SSDE 070	ANESTEZİ BALONU 0,5 L ANESTHESIA BALLOON 0,5 L	SSDE 072	ANESTEZİ BALONU 2 L ANESTHESIA BALLOON 2 L
SSDE 071	ANESTEZİ BALONU 1 L ANESTHESIA BALLOON 1 L	SSDE 073	ANESTEZİ BALONU 3 L ANESTHESIA BALLOON 3 L

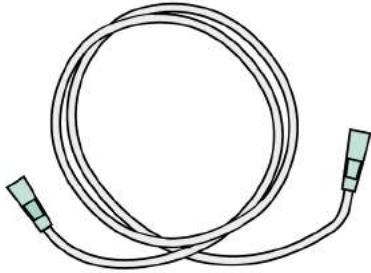

KOD / CODE	TIP / TYPE
130 112	OKSİJEN HORTUMU OXYGEN TUBING

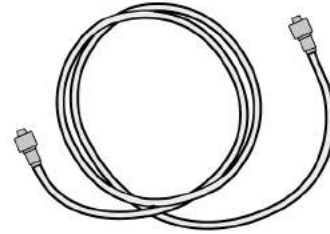

KOD / CODE	TIP / TYPE
320 XXX	*UZATMA HORTUM EXTENSION LINE

* M/M, M/F, F/M, F/F olarak üretilmektedir.
* Manufactured as M/M, M/F, F/M, F/F

OTHER PRODUCTS

Diğer Ürünler

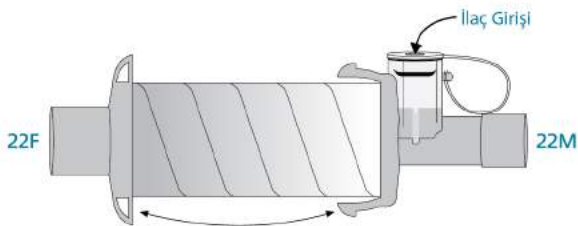

KOD / CODE	TIP / TYPE
489 641	SOLUNUM İNHALASYON TEDAVİ ÇEMBERİ BREATHING INHALATION - TREATMENT CHAMBER

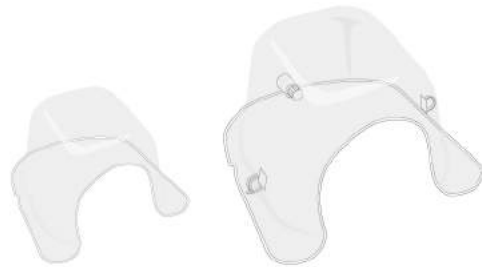

KOD / CODE	TIP / TYPE
470 101	HOOD BAŞLIĞI BÜYÜK HOOD CAP LARGE
470 111	HOOD BAŞLIĞI KÜÇÜK HOOD CAP SMALL



Since
1995

**Plasti-med Plastik Medikal Ürünler
Sanayi ve Ticaret Limited Şirketi**

Deri Osb Mahallesi Yan Sanayi Cad. No:13 Tuzla/İstanbul, TÜRKİYE
Tel: +90 (216) 591 04 91 Fax: +90 (216) 591 04 90

info@plasti-med.com
www.plasti-med.com

Plasti-med[®]
"supporting healthy life"

Plasti-med Plastik Medikal Ürünler Sanayi ve Ticaret Limited Şirketi

Deri Osb Mahallesi Yan Sanayi Cad. No: 13 Tuzla/İstanbul, TÜRKİYE

Tel: +90 (216) 591 04 91 Fax: +90 (216) 591 04 90

info@plasti-med.com www.plasti-med.com

