

Codul produsului, broșuri, poze, manuale cu date tehnice, alte materiale confirmative.

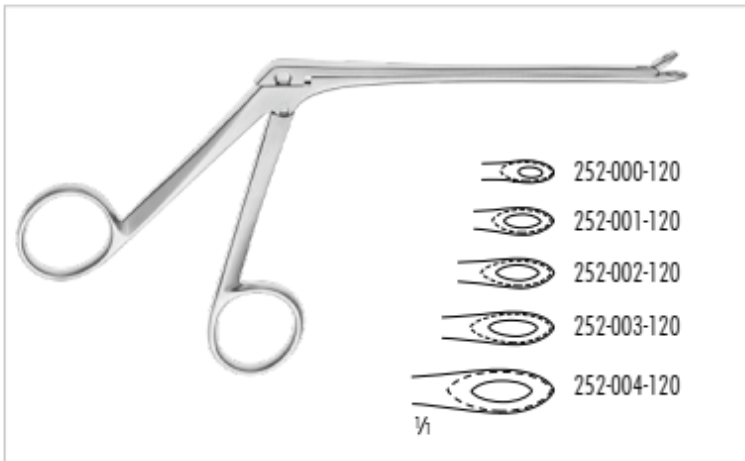

252-000-120	Fig.0	3,0 mm
252-001-120	Fig.1	3,6 mm
252-002-120	Fig.2	4,2 mm
252-003-120	Fig.3	4,8 mm
252-004-120	Fig.4	5,6 mm

WEIL-BLAKESLEY

Siebbeinzangen, gerade, ovaler Löffel, gefensterter Maul, 120 mm
Ethmoidal forceps, straight, oval, cup-shaped fenestrated jaws, 4 ¾ inch

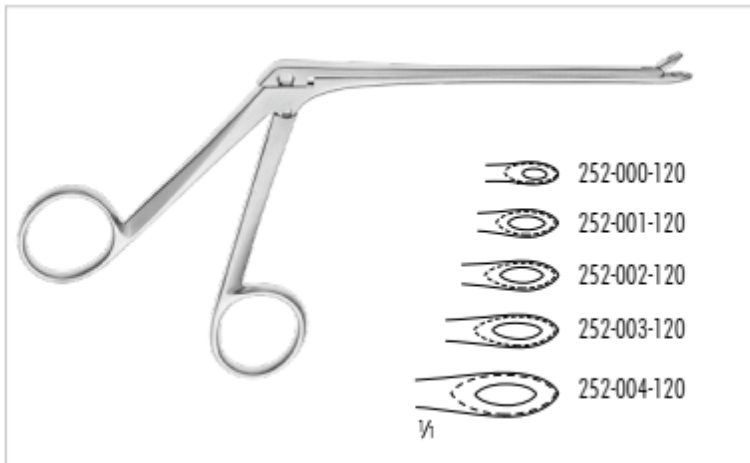

252-000-120	Fig.0	3,0 mm
252-001-120	Fig.1	3,6 mm
252-002-120	Fig.2	4,2 mm
252-003-120	Fig.3	4,8 mm
252-004-120	Fig.4	5,6 mm

WEIL-BLAKESLEY

Siebbeinzangen, gerade, ovaler Löffel, gefensterter Maul, 120 mm
Ethmoidal forceps, straight, oval, cup-shaped fenestrated jaws, 4 ¾ inch

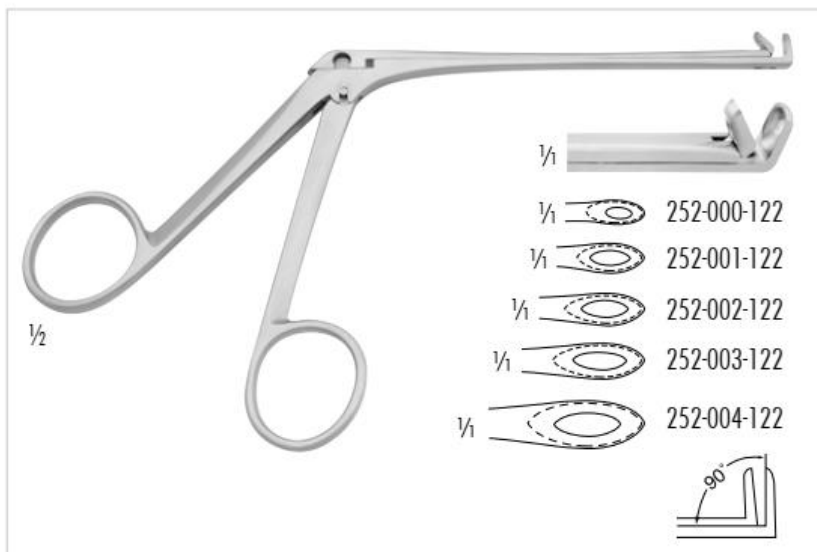

252-000-122	Fig.0	3,0 mm
252-001-122	Fig.1	3,6 mm
252-002-122	Fig.2	4,2 mm
252-003-122	Fig.3	4,8 mm
252-004-122	Fig.4	5,6 mm

WEIL-BLAKESLEY

Siebbeinzange, 90° aufgewinkelt, 110 mm
Ethmoidal forceps, 90° angled up, 4 ½ inch

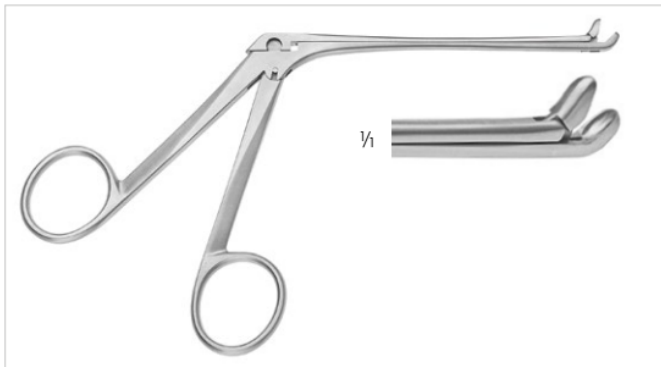

252-425-115

BEAD

Bead Nasenzange mit Löffel, aufgebogen, kleines Modell, Arbeitslänge: 115mm

Nasal Forceps with cup jaws, upturned, small model, Working length: 4 1/2 inch

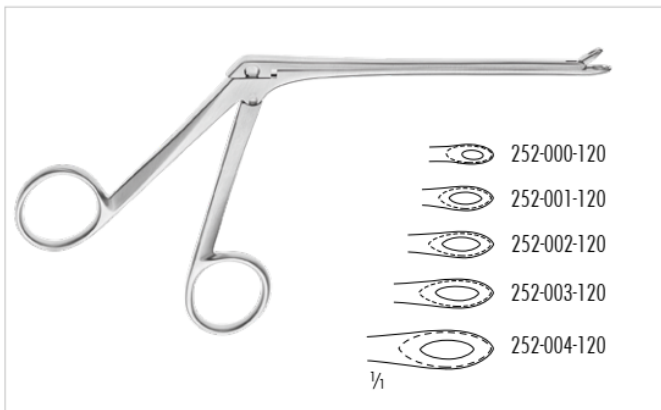

- 252-000-120 Fig.0 3,0 mm
- 252-001-120 Fig.1 3,6 mm
- 252-002-120 Fig.2 4,2 mm
- 252-003-120 Fig.3 4,8 mm
- 252-004-120 Fig.4 5,6 mm

WEIL-BLAKESLEY

Siebbeinzangen, gerade, ovaler Löffel, gefensterter Maul, 120 mm
Ethmoidal forceps, straight, oval, cup-shaped fenestrated jaws, 4 3/4 inch

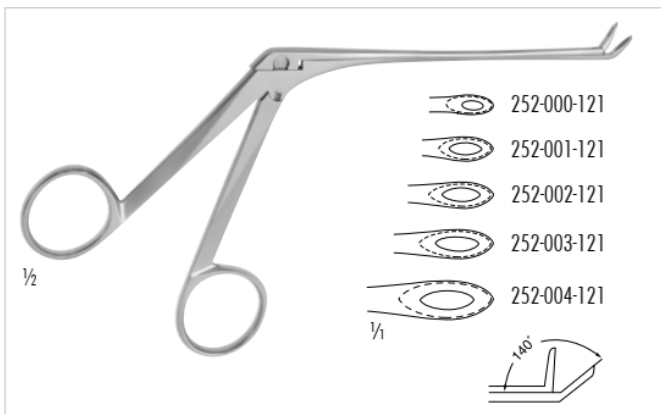

- 252-000-121 Fig.0 3,0 mm
- 252-001-121 Fig.1 3,6 mm
- 252-002-121 Fig.2 4,2 mm
- 252-003-121 Fig.3 4,8 mm
- 252-004-121 Fig.4 5,6 mm

WEIL-BLAKESLEY

Siebbeinzangen, aufgebogen, ovaler Löffel, gefensterter Maul, 110 mm
Ethmoidal forceps, upwards curved, oval cup, fenestrated jaws, 4 1/2 inch

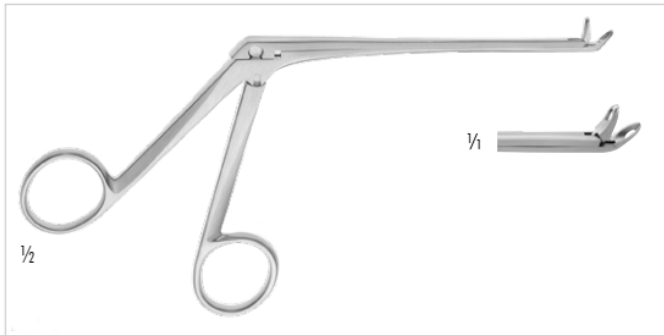

252-000-111

STRUEMPEL-VOSS

Siebbeinzange 45° aufgebogen, besonders fein, 2,5mm

110 mm Schaft

Ethmoidal forceps, 45° upwards curved, oval, very delicate, 2.5mm

110 mm shaft

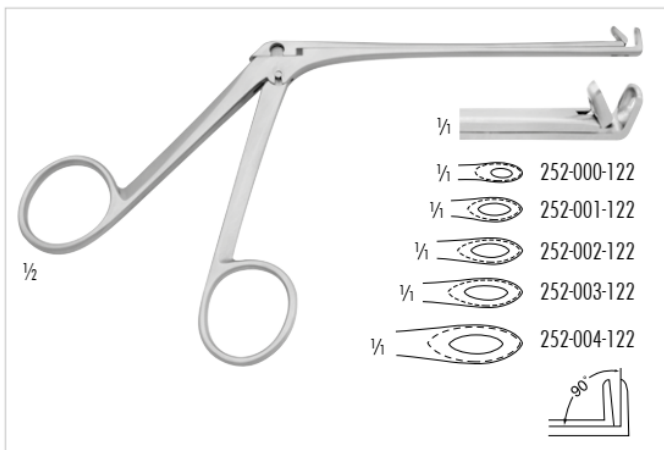

252-000-122

Fig.0 3,0 mm

252-001-122

Fig.1 3,6 mm

252-002-122

Fig.2 4,2 mm

252-003-122

Fig.3 4,8 mm

252-004-122

Fig.4 5,6 mm

WEIL-BLAKESLEY

Siebbeinzange, 90° aufgewinkelt, 110 mm

Ethmoidal forceps, 90° angled up, 4 1/2 inch



0°

252-035-150

Größe/Size 1: 3,5mm

252-040-150

Größe/Size 2: 4,0mm

252-050-150

Größe/Size 3: 5,0mm

45°

252-035-151

Größe/Size 1: 3,5mm

252-040-151

Größe/Size 2: 4,0mm

90°

252-035-152

Größe/Size 1: 3,5mm

252-040-152

Größe/Size 2: 4,0mm

BLAKESLEY

Nasenzange, Arbeitslänge: 150mm Arbeitslänge:

Nasal Forceps, working length: 6 inch

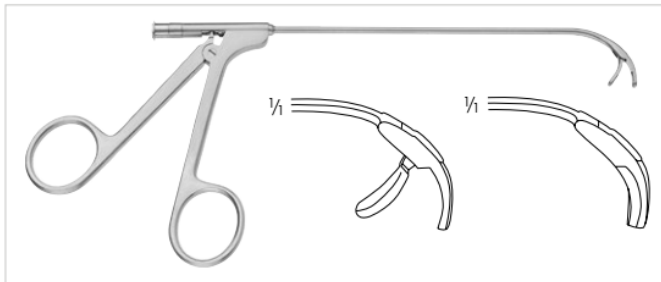
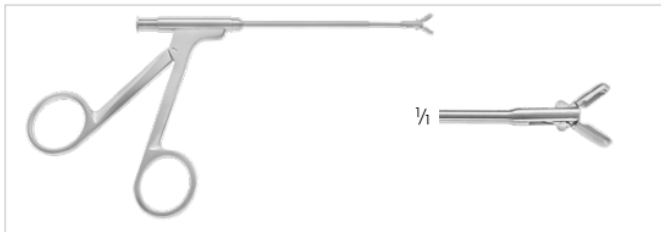
**252-410-112****HEUWIESER**Kieferhöhlen-Faßzange, 90° gebogen, bis 120° rückwärts öffnend,
Arbeitslänge: 130 mmAntrum grasping forceps, 90° curved, 120° backward opening,
working length: 5 inch**252-503-090**

Biopsie- und Faßzange, ovaler Löffel, 3x6mm, 89mm Arbeitslänge

Biopsy and Grasping forceps, 3x6mm oval cup, 89mm working length

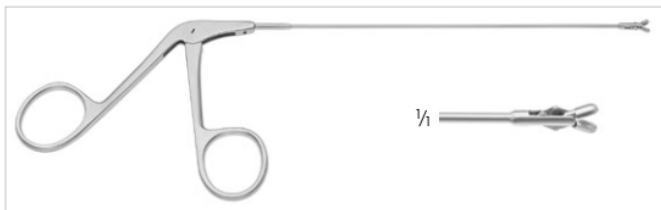
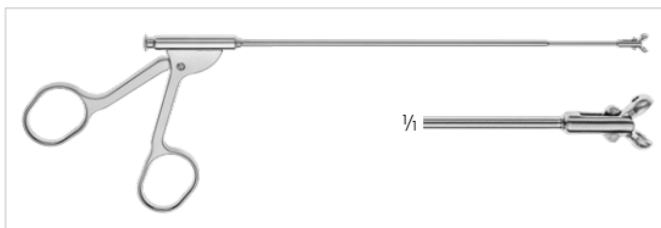
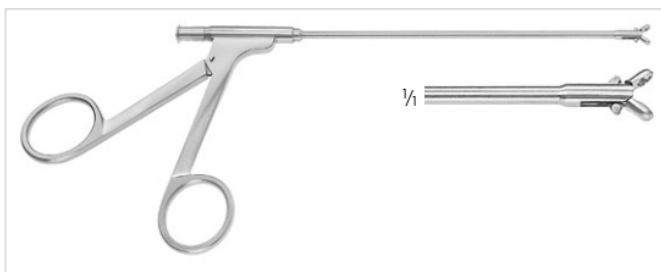
**252-503-140**Probexcisions- und Faßzange, extra fein, mit ovalem Löffel 3 mm,
140 mmBiopsy and Grasping forceps, delicate pattern, 3 mm oval cup,
5 1/2 inch**252-174-180**Probexcision- und Faßzange, Schaftende biegsam,
4 mm Löffel, vertikal öffnend, 180 mmBiopsy and Grasping forceps, malleable shaft, 4 mm biopsy cup,
vertical opening, 7 inch**252-503-150**Biopsie- und Faßzange, 3mm Löffel rund, gerade, mit Luer-Lock,
150mm ArbeitslängeBiopsy and Grasping Forceps, 3mm round cup, straight, with luer-lock,
150mm working length

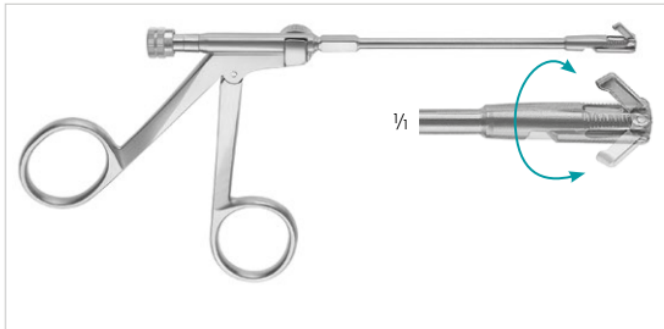

252-310-100 drehbar, 360°/rotating, 360°

OSTROM

Kieferhöhlenstanze, kleines schlankes Modell, 1,5 mm Schnitt

Arbeitslänge: 100 mm

Antrum punch, small delicate pattern, 1.5 mm bite, working length: 4 inch

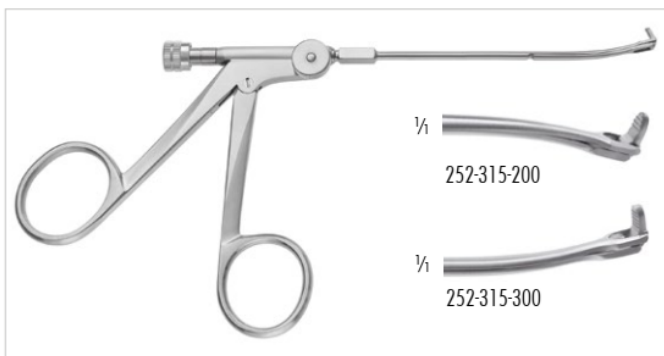

252-315-200 abgebogen/curved down

252-315-300 aufgebogen/curved up

OSTROM

Nasenzange, drehbar, kleiner Schnitt, Arbeitslänge: 100 mm

Ethmoidal forceps, rotating, micro bite, working length: 4 inch

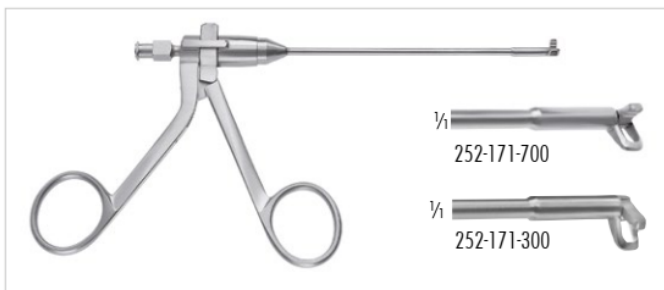

252-173-700 links schneidend/left cutting

252-171-700 rechts schneidend/right cutting

252-171-300 nach rechts unten schneidend/
downward right cutting

252-173-300 nach links unten schneidend/
downward left cutting

SIDECUTTER

Kieferhöhlenstanze, 2,5 mm Schnitt, Arbeitslänge: 100 mm

Antrum Punch, 2.5 mm bite, working length: 4 inch

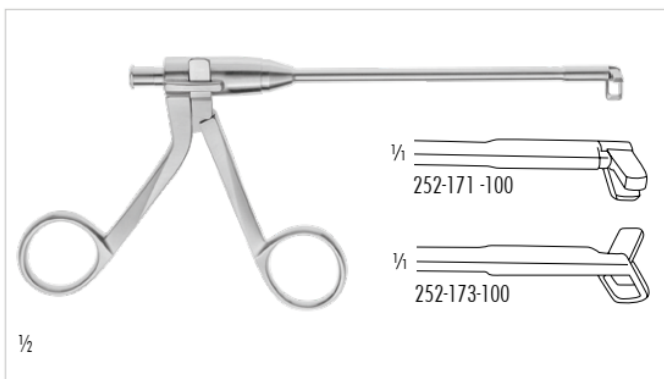

252-171-100 nach rechts unten schneidend
downward right cutting

252-173-100 nach links unten schneidend
downward left cutting

SIDECUTTER

Kieferhöhlenstanze, 3,5mm Schnitt, Arbeitslänge: 100 mm

Antrum punch, 3.5mm cut, working length: 4 inch



- 420-418-140 Mit Gitter, aufgebogen/
with basket, curved up
420-419-140 Ohne Gitter, aufgebogen/
without basket, curved up
420-420-140 Ohne Gitter, gerade/
without basket, straight

WATSON-WILLIAMS

Nasenzange, durchschneidend, 3 mm Schnitt,
Arbeitslänge: 140 mm
Nasal Forceps, through cutting, 3 mm bite,
Working length: 5 ½ inch

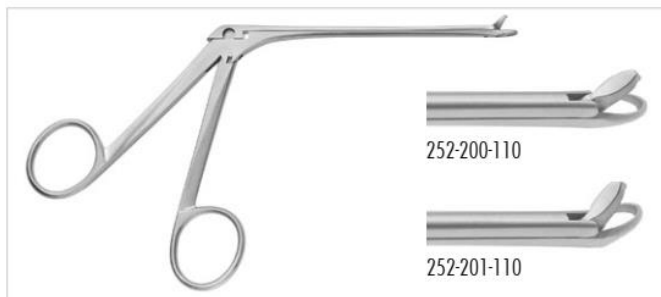

- 252-200-110 2 mm Schnitt, gerade/bite, straight
252-200-111 2,5 mm Schnitt, gerade/bite, straight
252-200-112 3 mm Schnitt, gerade/bite, straight
252-201-110 2 mm Schnitt, aufgebogen/bite, upcurved
252-201-111 2,5 mm Schnitt, aufgebogen/bite, upcurved
252-201-112 3 mm Schnitt, aufgebogen/bite, upcurved

BLAKESLEY

Nasenzange, durchschneidend, 115 mm
Nasal Forceps, through cutting, 4 ½ inch

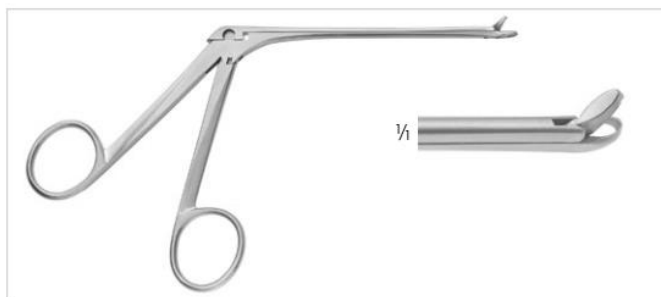

- 252-202-111 Fig.1 links gebogen/left curved jaw
252-203-111 Fig.2 rechts gebogen/right curved jaw

BLAKESLEY

Nasenzange, durchschneidend, 2,5mm Schnitt, 115mm
Nasal Forceps, through cutting, 2.5mm cut, 4 ½ inch

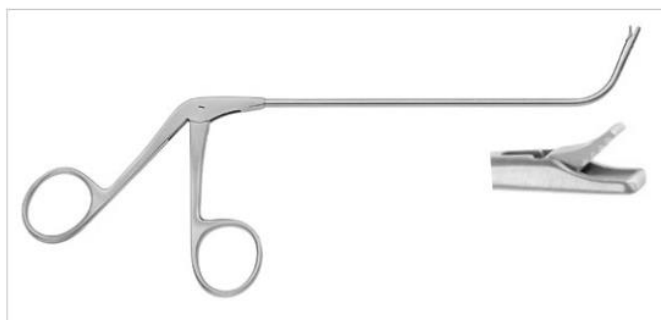

- 252-477-141 rückwärts öffnend/backward cutting
252-477-142 links öffnend/left side cutting
252-477-143 rechts öffnend/right side cutting

NICOLAI

Stirnhöhlezange 2mm Schnitt, 65° aufgebogen
Antrum Forceps, 2mm bite, 65° angled upwards

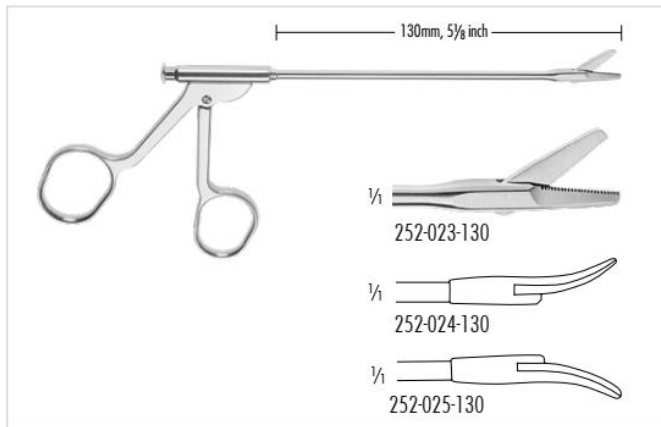

252-023-130 gerade/straight
 252-024-130 links gebogen/curved to left
 252-025-130 rechts gebogen/curved to right
 Nasenschere, 130 mm
 Nasal scissors, 5 1/8 inch

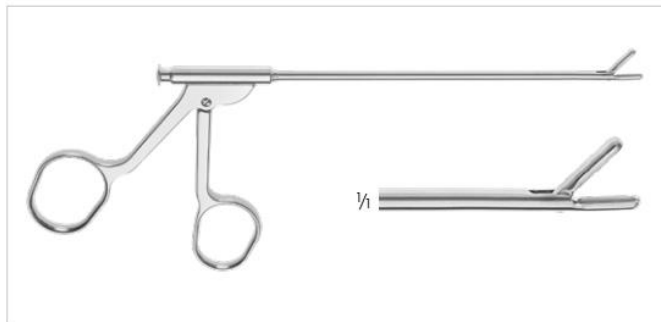

252-002-130
TAKAHASHI
 Siebbeinzange, 3x10 mm, 130 mm
 Ethmoidal forceps, 3x10 mm, 5 1/8 inch

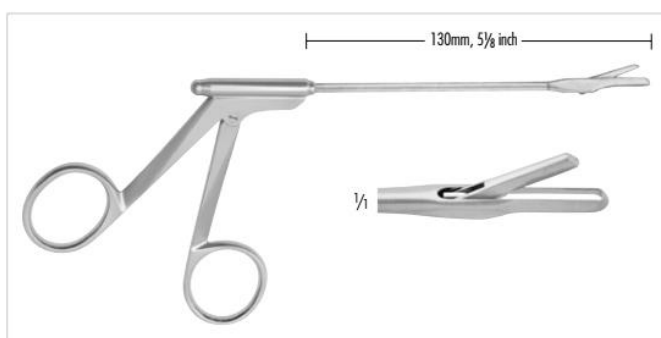

252-003-130
STRUYCKEN
 Siebbeinzange, 130 mm
 Ethmoidal forceps, 5 1/8 inch

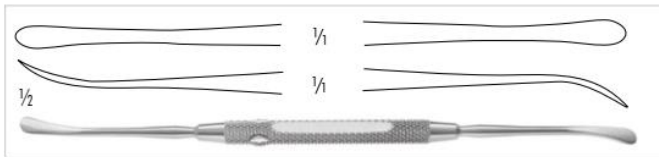

420-546-180 5 mm
FREER
 Elevatorium, scharf/stumpf, 185 mm
 Elevator, sharp /blunt, 7 1/4 inch

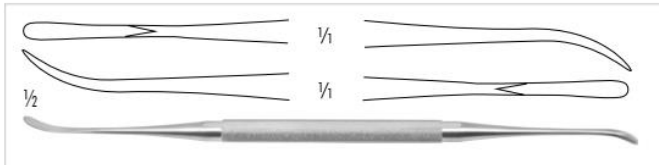

420-548-180
FREER-YASARGIL
 Dissektor, scharf, 190 mm
 Dissector, sharp, 7 1/2 inch



210-528-240
COHEN
 Elevator, doppelendig, 240mm
 Elevator, double-ended, 9 1/2 inch



420-556-200
WOODSON
 Elevator, 2,4 / 4,0mm Blatt, 200mm
 Elevator, 2,4 / 4.0mm blade, 8 inch



420-395-205 6 mm
NEGUS
 Saugdissektor, stumpf 210 mm
 Suction dissector, blunt, 8 1/4 inch



420-253-185 3 mm
GORNEY
 Saugraspatorium, halb-scharf 180 mm
 Suction raspatory, semi-sharp 7 inch

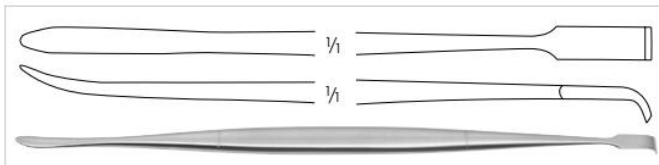

420-552-215
HOWARTH
 Doppel-Elevatorium, 215 mm
 Elevator, double-ended, 8 1/4 inch

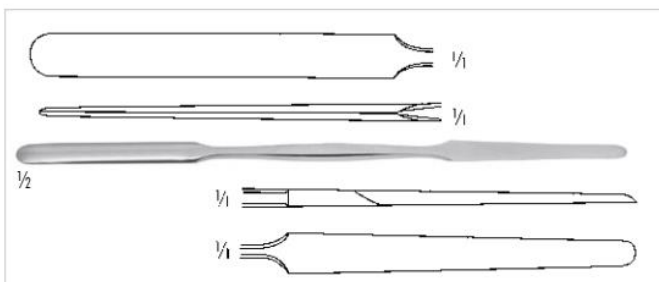

420-541-180
KILLIAN
 Doppel-Elevatorium, scharf/stumpf, 185 mm
 Elevator, double-ended, sharp/blunt, 7 1/4 inch

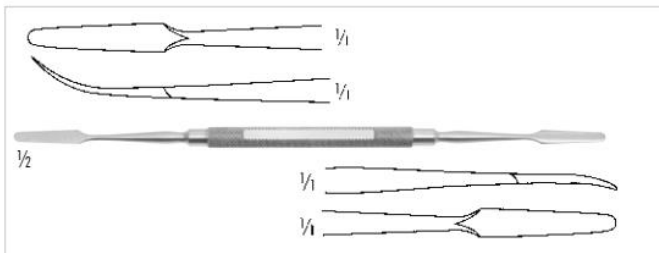

420-540-180
KILLIAN
 Doppel-Elevatorium, scharf/stumpf, 180 mm
 Elevator, double-ended, sharp/blunt, 7 inch



420-413-230

LANGE

Choanenhaken, 230 mm
Choana hook, 9 ½ inch

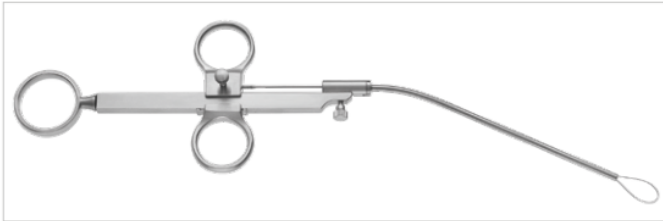

420-201-260

KRAUSE

Nasenpolypenschnürer, kniegebogen, 250 mm
Nasal polypus snare, knee bent, 10 inch

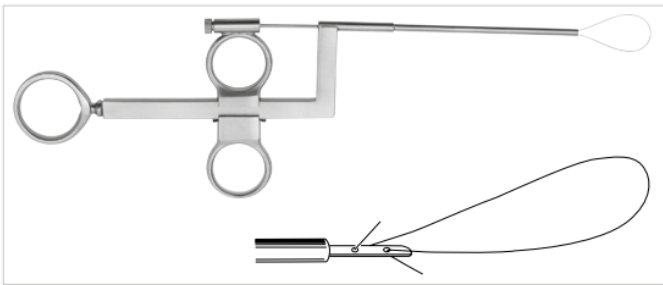

410-270-250

WILDE

Nasenpolypenschnürer, bajonettförmig gebogen, 250 mm
Nasal polypus snare, bayonet shaped, 10 inch



420-210-003 Ø 0,3 mm

Schlingen für Nasenpolypenschnürer,
Bestelleinheit: PH=Packung á 100 Stück
Wire loops for nasal snares,
sales unit: PH=Package of 100 pieces



420-210-013 Ø 0,3 mm

Schnürerdraht in Rollen á 10 m
Snare wire in coils of 10 metres

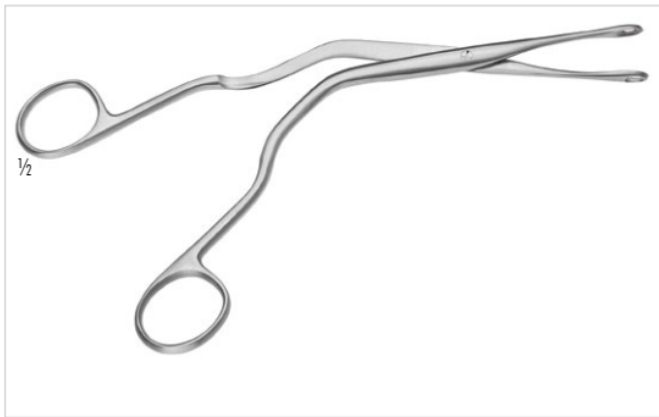

420-400-001 6,0 mm
 420-400-002 7,5 mm
 420-400-003 9,0 mm

LUC

Septumzange, gefenestert, 190 mm
 Septum forceps with fenestrated jaws, 7 1/2 inch

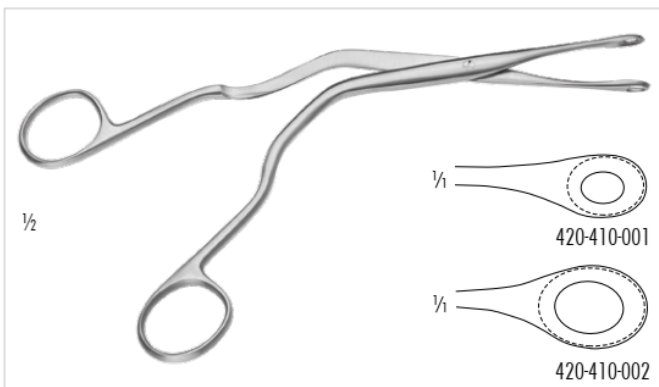

420-410-001 Fig. 1
 420-410-002 Fig. 2

LUC

Septumzange, gefenestert, 200 mm
 Septum forceps with fenestrated jaws, 8 inch

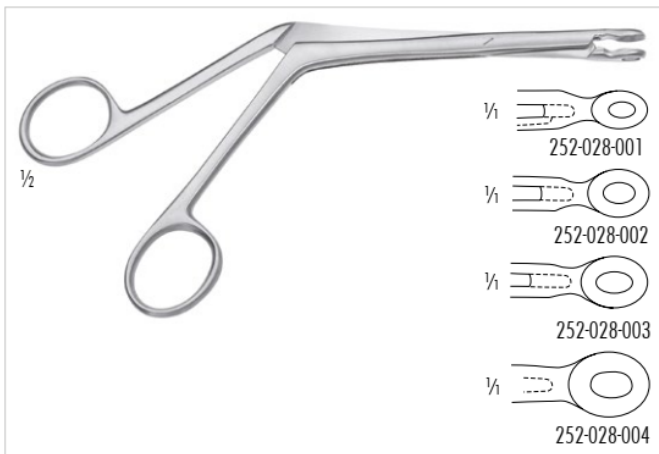

252-028-001 Größe/Size 1
 252-028-002 Größe/Size 2
 252-028-003 Größe/Size 3
 252-028-004 Größe/Size 4

BRUENINGS

Septumzange, gefenestert, 190 mm
 Septum forceps, fenestrated jaws, 7 1/2 inch



252-029-000 6mm

CRAIG

Vormerzange, gerade, scharfer Löffel oval, 165 mm
 Septum bone cutting and breaking forceps straight, sharp cup, 6 1/2 inch

252-029-165 6mm

CRAIG

Vormerzange mit eckigen Schneidkanten, 165 mm
 Septum bone cutting and breaking forceps straight, sharp cup, 6 1/2 inch



252-025-150 außen Ø 2,5 mm/outer Ø 2.5 mm
 252-025-151 außen Ø 3,0 mm/outer Ø 3.0 mm
 252-025-152 außen Ø 4,0 mm/outer Ø 4.0 mm

EICKEN

Kiefernhöhlenspülröhrchen, leicht gebogen, mit zentraler Öffnung und Luer-Ansatz, 130 mm
 Irrigating antrum cannula with central opening, slightly curved, Luer attachment, 5 1/2 inch



252-125-150 außen Ø 2,5 mm/outer Ø 2.5 mm
 252-125-151 außen Ø 3,0 mm/outer Ø 3.0 mm
 252-125-152 außen Ø 4,0 mm/outer Ø 4.0 mm

EICKEN

Kiefernhöhlenspülröhrchen, stark gebogen, mit zentraler Öffnung und Luer-Ansatz, 140 mm
 Irrigating antrum cannula with central opening, strong curved, Luer attachment, 5 1/2 inch



252-225-150 außen Ø 2,5 mm/outer Ø 2.5 mm
 252-225-151 außen Ø 3,0 mm/outer Ø 3.0 mm
 252-225-152 außen Ø 4,0 mm/outer Ø 4.0 mm

EICKEN

Antrum Kanüle, stark gebogen, mit Stoploch im Griff, Arbeitslänge: 150 mm
 Antrum Cannula, strong curved, with cut-off hole, working length: 6 inch



252-325-150 außen Ø 2,5 mm/outer Ø 2.5 mm
 252-325-151 außen Ø 3,0 mm/outer Ø 3.0 mm
 252-325-152 außen Ø 4,0 mm/outer Ø 4.0 mm

EICKEN

Antrum Kanüle, leicht gebogen, mit Stoploch im Griff Arbeitslänge: 150 mm
 Antrum Cannula, slightly curved, with cut-off hole, working length: 6 inch



252-425-150 außen Ø 2,5 mm/outer Ø 2.5 mm
 252-425-151 außen Ø 3,0 mm/outer Ø 3.0 mm
 252-425-152 außen Ø 4,0 mm/outer Ø 4.0 mm

EICKEN

Antrum Kanüle, leicht gebogen, biegsam, Arbeitslänge: 150 mm
 Antrum Cannula, slightly curved, malleable, working length: 6 inch



GULEN
Suction Elevator, 200mm, 8"

Right curved	165-521-200
Left curved	165-522-200



NEGUS
Suction Dissector, blunt, Ø 6mm

205mm, 8 1/8"	420-395-205
---------------	-------------



RZ
Nasal Suction Dissector, sharp, Luer Lock, Ø 8mm

190mm, 7 1/2"	420-310-190
---------------	-------------



GORNEY
Suction Raspator, Ø 3mm, 180mm, 7"

Blunt	420-252-185
Semi-Sharp	420-253-185



252-104-000 0°
 252-104-030 30°
 252-104-045 45°
 252-104-070 70°

Sinuskopie-Optiken, autoklavierbar, 4,0 mm, 180 mm
 Sinusscopes, autoclavable, 4.0 mm, 7 inch

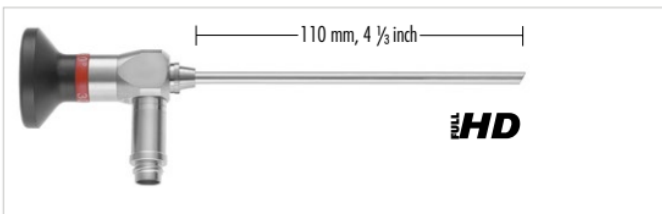

252-104-200 0°
 252-104-230 30°
 252-104-270 70°

Sinuskopie-Optiken, Kinder, autoklavierbar, 4,0 mm, 110 mm
 Sinusscopes, pediatric, autoclavable, 4.0 mm, 4 1/3 inch



252-127-000 0°
 252-127-030 30°
 252-127-070 70°

Sinuskopie-Optiken, autoklavierbar, 2,7 mm, 180 mm
 Sinusscopes, autoclavable, 2.7 mm, 7 inch

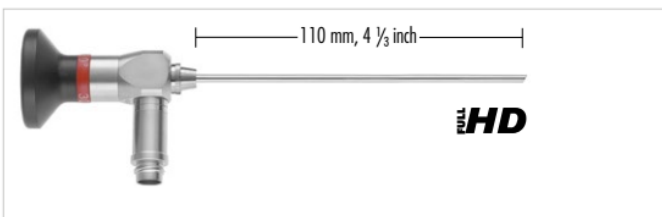

252-127-200 0°
 252-127-230 30°

Sinuskopie-Optiken, Kinder, autoklavierbar, 2,7 mm, 110 mm
 Sinusscopes, pediatric, autoclavable, 2.7 mm, 4 1/3 inch

- Removable eyepiece for C-mount connection or RZ QuickSnap locking
- 3-step light post adaptors to connect the most common light cables directly to the endoscope
- Sapphire glasses ensure highest stability against damages on the lens system
- Optimised glass fibre arrangements ensure an uniform image brightness of highest quality
- Full HD high definition pictures with increased detail-resolution through newest CAD-designed rod-lens systems
- Fully Autoclavable at 134°C and 2.3bar

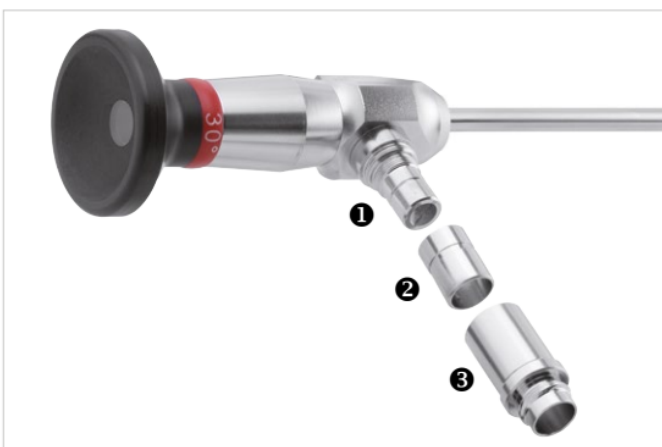

- 1 RZ/Storz Anschluss / RZ/Storz connection
- 2 R. Wolf Anschluss / R. Wolf connection
- 3 ACMI/Gyrus Anschluss / ACMI/Gyrus connection



Bayonet	180mm		200mm	
	flat plug 2-pin	straight tips	straight tips	straight tips
0.3mm tip (point)	flat plug	700-050-180	700-050-200	
	2-pin	700-052-180	700-052-200	
0.6mm tip (blunt)	flat plug	700-060-180	700-060-200	
	2-pin	700-062-180	700-062-200	
1.0mm tip (blunt)	flat plug	700-070-180	700-072-200	
	2-pin	700-072-180	700-072-200	
2.0mm tip (blunt)	flat plug	700-080-180	700-082-200	
	2-pin	700-082-180	700-082-200	
Bayonet	225mm		250mm	
	flat plug 2-pin	straight tips	straight tips	straight tips
0.3mm tip (point)	flat plug	700-050-220	700-050-250	
	2-pin	700-052-220	700-052-250	
0.6mm tip (blunt)	flat plug	700-060-220	700-060-250	
	2-pin	700-062-220	700-062-250	
1.0mm tip (blunt)	flat plug	700-070-220	700-070-250	
	2-pin	700-072-220	700-072-250	
2.0mm tip (blunt)	flat plug	700-080-220	700-080-250	
	2-pin	700-082-220	700-082-250	

Bayonet Shape	180mm		200mm		220mm		240mm	
	flat plug 2-pin	straight tips	straight tips	straight tips	straight tips	straight tips	straight tips	straight tips
0.3mm tip (point)	flat plug	700-050-180	700-050-200	700-050-220	700-050-240			
	2-pin	700-052-180	700-052-200	700-052-220	700-052-240			
0.6mm tip (blunt)	flat plug	700-060-180	700-060-200	700-060-220	700-060-240			
	2-pin	700-062-180	700-062-200	700-062-220	700-062-240			
1.0mm tip (blunt)	flat plug	700-070-180	700-070-200	700-070-220	700-070-240			
	2-pin	700-072-180	700-072-200	700-072-220	700-072-240			
2.0mm tip (blunt)	flat plug	700-080-180	700-080-200	700-080-220	700-080-240			
	2-pin	700-082-180	700-082-200	700-082-220	700-082-240			
Bayonet Shape, angled up/angled down	200mm		220mm		200mm		220mm	
	flat plug 2-pin	angled up tips	angled up tips	angled down tips	angled down tips	angled down tips	angled down tips	angled down tips
1.0mm tip (blunt)	flat plug	700-670-201	700-670-221	700-670-203	700-670-223			
	2-pin	700-672-201	700-672-221	700-672-203	700-672-223			

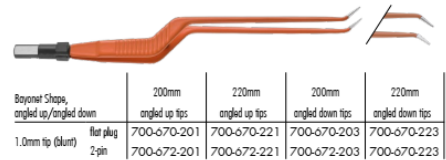

Electrode container stainless steel for storage or during sterilization



Sterilization Container for 4mm Electrodes
8 Electrodes holding capacity 1 pc. 700-700-002



Sterilization Container for 2.4mm Electrodes
8 Electrodes holding capacity 1 pc. 700-700-001

NON-STICK FORCEPS

By using a polished noble material with excellent thermal properties for the forcep's tip, the undesired effect of sticking tissue is now completely eliminated and non-stop working is ensured.



Straight	150mm		180mm		200mm		220mm	
	flat plug 2-pin	straight tips	angled tips	straight tips	angled tips	straight tips	straight tips	straight tips
0.3mm tip (point)	flat plug	700-010-150	700-011-150	700-010-180	700-011-180	700-010-200	700-010-220	
	2-pin	700-012-150	700-013-150	700-012-180	700-013-180	700-012-200	700-012-220	
0.6mm tip (blunt)	flat plug	700-020-150	700-021-150	700-020-180	700-021-180	700-020-200	700-020-220	
	2-pin	700-022-150	700-023-150	700-022-180	700-023-180	700-022-200	700-022-220	
1.0mm tip (blunt)	flat plug	700-030-150	700-031-150	700-030-180	700-031-180	700-030-200	700-030-220	
	2-pin	700-032-150	700-033-150	700-032-180	700-033-180	700-032-200	700-032-220	
2.0mm tip (blunt)	flat plug	700-040-150	700-041-150	700-040-180	700-041-180	700-040-200	700-040-220	
	2-pin	700-042-150	700-043-150	700-042-180	700-043-180	700-042-200	700-042-220	



JEWELER TYPE	110mm		
	flat plug 2-pin	straight tips	angled tips
0.25mm tip (point)	flat plug	700-001-710	700-001-730
	2-pin	700-001-711	700-001-731
0.6mm tip (blunt)	flat plug	700-001-712	700-001-732
	2-pin	700-001-713	700-001-733
1.0mm tip (blunt)	flat plug	700-001-714	700-001-734
	2-pin	700-001-715	700-001-735



SYRINGES & EVACUATORS

with Turn Lock connection to connect to RZ Cystoscope and Resectoscope sheaths



Bladder Syringe
 253-000-975 75cc
 253-000-900 100cc
 253-000-950* 150cc



Spare Glass Cylinder
 253-000-976 75cc
 253-000-901 100cc
 253-000-951 150cc







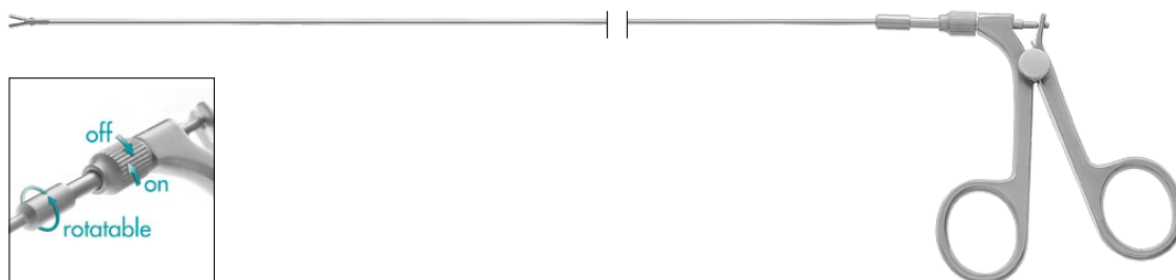

Elik Evacuator
 253-500-000 with turn lock connection
 253-500-001 with standard connection

- 1 253-500-003 Rubber ball
- 2 253-500-004 Glass body
- 3 253-500-020 Turn Lock connector with silicone tube
- 4 253-500-010 Standard connector with silicone tube

Flexible Instruments for use with cystoscopes



Working length: 400mm
Rotatable and detachable

	Flexible		Semi-rigid	
 Grasping Forceps, serrated jaws, double action	351-114-105* 5 Charr. 351-114-107* 7 Charr. 351-114-109 9 Charr.		351-114-305 5 Charr. 351-114-307 7 Charr.	
 Biopsy Forceps, oval cup, double action	351-120-105* 5 Charr. 351-120-107* 7 Charr. 351-120-109 9 Charr.		351-120-305 5 Charr. 351-120-307 7 Charr.	
 Serrated Biopsy Forceps, oval cup with aggressive serration, double action	351-124-107 7 Charr.		351-124-307 7 Charr.	
 Scissors, single action	351-100-105* 5 Charr. 351-100-107 7 Charr. 351-100-109 9 Charr.		351-100-305 5 Charr. 351-100-307 7 Charr.	
 DJ Forceps, double action	351-107-107 7 Charr. 351-107-109 9 Charr.		351-107-307 7 Charr.	
 Grasping Forceps, serrated jaw, double action, 730mm working length	253-958-105 5 Charr.			
 Biopsy Forceps, double action, 730mm working length	253-957-105 5 Charr.			

OPTICAL FORCEPS

- for use with \varnothing 4mm Cystoscopes

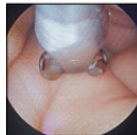
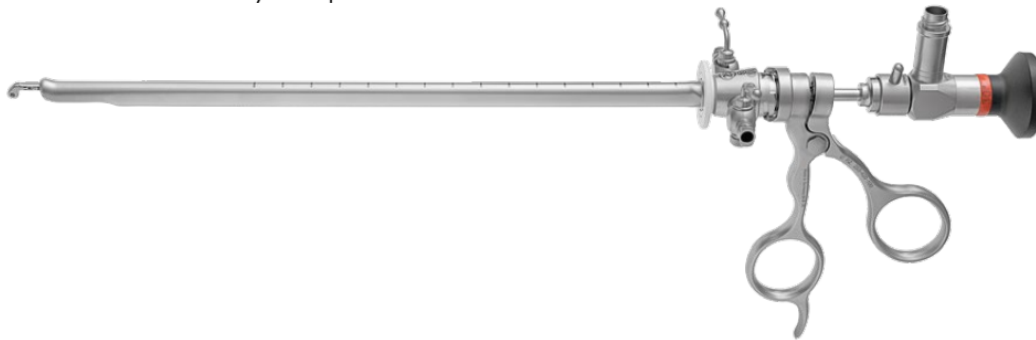

Scope is **below** forceps



Scope is **above** Forceps



253-420-100*

Spoon Biopsy Forceps with round cup, double action



253-426-100*

Mini Biopsy forceps with oval cup, double action
for use with 0° cystoscope



253-421-100

Grasping Forceps with serrated jaws, double action



253-431-100*

Biopsy forceps with large oval cup, double action
for use with 30° cystoscope



253-422-100

Biopsy Punch Forceps, thru-cutting, double action



253-425-100

Biopsy forceps with mini oval cup, double action
for use with 4mm, 70° cystoscope



253-423-100

Scissors, hook type blades, double action



253-427-100*

Stent Grasping forceps with serrated jaws, double action
for removal of stents



253-429-100* Adapter for use of optical forceps with resectoscope sheaths

ADAPTORS & VALVES



300-011-181* Luer-Lock tube connector, 9mm



300-011-506* Luer-Lock tube connector, 6mm



300-011-184* Luer-Lock Tuohy Borst Adapter



300-011-178 Luer-Lock one-way stop-cock with spring screw cap



300-011-179* Luer-Lock tube connector with stopcock



300-011-515* Luer-Lock one-way stopcock



351-905-110 Silicone Valve, reusable, for instruments up to \varnothing 1.8mm (5.5Charr.), with LL-Connection, 10pcs. per package



301-701-100* Grey Rubber cap for use on all working channels



351-905-105 Disposable Silicone Valve with Luer-Lock connection for use with 3 - 10 Charr. instruments, package with 10 pieces, sterile packed



300-400-900* Rubber Seal for Luer-Lock connectors

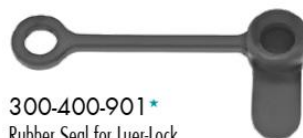

300-400-901* Rubber Seal for Luer-Lock connectors

HIGH FREQUENCY CABLES for RZ resectoscope systems, 4.5m length



- 253-610-001* with 5 mm plug for Erbe HF-unit
- 253-610-002* with 4 mm plug for Martin HF-unit
- 253-610-003* with 8 mm plug for Valleylab HF-unit
- 253-610-004* with 4 mm plug for older HF-units
- 700-501-453* SDS plug

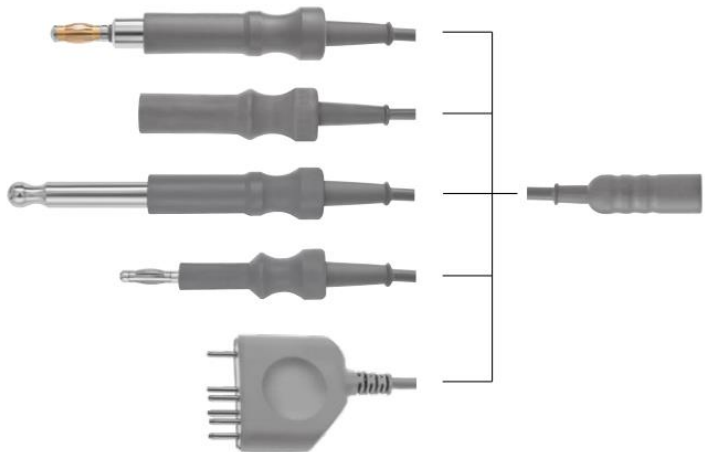

- 253-400-601 for Erbe HF-unit
- 253-400-602 for Martin HF-unit
- 700-500-453 SDS plug
- 253-400-606** for BOWA

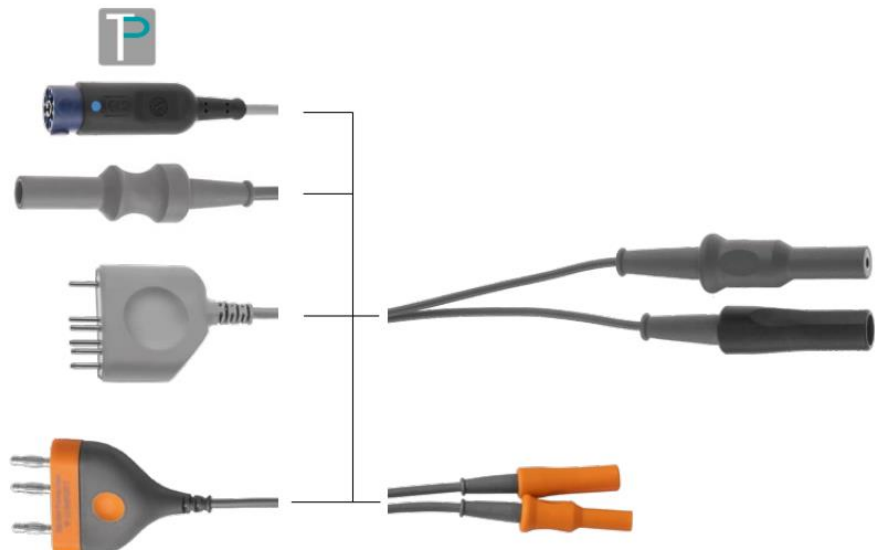

LASER ENUCLEATION SETS FRONT FIRE

HoLEP / ThuLEP / Overview

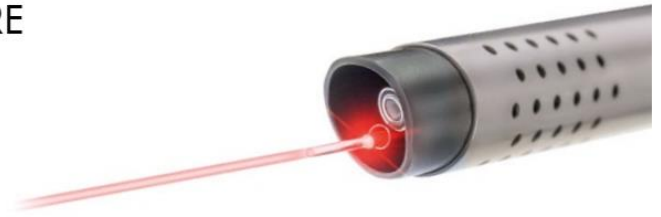

24
CHARR.

22
CHARR.

18.5
CHARR.

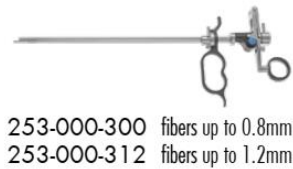
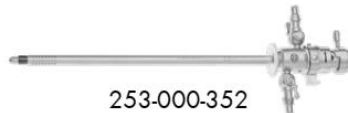
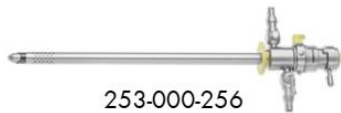
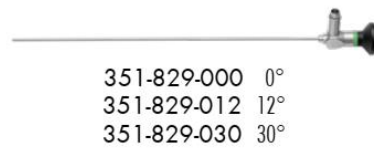
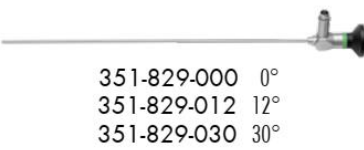
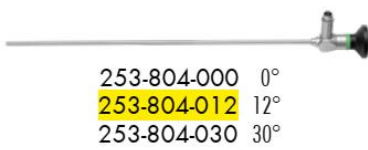

24
CHARR.

HoLEP Set

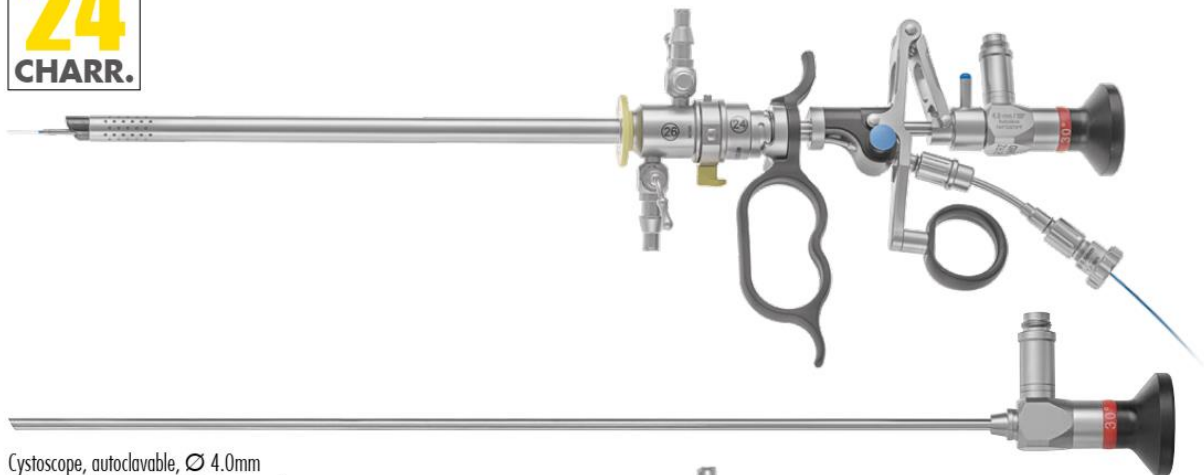

Cystoscope, autoclavable, Ø 4.0mm
 253-804-030 30° direction of view
 253-804-012 12° direction of view

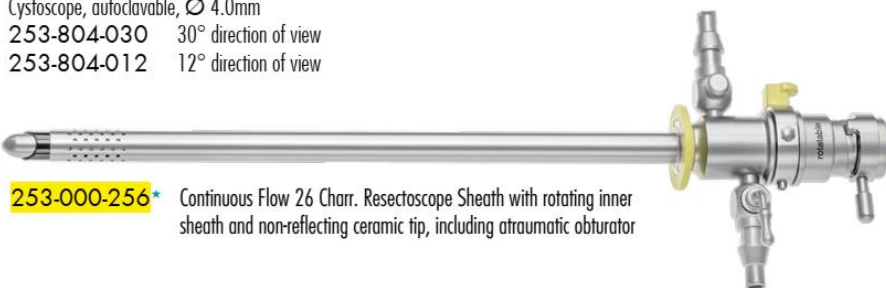

253-000-256* Continuous Flow 26 Charr. Resectoscope Sheath with rotating inner sheath and non-reflecting ceramic tip, including atraumatic obturator



253-000-266 Inner shaft, 24Charr., with oblique ceramic tip for 253-000-256

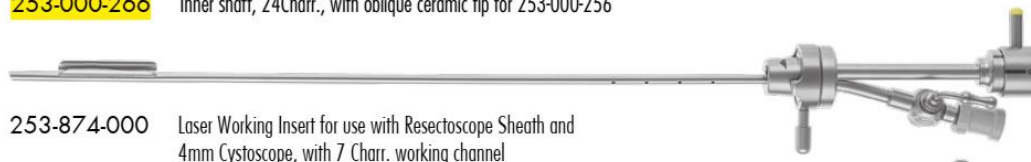

253-874-000 Laser Working Insert for use with Resectoscope Sheath and 4mm Cystoscope, with 7 Charr. working channel

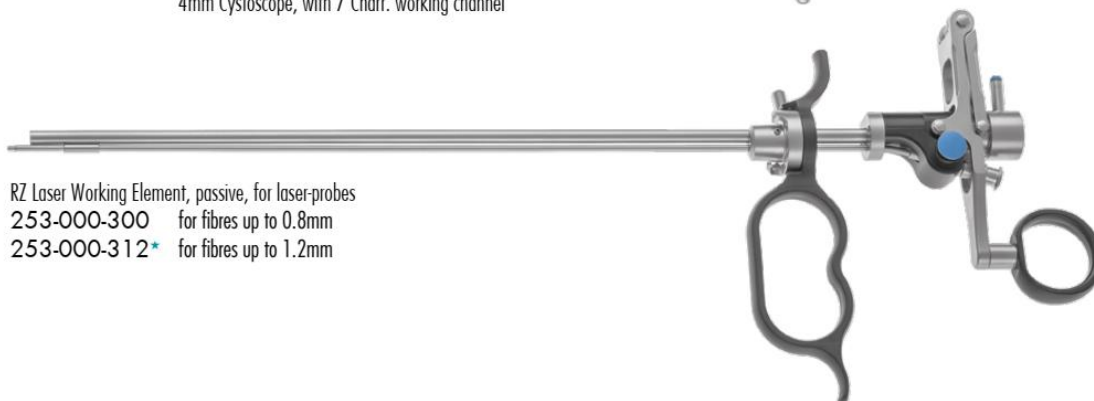

RZ Laser Working Element, passive, for laser-probes
 253-000-300 for fibres up to 0.8mm
 253-000-312* for fibres up to 1.2mm



300-011-184* Luer-Lock Tuohy Borst Adapter (Ø 0.6 - 1.4mm)



RZ LL-Connection, rotatable for use with Laser Probe
 253-000-301* short
 253-000-302 long



Working elements suitable for HYBRID 24 Charr. system with bipolar and monopolar cable connection

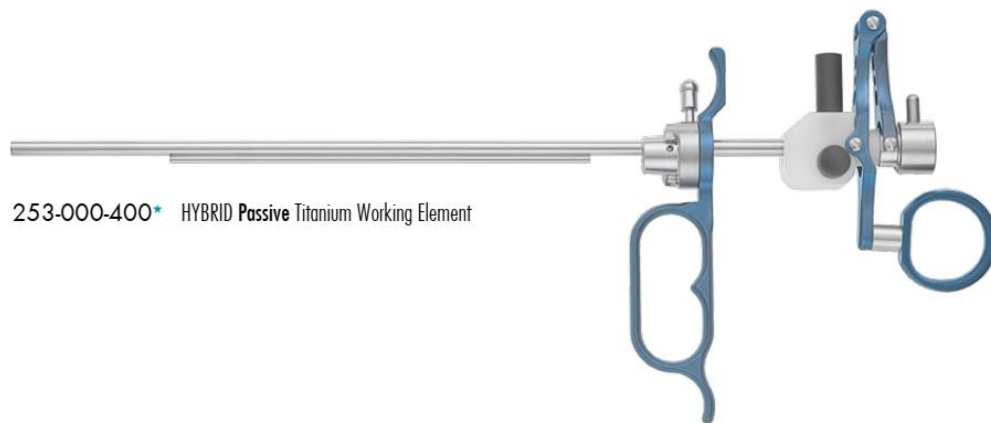

253-000-400* HYBRID Passive Titanium Working Element

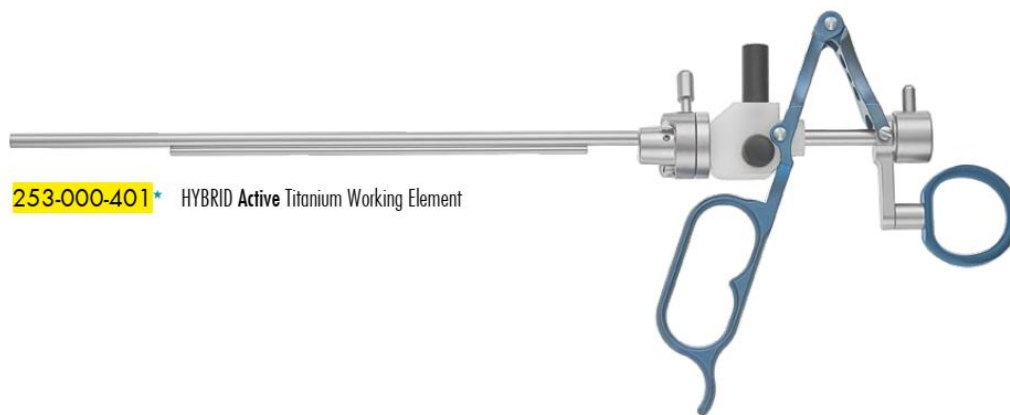

253-000-401* HYBRID Active Titanium Working Element



HYBRID
HYBRID



HYBRID Electrodes, to be used with 24 Charr. system

- works in bipolar and monopolar mode
- made of a standard wire of \varnothing 0.35mm



Cutting Loop, angled, for 12°/30° telescope

253-400-200



Cutting Loop, angled, for 12°/30° telescope

253-400-201*



Cutting Loop, thick wire, angled, for 12°/30° telescope

253-400-202



Collins Coagulation Electrode, pointed

253-400-203*



Coagulation Electrode, conical

253-400-204



Coagulation Electrode, ball shape, \varnothing 3mm

253-400-205*



Roller-Electrode, \varnothing 3mm

253-400-211



Cutting Loop, 90° angled, for 0° telescope

253-400-222



Coagulation Electrode, ball shape, \varnothing 5mm

253-400-206

RZ FAN RETRACTORS

- One-piece instrument with flush port
- 50° vertical adjustment
- Available in Ø 5mm and 10mm

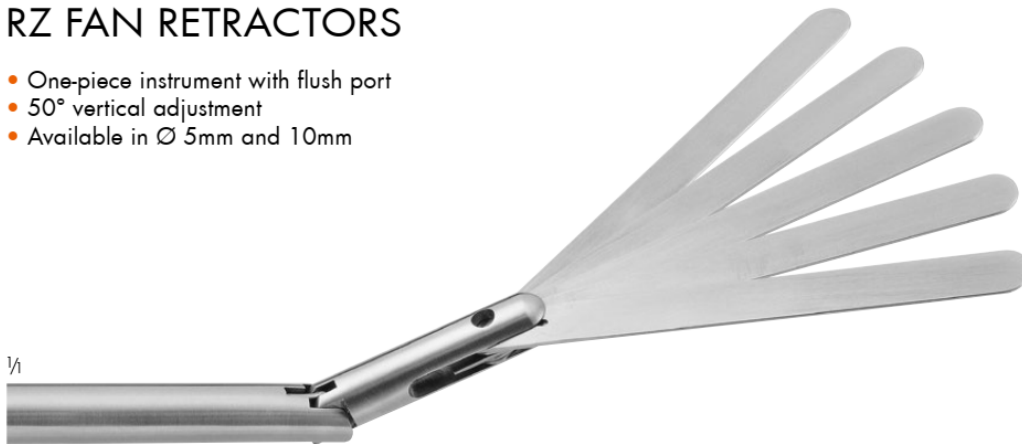

RZ Fan Retractor, 330mm working length

300-065-000* 10 mm, with 5 prongs

300-063-000* 5 mm, with 3 prongs



Esophagus Retractor with cleaning port, vertical up 90°, with distal hole

300-099-033 5 mm, 330 mm working length

300-099-100 5 mm, 440 mm working length

300-099-133 10 mm, 330 mm working length

300-099-140 10 mm, 440 mm working length



300-065-100 Advanced Fan Retractor, 10 mm, 5 prongs,
angulation: max. 80°, spread: max. 60°, length: 330 mm

HANDLE ELECTRODES

∅ 5mm, 360mm / 450mm working length

- Large and ergonomic handle design
- Very fine tips
- Ceramic tip and PEEK shaft
- Suction connection optionally available



Without suction



With suction

	Spatula Electrode	300-144-002*	300-145-003*
		360mm	360mm
	J-hook Electrode	300-144-004	300-145-004*
		360mm	360mm
	L-hook Electrode	300-144-452	300-145-453
		450mm	450mm
	L-hook Electrode	300-144-005*	300-145-005*
		360mm	360mm
	Needle Electrode	300-144-454	300-145-454
		450mm	450mm
	Needle Electrode	300-144-006*	300-145-006*
		360mm	360mm
	Needle Electrode	300-144-456	300-145-456
		450mm	450mm



Metzenbaum Scissors
straight, short blade: 12mm, double action

300-403-069 330mm
300-404-069 250mm



Hook Scissors
round cutting blade, single action

300-403-060 330mm
300-404-060 250mm



Biopsy Cup Forceps
sharp, oval cups, double action

300-403-082 330mm
300-404-082 250mm



Maryland Dissecting Forceps
gently curved, double action

300-403-732 330mm
300-404-732 250mm



Mixer Dissecting Forceps
90° angled, fine serrated jaws, double action

300-403-738 330mm
300-404-738 250mm



Fundus Grasping Forceps
2 cups, serrated, double action

300-403-015 330mm
300-404-015 250mm



DeBakey Grasping Forceps
25mm long, atraumatic, double action

300-403-244 330mm
300-404-244 250mm



Johans Grasping Forceps
20mm long, fenestrated, single action

300-403-284 330mm
300-404-284 250mm



Johans Grasping Forceps
20mm long, fenestrated, double action

300-403-289 330mm
300-404-289 250mm



PEEK Polymer Laparoscopic Handle, for modular instrument inserts, gold plated HF-connection, rotatable

Without ratchet

300-750-101



PEEK Polymer Laparoscopic Handle, for modular instrument inserts, gold plated HF-connection, rotatable

With ratchet

300-750-103



PEEK Polymer Laparoscopic Handle, for modular instrument inserts, gold plated HF-connection, rotatable

With hook up ratchet

300-750-105



PEEK Polymer Laparoscopic Handle, for modular instrument inserts, gold plated HF-connection, rotatable

With swing ratchet

300-750-106

For use with a monopolar cable (see page 76).

3.5mm LAPAROSCOPIC INSTRUMENTS

- Stronger 3-piece detachable instruments, less invasive & scarless surgery
- Very simple cleaning, assembling and disassembling
- 3.5mm mini instruments designed for pediatric (250mm) and mini Laparoscopy use



300-750-101*
PEEK Polymer Handle with
HF - connection



300-750-103*
PEEK Polymer Handle with ratchet
and HF - connection



Outer Sheath, insulated, adaptable to all handles
300-660-035 330mm
 300-550-035 250mm

1-PIECE NEEDLE HOLDER

- Extremely light
- Aluminium anodized handle



Lightweight design with satin black surface



65° LuerLock flushing port for optimal accessibility

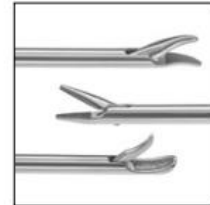

5 different jaw designs available



Rubber sealing cap included



6-tooth ratchet for always optimal positioning, with overload protection



Straight



Left curved



Right curved



1x2 teeth



Concave/convex



Ø 5mm STRAIGHT HANDLE

300-300-130*	straight	TC serrated	330mm
300-300-131	straight, 1x2 teeth	TC serrated	330mm
300-300-140*	left curved	TC serrated	330mm
300-300-141 *	right curved	TC serrated	330mm
300-300-142*	concave/convex	diamond dusted	330mm
300-300-230	straight	TC serrated	450mm
300-300-231	straight, 1x2 teeth	TC serrated	450mm
300-300-240	left curved	TC serrated	450mm
300-300-241	right curved	TC serrated	450mm
300-300-242	concave/convex	diamond dusted	450mm

Ø 5mm ANGLED HANDLE

300-300-160*	straight	TC serrated	330mm
300-300-161	straight, 1x2 teeth	TC serrated	330mm
300-300-170*	left curved	TC serrated	330mm
300-300-171 *	right curved	TC serrated	330mm
300-300-172*	concave/convex	diamond dusted	330mm
300-300-260	straight	TC serrated	450mm
300-300-261	straight, 1x2 teeth	TC serrated	450mm
300-300-270	left curved	TC serrated	450mm
300-300-271	right curved	TC serrated	450mm
300-300-272	concave/convex	diamond dusted	450mm

Ø 3mm STRAIGHT HANDLE

300-300-330	straight	TC serrated	330mm
300-300-340	left curved	TC serrated	330mm
300-300-341	right curved	TC serrated	330mm
300-300-430	straight	TC serrated	450mm
300-300-440	left curved	TC serrated	450mm
300-300-441	right curved	TC serrated	450mm

Ø 3mm ANGLED HANDLE

300-300-360	straight	TC serrated	330mm
300-300-370	left curved	TC serrated	330mm
300-300-371	right curved	TC serrated	330mm
300-300-460	straight	TC serrated	450mm
300-300-470	left curved	TC serrated	450mm
300-300-471	right curved	TC serrated	450mm

HANDLE ELECTRODES

∅ 5mm, 360mm / 450mm working length

- Large and ergonomic handle design
- Very fine tips
- Ceramic tip and PEEK shaft
- Suction connection optionally available





Without suction

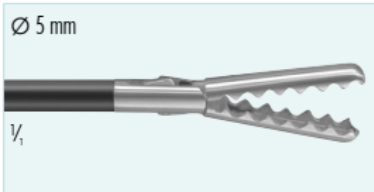

With suction

		Without suction	With suction
	Spatula Electrode	300-144-002* 360mm	300-145-003* 360mm
		300-144-452 450mm	300-145-453 450mm
	J-hook Electrode	300-144-004 360mm	300-145-004* 360mm
		300-144-454 450mm	300-145-454 450mm
	L-hook Electrode	300-144-005* 360mm	300-145-005* 360mm
		300-144-455 450mm	300-145-455 450mm
	Needle Electrode	300-144-006* 360mm	300-145-006* 360mm
		300-144-456 450mm	300-145-456 450mm

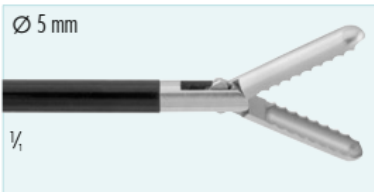
	insert only	Complete Instrument with handle 300-750-003	Complete Instrument with handle 300-750-103	Complete Instrument with handle 300-750-105
 <p>Ø 5 mm 1/1</p>	300-400-013*	300-430-013	300-440-013*	300-460-013*
PRESTIGE Atraumatic grasping forceps with long, wave shaped jaws and deep cup with lateral serration, double action, Ø 5 mm, 330 mm				
 <p>Ø 5 mm 1/1</p>	300-400-033*	300-430-033	300-440-033*	300-460-033*
PRESTIGE Grasping Forceps, wave-shaped lateral serration, and deep cup, single action, atraumatic, Ø 5 mm, 330 mm				
 <p>Ø 5 mm 1/1</p>	300-400-053	300-430-053	300-440-053	300-460-053
ALLIGATOR Grasping forceps with fine sharp lateral teeth and deep cup, double action, Ø 5 mm, 330 mm				

NON-DETACHABLE PRESTIGE FORCEPS

Complete Instrument, rotating, insulated, with prestige handle and Luer-Lock connection, 330mm working length

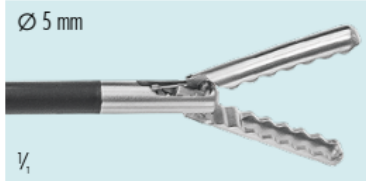
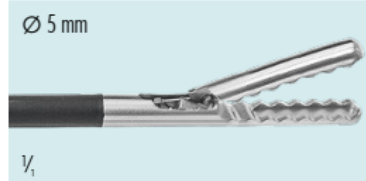
	 <p>Ø 5 mm 1/1</p>	 <p>Ø 5 mm 1/1</p>
	300-111-013 Double action jaws	300-111-033 Single action jaws

3.5mm LAPAROSCOPIC INSTRUMENTS

- Stronger 3-piece detachable instruments, less invasive & scarless surgery
- Very simple cleaning, assembling and disassembling
- 3.5mm mini instruments designed for pediatric (250mm) and mini Laparoscopy use



300-750-101*
PEEK Polymer Handle with
HF - connection



300-750-103*
PEEK Polymer Handle with ratchet
and HF - connection



Outer Sheath, insulated, adaptable to all handles
300-660-035 330mm
 300-550-035 250mm



Metzenbaum Scissors
straight, short blade: 12mm, double action

300-403-069 330mm
300-404-069 250mm



Hook Scissors
round cutting blade, single action

300-403-060 330mm
300-404-060 250mm



Biopsy Cup Forceps
sharp, oval cups, double action

300-403-082 330mm
300-404-082 250mm



Maryland Dissecting Forceps
gently curved, double action

300-403-732 330mm
300-404-732 250mm



Mixer Dissecting Forceps
90° angled, fine serrated jaws, double action

300-403-738 330mm
300-404-738 250mm



Fundus Grasping Forceps
2 cups, serrated, double action

300-403-015 330mm
300-404-015 250mm



DeBakey Grasping Forceps
25mm long, atraumatic, double action

300-403-244 330mm
300-404-244 250mm



Johans Grasping Forceps
20mm long, fenestrated, single action

300-403-284 330mm
300-404-284 250mm



Johans Grasping Forceps
20mm long, fenestrated, double action

300-403-289 330mm
300-404-289 250mm

COAGULATION ELECTRODES

with 4mm HF connector, Ø 5mm, 330mm working length



J-hook Electrode 300-100-132



L-hook Electrode 300-100-133*



Spatula Electrode **300-100-131***



Ballpoint Electrode **300-100-134**



SUCTION-IRRIGATION ELECTRODES

with 4mm HF connector, one piston and LuerLock connector, Ø 5mm, 330mm working length



J-hook Electrode 300-163-111



L-hook Electrode 300-163-121











Spatula Electrode 300-163-131

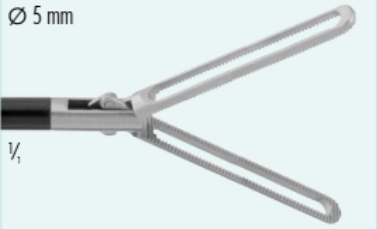

Ballpoint Electrode 300-163-141

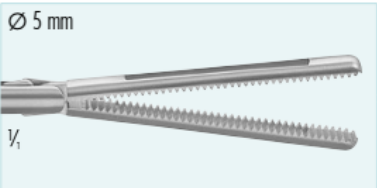

 <p>Ø 5 mm 1/1</p>	insert only	 Complete Instrument with handle 300-750-003	 Complete Instrument with handle 300-750-103	 Complete Instrument with handle 300-750-105
	300-400-289*	300-430-289	300-440-289*	300-470-289*
 <p>Ø 5 mm 1/1</p>	300-400-291*	300-430-291	300-440-291*	300-470-291*
 <p>Ø 5 mm 1/1</p>	300-400-285*	300-430-285	300-440-285*	300-470-285*
 <p>Ø 5 mm 1/1</p>	300-400-287	300-430-287	300-440-287	300-470-287
 <p>Ø 5 mm 1/1</p>	300-400-288	300-430-288	300-440-288	300-470-288

JOHANS

Grasping forceps with 20 mm fenestrated jaws, double action, Ø 5 mm, 330 mm

LONG JOHANS

Grasping forceps with 40 mm fenestrated jaws, double action, Ø 5 mm, 330 mm

DORSEY

Grasping forceps with 12 mm fenestrated jaws, double action, Ø 5 mm, 330 mm

LONG DORSEY

Grasping forceps with 45 mm fenestrated jaws, double action, Ø 5 mm, 330 mm

LONG JOHANS

Grasping forceps with 40 mm fenestrated jaws, single action, Ø 5 mm, 330 mm



253-900-155* Amplatz Metal Dilator set containing 6 Dilators (9, 12, 15, 18, 21, 24 Charr.)
2 flexible and 2 rigid guide rods for use with guide wires



Amplatz Metal Dilator
253-900-156* 27 Charr.
253-900-157* 30 Charr.



253-900-201* Puncture Cannula with inner and outer cannula



253-900-202* Dilation Cannula, 3mm \varnothing with inner and outer cannula



253-900-200 Sterile disposable Guide wire, J-tip, flexible, 150cm length

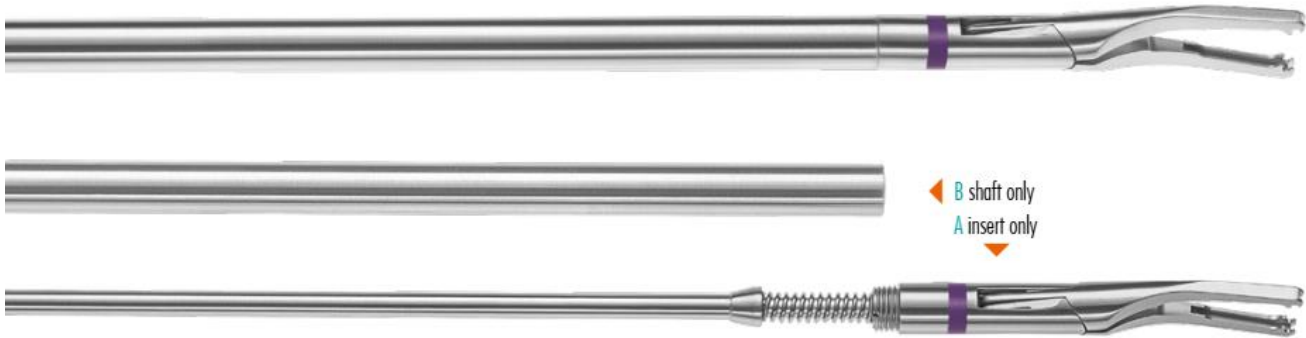

Ø 5mm SHAFT

Size / color code	non-detachable, 330mm	non-detachable, 450mm
M (blue) ■	300-820-051	300-820-451
M/L (green) ■	300-820-052*	300-820-452*

Ø 10mm SHAFT

Size / color code	non-detachable, 330mm	non-detachable, 450mm
L (purple) ■	300-820-013*	300-820-413*
XL (yellow) ■	300-820-014*	300-820-414*

Polymer Clips
Applying Forceps



Detachable Forceps
without LuerLock

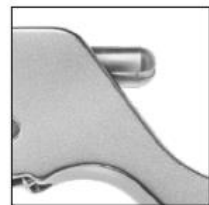

Non-detachable Forceps
with LuerLock



PEDIATRIC TROCAR SYSTEM

- 100mm working length
- Ø 5.5mm



MultiPort Trocar System



SiliPort Trocar System



- 1** Stainless steel sleeve, smooth
- 2** Stainless steel sleeve, thread
- 3** Stainless steel sleeve, oblique
- 4** Synthetic sleeve, smooth
- 5** Synthetic sleeve, thread

MultiPort Trocar System

300-220-055*
300-221-055
300-222-055*
300-223-055
300-224-055

Siliport Trocar System

300-230-055
300-231-055
300-232-055
300-233-055
300-234-055



300-112-035 Stainless steel trocar with smooth sleeve,
70mm working length, Ø 3.5mm

Siliport Trocar Sleeves, 100mm working length

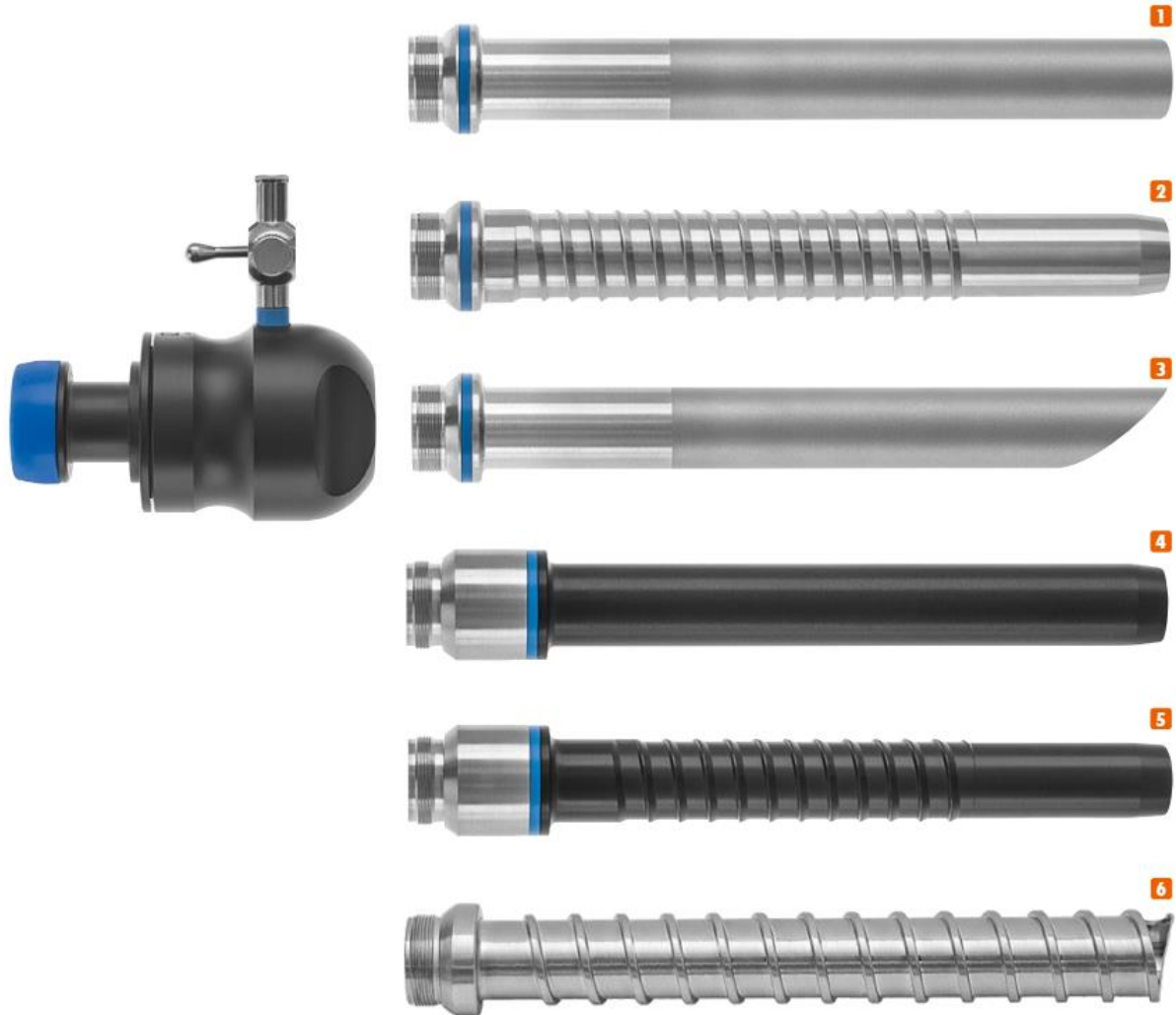

- 1** Stainless steel sleeve, smooth
- 2** Stainless steel sleeve, thread
- 3** Stainless steel sleeve, oblique
- 4** Synthetic sleeve, smooth
- 5** Synthetic sleeve, thread
- 6** Stainless Steel Sleeve, self-cutting

	Ø 5.5mm	Ø 11mm	Ø 13mm
1	300-230-055	300-230-011	300-230-013
2	300-231-055	300-231-011	300-231-013
3	300-232-055	300-232-011	300-232-013
4	300-233-055	300-233-011	300-233-013
5	300-234-055	300-234-011	300-234-013
6	300-236-055	300-236-011	300-236-013

LAPAROSCOPY

Reducer Systems



Reducer clip with silicone band
for all RZ trocar systems
300-021-011* Ø 11mm → 5.5 mm
300-021-125 Ø 12.5mm → 5.5 mm



Reducer clip with silicone band for
all RZ trocar systems
300-021-355* Ø 11mm → 5.5 mm
300-021-380 Ø 11mm → 8.0 mm
300-021-305 Ø 13mm → 5.5 mm
300-021-310 Ø 13mm → 10.0 mm



Slide-reducer for all RZ Trocar Systems
300-021-455 Ø 11mm → 5.5 mm
300-021-405 Ø 13mm → 5.5 mm
300-021-410 Ø 13mm → 10.0 mm



Reducer Sleeve short, for all RZ modular trocar systems, 60mm
300-012-106 Ø 10mm → 5.0 mm
300-012-116 Ø 11mm → 5.5 mm
300-012-121 Ø 12.5mm → 5.5 mm



Reducer Sleeve long, for all RZ modular trocar systems, 190mm
300-012-405* Ø 5.0mm → 4.0mm (red)*
300-012-455* Ø 10.0/11.0mm → 5.5mm (red)
300-012-410 Ø 12.5mm → 10.0mm (blue)
300-012-412 Ø 12.5mm → 5.5mm (red)
300-012-415 Ø 15.0mm → 10.0mm (blue)
300-012-416 Ø 15.0mm → 5.5mm (red)
300-012-425 Ø 20.0mm → 15.0mm (grey)
300-012-420 Ø 20.0mm → 10.0mm (blue)
300-012-421 Ø 20.0mm → 5.5mm (red)

* 175mm



300-023-100 Endo Dilator Speculum, 195mm, with 3 blades,
for symmetric dilation of the tissue during heavy tissue removal



300-098-105 Tissue retractor, S-shaped, pair with 2 pieces
to expose anatomical layers



Insufflation needle, matt chrome, Ø 2 mm

300-195-080	80 mm
300-195-100	100 mm*
300-195-120*	120 mm*
300-195-150	150 mm*
300-195-170	170 mm
300-195-200	200 mm

* standard length

Insufflation needle, polished chrome, Ø 2.7 mm, High-Flow

300-195-300	100 mm
300-195-320	120 mm*
300-195-350	150 mm*
300-195-370	170 mm*

Suction and irrigation tubes, for 300-165-100, 300-166-100 and 300-167-100



4 holes on the tip, with markings, 340mm working length

- 1 300-172-003 Ø 3mm
- 2 300-172-005* Ø 5mm
- 3 300-172-010* Ø 10mm



4x4 holes, with markings, 340mm working length

- 1 300-173-003 Ø 3mm
- 2 300-173-005* Ø 5mm
- 3 300-173-010* Ø 10mm



300-165-100 Suction and irrigation handle with 2 trumpet valves. Suction channel with large universal tube connector, irrigation channel with lateral LuerLock connection. Removable ergonomic handle plate for easy cleaning and maintenance.



300-166-100* Pistol-shaped suction and irrigation handle with 2-way valve and 2 big universal tube connectors for suction and irrigation. Ergonomic handle design for optimal operating convenience.



Suction and irrigation cannula with 4 holes, Ø 3 mm
300-172-003 340 mm working length
300-172-253 250 mm working length



Suction and irrigation cannula with 16 holes, Ø 3 mm
300-173-003 340 mm working length
300-173-253 250 mm working length





300-165-100 Suction and irrigation handle with 2 trumpet valves. Suction channel with large universal tube connector, irrigation channel with lateral LuerLock connection. Removable ergonomic handle plate for easy cleaning and maintenance.



300-167-100 Suction and irrigation handle with 1 trumpet valve and large universal tube adapter. To control suction or irrigation.



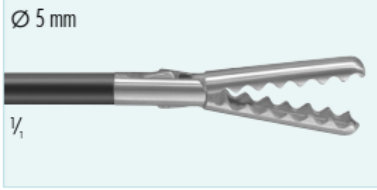

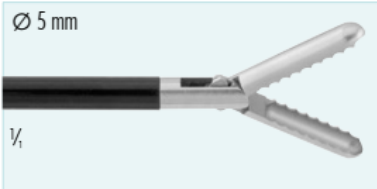

300-166-100* Pistol-shaped suction and irrigation handle with 2-way valve and 2 large universal tube connectors for suction and irrigation.

	insert only	Complete Instrument with handle 300-750-003	Complete Instrument with handle 300-750-103	Complete Instrument with handle 300-750-105
 <p>Ø 5 mm 1/1</p>	300-400-013*	300-430-013	300-440-013*	300-460-013*
PRESTIGE Atraumatic grasping forceps with long, wave shaped jaws and deep cup with lateral serration, double action, Ø 5 mm, 330 mm				
 <p>Ø 5 mm 1/1</p>	300-400-033*	300-430-033	300-440-033*	300-460-033*
PRESTIGE Grasping Forceps, wave-shaped lateral serration, and deep cup, single action, atraumatic, Ø 5 mm, 330 mm				
 <p>Ø 5 mm 1/1</p>	300-400-053	300-430-053	300-440-053	300-460-053
ALLIGATOR Grasping forceps with fine sharp lateral teeth and deep cup, double action, Ø 5 mm, 330 mm				

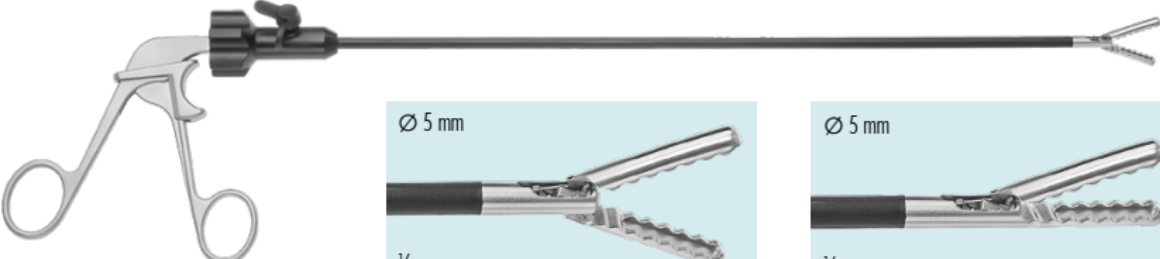
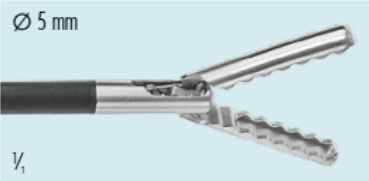
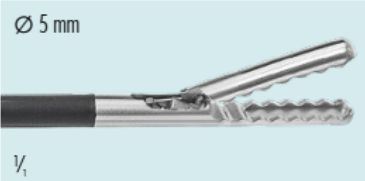
NON-DETACHABLE PRESTIGE FORCEPS

Complete Instrument, rotating, insulated, with prestige handle and Luer-Lock connection, 330mm working length

	 <p>Ø 5 mm 1/1</p>	 <p>Ø 5 mm 1/1</p>
	300-111-013 Double action jaws	300-111-033 Single action jaws

	insert only	Complete Instrument with handle 300-750-003	Complete Instrument with handle 300-750-103	Complete Instrument with handle 300-750-105
 <p>∅ 5 mm 1/1</p>	300-400-284*	300-430-284	300-440-284*	300-470-284*
JOHANS Grasping forceps with 20 mm fenestrated jaws, single action, ∅ 5 mm, 330 mm				
 <p>∅ 5 mm 1/1</p>	300-400-310*	300-430-310	300-440-310*	300-470-310*
	300-400-312**	300-430-312*	300-440-312**	300-470-312**
MARQUES Grasping forceps with 2 fenestrations, single action, ∅ 5 mm, 330 mm * with 3 fenestrations				
 <p>∅ 5 mm 1/1</p>	300-400-314*	300-430-314	300-440-314*	300-470-314*
MARQUES Grasping forceps with 2 fenestrations, bent up, single action, ∅ 5 mm, 330 mm				
 <p>∅ 5 mm 1/1</p>	300-400-311	300-430-311	300-440-311	300-470-311
	300-400-313*	300-430-313*	300-440-313*	300-470-313*
MARQUES Grasping forceps with 2 fenestrations, double action, ∅ 5 mm, 330 mm * with 3 fenestrations				
 <p>∅ 5 mm 1/1</p>	300-400-052*	300-430-052	300-440-052*	300-470-052*
GRASPER Atraumatic Grasping forceps with fenestrated jaws, fine serrations, double action, ∅ 5 mm, 330 mm				

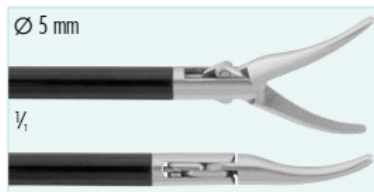

Ø 5 mm

1/1

Catalogue-No. for insert only

300-400-732*



Complete Instrument
with handle 300-750-001

300-410-732



Complete Instrument
with handle 300-750-101

300-420-732*

KELLY

Dissecting forceps curved, slightly tapered, cross-serrated jaws, wide opening, double action, Ø 5 mm, 330 mm



Ø 5 mm

1/1

300-400-733

300-410-733

300-420-733

BABY KELLY

Short dissecting and suturing forceps, curved, tapered, cross-serrated jaws, wide opening, double action, Ø 5 mm, 330 mm

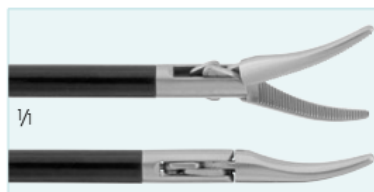

1/1

300-400-731*

300-410-731

300-420-731*

MARYLAND

Extra fine dissector with slightly tapered tip and gently curved for precise dissection, Ø 5 mm, 330 mm



Ø 5 mm

1/1

300-400-738*

300-410-738

300-420-738*

MIXTER

Fine dissecting forceps, 90° angled, fine serrated jaws, double action, Ø 5 mm, 330 mm

HANDLE ELECTRODES

∅ 5mm, 360mm / 450mm working length

- Large and ergonomic handle design
- Very fine tips
- Ceramic tip and PEEK shaft
- Suction connection optionally available



Without suction





With suction

		Without suction	With suction
	Spatula Electrode	300-144-002* 360mm	300-145-003* 360mm
		300-144-452 450mm	300-145-453 450mm
	J-hook Electrode	300-144-004 360mm	300-145-004* 360mm
		300-144-454 450mm	300-145-454 450mm
	L-hook Electrode	300-144-005* 360mm	300-145-005* 360mm
		300-144-455 450mm	300-145-455 450mm
	Needle Electrode	300-144-006* 360mm	300-145-006* 360mm
		300-144-456 450mm	300-145-456 450mm

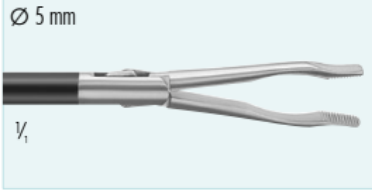

LAPAROSCOPY

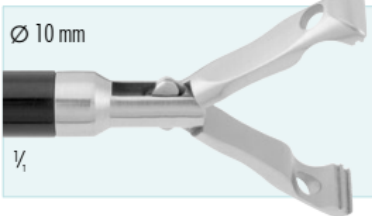
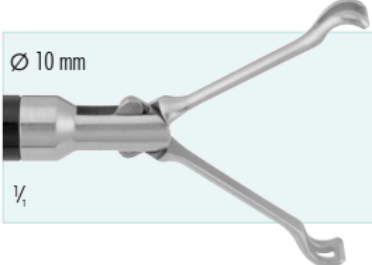
Grasping Forceps





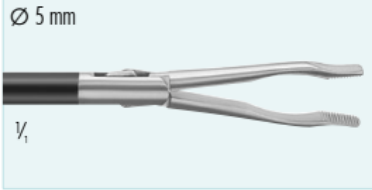

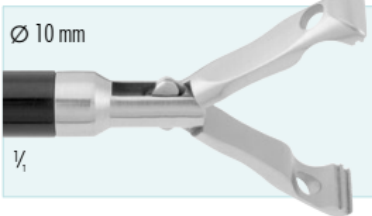
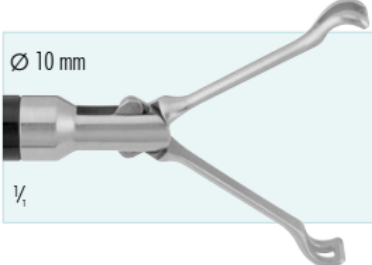
	insert only	Complete Instrument with handle 300-750-003	Complete Instrument with handle 300-750-103	Complete Instrument with handle 300-750-105
 <p>Ø 5 mm 1/4</p> <p>BABCOCK PADDLE Grasping forceps with flat paddles and fine serration for atraumatic grip of delicate tissue, double action, Ø 5 mm, 330 mm</p>	300-400-250	300-430-250	300-440-250	300-470-250
 <p>Ø 5 mm 1/4</p> <p>BABCOCK Traditional style Babcock grasping forceps, rounded jaws with fine serrations, double action, Ø 5 mm, 330 mm</p>	300-400-252*	300-430-252	300-440-252*	300-470-252*
 <p>Ø 10 mm 1/4</p> <p>DEBAKEY BABCOCK Traditional style Babcock grasping forceps, rounded jaws with atraumatic DeBaKey serration, double action, Ø 10 mm, 330 mm</p>	300-400-079	300-430-079	300-440-079	300-470-079
 <p>Ø 10 mm 1/4</p> <p>BABCOCK Traditional style Babcock grasping forceps with medium jaws, rounded jaws with fine serrations, double action, Ø 10 mm, 330 mm</p>	300-400-078*	300-430-078	300-440-078*	300-470-078*

LAPAROSCOPY





Grasping Forceps

	insert only	Complete Instrument with handle 300-750-003	Complete Instrument with handle 300-750-103	Complete Instrument with handle 300-750-105
 <p>Ø 5 mm 1/4</p> <p>BABCOCK PADDLE Grasping forceps with flat paddles and fine serration for atraumatic grip of delicate tissue, double action, Ø 5 mm, 330 mm</p>	300-400-250	300-430-250	300-440-250	300-470-250
 <p>Ø 5 mm 1/4</p> <p>BABCOCK Traditional style Babcock grasping forceps, rounded jaws with fine serrations, double action, Ø 5 mm, 330 mm</p>	300-400-252*	300-430-252	300-440-252*	300-470-252*
 <p>Ø 10 mm 1/4</p> <p>DEBAKEY BABCOCK Traditional style Babcock grasping forceps, rounded jaws with atraumatic DeBaKey serration, double action, Ø 10 mm, 330 mm</p>	300-400-079	300-430-079	300-440-079	300-470-079
 <p>Ø 10 mm 1/4</p> <p>BABCOCK Traditional style Babcock grasping forceps with medium jaws, rounded jaws with fine serrations, double action, Ø 10 mm, 330 mm</p>	300-400-078*	300-430-078	300-440-078*	300-470-078*

MONOPOLAR CABLES

Generator end		4mm socket	4mm socket, ang.	2mm plug	4mm plug	3mm socket	4mm hexagon	4mm plug
	3 m	700-501-303						
	5 m	700-501-503						
	3 m	700-501-300						
	5 m	700-501-500						
	3 m	700-280-030	700-290-030	700-291-030		700-292-030	700-293-030	700-293-033
	5 m	700-280-050	700-290-050	700-291-050				700-293-035
	3 m	700-360-031	700-361-030	700-362-030	700-363-030	700-364-030		700-370-030
	5 m	700-360-051	700-361-050	700-362-050	700-363-050			700-370-050
	3 m	700-285-030		700-286-030	700-286-130			700-286-230
	5 m	700-285-050		700-286-050				
	3 m	700-101-030	700-102-030	700-103-030			700-105-030	
	5 m	700-101-050		700-103-050		700-104-050		

BIPOLAR CABLES

Generator end		Flat Plug	Flat plug, angled	Flat plug, square	2-pin plug	2-pin plug, angled	2-pin plug, angled
	3 m	700-350-030	300-860-100	700-350-130	700-351-030	700-345-403	700-345-003
	5 m	700-350-050	300-860-111	700-350-150	700-351-050	700-345-405	700-345-005
	3 m	700-101-001	700-100-130	700-101-130	700-100-102	700-101-230	
	5 m	700-100-101	700-100-150	700-101-150	700-100-103	700-101-250	
	3 m	700-287-030	700-200-130	700-287-130	700-200-132	700-287-230	
	5 m	700-287-050	700-200-150	700-287-150	700-200-152	700-287-250	
	3 m	700-351-031	700-300-003	700-351-131	700-300-203	700-351-231	700-300-403
	5 m	700-351-051	700-300-005	700-351-151	700-300-205	700-351-251	700-300-405
	3 m	700-500-300					
	5 m	700-500-500					

* Not for sale within Europe

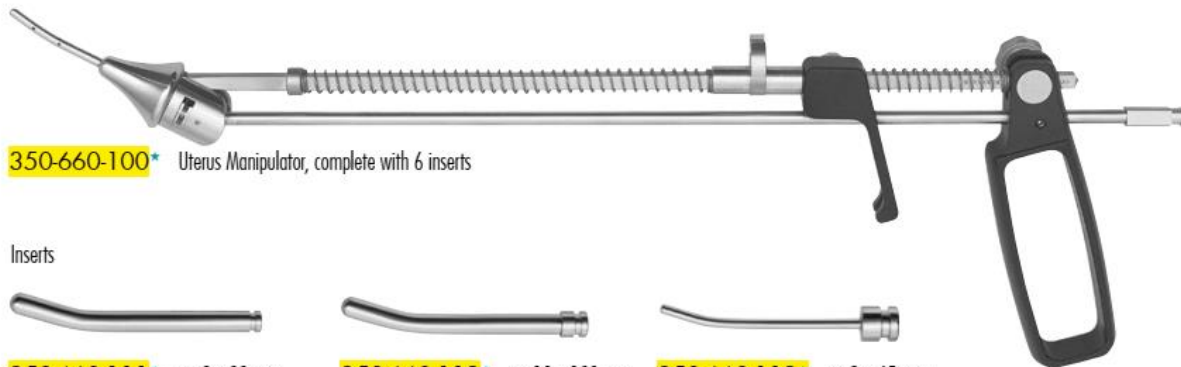

350-660-100* Uterus Manipulator, complete with 6 inserts

Inserts



350-660-111* Ø 8 x 80 mm



350-660-112* Ø 10 x 100 mm



350-660-113* Ø 3 x 45 mm



350-660-114* Ø 3 x 55 mm



350-660-115* Ø 3.2 x 35 mm



350-660-116* Ø 3.2 x 45 mm



COHEN

Self retaining Cannula complete with 2 interchangeable acorns
350-750-000*

Acorn only

350-750-002 large

350-750-001 small



350-400-250* **SCHROEDER** tenaculum forceps



Myoma screw

300-032-015* Ø 5mm, 330mm working length

300-042-005 Ø 5mm, 420mm working length

300-033-010 Ø 10mm, 330mm working length

300-042-010 Ø 10mm, 420mm working length

HIGH TEMPERATURE LED/XENON LIGHT CABLES



250-042-000
RZ/Storz/Olympus



250-040-000
Wolf



250-041-000
ACMI/British Standard

XENON/LED Light Guide Cables
with melt and bending protection

250-025-230 ∅ 2.5 mm, 2300 mm

250-025-300 ∅ 2.5 mm, 3000 mm

250-035-180 ∅ 3.5 mm, 1800 mm

250-035-230 ∅ 3.5 mm, 2300 mm

250-035-300 ∅ 3.5 mm, 3000 mm

250-048-180 ∅ 4.8 mm, 1800 mm

250-048-230 ∅ 4.8 mm, 2300 mm

250-048-300 ∅ 4.8 mm, 3000 mm



250-039-000
RZ/Storz



250-038-000
ACMI/CUDA



250-048-000
Luxtac



250-051-000
Stryker



250-037-000
Wolf



250-044-000
Olympus



250-045-000
Olympus - Standard



250-052-000
Heine



250-059-000
Pentax



COMPATIBILITY NOTE:
A fiber optic cable with a large diameter should not be connected to a smaller diameter scope.
For example: ∅ 4.8mm fiber optic cables connected to a ∅ 2.9mm may risk high temperature at the light entry of the endoscope and may risk patient safety.

1-PIECE NEEDLE HOLDER

- Extremely light
- Aluminium anodized handle



Lightweight design with satin black surface



65° LuerLock flushing port for optimal accessibility

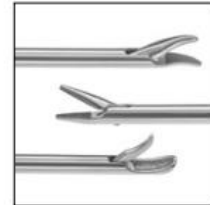

5 different jaw designs available



Rubber sealing cap included



6-tooth ratchet for always optimal positioning, with overload protection



Straight



Left curved



Right curved



1x2 teeth



Concave/convex



Ø 5mm STRAIGHT HANDLE

300-300-130*	straight	TC serrated	330mm
300-300-131	straight, 1x2 teeth	TC serrated	330mm
300-300-140*	left curved	TC serrated	330mm
300-300-141 *	right curved	TC serrated	330mm
300-300-142*	concave/convex	diamond dusted	330mm
300-300-230	straight	TC serrated	450mm
300-300-231	straight, 1x2 teeth	TC serrated	450mm
300-300-240	left curved	TC serrated	450mm
300-300-241	right curved	TC serrated	450mm
300-300-242	concave/convex	diamond dusted	450mm

Ø 5mm ANGLED HANDLE

300-300-160*	straight	TC serrated	330mm
300-300-161	straight, 1x2 teeth	TC serrated	330mm
300-300-170*	left curved	TC serrated	330mm
300-300-171 *	right curved	TC serrated	330mm
300-300-172*	concave/convex	diamond dusted	330mm
300-300-260	straight	TC serrated	450mm
300-300-261	straight, 1x2 teeth	TC serrated	450mm
300-300-270	left curved	TC serrated	450mm
300-300-271	right curved	TC serrated	450mm
300-300-272	concave/convex	diamond dusted	450mm

Ø 3mm STRAIGHT HANDLE

300-300-330	straight	TC serrated	330mm
300-300-340	left curved	TC serrated	330mm
300-300-341	right curved	TC serrated	330mm
300-300-430	straight	TC serrated	450mm
300-300-440	left curved	TC serrated	450mm
300-300-441	right curved	TC serrated	450mm

Ø 3mm ANGLED HANDLE

300-300-360	straight	TC serrated	330mm
300-300-370	left curved	TC serrated	330mm
300-300-371	right curved	TC serrated	330mm
300-300-460	straight	TC serrated	450mm
300-300-470	left curved	TC serrated	450mm
300-300-471	right curved	TC serrated	450mm