



surgival
GRUPO COSÍAS

TOTAL KNEE SYSTEM

GENUTECH®

SURGICAL TECHNIQUE

A B C D E



COMPLETE INSTRUMENT SET

FEMORAL 1 UPPER TRAY

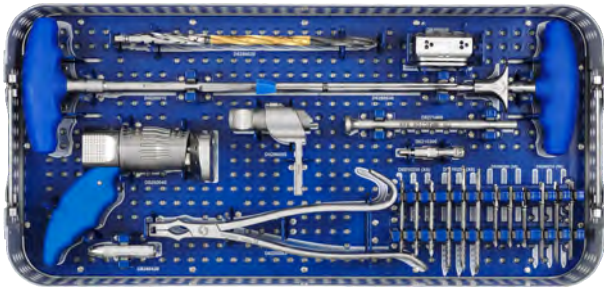

FEMORAL 1 LOWER TRAY

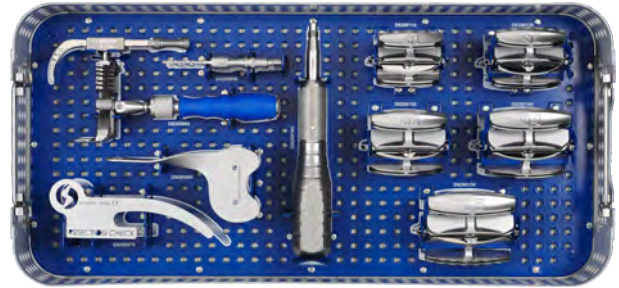

FEMORAL 2 UPPER TRAY

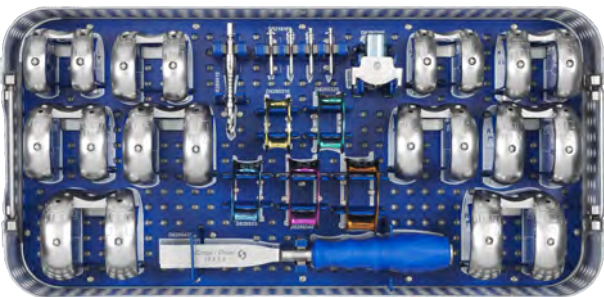

FEMORAL 2 LOWER TRAY

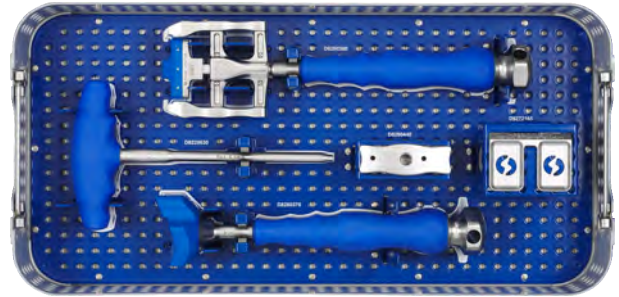

TIBIAL UPPER TRAY



TIBIAL LOWER TRAY

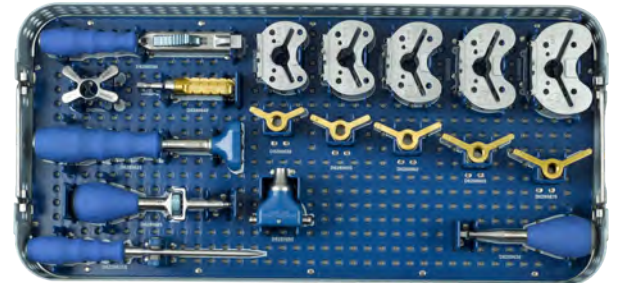

NPS

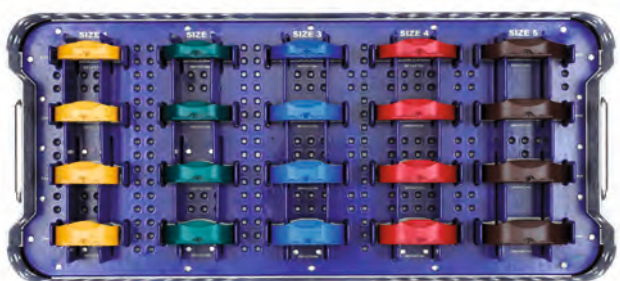

PS



PATELLA



COMPLEX PRIMARY SET *

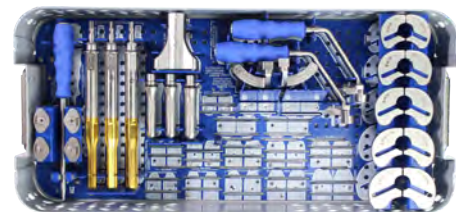

* OPTIONAL. Available upon request Not compatible with previous versions of GENUTECH instruments

| | | |
|----------|---|---------|
| * | <i>T.0 Option: Intramedullary or Extramedullary Tibia</i> | Page 4 |
| A | Distal Cut of Femur and Tibia | |
| | <i>T.1. Tibia cut</i> | Page 6 |
| | <i>F.1. Distal Cut of Femur</i> | Page 10 |
| | * <i>Spacers in extension</i> | Page 13 |
| B | Finishing Femur | |
| | <i>F.2. Measuring Femoral size</i> | Page 14 |
| | <i>F.3 Anterior and posterior Femoral cuts and bevels</i> | Page 16 |
| | * <i>Spacers in flexion and extension</i> | Page 17 |
| | <i>F.4 Trial Femoral component</i> | Page 19 |
| | <i>NPS or PS</i> | |
| C | Finishing Tibia | |
| | <i>T.2. Measuring and positioning tibial tray</i> | Page 20 |
| | <i>T.3 Carve the tibial keel space</i> | Page 21 |
| * | <i>Flexo-extension tests with components</i> | Page 22 |
| D | Patella | |
| | <i>P.1. Patellar time</i> | Page 23 |
| E | Femur, Tibia and Patella implants | |
| | <i>F.5 Definitive femoral implant</i> | Page 25 |
| | <i>T.4 Definitive tibial implant</i> | Page 25 |
| | <i>P.2. Definitive patellar implant</i> | Page 25 |



T.O. EXTRAMEDULLARY TIBIA

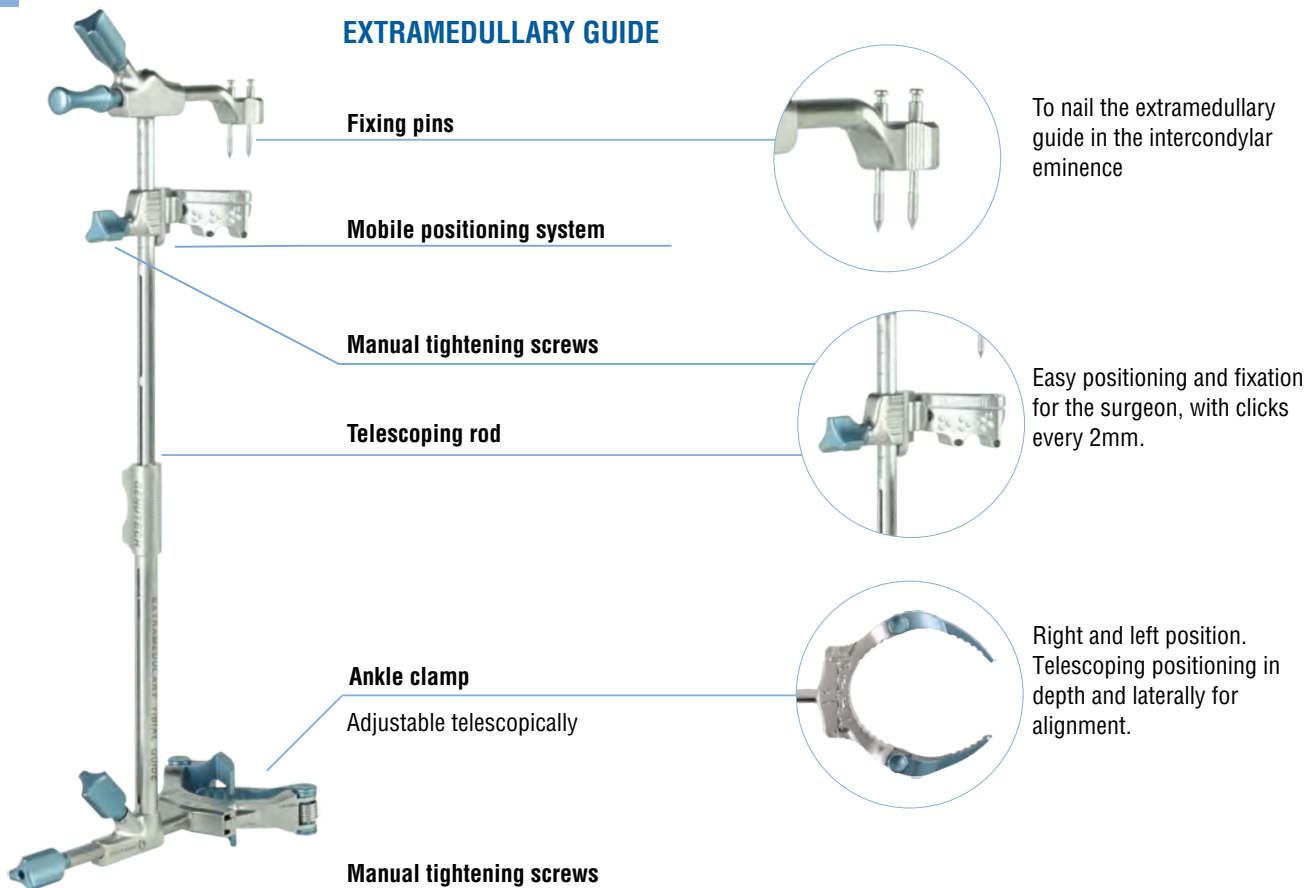

1 Position the ankle clamp

2 Nail the posterior fixation pin and position the extramedullary guide

In the tibial intercondylar eminence, which leaves the extramedullary guide free to rotate and position correctly (remember alignment references with the 2nd metatarsal and anterior tibial tuberosity and parallel to the tibial anterior border). Once in the desired position, it is fixed by nailing the anterior fixing pin.

3 Nailing the anterior fixing pin

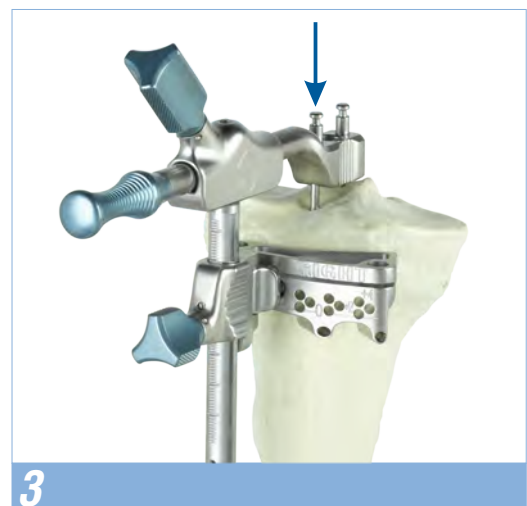
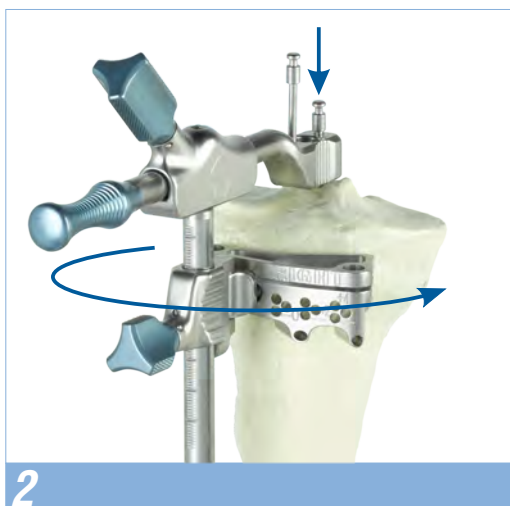

* **T.O. INTRAMEDULLARY TIBIA**

INTRAMEDULLARY GUIDE

Mobile positioning system

Intramedullary rod

Mobile positioning system

Millimetric positioning: 1 click = 2 mm

Probe stylus

Manual tightening screw

Cutting block

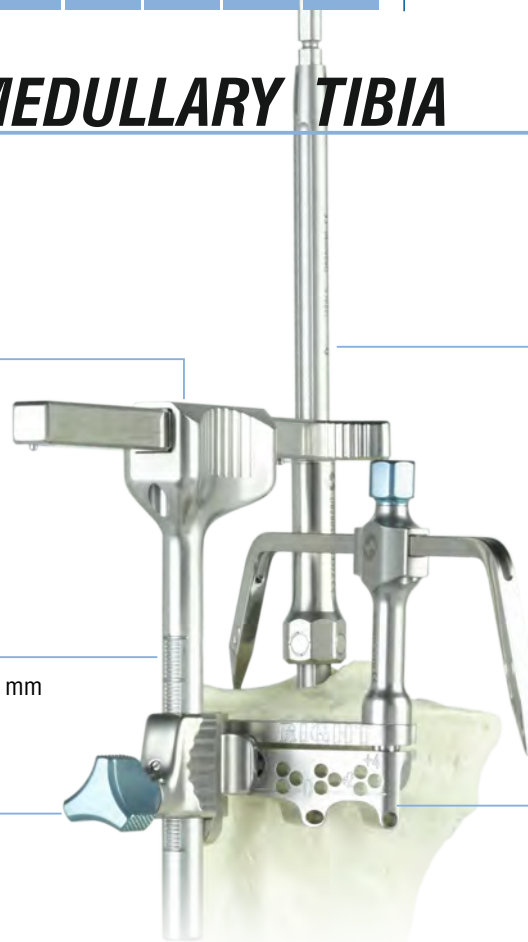

1 Initial perforation

Perforate the chosen location on the cortical with the starter awl and/or drill with the starter drill to prepare the intramedullary canal for insertion of the intramedullary rod. The whole depth of the drill bit should be used, as the last part opens the canal a little more, to facilitate intramedullary cleaning and prevent thrombi.

Tip Femur can also be perforated and/or drilled to speed up surgery time.

2 Inserting the intramedullary rod

Use the T-handle to insert the intramedullary rod through the hole made. Remove the T-handle to insert the intramedullary guide.

3 Inserting the intramedullary guide: Via the intramedullary rod, until it rests on the tibia.



A T.1. TIBIA CUT

Intramedullary and extramedullary

TIBIAL CUTTING BLOCK: Design justification

Cutting at 0°:

The cut is perpendicular to the intramedullary rod or extramedullary guide.

Magnetic grip

Easy to attach to the alignment guide.

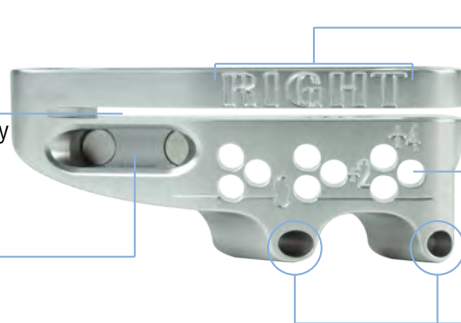

RIGHT / LEFT

Two cutting blocks, RIGHT and LEFT, with anatomical design.

Parallel pins

Positions "0", "+2" and "+4" of 2 mm and 4 mm, respectively, are to facilitate later "recuts", if necessary.

Oblique pins

2 holes so that, if one intersects with the intramedullary rod, the other never does.

Anatomic, minimally invasive design

To affect the soft tissues as less as possible during surgery.



PROBE STYLUS "10/0": Design justification

The probe stylus "10/0" is designed to establish the height at which to perform the tibial cut.

One end is marked with the number "10" and the other with number "0". The probe is inserted in the tibial cutting block with the end "10" in contact with a point of the tibia; the cut is made 10 mm below that point.

This 10 mm resection height corresponds to the total thickness of the smallest tibial component (tray + insert). Whereas, the "0" end indicates the exact height at which the cutting saw will pass through.

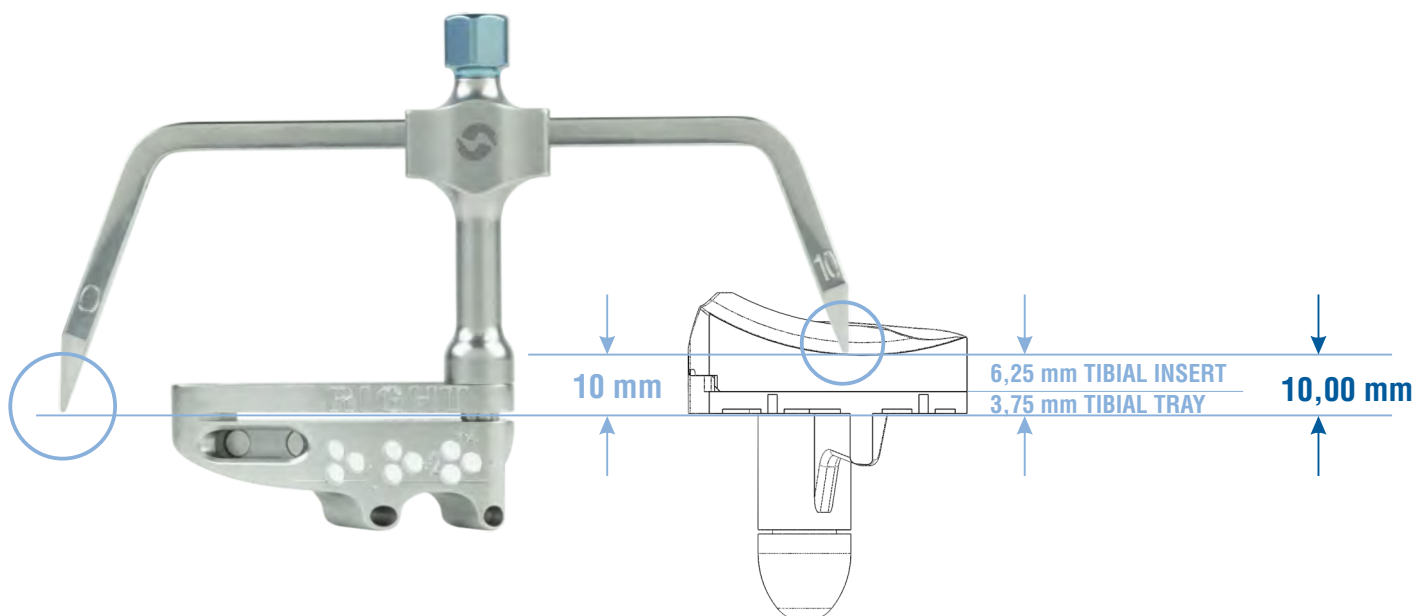

A T.1. TIBIA CUT

Intramedullary and extramedullary

1 **Palpate with the “10” end of the stylus on the highest tibial condyle**

Loosen the manual tightening screw of the cutting block to allow the cutting block to move up and down freely on its guide and position the stylus in one of its locations, then, move the cutting block up or down on the cutting guide until the stylus at the “10” end makes contact with the highest tibial condyle.

2 **Tighten the manual screw to fix the cutting block height on the alignment guide.**

After the probe at the “10” end is in contact with the highest tibial condyle, tighten the manual tightening screw so that the cutting block remains fixed at that height and does not move when checking the following:

3 **Check the height of the cut by trying to touch the lower tibial condyle with the probe stylus perfectly fitted in its position.**

Position the stylus perfectly fitted in one of its locations and remember that the “0” end indicates the height where the saw will pass through when making the tibial cut. Try to make contact on the most depressed part of the lowest tibial condyle with the probe. There are two possible outcomes:

A Try to have the “0” end in contact with the lowest tibial condyle, the stylus will not fit in its position on the cutting block. Therefore, the cut WILL in fact resect that tibial condyle. (As the “0” end of the fully positioned stylus indicates the cutting height and would be below the lowest tibial condyle in this case.) Go to point 4.

B Try to have the “0” end in contact with the lowest tibial condyle. If the stylus does not make contact, therefore the cut will NOT resect that tibial condyle with the cutting block at that height. Go to point 3B on page 8 to reposition the cutting block.

A **CUT IS ENABLED: Go to point 4**



B **NO CUT: Go to point 3B on page 8**

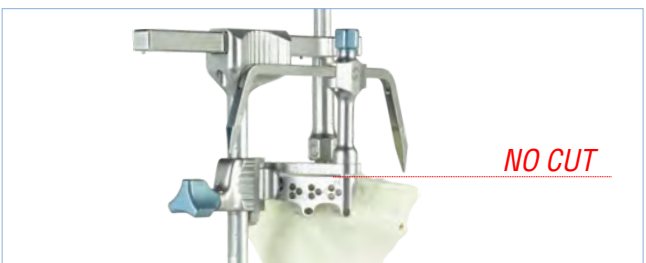

4 **Check resection levels with the resection checker**

5 **Fix the cutting block with headless helical pins in the parallel holes “0” and one threaded pin with head in one of the oblique holes.**



A T.1. TIBIA CUT

3B As checked before, the "0" end does not make contact with the lowest tibial condyle. So **the cutting height must be readjusted** to ensure that the osteotomy completely resects the lower tibial condyle and properly supports our tibial tray.

Remember that the "0" end of the stylus indicates the exact height at which the saw makes its cut. Loosen the manual tightening screw to allow the cutting block to move up and down freely and position the stylus perfectly fitted in one of its locations. Make contact with the most depressed area of the lowest condyle to set the height of the cut.

Fix the cutting block position again by tightening the manual screw.

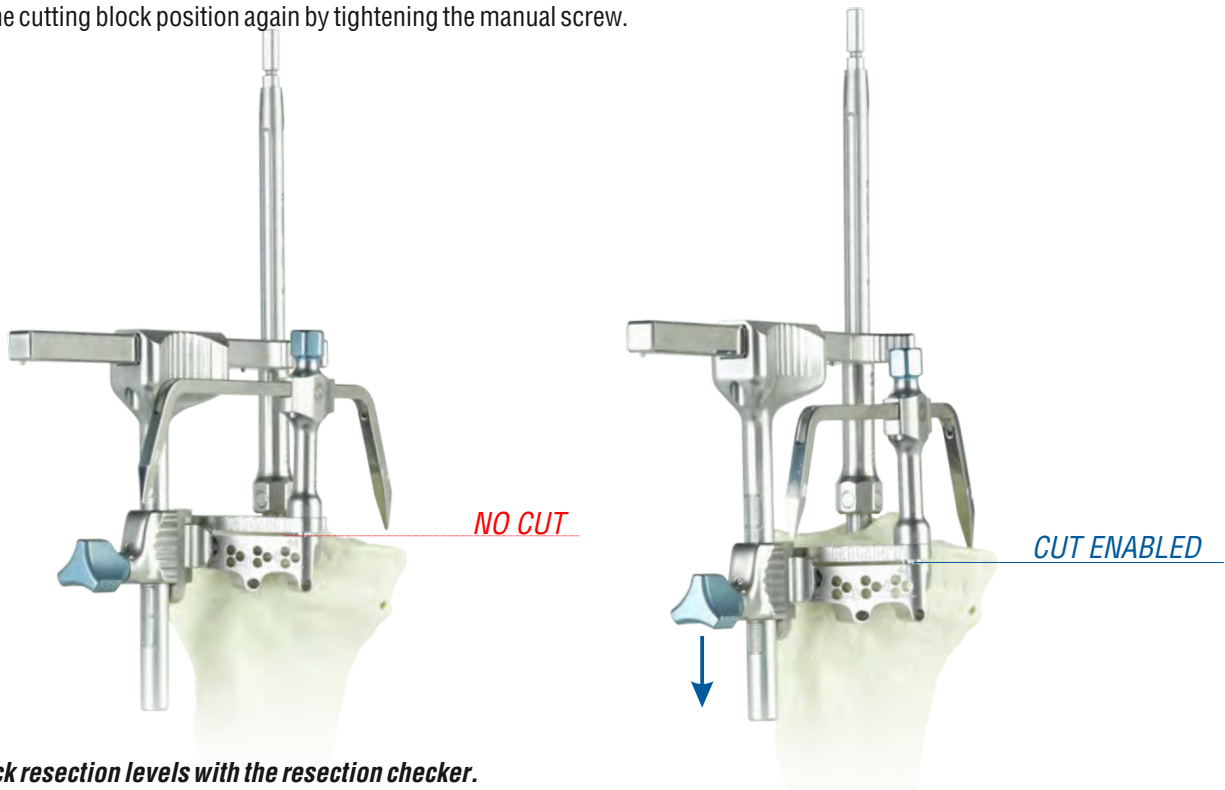

4 Check resection levels with the resection checker.

5 Fix the cutting block with headless helical pins in the parallel holes "0" and one threaded pin with head in one of the oblique holes.

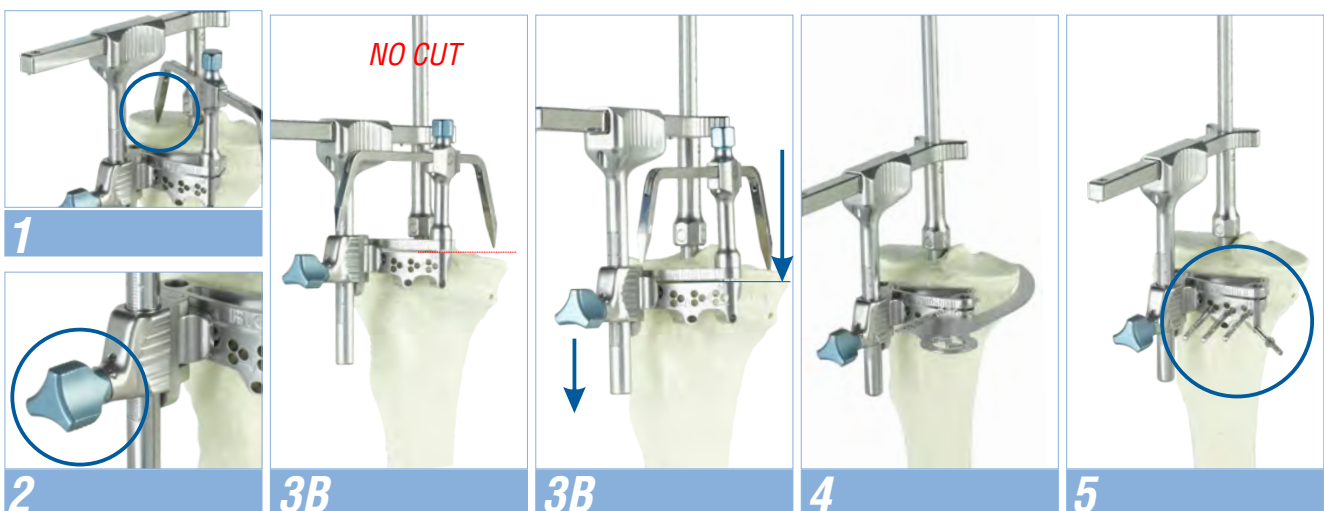

A T.1. TIBIA CUT

REMOVE GUIDE AND MAKE TIBIAL CUT



HOLES "+2", "+4"

To make a cut 2 mm or 4 mm under "0" level, retire the cutting block and insert it again through the holes marked as "+2" or "+4"

HEADLESS HELICAL PINS



Easy to insert, place in the "0" parallel holes to be able to remove the cutting block through them once the tibial cut has been made. They are left in position for possible recuts.

THREADED PINS WITH HEAD



They ensure a stronger fixation by compressing the part against the bone with their head. They are inserted into the oblique holes and have to be removed to remove the cutting block. There are two holes so that, if one intersects with the intramedullary rod, the other never does.

A Removing the extramedullary guide

A1 Loosen the manual screws and screw the impactor/extractor handle to the top of the guide and pull upwards to unfasten the fixing pins and leave the guide loose.

A2 Separate the guide from the cutting block by pulling it backwards.

B Removing the intramedullary guide

B1 Position the alignment rod T-handle and remove the intramedullary alignment rod.

B2 Separate the guide from the cutting block by pulling it backwards.

3 Make the tibia cut trying to avoid the saw sag that will produce an incorrect cut. The saws must have a thickness of 1.27 mm. A lower thickness runs the risk of making inadequate cuts.

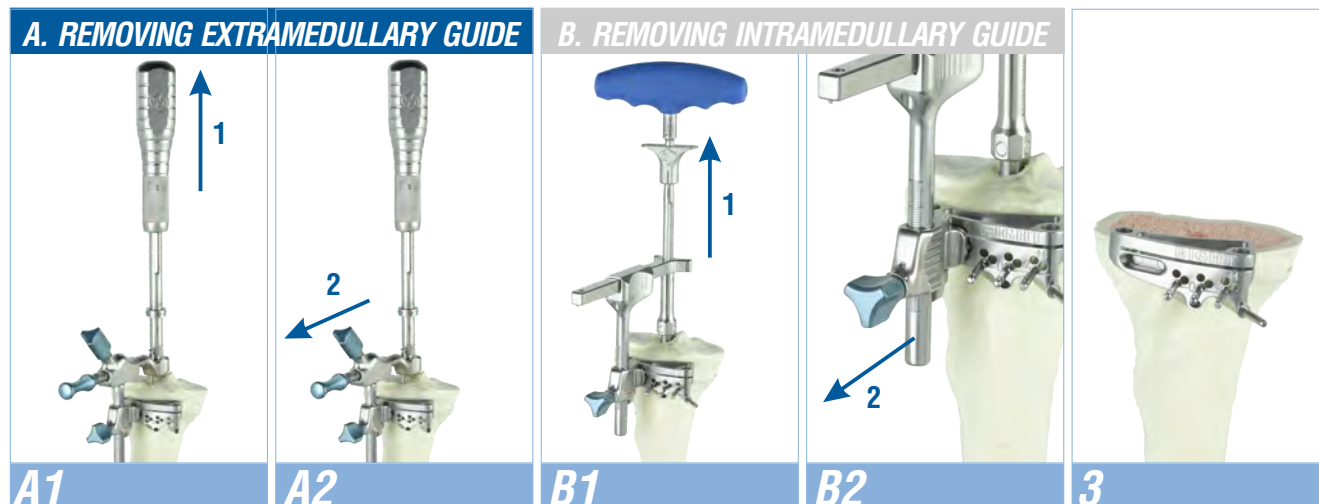

A F.1. FEMUR DISTAL CUT

STARTER DRILL: Design justification

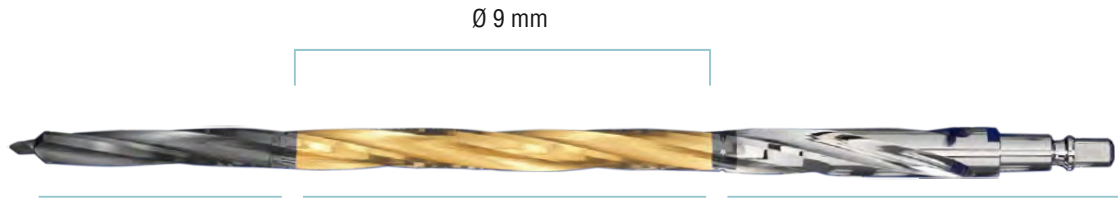

1
 Conical transition from 7 to 9 mm to fix the intramedullary rod diaphysially.

2
 Constant diameter zone for guiding the intramedullary rod.

3
 Transition from 9 to 11 mm to practise a distal opening to facilitate cleaning of the canal and prevent thrombi.

1 Initial drilling

Perforate the entry location on the cortical with the starter awl and/or starter drill to prepare the intramedullary canal for insertion of the intramedullary rod. The whole depth of the drill bit should be used, as the last part opens the canal a little more, to facilitate intramedullary cleaning and prevent thrombi.

Tip *Tibia can also be perforated and/or drilled* to speed up surgery time.

2 Inserting the alignment rod no further than the maximum limit mark

Using the T-handle for quick coupling, insert the alignment rod through the hole made no farther than the mark engraved on the rod. This mark indicates the minimum space the intramedullary rod needs to insert the varus-valgus alignment guide.

3 Remove the T-handle via its quick coupling.

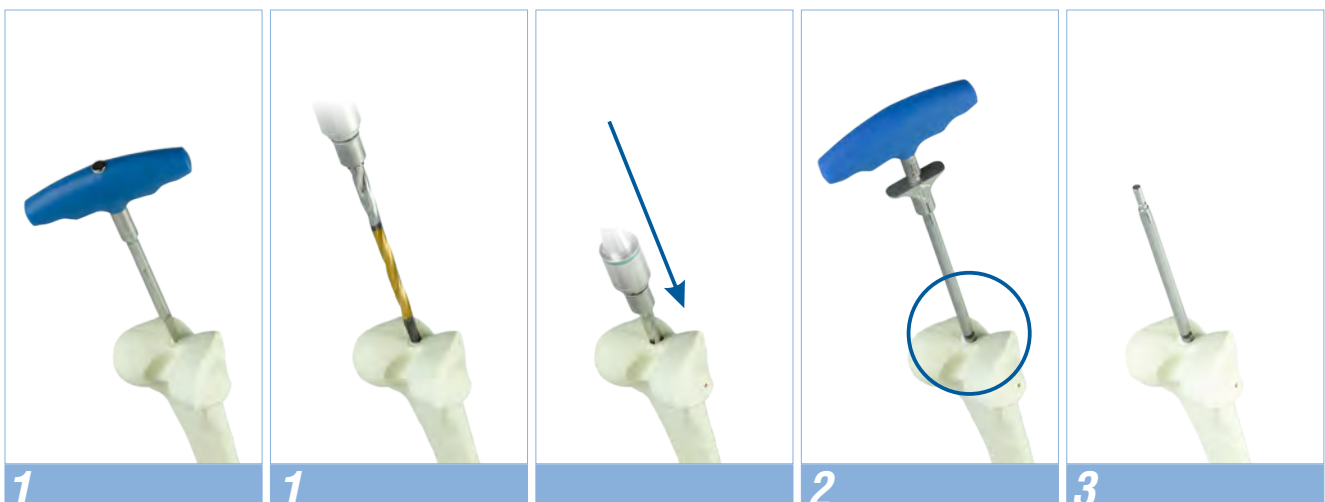

A F.1. FEMUR DISTAL CUT

VARUS-VALGUS ALIGNMENT GUIDE: Design justification

The fully assembled varus-valgus alignment guide consists of three parts: the alignment guide itself, the cutting block support and the cutting block.

DISTAL CUTTING BLOCK

MAGNETIC UNION FOR CUTTING BLOCK

Easy to assemble and remove.



PIN HOLES

To move the cutting block on the pins to enlarge the resection +2 mm or +4 mm .

CUTTING BLOCK SUPPORT

LEVER LOCK "OPEN" / "CLOSED"

The selected resection level is prevented in the "CLOSED" position.

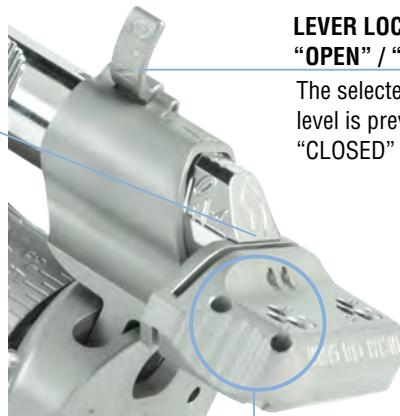

PIN HOLES

Holes for headless pins and oblique holes for fixing the cutting block.

POSITION "0"

The "0" position establishes a resection level of 8 mm, equivalent to the thickness of our femoral component. Adjustable from -4 mm to + 8 mm (added to the "0" resection of 8 mm).



- 1** **Set the cut value on the distal cutting block support and put with the locking lever in the CLOSED position**
Usually in the "0" position (the "0" position is equivalent to an 8 mm cut, which is the condylar thickness of our femoral implant) and fix that position by putting the locking tab in the CLOSED position.
- 2** **Mount the cutting block on the support in its magnetic housing**
- 3** **Insert the cutting block support on the alignment guide slot**
- 4** **Select the varus-valgus alignment value between 0° and 9°**, (usually 5°) towards the part corresponding to the leg to be operated upon: RIGHT or LEFT.

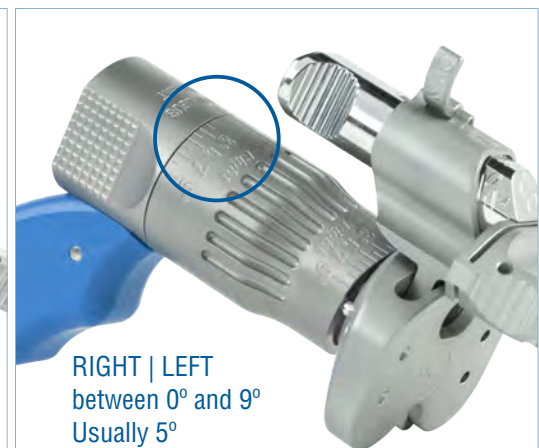
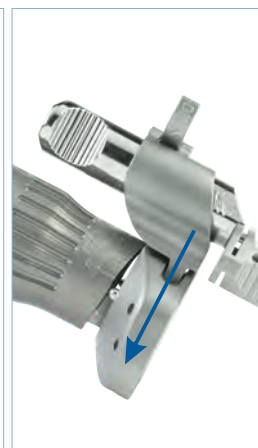

1

2

3

4

A F.1. FEMUR DISTAL CUT

Insert the varus-valgus alignment guide through the alignment rod until contacting the distal part of the femur. The cutting block will slide over the femur easily and position itself on its anterior part. Check all the settings previously selected before fixing the cutting block with headless pins and the oblique pin.

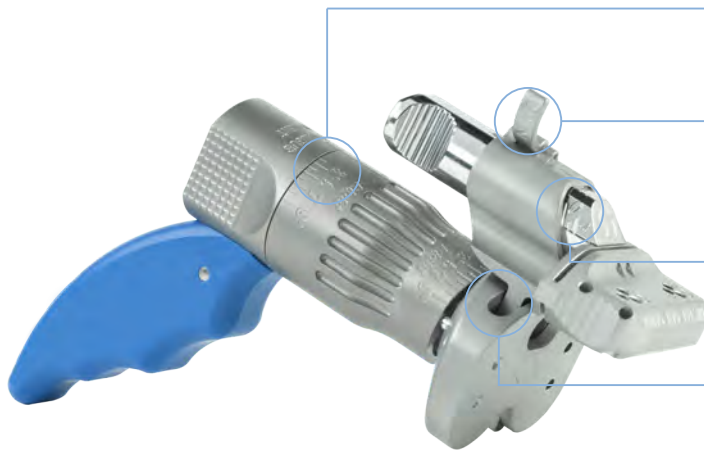

CHECK THE VARUS-VALGUS ALIGNMENT

Choose "RIGHT" or "LEFT" side for the leg you are operating and degrees between 0° and 9°

LEVER LOCK "CLOSED"

Raise the lever to the CLOSED position to block the desired measures on the cutting block positioner.

CUTTING BLOCK POSITIONER AT "0"

At the "0" mark, the cut made is 8 mm, (depth of our implant). Adjustable from -4 mm to +8 mm from "0".

CORRECTLY POSITIONED

Cutting block properly housed in support.
 Cutting block supported on the femur.
 Distal cutting guide supported on femur.

- 1** *Insert the alignment guide* through the alignment rod until contacting with the distal part of the femur.
- 2** *Fix parallel pins* with headless pins in the cutting block holes identified with "0" and an *oblique pin* in one of the holes for oblique pins to ensure the position of the cutting block.
- 3** *Remove the alignment guide from its position*, by holding the alignment rod T-handle with one hand and the alignment guide knob with the other hand. Remove the alignment rod. Then the Alignment Guide which is engaged magnetically to the cutting block.
- 4** Assess the level of resection with the resection checker.
- 5** *Perform the distal cut* with a 1.27 mm saw. Use the tibial protection plate.



A *. SPACERS IN EXTENSION



Use the spacers provided to check if our cuts give enough space for our implants with the knee in extension.

In case that the smallest of our spacers can not be introduced, the knee will not have enough space to house our prosthesis and a recut has to be done, normally in the tibia.

Note that at this point of the surgery it is easier to make a recut, as we have all the parallel pins for tibia and femur in place.

The proper alignment of the cuts can also be evaluated by inserting the alignment rod through one of the spacer holes.

TIBIA RECUT

To make the tibia recut remove the cutting block from its position through the “0” holes, and position it through the “+2” holes for a 2 mm recut or the “+4” holes for a 4 mm recut.

PINS IN “+2” POSITION (RECUT)



RESECTION LEVEL “+2”

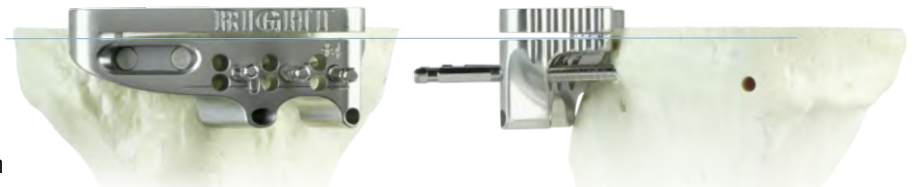

There is also a second option of the pins through the “+4” holes.

FEMUR RECUT

To make the femur recut remove the cutting block from its position through the “0” holes, and position it through the “+2” holes for a 2 mm recut or the “+4” holes for a 4 mm recut.

It is important to remember that the femur recuts modify the position of the interline.



B F.2. MEASURING THE FEMORAL SIZE

FEMORAL GAUGE: Design justification

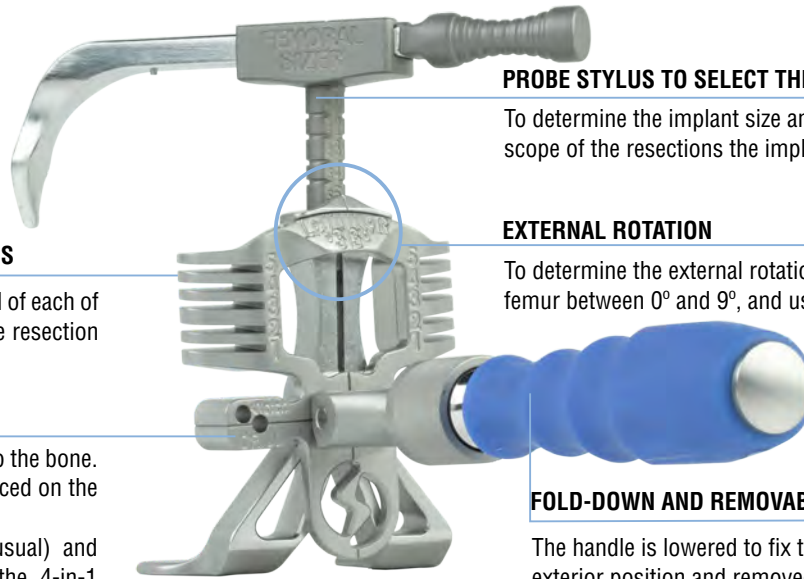

PROBE STYLUS TO SELECT THE SIZE

To determine the implant size and the scope of the resections the implant requires.

EXTERNAL ROTATION

To determine the external rotation of the femur between 0° and 9°, and usually 3°

FOLD-DOWN AND REMOVABLE HANDLE

The handle is lowered to fix the desired rotation to exterior position and removed via the easy extraction mechanism.

SLOTS TO CHECK CUTS AND SIZES

Evaluate the anterior resection level of each of the sizes using these slots with the resection checker.

“DRILL” AND “NOTCH” HOLES

Used to transfer external rotation to the bone. The 4-in-1 cutting block will be placed on the drilled holes.

2 positions available: “DRILL” (usual) and “NOTCH” (to raise the level of the 4-in-1 cutting block to avoid notching).

1 With the knee at 90°, position the femoral gauge in contact with the distal cut and both posterior condyles of the femur. **Select the desired external rotation on the gauge and secure the position turning the handle downwards.** There are RIGHT | LEFT options and a range from 0° to 9° to perform the external rotation.

Once the external rotation position is fixed, remove the handle to have more space to work in the area.

Hypo-plastic condyle If there is a hypoplastic posterior condyle unable to properly support the gauge, there is a slot to insert the resection checker and align it with the Whiteside’s line. If both posterior condyles are damaged, align it with the transepicondylar axis.

The holes are made in the next step.

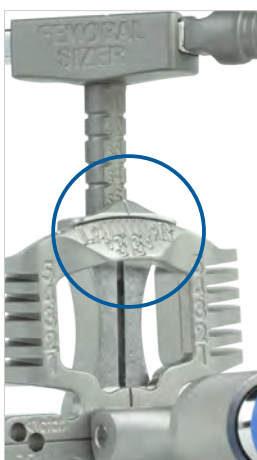

1

RIGHT | LEFT
 Usual 3°

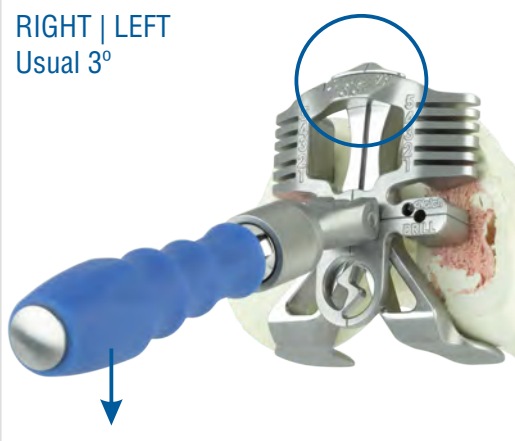

1



Special case for hypoplastic condyle

B F.2. MEASURING THE FEMORAL SIZE

2 Drill the bone using the holes marked as “DRILL” with the Ø 3.4 mm bit included in the instruments. Alternatively, insert two pins through these holes to keep the position of the gauge ensured in preparation for the next step: size selection.

PROBE STYLUS: Design justification

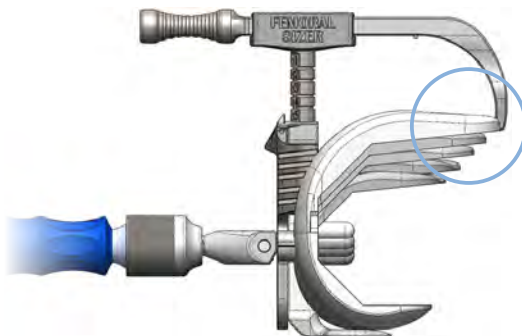

PROBE STYLUS

When setting the same size in the vertical axis and in the horizontal axis of the probe stylus, the tip of the stylus indicates exactly where the antero-external flap of the prosthesis will reach and exactly where the anterior cut will end.

3 Femoral implant size selection

3.1. PLACE THE PROBE IN ITS HOUSING

Place the probe in its housing with the horizontal indicator selecting an intermediate size (3) and the tip resting slightly externalised.

3.2. CHECK VERTICAL AXIS READING

In that position, read the size on the vertical axis, which now has to be transferred to the horizontal axis as a possible size for the femoral component.

3.3. SELECT THE SAME SIZE ON THE HORIZONTAL AXIS

Select the size indicated by the vertical axis on the horizontal axis. Now with the two identical values, the pointer indicates exactly where the antero-external flap of the prosthesis will reach and exactly where the anterior cut will end for that size.

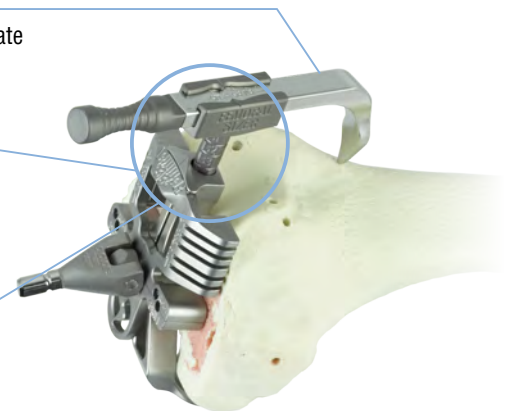

4 Check the level of cuts for the selected size

The resection checker inserted in the selected size slot gives a second reference for the height at which the saw will make the anterior cut; thus, allowing an assessment to be made about if this cut would lead to a “notch”.



2

3.1.

3.2.

3.3.

4

B F.3. ANTERIOR AND POSTERIOR CUTS AND BEVELS

4-IN-1 CUTTING BLOCK: Design justification

5 CUTTING BLOCKS FROM SIZES 1 TO 5

The cutting block width is identical to that of the femoral component of the same size, with the height also corresponding to the component height.

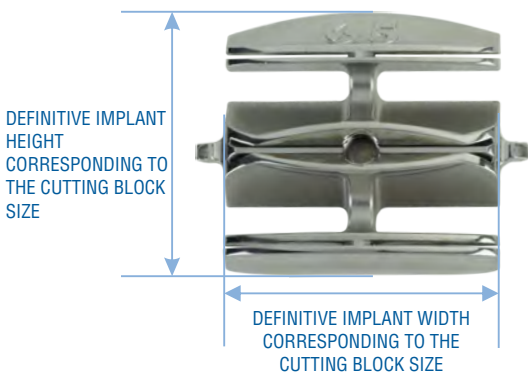

4 CUTS IN A SINGLE CUTTING BLOCK

The cutting block allows the anterior and posterior cuts and the two bevels to be done simply and accurately.



- 1** *With the impactor/extractor handle impact the selected size of 4-in-1 cutting block*
 The block is inserted into the two holes made previously with the femoral gauge.
- 2** *Check the cut resection levels with the resection checker*
- 3** *Fix the cut block with Ø 3.4 mm pins*
- 4** *Perform the anterior, posterior and bevel cuts*
- 5** *Remove the pins and disimpact the cutting block with the impactor/extractor handle.*

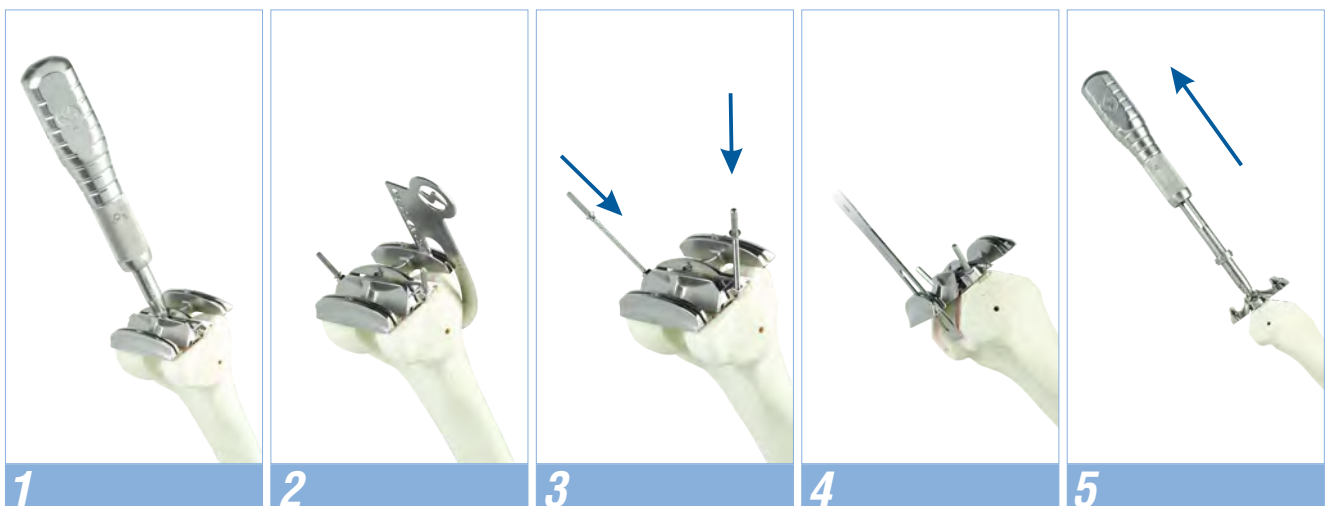

B *. SPACERS IN FLEXION AND EXTENSION

Insert the spacers in flexion and extension. With the tibial cut and the femoral cuts performed, a spacer is selected and inserted in flexion and extension to assess the alignment of the limb and the ligament tension in the knee. This spacer height is equivalent to the total height of the prosthesis with an insert of the size marked in the spacer.



PERFORMING THE FEMUR AND TIBIA RECUTS

If the spacers do not fit in flexion or extension, or there is excessive ligament tension in one of the positions, it is advisable to perform a recut, either in the tibia or the femur; there being three possibilities, which are explained in more detail on page 18:

EXTENSION YES / FLEXION NO

POSTERIOR FEMUR RECUT

see page 18

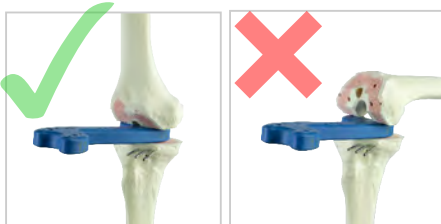

To give more space only in flexion, a posterior recut of the femur must be done.

Insert the **posterior recut block +4 mm** into the holes drilled beforehand with the femoral gauge. Drill new holes, and insert a smaller size cutting block than the one selected originally.

EXTENSION NO / FLEXION YES

RECUT FEMUR DISTAL

see page 18

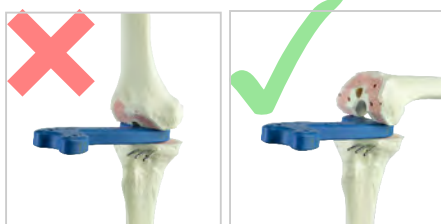

To give more space only in extension, we must do a femur distal recut.

After the distal recut of femur, the rest of the 4 cuts must be repeated (anterior, posterior and 2 bevels), with the 4-in-one cutting block of the same size.

EXTENSION NO / FLEXION NO

RECUT TIBIA

see page 18

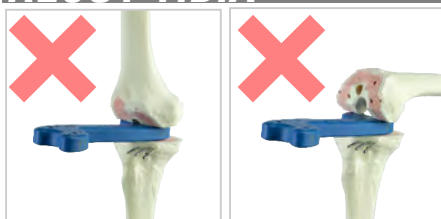

To give more space in flexion and extension, the recut needed will be done on the tibia.

Or FEMUR DISTAL RECUT + FEMUR POSTERIOR RECUT

To give more space in flexion and extension without cutting the tibia, two recuts should be done. A distal recut of femur followed by a posterior recut of femur.

B *. RECUTS

POSTERIOR FEMUR RECUT

A posterior recut of the femur should be done to give more space to the prosthesis in flexion. Use the **posterior recut block +4 mm** inserted into the holes already made with the femoral gauge. Once positioned, drill the new holes of the block. Place again the **4-in-1 cutting block** of a **smaller size** than the one used for the previous cuts. The **4-in-1 cutting block** is fixed and the anterior, posterior and bevel cuts are re-done.



DISTAL FEMUR RECUT

The **distal recut block** is supported in the anterior and distal femur cuts, fixed with pins. Make a new distal recut through one of its cutting slots (+2, +4, +8 or +12). After the distal recut, the **4-in-1 cutting block** of the **same size** previously used is impacted and fixed with pins to make the 4 cuts left.

Note that the distal recut will change the interline position. The recut should not be greater than 4 mm.



TIBIA RECUT

Insert the **tibial cutting block** via the parallel pins through the **+2** holes for a recut of 2 mm or through the **+4** holes for a recut of 4 mm. Fix the **tibial cutting block** position with an oblique pin and make the new cut.



B F.4. TRIAL FEMORAL COMPONENT

NPS (Non Postero Stabilized) or PS (Postero Stabilized)

Impactor / Extractor of femoral components: Design justification

PREPARING IMPACTOR / EXTRACTOR FOR FEMORAL COMPONENTS

Opened position: with the fixing tabs separated and the handle unscrewed to capture the component with the tabs, then manually close them over the femoral component notches.

ADJUST WITH IMPACTOR

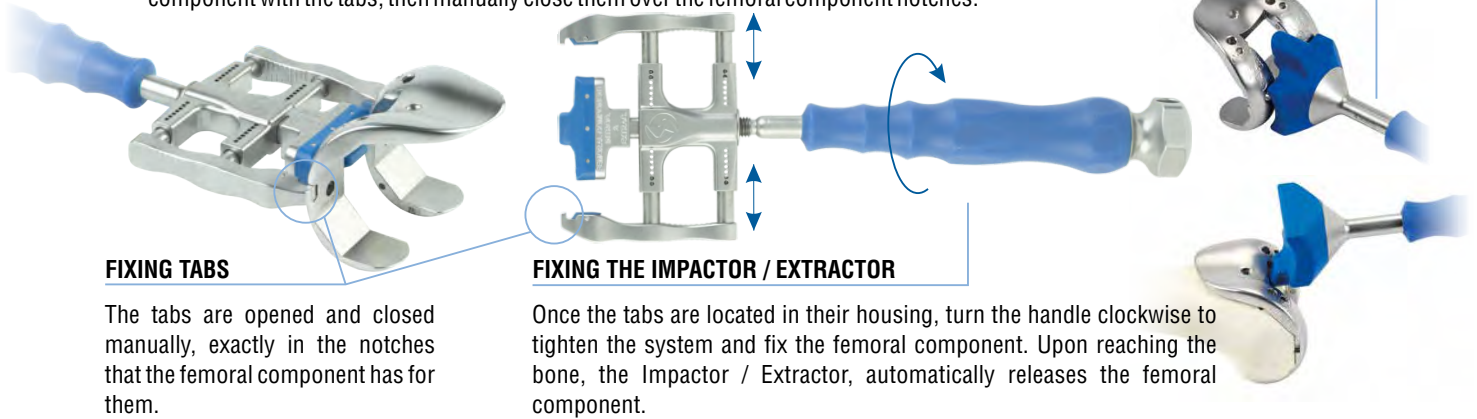

FIXING TABS

The tabs are opened and closed manually, exactly in the notches that the femoral component has for them.

FIXING THE IMPACTOR / EXTRACTOR

Once the tabs are located in their housing, turn the handle clockwise to tighten the system and fix the femoral component. Upon reaching the bone, the Impactor / Extractor, automatically releases the femoral component.

1 *Insert the component* with the femoral component impactor / extractor and impact in its position. This instrument helps to prevent the femoral component from being inserted in flexion. The impactor / extractor automatically releases the femoral component when it reaches the bone. If adjustments need to be done, the final, very versatile impactor is available, which offers many possibilities for impaction.

2A *To implant a NPS femoral component, make two holes with the Ø 6 mm NPS drill* on the femoral resection plane to accommodate the definitive NPS implant pivots to complete this part

2B *To implant a PS femoral component, position the intercondylar cutting guide in its housing* and secure it with the manual thread. It can be tightened with the screwdriver and the femoral component fixed with pins, if necessary, before making the cut.

3 Using a narrow saw, *make the cuts to accommodate the intercondylar box*. Use the chisel available in the instruments to perform specific final adjustments. Protect the posterior areas with the tibial protection plate.

4 *Insert the intercondylar box*, of the same size as the femoral component, sliding and clicking it properly in place. Now we have a PS trial femoral component.

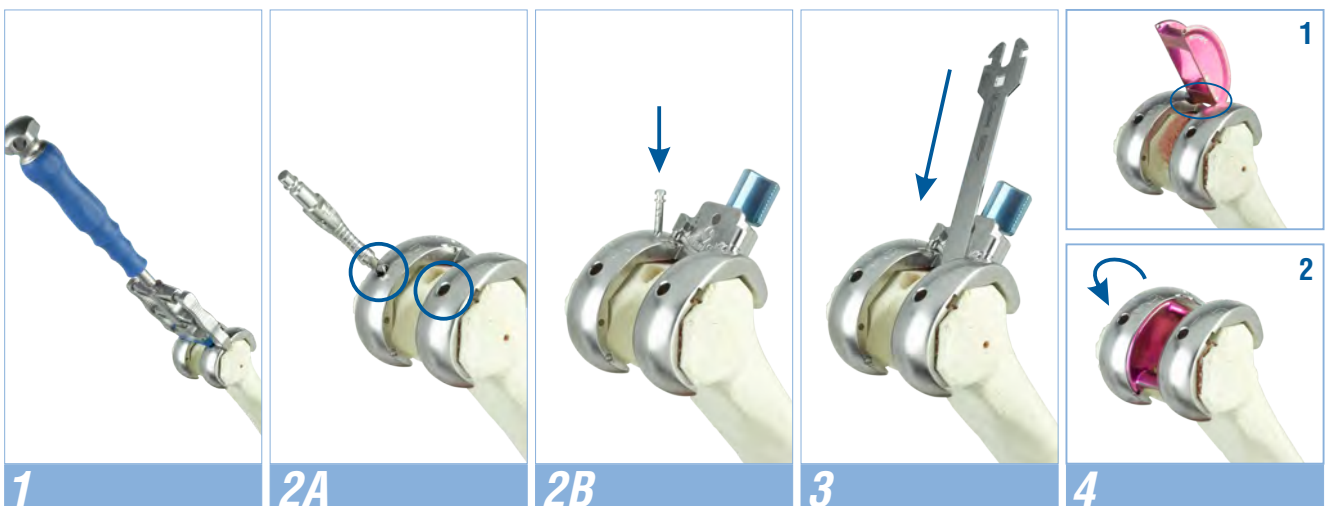

C T.2. MEASURE AND POSITION TIBIAL TRAY

TRIAL TIBIAL TRAY AND TIBIAL TRAY HANDLE: Design justification

TRIAL TIBIAL TRAY

Contains holes for fixing with motorised pins or pins with nailed heads which also allow positioning of the tibial insert without them needing to be removed. Marks in the profile make it easy to reference their positioning.

TIBIAL TRAY HANDLE

The OPEN / CLOSED position allows the tibial tray to be fixed and positioned easily to assess its size.

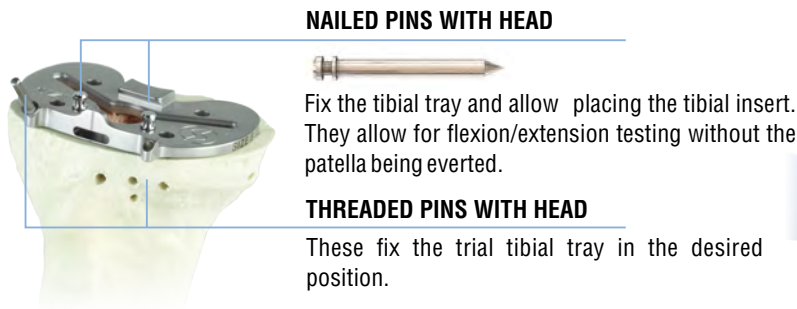

- 1** **Select one trial tibial tray and position** it with its handle in the CLOSED position. Place it on the resected tibia to check if it is supported well, that it does not protrude and that it allows for proper articulation. There are 5 sizes of trial tibial tray.
- 2** Once the size has been decided, **attach a tibial insert OF THE SAME SIZE OF THE TRIAL FEMORAL COMPONENT AND THE ADEQUATE THICKNESS** to the trial tibial tray, either manually or with the impactor.
- 3** **Place the trial tibial tray and tibial insert in position** and assess the joint movement with the trial femoral component to confirm the proper and final position. Mark the position with the scalpel using any of the references marked in the trial tibial tray.
- 4** **Fix the final position with pins.**
- 5** **Remove the trial tibial insert with the inserts extractor** by making a rotational movement (not levering it out).

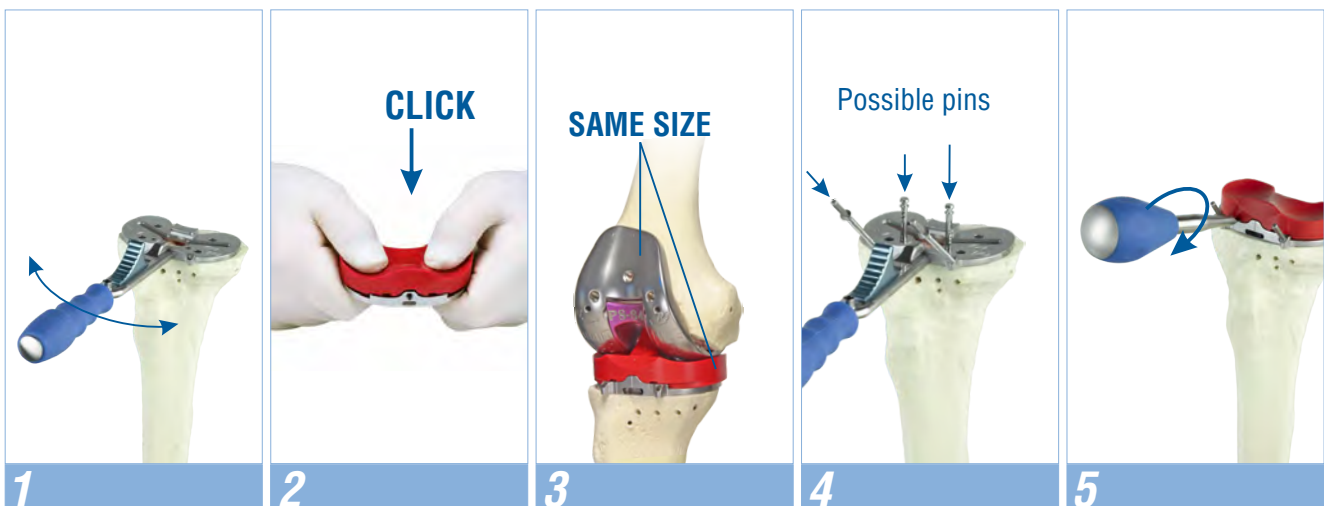

C T.2. CARVE SPACE FOR THE TIBIAL KEEL

TIBIAL KEEL: Design justification

MINIMALLY INVASIVE FLAPS

Anthropometric “W” design in convergent planes, whose implantation by impactation ensures the integrity of the surrounding bone structure.

STANDARD OR LONG PLUG (15 mm or 25 mm)

The keel chisel can carve the two lengths of plug, the standard 15 mm or the 25 mm, by using the pin impactor on the central cylinder of the keel chisel.



1 Thread the impactor / extractor handle to the tibial keel of the same size of the trial tibial tray. Impact the tibial keel until flushed with the trial tibial tray.

SHORT PLUG

Tip If sclerous bone is found, start with the saw to mark the entry and the tibial drill to facilitate the later impactation of the keel.



1b To carve the long tibial tray plug, **impact with the pin impactor bar through the tibial keel orifice.**

LONG PLUG

2 Remove the fixing pins

3 Place the tibial insert of the selected size, starting with the posterior part and then the anterior part until it clicks into position, either manually or with the help of the multi-purpose impactor.





FLEXION-EXTENSION WITH TRIAL COMPONENTS

With the trial components installed, perform the joint flexion and extension movements to verify proper mobility and stability of the knee.

If satisfactory, prepare the implants to finish the knee replacement.

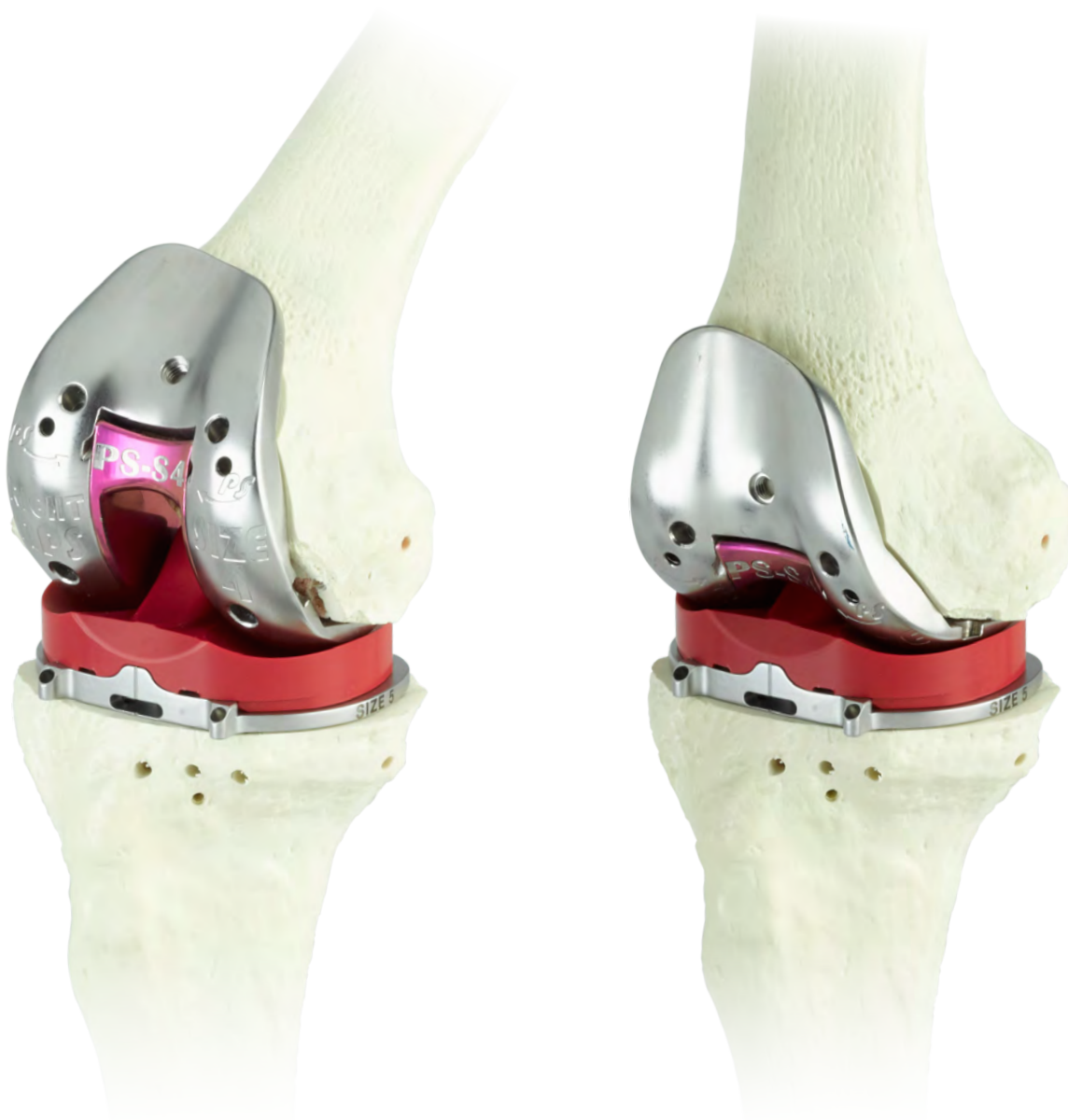

D P.1. PATELLAR TIME

PATELLA RESECTION FORCEPS: Design justification

PATELLA DIAMETER AND THICKNESS

To recall all available patella measurements.

MANUAL TIGHTENING

To ensure the patella firmly fixed with the forceps.

RESECTION LEVEL INDICATOR



The manual thread is used to adjust the level of resection, marked in the turret.

PATELLA CUTTING AND HOLDING JAWS

Numerous small and sharp teeth ensure the position of the patella during resection.

PATELLA REST BASE

Rest for the patella before fixing.



ERGONOMIC PUSHBUTTON

For opening the measurement.

PATELLA HEIGHT GAUGE: Design justification

GRADUATION AND MEASUREMENT IN MILLIMETRES

To measure the thickness of the patella.



MEASUREMENT TIP

MEASUREMENT BASE

PATELLA THICKNESS MM

HANDLE

Ergonomic and of silicone to facilitate its positioning.

PATELLA DRILL GUIDE AND PATELLA DRILL BIT: Design justification

PATELLA PERIMETERS

Visualisation of the patella perimeters to help in centering the implant over the resection.

PATELLA DRILL BIT

Sharp with a limit for the exact drill depth required.

PATELLA DRILL GUIDE

With spikes to help secure it on the resected plane of the patella.

CLOVERLEAF SHAPE

Allows us to see the bone behind and correctly position the patella.



D P.1. PATELLAR TIME



Patella implant thickness

Choose the appropriate patella implant thickness to maintain the height of the original patella. 5 thicknesses between 7 mm and 11 mm are available.

Maintain as much bone stock as possible (at least 12-14 mm)

A minimum of 12-14 mm is recommended to reduce the risk of fracture

PATELLA IMPLANTS: Diameters and heights

| | | | | | |
|----------|-------|-------|-------|-------|-------|
| Diameter | 32 mm | 34 mm | 36 mm | 38 mm | 40 mm |
| Height | 7 mm | 8 mm | 9 mm | 10 mm | 11 mm |

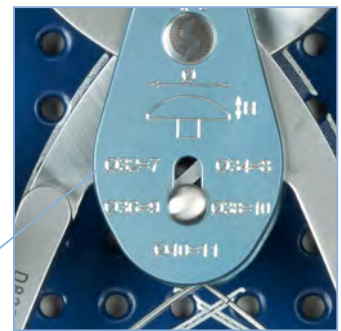

To recall all available patella measurements.

- 1 Measure the thickness of the patella** with the patella height gauge included in the instruments. Leave a minimum bone thickness to reduce the risk of a fracture (12-14 mm).
- 2 Adjust the cutting height** in the resection level indicator of the patellar resection forceps, indicating the thickness in mm of patella to be maintained from the original patella. A minimum of 12-14 mm is recommended.
- 3 Resection of the patella:** Rest the patella on the patella rest base prepared for it and close the resection forceps jaws on the patella to maintain its position. Tighten manually and perform the resection with a 1.27 mm saw through the cutting slots.
- 4 Drilling the patella.** Centre and position the patella drill guide by pressing on the resected plane of the patella and drill through its drill guided hole with the patella drill.
- 5 Insert the trial patella**



E DEFINITIVE COMPONENTS

GENUTECH[®] NPS



GENUTECH[®] PS



- 1** Using the impactor/extractor for femoral components and with the final femoral implant properly attached, **impact the femoral component into its correct position** (after placing the cement in the implant, if cemented). Make final adjustments to the position with the final femoral impactor, if necessary.
- 2** **The cap tibial tray selected (standard or long) is fixed to the tibial tray** with the 4.5 mm screwdriver.
- 3** Use the tibial tray holder handle to hold the tibial tray (keeping it fixed on its CLOSED position). **Position the tibial tray and impact it correctly on the carved tibia**. Use the multi-purpose impactor for any final adjustments.
- 4** **Position the definitive tibial insert** either manually or with the help of the multi-purpose impactor. Insert the fixing bolt using the fixation bolt handle and finish by tightening it with the 2.5 mm screwdriver.
- 5** **Position the definitive patella implant** cemented in its hole and leave it tightened by the patellar clamp until the cement hardens.

Perform the definitive flexion-extension tests and finish the surgery.





FACTORY / INTERNATIONAL DEPT.

Parque Tecnológico
Leonardo Da Vinci, 12-14
46980 Paterna · Valencia · Spain

NATIONAL DEPT.

Ignacio Iglesias, 70
08950 Esplugues de Llobregat
Barcelona · Spain

www.surgival.com



TOTAL KNEE SYSTEM
GENUTECH®

EXPRESS SURGICAL TECHNIQUE

A B C D E