

Tip lumină alb/rece
Detartor (scaler) 5 vîrfuri cu iluminare LED obligatoriu
Mîner detașabil, autoclavabil obligatoriu
Frecvența de lucru 25 pînă la 31 KHz
Intensitate reglabilă
Tip virfuri ≥ 4
Compresor Fără ulei obligatoriu Putere $\geq 1,5\text{kw}$
Revenirea automată la poziția inițială
Obligatoriu
Control multifuncțional de la picior mobil
Tensiune 220-240V
Frecvența 50-60 Hz

Compresor Fără ulei obligatoriu Putere $\geq 1,5\text{kw}$ SA 150
<https://en.lifedent.cn/97.html>
Revenirea automată la poziția inițială (pagina 19)
Obligatoriu
Control multifuncțional de la picior mobil
Tensiune 220-240V (instrucțiuni, pagina 29)
Frecvența 50-60 Hz (instrucțiuni, pagina 29)



E9-c/E9-i/E9-t/E9-x/P3-c/P3-i/P3-t

Dental Unit

Operating Manual

Lifedent (Zhuhai) Co., Ltd.

Foreword

Please carefully read and understand this manual before using this product, and keep it handy for future use. You must strictly follow the operating procedures to use this product and maintain it properly.

Paragraphs marked with "**Warning**" or "**Caution**" shall be read and executed carefully to avoid injuries to operators and patients or damage to the equipment.

If any fault occurs to the equipment during use, please contact the local dealer or the company in time.

● Safety precautions

When using the equipment, be sure to follow the basic safety precautions listed below to reduce the risk of equipment damage, fire, electric shock, personal injury and other hazards:

- * Follow all warnings and instructions given on the equipment and in the accompanying text document. If any operating instructions conflict with the safety information, pay attention to the safety information as you may have misinterpreted the operating instructions. If you cannot resolve the conflict, contact a professional service person for help.

- * Before maintaining and cleaning the equipment, please turn off the total power, water and air supply of the equipment.

- * Do not place the equipment on unstable floors, carts or racks as the equipment may fall and cause damage.

- * Do not place the equipment near radiators or heaters.

- * The equipment cannot be used in the presence of flammable anesthetic gas mixed with air or flammable anesthetic gas mixed with oxygen or nitrous oxide.

- * Do not place or hang heavy objects on the equipment.

- * Do not use wires that do not comply with the requirements of the equipment. Otherwise, its performance may be compromised or a fire or an electric shock may even be caused.

- * Do not push anything into the equipment through the opening in the housing or enclosure. That may touch a place with dangerous voltage, which may cause fire or electric shock. Do not spill any liquid on the equipment.

- * To avoid the risk of electric shock, do not disassemble the equipment without prior authorization. If you need to repair the equipment, please contact professional technical service personnel.

- * Opening or removing the cover may expose you to dangerous voltages or other dangers. Improper assembly may cause electric shocks during subsequent use of the equipment.

- * In the event of the following cases, turn off the main power switch and ask professional service personnel for help:

(1) Any part of the power cord, plug, or connecting cable is damaged or frayed.

(2) Unknown liquid is spilled into the equipment or the circuit of the equipment.

(3) The performance of the equipment suddenly changes significantly.

- * Please adjust only the controls mentioned in the operation instructions. Incorrect adjustment of other controls may result in equipment damage.

- * Avoid using the equipment during thunderstorms. Thunderstorms may cause a lightning strike. If possible, turn off the main power during a thunderstorm.

- * Do not use a damaged or loose plug. Insecure plug connections may cause electric shocks or sparks, which will lead

to fires.

- * Grounded plugs and sockets must be used. Poor grounding may result in electric shocks or equipment damage.

- * It is strictly forbidden to touch the PC board and the manufacturer's electronic components with hands or metal

instruments.

⚠Warning: When a patient is wearing a cardiac pacemaker or hearing aid, it should be considered that the dental unit may affect it.

⚠Warning: The maximum load of the electric dental chair of dental unit does not exceed 150 kg.

⚠Warning: Do not turn on the water heater switch when there is no water supply.

⚠Warning: The instrument tray should not exceed the maximum allowable load, the maximum allowable distributed load is: 3 kg.

⚠Warning: The action limit of the dental chair is locked, and non-professionals cannot adjust it at will.

⚠Warning: The dental unit should be used with the dental handpiece with anti-suck-back function and consistent with the equipment, and it should be operated strictly according to the operating manual.

⚠ Warning: The replacement of the bur must be done when the handpiece has come to a complete stop, otherwise the bearings may be damaged and the bur may injure people.

⚠ Warning: The equipment can only be used by fully trained individuals (doctors or nurses). The manufacturer is not liable for any incorrect operation, negligence or inapplicability.

⚠ Warning: When the operation is over or when the operator gets off work, the water source, gas source and main power supply must be turned off.

⚠ Warning: The discharge of sewage and waste should comply with the laws and regulations of the country. For collection of amalgam, users should equip themselves with an amalgam separator.

⚠ Warning: The equipment is equipped with a one-way check valve at the main water inlet to prevent backflow, and the distance between the water outlet and other pollutants is greater than 20 mm. The distilled water system is completely independent of the tap water system. Make sure it is reliable before use.

⚠ Warning: The use of gas source shall comply with national laws and regulations. Countries without gas source requirements shall ensure that the gas source is free of hazardous substances such as oil, water and bacteria.

⚠ Warning: Modifications to this equipment are not permitted.

⚠ Warning: The expected service life of the equipment is ten years. See the nameplate for the production date. Do not use the product when reaching the lifetime of the device to avoid affecting the operation or treatment due to the device's incomplete performance.

● **Notes on this manual**

The notes contain information on all optional components in this series, so some of the information may not be applicable to your machine.

What is provided in this manual is the operation and maintenance of this series of dental units. All information provided is valid until the publication of the manual. The company reserves the right to modify the specifications or design of the equipment at any time without prior notice to the user.

Without the prior written permission of Lifedent (Zhuhai) Co., Ltd., this manual may not be added, modified, disseminated, reprinted or sold in any form or by any means (such as electronics, machinery and pictures).

Lifedent (Zhuhai) Co., Ltd. reserves the right to interpret and change all the information in this article.

⚠ Caution: The guaranteed content shall be invalid in the event of non-compliance with any of the following alerts:

- (1) Abide by the terms stated in the guarantee.
- (2) The equipment must only be used according to the contents of the manual.
- (3) The indoor power cord installed shall be a three-core power cord of 1.5 square millimeter.
- (4) The equipment should be fixedly installed.
- (5) For the maintenance that involves entering the inside of the equipment, any correction operation must be performed by engineers of Lifedent (Zhuhai) Co., Ltd.
- (6) Any accessories and used equipment must be replaced by Lifedent (Zhuhai) Co., Ltd. or authorized personnel, otherwise the performance and safety of the dental unit will be affected. Please refer to the packing list for the parts.

Contents

Chapter 1 Product Description	1
1.1 Scope of application/structure	1
1.2 Equipment overview	1
1.2.1 Panorama of E9-c dental unit.....	1
1.2.2 Panorama of E9-i dental unit.....	2
1.2.3 Panorama of E9-t dental unit.....	3
1.2.4 Panorama of E9-x dental unit.....	4
1.2.5 Panorama of P3-c dental unit.....	5
1.2.6 Panorama of P3-i dental unit.....	6
1.2.7 Panorama of P3-t dental unit.....	7
1.2.8 The dental operative unit connected with dental unit	7
1.2.9 Nameplate	8
1.2.10 Technical parameters	8
1.2.11 Normal operations, transportation and storage conditions of the dental unit.....	8
Chapter 2 Description of E9-c/E9-i/E9-t/E9-x Operating Panel, Display and Keys	9
2.1 Description of the operating panel and operation keys	9
2.1.1 Illustration of the doctor's main operating panel and assistant position operating panel.....	9

E9-c/E9-i/E9-t/E9-x/P3-c/P3-i/P3-t Dental Unit Operating Manual

2.1.2 Description of keys and symbols	9
2.2 Parameter setting and display	10
2.3 Assistant position operating panel operation.....	16
2.3.1 Dental operating light operation.....	16
Chapter 3 Description of P3-c/P3-i/P3-t Operating Panel and Keys	17
3.1 Description of operating panel and operation keys	17
3.1.1 Illustration of the doctor's main operating panel and assistant position operating panel.....	17
3.1.2 Description of keys and symbols	17
3.2 The operation of the treatment table and the assistant position key panel and the function key memory setting	18
3.2.1 Doctor selection	18
3.2.2 Lifting operation method of electric dental chair	18
3.2.3 Electric dental chair backrest lift	18
3.2.4 Memory setting and operation method of program positions	18
3.2.5 Mouth-rinsing position key setting	18
3.2.6 Emergency position setting	18
3.2.7 Mouth-rinsing water heating key operation	19
3.2.8 Disinfection key operation	19
3.2.9 Reset position setting	19
3.2.10 Dental operating light ON/OFF key setting	19
3.2.11 Mouth-rinsing water filling key setting	19
3.2.12 Spittoon rinsing setting	19
Chapter 4 Equipment Operation Instructions	19
4.1 Power switch operation.....	19
4.2 Dental operating light operation	19
4.2.1 LED dental operating light operation.....	19
4.2.2 Installation and removal of dental operating light handle.....	20
4.3 Foot switch operation.....	20
4.4 Operation of treatment table balance arm height	20
4.5 Instrument tray operation	21
4.6 Pull-up treatment table pull rod operation.....	21
4.7 Operation of the headrest.....	21
4.8 3 way syringe operation.....	21
4.9 Operation when used with dental handpieces	21
4.9.1 Dental low-speed handpiece connection port.....	21
4.9.2 Dental high-speed handpiece connection port.....	21
4.9.3 Dynamic instruments water volume adjustment.....	21
4.9.4 Dynamic instruments spray volume adjustment.....	22
4.10 Strong saliva aspirator operation	22
4.11 Weak saliva aspirator operation	22
4.12 Distilled water system operation	22
4.13 Pipeline disinfection system operation.....	23
4.14 Security function.....	23
Chapter 5 Maintenance, Servicing, Cleaning and Disinfection of Equipment.....	23
5.1 Description of disinfection and sterilization.....	23
5.2 Cleaning of the saliva aspirator pipeline and filter	24
5.3 Cleaning of the spittoon.....	24
5.4 Cleaning of the return gas bottle	24

E9-c/E9-i/E9-t/E9-x/P3-c/P3-i/P3-t Dental Unit Operating Manual

5.5 Other cleaning.....	24
5.6 Maintenance and servicing of equipment.....	25
Chapter 6 Installation, Commissioning and Maintenance of Dental Unit.....	25
6.1 Installation conditions	25
6.2 Installation site requirements	25
6.3 Handling, packaging and dismantling methods of equipment.....	27
6.4 Installation method of equipment.....	27
6.4.1 Installation of electric dental chair.....	27
6.4.2 Installation of the dental operating light.....	27
6.4.3 Installation of water, gas and electricity in the floor box.....	27
6.5 Commissioning method of equipment.....	28
6.6 Water sampling connection port.....	28
6.7 Schematic diagram of water and gas and electrical diagram	28
6.8 Waste disposal.....	35
Chapter 7 Common Faults and Troubleshooting	35
7.1 Electric dental chair part.....	35
7.2 Replacement of fuse tube.....	35
7.3 accessory and of common spare parts list	35
7.4 Graphics and symbols used in equipment.....	35
Chapter 8 Electromagnetic Compatibility	36
Chapter 9 Disposing.....	40

Chapter 1 Product Description

1.1 Scope of application/structure

1.1.1 Scope of application **Intended**

Purpose

The Dental Units is an AC-powered equipment that intended to properly position a patient to perform dental procedures and supply power, water, or air to and serve as a base for other dental equipment. And the Dental Units is attached to a dental chair.

Population: adult.

Contraindications: 1) Patient weighed more than 150kg. 2)Child patients (below the age of 12 years). 3) Patients with pacemaker and/or hearing aids.

Side-effect: The side-effects of dental unit are the noise, eye fatigue of the dental doctor by the dental light.

1.1.2 Structure: It's mainly composed of electric dental chair, instrument tray, mouthwash water supply equipment, dental operating light, saliva aspirator, spittoon, 3 way syringe and foot switch.

1.2 Equipment overview

1.2.1 Panorama of E9-c dental unit

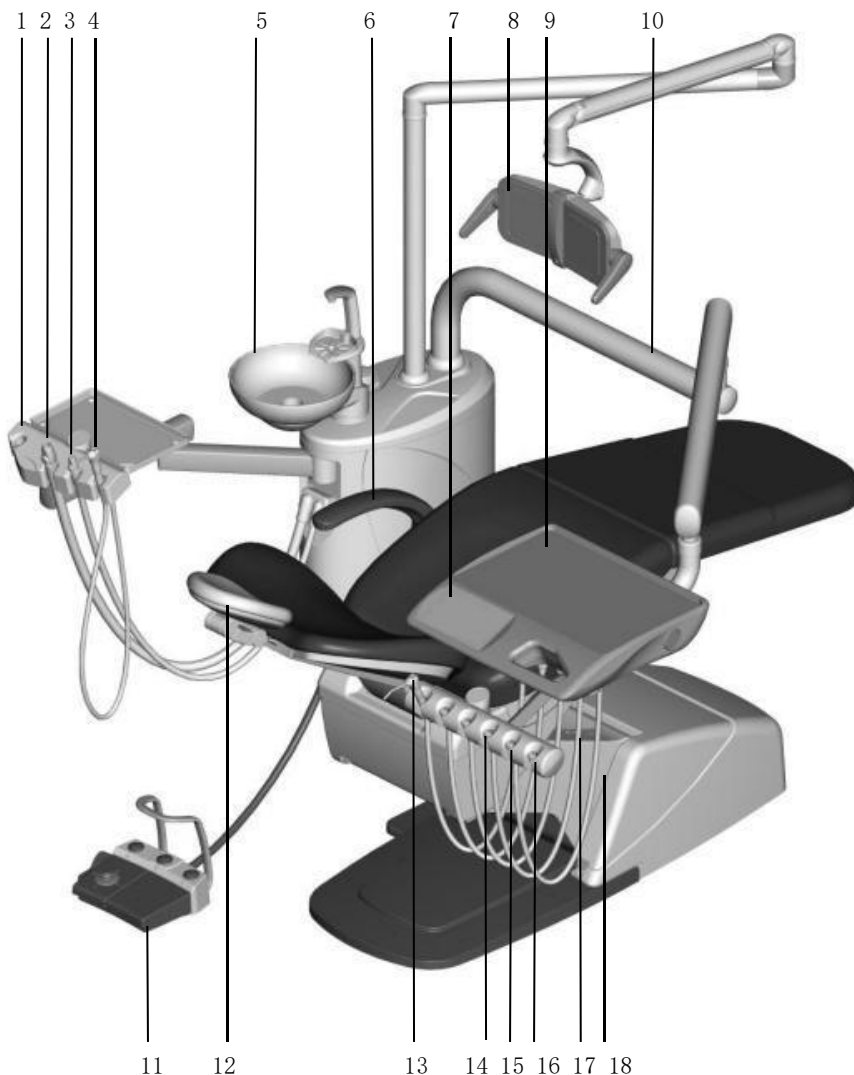

Name of main parts

1	Assistant position operating panel	10	Treatment table balance arm
2	Strong saliva aspirator connection port	11	Foot switch
3	Weak saliva aspirator connection port	12	Headrest (adjustable)

E9-c/E9-i/E9-t/E9-x/P3-c/P3-i/P3-t Dental Unit Operating Manual

4	Assistant position 3 way syringe	13	Treatment table 3 way syringe
5	Spittoon glass/ceramic (detachable, autoclavable)	14	Dental low-speed handpiece connection port
6	Armrest	15	Dental high-speed handpiece connection port
7	Treatment table operating panel	16	Dental high-speed handpiece connection port
8	Dental operating light (3 way adjustable)	17	Power switch
9	Treatment table	18	Electric dental chair

1.2.2 Panorama of E9-i dental unit

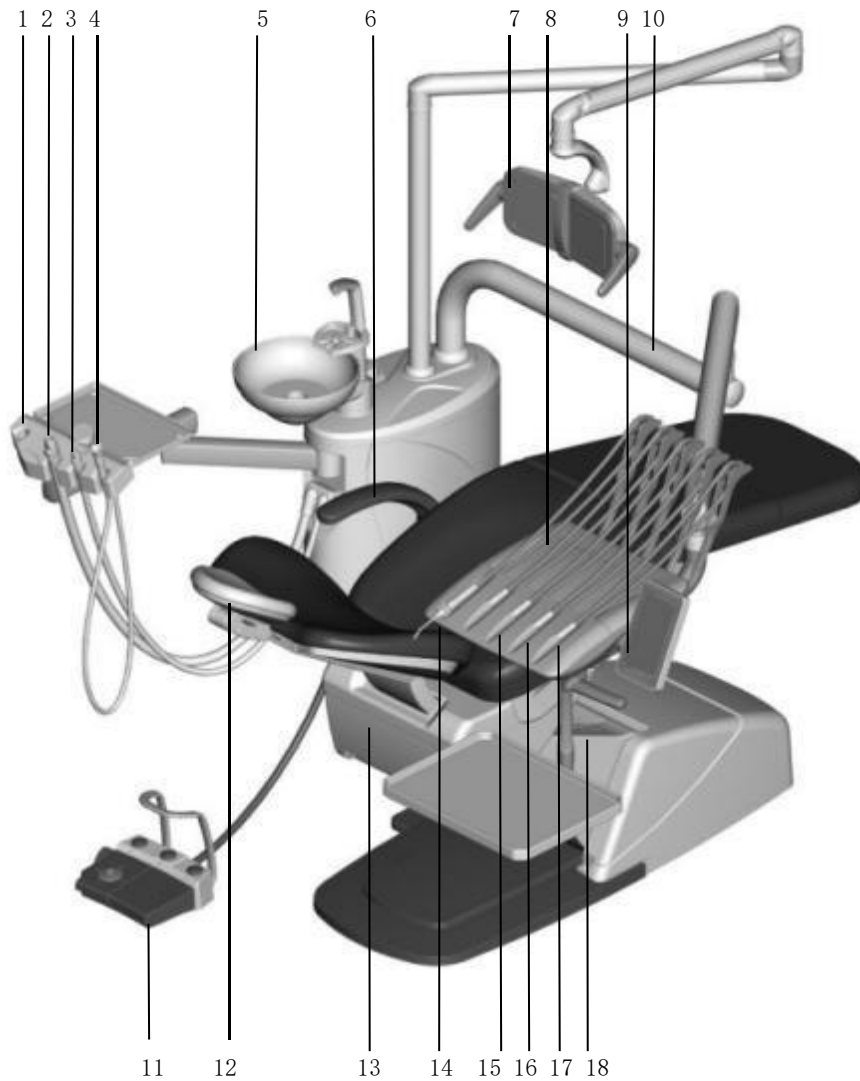

Name of main parts

1	Assistant position operating panel	10	Treatment table balance arm
2	Strong saliva aspirator connection port	11	Foot switch
3	Weak saliva aspirator connection port	12	Headrest (adjustable)
4	Assistant position 3 way syringe	13	Electric dental chair
5	Spittoon Ceramic (detachable, autoclavable)	14	Treatment table 3 way syringe

Panorama of dental unit

6	Armrest	15	Electric micromotor (100-40.000 rpm), LED Handpiece 1:1, LED, max. 40.000 rpm, 3 way cooling
7	Dental operating light (3 way adjustable, 4.000-30.000 LUX)	16	Ultrasonic Scaler (detachable, autoclavable, 28-31KHz)
8	Treatment table	17	Dental Turbine (2.5-2.7 bar), Handpiece – 3 way cooling, LED, max. 300.000 rpm
9	Treatment table operating panel	18	Power switch

1.2.3

E9-t

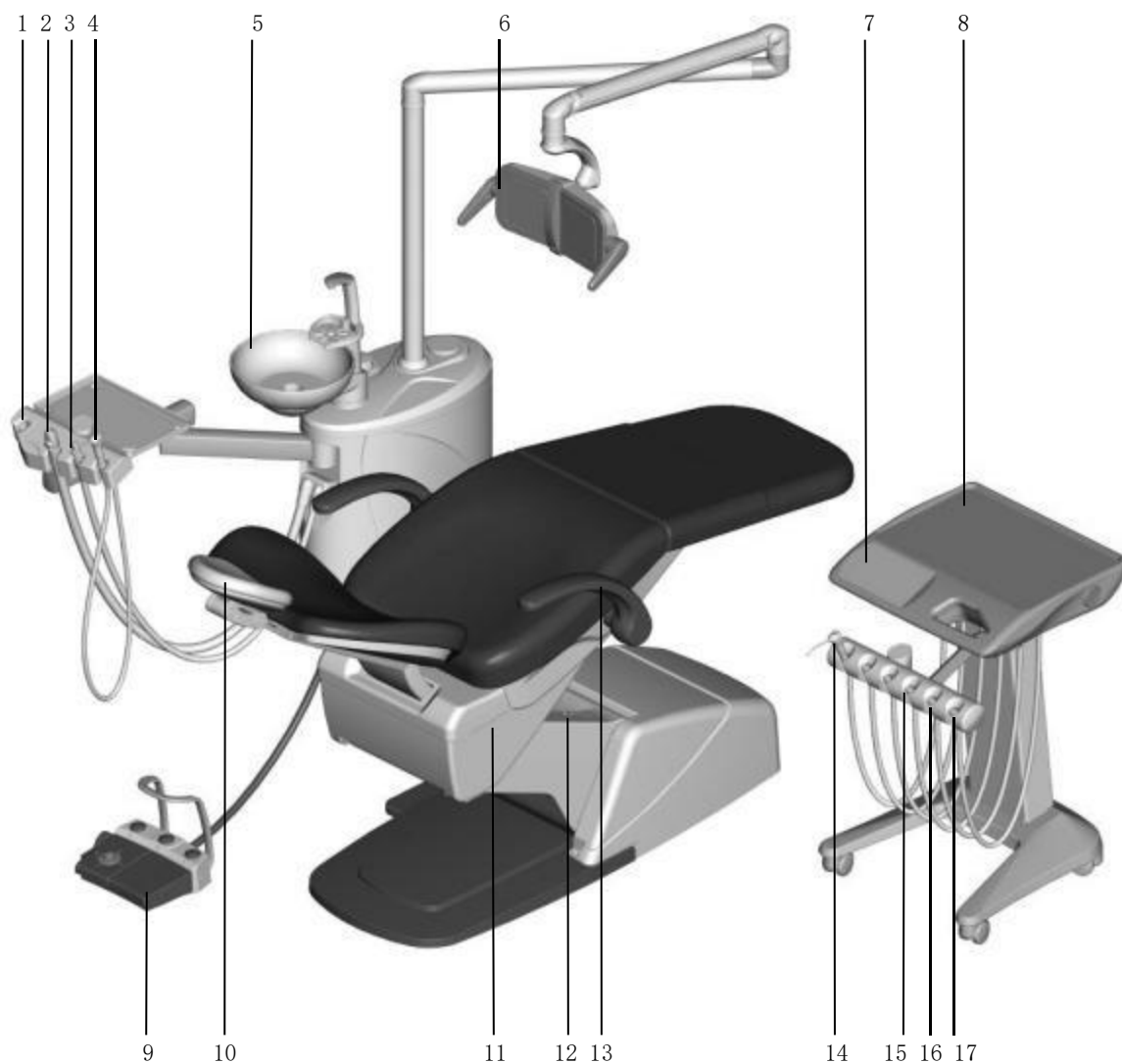

Name of main parts

1	Assistant position operating panel	10	Headrest
2	Strong saliva aspirator connection port	11	Electric dental chair
3	Weak saliva aspirator connection port	12	Power switch
4	Assistant position 3 way syringe	13	Armrest

E9-c/E9-i/E9-t/E9-x/P3-c/P3-i/P3-t Dental Unit Operating Manual

5	Spittoon	14	Treatment table 3 way syringe
6	Dental operating light	15	Electric micromotor (100-40.000 rpm), LED
7	Treatment table operating panel	16	Dental high-speed handpiece connection port
8	Treatment table	17	Electric micromotor (100-40.000 rpm), LED
9	Foot switch		

1.2.4 Panorama of E9-x dental unit

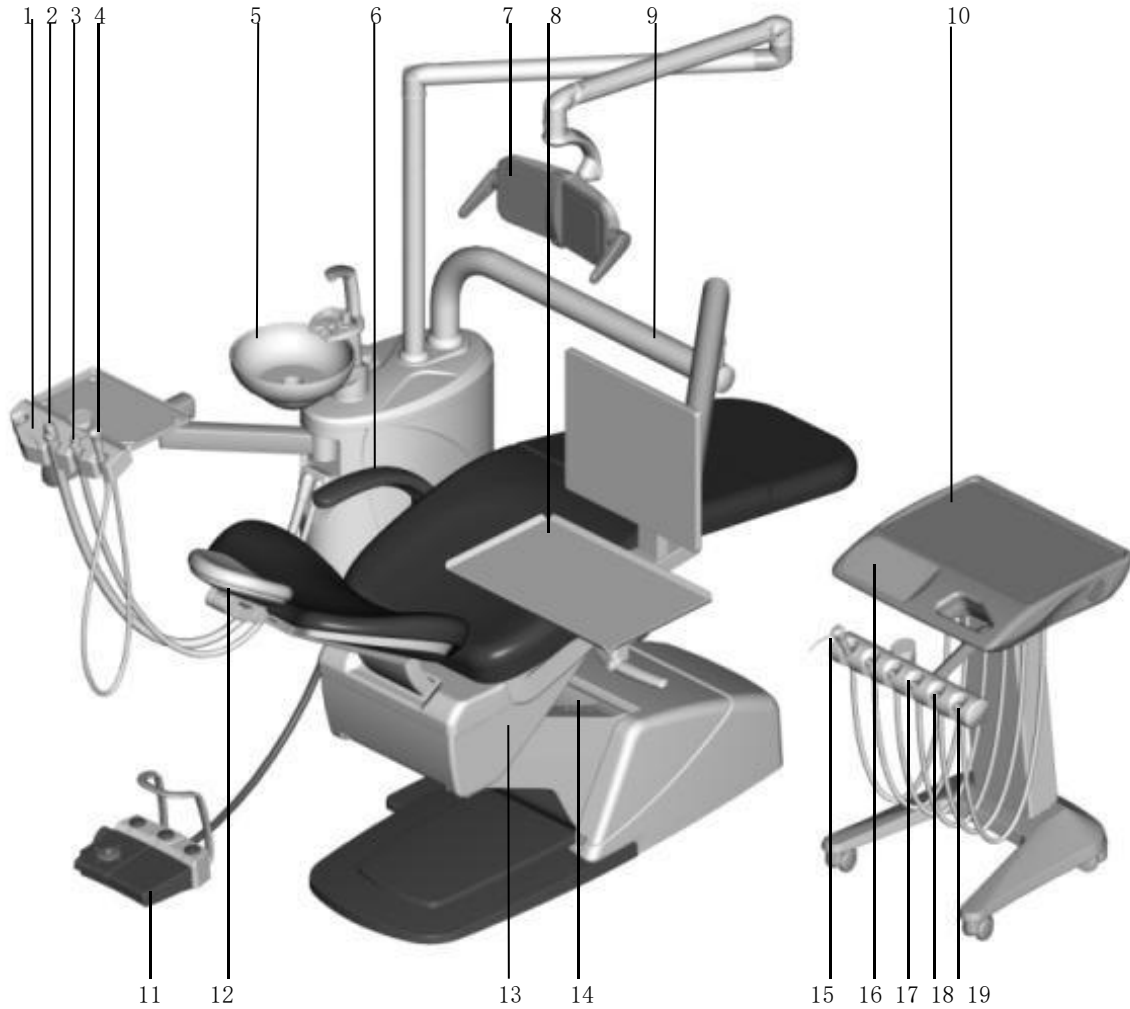

Name of main parts

1	Assistant position operating panel	11	Foot switch
2	Strong saliva aspirator connection port	12	Headrest
3	Weak saliva aspirator connection port	13	Electric dental chair
4	Assistant position 3 way syringe	14	Power switch
5	Spittoon	15	Treatment table 3 way syringe

Panorama of dental unit

6	Armrest	16	Treatment table operating panel
7	Dental operating light	17	Dental low-speed handpiece connection port
8	Tray	18	Dental high-speed handpiece connection port
9	Treatment table balance arm	19	Dental high-speed handpiece connection port
10	Treatment table		

1.2.5

P3-c

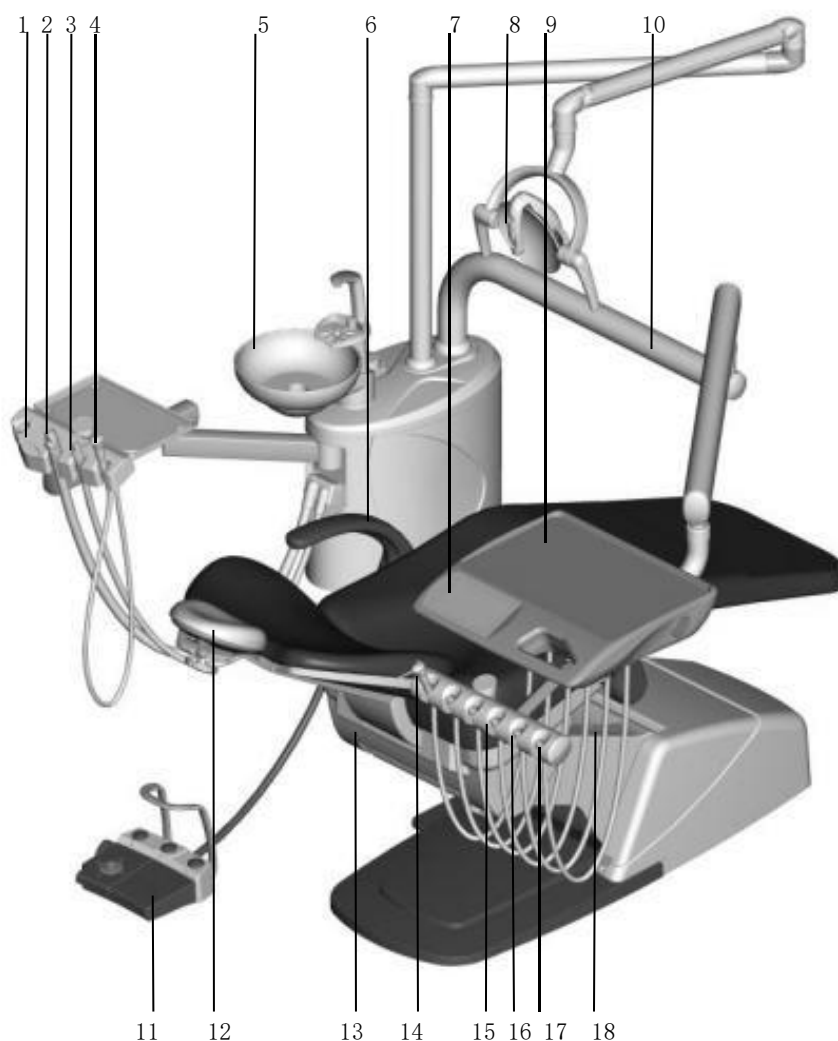

Name of main parts

1	Assistant position operating panel	10	Treatment table balance arm
2	Strong saliva aspirator connection port	11	Foot switch
3	Weak saliva aspirator connection port	12	Headrest
4	Assistant position 3 way syringe	13	Electric dental chair

E9-c/E9-i/E9-t/E9-x/P3-c/P3-i/P3-t Dental Unit Operating Manual

5	Spittoon	14	Treatment table 3 way syringe
6	Armrest	15	Dental low-speed handpiece connection port
7	Treatment table operating panel	16	Dental high-speed handpiece connection port
8	Dental operating light	17	Dental high-speed handpiece connection port
9	Treatment table	18	Power switch

1.2.6 Panorama of P3-i dental unit

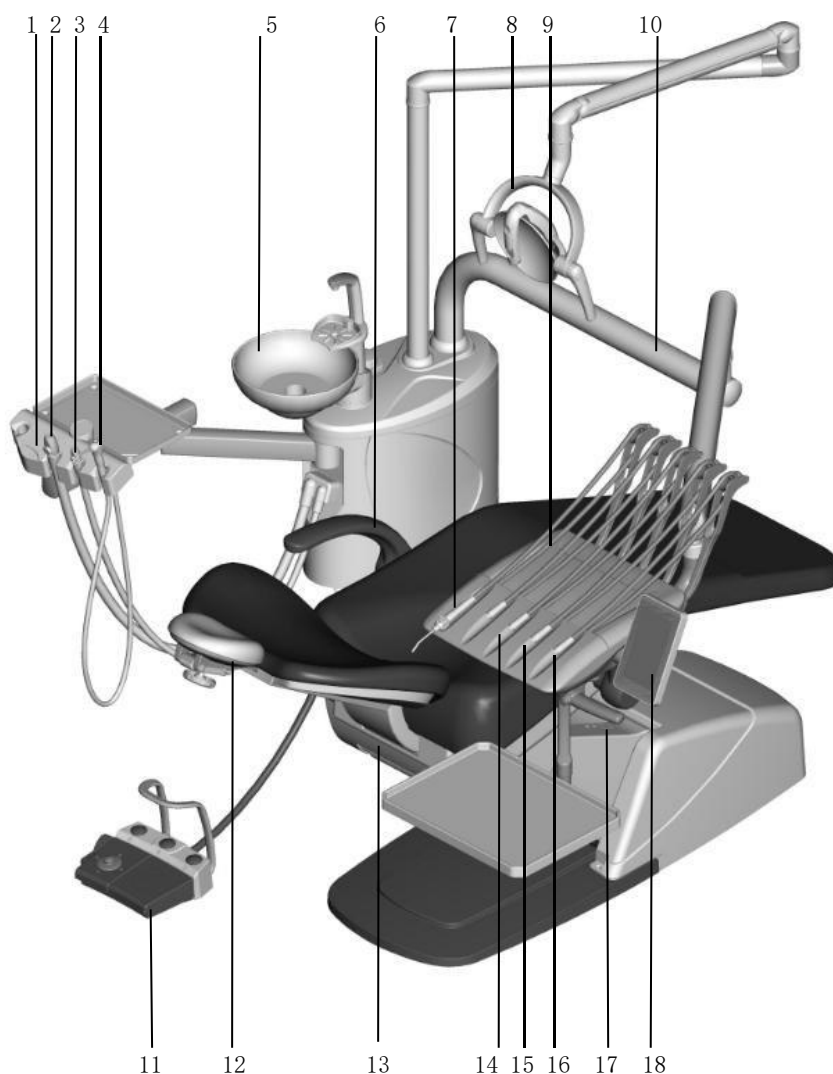

Name of main parts

1	Assistant position operating panel	10	Treatment table balance arm
2	Strong saliva aspirator connection port	11	Foot switch
3	Weak saliva aspirator connection port	12	Headrest (adjustable, detachable)
4	Assistant position 3 way syringe	13	Electric dental chair
5	Spittoon Ceramic (detachable, autoclavable)	14	Electric micromotor (100-40.000 rpm), LED Handpiece 1:1, LED, detachable, max. 40.000 rpm, 3 way cooling, autoclavable

Panorama of dental unit

6	Armrest	15	Dental Turbine (2.5-2.7 bar), Handpiece – 3 way cooling, detachable, push-button, LED, max. 300.000 rpm
7	Treatment table 3 way syringe	16	Ultrasonic Scaler, LED (detachable, autoclavable, 6 tips, 28-31KHz)
8	Dental operating light (3 way adjustable, adjustable angle 4.000-30.000 LUX, cool/neutral light)	17	Power switch
9	Treatment table	18	Treatment table operating panel

1.2.7

P3-t

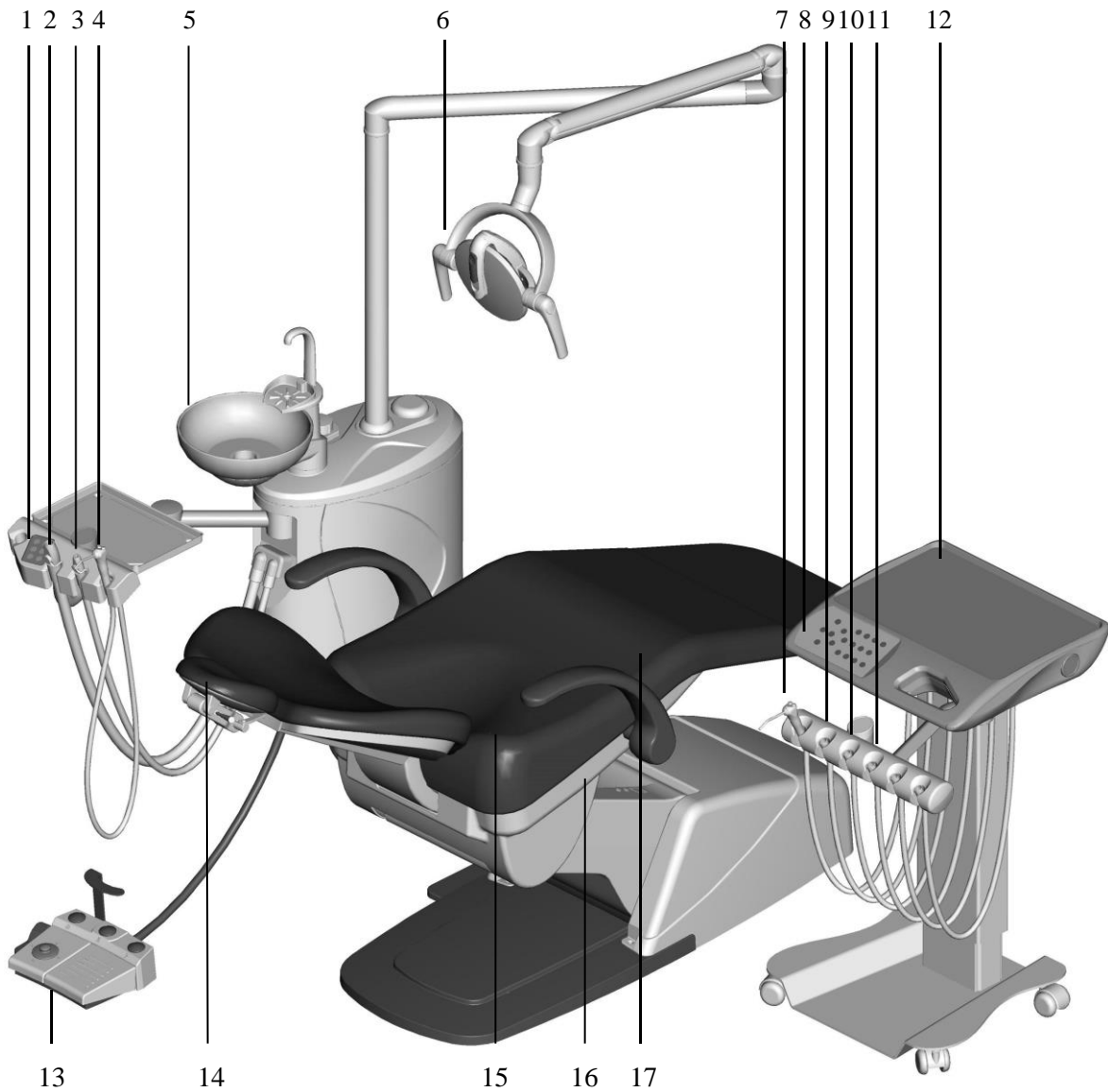

Name of main parts

1	Assistant position operating panel	10	Dental high-speed handpiece connection port
2	Strong saliva aspirator connection port	11	Ultrasonic Scaler (detachable, autoclavable)
3	Weak saliva aspirator connection port	12	Treatment table
4	Assistant position 3 way syringe	13	Foot switch

E9-c/E9-i/E9-t/E9-x/P3-c/P3-i/P3-t Dental Unit Operating Manual

5	Spittoon	14	Headrest
6	Dental operating light	15	Electric dental chair
7	Treatment table 3 way syringe	16	Power switch
8	Treatment table operating panel	17	Armrest
9	Electric micromotor (100-40.000 rpm), LED		

1.2.8 The dental operative unit connected with dental unit

Dental turbine handpiece, dental suction handpiece (Strong saliva aspirator connection port and Weak saliva aspirator connection port) and vacuum pump can be connected with dental unit to use.

Note: dental suction handpiece (Strong saliva aspirator connection port and Weak saliva aspirator connection port) and vacuum pump are not certified by DNV in the IFU.

Note: Please see chapter 4.9 for the recommended Dental turbine handpiece information.

1.2.9 Nameplate

On the seat cover of the electric dental chair, the identification nameplate of the equipment is affixed, and the basic parameters of the product can be seen from the nameplate.

Dental Unit **MODEL: E9-c**

Input: AC230 V 50/60 Hz **Power Consumption:** 900 VA

SN E9-cXXXXXXXX **Safe working load of patient chair:** 150 kg

Operation Mode: Continuous operation with intermittent loading

Duty Cycle For Chair: 2 min ON/18 min OFF

Lifedent (Zhuhai) Co., Ltd.
Address: 3rd floor and 4th floor, Building 3, No.1 Chuangxinyi Road, Tangjiawan Town, Hi-tech Zone, Zhuhai, China

Shanghai International Holding Corp. GmbH (Europe)
 Eiffestrasse 80, 20537 Hamburg, Germany

xx/xxxx



(01) 0697427629XXXX (11) XXXXXX (21) XXXXXXXX

1.2.10 Technical parameters

The technical parameters of this medical equipment are listed in the following table:

Safety class	I	Water hardness limit	Below 2.14 m mol/L (< 12°dH)
Protection type	Type B	Water pH Limit	6.5~8.5
Equipment operating mode	Intermittent operation	Maximum particle size of water	<100 μm
Protection level	Whole machine: common equipment that does not prevent liquid entry; Foot switch: IPX1	Water source requirements	Comply with local drinking water regulations
Power voltage	230 V AC	Water filter aperture	75 μm
Input power	900 VA	Air pressure limit	(0.7±0.1) MPa
Power frequency	50 Hz/60Hz	Air flow rate limit	Above 80 NL/min
Main fuse tube	T10 AL/250 V	Air humidity limit	The dew point is not higher than -20°C under atmospheric pressure
Rated illuminance of dental operating light	8000-35000 Lux	Gas and oil pollution limit	0.5 mg/m ³ max

Panorama of dental unit

Dental operating light voltage	AC 12 V~24 V	Airborne particulate pollution limit	The particle size of 1 μm ~5 μm is not more than 100/ m^3
Heater	AC 24 V 120 W	Gas source requirements	Free from oil, water, bacteria
Water pressure limit	0.2 MPa~0.4 MPa	Air filter aperture	20 μm
Water flow rate limit	Above 5 L/min	Release version of the software	V1.01

Intermittent operation working mode: The longest working time is 2 minutes, and the shortest stop time is 18 minutes.

1.2.11 Normal operations, transportation and storage conditions of the dental unit

Normal operations		Transportation and storage	
Ambient temperature	5 °C ~ 40 °C	Ambient temperature	-40 °C ~ +55 °C
Relative	$\leq 80\%$	Relative	$\leq 93\%$

humidity		humidity	
Atmospheric pressure	70 kPa~106 kPa	Atmospheric pressure	50 kPa~106 kPa

Chapter 2 Description of E9-c/E9-i/E9-t/E9-x Operating Panel, Display and Keys

2.1 Description of the operating panel and operation keys

2.1.1 Illustration of the doctor's main operating panel and assistant position operating panel



E9-c /E9-t/E9-x Main operating panel

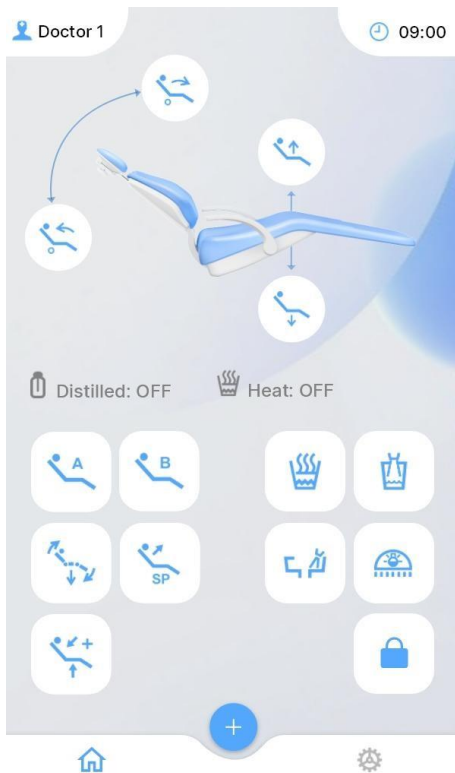



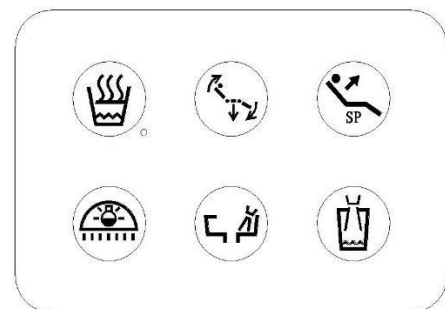



















E9-i Main operating panel



Assistant position operating panel

2.1.2 Description of keys and symbols

Key	Description	Key	Description
	Doctor key		Start key
	Backrest up key		Pause key
	Backrest down key		Terminate key
	Seat up key		Setting key
	Seat down key		General setting button
	A-program position key		ON/OFF key

	B-program position key		Restore to default key
	Emergency program position key		Return key
	Mouth-rinsing program position key		Pipeline disinfection setting key
	Reset program position key		End key
	Optical fiber key		Return to home page key
	Dental operating light key		Confirm key
	Lock key		Rinsing only key
	Spittoon rinsing key		Save key
	Mouth-rinsing water filling key		Electric dental chair setting key
	Mouth-rinsing water heating key		Cup water/spittoon rinsing setting key
	Timer key		Home page key

2.2 Parameter setting and display

2.2.1 Turn on the equipment

After checking the installation and making sure that there are no problems, plug in the power and turn on the power switch. After the self-test is completed, the page on the right will appear:

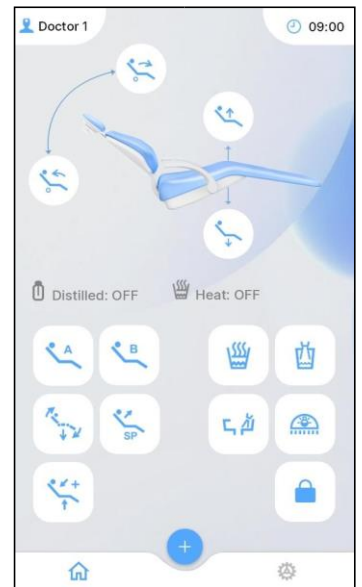
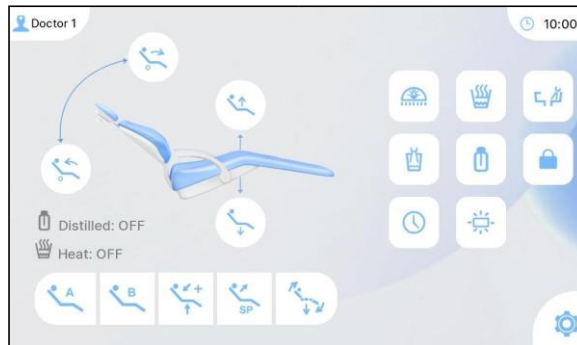

2.2.2 Home page setting 2.2.2.1 Doctor selection

On the home page, you can select three doctors 1, 2, and 3 through the doctor key . The page is as follows:

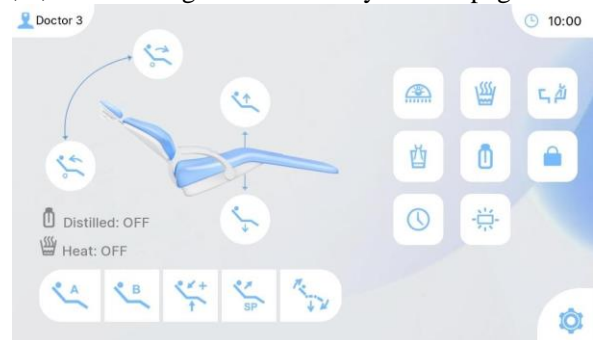
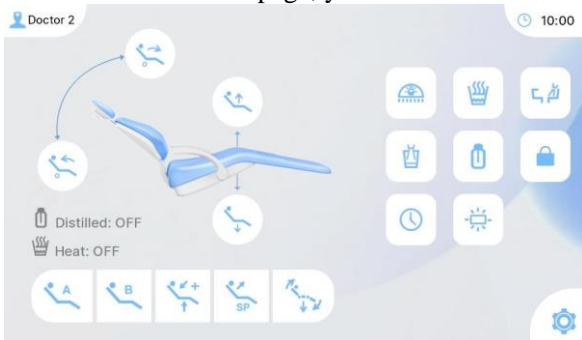

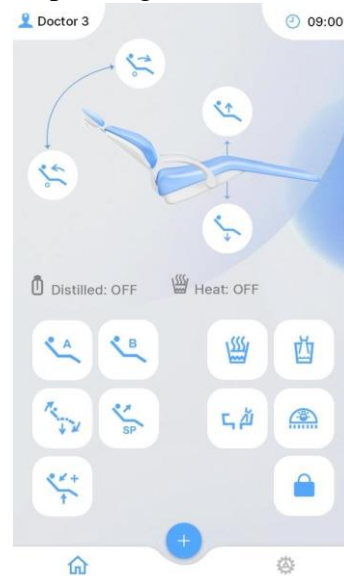
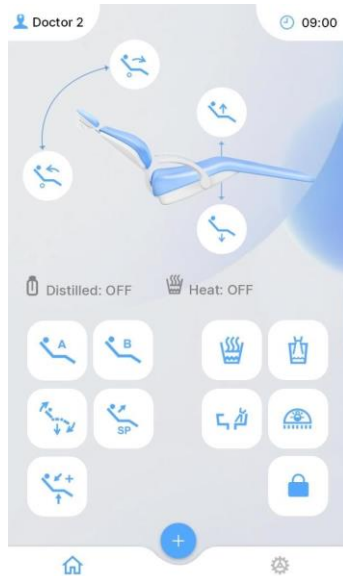

2.2.2.2 Backrest up

On the home page, press and hold the backrest up key , the back of the electric dental chair will move up.

2.2.2.3 Backrest down

On the home page, press and hold the backrest down key , the back of the electric dental chair will move down.

2.2.2.4 Seat up

On the home page, press and hold the seat up key , the seat of the electric dental chair will move up.

2.2.2.5 Seat down

On the home page, press and hold the seat down key , the seat of the electric dental chair will move down.

2.2.2.6 A-program position Operation

On the home page, short-press the A-program position key , the electric dental chair will automatically run to the stored A-program position, and the dental operating light will be turned on simultaneously.



2.2.2.7 B-program position operation

On the home page, short-press the B-program position key , the electric dental chair will automatically run to the stored B-program position, and the dental operating light will be turned on simultaneously.

2.2.2.8 Emergency program position operation

On the home page, short-press the emergency program position key , the electric dental chair will automatically run to the stored emergency program position, and the dental operating light will be turned on simultaneously.

2.2.2.9 Mouth-rinsing position key operation

On the home page, short-press the mouth-rinsing position key , the electric dental chair will automatically run to the stored mouth-rinsing position, and can be linked to spittoon rinsing, mouth-rinsing water, and dental operating light going-out. After completion, press the mouth-rinsing position key  again, the electric dental chair will return to its previous working position, and at the same time, the spittoon rinsing and dental operating light will be linked and turned on.

2.2.2.10 Reset position operation

On the home page, short-press the reset position key , the electric dental chair will automatically run to the stored reset program position, and the dental operating light will be turned off at the same time.

2.2.2.11 Optical fiber operation



When the working equipment with optical fiber is in standby, on the home page, short-press the optical fiber key , the optical fiber signal light is turned on. The icon is displayed in the information display bar in the upper right corner of the

screen. Short-press the optical fiber key again, the optical fiber signal light is turned off, and no icon is displayed in the information display bar in the upper right corner of the screen.

2.2.2.12 Dental operating light operation

On the home page, short-press the dental operating light key , the dental operating light is turned on, and then press this key to turn off.



2.2.2.13 Dental chair key lock operation

When the operator needs to clean and disinfect the dental chair, make the dental chair in the system key lock state, and the operation is as follows. In the state of no operation, short-press the dental chair button lock key , the key icon is in the selected state, and the system enters the key lock state. At this time, all keys are invalid (including the main operation touch key, assistant position touch key, foot switch key, light control sensor, lever switch, etc.). When the dental chair button lock key  is short-pressed again, the key icon is in a non-selected state, then the lock is released and the state before the lock is restored.





2.2.2.14 Spittoon rinsing operation

On the home page, short-press the spittoon rinsing key  to rinse the spittoon once according to the set time, and the icon is displayed in the information display bar in the upper right corner of the screen; or short-press the spittoon rinsing key to stop the spittoon rinsing, and no icon is displayed in the information display bar in the upper right corner of the screen.

2.2.2.15 Mouth-rinsing water filling operation

On the home page, short-press the mouth-rinsing water filling key  to open the mouth-rinsing water filling once according to the set time, and the icon  is displayed in the information display bar in the upper right corner of the screen; or short-press the mouth-rinsing water filling key , the mouth-rinsing water filling will stop, and no icon is displayed in the information display bar in the upper right corner of the screen.



2.2.2.16 Mouth-rinsing water heating operation

On the home page, short-press the mouth-rinsing water heating key  to start heating. During use, the heating display will cycle, and the heating icon  is displayed in the information display bar in the upper right corner of the screen; when the water temperature reaches the standard, the icon  will be always on. When the water temperature does not reach the standard, the icon  flashes at a 1s interval; when it's not heated, no icon is displayed on the screen.

2.2.2.17 Timer operation

On the home page, short-press the timer key  to pop up the timer dialog box as shown on the right:

Use the numeric keypad to set the preset value (1-9999s), press the delete key  to delete a preset value, and press the return key to exit the setting state. After setting, press the confirm key return to the home page, the timing interface will be displayed on the right side of the timer key, and the timing operation can be started:

Press the start/pause key  to start the timing, when the timing expires, the buzzer will sound and the timing will end. If necessary, you can also press the start and pause key  to pause the timing; press the terminate key  to terminate the timing.

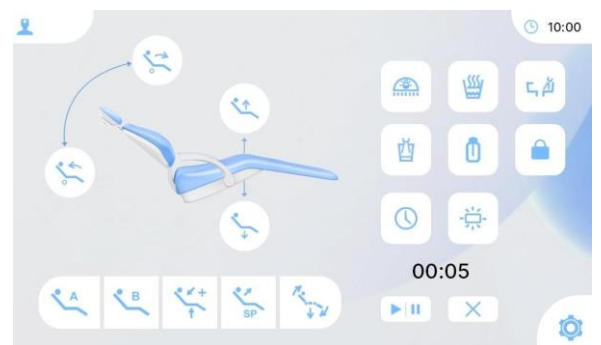
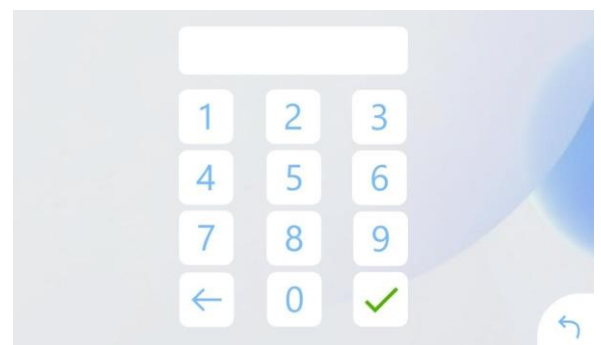

2.2.2.18 Switching between dry grinding and wet grinding of instruments

When the working equipment is in standby, press the left key of the foot pedal to switch between dry grinding and wet grinding. In the wet grinding state, the icon  is displayed in the information display bar in the upper right corner of the screen; in the dry grinding state, on icon is displayed in the information display bar in the upper right corner of the screen.

2.2.2.19 Operation to access the setting page

, and access the setting

Press the corresponding icon in the setting page to access the corresponding setting

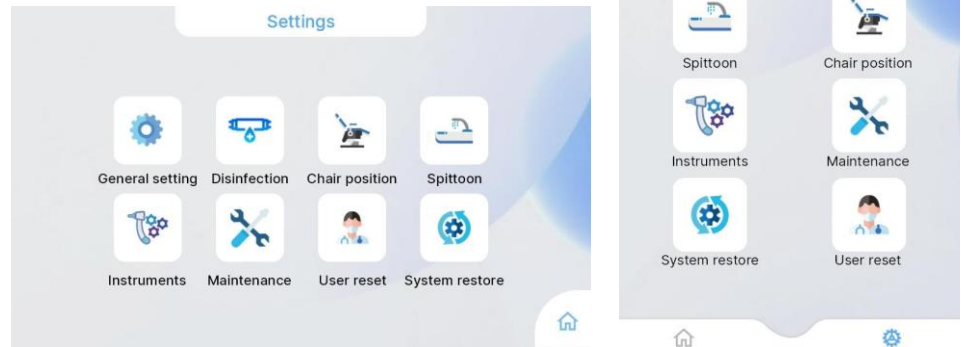



On the home page, select the menu through the setting key page as shown on the right: page.

2.2.3 Setting page settings

2.2.3.1 General setting

On the setting page, press the general setting key  to access the general setting page:

Press the sound ON/OFF key  to the right of the sound icon  to switch the sound.

Press the time value to the right of the clock icon to set the time. Slide the slider on the right side up and down to adjust the

Slide the slider to the right of the language selection icon up and down to select a

to restore the factory settings.

to exit the

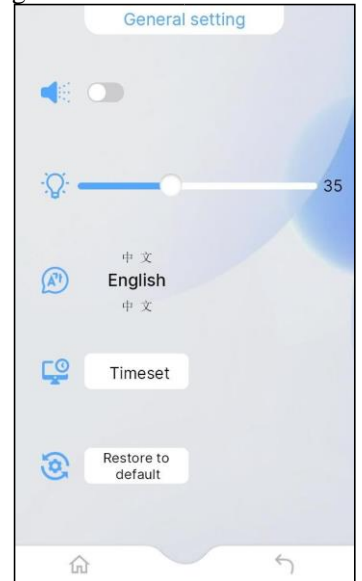
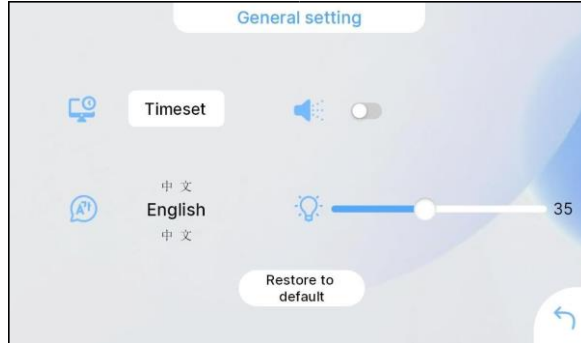

On the setting page, press the pipeline disinfection setting key to access the

to select enhanced disinfection mode and cup water

to start disinfection and start the countdown at the same time. There will be prompts on the page for different disinfection stages (preparation

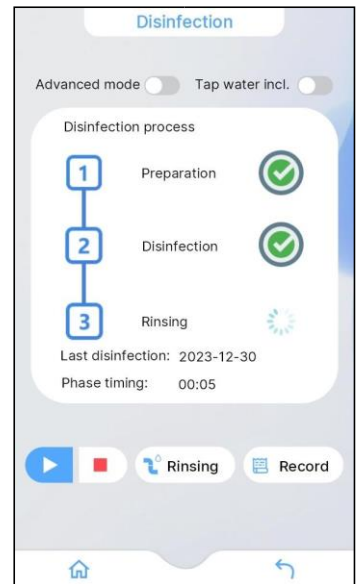
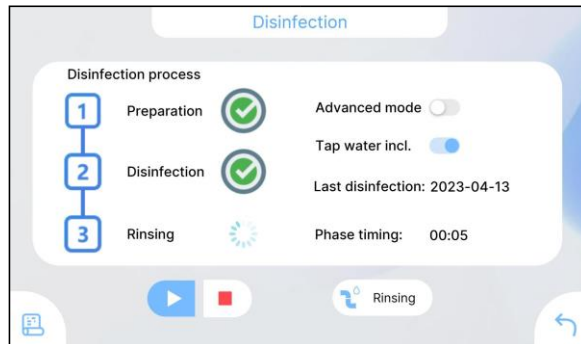

of the brightness icon brightness level (level 10).

language.

Press the restore initial position key

After setting, other options do not need to be set. Press the return key setting state.

2.2.3.2 Pipeline disinfection setting

pipeline disinfection setting page:

Press the ON/OFF key disinfection.

Press the start disinfection key



stage, disinfection stage and rinsing stage).

When the disinfection is completed, it will automatically access complete page:

Press the key  page to return to the setting page.

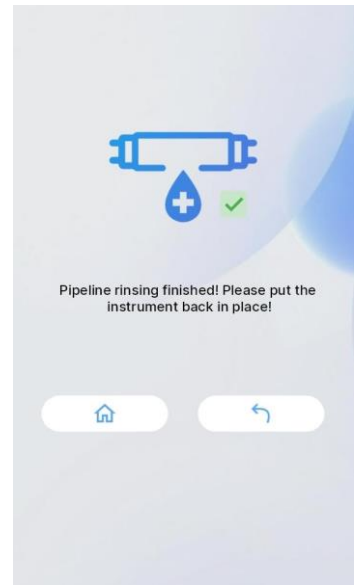
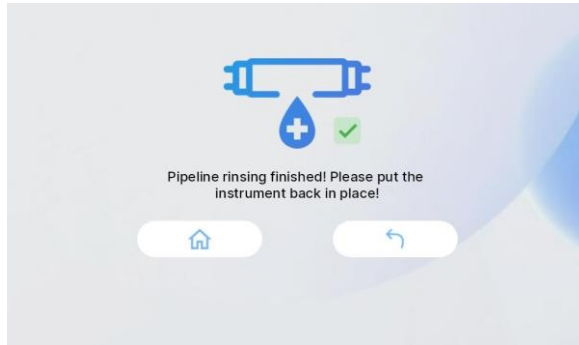
the disinfection to return to the home page; press the key  to return to the setting



you can press the abort program key  to
 ✓ to terminate the disinfection; press the return key  to

During the disinfection process, automatically access the abort page: Press the confirm key continue disinfection and return to the pipeline disinfection page.

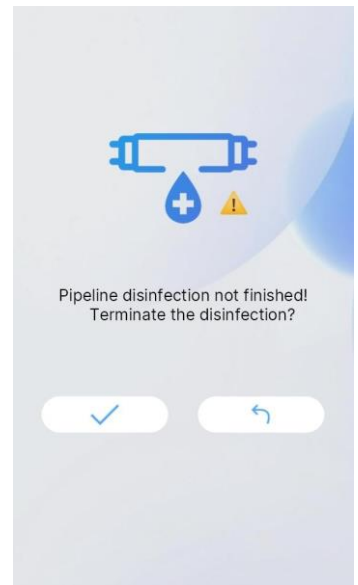
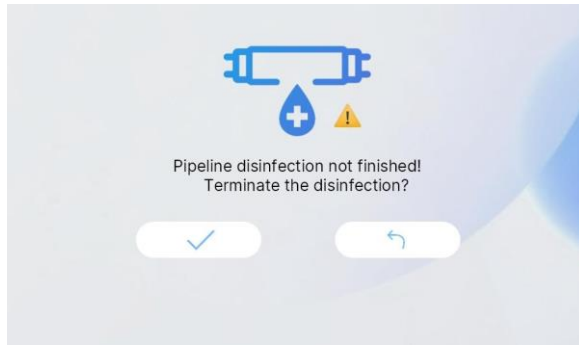

 in the
 ✓ to execute the rinsing procedure of the pipeline; press the





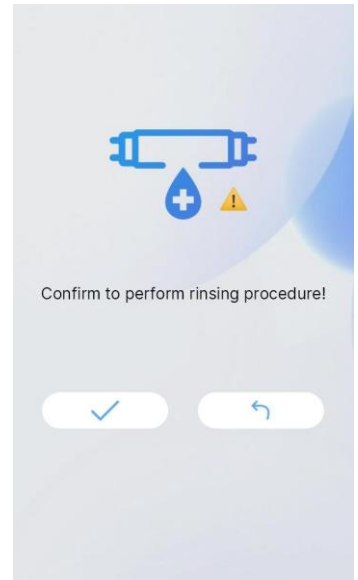
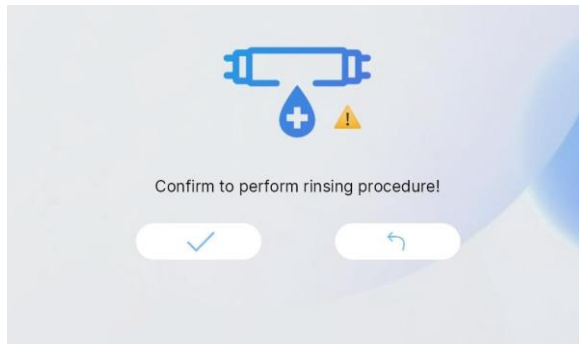

When the disinfection is not started, you can press the rinsing only key pipeline disinfection setting page to access the pipeline rinsing page:

Press the confirm key return key  to return to the pipeline disinfection page.



2.2.3.3 Electric dental chair setting

On the setting page, press the electric dental chair setting key  to access the electric dental chair setting page: 5 kinds of program position memory settings can be performed:

A-program position setting: manually adjust the keys , ,  and  of the electric dental chair to run to the required treatment position, and the key  to the right of the icon of A-program position will store the current chair position in the program memory position A; Press the restore initial position key  to restore the A-program position to the initial

B-program position setting: the same as the A-program position.

Emergency program position setting: the same as the A-program position.

Mouth-rinsing position key setting: the same as the A-program position.

Reset program position setting: the same as the A-program position.

After setting, other options do not need to be set. Press the return key  to exit the setting state.

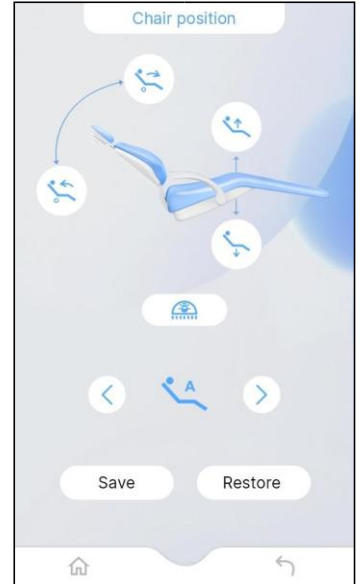

2.2.3.4 System reset setting

On the setting page, press the system reset setting key  to enter the system restore setting page:

Press the confirm execution key  to remove all personal settings of the doctor and other information recorded by the equipment.

After setting, other options do not need to be set. Press the return key  to exit the setting state.

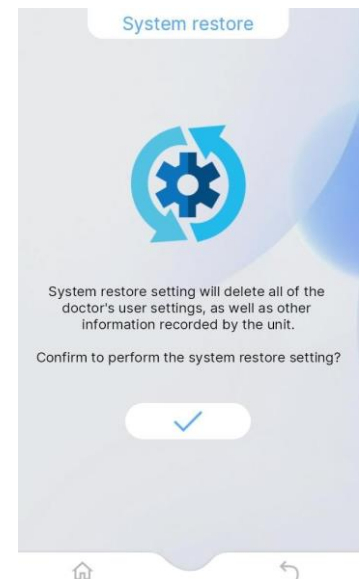
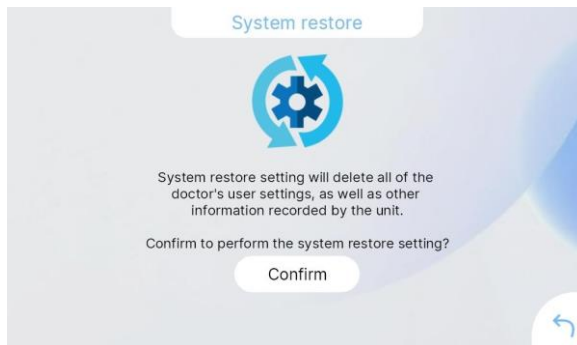

2.2.3.5 Cup water filling/spittoon rinsing setting

On the setting page, press the cup water filling/spittoon rinsing setting key  to access the cup water filling/spittoon position. rinsing setting page:

The sliding bar on right side of upper/lower cup water filling time and spittoon rinsing time can adjust the cup water time and spittoon rinsing time (1-60s).

Press the ON/OFF key  on the right side of mouth-rinsing position/cup water filling linkage, mouth-rinsing position/spittoon filling linkage and cup water filling/spittoon flush linkage to set the mouth-rinsing position/cup water filling linkage, mouth-rinsing position/spittoon filling linkage and cup water filling/spittoon filling linkage.

After setting, other options do not need to be set. Press the return key  to exit the setting state.

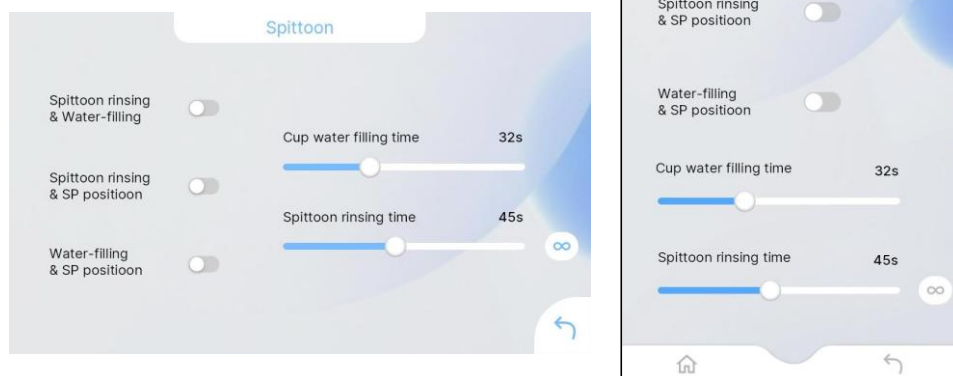

2.2.3.6 Distilled water selection

On the setting page, press the ON/OFF key on the right side of the distilled water bottle icon  to select distilled water as the water supply for the dental unit.

After setting, other options do not need to be set. Press the home page key  to exit the setting state and return to the home page.

2.2.4 Seat protection function

When the electric dental chair is lowered, the bottom of the electric dental chair will automatically stop when it encounters resistance, and the electric dental chair will rise slightly. The icon  E01 is displayed in the information display bar in the upper right corner of the screen.

2.2.5 Backrest protection function

When the electric dental chair descends or the backrest descends, the backrest will automatically stop when it encounters resistance, and the electric dental chair will rise slightly. The icon  E02 is displayed in the information display bar in the upper right corner of the screen.

2.2.6 Communication exception display





When the communication between the main operation control panel and the treatment table control panel is abnormal, the icon  E04 is displayed in the information display bar in the upper right corner of the screen.

2.3 Assistant position operating panel operation



2.3.1 Dental operating light operation

Short-press the dental operating light key  to turn on the dental operating light, then press this key again to turn off.



















2.3.2 Mouth-rinsing water heating operation

Short-press the mouth-rinsing water heating key  to start heating. During use, the heating display will cycle, and the heating icon  is displayed in the information display bar in the upper right corner of the screen; when the water temperature reaches the standard, the icon  will be always on, and the heating indicator next to the assistant position heating key will always be on. When the water temperature does not reach the standard, the icon  flashes at a 1 s interval, and the heating indicator next to the assistant position heating key flashes; when it is not heated, no icon is displayed on the screen, and the heating indicator next to the heating key in the assistant position goes out.

2.3.3 Mouth-rinsing position key operation

Short-press the mouth-rinsing position key  _{SP}, the electric dental chair will automatically run to the stored mouth-rinsing position, and can be linked to the spittoon rinsing, mouth-rinsing water, and the dental operating light going-out. After completion, press the mouth-rinsing position key  _{SP} again, the electric dental chair will return to its previous working position, and at the same time, the spittoon rinsing and dental operating light will be linked and turned on.

3.1.2 Description of keys and symbols

Key	Description	Key	Description
	1-doctor key		Mouth-rinsing position key
	2-doctor key		Emergency position key
	3-doctor key		Setting key
	Seat up key		Mouth-rinsing water heating key
	Seat down key		Disinfection key
	Backrest up key		Reset position key
	Backrest down key		Dental operating light ON/OFF key
	A-program position key		Mouth-rinsing water filling key
	B-program position key		Spittoon rinsing key

3.2 The operation of the treatment table and the assistant position key panel and the function key memory setting

3.2.1 Doctor selection

Short-press the 1-doctor  key, the A-doctor indicator is always on.

Short-press the 2-doctor  key, the B-doctor indicator is always on.



Short-press the 3-doctor  key, the C-doctor indicator is always on.

3.2.2 Lifting operation method of electric dental chair

Press and hold the seat up key  on the operating panel, the seat of the electric dental chair will move up.

Press and hold the seat down key  on the operating panel, the seat of the electric dental chair moves down.

3.2.3 Electric dental chair backrest lift

Press and hold the backrest up key  on the operating panel, the backrest of the electric dental chair moves up. Press and hold the backrest down key  on the operating panel, the backrest of the electric dental chair moves down.



3.2.4 Memory setting and operation method of program positions



A-program position setting: run the electric dental chair to the desired treatment position, long-press the A-program position key  for about 5s, and when you hear the prompting sound, the current chair position has been stored in the program memory position A.

A-program position operation: Short-press the A-program position key , the electric dental chair will automatically run to the stored A-program position, and the dental operating light will be turned on simultaneously. B-program position setting and operation: the same as A.

3.2.5 Mouth-rinsing position key setting

Setting of mouth-rinsing position: Run the electric dental chair to the required mouth-rinsing position, long-press the mouth-rinsing position key  for about 5 s, and when you hear the prompting sound, the current chair position will be stored in mouth-rinsing memory position.

Mouth-rinsing position and spittoon linkage selecting and setting: Press the setting key  for about 5s, and the indicator flashes. Then press the mouth-rinsing position key , and the indicator goes out when you hear the prompting sound, which not only sets the switching operation when the chair moves and the cup is flushed.

Mouth-rinsing position operation: Short-press the mouth-rinsing position key , the electric dental chair will automatically run to the mouth-rinsing memory position, and can be linked to the spittoon rinsing, mouth-rinsing water, and the dental operating light going-out. After completion, press the mouth-rinsing position key  again, the electric dental chair will return to its previous working position, and at the same time, the spittoon rinsing and dental operating light will be linked and turned on.

3.2.6 Emergency position setting

Emergency position setting: run the electric dental chair to the required emergency position, long-press the emergency position key  for about 5s, and when you hear the prompting sound, the current chair position has been stored in the emergency memory position.

Emergency position operation: Short-press the emergency position key , the electric dental chair will run to the emergency position, and the dental operating light will be turned on at the same time.

3.2.7 Mouth-rinsing water heating key operation

Short-press the mouth-rinsing water heating key , the heating indicator flashes; when the mouthwash is heated to the set temperature, the heating indicator is always on, which means the heating is completed. The heating indicator will cycle during use.

3.2.8 Disinfection key operation

Short-press the disinfection key , the disinfection indicator flashes, and when the disinfection is completed, the disinfection indicator is always on.

3.2.9 Reset position setting

Reset position setting: run the electric dental chair to the desired reset position, long-press the reset position key  for 5s, and when you hear the prompting sound, the current chair position has been stored in the reset memory position.



Reset operation: Short-press the reset key , the electric dental chair will run to the reset position, and the dental operating light will be turned off at the same time.



3.2.10 Dental operating light ON/OFF key setting

Operation of the dental operating light ON/OFF key: Short-press the dental operating light ON/OFF key  to turn on the dental operating light, then press this key to turn off.



Long-press the dental operating light ON/OFF key  for 5 seconds, after hearing the buzzer sound, the key sound function is turned off, and the same operation is performed again, and the key sound function is turned on.

3.2.11 Mouth-rinsing water filling key setting

Mouth-rinsing water volume setting: Press the setting key  for about 5 s, and the indicator flashes. Short-press the Mouth-rinsing water filling key, the  mouth-rinsing water will reach the desired water volume. Then, short-press the mouth-rinsing water filling key for  stopping, the indicator will go out, and the setting is completed.

Mouth-rinsing water filling key operation: Short-press the mouth-rinsing water filling key  to turn on the mouth-rinsing water filling, and then short-press the mouth-rinsing water filling key  to stop.

3.2.12 Spittoon rinsing setting

Setting of the rinsing time: press the setting key  for about 5 seconds, the indicator will flash; short-press the spittoon rinsing key , the rinsing time reaches the desired time, and then short-press the spittoon rinsing key  to stop, the indicator will turn off, the setting is complete.

Rinsing operation: Short-press the spittoon rinsing key  to rinse the spittoon once according to the set time, or short-press again to stop rinsing.

Chapter 4 Equipment Operation Instructions

 **Warning:** Before proceeding in accordance with the contents of this chapter, please confirm that the installation and commissioning are completed properly according to the equipment installation and maintenance manual.

4.1 Power switch operation

Turn on the power switch to I, the green indicator is on, the equipment will be on.



4.2 Dental operating light operation

4.2.1 LED dental operating light operation

The handle of the dental operating light can change the angle according to the user's request.

The effective sensing range of the dental operating light is 50 mm-120 mm. Put your hand close to the sensor and let go after 0.5 second, the light can be turned on/off.

When the light is on, put your hand close to the sensor. The illuminance will go from low to high with 5 levels, and then changes from high to low in a cycle. Take your hand away when it reaches the desired level.

The light with color temperature adjustment function. Use your hand to touch the touch button to adjust color temperature among three levels of cold, cold and warm, warm. The color temperature set when the hand left the equipment will be constant.

The dental operating light has blue cut-off function. While using photosensitive resin to fill the teeth, adjust color temperature to the warm light, and the light of the dental operating light will turn to yellow which can prevent fast curing of photosensitive resin. At a regular oral surgery, please adjust color temperature to the suitable level.

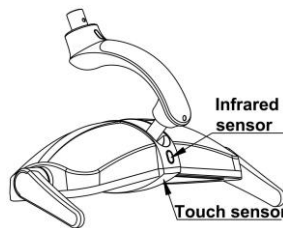

4.2.2 Installation and removal of dental operating light handle

Installation of the V5 dental operating light handle cover: Hold the light with the right hand->Hold the left handle cover with the left hand-> Insert the handle cover to the handle and push up, the handle button is stuck on the handle cover, then release the handle cover. Install the right handle following the same method.

Disassemble of V5 dental operating light handle cover: Hold the light with the right hand->Hold the left handle cover with the left hand. Press the handle button with the thumb ->Pull out the handle cover. Disassemble the right handle following the same method.

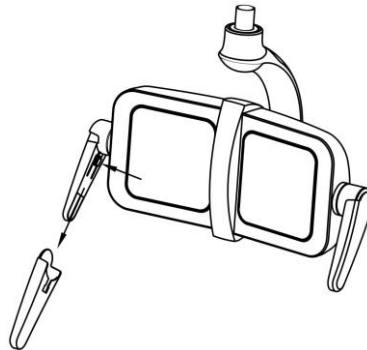

4.3 Foot switch operation

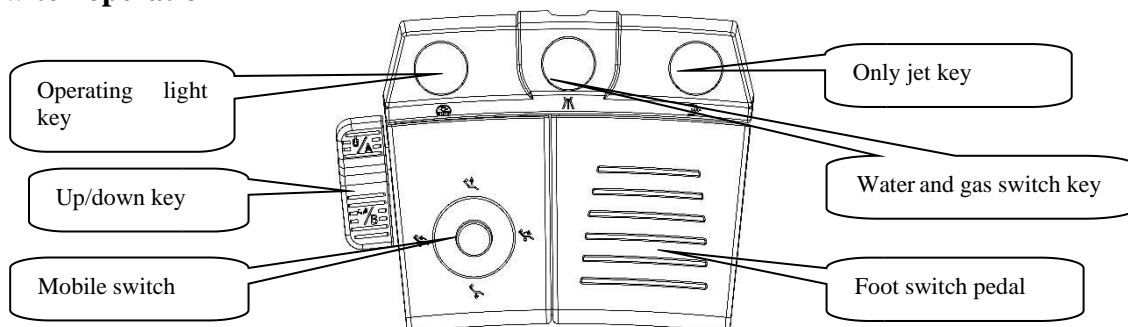

Dental operating light key operation: Short-press the dental operating light ON/OFF key, the dental operating light is turned on, and then press this key to turn off.

Water and gas switch key operation: Short-press the key to switch between dry grinding and wet grinding.

Single jet key operation: Press the key for the dynamic instrument to jet only; release the key, the jet stops.

Up key operation: Short-press the up key to add water to the mouth rinsing, the mouth-rinsing water is turned on, and then short press the mouth-rinsing water filling key to stop. Long-press (about 2 seconds) to hear the "beep" buzzer sound for the A-program position.

Down key operation: Short-press the key for the rinsing function, rinsing the spittoon once according to the set time, or short-press the key again to stop rinsing. Long-press (about 2 seconds) to hear the "beep" buzzer sound for the B-program position.

Mobile switch operation: Toggle the chair position mobile switch to control the rise and fall of the electric dental chair; the backrest rises and falls.

Foot switch pedal: move from top to bottom to control the gradual increase in the working speed or power of dynamic instruments.

Handle operation: You can use your feet to lift the handle to move the foot switch.

4.4 Operation of treatment table balance arm height

Hold the handle with your right hand and press the left air brake button with your thumb. Move the handle up and down to the desired position, release the air brake button, it can be fixed in this position.



4.5 Instrument tray operation

The weight of the instrument tray must not exceed 3 kg. The pull-up instrument tray can be rotated 180°.

4.6 Pull-up treatment table pull rod operation

Pick up the dynamic machine, pull it back, and the dynamic machine will work.

After the work is completed, the dynamic instrument is sent back forward to make the dynamic instrument return to its initial position.

4.7 Operation of the headrest

Rotate the headrest locking handle counterclockwise for 1-2 turns, so that the headrest can be moved freely.

Adjust the headrest to the desired position, move the headrest to the lower end of the backrest when treating children, and then lock the handle clockwise.



4.8 3 way syringe operation (0°, 45° or 90°)

Press the water control button to spray water, press the gas control button to spray gas, and press both buttons at the same time to mist.

Press the disassembly ring to remove the nozzle, which can be sterilized at 135°C.



4.9 Operation when used with dental handpieces

Dental handpieces should be purchased and used by professional doctors at their discretion. Dental handpieces that meet the requirements of national standards and have obtained the registration certificate of Class II medical equipment should be used. Refer to the manufacturer's instructions for specific use of the dental handpiece.

Dental handpiece operation: Pick up the dental handpiece, operate the foot switch, and the dental handpiece can work.

The air pressure of the dental handpiece can be adjusted through the regulating valve under the treatment table, and the air pressure is adjusted clockwise to decrease and anticlockwise to increase.



The recommend dental instrument see following table:

Name	Model/specification	Manufacturer
Dental turbines	THALIA	TEKNE DENTAL SRL

4.9.1 Dental low-speed handpiece connection port

The dental unit provides a set of control dental low-speed handpiece system. Users need to use a handpiece that matches it. When the air intake is 250 kPa, the no-load speed is not less than 14000 r/min.



Pressure gauge

4.9.2 Dental high-speed handpiece connection port

The dental unit provides a high-speed handpiece system for controlling the dental system. The user needs to use a handpiece that matches it. When the air intake is 250 kPa, the no-load speed is not less than 300,000 r/min.

The air pressure of the dental handpiece can be adjusted through the corresponding regulating valve under the treatment table, and the air pressure is adjusted clockwise to decrease and anticlockwise to increase.

4.9.3 Dynamic instruments water volume adjustment

The water volume adjustment of the dental handpiece can be adjusted through the regulating valve under the treatment table, clockwise to reduce the water pressure and anticlockwise to increase. The regulating valve and dynamic instruments are in one-to-one correspondence.



Handpiece water

4.9.4 Dynamic instruments spray volume adjustment

To adjust the spray volume of the dental handpiece, it can be adjusted through the regulating valve under the treatment table, clockwise to reduce and anticlockwise to increase. This mist regulating valve is common to all dynamic instruments.



Handpiece fog adjustment

4.10 Strong saliva aspirator operation

The inner diameter of the strong saliva aspirator handle is 11 mm, and it needs to be used with a strong saliva aspirator pipe connector with an outer diameter of 11 mm.

The detailed

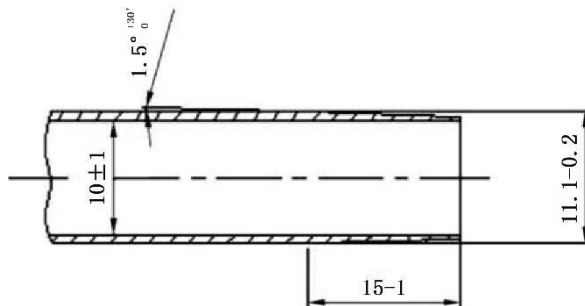

dimensions are as follows (unit mm):

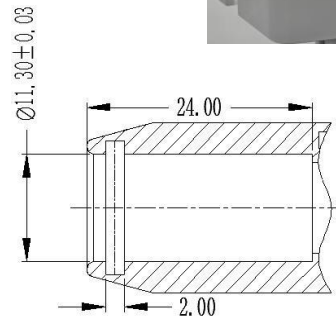

Strong saliva aspirator pipe connector

Remove the strong suction handle, the strong saliva aspirator system starts to work, and the handle adjustment push rod will adjust the saliva flow.

When the strong saliva aspirator handle is returned to the shelf, the strong saliva aspirator system will stop after a delay of approximately 3 seconds. This delay will keep the strong saliva aspirator pipeline hygienic. (This function is only available for E9-c, E9-i, E9-t, E9-x).

Under static (i.e. no flow) conditions, the maximum vacuum pressure provided to the dental unit at the strong saliva aspirator connection port is 25kPa

Strong saliva aspirator handle

4.11 Weak saliva aspirator operation

The inner diameter of the weak saliva aspirator handle is 6.8 mm, and it needs to be used with a weak saliva aspirator pipe connector with an outer diameter of 6.8 mm. The detailed dimensions are as follows (unit mm):

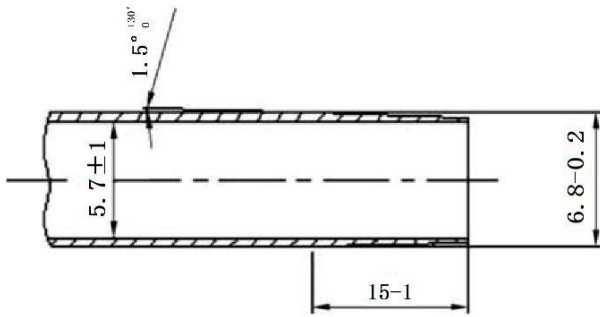

Weak saliva aspirator pipe connector

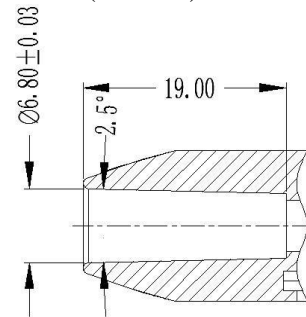

Weak saliva aspirator handle

Remove the weak saliva aspirator handle, and the weak saliva aspirator system starts to work.

When the weak saliva aspirator handle returns to the shelf, the weak saliva aspirator system stops.

Under static (i.e. no flow) conditions, the maximum vacuum pressure provided to the dental unit at the weak saliva aspirator connection port is 15kPa.

4.12 Distilled water system operation

The distilled water system consists of a distilled water bottle and a selecting switch located at the lower end of the rear of the side box. Water for all dynamic instruments on the treatment table and assistant position comes from distilled water in a distilled water bottle or filtered tap water. Therefore, medical distilled water must be added to the distilled water bottle in time. The water-filling method is:

1) Pull the gas switch of the distilled water bottle to the pressure relief position and wait until the pressure gas in the distilled water bottle is exhausted.

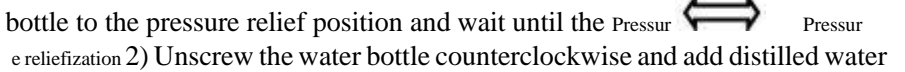

2) Unscrew the water bottle counterclockwise and add distilled water to the maximum limit.

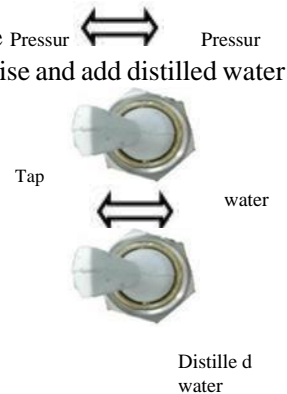

3) Tighten the distilled water bottle clockwise, put it back, and turn on the gas switch of the distilled water bottle and the water change-over key or switch.

⚠Caution:

The distilled water bottle can only be opened after the gas in the distilled water bottle is exhausted.

It is recommended to use medical distilled water in the treatment to prevent impurities in the tap water from affecting the service life of the pipeline and working equipment of the whole machine.



To screw off the bottle, hold the lid with left hand and screw the bottle with right hand. Do not screw the lid, otherwise the air and water pipes connected to it will be damaged

4.13 Pipeline disinfection system operation

Turn the pressurizing and depressurizing switches to the depressurizing position, fill up the distilled water bottle and the disinfectant bottle respectively, and then turn the switch back to the pressurizing position.

Remove each instrument head and clean or disinfect it individually, following the manufacturer's instructions.

Place the disinfection tray on the spittoon, remove all dynamic instrument pipelines on the treatment table shelf, and insert them into the corresponding positions of the disinfection tray; place the disinfection water filling cup holder.

Press the start disinfection key  or the disinfection key  on the control panel to start disinfection. For specific operations, see 2.2.3.2 or 3.2.8.



⚠Warning:

Before disinfection begins, if there is any dynamic instrument pipeline on the shelf, it must be removed and inserted into the corresponding position of the disinfection tray; After disinfection is started, it is forbidden to carry out other irrelevant operations such as putting the dynamic instrument pipeline back on the shelf, pressurizing and depressurizing, etc!

When prompted to complete the disinfection, put all dynamic instrument pipelines back on the initial treatment table shelf.

Remove the disinfection tray from the spittoon, remove the disinfection cup holder from the cup water filling cup holder, and the whole disinfection process is completed.

⚠Caution:

Disinfectants should not remain in the treatment table for more than 30 minutes (for example, not for more than one night or for an entire weekend).

4.14 Security function

When the electric dental chair is moving down, the bottom of the electric dental chair will automatically stop when it encounters obstacles, and it will rise slightly. Accompanied by buzzer 'beep' alarm sound. The customer must move the obstacles out of the way to release it. (Users cannot adjust by themselves)

When the electric dental chair is moving down or the backrest is moving down, the backrest will automatically stop when it encounters obstacles. Accompanied by buzzer 'beep' alarm sound. The customer must move the obstacles out of the way to release it. (Users cannot adjust by themselves)

When the dental handpiece stops working, the spray gas is delayed for about 2 seconds to form an automatic anti-sucking function, which can effectively prevent cross infection. (This function is only available for E9-c, E9-i, E9-t, E9-x).

When the electric dental chair is in motion, press any key to stop the movement.

When the instrument is working, the electric dental chair is in a working protection state, and all movements are stopped.

When the first dynamic instrument is in the working state, all other dynamic instruments cannot be activated. This internal locking state allows the bur to be replaced when another instrument is used. (Only available to E9-c, E9-i, E9-t, E9-x).

Chapter 5 Maintenance, Servicing, Cleaning and Disinfection of Equipment

5.1 Description of disinfection and sterilization

Disinfection: After the pipeline system of this product is used, users can use hydrogen peroxide for disinfection. The prepared disinfectant hydrogen peroxide with concentration of 3% is used to continuously wash the pipeline for 2 minutes. After standing for 30 minutes, it is washed with clear water for 5 minutes and dried overnight. The pipeline system shall be disinfected once a day. See 4.14 for specific operation methods. Parts that are often touched by doctors, nurses and patients outside the equipment should be wiped and disinfected with alcohol or neutral disinfectant on clean gauze once a day. Please refer to the corresponding operating manual of disinfectant for use.

Sterilization: Sterilization of the 3-way syringe nozzle in this product: it can be cleaning and sterilized as following method:

Syringe nozzle cleaning

1) Rinsing

Using daily drinking water rinsing with a brush, removal of organic residues on the 3 way Syringe. then perform disinfectant soaking.

2) Disinfectant soaking

Disinfectant: Medical alcohol.

Put the rinsed equipment on medical utensils, Pour into medical alcohol, the 3-way Syringe nozzle. should be submerged medical alcohol, soak for 10 minutes, then scrub the surface of the 3-way Syringe nozzle with the brush. in the end perform end rinsing.

3) End rinsing

With purified water or distilled water to flush, Clean the residual alcohol. Since then, it can be used to sterilization. The 3-way Syringe nozzle has to clean after each use.

The Maximum clean times: 250

Syringe nozzle sterilization 1)Syringe loading:

Put 3-way Syringe nozzle samples into heat-sealing sterilization pouches. The 3-way Syringe nozzle were placed in trays, then transferred to sterilizer cavity. 2)Moist heat sterilization:

Sterilization temperature: 134°C.

Sterilization time: 4 minutes.

Drying time: 15 minutes.

Pressure: 2.1 bar.

The Syringe has to sterilization after each use. The

Maximum sterilization times:250

The detailed sterilization method of dental handpieces shall be implemented according to the manufacturer's instructions.

5.2 Cleaning of the saliva aspirator pipeline and filter

Remove the strong/weak saliva aspirator handle from the assistant position shelf, and then pull out the saliva aspirator connection pipeline from the saliva aspirator filter to remove the cleaning accessory.

Pull out the filter screen from the filter and pour out the dirt in the filter. Note that the dirt in the filter needs to be handled centrally and must not be discarded arbitrarily.

Connect the strong and weak saliva aspirator handle to the tube, rinse the filter with clean water, and can be used for disinfection.

Connect the strong and weak saliva aspirator handle to the pipe and install the filter back to its initial position. Once a day is recommended.



5.3 Cleaning of the spittoon

Take out the spittoon decorative cover and filter screen in the spittoon basin, and pour out the dirt in the filter screen. Note that the dirt needs to be handled centrally and should not be discarded arbitrarily. Rinse with clean water to clean it up for detoxification.

Just install the decorative cover and the filter screen back to their initial positions, it is recommended to use it once a day. The hole diameter of the filter screen is 2 mm.

5.4 Cleaning of the return gas bottle

Unscrew the return gas bottle counterclockwise, remove the dirt in the bottle, and clean the sound-absorbing sponge.

Turn the gas bottle clockwise and screw it back to its initial position.



5.5 Other cleaning

The surface and the upholstery can be cleaned with special chemical solution recommended for this intend. Please check the Instruction for use of the pproduct before applying.

⚠Caution: Please do not use abrasives or acidic products.

5.6 Maintenance and servicing of equipment

⚠Caution: The correct maintenance method can extend the life of the equipment!

Users should regularly maintain and replace accessories that are prone to aging (such as dental handpieces).

Change the disinfectant bottle once a year.

Check the power voltage every month, the water pressure and air pressure must meet the working requirements of the machine, and the pipeline must be unblocked. The running parts of the electric dental chair are flexible and the control keys are sensitive.

Wash distilled water bottles once a week with a bottle brush and neutral soapy water.

After use every day, the spittoon should be cleaned, the filter should be rinsed with water and the saliva suction filter should be pulled out.

For cleaning and maintenance of the dental handpiece, refer to the operating manual for dental handpieces.

Water filter: In order to ensure the normal operation of the machine, a water filter is installed at the water inlet of the machine to block impurities in the water. After working for a long time, the dirt will block the filter element and affect the water flow. At this time, the normal operation must be restored by cleaning or replacing the filter element.

Under normal circumstances, the filter element should be cleaned or replaced in one of the following situations:

- (1) The use time is more than one year;
- (2) The filter element is contaminated;
- (3) The water becomes cloudy;

The specific method of replacing the filter is: open the side box, remove the water filter, remove the filter housing in a counterclockwise direction, remove the sealing ring and the filter element in turn, clean or replace it, and then install it, and pay attention to sealing.

Chapter 6 Installation, Commissioning and Maintenance of Dental Unit

6.1 Installation conditions

⚠ Caution: The installation of this equipment must be completed by the company's professional personnel or personnel trained and authorized by the company.

This equipment shall be placed in a clean, dry, ventilated and shaded place. Retain enough space around the equipment for routine maintenance.

Do not install and use the equipment in the following places:

- A. Humid, dusty or poorly ventilated places or places in direct sunlight;
- B. Places where changes in high temperatures or high humidity often occur, e.g., places near air conditioners and heaters;

⚠ Caution: Improper installation may damage the equipment!

6.2 Installation site requirements

Determine the installation location according to the overall layout of the clinic room, lighting, use convenience and other specific circumstances. The machine shall be placed in a clean, dry, ventilated and cool place to keep it in a good operating environment. And ensure that the ground contacted by the base plate of the electric dental chair must be a flat, level and solid ground. The weight of this unit is about 228 kg (the weight of the electric dental chair is about 149 kg).

Standard layout of dental unit:

It is a single-person operation size, and does not include auxiliary equipment size in the clinic. If you need four-handed operation, add auxiliary equipment, please increase the size according to actual requirements.

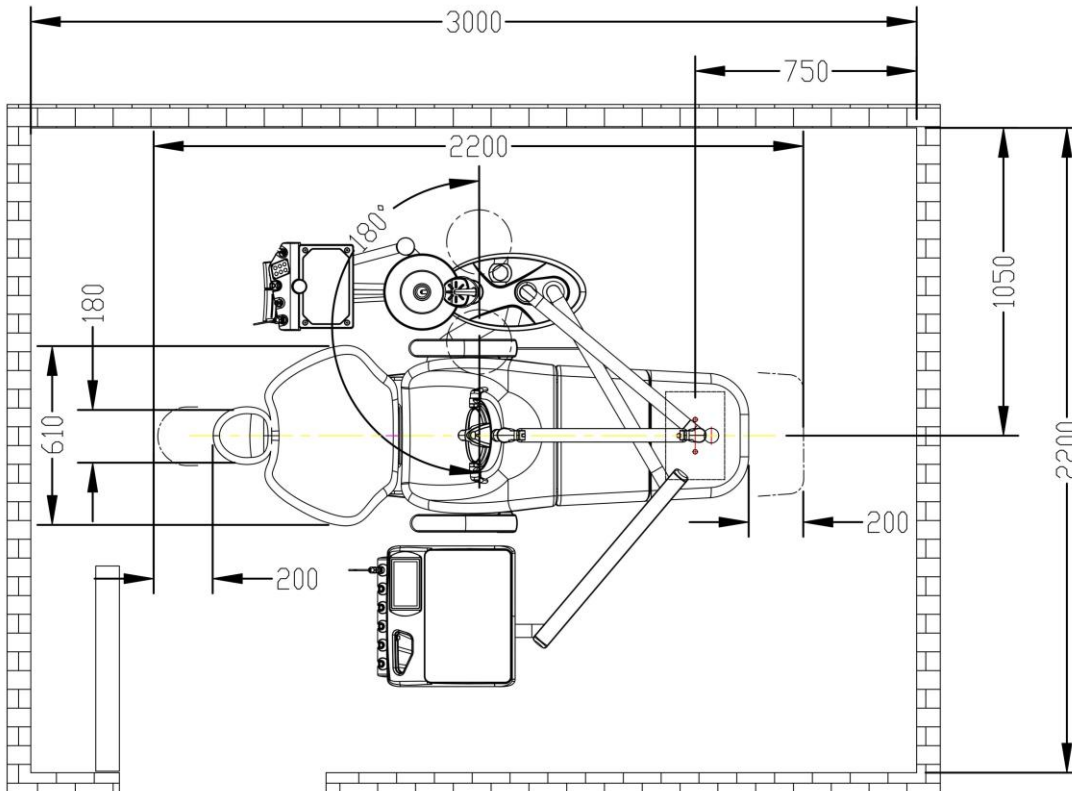

Dimensional drawing of dental unit E9-c/E9-i/ P3-c/P3-i/P3-t:

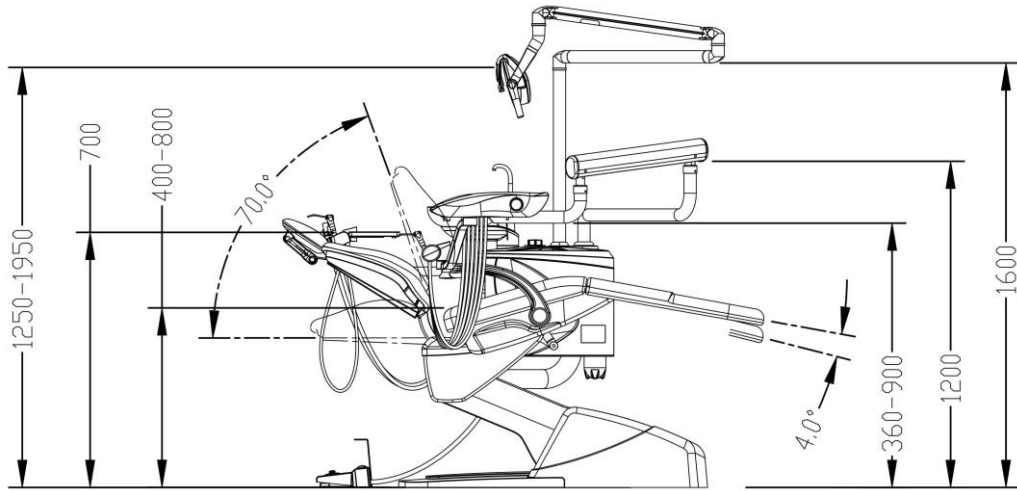

E9-t/E9-x:

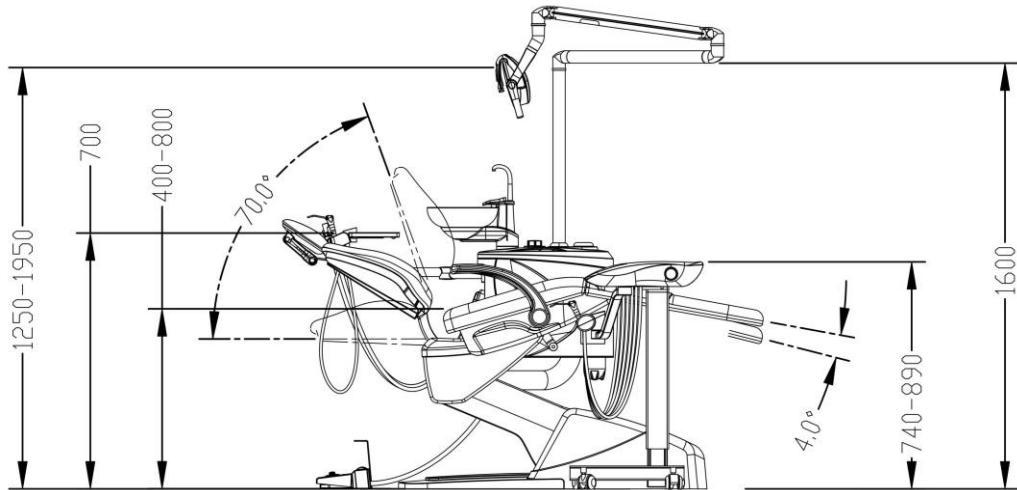

Layout requirements of floor box holes and overall dimension drawing of the floor box

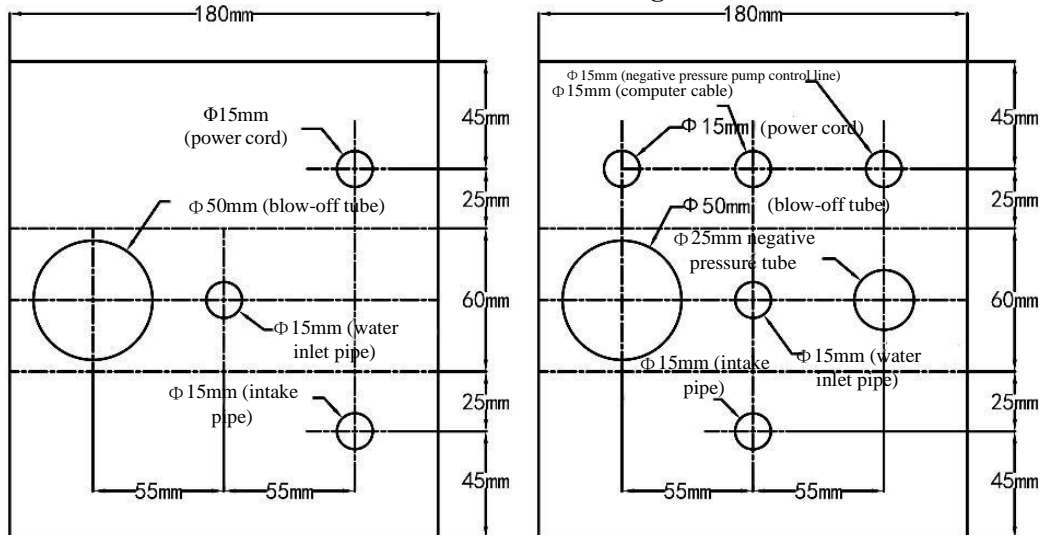

The blow-off tube in the floor box hole is a $\Phi 50$ mm PVC pipe, the water supply pipe is $\Phi 15$ mm, and the air supply pipe is $\Phi 15$ mm. The water supply pipe and air supply pipe can be used to connect the ball valve to the port of the high-pressure aluminum-plastic composite pipe. The power supply is 230 V with grounding wire, and the wire diameter is $\cong 1.5\text{mm}^2$. The pipeline should not be higher than the ground as much as possible. If it needs to be higher, it should not exceed 100 mm. If the endoscope is connected to the indoor computer, it must be increased in the floor box hole. VGA data cable and AV video cable are connected to the computer.

Power voltage:	220 V AC	Power frequency:	50 Hz/60Hz
----------------	----------	------------------	------------

Air pressure limit:	(0.7±0.1) MPa, flow ≥80 NL/min	Water pressure:	0.2Mpa~0.6Mpa, water follow rate should be above 5L/min
Maximum waste water flow rate:	6 L/min	Minimum inclination of waste water lines:	5°

6.3 Handling, packaging and dismantling methods of equipment

The equipment shall be transported to the desired installation site according to the method specified on the outer packaging box.

The product is packaged in 1 box, and the outer packaging of the equipment can be removed by removing the outer packaging bolts.

Take out the packing list and check the configuration and accessories to see if they are intact. If you have any doubts, please contact the company in time.

6.4 Installation method of equipment

6.4.1 Installation of electric dental chair

Remove the packing foam and remove the accessory box and other accessories.

Remove the front cover and the bottom cover of the electric dental chair, remove the four bolts that fix the electric dental chair on the bottom plate, and put them in the predetermined position at the bottom where the electric dental chair can be stressed, and keep the balance state.

Fix the 4 fixing holes on the base plate of the electric dental chair to the ground with 8mm expansion screws. The installation torque is 20 N·m.

6.4.2 Installation of the dental operating light

Insert the lamp post into the hole corresponding to the upright post of the side box, thread the electric wire connected to the lamp arm into the lamp post, then connect and fix the dental operating light holder, and then connect and fix the electric wire plug of the lamp arm with the corresponding connector on the circuit board in the side box.

6.4.3 Installation of water, gas and electricity in the floor box

Connect the G1/4*Φ8 straight-through connector to the air inlet ball valve, connect one end of the blue Φ8PU pipe to the straight-through connector, and the other end to the main air inlet port of the dental unit.

Connect the G1/4*Φ8 straight-through connector to the water inlet ball valve, connect one end of the orange Φ8PU pipe to the straight-through connector, and one end to the main water inlet port of the dental unit.

Insert the drainage pipe of the dental unit and the saliva ejector into the Φ50PVC blow-off tube of the floor box hole. Connect the power supply and the grounding wire, the connection should be firm and reliable, insert all the connection plugs into the corresponding floor box circuit board sockets, and arrange the pipelines.

6.5 Commissioning method of equipment

Total air pressure adjustment (note: non-professionals are not allowed to adjust at will): In the picture on the right, adjust the intake pressure regulator to 550 kPa according to the pressure gauge on the dental unit.

Air pressure adjustment of dental high-speed handpiece: adjust the air pressure of the handpiece to 250 kPa through the knob at the bottom of the treatment table.

Air pressure adjustment of dental low-speed handpiece: adjust the air pressure of the handpiece to 250 kPa-300 kPa through the knob at the bottom of the handpiece of the treatment table.



6.6 Water sampling connection port

As the dental unit is directly connected to the drinking water supply, users can install the input water sampling port near the input water connection port according to actual needs. The specific methods are as follows:

Connect the G1/4*Φ8 straight-through connector to the water sampling ball valve.

Connect the Φ8 three-way connector between the input water check valve and the water filter, connect one end of the orange Φ8 polyether pipe to the three-way connector, and one end to the water sampling ball valve.

The other end of the water sampling ball valve is connected to a suitable length of orange Φ8 polyether pipe.

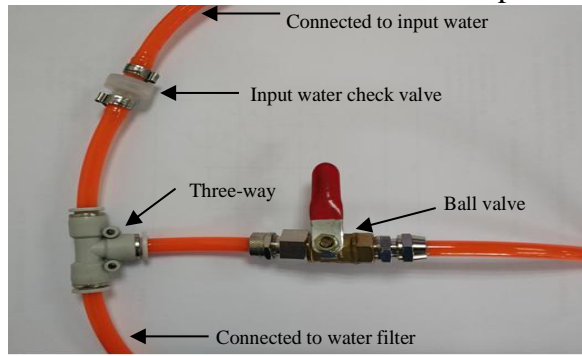

When sampling, open the water sampling ball valve switch, and close the water sampling ball valve switch after sampling.

6.7 Schematic diagram of water and gas and electrical diagram

Water/gas schematic diagram of E9-c/E9-i/E9-t/E9-x

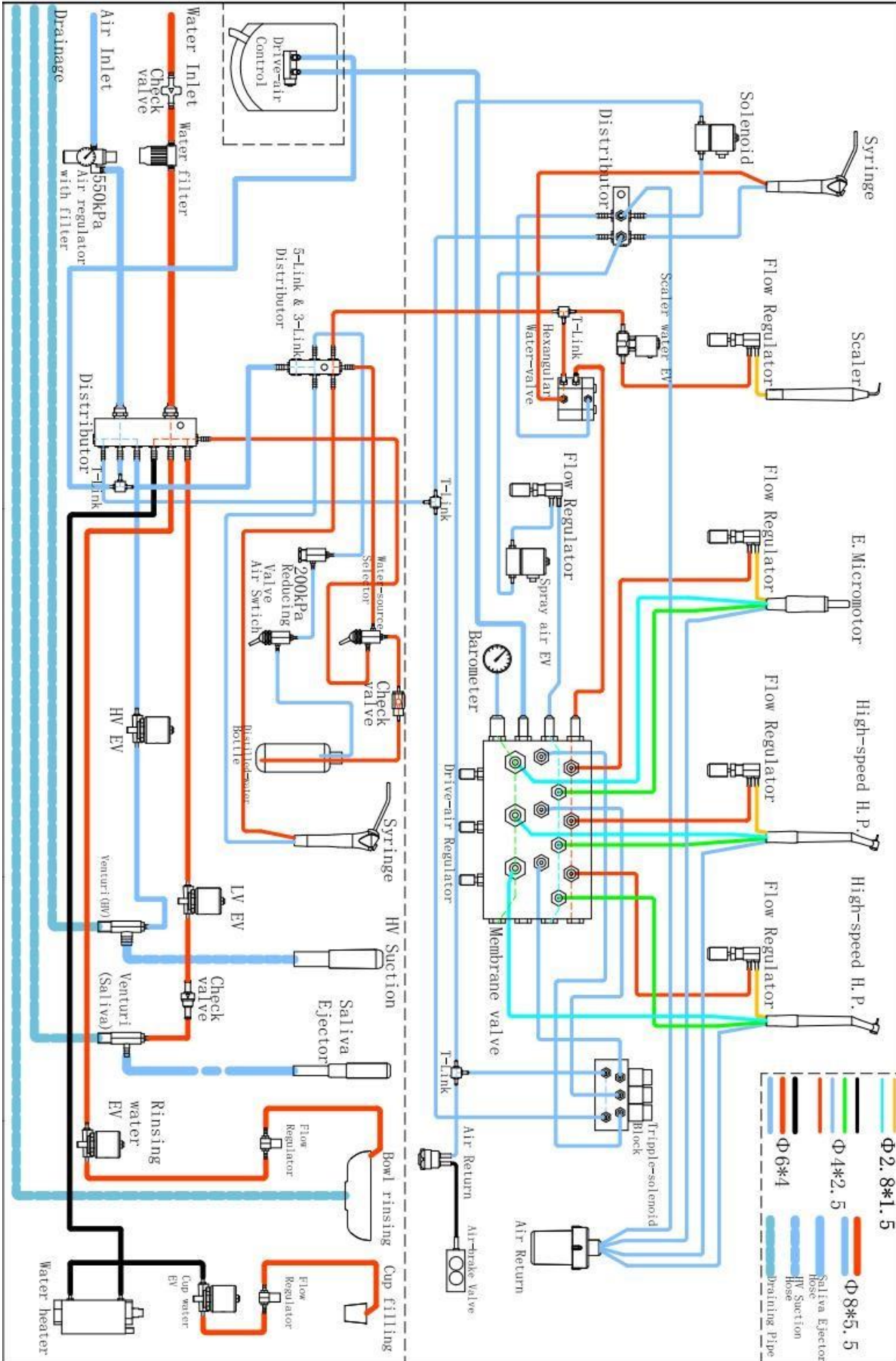

Water/gas schematic diagram of P3-c/P3-i

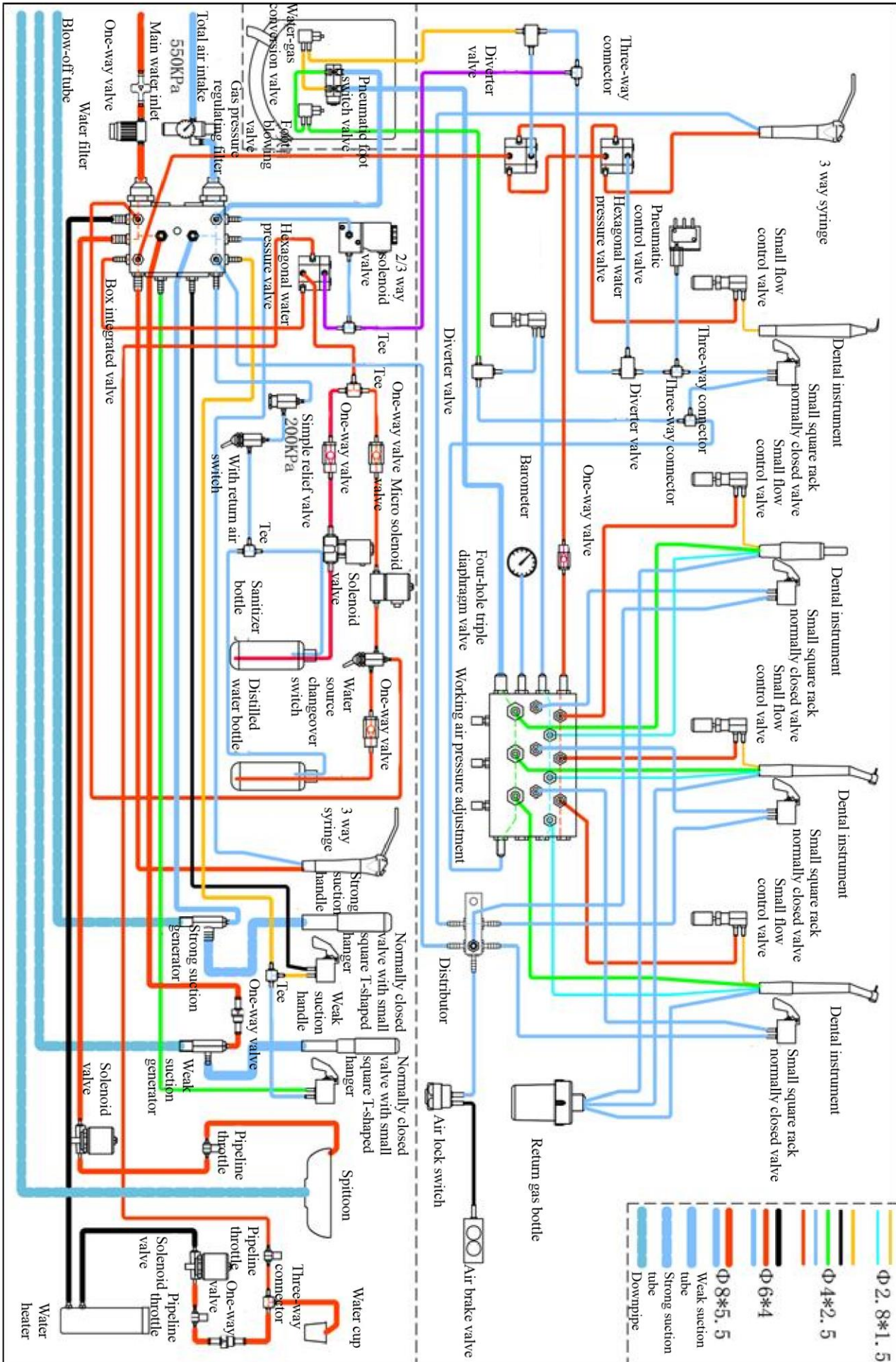

Water/gas schematic diagram of P3-t

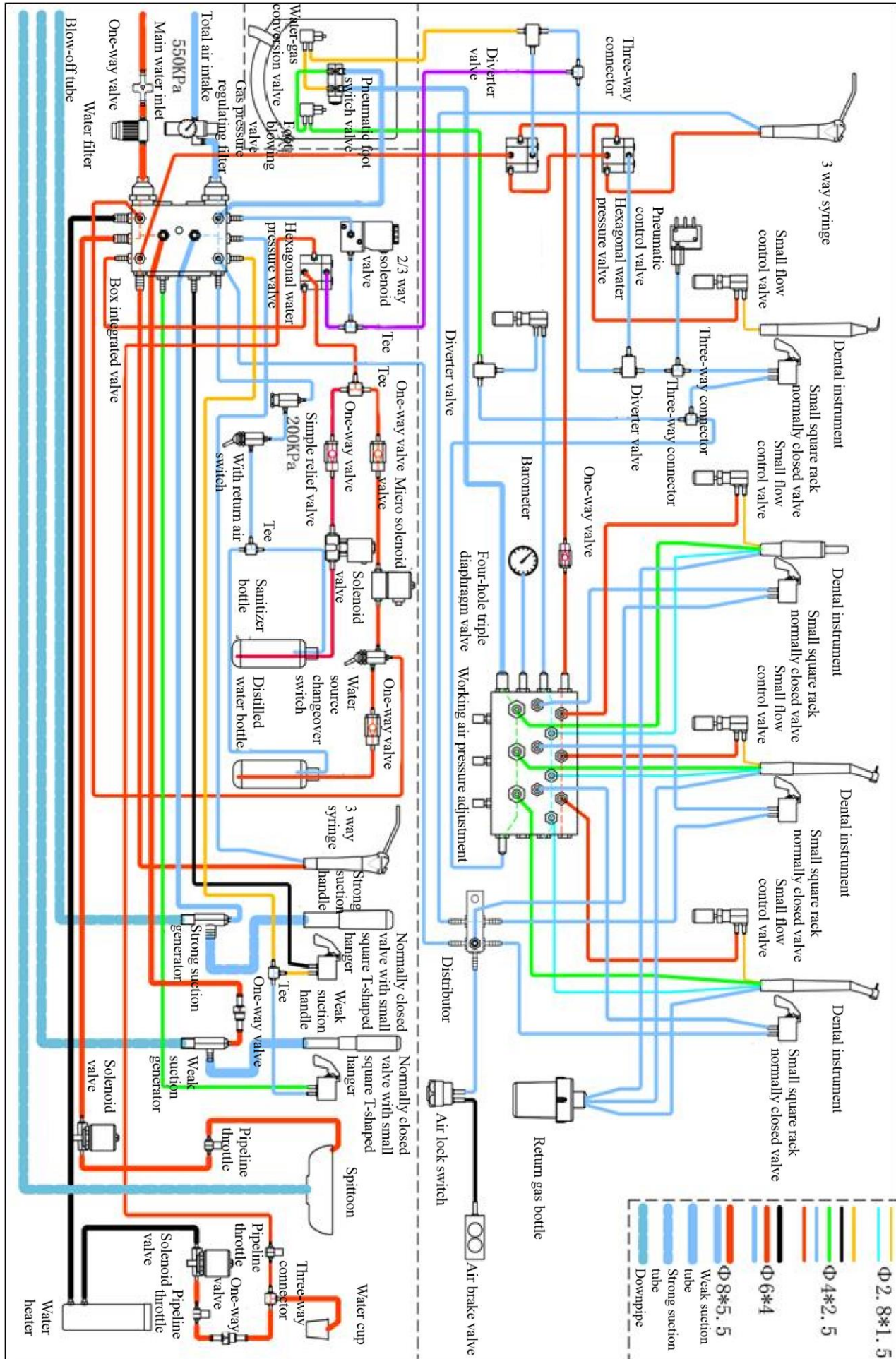

E9-c/E9-i/E9-t/E9-x electrical diagram

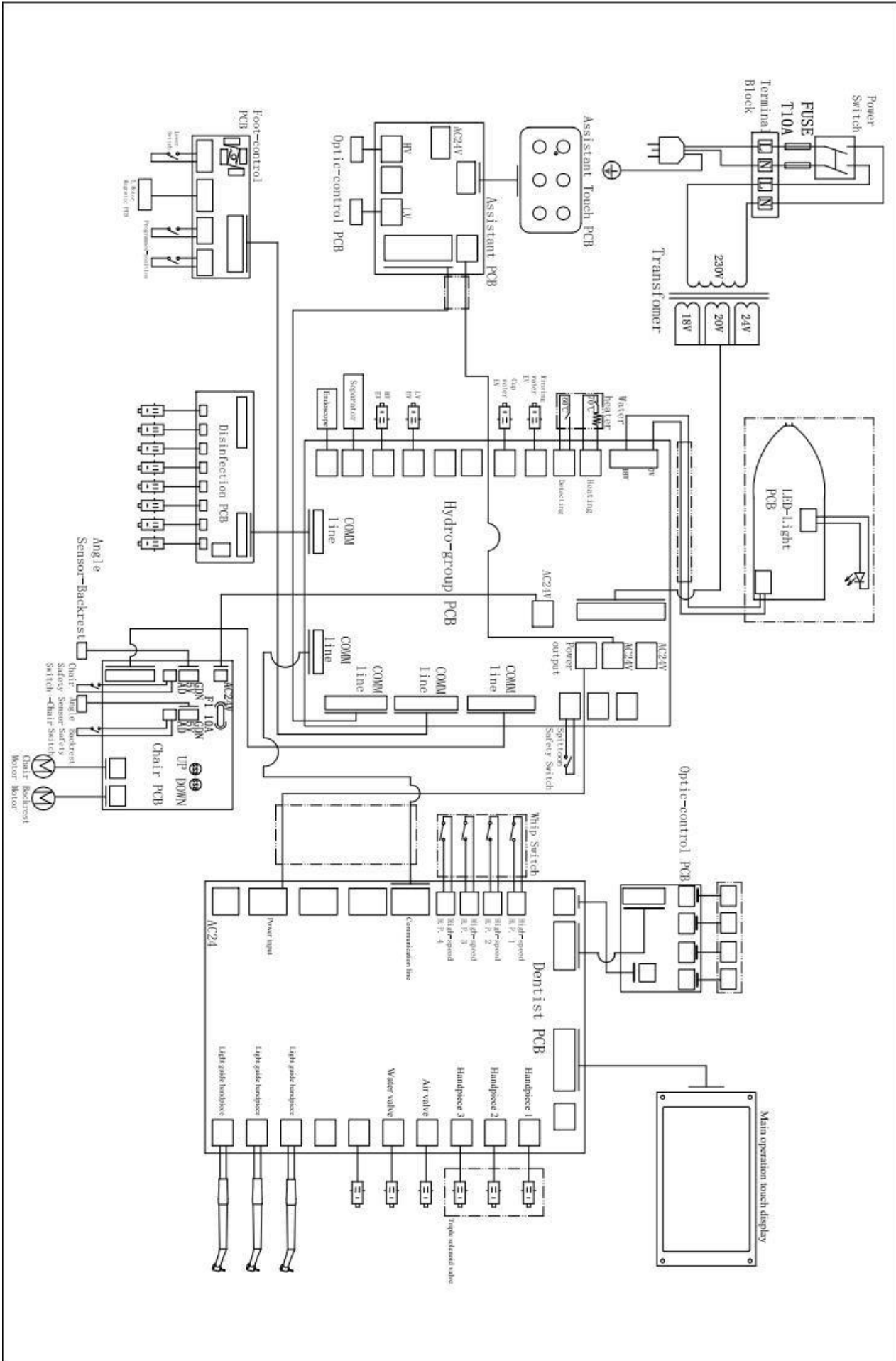

P3-c/P3-i electrical diagram

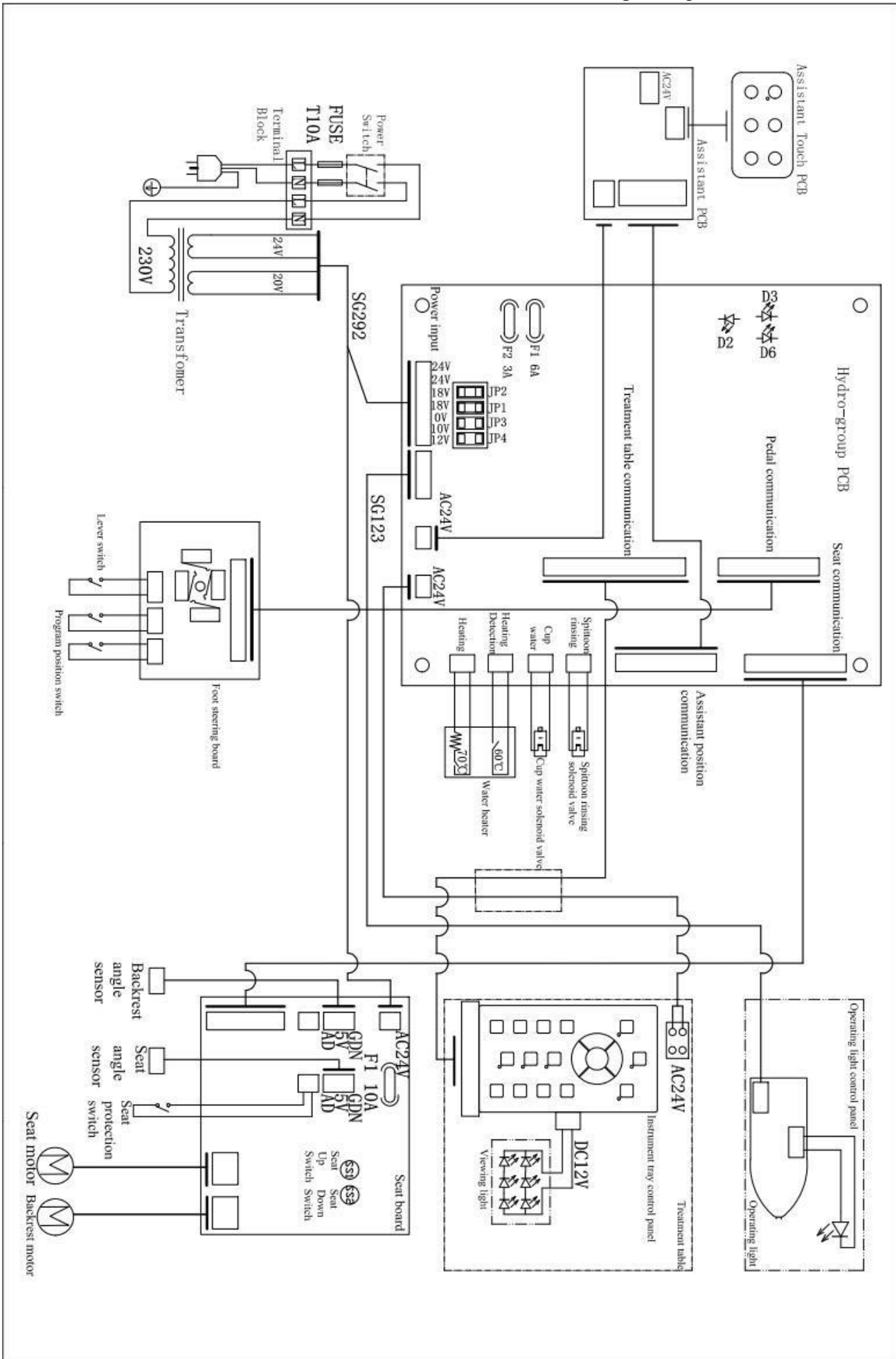

P3-t electrical diagram

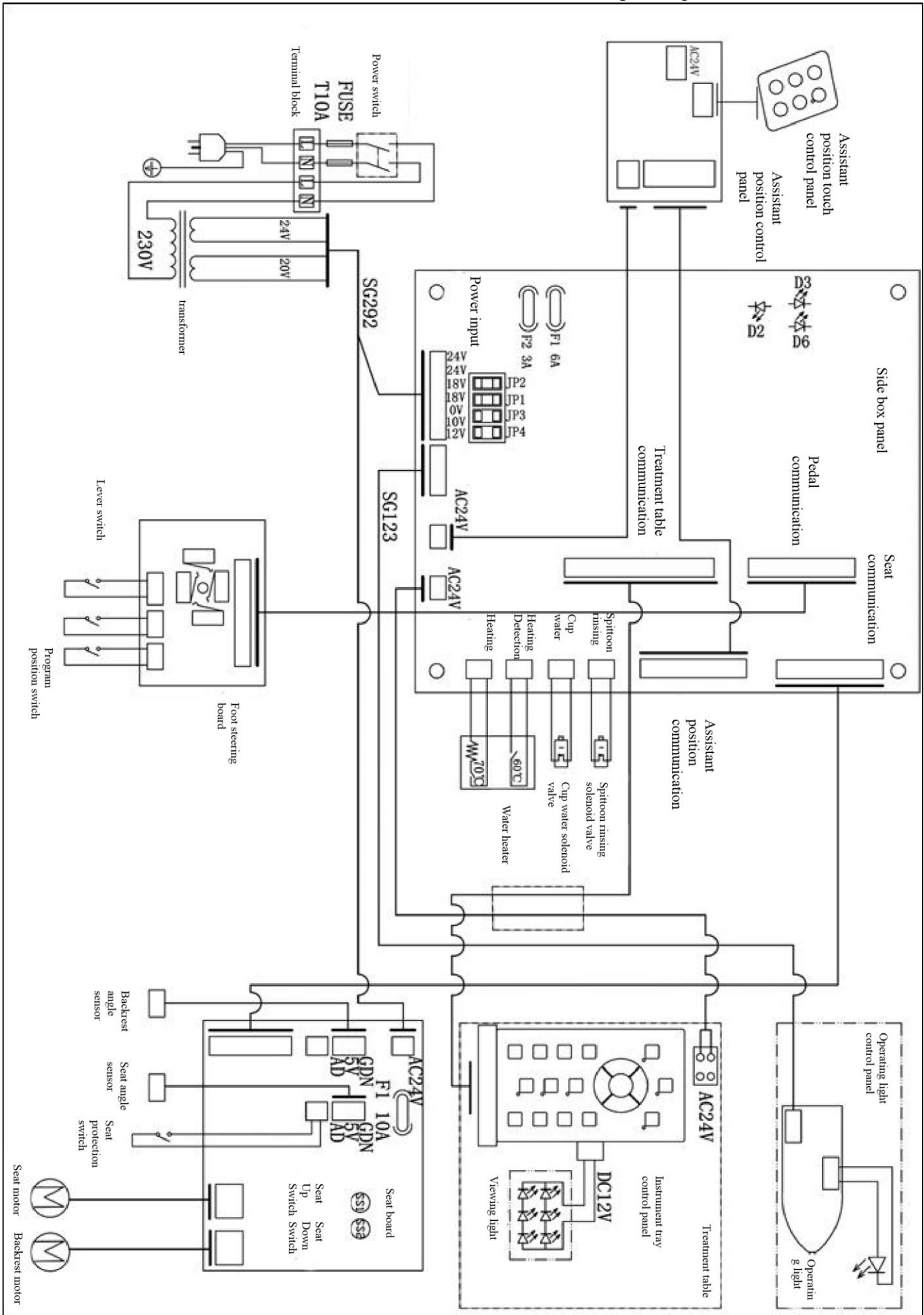

6.8 Waste disposal

If the equipment is too old, even after proper maintenance and repair, it can no longer meet the expected operating specifications of the manufacturer, then the equipment cannot be used and should be scrapped in time. All provisions concerning waste disposal shall be observed. At a minimum, the electronic circuit related components of the equipment shall be regarded as non-environmental protection waste. Disposed in accordance with the local laws and regulations or the rules of the hospital.

Chapter 7 Common Faults and Troubleshooting

7.1 Electric dental chair part

Fault	Cause	Solution
The whole machine does not move	Power fuse damaged	Replace the same type of fuse
The lift not functioning properly	Motor damaged or wiring is loose	Check wiring and notify engineer
Backrest not functioning properly	Motor damaged or wiring is loose	Check wiring and notify engineer
Movement Chaos	The chip of the CPU is damp or damaged	Moisture absorption treatment and notify the engineer
Dental operating light does not go on	Broken fuse or damaged circuit board	Replace the fuse of the same type or notify the engineer
Not enough air comes from the dental handpiece	Air hoses deformed or filter blocked	Adjust the air hoses or clean the filter
Not enough water comes from 3 way syringe	Throttle valve adjustment is too small or too large	Adjust the throttle valve
Saliva aspirator doesn't work	Solenoid valve damaged	Notify engineer to replace
Weak saliva aspirator suction force is not enough	O-rings damaged or insufficient water pressure	Replace O-rings or adjust water pressure
Strong saliva aspirator suction force is not enough	O-rings damaged or insufficient air pressure	Replace O-rings or adjust air pressure
No warm water	Heater damaged	Notify engineer to replace

7.2 Replacement of fuse tube













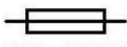

After the main power switch is turned off, open the side box cover, unscrew the fuse tube cap with a medium crosshead screwdriver, put in a new fuse tube, and follow the reverse procedure as above.

Fuse tube	Specification
Main fuse tube	T10 AL,250 V

7.3 accessory and of common spare parts list

Accessory	Specification/model
Fuse	4.01.416BA10521
Water tube (30cm)	4.05.440JM42520
Air tube (30cm)	
3-way spraying	3.02.301CX078A0
Spare parts	Specification/model
Stainless steel cross screw with deep head	M4*10
Copper joint	G1/2*5/16

7.4 Graphics and symbols used in equipment

	It appears alone, it means that other contents are detailed in the instruction manual		When appearing together with "Caution", it means important information for users or service personnel.
	When appearing together with "Warning", it means that failure to follow the manual may cause personal injury or damage to the equipment and its components.	 T10AL AC250V	Fuse mark.
	"No wet" sign.		"Fragile" sign.
	"Up" sign.	 93%	Storage humidity limit sign.
 -40°C 155°C	Storage temperature limit sign.	 106kPa 50kPa	Storage atmospheric pressure limit sign.
	Stacking limit.		Means "See the accompanying document".
	It is the sign meaning "Do not discard an electronic equipment freely". According to the regulations, after the expiration date, the equipment shall be disposed of according to the local legal requirements to avoid polluting the environment and injuring the user.		"Grounding" sign.
	Class: Class B.	IPX1	Foot switch waterproof grade mark.
	OFF (mains power).		ON (mains power).

Dental Unit

Chapter 8 Electromagnetic Compatibility

 Caution:

- The Dental Unit meets the relevant electromagnetic compatibility requirements of the standard IEC60601-1-2.
- The user shall install and use the equipment according to the information provided in the accompanying document.
 - Portable and mobile RF communication equipment may influence the performance of the dental X-ray machine. When using the equipment, avoid strong electromagnetic interference, e.g., in the vicinity of mobile phones, microwave ovens, etc.
- See Annex for details of the guidelines and the manufacturers' statements.

 Warning:

- The dental X-ray machine shall not be placed near or stacked with other equipment when it is used. Otherwise, you shall observe and verify whether it runs properly with the operating settings thereof.
- Use of the cables other than the cables that are delivered by the Dental Unit manufacturer as spare parts for internal components may result in an increase in the emission of the dental X-ray machine or a reduction in its immunity.

Annex:

Guidelines and the manufacturer's statement – electromagnetic emission

E9-c/E9-i/E9-t/E9-x/P3-c/P3-i/P3-t Dental Unit Operating Manual

The Dental Unit is intended for use the electromagnetic environment specified below. The customer or the user of Dental Unit should assure that it is used in such an environment:

Emissions test	Compliance	Electromagnetic environment - guideline
RF emission CISPR 11	Group 1	The Dental Unit uses RF energy only for its internal function. Therefore, its RF emission is very low and not likely to cause any interference in nearby electronic equipment.

RF emission CISPR 11	Class B	The Dental Unit is suitable for use in all establishments, including domestic establishments and those directly connected to the public low-voltage power supply network that supplies buildings used for domestic purposes.
Harmonic emissions IEC61000-3-2	Class A	
Voltage fluctuation / flicker emissions IEC61000-3-3	Complies	

Guidelines and the manufacturer's declaration – electromagnetic immunity

The Dental Unit image intensifier is intended for use in the electromagnetic environment specified below. The customer or the user of the Dental Unit image intensifier should assure that it is used in such an environment:

Immunity test	IEC 60601 Test	Compliance Voltage	Electromagnetic environment guidance
Electrostatic discharge (ESD) IEC61000-4-2	± 8 kV Contact ±15 kV Air	± 8 kV Contact ±15 kV Air	Floors should be wood, concrete or ceramic tile. If the floors are covered with synthetic material, the relative humidity should be at least 30%.
Electrical fast transient/burst IEC61000-4-4	±2kV for power supply lines ±2kV for input/output lines	±2kV for power supply lines ±2kV for input/output lines	Mains power quality should be that of a typical commercial or hospital environments.
Electrical surge IEC61000-4-5	±1 kV line(s)-to- line(s) ±2 kV Wire-to-ground	±1 kV differential mode ±2 kV common mode	Mains power quality should be that of a typical commercial or hospital environments.
Voltage dips, short interruptions and voltage variations on power supply input lines IEC61000-4-11	<5 % U_T (>95% dip in U_T) for 0.5 cycle 40 % U_T (60% dip in U_T) for 5 cycle 70 % U_T (30% dip in U_T) for 25 cycle <5 % U_T (>95% dip in U_T) for 5 s	<5 % U_T (>95% dip in U_T) for 0.5 cycle 40 % U_T (60% dip in U_T) for 5 cycle 70 % U_T (30% dip in U_T) for 25 cycle <5 % U_T (>95% dip in U_T) for 5 s	Mains power quality should be that of a typical commercial or hospital environments. If the user of the Dental Unit image Intensifier requires continue operation during power mains interruptions, it is recommended that the Dental Unit image Intensifier be powered from an uninterruptible power supply or a battery.

E9-c/E9-i/E9-t/E9-x/P3-c/P3-i/P3-t Dental Unit Operating Manual

Power frequency (50 / 60Hz) magnetic field IEC61000-4-8	30A/m	30A/m,50/60Hz	If image distortion occurs , it may be necessary to position the Dental Unit image Intensifier further from sources of power frequency magnetic fields or to install magnetic shielding .The power frequency magnetic field should be measured in the intended
---	-------	---------------	--

			installation location to assure that it is sufficiently low.
--	--	--	--

Note: U_T is the a.c. mains voltage prior to application of the test level.

Guidance and manufacturer's declaration – electromagnetic immunity

The Dental Unit is intended for use in the electromagnetic environment specified below. The customer or the user of the Dental Unit should assure that it is used in such an electromagnetic environment:

Immunity test	IEC 60601 Test level	Compliance level	Electromagnetic environment – guidance
Conducted RF IEC61000-4-6	3 Vrms 150 kHz to 80 MHz outside ISM bands ^a	3 Vrms	Portable and mobile RF communications equipment should be used no closer to any part of the Dental Unit, including cables, than the recommended separation distance calculated from the equation applicable to the frequency of the transmitter. Recommended separation distance: $E = \frac{6}{d} \sqrt{P}$ Where P is the maximum power in W, d is the minimum separation distance in m ^b , and E is the IMMUNITY TEST LEVEL in V/m.
	6 Vrms 150 kHz to 80 MHz is ISM bands ^a	6 Vrms	
Radiation RF IEC61000-4-3	10V/m 80 MHz to 2.7 GHz	10V/m	Field strengths from fixed RF transmitter, as determined by an electromagnetic site survey, ^c should be less than the level in each frequency range. ^d Interference may occur in the vicinity of equipment marked with the following symbol. 

Note :These guidelines may not apply in all situation. Electromagnetic propagation is affected by absorption and reflection from structures, objects and people.

- a The ISM (industrial, scientific and medical) bands between 150 kHz and 80 MHz are 6,795 MHz; 13,553 MHz to 13,567 MHz; 26,957 MHz to 27,283 MHz; and 40,66MHz to 40,70MHz.
- b The compliance level in the ISM frequency bands between 150 kHz and 80MHz and in the frequency range 80MHz to 2,5 GHz are intended to decrease the likelihood that mobile/portable communications equipment could cause interference if it is inadvertently brought into patient areas. For this reason, an additional factor of 10/3 is used in calculating the recommend separation distance for transmitters in these frequency ranges.
- c Field strengths fixed transmitters, such as base stations for radio (cellular/cordless) telephones and land mobile radios, amateur radio, AM and FM radio broadcast and TV broadcast cannot be predicted theoretically with accuracy. To assess the electromagnetic environment due to fixed RF transmitter, an electromagnetic site survey should be considered. If the measured field strength in the location in which the Dental Unit is used exceeds the applicable RF compliance level above, the Dental Unit should be observed

to verify normal operate. If abnormal performance is observed, additional measures may be necessary, such as re-adjust or relocating the Dental Unit.

- d Over the frequency range 150 kHz to 80 MHz, field strengths should be less than 1V/m.

Chapter 9 Disposing

It is required that you should not dispose of WEEE as unsorted municipal waste and collect such WEEE separately.

In accordance with Directive 2012/19/EU and national disposal regulations regarding old electrical and electronic devices, please be advised that such items must be disposed of in a special way within the European Union (EU). These regulations require the environmentally friendly recycling/disposal of old electrical and electronic devices. Such items must not be disposed of as domestic refuse. This has been expressed using the icon of the “crossed out trash can”.



The Dental unit (model: E9-c, E9-I, E9-t, E9-x, P3-c, P3-I, P3-t) contains recyclable electronic waste. To protect the environment, do not dispose of it in household waste as unsorted municipal waste, but collect separately and take it to an appropriate local collection center. In Germany

For the recyclable electronic waste disposal, you can search the authorized collection points at the following website: <https://www.ear-system.de/ear-verzeichnis/sammel-und-ruecknahmestellen>.

Search method: using your postcode or the name of the city and state where you live to find collection points near you.

Other countries

For country-specific information on disposal, contact your local dealers or importer.

Manufacturer: Lifedent (Zhuhai) Co., Ltd.

Manufacture & Registration Address: 3rd floor and 4th floor, Building 3, No.1 Chuangxinyi Road,
Tangjiawan Town, Hi-tech Zone, Zhuhai, China

Tel: +86-756-8699593 Website: <http://www.lifedent.cn>

E-mail: sales@lifedent.cn Post Code: 519000 Doc No.: LF-ZLJ-RD-035 Version: A3 Date of issue: 12/2023

EU Authorized Representative: Shanghai International Holding Corp. GmbH (Europe)

Address: Eiffestrasse 80, 20537 Hamburg, Germany

Tel: +49-40-2513175

Fax: +49-40-255726

email: shholding@hotmail.com



DOCTOR STOOL

TECHINCAL SPECIFICATIONS:

- 30 cm Diameter, 32,5 cm Width
- 70 cm Height
- PU Leather
- Chemical Disinfection allowed
- Adjustable Height (30 - 70 cm)
- Legrest (adjustable)
- Backrest – Adjustable
- 35-40 High Density New Foam in the Seat and Backrest Matching 13MM Plywood
- Anti-noised PU Castors with Dust Cover
- Maximum load 150 kg

