

Tracheobronchial Stent

Code: ST



The Stening® Tracheobronchial stent is the classical and straight stent for tracheal and bronchial affections. It has a tubular structure, with flat surface anchoring studs on its outer wall to prevent stent migration.

Indications

- Primary or secondary bronchial/tracheal neoplasms
- Tracheoesophageal fistula
- Bronchial/tracheal rupture
- After laser resection, cryotherapy or electrocautery, to maintain the airway opened
- Extrinsic compression or commitment of the submucosa
- Post-intubation stenosis
- Post-traumatic stenosis
- Post infectious stenosis (endobronchial tuberculosis, histoplasmosis mediastinal fibrosis, herpes virus, diphtheria)
- Post inflammatory stenosis: Wegener's disease
- Focal trachea-broncho-malacia: following tracheostomy or radiation therapy
- Diffuse trachea-broncho-malacia: idiopathic, polychondritis or Mounier-Kuhn syndrome
- Tracheal/bronchial tumors
- Amyloidosis
- Excessive dynamic compression of the airway
- Postsurgical term-terminal bronchial anastomosis stenosis
- Broncho-malacia
- Bronchus invasion caused by an esophageal carcinoma
- After endoscopic resection of bronchial metastasis

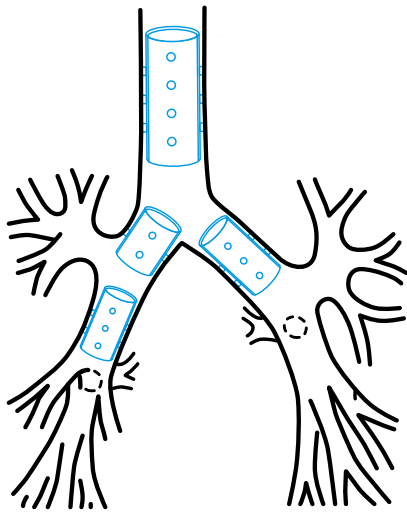

Miscellaneous

- Extrinsic compression caused by an aortic aneurysm
- Tracheal distortion caused by kyphoscoliosis
- Tracheal obstruction caused by an esophageal stent
- In combination with an esophageal stent

How to Use:

Introduction technique: the procedure will be carried out under general anesthesia.

The implant of these type of prostheses can be performed directly through the work channel of the tracheoscope or bronchoscope. A conventional introducer for silicone prostheses can be used as well. A rigid endoscope will be used to access the airway.

The length and diameter of the area that the stent will cover must be established correctly. If you want to know the length of the area, you can mark the endoscope when its extreme is located at the end of the injury. Repeat the process once the tracheoscope is moved up to the beginning of the injury. The diameter of the trachea or bronchi must be estimated by comparing it with the diameter of the endoscope used.

Retrograde mode of Implant:

1. Lubricate the introducer nozzle with lidocaine gel, preventing the lubricant from reaching the operator's fingers.
2. Fold the Stening® over its axial axis and put it inside the prostheses introducer through its nozzle.
3. Remove the nozzle.
4. Pass the injured area with the bronchoscope tube and locate its distal end or bevel on the healthy mucosa, exceeding the affected area by 5 to 7 mm.
5. Place the introducer inside the endoscope.
6. Press the ejector while extracting the endoscope in equal measure in which the plunger progresses inside. The prosthesis will be released. If necessary, it can be accommodated with an alligator forceps. The maneuver is simpler if the stent is "lower" than the lesion.

Antegrade mode of implant: steps 1, 2 and 3 will be repeated.

Stop the endoscope containing the introducer and prosthesis 5 mm before injury. Then slowly press the ejector plunger. In this way the prosthesis will advance inside the area to be treated. When the stent starts to abandon the endoscope interior you will feel a small reduction of the resistance in the pressure performed on the plunger.

A prosthesis loader can be used to propel the stent through the interior of the endoscope, or the method that the operator deems appropriate.

Correction of the stent position: the stent may require additional maneuvers in order to correct or adjust its final position. It is preferable to correct a stent that has been released beyond the desired position. It is highly inconvenient to advance a prosthesis that has been released before the lesion to be treated.

To move a stent in a proximal way it has to be taken by its edge with an alligator forceps and then you must pull with kindness. To be more accurate we recommend this maneuver: take the stent by its edge. Then, advance with the optical vision through the stent until you see its distal end. Now pull the forceps and you will be able to see how the stent ascends through the airway.

Stop pulling when you consider that the position is correct.

Extraction technique: the intubation will be carried out with a rigid endoscope.

The stent must be taken by its edge with an alligator forceps, with enough steadiness. Rotate the forceps 360° so the stent folds on itself taking an omega shape and loses its radial resistance to compression. Next, pull the forceps by removing the prosthesis together with the endoscope. You can insert the proximal end of the stent into the endoscope. This way, the vocal cords are protected during the extraction.

Other implant and removal methods are also possible depending on the experiences and preferences of the surgeon.

Cares:

- Maintain the moisture of secretions whenever they appear, by taking nebulizations frequently with a warm isotonic saline solution
- Perform a periodic check-up following your doctor's advice
- Take care of your oral hygiene and treat cavities

Features

- Medical grade silicone
- Bevelled edges to prevent granulomas
- Spur system to prevent migration
- Removable
- Surface of maximum softness to avoid adherence of secretions
- Transparent or Radiopaque

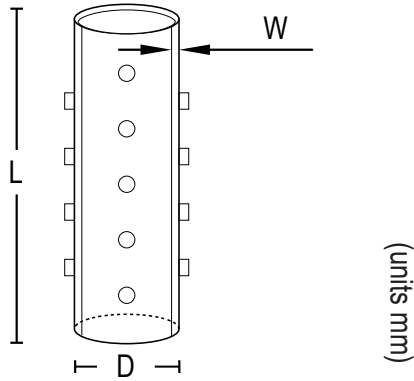

References		Dimensions (mm)		
Translucent	Radiopaque	Diameter (D)	Length (L)	Wall thickness (W)
ST05	ST05X	5	50	0.5
ST06	ST06X	6	50	0.6
ST08	ST08X	8	50	0.8
ST10	ST10X	10	20, 30, 40, 50, 60, 70, 80	1
ST11	ST11X	11	20, 30, 40, 50, 60, 70, 80	1.1
ST12	ST12X	12	20, 30, 40, 50, 60, 70, 80	1.2
ST13	ST13X	13	30, 40, 50, 60, 70, 80	1.5
ST14	ST14X	14	30, 40, 50, 60, 70, 80	1.5
ST15	ST15X	15	30, 40, 50, 60, 70, 80	1.5
ST16	ST16X	16 ^¼	30, 40, 50, 60, 70, 80	1.5
ST17	ST17X	17 ^½	30, 40, 50, 60, 70, 80	1.5
ST18	ST18X	18	40, 60, 80, 100	1.5
ST20	ST20X	20	40, 60, 80, 100	1.5

Stening® provides detailed instructions for use with each device, including insertion and removal techniques, precautions, and postoperative care.

For custom made devices you can [contact us](#)

A radiopaque device can be white or pale yellow.

Due to the characteristics of the production process, the sizes of the devices may vary by +/- 2%

Warning: the product should not be reused because this can cause cross contamination.

Conical Bronchial Stent

Code: CLASS



The Stening® Class Stent is a device designed to maintain the clearance of the airway in sufficient conditions for ventilation. It has a conical elastic tubular structure, with non-slip spurs arranged in several rows and distributed symmetrically along its surface.

Indications:

- Bronchial neoplasms
- Neoplasms that invade tracheal carina or its slopes
- Following laser photoresection, cryotherapy or electrocautery, to maintain the opening of the airway
- Invasion of bronchial sources by esophageal carcinoma
- Postinfectious stenosis (tuberculosis, histoplasmosis with mediastinal fibrosis, herpes virus, diphtheria)
- Impending atelectasis
- Bronchial stenosis
- Post-traumatic stenosis
- Post-terminal surgical bronchial anastomosis stenosis
- Bronchial rupture
- Extrinsic compression
- Bronchomalacia
- Bronchial Amyloidosis
- Excessive dynamic compression of the airway
- After endoscopic resection of bronchial metastases

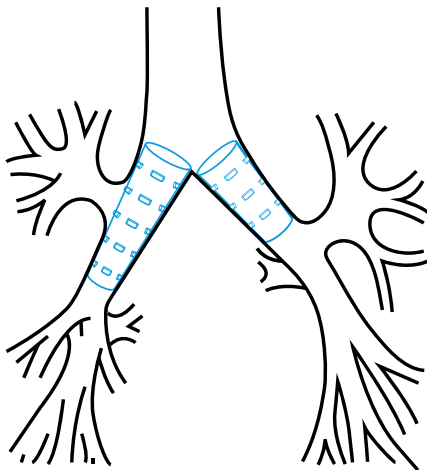

Special features:

Gradual resistance: to accompany the functionality of the bronchus and its physiology, the strength of its wall is progressively reduced distally at a rate of 3% per each centimeter of the length of the stent.

Increase in fixing capacity: although the increase in the fixing capacity of the Stening® Class Stent cannot be precisely determined with regard to its counterpart, this property is benefited by the existence of fixations aligned against the direction of possible unwanted displacement. Their number duplicates the existing ones in the straight stent model.

How to Use:

Introduction technique: the procedure will be carried out under general anesthesia. The implantation of this type of prosthesis requires the use of a conventional introducer for silicone prostheses.

The airway will be accessed with a rigid tracheoscope. The length and clearance of the trachea or bronchus in the segment in which the stent will be housed must be estimated in order to make the correct choice of prosthesis.

Retrograde mode of Implant:

1. Lubricate the introducer nozzle with lidocaine gel, preventing the lubricant from reaching the operator's fingers.
2. Fold the Stening® over its axial axis and put it inside the prostheses introducer through its nozzle, with the narrowest end of the stent in the distal position.
3. Remove the nozzle.
4. Pass the injured area with the bronchoscope tube and locate its distal end or bevel on the healthy mucosa, exceeding the affected area by 5 to 7 mm.
5. Place the introducer inside the endoscope.
6. Press the ejector while extracting the endoscope in equal measure in which the plunger progresses inside. The prosthesis will be released. If necessary, it can be accommodated with an alligator forceps. The maneuver is simpler if the stent is "lower" than the lesion.

Antegrade mode of implant: steps 1, 2 and 3 will be repeated.

Stop the endoscope containing the introducer and prosthesis 5 mm before injury. Then slowly press the ejector plunger. In this way the prosthesis will advance inside the area to be treated. When the stent starts to abandon the endoscope interior you will feel a small reduction of the resistance in the pressure performed on the plunger.

A prosthesis loader can be used to propel the stent through the interior of the endoscope, or the method that the operator deems appropriate.

Correction of the stent position: the stent may require additional maneuvers in order to correct or adjust its final position. It is preferable to correct a stent that has been released beyond the desired position. It is highly inconvenient to advance a prosthesis that has been released before the lesion to be treated.

To move a stent in a proximal way it has to be taken by its edge with an alligator forceps and then you must pull with kindness. To be more accurate we recommend this maneuver: take the stent by its edge. Then, advance with the optical vision through the stent until you see its distal end. Now pull the forceps and you will be able to see how the stent ascends through the airway.

Stop pulling when you consider that the position is correct.

Extraction technique: the intubation will be carried out with a rigid endoscope.

The stent must be taken by its edge with an alligator forceps, with enough steadiness. Rotate the forceps 360° so the stent folds on itself taking an omega shape and loses its radial resistance to compression. Next, pull the forceps by removing the prosthesis together with the endoscope. You can insert the proximal end of the stent into the endoscope. This way, the vocal cords are protected during the extraction.

Other implant and removal methods are also possible depending on the experiences and preferences of the surgeon.

Cares:

- Maintain the moisture of the secretions when they exist, by making frequent nebulizations with warm isotonic saline solution
- Periodic control must be done according to medical criteria
- Treat dental caries and perform effective oral hygiene

Warning:

This device is an anatomical, slightly conical stent, therefore:

1. Remember that the stent should always be inserted into the bronchoscope with the larger diameter end in a proximal position, and the narrowest end in distal one.
2. If it is necessary to shorten the stent, it is preferable to make the cut close to its distal end. In other words, near the end of the smaller diameter.

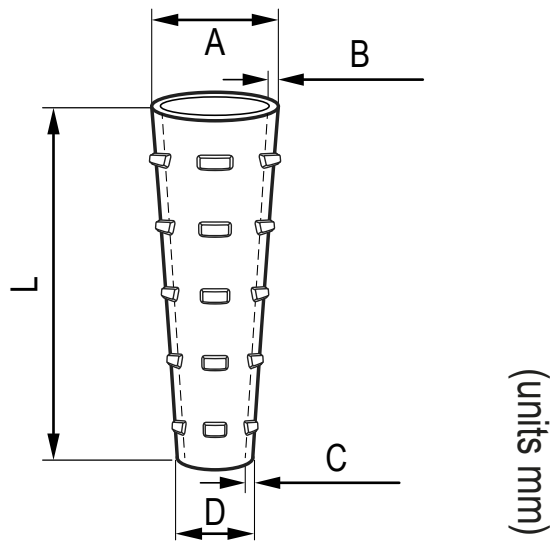

Features

- Medical grade silicone
- Bevelled edges to prevent granulomas
- Spur system to prevent migration
- Removable
- Surface of maximum softness to avoid adherence of secretions
- Transparent or Radiopaque

References		Dimensions (mm)				
Translucent	Radiopaque	Length (L)	Larger diameter (A)	Wider wall (B)	Narrower wall (C)	Smaller diameter (D)
CLASS10-30	CLASSX10-30	30	10	1.1	0.9	9.1
CLASS10-40	CLASSX10-40	40	10	1.1	0.9	8.8
CLASS10-50	CLASSX10-50	50	10	1.1	0.9	8.5
CLASS11-30	CLASSX11-30	30	11	1.1	0.9	9.9
CLASS11-40	CLASSX11-40	40	11	1.1	0.9	9.4
CLASS11-50	CLASSX11-50	50	11	1.1	0.9	9
CLASS12-30	CLASSX12-30	30	12	1.2	1	10.9
CLASS12-40	CLASSX12-40	40	12	1.2	1	10.4
CLASS12-50	CLASSX12-50	50	12	1.2	1	10
CLASS13-30	CLASSX13-30	30	13	1.3	1.1	11.8
CLASS13-40	CLASSX13-40	40	13	1.3	1.1	11.4
CLASS13-50	CLASSX13-50	50	13	1.3	1.1	11
CLASS14-30	CLASSX14-30	30	14	1.4	1.2	12.8
CLASS14-40	CLASSX14-40	40	14	1.4	1.2	12.4
CLASS14-50	CLASSX14-50	50	14	1.4	1.2	12

Stening® provides detailed instructions for use with each device, including insertion and removal techniques, precautions, and postoperative care.

For custom made devices you can [contact us](#)

A radiopaque device can be white or pale yellow.

Due to the characteristics of the production process, the sizes of the devices may vary by +/- 2%

Warning: the product should not be reused because this can cause cross contamination.

Conical Bronchial Stent

Conical stent for minor bronchi

Code: ROLL



The Stening® ROLL is our response to the clinical need on carrying out diseases treatments for small bronchi, but that are still capable of providing ventilation to its distal segments. This can be seen in the neoplastic infiltrations in the lower lobar bronchi both right and left ones. In this way, the interventionist and therapeutic bronchoscopy extends its scopes and we accompany this fact with the development of devices that can be applicable in minor bronchi. As well as

in peripheral ones and those with low resistance on their thin walls. This pushes experts' skills to increase the scopes of the endo-surgical treatments of the airway.

The Stening® ROLL is a special stent for common trunk of the basal segments of the lower lobes (left and right). Due to this, the stent possesses more smaller studs that provide a smooth support and with more distribution points of its loads. So that, its short dimensions make possible its fitting inside the bronchus that is going to be treated. Its anatomic shape copies the bronchus' conical shape, avoiding the distortion produced by the classical stents with a cylindrical shape. For individual anatomic variations we have three versions: ROLL810, ROLL911 (both with a length of 20 mm) and the ROLL1012 (with a length of 25 mm). The last one is special for the intermediate bronchus. It permits the air flux without occluding the apical entrance of the lower one, when this segment is unscathed. In this way, it is possible to effectuate treatments on the intermediate bronchus without interfering with the ventilation of other segments.

The Stening® ROLL can be cut on their margins to fit the length of the bronchus where they are implanted. Effectuate the section on its proximal margin, because this one does not confront any bronchial spur during the respiratory dynamic.

A stent implant inside the common trunk of the lower lobar can end in an occlusion on the entrance of the apical segment. The doctor must evaluate the benefits of restoring the ventilation of the basal ones in spite of the loss of the apical from the lower one. This must be done when this last one would not be affected by the neoplastic disease.

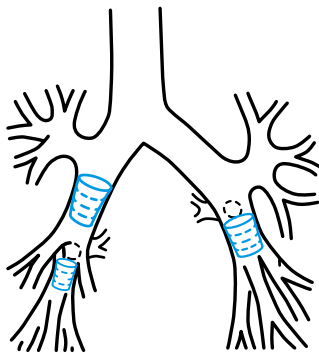

Indications:

- A complete or partial obstruction of the lower lobar bronchus with unscathed basal ones
- A complete or partial obstruction of the common trunk of the basal ones in the lower lobe (right or left)
- A complete or partial obstruction of the intermediate bronchus
- A combination of the ones above

Miscellaneous:

The division spurs of the basal segmentaries stop the stent and prevent it from being implanted in an undesirable location. For your implant, all sizes of Stening® ROLL can be introduced through a bronchoscope number 8 or larger diameter. Once the endoscope is located near the lower intermediate or lobular bronchus, as the case may be, insert the Stening® ROLL previously lubricated and folded at the end of the bronchoscope, and then push it with the bronchoscopy forceps, until it leaves the endoscope at its opposite end and is thus accommodated in the bronchus. You can also use a standard stent loader and its bronchoscope plunger number 8, 9 or whichever you prefer. When loading the stent into the bronchoscope, remember that the widest end of the ROLL must be positioned proximally to be "looking at the bronchoscopist". Conversely, the narrower end will occupy the distal position.

Removal is easy compared to a classic stent due to the small dimensions of the Stening® ROLL.

How to Use:

Introduction technique: the procedure will be carried out under general anesthesia.

The implantation of this type of prosthesis requires the use of a conventional introducer for silicone prostheses.

The airway will be accessed with a rigid tracheoscope. The length and clearance of the trachea or bronchus in the segment in which the stent will be housed must be estimated in order to make the correct choice of prosthesis.

Retrograde mode of Implant:

1. Lubricate the introducer nozzle with lidocaine gel, preventing the lubricant from reaching the operator's fingers.
2. Fold the Stening® over its axial axis and put it inside the prostheses introducer through its nozzle, with the narrowest end of the stent in the distal position.
3. Remove the nozzle.
4. Pass the injured area with the bronchoscope tube and locate its distal end or bevel on the healthy mucosa, exceeding the affected area by 5 to 7 mm.
5. Place the introducer inside the endoscope.
6. Press the ejector while extracting the endoscope in equal measure in which the plunger progresses inside. The prosthesis will be released. If necessary, it can be accommodated with an alligator forceps. The maneuver is simpler if the stent is "lower" than the lesion.

Antegrade mode of implant: steps 1, 2 and 3 will be repeated.

Stop the endoscope containing the introducer and prosthesis 5 mm before injury. Then slowly press the ejector plunger. In this way the prosthesis will advance inside the area to be treated. When the stent starts to abandon the endoscope interior you will feel a small reduction of the resistance in the pressure performed on the plunger.

A prosthesis loader can be used to propel the stent through the interior of the endoscope, or the method that the operator deems appropriate.

Correction of the stent position: The stent may require additional maneuvers in order to correct or adjust its final position. It is preferable to correct a stent that has been implanted beyond the desired position. It is highly inconvenient to advance a prosthesis that has been released before the lesion to be treated.

Extraction technique: the intubation will be carried out with a rigid endoscope.

The stent must be taken by its edge with an alligator forceps, with enough steadiness. Rotate the forceps 360° so the stent folds on itself taking an omega shape and loses its radial resistance to compression. Next, pull the forceps by removing the prosthesis together with the endoscope. You can insert the proximal end of the stent into the endoscope. This way, the vocal cords are protected during the extraction.

Other implant and removal methods are also possible depending on the experiences and preferences of the surgeon.

Cares:

- Maintain the moisture of the secretions when they exist, by making frequent nebulizations with warm isotonic saline solution.
- Periodic control must be done according to medical criteria.

Features

- Medical grade silicone
- Bevelled edges to prevent granulomas
- Spur system to prevent migration
- Removable
- Surface of maximum softness to avoid adherence of secretions
- Transparent or Radiopaque

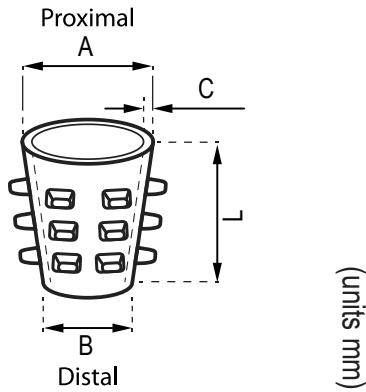

References		Dimensions (mm)			
Translucent	Radiopaque	Length (L)	Larger diameter (A)	Smaller diameter (B)	Wall thickness (C)
ROLL1012	ROLLX1012	25	12	10	1.2
ROLL810	ROLLX810	20	10	8	1.1
ROLL911	ROLLX911	20	11	9	1.1

Stening® provides detailed instructions for use with each device, including insertion and removal techniques, precautions, and postoperative care.

For custom made devices you can [contact us](#)

A radiopaque device can be white or pale yellow.

Due to the characteristics of the production process, the sizes of the devices may vary by +/- 2%

Warning: the product should not be reused because this can cause cross contamination.

Tracheal Stenosis Stent

Code: SET



It is a tracheal stent of easy implant and removal. It is especially suitable for the benign stenosis treatment. With a 14, 15 and 16 mm diameter on its extremes and a 12, 13 and 14 mm diameter respectively on its central portion, constitutes a profile that increase the difficulty of its spontaneous displacement after being introduced.

The stents for tracheal stenosis (SET) have a 5 mm longer version: "L". These variants are how Stening® responds to the needs on treatment for special clinical situations.

Indications:

- Simple tracheal stenosis
- Complex and long tracheal stenosis
- Stenosis combined with malacia or compression
- After laser resection, cryotherapy or electrocautery, to maintain the airway opened
- Post infectious stenosis (endobronchial tuberculosis, histoplasmosis mediastinal fibrosis, herpes virus, diphtheria)
- Post anastomosis surgical tracheal stenosis
- Architecture modifications, deformity, bending (senile trachea)
- Extrinsic compression

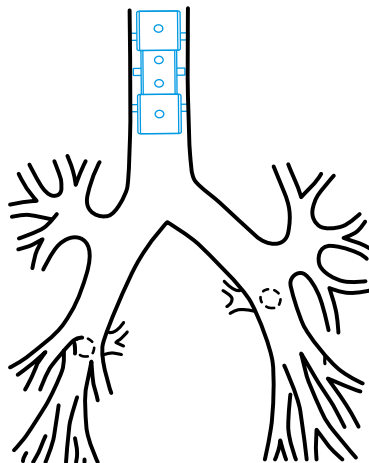

How to Use:

Introduction technique: the procedure will be carried out under general anesthesia.

The implant of these type of prostheses can be performed directly through the work channel of the tracheoscope or bronchoscope. A conventional introducer for silicone prostheses can be used as well. A rigid endoscope will be used to access the airway.

The length and diameter of the area that the stent will cover must be established correctly. If you want to know the length of the area, you can mark the endoscope when its extreme is located at the end of the injury. Repeat the process once the tracheoscope is moved up to the beginning of the injury. The diameter of the trachea or bronchi must be estimated by comparing it with the diameter of the endoscope used.

Retrograde mode of Implant:

1. Lubricate the introducer nozzle with lidocaine gel, preventing the lubricant from reaching the operator's fingers.
2. Fold the Stening® over its axial axis and put it inside the prostheses introducer through its nozzle.
3. Remove the nozzle.
4. Pass the injured area with the bronchoscope tube and locate its distal end or bevel on the healthy mucosa, exceeding the affected area by 5 to 7 mm.
5. Place the introducer inside the endoscope.
6. Press the ejector while extracting the endoscope in equal measure in which the plunger progresses inside. The prosthesis will be released. If necessary, it can be accommodated with an alligator forceps. The maneuver is simpler if the stent is "lower" than the lesion.

Antegrade mode of implant: steps 1, 2 and 3 will be repeated.

Stop the endoscope containing the introducer and prosthesis 5 mm before injury. Then slowly press the ejector plunger. In this way the prosthesis will advance inside the area to be treated. When the stent starts to abandon the endoscope interior you will feel a small reduction of the resistance in the pressure performed on the plunger.

A prosthesis loader can be used to propel the stent through the interior of the endoscope, or the method that the operator deems appropriate.

Correction of the stent position: the stent may require additional maneuvers in order to correct or adjust its final position. It is preferable to correct a stent that has been released beyond the desired position. It is highly inconvenient to advance a prosthesis that has been released before the lesion to be treated.

To move a stent in a proximal way it has to be taken by its edge with an alligator forceps and then you must pull with kindness. To be more accurate we recommend this maneuver: take the stent by its edge. Then, advance with the optical vision through the stent until you see its distal end. Now pull the forceps and you will be able to see how the stent ascends through the airway.

Stop pulling when you consider that the position is correct.

Extraction technique: the intubation will be carried out with a rigid endoscope.

The stent must be taken by its edge with an alligator forceps, with enough steadiness. Rotate the forceps 360° so the stent folds on itself taking an omega shape and loses its radial resistance to compression. Next, pull the forceps by removing the prosthesis together with the endoscope. You can insert the proximal end of the stent into the endoscope. This way, the vocal cords are protected during the extraction.

Other implant and removal methods are also possible depending on the experiences and preferences of the surgeon.

Cares:

- Maintain the moisture of secretions, whenever they appear, by taking nebulizations frequently with a warm isotonic saline solution
- Perform a periodic check-up following your doctor's advice
- Take care of your oral hygiene and treat cavities

Features

- Medical grade silicone
- Bevelled edges to prevent granulomas
- Spur system to prevent migration
- Removable
- Surface of maximum softness to avoid adherence of secretions
- Transparent or Radiopaque

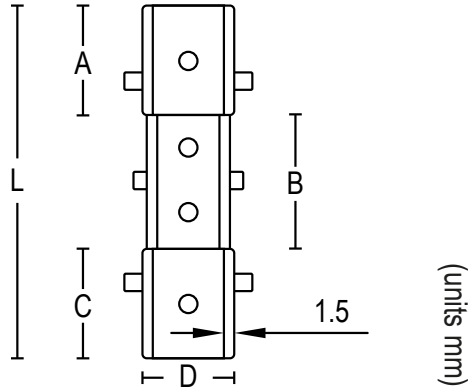

References		Dimensions (mm)				
Translucent	Radiopaque	Diameter (D)	Length (L)	A	B	C
SET14-12	SETX14-12	14	40	10	20	10
SET14-12L	SETX14-12L	14	45	12.5	20	12.5
SET15-13	SETX15-13	15	40	10	20	10
SET15-13L	SETX15-13L	15	45	12.5	20	12.5
SET16-14	SETX16-14	16	50	14.5	21	14.5
SET16-14L	SETX16-14L	16	55	17	21	17

Stening® provides detailed instructions for use with each device, including insertion and removal techniques, precautions, and postoperative care.

For custom made devices you can [contact us](#)

A radiopaque device can be white or pale yellow.

Due to the characteristics of the production process, the sizes of the devices may vary by +/- 2%

Warning: the product should not be reused because this can cause cross contamination.

Tracheocarino bronchial Stent ("Y" shaped)

Code: SY



Flexible tracheo-carino-bronchial prosthesis for supporting tracheal bifurcation and carinal angle, able to maintain ventilation through the main bronchi in very advanced obstructive conditions.

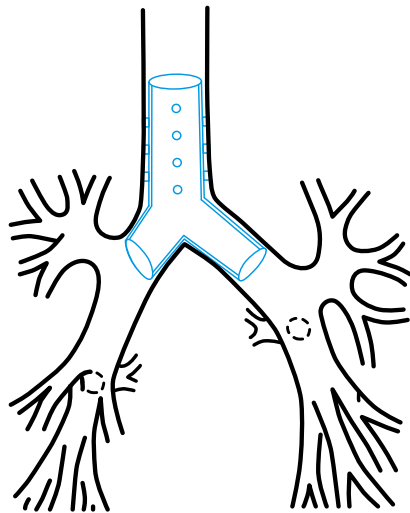

Indications:

- Tracheal neoplasms
- Long tracheobronchial neoplasm, with or without a compromise for the carina and/or its slopes
- Neoplasms that affect both sources
- Esophageal carcinoma with an airway invasion
- Tracheoesophageal or tracheocutaneous fistula
- After laser resection, cryotherapy or electrocautery, to maintain the airway opened
- Extrinsic compression or compromise of the submucosa
- Tracheal stenosis
- Tracheobronchial stenosis
- Tracheo-broncho-malacia
- Amyloidosis
- Excessive dynamic compression of the airway

Miscellaneous:

It also admits other uses according to doctor's judgment due to its length and designing.

The Stening® "Y" has been used with success in tracheostomized patients and in mechanical respiratory assistance, in combination with tracheostomy cannula, to allow ventilation in seriously ill patients when other methods are not possible.

How to Use:

Implant:

The process will take place under general anesthesia. This kind of implants must be carried out by experienced staff. The stent can be fitted on a special forceps that is used for "Y" prosthesis implant.

Lubricate the forceps' margin with lidocaine gel. Introduce it inside the stent in order to make its valves penetrate into its bronchial branches. Ventilate the patient with oxygen until you reach the higher saturation possible. After that we will proceed to the patient extubation by removing the tracheoscope from the airway. Immediately, and with the laryngoscope help, the forceps will be guided towards the trachea. When you close the forceps' valves the bronchial branches from the stent will join, and, in this position, it will pass through the vocal cords towards the trachea. The maneuver will continue to displace the forceps-stent assembly inside the trachea until it approaches to the carina. When the edge of the forceps-stent assembly is close to the tracheal carina, the valves must open kindly so that they can notice the prosthesis arrival to the tracheal bifurcation.

At this moment, the valves will open completely so that the stent bronchial branches can be introduced inside the source bronchus. Then the button from the forceps that holds the stent against the carinal edge will be pushed at the same time the forceps is removed. The maneuver must be fast, knowing that it is carried out while the patient is extubated and in apnea.

To make sure that the stent does not go to the esophagus and that it cross the vocal cords safely, use direct optic vision.

To verify if the stent passes through the glottis, the optic must accompany the forceps in a parallel way during the maneuver.

This is only possible if a second surgeon holds the laryngoscope in a suitable intubation position, whilst the bronchoscopist holds the forceps with his right hand and the optic with his left hand.

Other ways of implant are possible; for instance, the insertion of a bended prosthesis inside a bronchoscope with the right size, then pushing the stent through the bronchoscope interior with an alligator forceps or a smaller diameter bronchoscope when it is closer to the tracheal carina.

The maneuver can be completed by adjusting the prosthesis with a forceps.

Removal:

We will proceed to the patient's intubation with a tracheoscope.

The extraction is easier. The stent must be taken by its proximal border with a strong forceps to remove it kindly by pulling the forceps and removing the prosthesis at the same time you remove the tracheoscope.

Cares:

- Despite its size, the Stening® Y stent are well-tolerated. However, its larger length increases the difficulty of getting rid of secretions, and even more when the cough is not effective
- Perform nebulizations frequently and if you notice an increase on bronchial secretions attend your kinesiologist daily
- The appearance of excessive cough may suggest an unwanted touch of one or both stent bronchial branches with the inflamed bronchial mucosa
- If the symptom persists or becomes irrepressible in spite of the anti-inflammatory treatment, removing the stent may be necessary and then introduce a new one with the bronchial branches length shortened
- Take care of your oral hygiene and treat cavities

Features

- Medical grade silicone
- Bevelled edges to prevent granulomas
- Spur system to prevent migration
- Removable
- Surface of maximum softness to avoid adherence of secretions
- Transparent or Radiopaque

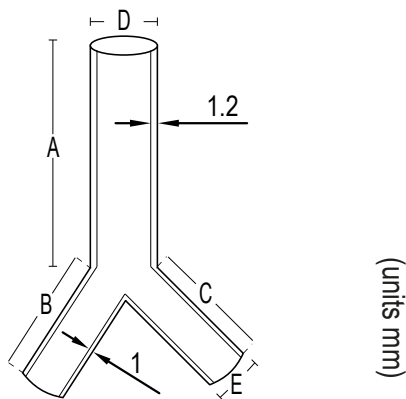

References		Dimensions (mm)				
Translucent	Radiopaque	Tracheal Length (A)	Bronchial Length (B)	Bronchial Length (C)	Tracheal diameter (D)	Bronchial Diameters (E)
SY13-11-11	SYX13-11-11	90	50	50	13	11
SY15-12-12	SYX15-12-12	110	50	50	15	12
SY16-13-13	SYX16-13-13	110	50	50	16	13
SY18-14-14	SYX18-14-14	110	50	50	18	14

Stening® provides detailed instructions for use with each device, including insertion and removal techniques, precautions, and postoperative care.

For custom made devices you can [contact us](#)

A radiopaque device can be white or pale yellow.

Due to the characteristics of the production process, the sizes of the devices may vary by +/- 2%

Warning: the product should not be reused because this can cause cross contamination.

Tracheocarino bronchial Stent (occlusive)

Code: SYO



Flexible tracheocarino bronchial prosthesis for supporting tracheal bifurcation and carinal angle, able to maintain ventilation through the main bronchi in very advanced obstructive conditions.

It has one of its bronchial branches completely occluded on its origin. Thereby, the stent satisfies a special function, allowing the ventilation from the healthy lung on patients with a postsurgical bronchopleural fistula or from other etiologies and that require mechanical respiratory assistance.

The occluded branch impedes the air flow loss through the vast communication with the pleural cavity.

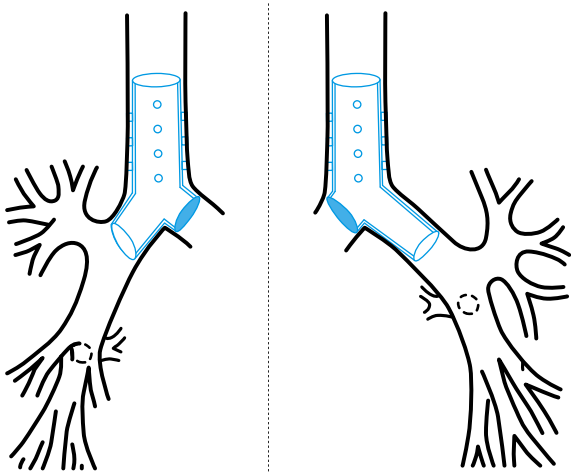

Indications:

- A right or left bronchopleural fistula, from any etiology, with or without the MRA (Mechanical Respiratory Assistance) need
- A bronchopleural fistula accompanied by empyema on patients with a tube drainage or buleau

How to Use:

The maneuvers needed for the implant of the standard Stening® “Y” are described below, although it is not essential to use the special “Y” stent forceps, since this device has only one bronchial branch. The implant will be carried out then by introducing the stent inside a tracheoscope, to, afterwards, intubate the airway with the set.

When loading the stent into the endoscope, the bronchial branch should be oriented in the direction that allows it to occupy in the airway the source bronchus or the affected stump.

Once the patient is intubated, advance inside the trachea until you approach to the carina. The stent will then be pressed with a forceps, in order to force it to leave the tracheoscope and remain lodged in the trachea. The final position can be adjusted with the same forceps, so that the only bronchial branch of the stent is lodged within the chosen bronchus source.

“Y” Stening® implant:

The process will take place under general anesthesia. This kind of implants must be carried out by experienced staff. The stent can be fitted on a special forceps that is used for “Y” prosthesis’ implant.

Lubricate the forceps’ margin with lidocaine gel. Introduce it inside de stent in order to make its valves penetrate into its bronchial branches. Ventilate the patient with oxygen until you reach the higher saturation possible. After that we will proceed to the patient extubation by removing the tracheoscope from the airway. Immediately, and with the laryngoscope help, the forceps will be guided towards the trachea.

When you close the forceps’ valves the bronchial branches from the stent will join, and, in this position, it will pass through the vocal cords towards the trachea. The manoeuvre will continue to displace the forceps-stent assembly inside the trachea until it approaches to the carina. When the edge of the forceps-stent assembly is close to the tracheal carina, the valves must open kindly so that they can notice the prosthesis arrival to the tracheal bifurcation.

Other ways of implant are possible; for instance, the insertion of a bended prosthesis inside a bronchoscope with the right size, then pushing the stent through the bronchoscope interior with an alligator forceps or a smaller diameter bronchoscope when it is closer to the tracheal carina.

The maneuver can be completed by adjusting the prosthesis with a forceps.

Removal:

First we will proceed to the intubation with the tracheoscope.

The stent must be taken by its proximal edge with a strong forceps to remove it kindly by pulling the forceps and removing the prosthesis at the same time you remove the tracheoscope.

Cares:

This device application supposes a very critical condition of the patient: a respiratory assistance is required usually at the intensive care unit.

Therefore, the care of the stent consists in frequent aspirations and a humidified airway, with the purpose of reducing the production and accumulation of secretions. It is a care usually provided in these hospitalization units.

Features

- Medical grade silicone
- Bevelled edges to prevent granulomas
- Spur system to prevent migration
- Removable
- Surface of maximum softness to avoid adherence of secretions
- Transparent or Radiopaque

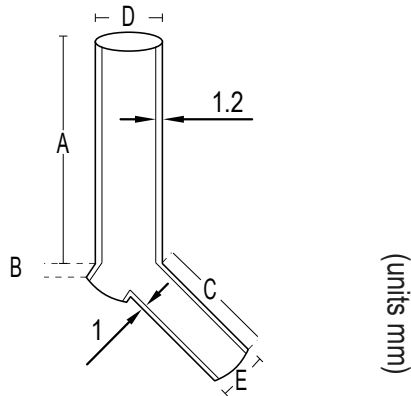

References		Dimensions (mm)				
Translucent	Radiopaque	Tracheal Length (A)	Bronchial Length (B)	Bronchial Length (C)	Tracheal diameter (D)	Bronchial Diameter (E)
SY013-11	SYOX13-11	90	5	50	13	11
SY015-12	SYOX15-12	110	5	50	15	12
SY016-13	SYOX16-13	110	5	50	16	13
SY018-14	SYOX18-14	110	5	50	18	14

Stening® provides detailed instructions for use with each device, including insertion and removal techniques, precautions, and postoperative care.

For custom made devices you can [contact us](#)

A radiopaque device can be white or pale yellow.

Due to the characteristics of the production process, the sizes of the devices may vary by +/- 2%

Warning: the product should not be reused because this can cause cross contamination.

Subglottic Stent

Code: SG



That could help to reduce the turbulence of the air flow and the secretions impaction. The subglottic stent presents an 8 mm section on its proximal edge where the wall's thickness is reduced. Throughout this section, its normal wall, of 1.5 mm, reduces its thickness gradually until it ends.

This wall's thickness decreasing achieves, on that edge, a surface of low resistance on the stent. It is meant to occupy the subglottic region, close to the vocal cords. This design allows the stent

deformation during the laryngeal movements and the glottal dynamic during swallowing and phonation. The stent fixation on the trachea will be carried out by the remaining walls of the prosthesis, of a standard shape and width.

The use of the subglottic stent can be preferred for other locations such as the middle or lower trachea or even in the source bronchi, replacing a classical stent. As it can be understood, when this stent is implanted in the source bronchus, with its "subglottic" edge in the proximal direction, the transition from the bronchial mucosa to the stent inside will be very smooth, without the "step" that accompanies the classical stent.

Indications:

- Tracheal stenosis close to the subglottis
- All indications from every tracheal and bronchial stent

Special considerations:

When the stent is introduced inside the charger or inside the bronchoscope or tracheoscope, you will have to make sure that its "subglottic" end (the one with thinner wall) remains on a proximal position (or cephalic). In other words, it must be positioned in the surgeon's direction. This is the only way in which the stent, once freed inside the airway, could achieve all its duties that make it different from the rest. The stenosis length and diameter must be carefully determined, in order to get the suitable stent with the right dimensions. The final distance between the vocal cords and the stent must be equal or greater than 2 mm. Keep in mind that the distances inside the affected trachea are difficult to estimate due to the fact that they will change when the patient acquires the standing position. A major drawback is added in the distances determination within the airway because of the muscular recovery after the metabolism of the relaxants used in the anesthetic act. Remember that, in addition, you will confront the length modifications that can occur in the trachea after being submitted to tractions and elongations because of the dilatation maneuvers carried out with the rigid tools. Even though some or all of these circumstances can be present in every tracheobronchial recanalization procedure and implant, they gain a crucial interest in the diseases that have a subglottic location. This is due to the precision that is necessary for leaving the stent only a few millimeters close to the vocal cords. This will require the best of skills and knowledge.

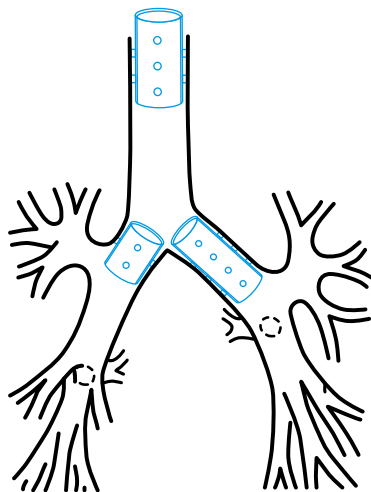

How to Use:

Introduction technique: the procedure will be carried out under general anesthesia.

The implant of these type of prostheses can be performed directly through the work channel of the tracheoscope or bronchoscope. A conventional introducer for silicone prostheses can be used as well. A rigid endoscope will be used to access the airway.

The length and diameter of the area that the stent will cover must be established correctly. If you want to know the length of the area, you can mark the endoscope when its extreme is located at the end of the injury. Repeat the process once the tracheoscope is moved up to the beginning of the injury. The diameter of the trachea or bronchi must be estimated by comparing it with the diameter of the endoscope used.

Retrograde mode of Implant:

1. Lubricate the introducer nozzle with lidocaine gel, preventing the lubricant from reaching the operator's fingers.
2. Fold the Stening® over its axial axis and put it inside the prostheses introducer through its nozzle.
3. Remove the nozzle.
4. Pass the injured area with the bronchoscope tube and locate its distal end or bevel on the healthy mucosa, exceeding the affected area by 5 to 7 mm.
5. Place the introducer inside the endoscope.
6. Press the ejector while extracting the endoscope in equal measure in which the plunger progresses inside. The prosthesis will be released. If necessary, it can be accommodated with an alligator forceps. The maneuver is simpler if the stent is "lower" than the lesion.

Antegrade mode of implant: steps 1, 2 and 3 will be repeated.

Stop the endoscope containing the introducer and prosthesis 5 mm before injury. Then slowly press the ejector plunger. In this way the prosthesis will advance inside the area to be treated. When the stent starts to abandon the endoscope interior you will feel a small reduction of the resistance in the pressure performed on the plunger.

A prosthesis loader can be used to propel the stent through the interior of the endoscope, or the method that the operator deems appropriate.

Correction of the stent position: the stent may require additional maneuvers in order to correct or adjust its final position. It is preferable to correct a stent that has been released beyond the desired position. It is highly inconvenient to advance a prosthesis that has been released before the lesion to be treated.

To move a stent in a proximal way it has to be taken by its edge with an alligator forceps and then you must pull with kindness. To be more accurate we recommend this maneuver: take the stent by its edge. Then, advance with the optical vision through the stent until you see its distal end. Now pull the forceps and you will be able to see how the stent ascends through the airway.

Stop pulling when you consider that the position is correct.

Extraction technique: the intubation will be carried out with a rigid endoscope.

The stent must be taken by its edge with an alligator forceps, with enough steadiness. Rotate the forceps 360° so the stent folds on itself taking an omega shape and loses its radial resistance to compression. Next, pull the forceps by removing the prosthesis together with the endoscope. You can insert the proximal end of the stent into the endoscope. This way, the vocal cords are protected during the extraction.

Cares:

- When an increase in secretions is detected, perform frequent nebulizations with a warm isotonic saline solution
- Treat cavities and take care of your oral hygiene
- Endoscopic controls must be performed following the doctor instructions

Features

- Medical grade silicone
- Bevelled edges to prevent granulomas
- Spur system to prevent migration
- Removable
- Surface of maximum softness to avoid adherence of secretions
- Transparent or Radiopaque

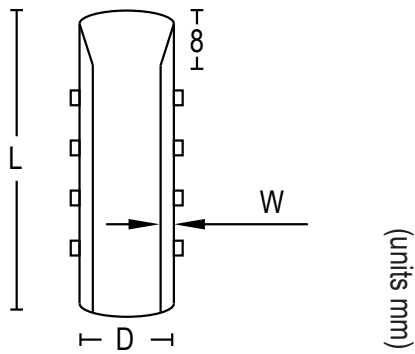

References		Dimensions (mm)		
Translucent	Radiopaque	Diameter (D)	Length (L)	Wall thickness (W)
SG13	SG13X	13	30, 40, 50, 60, 70, 80	1.5
SG14	SG14X	14	30, 40, 50, 60, 70, 80	1.5
SG15	SG15X	15	30, 40, 50, 60, 70, 80	1.5
SG16	SG16X	16	30, 40, 50, 60, 70, 80	1.5
SG17	SG17X	17	30, 40, 50, 60, 70, 80	1.5
SG18	SG18X	18	40, 60, 80, 100	1.5
SG20	SG20X	20	40, 60, 80, 100	1.5

Stening® provides detailed instructions for use with each device, including insertion and removal techniques, precautions, and postoperative care.

For custom made devices you can [contact us](#)

A radiopaque device can be white or pale yellow.

Due to the characteristics of the production process, the sizes of the devices may vary by +/- 2%

Warning: the product should not be reused because this can cause cross contamination.

Thin Wall Stent

Thin Wall Tracheobronchial Stent

Code: HE



It consists on a straight tracheobronchial stent with a thinner wall. This docility makes its implant and removal easier. It has a special utility after the neoplastic and endotracheal tissue's resection, when the affection lacks of a compressive component.

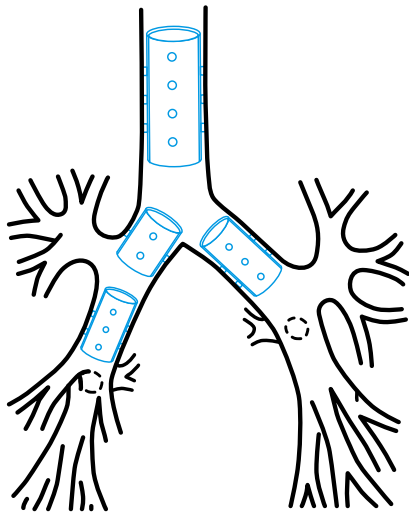

Indications:

- Primary or secondary tracheal neoplasm
- Tracheoesophageal fistula
- Tracheal rupture
- After laser resection, cryotherapy or electrocautery, to maintain the airway opened
- Tracheomalacia

Distinctive features:

A thinner wall of the prosthesis significances an increase in the stent cross section surface destined for ventilation.

The relation between the surface that occupies the wall and the clearance available for ventilation is modified favorably. In the other way round, it can be expected a lower resistance to extrinsic compression and a decrease of the cession point.

The wall's thickness decrease makes easier the introduction of the prosthesis inside the ejector or the bronchoscope. As well as the implant and removal maneuvers.

How to Use:

Introduction technique: the procedure will be carried out under general anesthesia.

The implant of these type of prostheses can be performed directly through the work channel of the tracheoscope or bronchoscope. A conventional introducer for silicone prostheses can be used as well. A rigid endoscope will be used to access the airway.

The length and diameter of the area that the stent will cover must be established correctly. If you want to know the length of the area, you can mark the endoscope when its extreme is located at the end of the injury. Repeat the process once the tracheoscope is moved up to the beginning of the injury. The diameter of the trachea or bronchi must be estimated by comparing it with the diameter of the endoscope used.

Retrograde mode of Implant:

1. Lubricate the introducer nozzle with lidocaine gel, preventing the lubricant from reaching the operator's fingers.
2. Fold the Stening® over its axial axis and put it inside the prostheses introducer through its nozzle.
3. Remove the nozzle.
4. Pass the injured area with the bronchoscope tube and locate its distal end or bevel on the healthy mucosa, exceeding the affected area by 5 to 7 mm.
5. Place the introducer inside the endoscope.
6. Press the ejector while extracting the endoscope in equal measure in which the plunger progresses inside. The prosthesis will be released. If necessary, it can be accommodated with an alligator forceps. The maneuver is simpler if the stent is "lower" than the lesion.

Antegrade mode of implant: steps 1, 2 and 3 will be repeated.

Stop the endoscope containing the introducer and prosthesis 5 mm before injury. Then slowly press the ejector plunger. In this way the prosthesis will advance inside the area to be treated. When the stent starts to abandon the endoscope interior you will feel a small reduction of the resistance in the pressure performed on the plunger.

A prosthesis loader can be used to propel the stent through the interior of the endoscope, or the method that the operator deems appropriate.

Correction of the stent position: the stent may require additional maneuvers in order to correct or adjust its final position. It is preferable to correct a stent that has been released beyond the desired position. It is highly inconvenient to advance a prosthesis that has been released before the lesion to be treated.

To move a stent in a proximal way it has to be taken by its edge with an alligator forceps and then you must pull with kindness. To be more accurate we recommend this maneuver: take the stent by its edge. Then, advance with the optical vision through the stent until you see its distal end. Now pull the forceps and you will be able to see how the stent ascends through the airway.

Stop pulling when you consider that the position is correct.

Extraction technique: the intubation will be carried out with a rigid endoscope.

The stent must be taken by its edge with an alligator forceps, with enough steadiness. Rotate the forceps 360° so the stent folds on itself taking an omega shape and loses its radial resistance to compression. Next, pull the forceps by removing the prosthesis together with the endoscope. You can insert the proximal end of the stent into the endoscope. This way, the vocal cords are protected during the extraction.

Other implant and removal methods are also possible depending on the experiences and preferences of the surgeon.

Cares:

- Maintain the moisture of secretions, whenever they appear, by taking nebulizations frequently with a warm isotonic saline solution
- Perform a periodic check-up following your doctor's advice
- Take care of your oral hygiene and treat cavities

Features

- Medical grade silicone
- Bevelled edges to prevent granulomas
- Spur system to prevent migration
- Removable
- Surface of maximum softness to avoid adherence of secretions
- Transparent or Radiopaque

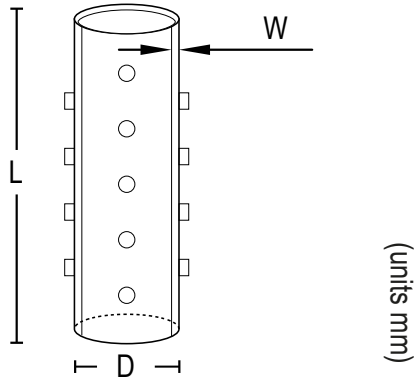

References		Dimensions (mm)		
Translucent	Radiopaque	Diameter (D)	Length (L)	Wall thickness (W)
HE13	HE13X	13	30, 40, 50, 60, 70, 80	1
HE14	HE14X	14	30, 40, 50, 60, 70, 80	1
HE15	HE15X	15	30, 40, 50, 60, 70, 80	1
HE16	HE16X	16	30, 40, 50, 60, 70, 80	1
HE18	HE18X	18	40, 60, 80, 100	1
HE20	HE20X	20	40, 60, 80, 100	1

Stening® provides detailed instructions for use with each device, including insertion and removal techniques, precautions, and postoperative care.

For custom made devices you can [contact us](#)

A radiopaque device can be white or pale yellow.

Due to the characteristics of the production process, the sizes of the devices may vary by +/- 2%

Warning: the product should not be reused because this can cause cross contamination.

High Pressure Stent

High Pressure Tracheobronchial Stent

Code: SAP



With a more robust wall, this model is very resistant to max compression.

When any stent is put under a strength test that compresses it with loads that increase progressively, a stent's gradual deformation takes place until it reaches the cession point. Here, the prosthesis suffers a higher deformation, with a notorious reduction of its radial resistance to flattening. This break point is about 900 g/cm² in a classical stent.

In the Stening® High Pressure Stent the

tolerance to compression increases surpassing the 2000 g/cm².

Its wall's thickness increase is accompanied by an inevitable reduction in the area available for air flow.

Indications:

- Tracheal neoplasms with a solid extrinsic compression
- A severe tracheal compression that occurs again after the dilatation
- In replacement of a classical stent that collapse by extrinsic compression

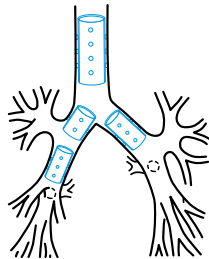

Special Indications:

The severe tracheal compressive phenomena are due to different etiologies and can be accompanied by the superior vena cava syndrome or other disorders that have an intrathoracic venous circulatory difficulty. In these cases, as in presence of a mediastinal syndrome, it must be taken into account the anticipation of the application of a vascular stent before the implant of a tracheal stent.

The high pressure stent must be used by an expert bronchoscopists.

Although the above considerations apply to the implantation of tracheal stents, the special indications for the use of a high-pressure stent should be observed since the compression tolerance of a high-pressure stent is slightly more than twice that of a classic stent. The placement of the prosthesis in the introducer can therefore be painful. It is then recommended to apply it directly through the tracheoscope. With the exception of very firm tracheal compressions, complete expansion of the stent will occur in a short time.

The removal of the prosthesis should only be done when the causes of the compressive phenomenon have disappeared. Proceed according to the extraction technique described below, but be sure to use a strong forceps.

How to Use:

Introduction technique: the procedure will be carried out under general anesthesia.

The implant of these type of prostheses can be performed directly through the work channel of the tracheoscope or bronchoscope. A conventional introducer for silicone prostheses can be used as well. A rigid endoscope will be used to access the airway.

The length and diameter of the area that the stent will cover must be established correctly. If you want to know the length of the area, you can mark the endoscope when its extreme is located at the end of the injury. Repeat the process once the tracheoscope is moved up to the beginning of the injury. The diameter of the trachea or bronchi must be estimated by comparing it with the diameter of the endoscope used.

Retrograde mode of Implant:

1. Lubricate the introducer nozzle with lidocaine gel, preventing the lubricant from reaching the operator's fingers.
2. Fold the Stening® over its axial axis and put it inside the prostheses introducer through its nozzle.
3. Remove the nozzle.
4. Pass the injured area with the bronchoscope tube and locate its distal end or bevel on the healthy mucosa, exceeding the affected area by 5 to 7 mm.
5. Place the introducer inside the endoscope.
6. Press the ejector while extracting the endoscope in equal measure in which the plunger progresses inside. The prosthesis will be released. If necessary, it can be accommodated with an alligator forceps. The maneuver is simpler if the stent is "lower" than the lesion.

Antegrade mode of implant: steps 1, 2 and 3 will be repeated.

Stop the endoscope containing the introducer and prosthesis 5 mm before injury. Then slowly press the ejector plunger. In this way the prosthesis will advance inside the area to be treated. When the stent starts to abandon the endoscope interior you will feel a small reduction of the resistance in the pressure performed on the plunger.

A prosthesis loader can be used to propel the stent through the interior of the endoscope, or the method that the operator deems appropriate.

Correction of the stent position: the stent may require additional maneuvers in order to correct or adjust its final position. It is preferable to correct a stent that has been released beyond the desired position. It is highly inconvenient to advance a prosthesis that has been released before the lesion to be treated.

To move a stent in a proximal way it has to be taken by its edge with an alligator forceps and then you must pull with kindness. To be more accurate we recommend this maneuver: take the stent by its edge. Then, advance with the optical vision through the stent until you see its distal end. Now pull the forceps and you will be able to see how the stent ascends through the airway.

Stop pulling when you consider that the position is correct.

Extraction technique: the intubation will be carried out with a rigid endoscope.

The stent must be taken by its edge with an alligator forceps, with enough steadiness. Rotate the forceps 360° so the stent folds on itself taking an omega shape and loses its radial resistance to compression. Next, pull the forceps by removing the prosthesis together with the endoscope. You can insert the proximal end of the stent into the endoscope. This way, the vocal cords are protected during the extraction.

Other implant and removal methods are also possible depending on the experiences and preferences of the surgeon.

Cares:

- Maintain the moisture of secretions, whenever they appear, by taking nebulizations frequently with a warm isotonic saline solution
- Perform a periodic check-up following your doctor's advice.
- Take care of your oral hygiene and treat cavities

Features

- Medical grade silicone
- Bevelled edges to prevent granulomas
- Spur system to prevent migration
- Removable
- Surface of maximum softness to avoid adherence of secretions
- Transparent or Radiopaque

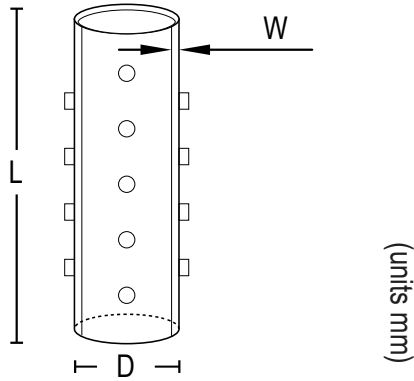

References		Dimensions (mm)		
Translucent	Radiopaque	Diameter (D)	Length (L)	Wall thickness (W)
SAP13	SAP13X	13	30, 40, 50, 60, 70, 80	2
SAP14	SAP14X	14	30, 40, 50, 60, 70, 80	2
SAP15	SAP15X	15	30, 40, 50, 60, 70, 80	2
SAP16	SAP16X	16	30, 40, 50, 60, 70, 80	2
SAP18	SAP18X	18	40, 60, 80, 100	2
SAP20	SAP20X	20	40, 60, 80, 100	2

Stening® provides detailed instructions for use with each device, including insertion and removal techniques, precautions, and postoperative care.

For custom made devices you can [contact us](#)

A radiopaque device can be white or pale yellow.

Due to the characteristics of the production process, the sizes of the devices may vary by +/- 2%

Warning: the product should not be reused because this can cause cross contamination.

Conical Bronchial Stent with side hole

Code: CLASS-LSD



The Stening® Class LSD Stent is a device designed to maintain the clearance of the airway in sufficient conditions for ventilation. It is a conical elastic tubular structure, with non-slip spurs arranged in several rows and distributed symmetrically along its surface. It has a side hole that allows ventilation of the right upper lobe.

Indications:

- Excessive dynamic compression of the airway
- Neoplasms in right or intermediate source bronchus that do not affect the upper lobe
- Neoplasms that invade tracheal carina or its slopes
- Postinfectious stenosis (tuberculosis, histoplasmosis with mediastinal fibrosis, herpes virus, diphtheria)
- Following laser photoresection, cryotherapy or electrocautery, to maintain the opening of the airway
- Bronchial neoplasms
- Impending atelectasis
- Bronchial stenosis
- Post-traumatic stenosis
- Post-terminal surgical bronchial anastomosis stenosis
- Bronchial rupture
- Extrinsic compression
- Bronchomalacia
- Bronchial Amyloidosis
- Invasion of bronchial sources by esophageal carcinoma
- After endoscopic resection of bronchial metastases

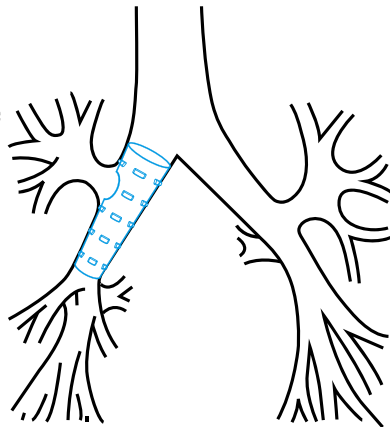

Special features:

Gradual resistance: to accompany the functionality of the bronchus and its physiology, the strength of its wall is progressively reduced distally at a rate of 3% per each centimeter of the length of the stent.

Increase in fixing capacity: although the increase in the fixing capacity of the Stening® Class LSD cannot be precisely determined with regard to its counterpart, this property is benefited by the existence of fixations aligned against the direction of possible unwanted displacement. Their number duplicates the existing ones in the straight stent model.

How to Use:

Introduction technique: the procedure will be carried out under general anesthesia. The implantation of this type of prosthesis requires the use of a conventional introducer for silicone prostheses.

The airway will be accessed with a rigid tracheoscope. The length and clearance of the trachea or bronchus in the segment in which the stent will be housed must be estimated in order to make the correct choice of prosthesis.

Retrograde mode of Implant:

1. Lubricate the introducer nozzle with lidocaine gel, preventing the lubricant from reaching the operator's fingers.
2. Fold the Stening® over its axial axis and put it inside the prostheses introducer through its nozzle, with the narrowest end of the stent in the distal position.
3. Remove the nozzle.
4. Pass the injured area with the bronchoscope tube and locate its distal end or bevel on the healthy mucosa, exceeding the affected area by 5 to 7 mm.
5. Place the introducer inside the endoscope.
6. Press the ejector while extracting the endoscope in equal measure in which the plunger progresses inside. The prosthesis will be released. If necessary, it can be accommodated with an alligator forceps. The maneuver is simpler if the stent is "lower" than the lesion.

Antegrade mode of implant: steps 1, 2 and 3 will be repeated.

Stop the endoscope containing the introducer and prosthesis 5 mm before injury. Then slowly press the ejector plunger. In this way the prosthesis will advance inside the area to be treated. When the stent starts to abandon the endoscope interior you will feel a small reduction of the resistance in the pressure performed on the plunger.

A prosthesis loader can be used to propel the stent through the interior of the endoscope, or the method that the operator deems appropriate.

Correction of the stent position: the stent may require additional maneuvers in order to correct or adjust its final position. It is preferable to correct a stent that has been released beyond the desired position. It is highly inconvenient to advance a prosthesis that has been released before the lesion to be treated.

To move a stent in a proximal way it has to be taken by its edge with an alligator forceps and then you must pull with kindness. To be more accurate we recommend this maneuver: take the stent by its edge. Then, advance with the optical vision through the stent until you see its distal end. Now pull the forceps and you will be able to see how the stent ascends through the airway.

Stop pulling when you consider that the position is correct.

LSD models may require a "rotation" adjustment, so that the lateral hole of the stent faces the entrance to the right upper lobe bronchus.

Extraction technique: the intubation will be carried out with a rigid endoscope.

The stent must be taken by its edge with an alligator forceps, with enough steadiness. Rotate the forceps 360° so the stent folds on itself taking an omega shape and loses its radial resistance to compression. Next, pull the forceps by removing the prosthesis together with the endoscope. You can insert the proximal end of the stent into the endoscope. This way, the vocal cords are protected during the extraction.

Other implant and removal methods are also possible depending on the experiences and preferences of the surgeon.

Cares:

- Maintain the moisture of the secretions when they exist, by making frequent nebulizations with warm isotonic saline solution
- Periodic control must be done according to medical criteria
- Treat dental caries and perform effective oral hygiene

Warning:

This device is an anatomical, slightly conical stent, therefore:

1. Remember that the stent should always be inserted into the bronchoscope with the larger diameter end in a proximal position, and the narrowest end in distal one.
2. If it is necessary to shorten the stent, it is preferable to make the cut close to its distal end. In other words, near the end of the smaller diameter.
3. As the name implies, LSD models are only useful in the right hemi-tree. In Class LSD models, when loading the stent into the introducer or the bronchoscope, remember to orient the lateral hole of the stent towards the entrance of the right upper lobe bronchus, which is usually at 3 o'clock. Check this location previously during the bronchoscopic examination and once again after the implant.

Features

- Medical grade silicone
- Bevelled edges to prevent granulomas
- Spur system to prevent migration
- Removable
- Surface of maximum softness to avoid adherence of secretions
- Transparent or Radiopaque

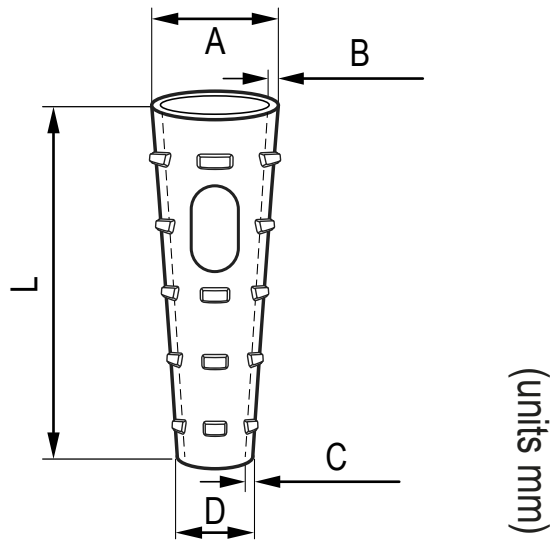

References		Dimensions (mm)				
Translucent	Radiopaque	Length (L)	Larger diameter (A)	Wider wall (B)	Narrower wall (C)	Smaller diameter (D)
CLASS-LSD10-30	CLASS-LSDX10-30	30	10	1.1	0.9	9.1
CLASS-LSD10-40	CLASS-LSDX10-40	40	10	1.1	0.9	8.8
CLASS-LSD10-50	CLASS-LSDX10-50	50	10	1.1	0.9	8.5
CLASS-LSD11-30	CLASS-LSDX11-30	30	11	1.1	0.9	9.9
CLASS-LSD11-40	CLASS-LSDX11-40	40	11	1.1	0.9	9.4
CLASS-LSD11-50	CLASS-LSDX11-50	50	11	1.1	0.9	9
CLASS-LSD12-30	CLASS-LSDX12-30	30	12	1.2	1	10.9
CLASS-LSD12-40	CLASS-LSDX12-40	40	12	1.2	1	10.4
CLASS-LSD12-50	CLASS-LSDX12-50	50	12	1.2	1	10
CLASS-LSD13-30	CLASS-LSDX13-30	30	13	1.3	1.1	11.8
CLASS-LSD13-40	CLASS-LSDX13-40	40	13	1.3	1.1	11.4
CLASS-LSD13-50	CLASS-LSDX13-50	50	13	1.3	1.1	11
CLASS-LSD14-30	CLASS-LSDX14-30	30	14	1.4	1.2	12.8
CLASS-LSD14-40	CLASS-LSDX14-40	40	14	1.4	1.2	12.4
CLASS-LSD14-50	CLASS-LSDX14-50	50	14	1.4	1.2	12

Stening® provides detailed instructions for use with each device, including insertion and removal techniques, precautions, and postoperative care.

For custom made devices you can [contact us](#)

A radiopaque device can be white or pale yellow.

Due to the characteristics of the production process, the sizes of the devices may vary by +/- 2%

Warning: the product should not be reused because this can cause cross contamination.

Bronchial Stent with side hole

Code: ST-LSD



The Stening® Bronchial stent with a lateral hole is useful for diseases in the main right bronchus or the intermediate one when you want to preserve the ventilation of the upper lobe through the lateral hole of the stent. The hole must be orientated to this lobe.

Indications:

- Neoplasms in the main right bronchus or intermediate one that do not affect the upper lobe
- Extrinsic compression that do not affect the upper lobe

The use of this stent is exclusive for diseases that take place in the main right bronchus or the intermediate one that have an unscathed upper lobe. So, pay particular attention on orientating the stent inside the ejector and this one inside the bronchoscope. In order to leave the stent lateral hole confronted with the right upper lobar entrance when the stent is freed inside the bronchus. Once implanted, the air will flow to the upper lobe through the lateral hole of the Stening® LSD.

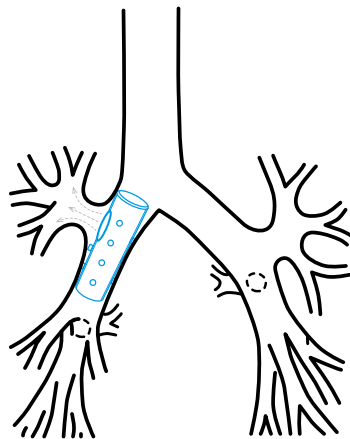

How to Use:

The removal and introduction technique described in the Stening Tracheobronchial Stent can be followed. But the tracheoscope must be replaced by a bronchoscope with a diameter of 10 or 11 mm.

Introduction technique: the procedure will be carried out under general anesthesia.

The implant of these type of prostheses can be performed directly through the work channel of the tracheoscope or bronchoscope. A conventional introducer for silicone prostheses can be used as well. A rigid endoscope will be used to access the airway.

The length and diameter of the area that the stent will cover must be established correctly. If you want to know the length of the area, you can mark the endoscope when its extreme is located at the end of the injury. Repeat the process once the tracheoscope is moved up to the beginning of the injury. The diameter of the trachea or bronchi must be estimated by comparing it with the diameter of the endoscope used.

Retrograde mode of Implant:

1. Lubricate the introducer nozzle with lidocaine gel, preventing the lubricant from reaching the operator's fingers.
2. Fold the Stening® over its axial axis and put it inside the prostheses introducer through its nozzle.
3. Remove the nozzle.
4. Pass the injured area with the bronchoscope tube and locate its distal end or bevel on the healthy mucosa, exceeding the affected area by 5 to 7 mm.
5. Place the introducer inside the endoscope.
6. Press the ejector while extracting the endoscope in equal measure in which the plunger progresses inside. The prosthesis will be released. If necessary, it can be accommodated with an alligator forceps. The maneuver is simpler if the stent is "lower" than the lesion.

Antegrade mode of implant: steps 1, 2 and 3 will be repeated.

Stop the endoscope containing the introducer and prosthesis 5 mm before injury. Then slowly press the ejector plunger. In this way the prosthesis will advance inside the area to be treated. When the stent starts to abandon the endoscope interior you will feel a small reduction of the resistance in the pressure performed on the plunger.

A prosthesis loader can be used to propel the stent through the interior of the endoscope, or the method that the operator deems appropriate.

Correction of the stent position: the stent may require additional maneuvers in order to correct or adjust its final position. It is preferable to correct a stent that has been released beyond the desired position. It is highly inconvenient to advance a prosthesis that has been released before the lesion to be treated.

To move a stent in a proximal way it has to be taken by its edge with an alligator forceps and then you must pull with kindness. To be more accurate we recommend this maneuver: take the stent by its edge. Then, advance with the optical vision through the stent until you see its distal end. Now pull the forceps and you will be able to see how the stent ascends through the airway.

Stop pulling when you consider that the position is correct.

LSD models may require a "rotation" adjustment, so that the lateral hole of the stent faces the entrance to the right upper lobe bronchus.

Extraction technique: the intubation will be carried out with a rigid endoscope.

The stent must be taken by its edge with an alligator forceps, with enough steadiness. Rotate the forceps 360° so the stent folds on itself taking an omega shape and loses its radial resistance to compression. Next, pull the forceps by removing the prosthesis together with the endoscope. You can insert the proximal end of the stent into the endoscope. This way, the vocal cords are protected during the extraction.

Other implant and removal methods are also possible depending on the experiences and preferences of the surgeon.

Features

- Medical grade silicone
- Bevelled edges to prevent granulomas
- Spur system to prevent migration
- Removable
- Surface of maximum softness to avoid adherence of secretions
- Transparent or Radiopaque

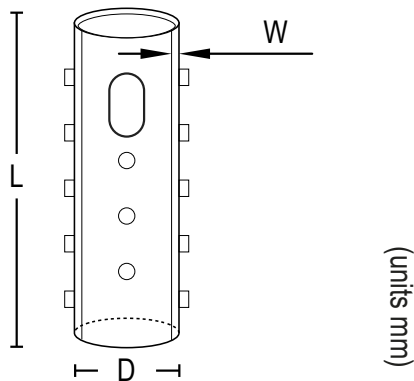

References		Dimensions (mm)		
Translucent	Radiopaque	Diameter (D)	Length (L)	Wall thickness (W)
ST-LSD10-30	ST-LSDX10-30	10	30	1
ST-LSD10-40	ST-LSDX10-40	10	40	1
ST-LSD10-50	ST-LSDX10-50	10	50	1
ST-LSD11-30	ST-LSDX11-30	11	30	1.1
ST-LSD11-40	ST-LSDX11-40	11	40	1.1
ST-LSD11-50	ST-LSDX11-50	11	50	1.1
ST-LSD12-30	ST-LSDX12-30	12	30	1.2
ST-LSD12-40	ST-LSDX12-40	12	40	1.2
ST-LSD12-50	ST-LSDX12-50	12	50	1.2
ST-LSD13-30	ST-LSDX13-30	13	30	1.5
ST-LSD13-40	ST-LSDX13-40	13	40	1.5
ST-LSD13-50	ST-LSDX13-50	13	50	1.5
ST-LSD14-30	ST-LSDX14-30	14	30	1.5
ST-LSD14-40	ST-LSDX14-40	14	40	1.5
ST-LSD14-50	ST-LSDX14-50	14	50	1.5

Stening® provides detailed instructions for use with each device, including insertion and removal techniques, precautions, and postoperative care.

For custom made devices you can [contact us](#)

A radiopaque device can be white or pale yellow.

Due to the characteristics of the production process, the sizes of the devices may vary by +/- 2%

Warning: the product should not be reused because this can cause cross contamination.

Occlusive Solid Stent - large (2 units pack)

Code: MS02



Stening® Solid Stents are made out of silicone and intended for bronchial occlusion in the treatment of different bronchopleural pulmonary affections such as the bronchopleural fistula and persistent air loss in pneumothorax cases that cannot be treated with conventional surgery.

These solid stents are radiopaque and may be white or pale yellow in color.

Indications:

- Bronchopleural fistula
- Suture failure in a stump after lobar pulmonary resection
- Occluded bronchial treatment
- Hemoptysis

Warning: this type of device may suffer an unexpected displacement. This will depend on the failed choice of stent caliber in relation to the bronchial or fistulous orifice where it has been placed, as well as the unpredictable individual reaction of the tissue that acts as support in the implant area. A device that has migrated may be removed by coughing or accidentally lodged in another bronchus in the same or adjacent lung, resulting in unwanted bronchial occlusion that may lead to severe ventilatory insufficiency and subsequent death.

A displacement of the occlusion device towards the pleural cavity in cases of post-pneumectomy fistula is possible, and also its spontaneous elimination through an

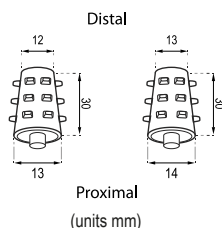
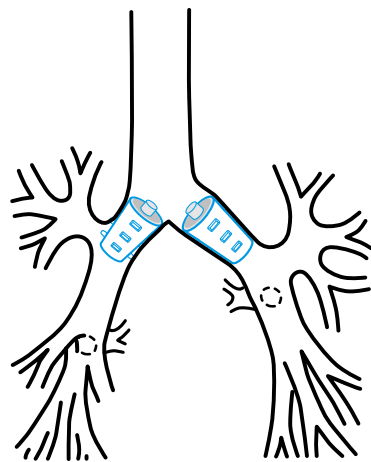

existing pleurocutaneous window. An anomalous position may be suspected by the appearance of a sustained cough. The devices are radiopaque and their position can be identified on chest radiography. A displaced device must be removed by the interventional physician.

How to Use:

The Stening® Solid Stent is implanted with the help of a rigid bronchoscope and it will be required general anesthesia.

Once the location spot has been determined and its size, which is established by comparison with the known diameter of the endoscopic instruments that are being used, one or a few solid stents with the right measures, that exceed the fistulous hole diameter or the bronchus diameter, will be chosen. This is done in order to adjust the stent to the bronchus or stump where it will be hosted.

The device has an appendage at its posterior end from where it will be taken with a rigid alligator forceps.

Then the **stent-forceps** assembly is introduced through the bronchoscope to lead it to its final destination in the bronchus or fistula that is desired to be occluded by introducing the Stening® Solid Stent into the hole.

All the procedure described is carried out under direct vision using the optics for bronchoscopy.

The removal is done performing the inverse maneuvers.

Due to its radiopaque properties, it can be identified in the radiographies.

Cares:

- Maintain the moisture of the secretions when they exist, by making frequent nebulizations with warm isotonic saline solution.
- Periodic control must be done according to medical criteria.

Features

- Medical grade silicone
- Bevelled edges to prevent granulomas
- Spur system to prevent migration
- Removable
- Surface of maximum softness to avoid adherence of secretions
- Transparent or Radiopaque

Presentation:

The Stening® Solid Stent MS02 pack, is supplied in a container that has two units of 30 mm length:

- **MS1213:** 12mm distal diameter - 13 mm proximal diameter
- **MS1314:** 13mm distal diameter - 14 mm proximal diameter

Stening® provides detailed instructions for use with each device, including insertion and removal techniques, precautions, and postoperative care.

For custom made devices you can [contact us](#)

A radiopaque device can be white or pale yellow.

Due to the characteristics of the production process, the sizes of the devices may vary by +/- 2%

Warning: the product should not be reused because this can cause cross contamination.

Occlusive Solid Stent (3 units pack)

Code: MS03

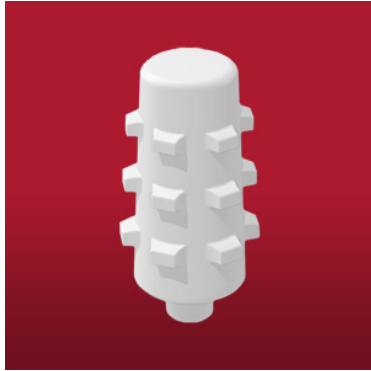

Stening® Solid Stents are made out of silicone and intended for bronchial occlusion in the treatment of different bronchopleural pulmonary affections such as the bronchopleural fistula and persistent air loss in pneumothorax cases that cannot be treated with conventional surgery.

These solid stents are radiopaque and may be white or pale yellow in color.

Indications:

- Bronchopleural fistula
- Suture failure in a stump after lobar pulmonary resection
- Occluded bronchial treatment
- Hemoptysis

Warning: this type of device may suffer an unexpected displacement. This will depend on the failed choice of stent caliber in relation to the bronchial or fistulous orifice where it has been placed, as well as the unpredictable individual reaction of the tissue that acts as support in the implant area. A device that has migrated may be removed by coughing or accidentally lodged in another bronchus in the same or adjacent lung, resulting in unwanted bronchial occlusion that may lead to severe ventilatory insufficiency and subsequent death.

A displacement of the occlusion device towards the pleural cavity in cases of post-pneumectomy fistula is possible, and also its spontaneous elimination through an

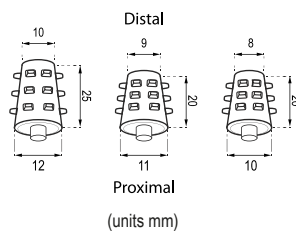
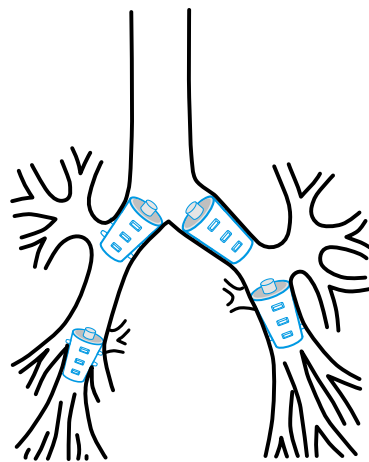

existing pleurocutaneous window. An anomalous position may be suspected by the appearance of a sustained cough. The devices are radiopaque and their position can be identified on chest radiography. A displaced device must be removed by the interventional physician.

How to Use:

The Stening® Solid Stent is implanted with the help of a rigid bronchoscope and it will be required general anesthesia.

Once the location spot has been determined and its size, which is established by comparison with the known diameter of the endoscopic instruments that are being used, one or a few solid stents with the right measures, that exceed the fistulous hole diameter or the bronchus diameter, will be chosen. This is done in order to adjust the stent to the bronchus or stump where it will be hosted.

The device has an appendage at its posterior end from where it will be taken with a rigid alligator forceps.

Then the **stent-forceps** assembly is introduced through the bronchoscope to lead it to its final destination in the bronchus or fistula that is desired to be occluded by introducing the Stening® Solid Stent into the hole.

All the procedure described is carried out under direct vision using the optics for bronchoscopy.

The removal is done performing the inverse maneuvers.

Due to its radiopaque properties, it can be identified in the radiographies.

Cares:

- Maintain the moisture of the secretions when they exist, by making frequent nebulizations with warm isotonic saline solution.
- Periodic control must be done according to medical criteria.

Features

- Medical grade silicone
- Bevelled edges to prevent granulomas
- Spur system to prevent migration
- Removable
- Surface of maximum softness to avoid adherence of secretions
- Transparent or Radiopaque

Presentation:

The Stening® Solid Stent MS03 pack, is supplied in a container that has three units:

- **MS810:** 8 mm distal diameter - 10 mm proximal diameter - 20 mm length
- **MS911:** 9 mm distal diameter - 11 mm proximal diameter - 20 mm length
- **MS1012:** 10 mm distal diameter - 12 mm proximal diameter - 25 mm length

Stening® provides detailed instructions for use with each device, including insertion and removal techniques, precautions, and postoperative care.

For custom made devices you can [contact us](#)

A radiopaque device can be white or pale yellow.

Due to the characteristics of the production process, the sizes of the devices may vary by +/- 2%

Warning: the product should not be reused because this can cause cross contamination.

Occlusive Solid Stent - medium (3 units pack)

Code: MSO3M

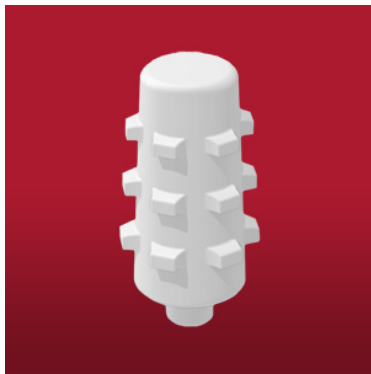

Stening® Solid Stents are made out of silicone and intended for bronchial occlusion in the treatment of different bronchopleural pulmonary affections such as the bronchopleural fistula and persistent air loss in pneumothorax cases that cannot be treated with conventional surgery.

These solid stents are radiopaque and may be white or pale yellow in color.

Indications:

- Bronchopleural fistula
- Suture failure in a stump after lobar pulmonary resection
- Occluded bronchial treatment
- Hemoptysis

Warning: this type of device may suffer an unexpected displacement. This will depend on the failed choice of stent caliber in relation to the bronchial or fistulous orifice where it has been placed, as well as the unpredictable individual reaction of the tissue that acts as support in the implant area. A device that has migrated may be removed by coughing or accidentally lodged in another bronchus in the same or adjacent lung, resulting in unwanted bronchial occlusion that may lead to severe ventilatory insufficiency and subsequent death.

A displacement of the occlusion device towards the pleural cavity in cases of post-pneumectomy fistula is possible, and also its spontaneous elimination through an existing pleurocutaneous window. An anomalous position may be suspected by the

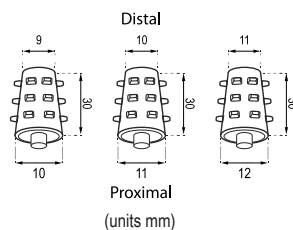
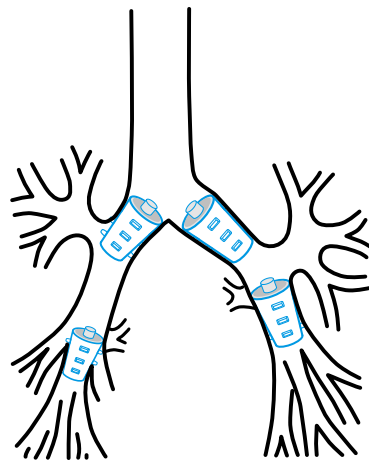

appearance of a sustained cough. The devices are radiopaque and their position can be identified on chest radiography. A displaced device must be removed by the interventional physician.

How to Use:

The Stening® Solid Stent is implanted with the help of a rigid bronchoscope and it will be required general anesthesia.

Once the location spot has been determined and its size, which is established by comparison with the known diameter of the endoscopic instruments that are being used, one or a few solid stents with the right measures, that exceed the fistulous hole diameter or the bronchus diameter, will be chosen. This is done in order to adjust the stent to the bronchus or stump where it will be hosted.

The device has an appendage at its posterior end from where it will be taken with a rigid alligator forceps.

Then the **stent-forceps** assembly is introduced through the bronchoscope to lead it to its final destination in the bronchus or fistula that is desired to be occluded by introducing the Stening® Solid Stent into the hole.

All the procedure described is carried out under direct vision using the optics for bronchoscopy.

The removal is done performing the inverse maneuvers.

Due to its radiopaque properties, it can be identified in the radiographies.

Cares:

- Maintain the moisture of the secretions when they exist, by making frequent nebulizations with warm isotonic saline solution.
- Periodic control must be done according to medical criteria.

Features

- Medical grade silicone
- Bevelled edges to prevent granulomas
- Spur system to prevent migration
- Removable
- Surface of maximum softness to avoid adherence of secretions
- Transparent or Radiopaque

Presentation:

The Stening® Solid Stent MSO3 medium pack, is supplied in a container that has three units of 30 mm length:

- **MS910:** 9mm distal diameter - 10 mm proximal diameter
- **MS1011:** 10mm distal diameter - 11 mm proximal diameter
- **MS1112:** 11mm distal diameter - 12 mm proximal diameter

Stening® provides detailed instructions for use with each device, including insertion and removal techniques, precautions, and postoperative care.

For custom made devices you can [contact us](#)

A radiopaque device can be white or pale yellow.

Due to the characteristics of the production process, the sizes of the devices may vary by +/- 2%

Warning: the product should not be reused because this can cause cross contamination.

Occlusive Solid Stent (10 units pack)

Code: MS10



Stening® Solid Stent MS10 pack is made out of silicone and intended for bronchial occlusion in the treatment of different bronchopleural pulmonary affections such as the bronchopleural fistula and persistent air loss in pneumothorax cases that cannot be treated with conventional surgery.

These solid stents are radiopaque and may be white or pale yellow in color.

Indications:

- Bronchopleural fistula
- Suture failure in a stump after lobar pulmonary resection
- Occluded bronchial treatment
- Hemoptysis

Warning: this type of device may suffer an unexpected displacement. This will depend on the failed choice of stent caliber in relation to the bronchial or fistulous orifice where it has been placed, as well as the unpredictable individual reaction of the tissue that acts as support in the implant area. A device that has migrated may be removed by coughing or accidentally lodged in another bronchus in the same or adjacent lung, resulting in unwanted bronchial occlusion that may lead to severe ventilatory insufficiency and subsequent death.

A displacement of the occlusion device towards the pleural cavity in cases of post-pneumectomy fistula is possible, and also its spontaneous elimination through an

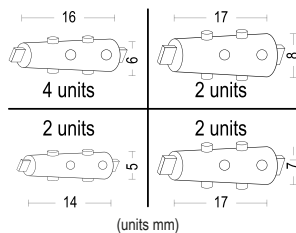
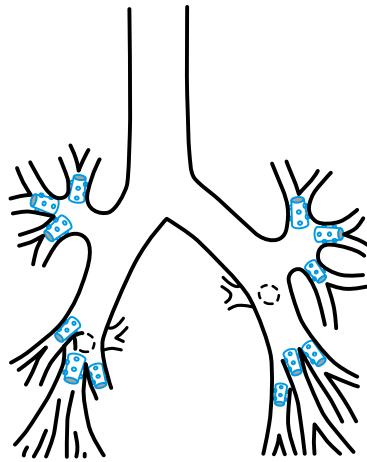

existing pleurocutaneous window. An anomalous position may be suspected by the appearance of a sustained cough. The devices are radiopaque and their position can be identified on chest radiography. A displaced device must be removed by the interventional physician.

How to Use:

The Stening® Solid Stent is implanted with the help of a rigid bronchoscope and it will be required general anesthesia.

Once the location spot has been determined and its size, which is established by comparison with the known diameter of the endoscopic instruments that are being used, one or a few solid stents with the right measures, that exceed the fistulous hole diameter or the bronchus diameter, will be chosen. This is done in order to adjust the stent to the bronchus or stump where it will be hosted.

The device has a flat appendage at its posterior end from where it will be taken with a rigid alligator forceps.

Then the **stent-forceps** assembly is introduced through the bronchoscope to lead it to its final destination in the bronchus or fistula that is desired to be occluded by introducing the Stening® Solid Stent into the hole.

All the procedure described is carried out under direct vision using the optics for bronchoscopy.

The removal is done performing the inverse maneuvers.

Due to its radiopaque properties, it can be identified in the radiographies.

Cares:

- Maintain the moisture of the secretions when they exist, by making frequent nebulizations with warm isotonic saline solution.
- Periodic control must be done according to medical criteria.

Features

- Medical grade silicone
- Bevelled edges to prevent granulomas
- Spur system to prevent migration
- Removable
- Surface of maximum softness to avoid adherence of secretions
- Transparent or Radiopaque

Presentation:

The Stening® Solid Stent MS10 pack, is supplied in a container that has two units of 5 mm of greater diameter, four of 6 mm, two of 7 mm and two of 8 mm.

Stening® provides detailed instructions for use with each device, including insertion and removal techniques, precautions, and postoperative care.

For custom made devices you can [contact us](#)

A radiopaque device can be white or pale yellow.

Due to the characteristics of the production process, the sizes of the devices may vary by +/- 2%

Warning: the product should not be reused because this can cause cross contamination.