



U2<sup>TM</sup> *Knee* PS CR  
Knee

Surgical Protocol



# Table of Contents

---

<b>Pre-Operative Planning</b> .....	1
<b>Surgical Incision</b> .....	2
<b>A. Femoral Preparation</b>	
A.1. Pilot Hole .....	3
A.2. Femoral Valgus Angle Confirmation .....	4
A.3. Distal Femur Cutting .....	5
A.4. Femoral Component Sizing .....	6
A.5. A-P Chamfer Cutting .....	7
<b>B. Tibial Preparation</b>	
B.1. Tibial Intramedullary Alignment Method .....	8
B.1.1. Pilot Hole .....	8
B.1.2. Tibial Cutting Jig Positioning and Tibial Resection .....	9
B.2. Tibial Extramedullary Alignment Method .....	10
<b>C. Trial Preparation</b>	
C.1. Extension and Flexion Gap Confirmation .....	12
C.2. Initial Femoral Trial Insertion .....	14
C.3. Initial Tibial Baseplate Trial Insertion .....	15
C.4. Creating Stem Space for Tibial Baseplate .....	16
<b>D. Posterior Stabilized Femoral Component Preparation</b>	
D.1. PS Femoral Notch Guide Positioning .....	17
D.2. PS Intercondylar Notch Creation .....	18
D.3. PS Femoral Trial Reduction .....	19
<b>E. Patellar Preparation</b>	
E.1. Inset Patellar Component Preparation .....	20
E.1.1. Inset Patellar Reaming Depth and Pilot Hole .....	21
E.1.2. Drill Hole Completion and Trial Installation .....	22
E.2. Onset Patellar Component Preparation .....	23
<b>F. Implant Fixation</b>	
F.1. Final Trial Reduction .....	24
F.2. Implant Fixation .....	25
<b>Implant Catalog</b> .....	28
<b>Instrument Catalog</b> .....	32
<b>Safety Statement</b> .....	45





# Preface

Throughout the evolution of total knee replacement science, significant improvements have been achieved to both implant design and implantation techniques, refining the procedure to routinely provide measurable improvements in clinical results. Amidst these advancements, the body of science continues to evolve, inspiring further refinements in both TKR implant and instrumentation design. At United Orthopedic Corporation, our research and development efforts have focused on a comprehensive review of the contemporary state of the art, an observance of time proven performance and design elements, and thoughtful analysis of those areas which may be improved through refined design elements. Our research areas included a scientific review of contemporary TKR designs and their associated clinical performance, along with a dimensional analysis of normal human knee anatomy, a study of motion patterns which achieve deep flexion, and key mechanisms of wear and failure in present designs. We then applied this data to evaluate ideal implant shape, size range, contact geography, durability, and increased functional range of motion. The result is a comprehensive design intended to enhance patient results. We invite you to reference the U2 Design Rationale documents for further information.

Among the major features of the U2 Knee design are:

- A science based size range for improved implant fit and associated capsular / soft tissue interactions
- An interchangeable femorotibial articulation for enhanced load distributions and improve wear characteristics
- A refined PS Progressive Rollback Post and Cam mechanism to provide more effective anatomic rollback behavior for improved ROM potentials
- An improved Post and Cam jumping distance to reduce dislocation potential
- An increased posterior condylar lobe thickness to provide important curvature continuation to encourage ROM and minimize bone/implant impingement potentials in deep flexion
- A multi radius femoral component curvature to encourage physiologic ligament tension relationships

The U2 Total Knee System Instrumentation key components include:

- Anterior Reference System to accurately position anterior flange blending
- Distal Femoral Valgus cutting guide in 1 degree increments
- PS Notch Cutting Guide with powered Reamer and Osteotomes for precise preparation
- Both Intramedullary and Extramedullary Tibial Alignment Guide Options
- Both Inset and Onset Patellar Cutting Guide Options to accurately prepare and restore the patellar thickness
- Femoral/Tibial Spacer Blocks to allow assessment of the flexion and extension gap balance
- Four compact sterilization trays to provide efficient instrument handling

MIS options include minimal size instrumentation, a patented Distal Femoral Cutting Guide and Femoral Sizing Caliper to improve working within the spacial limitations of the incision.

# Pre-Operative Planning

A thorough physical examination of the knee should be performed in a standard manner to evaluate the patient's overall knee function. Functional stability, muscle tone, ligamentous/ capsular laxity and/or contractures, and potential bone loss are all need to be considered.

Both A-P and Lateral standing radiographs, with a known magnification, should be obtained and evaluated. Radiographs of the non-operative limb may also be taken to provide an additional reference.

Additionally, the surgeon may elect to obtain A-P whole leg radiographs for both limbs to determine the current hip/knee/ankle mechanical axis and to allow for additional preoperative planning of the intended corrective osteotomies and resultant alignment/implant positioning.

If intra-medullary alignment instrumentation is intended to be used, the shape and diameter of femoral and tibial canals should be evaluated to help assure the successful use and passage of intramedullary alignment devices into the bone canals.

The intended implant size must also be evaluated on both A-P and lateral radiographs, by using the U2 Radiographic overlay templates. The magnification percentage of the templates used should approximate the known magnification of the radiographs.

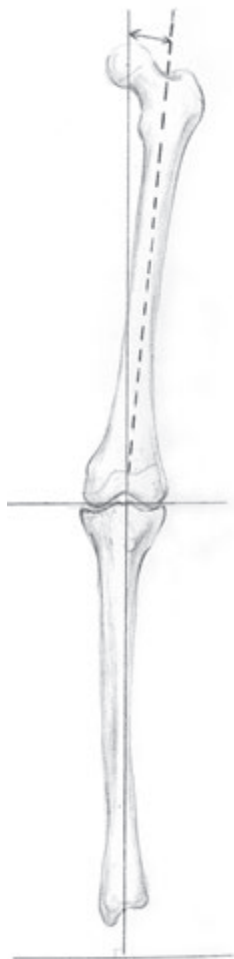

# Surgical Incision



The surgeon may select to use any standard exposure method to perform the skin and capsular incision. If the medial parapatellar approach is selected, a straight midline skin incision, extending above and below the patella is applied to begin the exposure. The capsular exposure is then approached by utilizing a longitudinal medial parapatellar incision, typically extending upward to a level of one third of the rectus femoris or vastus medialis and downward to the medial side of the origin of patellar tendon on the tibial tuberosity.

Once the exposure is completed, the patella is everted in a standard fashion, and the knee joint is inspected under vision. Careful assessment and removal of the osteophytes should be undertaken. In the meanwhile, ROM, patellar tracking, and soft tissue stability/instability should be evaluated again. It may be the preference of the surgeon to conduct a preliminary soft tissue release of the fixed contracted structures. Once completed, the knee is flexed to 90 degrees to perform the initial femoral pilot hole for the intramedullary alignment.

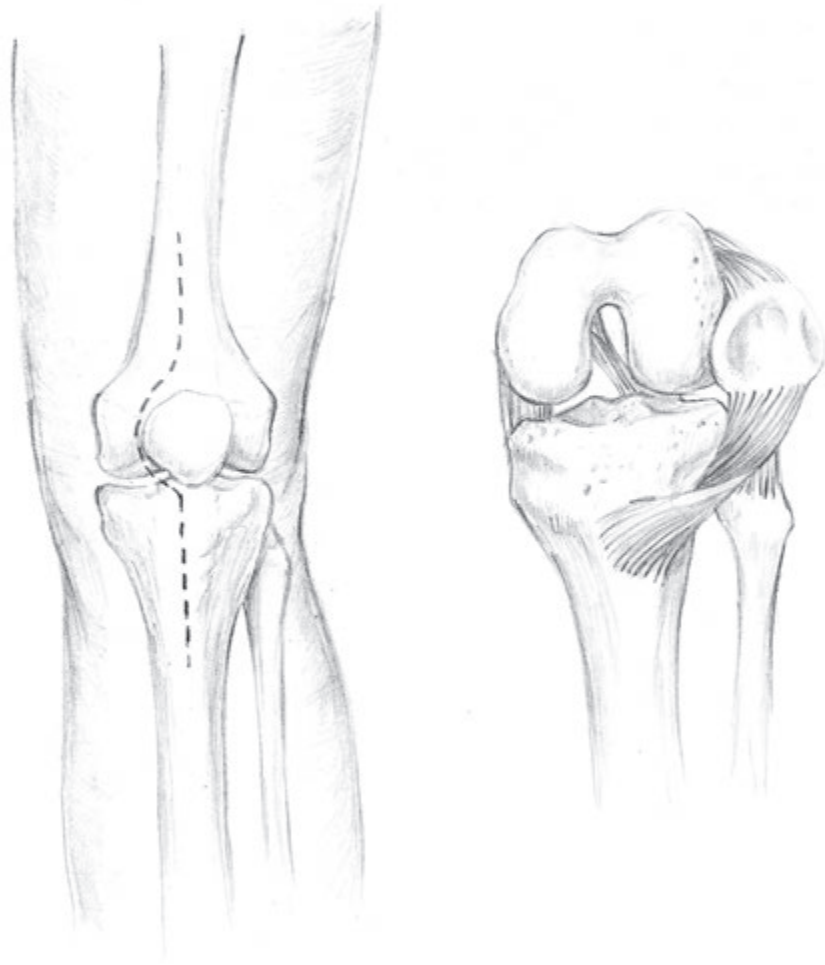

# A. Femoral Preparation

## A.1. Pilot Hole

With the ACL removed, the typical femoral entry hole location is thought to be slightly medial to the center of the intercondylar notch, and approximately 5 to 7 mm anterior to the anterior insertion of the PCL into the femur. Important note: As both varus and valgus deformities are commonly encountered in the total knee patient, careful evaluation of the possible A-P and M-L curvature of the femoral shaft should be undertaken to consider shifting the initial entry hole to a more appropriate location for each specific patient.

A **Starter** <sup>1</sup> is used to mark the hole location, followed by the **8 mm Twist Drill** <sup>2</sup> to create an opening in the femoral canal. The drill is typically inserted to a depth of approximately 100 mm within the femoral canal.

After removal of the drill, intramedullary fluid of the femur may be reduced by inserting the small diameter **Alignment Rod** <sup>3</sup> into the femoral shaft several times. This will also identify the femoral canal.

Once the canal is identified, the **Femoral IM Rod** <sup>4</sup> and **T-Handle** <sup>5</sup> is manually inserted into the femoral canal until the isthmus is engaged. Care should be taken when encountering the isthmus and make sure the rod can be completely pass through. Please note: If the canal isthmus diameter is thought to be too narrow for standard passage of the rod, advancement is discontinued, and an intraoperative radiograph may be employed to access the appropriate location of the rod.

- 1 Starter  
9301-2101-RB



- 2 Twist Drill, ø8 mm  
9301-3201



- 3 Alignment Rod  
9403-2202



- 4 Femoral IM Rod, 400 mm  
9303-3200



- 5 T-Handle  
9301-1100

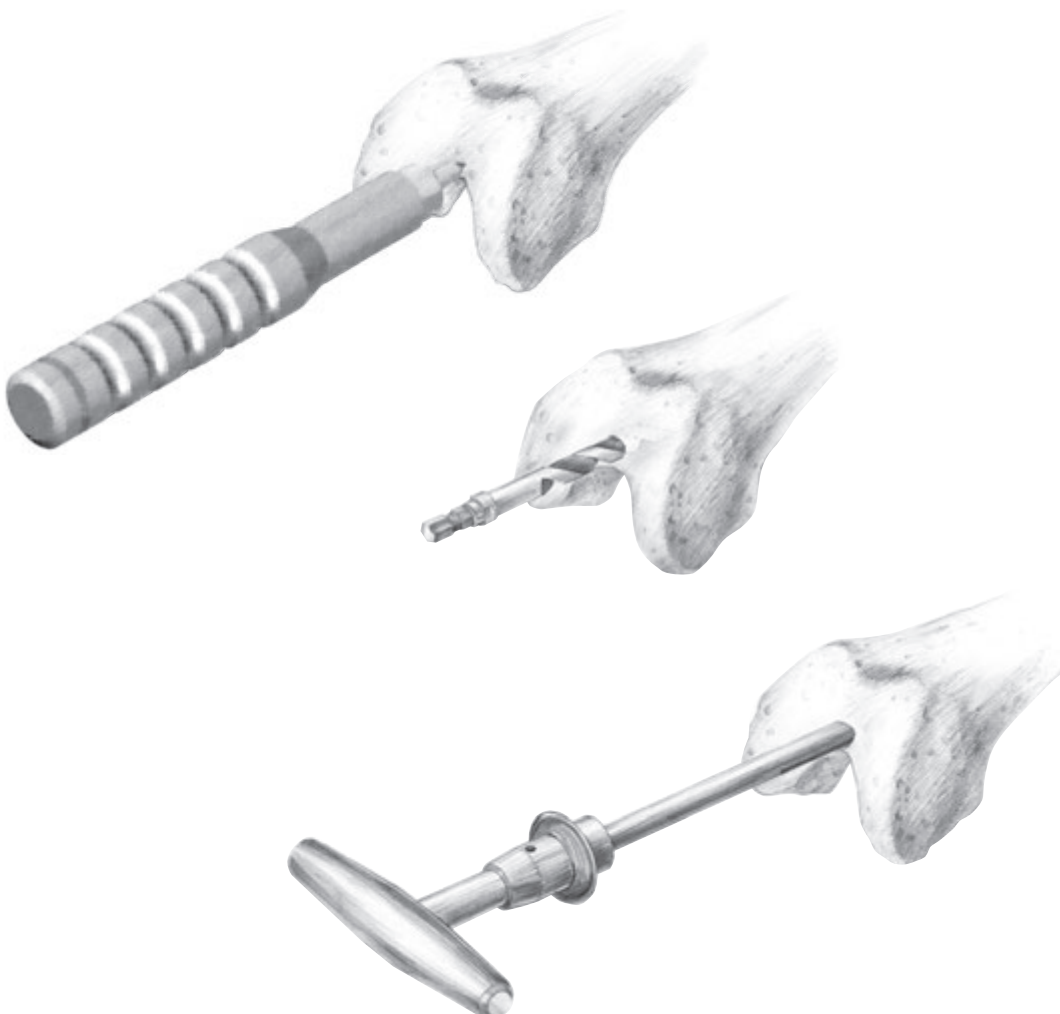

# A. Femoral Preparation

## A.2. Femoral Valgus Angle Confirmation

Take the **T-Handle** <sup>5</sup> off. Adjust the valgus angle (range: 0-11°) on the **Femoral IM Alignment Guide** <sup>6</sup> to the pre-operative estimated angle. Slip the **Femoral IM Alignment Guide** <sup>6</sup> through the **Femoral IM Rod** <sup>4</sup>. Fix the **Femoral IM Alignment Guide** <sup>6</sup> with **Spikes** <sup>7</sup> to ensure the Guide is firmly contacted to the distal femur. The **Alignment Rod** <sup>3</sup> can be also attached to the **Extramedullary Alignment Tower** <sup>8</sup>, following to the **Femoral IM Alignment Guide** <sup>6</sup> and directed towards to the center of the femoral head to confirm if the intended valgus angle is correct.

- 6 Femoral IM Alignment Guide  
9303-2111-RA



- 7 Spike  
9301-3207  
9303-3201  
9303-3202

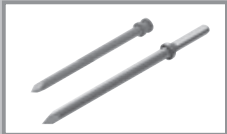

- 8 Extramedullary Alignment Tower  
9301-2282





# A. Femoral Preparation

## A.3. Distal Femur Cutting

Attach the **Distal Femoral Cutting Guide** <sup>9</sup> to the **Distal Femoral Alignment Guide** <sup>10</sup>. To secure the cutting guide, two **3.2 mm Twist Drills** <sup>11</sup> are drilled into the "0" hole site on the distal femoral cutting guide. Prior to cutting the distal femur, additional fixation may be achieved by utilizing the **Quick Pin Driver** <sup>12</sup> to place additional pins in the medial and lateral pin holes.

Once the instrument is secured, the resection is performed through the most distal slot in the instrument by using a standard .050" (1.27 mm) thick saw blade.

NOTE : The +3 mm slot option may also be selected for use if the surgeon wishes to resect an extra 3 mm thick distal bone.

NOTE : +2 mm / +4 mm guide hole provides options to allow additional resection if desired at a later point in the procedure.

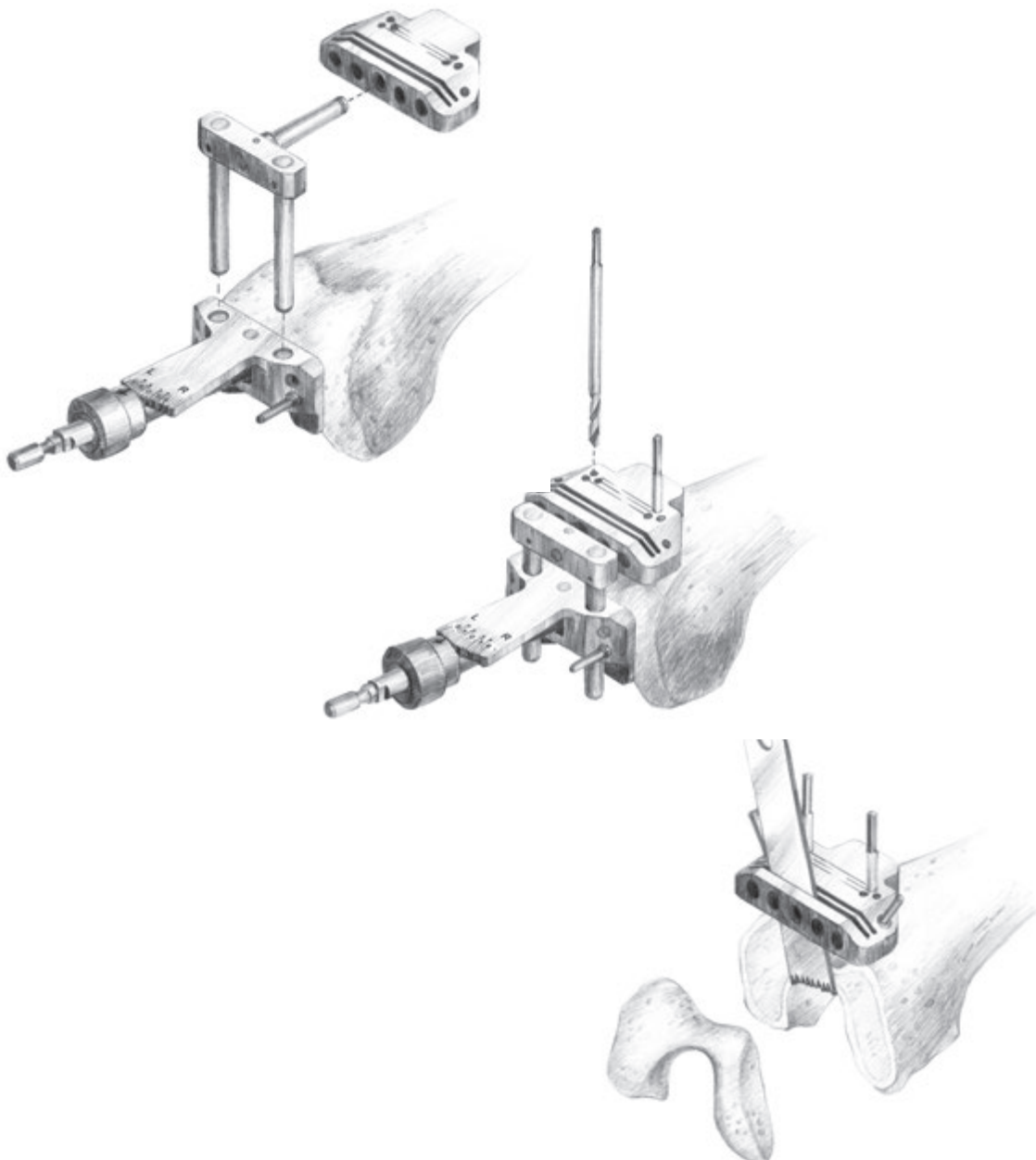

**9** Distal Femoral Cutting Guide  
9303-2103-RC



**10** Distal Femoral Alignment Guide  
9303-2102-RA



**11** Twist Drill,  $\varnothing$ 3.2 mm  
9303-3203  
9303-3204



**12** Quick Pin Driver  
9303-5001-RA



# A. Femoral Preparation

## A.4. Femoral Component Sizing

13 Pin Extractor  
9303-5002



14 Femoral Sizer  
Anterior Ref  
9303-7101-RE



Extract the **3.2 mm Twist Drills** <sup>11</sup> and **Spikes** <sup>7</sup> with a **Pin Extractor** <sup>13</sup> and remove the **Distal Femoral Cutting Guide** <sup>9</sup> after resection. Place a **Femoral Sizer** <sup>14</sup> flush against the resected distal femur, with the two feet rested flat against the posterior femoral condyles and ensure its stylus touching the lowest point of the anterior femoral cortex. The estimated size is indicated on the front and tight the screw of the **Femoral Sizer** <sup>14</sup>. To establish a 3° external rotation, create the fixation pin holes with **3.2 mm Twist Drills** <sup>11</sup> through the holes that correspond to the affected knee (left or right) on the front of the **Femoral Sizer** <sup>14</sup>. The neutral position can simply be created by drilling the fixation pin holes through the drill holes labelled "0" on the front of the **Femoral Sizer** <sup>14</sup>.

NOTE : The U2 Knee primary system is an anterior reference system. If the indicated size on the face of the guide is between two sizes, it is generally preferred to choose the smaller one. The additional bone resection will be removed from the posterior condyles.

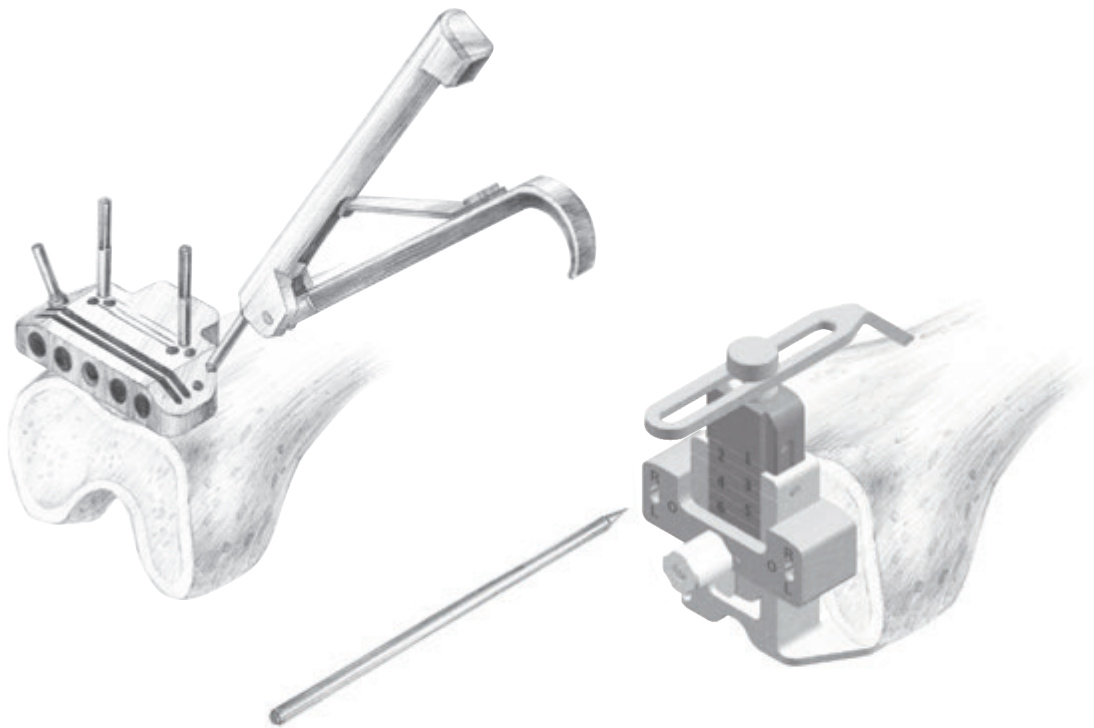

### ■ 3° External Rotation



Left/Right

### ■ No Rotation



# A. Femoral Preparation

## A.5. A-P Chamfer Cutting

Fix the chosen **Femoral A/P Chamfer Cutting Guide** <sup>15</sup> in the predrilled fixation pin holes (Note: it must be placed flush against the resected distal femur). Use **Spikes** <sup>7</sup> or **Femoral A/P Chamfer Guide Handle** <sup>16</sup> to enhance the stability during resection and check resection thickness with the **Lower Point Gauge** <sup>17</sup>. Then, complete the four resection procedure with a 1.27 mm saw blade. At this point, the femoral preparation for posterior cruciate retaining femoral component is completed.

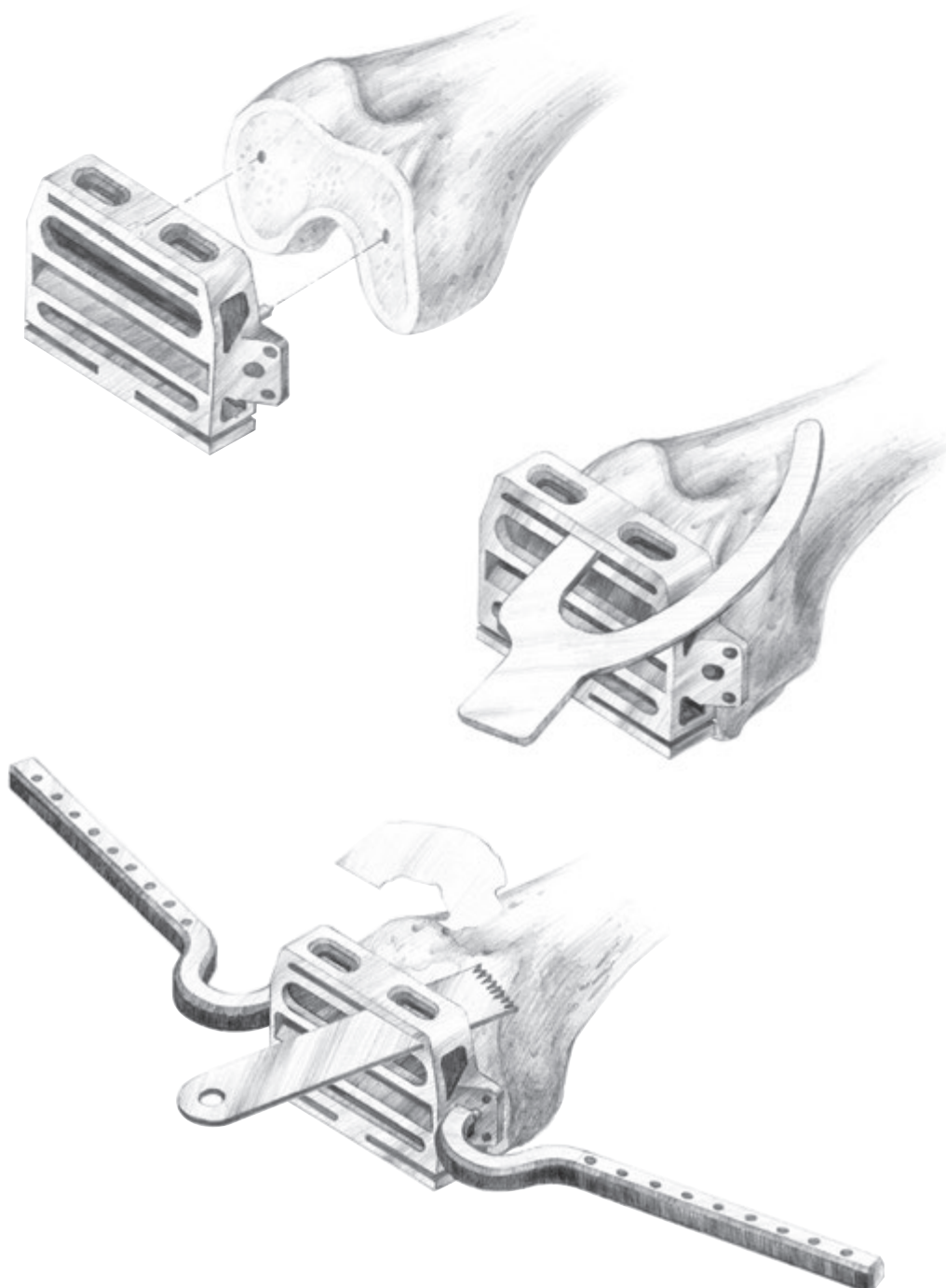

- 15 Femoral A/P Chamfer Cutting Guide  
9303-2110-RC  
9303-2120-RC  
9303-2130-RC  
9303-2140-RC  
9303-2150-RC  
9303-2160-RC  
9303-2170-RC



- 16 Femoral A/P Chamfer Guide Handle  
9301-2291



- 17 Lower Point Gauge, 1.3 mm  
9301-2251



# B. Tibial Preparation

18 Tibial IM Rod  
9401-2203



There are two options for preparing tibial platform. One is intramedullary alignment method, and the other is extramedullary alignment method.

## B.1. Tibial Intramedullary Alignment Method

### B.1.1. Pilot Hole

Flex the knee joint to the maximum angle and expose the whole tibial plateau by moving it anteriorly. Use the **Starter** <sup>1</sup> to create a pilot hole which is located at approximately 10 mm posterior to the origin of anterior cruciate ligament. Then, use an **8 mm Twist Drill** <sup>2</sup> to create canal with a depth of approximately 100 mm into the tibial. After taking out the drill, it is recommended to apply an **Alignment Rod** <sup>3</sup> into the marrow cavity several times to reduce the risk of fat embolism. Connect the **T-Handle** <sup>5</sup> to the **Tibial IM Rod** <sup>18</sup> and insert the assembly manually into tibial canal through the narrowest point inside. Then, remove the **T-Handle** <sup>5</sup>. If it is difficult to insert or align the **Tibial IM Rod** <sup>18</sup>, enlarge the pilot hole with the **8 mm Twist Drill** <sup>2</sup> again.

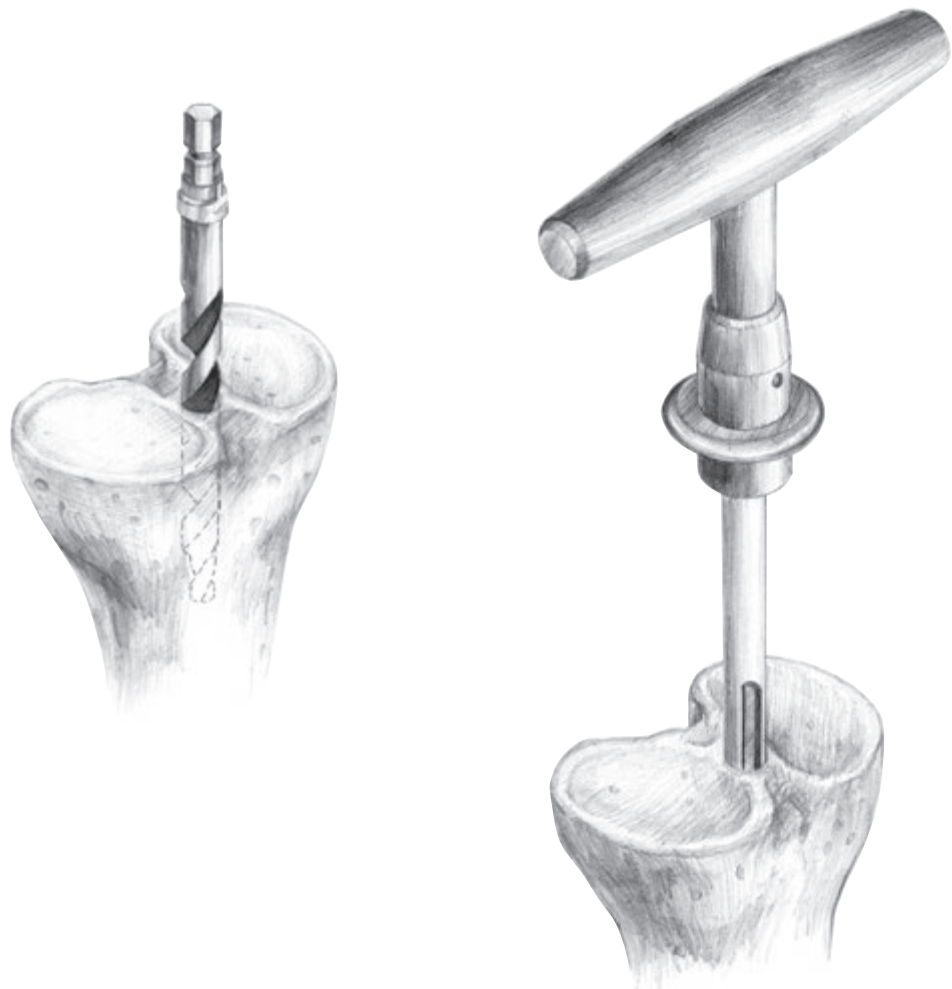

# B. Tibial Preparation

## B.1.2. Tibial Cutting Jig Positioning and Tibial Resection

Select and position a left or right, 0 or 5 degrees slope **Tibial Cutting Jig** <sup>19</sup> onto the **Tibial IM Alignment Guide** <sup>20</sup>. With the thumb screw held loosely, the **Tibial Stylus** <sup>21</sup> may be used to establish the appropriate height position of the **Tibial Cutting Jig** <sup>19</sup>.

NOTE : The **Tibial Stylus** <sup>21</sup> has two options to position the Cutting Guide: 2 mm or 9 mm cutting levels. When the **Tibial Stylus** <sup>21</sup> tip marked 2 mm is positioned on the lowest point of the tibial plateau, the bone resection will occur 2 mm below the contact point of the stylus tip. If the 9 mm stylus tip is positioned on the highest point of the tibial plateau, it will position the **Tibial Cutting Jig** <sup>19</sup> 9 mm below the contact point of the stylus tip.

With the **Tibial Cutting Jig** <sup>19</sup> properly positioned, two **3.2 mm Twist Drills** <sup>11</sup> are placed into the "0" hole locations. Additional **3.2 mm Twist Drills** <sup>11</sup> may be used in the peripheral holes provided.

With the **Tibial Cutting Jig** <sup>19</sup> secured, the **T-Handle** <sup>5</sup> is re-assembled onto the **Tibial IM Rod** <sup>18</sup> for the removal of the **Tibial IM Rod** <sup>18</sup> and **Tibial IM Alignment Guide** <sup>20</sup>. The **Tibial Cutting Jig** <sup>19</sup> will stay in the position.

Now the proximal tibial resection may be performed utilizing a 1.27 mm saw blade. Once the resection is completed, the Cutting Guide and Pins may be removed for subsequent trial reduction.

NOTE : Prior to resection, if the surgeon wishes to increase or decrease the tibial resection thickness, the "+2" or "-2" hole locations may be utilized to re-position the **Tibial Cutting Jig** <sup>19</sup>.

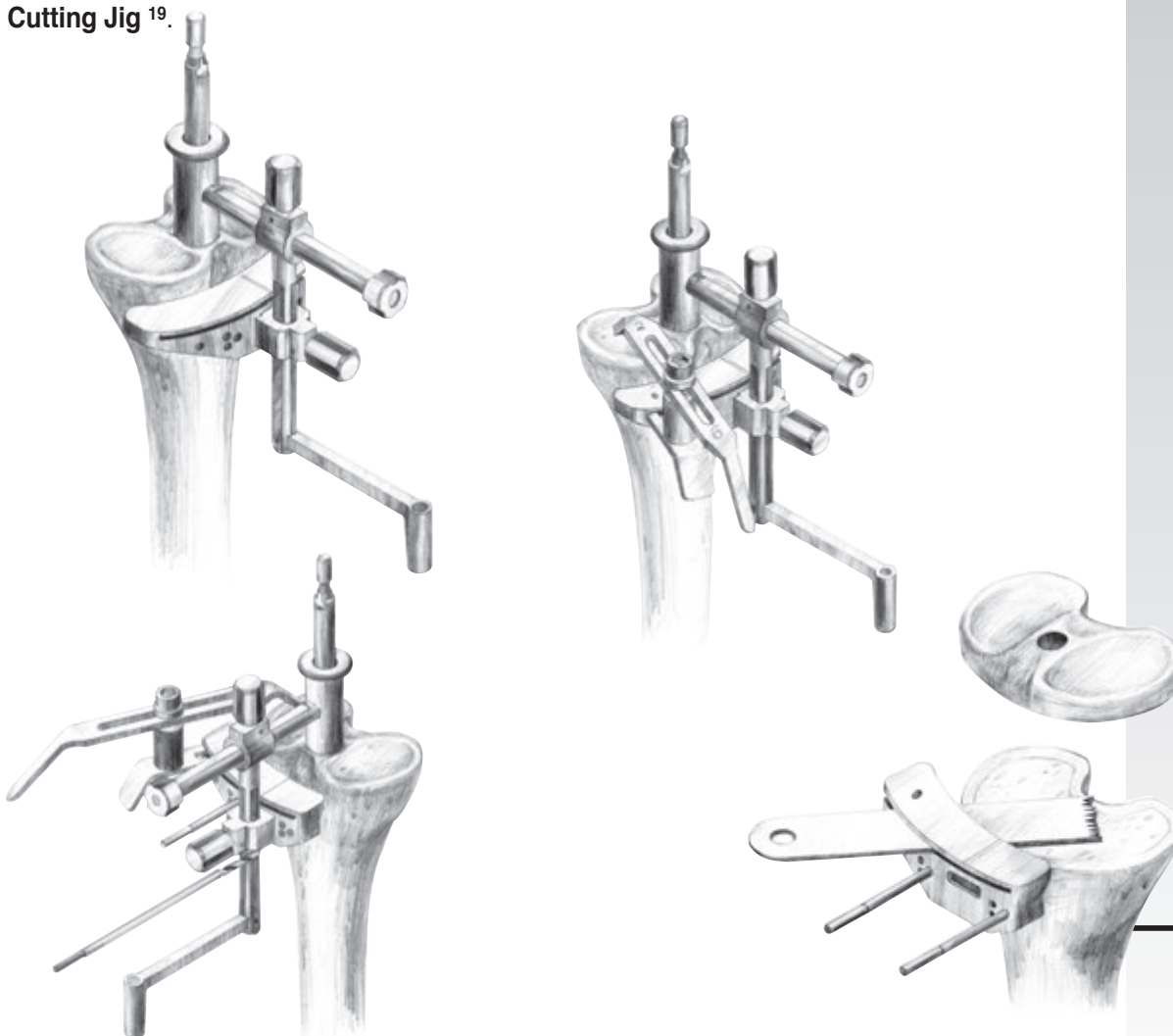

- 19 Tibial Cutting Jig  
9403-2120-RE  
9403-2125-RE  
9403-2220-RE  
9403-2225-RE



- 20 Tibial IM Alignment Guide  
9403-2103-RA



- 21 Tibial Stylus  
9403-7101-RA



# B. Tibial Preparation

## B.2. Tibial Extramedullary Alignment Method

Assemble the **Tibial EM Alignment Guide** <sup>22</sup> to the selected **Tibial Cutting Jig** <sup>19</sup>. The surgeon may select from the options : left or right, 0 or 5 degrees slope.

With the knee fully flexed, position the distal portion of the **Tibial EM Alignment Guide** <sup>22</sup> at the anterior ankle joint with the supramalleolar spring tabs. Position the proximal portion of the **Tibial EM Alignment Guide** <sup>22</sup> by impacting the spikes of the **Tibial EM Alignment Guide** <sup>22</sup> into the central portion of the proximal tibial plateau.

The cutting amount may be determined by inserting the **Tibial Stylus** <sup>21</sup> in the resection slot.

NOTE : The **Tibial Stylus** <sup>21</sup> has two options to position the Cutting Guide; 2 mm or 9 mm cutting levels. When the **Tibial Stylus** <sup>21</sup> tip marked 2 mm is positioned on the lowest point of the tibial plateau, the bone resection will occur 2 mm below the contact point of the stylus tip. If the 9 mm stylus tip is positioned on the highest point of the tibial plateau, it will position the **Tibial Cutting Jig** <sup>19</sup> 9 mm below the contact point of the stylus tip.

Once the elevation is chosen, the **3.2 mm Twist Drills** <sup>11</sup> are placed in the “0” hole option of the **Tibial Cutting Jig** <sup>19</sup>. Additional peripheral **3.2 mm Twist Drills** <sup>11</sup> or **Spikes** <sup>7</sup> may also be used to secure the **Tibial Cutting Jig** <sup>19</sup>.

Once the **Tibial Cutting Jig** <sup>19</sup> is securely positioned, the **Tibial EM Alignment Guide** <sup>22</sup> may now be removed by utilizing the **Spike and Tibial EM Guide Extractor** <sup>23</sup>. Resection of the tibial plateau is now performed by using a 1.27 mm saw blade.

NOTE : Prior to resection, if the surgeon wishes to increase or decrease the tibial resection thickness, the “+2” or “-2” hole locations may be utilized to re-position the **Tibial Cutting Jig** <sup>19</sup>.

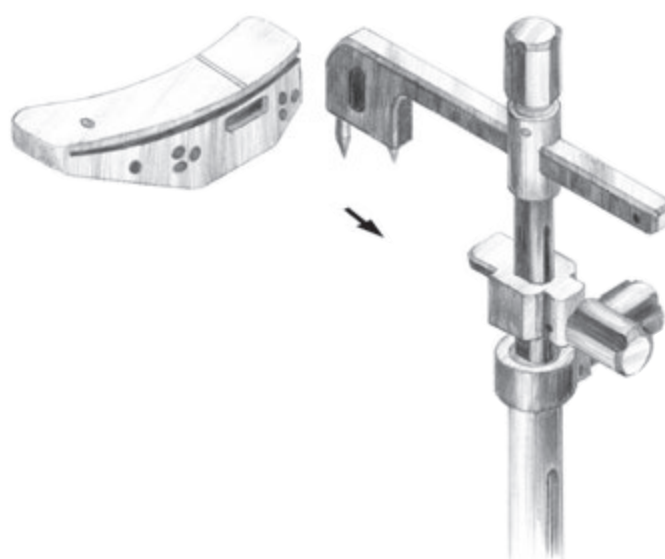

22 Tibial EM Alignment Guide  
9403-2104-RA



23 Spike and Tibial EM Guide Extractor  
9303-5101



# B. Tibial Preparation

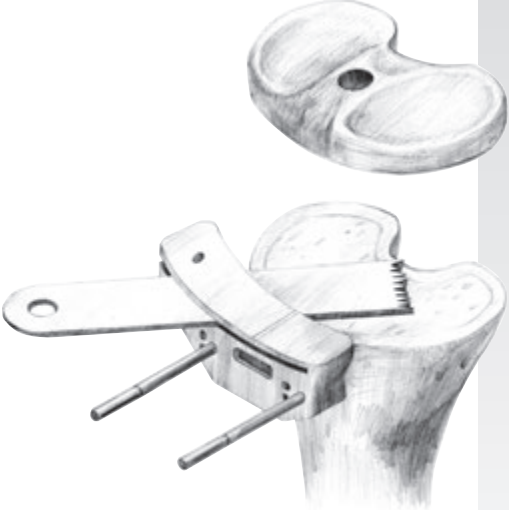
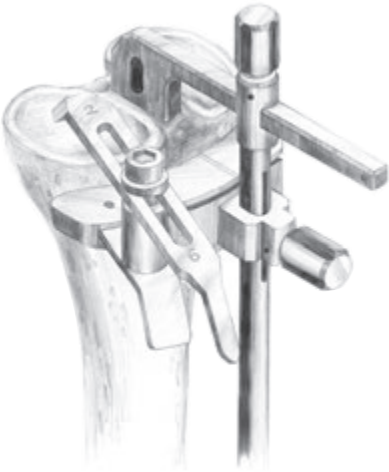
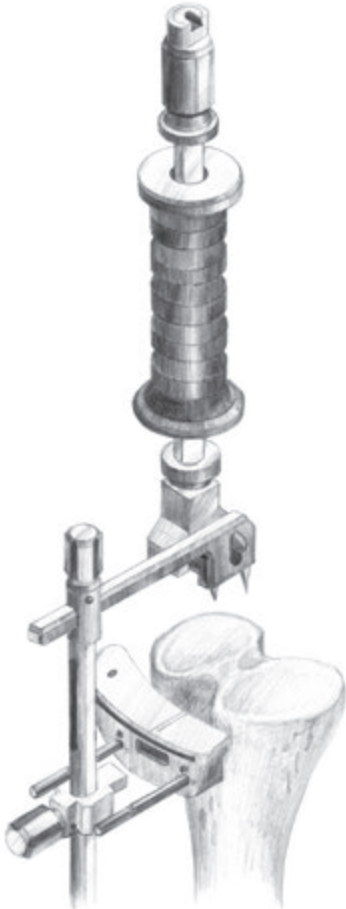
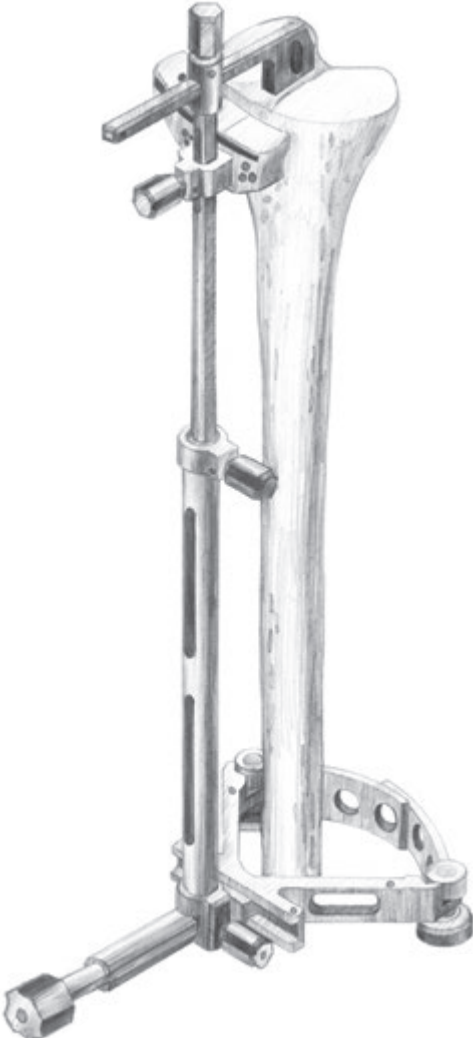

# C. Trial Preparation

## C.1. Extension and Flexion Gap Confirmation

The flexion and extension joint space gaps may be evaluated at this time with the **Gap Gauge**<sup>24</sup>. The 9 mm **Gap Gauge**<sup>24</sup> is initially selected to assess both the flexion and extension joint space.

If a thicker gap is required, combine additional **Gap Gauge**<sup>24</sup> blocks with different thicknesses and test again. The range of thickness is from 9 mm to 18 mm.

If neither the flexion and extension gaps nor soft tissue tension shows any problem, insert the femoral trial and the tibial trial to test the knee mobility and their relative positions.

NOTE : The **Alignment Rod**<sup>3</sup> may be inserted through the **Gap Gauge**<sup>24</sup> handle to assess the extramedullary alignment in both flexion and extension.

- 24 Gap Gauge
- 9403-7009
- 9403-7011
- 9403-7013
- 9403-7015
- 9403-7018

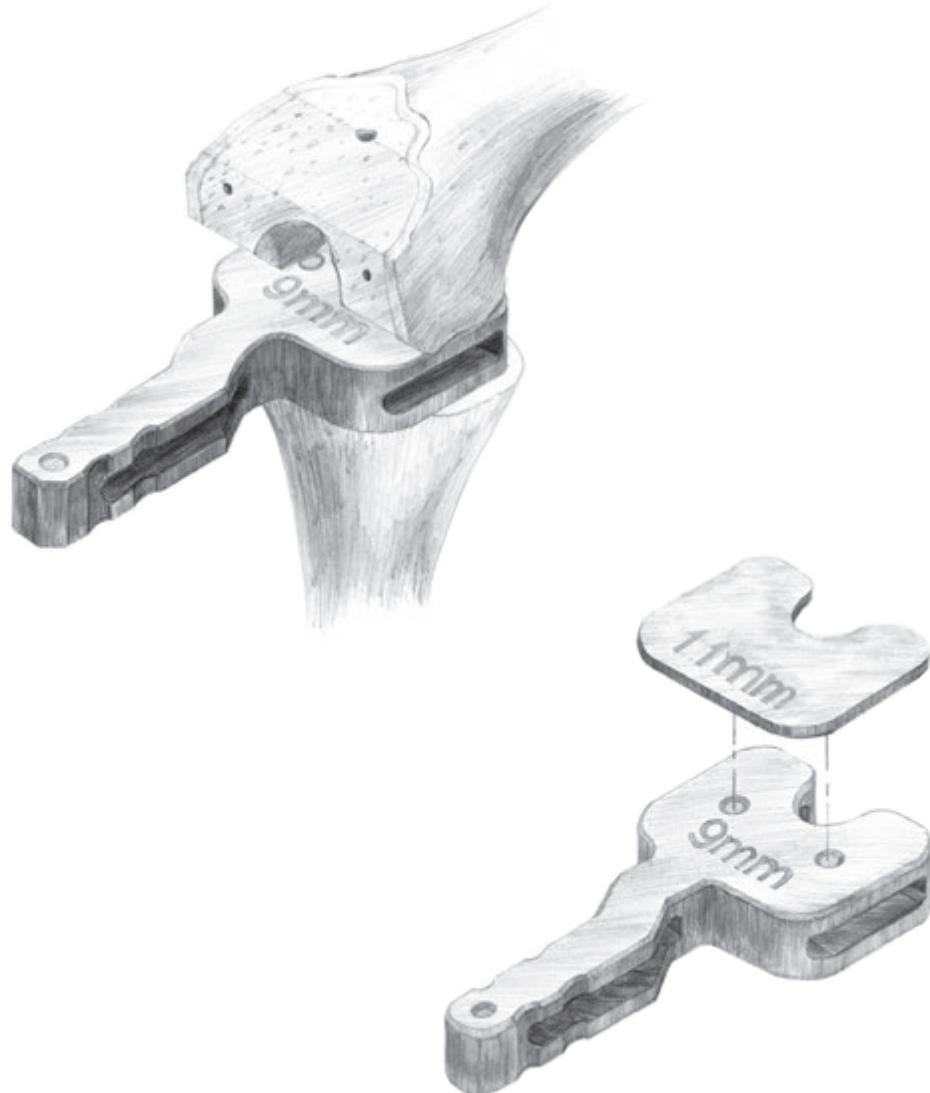



# C. Trial Preparation

If the flexion, extension, or both gaps and associated soft tissue tension appear to be unbalanced, the following techniques may be employed :

## **Tight Flexion - Tight Extension :**

### **Resect Additional Bone from the Tibia**

If the gap is deemed too tight in both flexion and extension, the surgeon may wish to remove additional bone from the tibia, as it is the common surface to both flexion and extension gaps. The surgeon may re-position the **Tibial Cutting Jig** <sup>19</sup> to perform this resection. The **Gap Gauge** <sup>24</sup> may then be utilized to re-access the newly established flexion/extension gap.

## **Balanced Flexion - Tight Extension :**

### **Resect Additional Bone from the Distal Femur**

If the gap is deemed too tight in extension only, the surgeon may wish to remove additional bone from the distal femur, as recutting this surface will only affect the extension gap only. The **Distal Femoral Cutting Guide** <sup>9</sup> may be repositioned on the femur to perform this resection. Then the **Gap Gauge** <sup>24</sup> may be utilized to re-access the flexion/extension gap.

NOTE : Following the distal femoral recutting, the **Femoral A/P Chamfer Cutting Guide** <sup>15</sup> is required to recreate the femoral chamfer cuts.

## **Tight Flexion - Balanced Extension :**

### **Resect Additional Bone from the Posterior Femur**

If the **Gap Gauge** <sup>24</sup> is too tight in flexion only, the surgeon may select to down-size the femoral component and thereby affect the associated flexion gap only. To down-size the femoral component, select an **Femoral A/P Chamfer Cutting Guide** <sup>15</sup> one size smaller than the originally used, and reposition the guide into the original distal femoral drill holes.

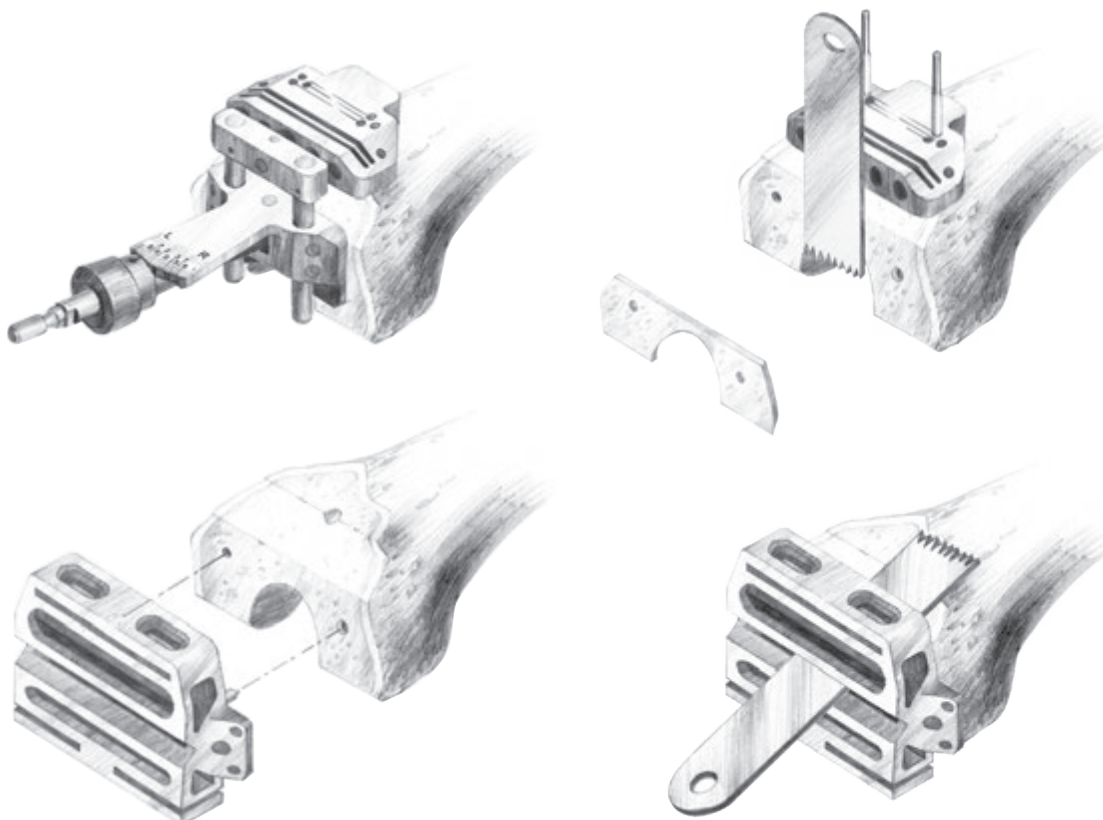

# C. Trial Preparation

## C.2. Initial Femoral Trial Insertion

Assemble the **CR Femoral Trial** <sup>25</sup> to the **Femoral Driver** <sup>26</sup>. Center **CR Femoral Trial** <sup>25</sup> at the femoral intercondylar notch and hit it onto the resected femur with the **Femoral Impactor** <sup>27</sup>. Perform with great care and pay special attention to make sure that it is aligned with the mechanical axis and rested flush against the bone cutting surface. Drill the fixation peg holes with the **Femoral Condyle Drill** <sup>28</sup>.

25 Femoral Trial, CR  
C/N varies by size



26 Femoral Driver  
9303-5110



27 Femoral Impactor  
9303-5103-RB



28 Femoral Condyle Drill  
9303-3206

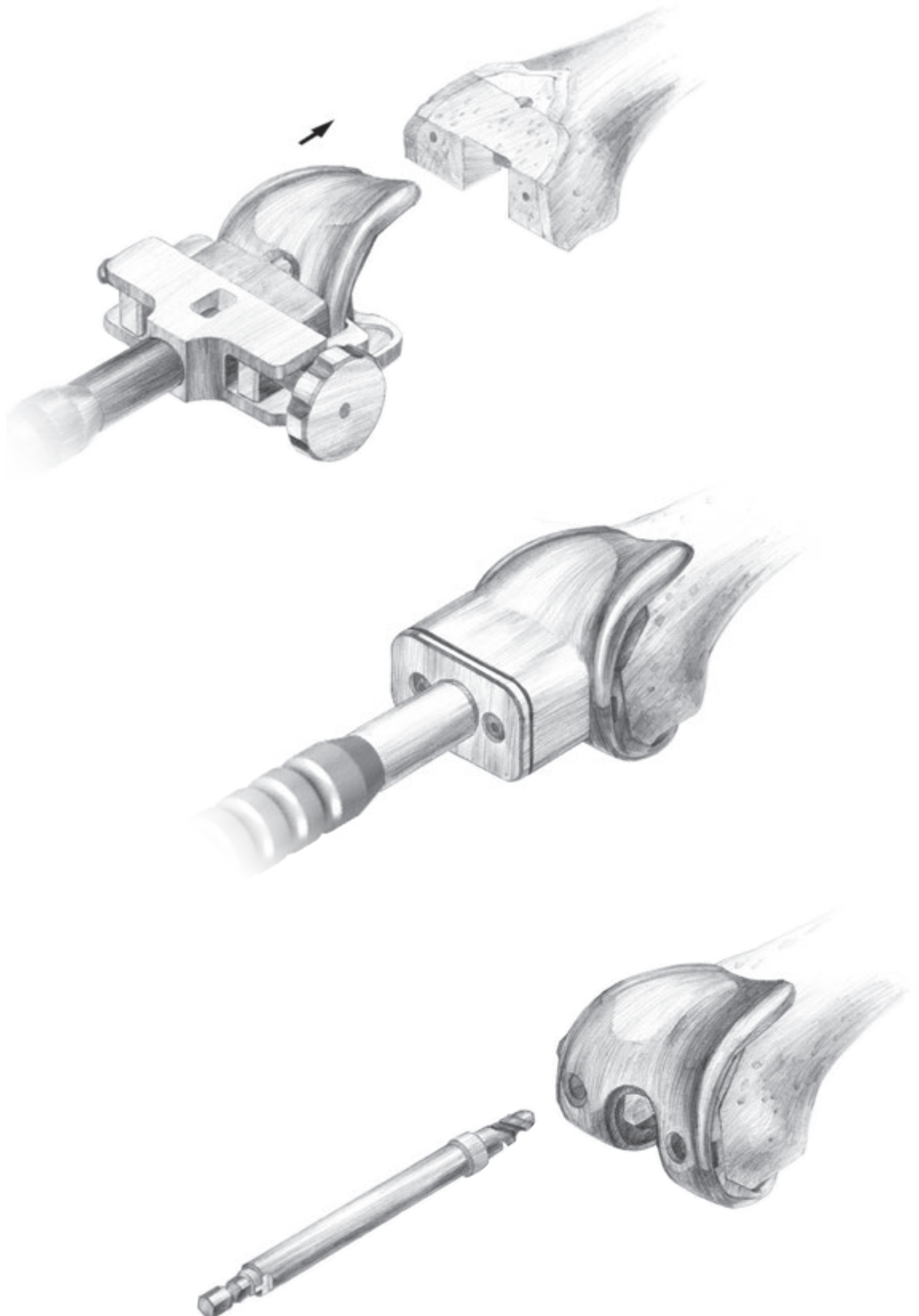

# C. Trial Preparation

## C.3. Initial Tibial Baseplate Trial Insertion

As the U2 Knee system allows interchangeability of femoral and tibial implant sizes, select the **Tibial Baseplate Trial** <sup>29</sup> that best provides maximum coverage of the proximal tibia.

Once selected, attach the **Tibial Baseplate Trial Handle** <sup>30</sup> to the **Tibial Baseplate Trial** <sup>29</sup> and reposition this assembly onto the tibia. The **Alignment Rod** <sup>3</sup> may be inserted into the **Tibial Baseplate Trial Handle** <sup>30</sup> to further evaluate the proper positioning of the **Tibial Baseplate Trial** <sup>29</sup>. Remove the **Tibial Baseplate Trial Handle** <sup>30</sup> and insert a **CR Tibial Insert Trial** <sup>31</sup> of desired thickness.

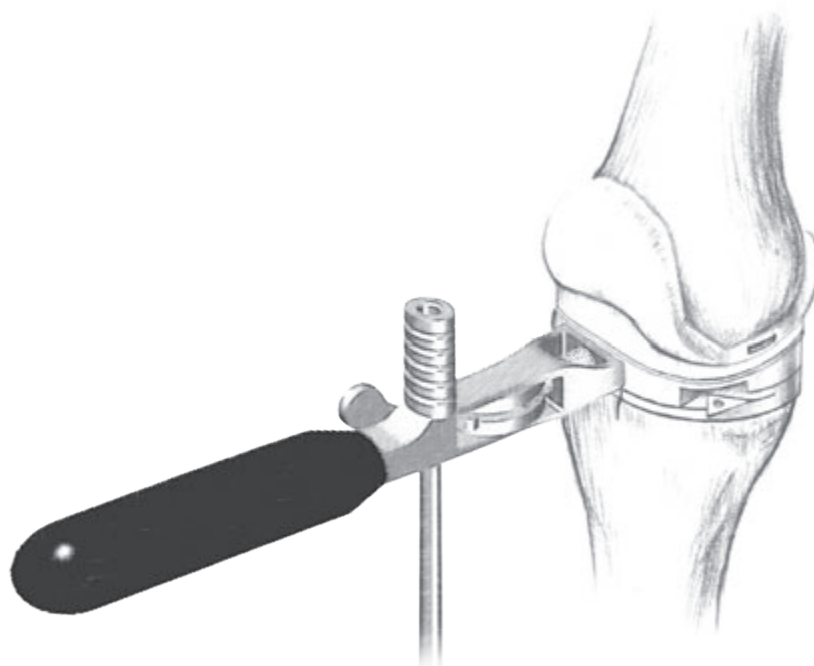
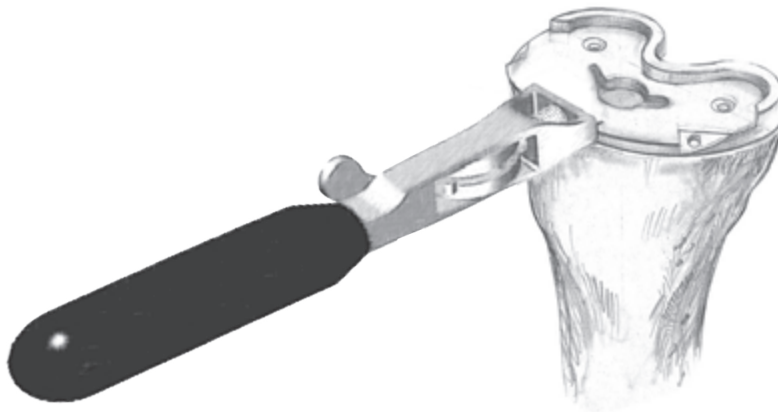

- 29 Tibial Baseplate Trial  
2203-4010-RB  
2203-4020-RB  
2203-4030-RB  
2203-4040-RB  
2203-4050-RB  
2203-4060-RB



- 30 Tibial Baseplate Trial Handle  
9403-1202



- 31 Tibial Insert Trial, CR  
C/N varies by size



# C. Trial Preparation

## C.4. Creating Stem Space for Tibial Baseplate

Fix the **Tibial Baseplate Trial** <sup>29</sup> on the tibia with **Spikes** <sup>7</sup>. Attach the **Tibial Drill Guide** <sup>32</sup> to it and drill an opening with the **Tibial Drill** <sup>33</sup>. Choose a corresponding size **Cemented Tibial Punch** <sup>35</sup> and attach it to a **Tibial Punch Handle, CM** <sup>34</sup>. Position the Handle to the guide hole on the **Tibial Baseplate Trial** <sup>29</sup> and to ensure that the **Cemented Tibial Punch** <sup>35</sup> hits precisely and vertically into the tibial canal.

32 Tibial Drill Guide  
9403-2105

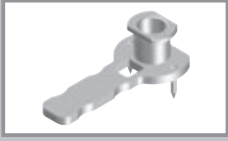

33 Tibial Drill  
9403-3001



34 Tibial Punch Handle, CM  
9403-1101-RC



35 Cemented Tibial Punch  
9403-6010  
9403-6020  
9403-6030

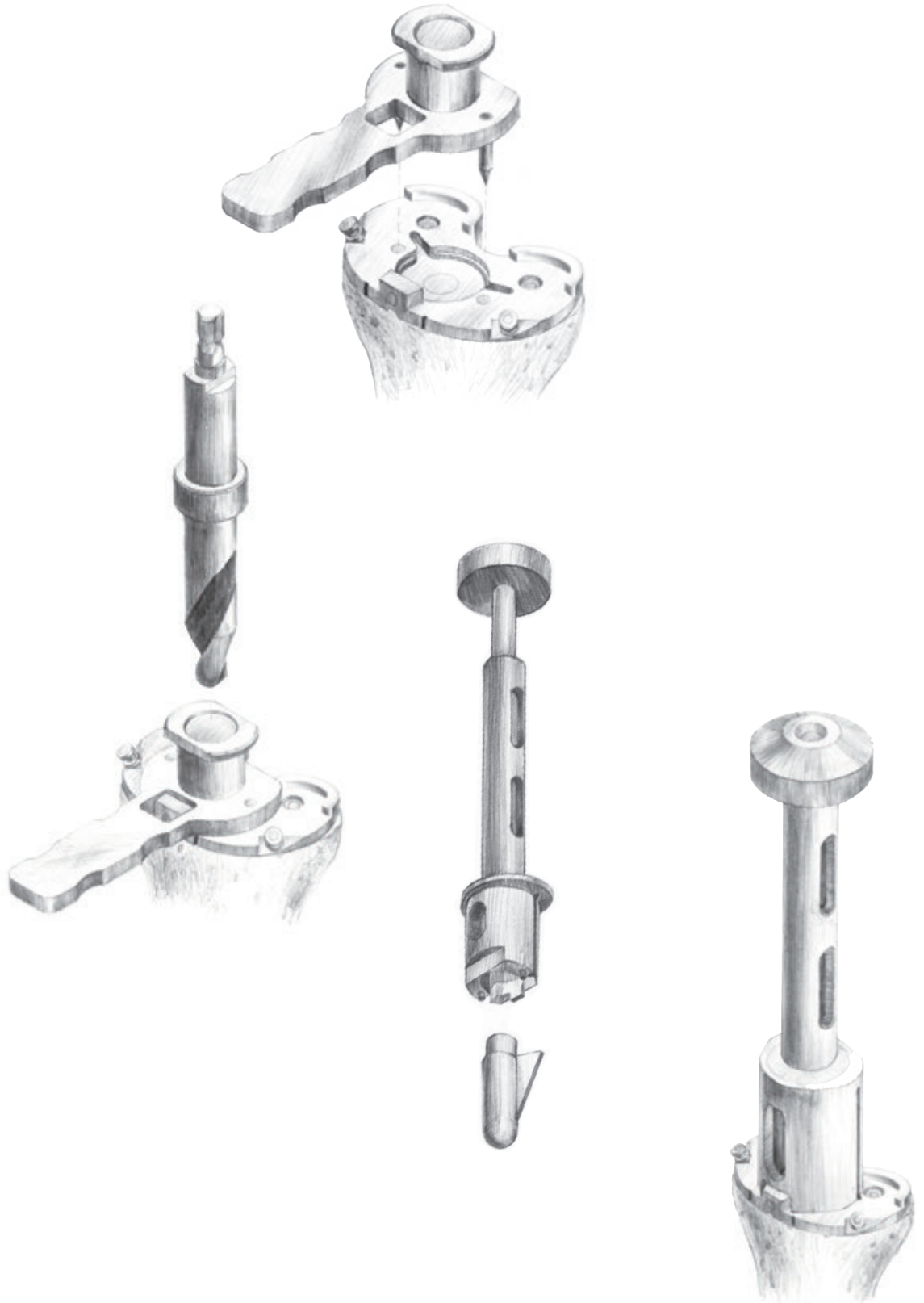

# D. Posterior Stabilized Femoral Component Preparation

## D.1. PS Femoral Notch Guide Positioning

To utilize the PS Femoral system, the **CR Femoral Trial**<sup>25</sup> component is first used to position the hole locations for the **PS Notch Cutting Jig**<sup>36</sup>.

The **CR Femoral Trial**<sup>25</sup> is positioned and carefully impacted as before. Locate the **PS Cutting Jig Drill Guide**<sup>37</sup> onto the **CR Femoral Trial**<sup>25</sup>. A **3.2 mm Twist Drill**<sup>11</sup> is now used, leaving the drills in place to position the **PS Notch Cutting Jig**<sup>36</sup>.

Remove the **CR Femoral Trial**<sup>25</sup> and position the **PS Notch Cutting Jig**<sup>36</sup> onto the two drills. Additional **Spikes**<sup>7</sup> are now used to secure the Jig in position.

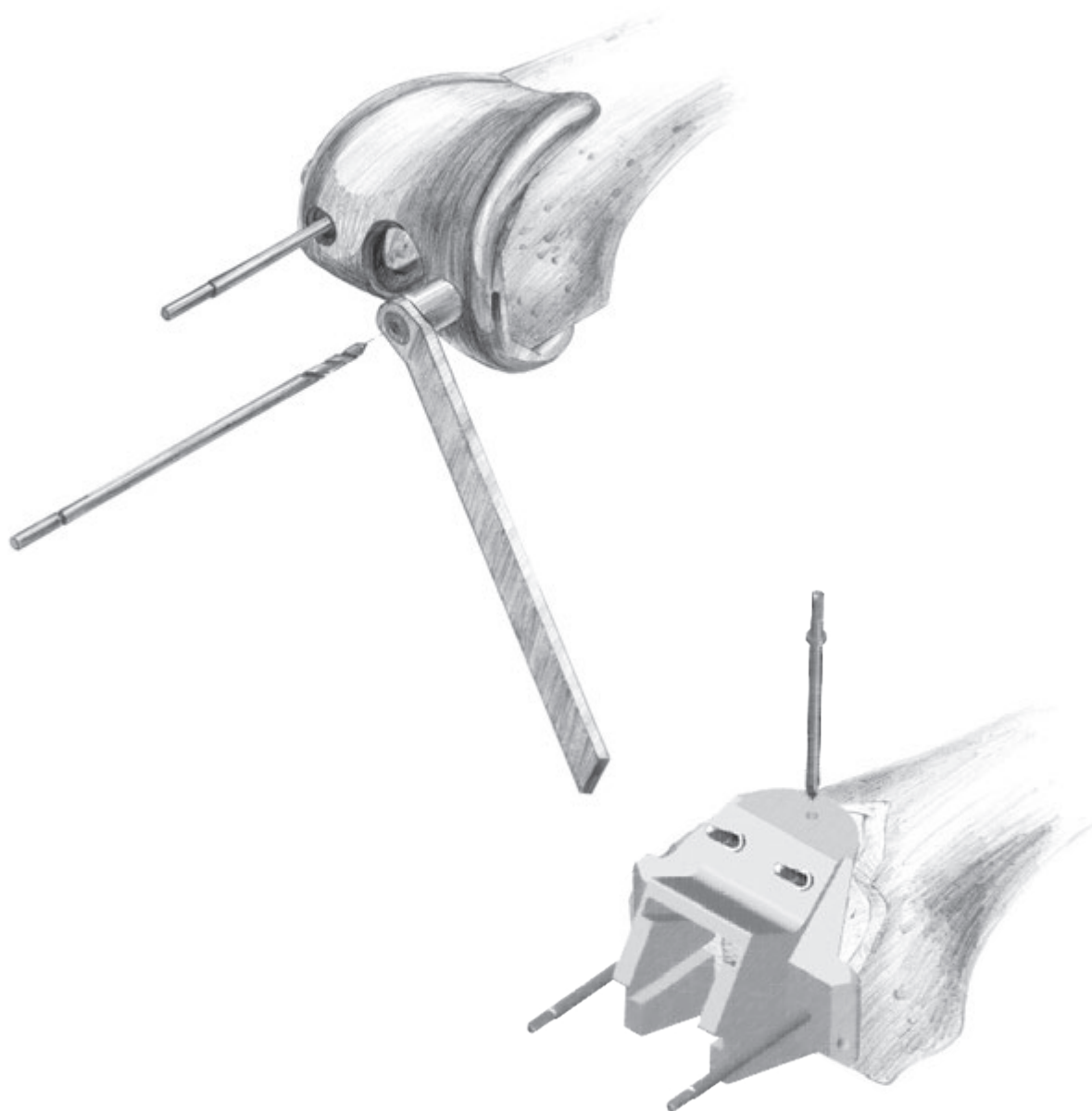

- 36 PS Notch Cutting Jig  
9303-2210-RC  
9303-2220-RC  
9303-2230-RC  
9303-2240-RC  
9303-2250-RC  
9303-2260-RC  
9303-2270-RC



- 37 PS Cutting Jig  
Drill Guide  
9303-2104



# D. Posterior Stabilized Femoral Component Preparation

38 PS Reamer  
9303-4101-RF

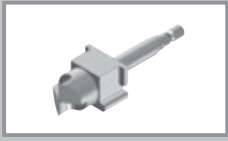

39 PS Housing Punch  
9303-5104-RA

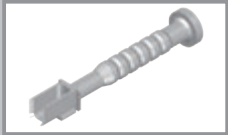

40 PS Housing  
Impactor  
9303-5105-RA



## D.2. PS Intercondylar Notch Creation

Insert the **PS Reamer**<sup>38</sup> first into the anterior guide slot in the **PS Notch Cutting Jig**<sup>36</sup>. Advance the **PS Reamer**<sup>38</sup> under drill power until it is seated flush with the **PS Notch Cutting Jig**<sup>36</sup>. The **PS Reamer**<sup>38</sup> is then inserted in the same manner into the posterior guide slot. A visual clearance of complete bone removal is advised.

The **PS Housing Punch**<sup>39</sup> is now inserted into both the anterior and posterior slots to complete all bone removal. The **PS Housing Impactor**<sup>40</sup> is now inserted to verify complete clearance of bone.

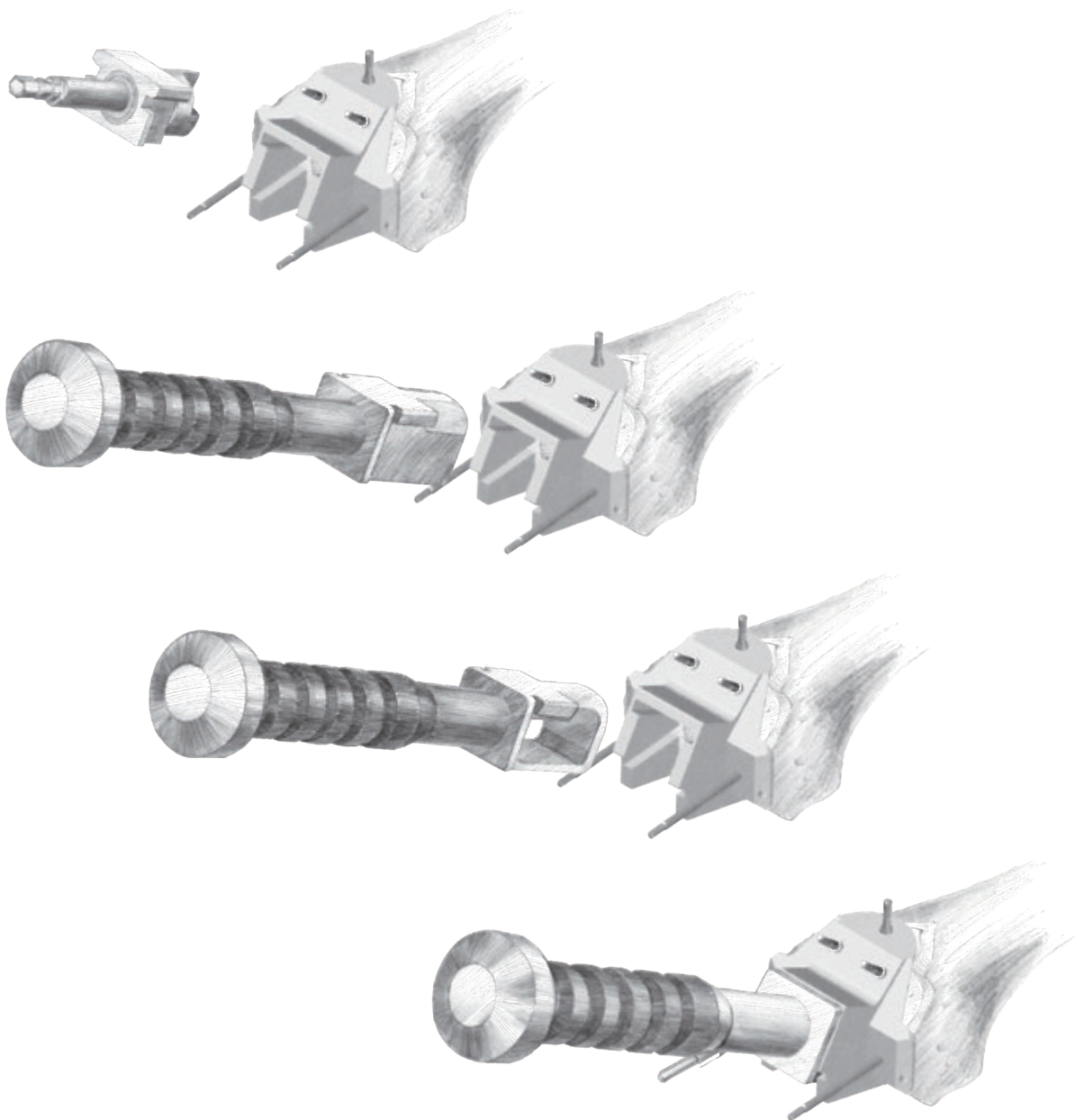

# D. Posterior Stabilized Femoral Component Preparation

## D.3. PS Femoral Trial Reduction

Introduce the **PS Femoral Trial** <sup>41</sup> onto the femur, carefully aligning the PS Housing of the Trial implant to the cut housing in the femoral bone. Advance the **PS Femoral Trial** <sup>41</sup> and **Femoral Driver** <sup>26</sup> carefully with a mallet until fully seated.

Insert an appropriate size and thickness of **PS Tibial Insert Trial** <sup>42</sup> onto the **Tibial Baseplate Trial** <sup>29</sup> and **PS Femoral Trial** <sup>41</sup> in a normal fashion. Once trialing is completed, the trials may be removed in a standard fashion.

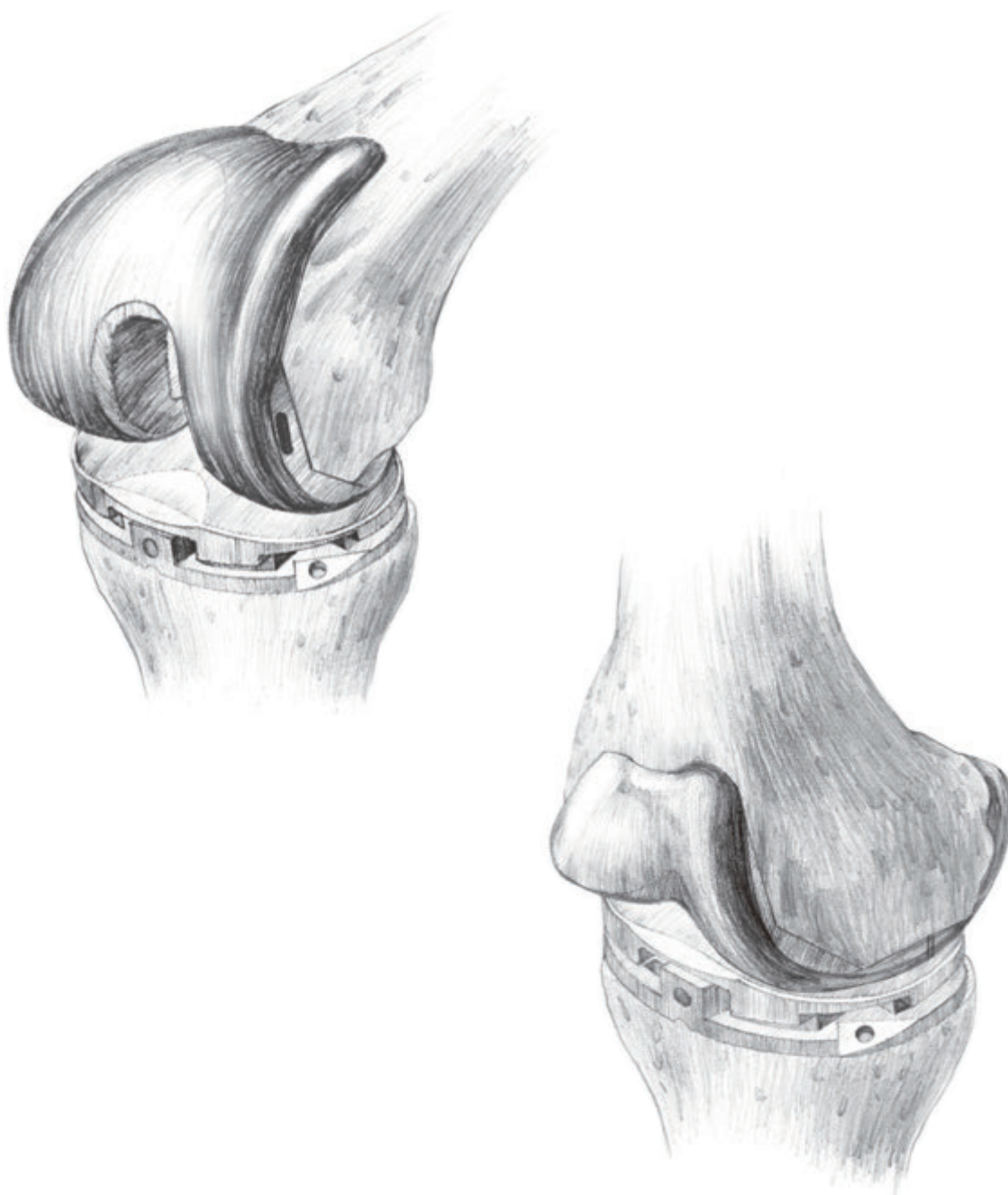

41 Femoral Trial, PS  
C/N varies by size



42 Tibial Insert Trial, PS  
C/N varies by size



# E. Patellar Preparation

43 Caliper  
9401-7012



There are two options for patellar component: Inset and Onset.

## E.1. Inset Patellar Component Preparation

Evert the patellar and remove excessive osteophytes. With a **Caliper** <sup>43</sup>, measure and record the thickness of the anterior-posterior dimension of the patella.

NOTE : In planning the resection thickness, it is recommended to retain a 10 mm minimal thickness of retained patella bone to support the implant structure.

The **Patellar Sizing Ring** <sup>44</sup> is used to determine the desired patellar diameter and positioning. Typically, the Ring is positioned over the highest point of the articulation and the center position is marked with a cautery or ink.

44 Patellar Sizing Ring  
9401-7002

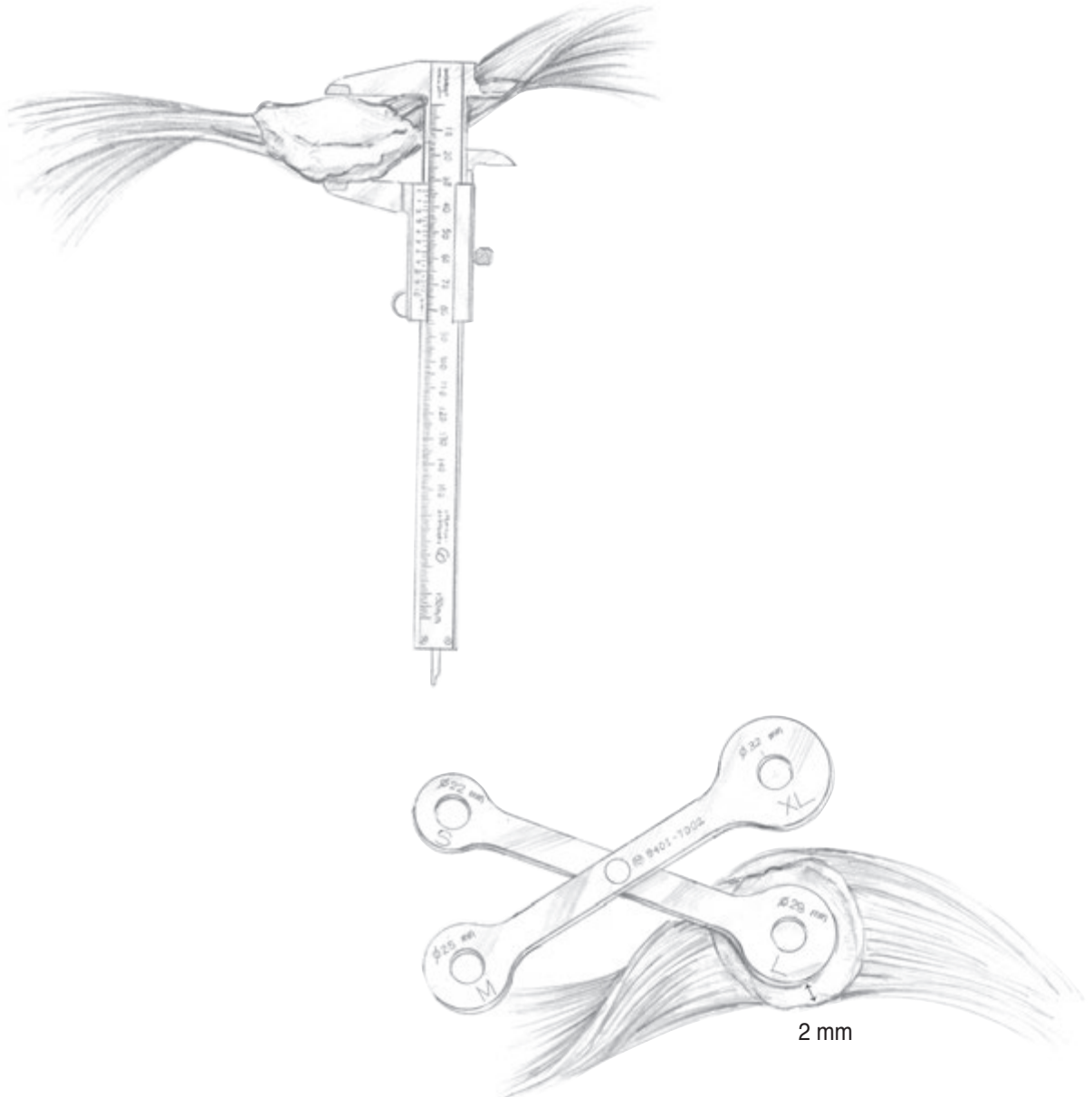



# E. Patellar Preparation

## E.1.1. Inset Patellar Reaming Depth and Pilot Hole

Attach the **Patellar Clamp Ring** <sup>45</sup> to the **Patellar Resection Clamp** <sup>46</sup> of the chosen size. Center the Ring at the highest position of the patella and clamp the patella for fixation. Place a **Patellar Drill Depth Sleeve** <sup>47</sup> on the clamp ring. Direct the **Patellar Reamer** <sup>48</sup> downwards into the Ring, with its tip touching the highest point of patellar. Place **Patellar Reamer Stopper** <sup>49</sup> level on the sleeve and tighten the stopper with a **Screw Driver** <sup>50</sup>. Make sure the drill depth of the reamer equals to the patellar component thickness. Remove the sleeve and insert a **Patellar Drill Guide** <sup>51</sup> of the same size. Next, use the **Patellar Drill** <sup>52</sup> to create the pilot hole for the patellar component. Once the drilling is completed, the **Patellar Reamer** <sup>48</sup> is reintroduced into the **Patellar Clamp Ring** <sup>45</sup> for creating the inset patellar bed.

**NOTE:** If the thickness of patella is smaller than 20 mm, it will be necessary to adjust the stopper manually to the desired drill depth to retain at least 8 mm patellar thickness.



45 Patellar Clamp Ring  
C/N varies by size



46 Patellar Resection Clamp  
9401-5302-RB



47 Patellar Drill Depth Sleeve  
C/N varies by size



48 Patellar Reamer  
C/N varies by size



49 Patellar Reamer Stopper  
9401-4205



50 Screw Driver  
9401-5307



51 Patellar Drill Guide  
C/N varies by size



52 Patellar Drill  
9401-5121



# E. Patellar Preparation

## E.1.2. Drill Hole Completion and Trial Installation

Now the **Patellar Resection Clamp** <sup>46</sup> is removed, and the **Inset Patellar Trial** <sup>53</sup> is in the position of the prepared bone bed. The peripheral bone shoulder surrounding the inset patellar trial is accessed, and may be trimmed to achieve a smooth blending of the implant periphery to the bony shoulder.

53 Patellar Trial, Inset  
2401-2010  
2401-2020  
2401-2030  
2401-2040

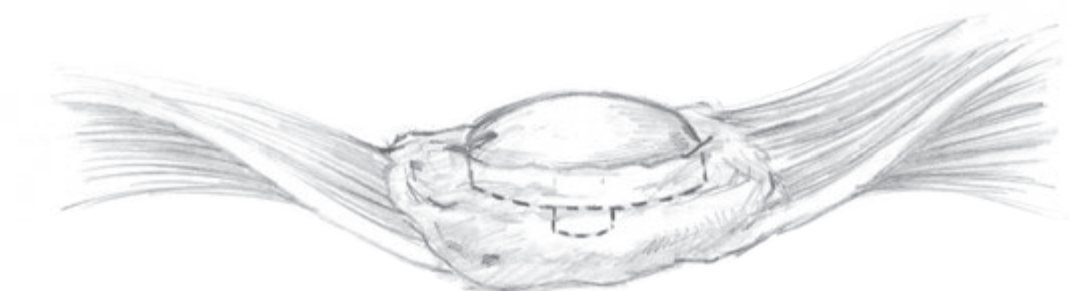

# E. Patellar Preparation

## E.2. Onset Patellar Component Preparation

When the Onset patellar component is chosen, assemble the **Onset Patellar Resection Guide** <sup>54</sup> to the **Patellar Resection Clamp** <sup>46</sup>. Use the stylus on the bottom of onset patellar resection guide to check if the remained patellar thickness exceeds 10 mm. If so, clamp the patella tight and place the saw blade into the slot of the clamp and resect the patella until the showing subchondral bone. Then choose the appropriate size **Onset Patellar Drill Guide** <sup>55</sup>, and drill three round fixation peg holes with the **Onset Patellar Peg Drill** <sup>56</sup>. Now the preparation for onset patellar component is completed.

Now the **Onset Patellar Trial** <sup>57</sup> may be positioned. Assessing the contact and stability of the bone/implant couple. A thickness measurement of the implant/bone couple may be performed to assure the original patellar A-P thickness. Trialing is performed in a standard fashion.

54 Onset Patellar Resection Guide  
9403-5302-RB



55 Onset Patellar Drill Guide  
C/N varies by size



56 Onset Patellar Peg Drill  
9403-4001



57 Patellar Trial, Onset  
C/N varies by size

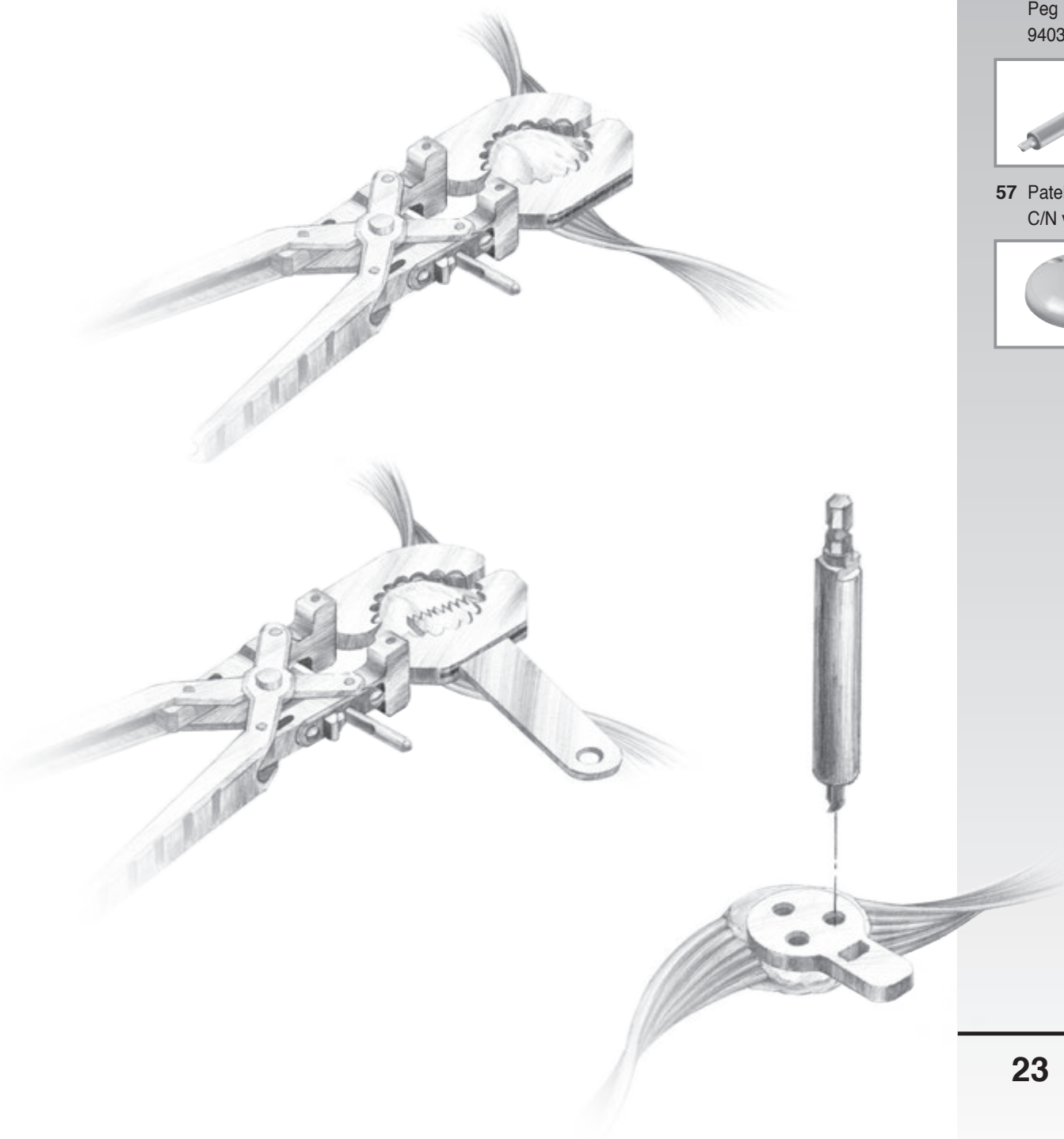

# F. Implant Fixation

## F.1. Final Trial Reduction

Apply the patellar trial, femoral trial, tibial baseplate trial, and tibial insert trial to the corresponding resected bony surfaces. Test for the joint laxity and range of motion, and observe how muscles and ligaments react at extension and flexion. If it is too loose or too tight, adjust the soft tissue tension to ensure both joint stability and mobility are ideal. After testing is done, remove all trials and clean the cutting surface.

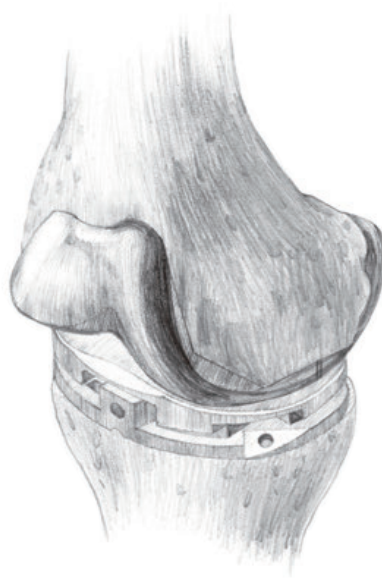

# F. Implant Fixation

## F.2. Implant Fixation

To impact the Tibial Baseplate, it is recommended to carefully introduce and align the stem of the implant into the prepared stem hole. The implant may be positioned by hand or by using the **Tibial Baseplate Driver** <sup>58</sup>. Once the Tibial Baseplate is advanced sufficiently, the **Tibial Baseplate Impactor** <sup>59</sup> may then be used to complete seating of the implant.

To impact the Femoral Implant, the **Femoral Driver** <sup>26</sup> is assembled onto the Femoral Implant. Carefully align the femoral implant with the distal femur to assure correct advancement and seating of the implant. The **Femoral Impactor** <sup>27</sup> may also be used for seating if desired.

The Patellar Implant is first seated by hand, carefully aligning the implant peg(s) with the prepared bone bed. The **Patellar Resection Clamp** <sup>46</sup> is equipped with the **Patella Cement Clamp Adaptor** <sup>60</sup>. This assembly is then used to fully seat the cemented implant in a standard fashion.

Femoral Tibial trialing may now be performed again if desired.

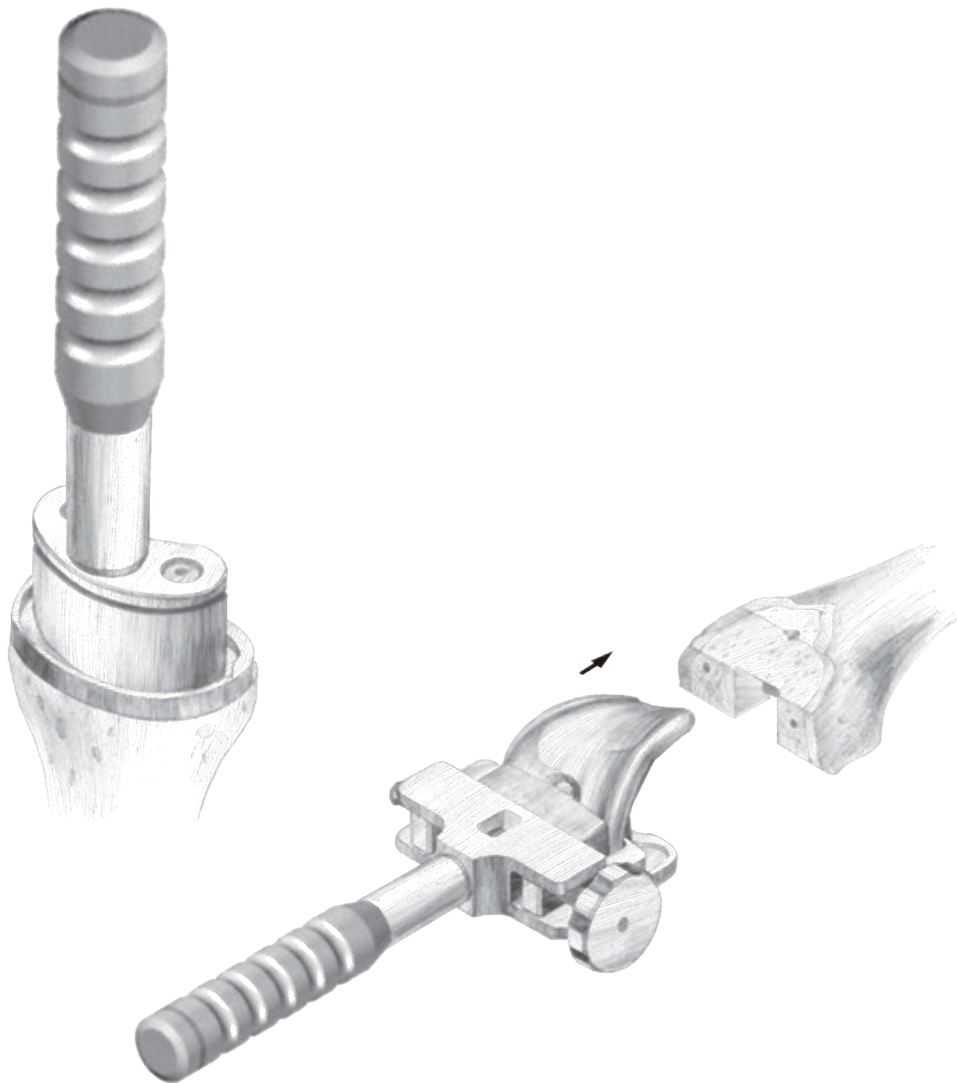

58 Tibial Baseplate Driver  
9403-5101-RC



59 Tibial Baseplate Impactor  
9403-5102-RF



60 Patella Cement Clamp Adaptor  
9401-5312-RD



## F. Implant Fixation

61 Universal Impactor  
9303-5119-RB



Prior insertion of the final Tibial Insert, place the knee in a flexed position and be sure to adequately retract soft tissues to allow proper visualization of the Tibial Base peripheral locking detail.

It is recommended to initially introduce the Tibial Insert by hand onto the Tibial Baseplate. Once initial engagement with the locking detail is verified, the grooved **Universal Impactor**<sup>61</sup> may be used to fully seat the Insert. All areas of the assembly are then visually assessed for complete seating and locking detail engagement.





# Implant Catalog

## U2 Femoral Component

Catalog Number	Description
2103-1110	CR, porous, #1, left
2103-1120	CR, porous, #2, left
2103-1130	CR, porous, #3, left
2103-1140	CR, porous, #4, left
2103-1150	CR, porous, #5, left
2103-1160	CR, porous, #6, left
2103-1170	CR, porous, #7, left
2103-1210	CR, porous, #1, right
2103-1220	CR, porous, #2, right
2103-1230	CR, porous, #3, right
2103-1240	CR, porous, #4, right
2103-1250	CR, porous, #5, right
2103-1260	CR, porous, #6, right
2103-1270	CR, porous, #7, right
2103-1310	CR, cemented, #1, left
2103-1320	CR, cemented, #2, left
2103-1330	CR, cemented, #3, left
2103-1340	CR, cemented, #4, left
2103-1350	CR, cemented, #5, left
2103-1360	CR, cemented, #6, left
2103-1370	CR, cemented, #7, left
2103-1410	CR, cemented, #1, right
2103-1420	CR, cemented, #2, right
2103-1430	CR, cemented, #3, right
2103-1440	CR, cemented, #4, right
2103-1450	CR, cemented, #5, right
2103-1460	CR, cemented, #6, right
2103-1470	CR, cemented, #7, right
2103-3110	PS, #1, left
2103-3120	PS, #2, left
2103-3130	PS, #3, left
2103-3140	PS, #4, left
2103-3150	PS, #5, left
2103-3160	PS, #6, left
2103-3170	PS, #7, left
2103-3210	PS, #1, right
2103-3220	PS, #2, right
2103-3230	PS, #3, right
2103-3240	PS, #4, right
2103-3250	PS, #5, right
2103-3260	PS, #6, right
2103-3270	PS, #7, right

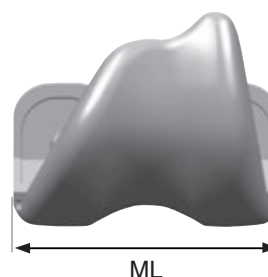
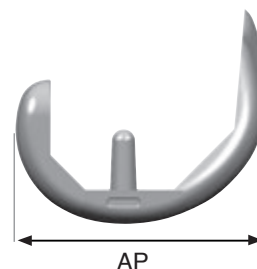

Size	AP (mm)	ML (mm)
1	52	56
2	56	60
3	60	64
4	64	68
5	68	72
6	72	76
7	76	80

## U2 Tibial Baseplate

Catalog Number	Description
2203-3010	Cemented, #1
2203-3020	Cemented, #2
2203-3030	Cemented, #3
2203-3040	Cemented, #4
2203-3050	Cemented, #5
2203-3060	Cemented, #6

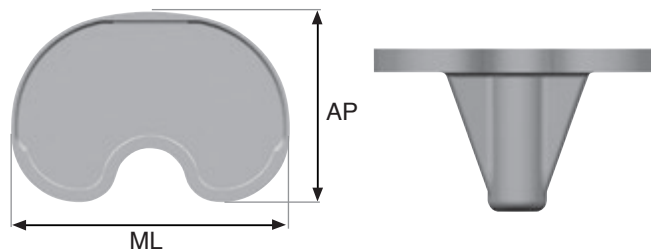

Size	1	2	3	4	5	6
AP (mm)	42	44.5	47	49.5	52.5	55.5
ML (mm)	63	66	69	72	76	80



# Implant Catalog

## Tibial Insert



Catalog Number	Description
2303-1211	CR, #1, 9 mm
2303-1212	CR, #1, 11 mm
2303-1213	CR, #1, 13 mm
2303-1214	CR, #1, 15 mm
2303-1215	CR, #1, 18 mm
2303-1221	CR, #2, 9 mm
2303-1222	CR, #2, 11 mm
2303-1223	CR, #2, 13 mm
2303-1224	CR, #2, 15 mm
2303-1225	CR, #2, 18 mm
2303-1231	CR, #3, 9 mm
2303-1232	CR, #3, 11 mm
2303-1233	CR, #3, 13 mm
2303-1234	CR, #3, 15 mm
2303-1235	CR, #3, 18 mm
2303-1241	CR, #4, 9 mm
2303-1242	CR, #4, 11 mm
2303-1243	CR, #4, 13 mm
2303-1244	CR, #4, 15 mm
2303-1245	CR, #4, 18 mm
2303-1251	CR, #5, 9 mm
2303-1252	CR, #5, 11 mm
2303-1253	CR, #5, 13 mm
2303-1254	CR, #5, 15 mm
2303-1255	CR, #5, 18 mm
2303-1261	CR, #6, 9 mm
2303-1262	CR, #6, 11 mm
2303-1263	CR, #6, 13 mm
2303-1264	CR, #6, 15 mm
2303-1265	CR, #6, 18 mm



Catalog Number	Description
2303-3011	PS, #1, 9 mm
2303-3012	PS, #1, 11 mm
2303-3013	PS, #1, 13 mm
2303-3014	PS, #1, 15 mm
2303-3015	PS, #1, 18 mm
2303-3021	PS, #2, 9 mm
2303-3022	PS, #2, 11 mm
2303-3023	PS, #2, 13 mm
2303-3024	PS, #2, 15 mm
2303-3025	PS, #2, 18 mm
2303-3031	PS, #3, 9 mm
2303-3032	PS, #3, 11 mm
2303-3033	PS, #3, 13 mm
2303-3034	PS, #3, 15 mm
2303-3035	PS, #3, 18 mm
2303-3041	PS, #4, 9 mm
2303-3042	PS, #4, 11 mm
2303-3043	PS, #4, 13 mm
2303-3044	PS, #4, 15 mm
2303-3045	PS, #4, 18 mm
2303-3051	PS, #5, 9 mm
2303-3052	PS, #5, 11 mm
2303-3053	PS, #5, 13 mm
2303-3054	PS, #5, 15 mm
2303-3055	PS, #5, 18 mm
2303-3061	PS, #6, 9 mm
2303-3062	PS, #6, 11 mm
2303-3063	PS, #6, 13 mm
2303-3064	PS, #6, 15 mm
2303-3065	PS, #6, 18 mm

## XPE Tibial Insert



Catalog Number	Description
2303-1611	XCR, #1, 9 mm
2303-1612	XCR, #1, 11 mm
2303-1613	XCR, #1, 13 mm
2303-1614	XCR, #1, 15 mm
2303-1615	XCR, #1, 18 mm
2303-1621	XCR, #2, 9 mm
2303-1622	XCR, #2, 11 mm
2303-1623	XCR, #2, 13 mm
2303-1624	XCR, #2, 15 mm
2303-1625	XCR, #2, 18 mm
2303-1631	XCR, #3, 9 mm
2303-1632	XCR, #3, 11 mm
2303-1633	XCR, #3, 13 mm
2303-1634	XCR, #3, 15 mm
2303-1635	XCR, #3, 18 mm
2303-1641	XCR, #4, 9 mm
2303-1642	XCR, #4, 11 mm
2303-1643	XCR, #4, 13 mm
2303-1644	XCR, #4, 15 mm
2303-1645	XCR, #4, 18 mm
2303-1651	XCR, #5, 9 mm
2303-1652	XCR, #5, 11 mm
2303-1653	XCR, #5, 13 mm
2303-1654	XCR, #5, 15 mm
2303-1655	XCR, #5, 18 mm
2303-1661	XCR, #6, 9 mm
2303-1662	XCR, #6, 11 mm
2303-1663	XCR, #6, 13 mm
2303-1664	XCR, #6, 15 mm
2303-1665	XCR, #6, 18 mm



Catalog Number	Description
2303-3611	XPS, #1, 9 mm
2303-3612	XPS, #1, 11 mm
2303-3613	XPS, #1, 13 mm
2303-3614	XPS, #1, 15 mm
2303-3615	XPS, #1, 18 mm
2303-3621	XPS, #2, 9 mm
2303-3622	XPS, #2, 11 mm
2303-3623	XPS, #2, 13 mm
2303-3624	XPS, #2, 15 mm
2303-3625	XPS, #2, 18 mm
2303-3631	XPS, #3, 9 mm
2303-3632	XPS, #3, 11 mm
2303-3633	XPS, #3, 13 mm
2303-3634	XPS, #3, 15 mm
2303-3635	XPS, #3, 18 mm
2303-3641	XPS, #4, 9 mm
2303-3642	XPS, #4, 11 mm
2303-3643	XPS, #4, 13 mm
2303-3644	XPS, #4, 15 mm
2303-3645	XPS, #4, 18 mm
2303-3651	XPS, #5, 9 mm
2303-3652	XPS, #5, 11 mm
2303-3653	XPS, #5, 13 mm
2303-3654	XPS, #5, 15 mm
2303-3655	XPS, #5, 18 mm
2303-3661	XPS, #6, 9 mm
2303-3662	XPS, #6, 11 mm
2303-3663	XPS, #6, 13 mm
2303-3664	XPS, #6, 15 mm
2303-3665	XPS, #6, 18 mm

## Inset Patellar Component

Catalog Number	Description	
2401-1010	Size S	ø22 mm
2401-1020	Size M	ø25 mm
2401-1030	Size L	ø28 mm
2401-1040	Size XL	ø32 mm
2403-3010	XPE, Size S	ø22 mm
2403-3020	XPE, Size M	ø25 mm
2403-3030	XPE, Size L	ø28 mm
2403-3040	XPE, Size XL	ø32 mm

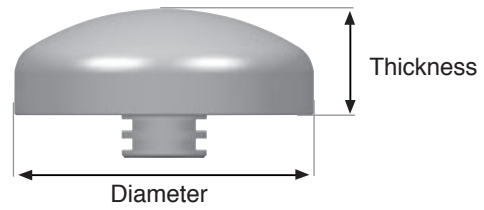

Size	S	M	L	XL
Diameter(mm)	22	25	28	32
Thickness(mm)	8	10	10	10

## Onset Patellar Component

Catalog Number	Description	
2403-1010	Size XS	ø26 mm
2403-1020	Size S	ø29 mm
2403-1030	Size M	ø32 mm
2403-1040	Size L	ø35 mm
2403-1050	Size XL	ø38 mm
2403-1060	Size 2XL	ø41 mm
2403-1070	Size 3XL	ø44 mm
2403-3210	XPE, Size XS	ø26 mm
2403-3220	XPE, Size S	ø29 mm
2403-3230	XPE, Size M	ø32 mm
2403-3240	XPE, Size L	ø35 mm
2403-3250	XPE, Size XL	ø38 mm
★ 2403-3260	XPE, Size 2XL	ø41 mm
★ 2403-3270	XPE, Size 3XL	ø44 mm

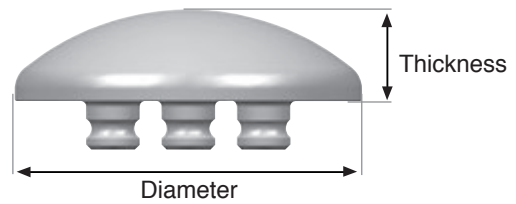

Size	XS	S	M	L	XL	2XL	3XL
Diameter(mm)	26	29	32	35	38	41	44
Thickness(mm)	7	8	8.5	9	9.5	10	10.5



# Instrument Catalog

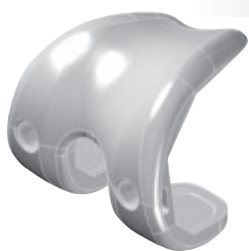

Catalog Number	Description
2103-2110	Femoral Trial CR, Left, #1
2103-2120	Femoral Trial CR, Left, #2
2103-2130	Femoral Trial CR, Left, #3
2103-2140	Femoral Trial CR, Left, #4
2103-2150	Femoral Trial CR, Left, #5
2103-2160	Femoral Trial CR, Left, #6
2103-2170	Femoral Trial CR, Left, #7
2103-2210	Femoral Trial CR, Right, #1
2103-2220	Femoral Trial CR, Right, #2
2103-2230	Femoral Trial CR, Right, #3
2103-2240	Femoral Trial CR, Right, #4
2103-2250	Femoral Trial CR, Right, #5
2103-2260	Femoral Trial CR, Right, #6
2103-2270	Femoral Trial CR, Right, #7



2103-4110	Femoral Trial PS, Left, #1
2103-4120	Femoral Trial PS, Left, #2
2103-4130	Femoral Trial PS, Left, #3
2103-4140	Femoral Trial PS, Left, #4
2103-4150	Femoral Trial PS, Left, #5
2103-4160	Femoral Trial PS, Left, #6
2103-4170	Femoral Trial PS, Left, #7
2103-4210	Femoral Trial PS, Right, #1
2103-4220	Femoral Trial PS, Right, #2
2103-4230	Femoral Trial PS, Right, #3
2103-4240	Femoral Trial PS, Right, #4
2103-4250	Femoral Trial PS, Right, #5
2103-4260	Femoral Trial PS, Right, #6
2103-4270	Femoral Trial PS, Right, #7



Catalog Number	Description
2203-4010-RB	Tibial Baseplate Trial #1
2203-4020-RB	Tibial Baseplate Trial #2
2203-4030-RB	Tibial Baseplate Trial #3
2203-4040-RB	Tibial Baseplate Trial #4
2203-4050-RB	Tibial Baseplate Trial #5
2203-4060-RB	Tibial Baseplate Trial #6



Catalog Number	Description
2303-2211	Tibial Insert Trial CR, #1 9 mm
2303-2212	Tibial Insert Trial CR, #1 11 mm
2303-2213	Tibial Insert Trial CR, #1 13 mm
2303-2214	Tibial Insert Trial CR, #1 15 mm
2303-2215	Tibial Insert Trial CR, #1 18 mm
2303-2221	Tibial Insert Trial CR, #2 9 mm
2303-2222	Tibial Insert Trial CR, #2 11 mm
2303-2223	Tibial Insert Trial CR, #2 13 mm
2303-2224	Tibial Insert Trial CR, #2 15 mm
2303-2225	Tibial Insert Trial CR, #2 18 mm
2303-2231	Tibial Insert Trial CR, #3 9 mm
2303-2232	Tibial Insert Trial CR, #3 11 mm
2303-2233	Tibial Insert Trial CR, #3 13 mm
2303-2234	Tibial Insert Trial CR, #3 15 mm
2303-2235	Tibial Insert Trial CR, #3 18 mm

# Instrument Catalog



## Catalog Number Description

2303-2241	Tibial Insert Trial	CR, #4, 9 mm
2303-2242	Tibial Insert Trial	CR, #4, 11 mm
2303-2243	Tibial Insert Trial	CR, #4, 13 mm
2303-2244	Tibial Insert Trial	CR, #4, 15 mm
2303-2245	Tibial Insert Trial	CR, #4, 18 mm
2303-2251	Tibial Insert Trial	CR, #5, 9 mm
2303-2252	Tibial Insert Trial	CR, #5, 11 mm
2303-2253	Tibial Insert Trial	CR, #5, 13 mm
2303-2254	Tibial Insert Trial	CR, #5, 15 mm
2303-2255	Tibial Insert Trial	CR, #5, 18 mm
2303-2261	Tibial Insert Trial	CR, #6, 9 mm
2303-2262	Tibial Insert Trial	CR, #6, 11 mm
2303-2263	Tibial Insert Trial	CR, #6, 13 mm
2303-2264	Tibial Insert Trial	CR, #6, 15 mm
2303-2265	Tibial Insert Trial	CR, #6, 18 mm



## Catalog Number Description

2303-4011	Tibial Insert Trial	PS, #1, 9 mm
2303-4012	Tibial Insert Trial	PS, #1, 11 mm
2303-4013	Tibial Insert Trial	PS, #1, 13 mm
2303-4014	Tibial Insert Trial	PS, #1, 15 mm
2303-4015	Tibial Insert Trial	PS, #1, 18 mm
2303-4021	Tibial Insert Trial	PS, #2, 9 mm
2303-4022	Tibial Insert Trial	PS, #2, 11 mm
2303-4023	Tibial Insert Trial	PS, #2, 13 mm
2303-4024	Tibial Insert Trial	PS, #2, 15 mm
2303-4025	Tibial Insert Trial	PS, #2, 18 mm
2303-4031	Tibial Insert Trial	PS, #3, 9 mm
2303-4032	Tibial Insert Trial	PS, #3, 11 mm
2303-4033	Tibial Insert Trial	PS, #3, 13 mm
2303-4034	Tibial Insert Trial	PS, #3, 15 mm
2303-4035	Tibial Insert Trial	PS, #3, 18 mm
2303-4041	Tibial Insert Trial	PS, #4, 9 mm
2303-4042	Tibial Insert Trial	PS, #4, 11 mm
2303-4043	Tibial Insert Trial	PS, #4, 13 mm
2303-4044	Tibial Insert Trial	PS, #4, 15 mm
2303-4045	Tibial Insert Trial	PS, #4, 18 mm
2303-4051	Tibial Insert Trial	PS, #5, 9 mm
2303-4052	Tibial Insert Trial	PS, #5, 11 mm
2303-4053	Tibial Insert Trial	PS, #5, 13 mm
2303-4054	Tibial Insert Trial	PS, #5, 15 mm
2303-4055	Tibial Insert Trial	PS, #5, 18 mm
2303-4061	Tibial Insert Trial	PS, #6, 9 mm
2303-4062	Tibial Insert Trial	PS, #6, 11 mm
2303-4063	Tibial Insert Trial	PS, #6, 13 mm
2303-4064	Tibial Insert Trial	PS, #6, 15 mm
2303-4065	Tibial Insert Trial	PS, #6, 18 mm



**Catalog Number Description**

2401-2010	Patellar Trial, Inset, S	ø22 mm
2401-2020	Patellar Trial, Inset, M	ø25 mm
2401-2030	Patellar Trial, Inset, L	ø28 mm
2401-2040	Patellar Trial, Inset, XL	ø32 mm



**Catalog Number Description**

2403-2010	Patellar Trial, Onset, Size XS	ø26 mm
2403-2020	Patellar Trial, Onset, Size S	ø29 mm
2403-2030	Patellar Trial, Onset, Size M	ø32 mm
2403-2040	Patellar Trial, Onset, Size L	ø35 mm
2403-2050	Patellar Trial, Onset, Size XL	ø38 mm
★ 2403-2060	Patellar Trial, Onset, Size 2XL	ø41 mm
★ 2403-2070	Patellar Trial, Onset, Size 3XL	ø44 mm



**Catalog Number Description**

9301-1100	T-Handle
-----------	----------



**Catalog Number Description**

9301-2101-RB	Starter
--------------	---------



**Catalog Number Description**

9301-2251	Lower Point Gauge, 1.3 mm
-----------	---------------------------

# Instrument Catalog



Catalog Number	Description
9301-2282	Extramedullary Alignment Tower



Catalog Number	Description
9301-2291	Femoral A/P Chamfer Guide Handle



Catalog Number	Description
9301-3201	Twist Drill, ø8 mm



Catalog Number	Description
9301-3207	Spike, Short

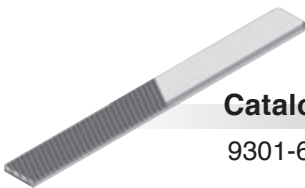

Catalog Number	Description
9301-6202	Bone File

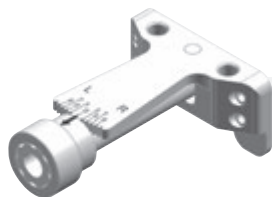

Catalog Number	Description
9303-2111-RA	Femoral IM Alignment Guide

# Instrument Catalog



## Catalog Number Description

9303-2102-RA Distal Femoral Alignment Guide



## Catalog Number Description

9303-2103-RC Distal Femoral Cutting Guide



## Catalog Number Description

9303-2104 PS Cutting Jig Drill Guide

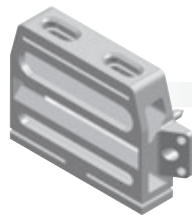

## Catalog Number Description

9303-2110-RC Femoral A/P Chamfer Cutting Guide #1  
 9303-2120-RC Femoral A/P Chamfer Cutting Guide #2  
 9303-2130-RC Femoral A/P Chamfer Cutting Guide #3  
 9303-2140-RC Femoral A/P Chamfer Cutting Guide #4  
 9303-2150-RC Femoral A/P Chamfer Cutting Guide #5  
 9303-2160-RC Femoral A/P Chamfer Cutting Guide #6  
 9303-2170-RC Femoral A/P Chamfer Cutting Guide #7



## Catalog Number Description

9303-2210-RC PS Notch Cutting Jig #1  
 9303-2220-RC PS Notch Cutting Jig #2  
 9303-2230-RC PS Notch Cutting Jig #3  
 9303-2240-RC PS Notch Cutting Jig #4  
 9303-2250-RC PS Notch Cutting Jig #5  
 9303-2260-RC PS Notch Cutting Jig #6  
 9303-2270-RC PS Notch Cutting Jig #7



## Catalog Number Description

9303-3200 Femoral IM Rod, 400 mm



# Instrument Catalog



Catalog Number	Description
----------------	-------------

9303-3201	Spike, Short
9303-3202	Spike, Long

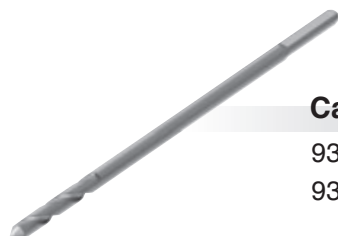

Catalog Number	Description
----------------	-------------

9303-3203	Twist Drill, ø3.2 mm, Short
9303-3204	Twist Drill, ø3.2 mm, Long

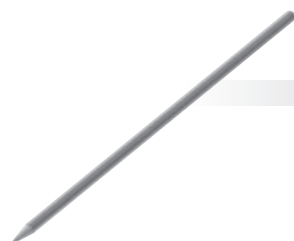

Catalog Number	Description
----------------	-------------

9303-3205	Round Pin, ø3.2x120 mm
-----------	------------------------



Catalog Number	Description
----------------	-------------

9303-3206	Femoral Condyle Drill
-----------	-----------------------

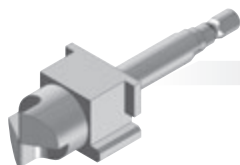

Catalog Number	Description
----------------	-------------

9303-4101-RF	PS Reamer
--------------	-----------



Catalog Number	Description
----------------	-------------

9303-5001-RA	Quick Pin Driver
--------------	------------------

# Instrument Catalog

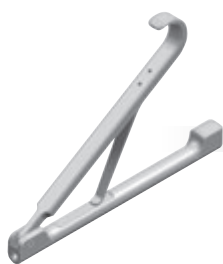

Catalog Number	Description
----------------	-------------

9303-5002	Pin Extractor
-----------	---------------

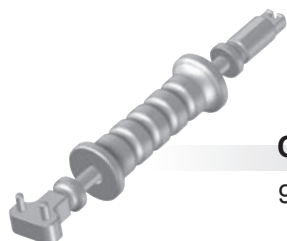

Catalog Number	Description
----------------	-------------

9303-5101	Spike and Tibial EM Guide Extractor
-----------	-------------------------------------

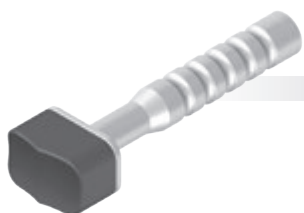

Catalog Number	Description
----------------	-------------

9303-5103-RB	Femoral Impactor
--------------	------------------

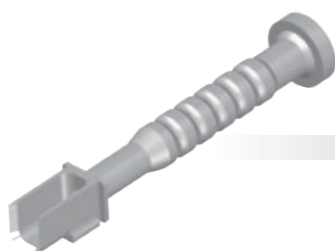

Catalog Number	Description
----------------	-------------

9303-5104-RA	PS Housing Punch
--------------	------------------

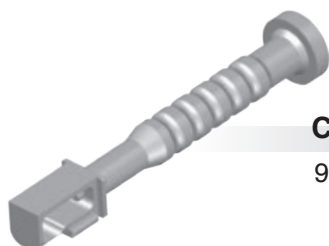

Catalog Number	Description
----------------	-------------

9303-5105-RA	PS Housing Impactor
--------------	---------------------

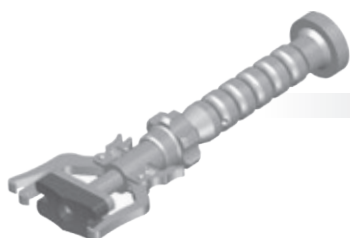

Catalog Number	Description
----------------	-------------

9303-5110	Femoral Driver
-----------	----------------

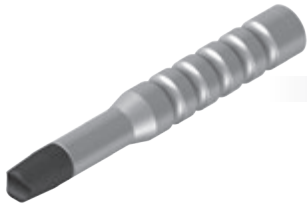

**Catalog Number Description**

9303-5119-RB Universal Impactor



**Catalog Number Description**

9303-7101-RE Femoral Sizer, Anterior Ref.

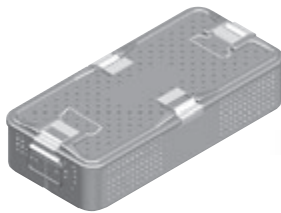

**Catalog Number Description**

9303-8010	Tool Box	U2 Knee Case #1
9303-8020	Tool Box	U2 Knee Case #2
9303-8030-RA	Tool Box	U2 Knee Case #3
9303-8040-RA	Tool Box	U2 Knee Case #4
★ 9303-8041	Tool Box	U2 Knee Case #5



**Catalog Number Description**

9401-2203 Tibial IM Rod



**Catalog Number Description**

9401-4201	Patellar Reamer, Size S
9401-4202	Patellar Reamer, Size M
9401-4203	Patellar Reamer, Size L
9401-4204	Patellar Reamer, Size XL

# Instrument Catalog



Catalog Number	Description
9401-4205	Patellar Reamer Stopper



Catalog Number	Description
9401-5113	Patellar Drill Depth Sleeve, Size S
9401-5114	Patellar Drill Depth Sleeve, Size M
9401-5115	Patellar Drill Depth Sleeve, Size L
9401-5116	Patellar Drill Depth Sleeve, Size XL



Catalog Number	Description
9401-5121	Patellar Drill

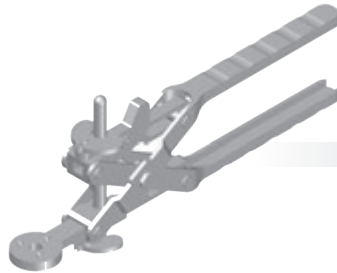

Catalog Number	Description
9401-5302-RB	Patellar Resection Clamp

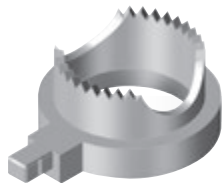

Catalog Number	Description
9401-5303-RA	Patellar Clamp Ring, Size S
9401-5304-RA	Patellar Clamp Ring, Size M
9401-5305-RA	Patellar Clamp Ring, Size L
9401-5306-RA	Patellar Clamp Ring, Size XL



Catalog Number	Description
9401-5307	Screw Driver

# Instrument Catalog

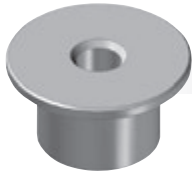

Catalog Number	Description
----------------	-------------

9401-5308	Patellar Drill Guide, Size S
9401-5309	Patellar Drill Guide, Size M
9401-5310	Patellar Drill Guide, Size L
9401-5311	Patellar Drill Guide, Size XL

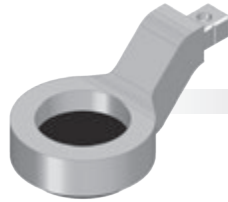

Catalog Number	Description
----------------	-------------

9401-5312-RD	Patellar Cement Clamp Adapter
--------------	-------------------------------



Catalog Number	Description
----------------	-------------

9401-7002	Patellar Sizing Ring
-----------	----------------------

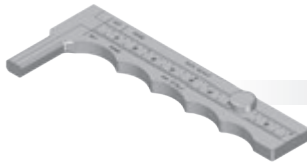

Catalog Number	Description
----------------	-------------

9401-7012	Caliper
-----------	---------

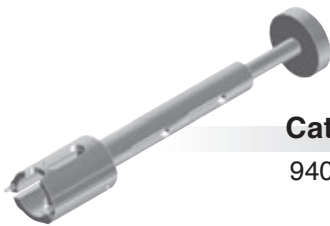

Catalog Number	Description
----------------	-------------

9403-1101-RC	Tibial Punch Handle, CM
--------------	-------------------------



Catalog Number	Description
----------------	-------------

9403-1202	Tibial Baseplate Trial Handle
-----------	-------------------------------

# Instrument Catalog



## Catalog Number Description

9403-2103-RA Tibial IM Alignment Guide



## Catalog Number Description

9403-2104-RA Tibial EM Alignment Guide

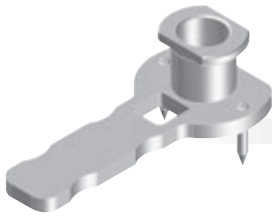

## Catalog Number Description

9403-2105 Tibial Drill Guide



## Catalog Number Description

9403-2120-RE Tibial Cutting Jig, 0°(Left)  
9403-2125-RE Tibial Cutting Jig, 5°(Left)  
9403-2220-RE Tibial Cutting Jig, 0°(Right)  
9403-2225-RE Tibial Cutting Jig, 5°(Right)

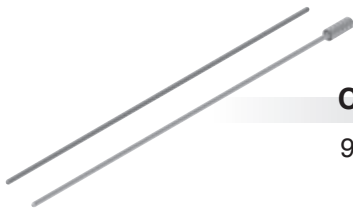

## Catalog Number Description

9403-2202 Alignment Rod



## Catalog Number Description

9403-3001 Tibial Drill

# Instrument Catalog



Catalog Number	Description
9403-4001	Onset Patellar Peg Drill

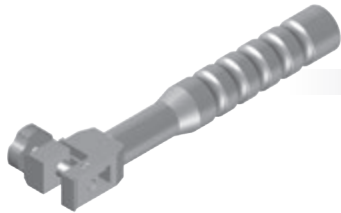

Catalog Number	Description
9403-5101-RC	Tibial Baseplate Driver

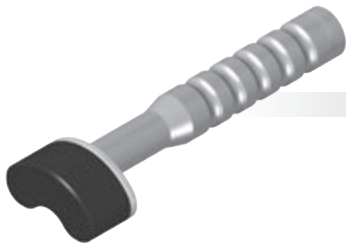

Catalog Number	Description
9403-5102-RF	Tibial Baseplate Impactor



Catalog Number	Description
9403-5104	Tibial Insert Extractor



Catalog Number	Description
9403-5302-RB	Onset Patellar Resection Guide



**Catalog Number Description**

9403-5307-RA	Onset Patellar Drill Guide, ø26 mm
9403-5308-RA	Onset Patellar Drill Guide, ø29 mm
9403-5309-RA	Onset Patellar Drill Guide, ø32 mm
9403-5310-RA	Onset Patellar Drill Guide, ø35 mm
9403-5311-RA	Onset Patellar Drill Guide, ø38 mm
★ 9403-5312-RA	Onset Patellar Drill Guide, ø41 mm
★ 9403-5313-RA	Onset Patellar Drill Guide, ø44 mm



**Catalog Number Description**

9403-6010	Cemented Tibial Punch, Size S
9403-6020	Cemented Tibial Punch, Size M
9403-6030	Cemented Tibial Punch, Size L

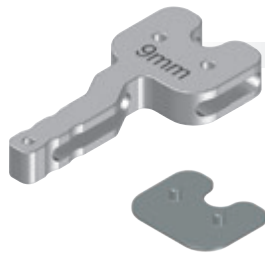

**Catalog Number Description**

9403-7009	Gap Gauge, 9 mm
9403-7011	Gap Gauge, 11 mm
9403-7013	Gap Gauge, 13 mm
9403-7015	Gap Gauge, 15 mm
9403-7018	Gap Gauge, 18 mm



**Catalog Number Description**

9403-7101-RA	Tibial Stylus
--------------	---------------



# Safety Statement - U2™ Total Knee System

## DESCRIPTION

The U2 Total Knee System include femoral components, patellar components, tibial baseplate components and tibial inserts components which are designed to be used together to achieve total replacement of the knee joint.

The femoral components are available in cruciate retained and posterior stabilized designs. The U2 Posterior Stabilized femoral components are not designed for use with the tibial inserts when cruciate ligaments excised and thus must not be utilized together.

The tibial baseplate components include fixed and mobile types with groove for cement fixation. Tibial inserts for the fixed type tibial baseplate are available in a range of thicknesses and in three design configurations: Cruciate Retained (CR) inserts have increased anterior and posterior bearing geometry surfaces for additional stability against subluxation. Posterior Stabilized (PS) inserts have raised tibial eminence for increased anterior and posterior constraint, prevention of posterior subluxation and varus/valgus stability. Ultracongruent (UC) insert has raised prominent anterior lip to prevent femur paradoxical anterior sliding during knee flexion, increase contact area for enhancing wear resistance and eliminate the need to cut out a bone box such as PS knee. Tibial inserts for the mobile type tibial baseplate include MB and MBC types. They are available in a range of thicknesses and freely rotated with metallic tibial baseplate. CR, UC and MBC insert types were designed to collocate with CR femoral component, while PS and MB insert types were designed to collocate with PS femoral component. CR knee design (CR femoral component collocate with CR insert) used for posterior cruciate ligament was excised, while PS knee design (PS femoral component collocate with PS, UC and MB inserts) used for both cruciate ligaments were excised.

The patellar components are available in all plastic in-set and on-set designs with dome shape configurations.

**Note:** The mobile type tibial baseplate, tibial insert-MB and tibial insert-MBC are not for sale in the U.S.A.

## MATERIALS:

ASTM F-75 Co-Cr-Mo alloy	Femoral component, Sintered bead Tibial baseplate-mobile
ASTM F-136 Titanium 6Al-4V ELI alloy	Tibial baseplate
ISO 5834/2 UHMWPE	Tibial insert, Patella

## INDICATIONS

The U2 Total Knee system is indicated in knee arthroplasty for reduction or relief of pain and/or improved knee function in skeletally mature patients with severe knee pain and disability due to rheumatoid arthritis, osteoarthritis, primary and secondary traumatic arthritis, polyarthritis, collagen disorders, avascular necrosis of the femoral condyle or pseudogout, posttraumatic loss of joint configuration, particularly when there is patellofemoral erosion, dysfunction or prior patellectomy, moderate valgus, varus, or flexion deformities. This device may also be indicated in the salvage of previously failed surgical attempts if the knee can be satisfactorily balanced and stabilized at the time of surgery. This device system is intended for cemented use only in the U.S.A.

## CONTRAINDICATIONS

The U2 Total Knee System is contraindicated in patients with any active or suspected latent infection in or about the knee joint. Patients without sufficient bone stock to provide adequate support and/or fixation to the prosthesis. Patients without sufficient soft tissue integrity to provide adequate stability. Patients with either mental or neuromuscular disorders which would create an unacceptable risk of prosthesis instability or complications in postoperative care, and in patients whose weight, age or activity level might cause extreme loads on the prosthesis and early failure of the system.

## ADVERSE EFFECTS

Potential adverse effects include infection, loosening of the components, breakage or bending of the components, or change in position of the components. Dislocation can occur due to inappropriate patient activity, trauma or other biomechanical considerations. Loosening may result from inadequate initial fixation, latent infection, premature loading of the prosthesis, component malalignment, osteolysis or trauma. Breakage or bending may result due to inadequate support of the component by the underlying bone or poor component fixation. Wear of polyethylene components has occurred and literature reports have associated its occurrence with bone resorption, loosening and infection. Other potential adverse effects of total knee surgery include genitourinary disorders; gastrointestinal disorders; neurovascular damage, thromboembolic disease, myocardial infarction and other less common adverse effects. Adverse effects may necessitate reoperation, revision, arthrodesis of the involved joint, and/or amputation of the limb. Due to the many biological, mechanical and physicochemical factors which affect these devices, the components cannot be expected to indefinitely withstand the activity level and loads of normal healthy bone.

## WARNINGS AND PRECAUTIONS

Familiarity with and attention to appropriate surgical Technique for total knee arthroplasty and the U2 Total Knee System is essential for success of the total knee procedure. Only surgeons who have reviewed the literature regarding total knee surgery and have had training in the technique should utilize the device. Patients should be instructed the limitations of the prosthesis, including, but not limited to, the impact of excessive loading through patient weight or activity, and be taught to govern their activities accordingly. If the patient is involved in an occupation or activity which includes substantial walking, running, lifting, or muscle strain, the resultant forces can cause failure of the fixation, the device, or both. The prosthesis will not restore function to the level expected with normal healthy bone, and the patient should not have unrealistic functional expectations. Accordingly, strict adherence to the indications, contraindications, precaution and warnings for this product is essential to potentially maximize service life. Appropriate selection, placement and fixation of the total knee components are critical factors that affect implant service life. As in the case of all prosthetic implants, the durability of these components is affected by numerous biologic biomechanical and other extrinsic factors, which limit their service life.

The surgeon must not allow damage to polished bearing surfaces because this may accelerate wear of the components. Discard all damaged or mishandled implants. Never reuse an implant. Reuse of this product will cause the risk of cross infection and unpredictable health threat. Keep bearing areas clean and free of debris prior to assembly. Components of the U2 Total Knee System should not be used with those of another manufacturer's total knee component since articular and dimensional compatibility cannot be assured. Intentional removal of the plastic tibial insert after its assembly into the tibial tray results in the destruction of the plastic insert. Care should be taken not to nick or notch the surface of the tibial tray during insert removal. Return all packages with flaws in the sterile barrier to the supplier. Do not resterilize.

## UTILIZATION AND IMPLANTATION

Selection of the U2 Total Knee System depends on the requirement of the patient. The surgeon should become thoroughly familiar with the technique of implantation of the prostheses by: (1) appropriate reading of the literature and (2) training in the operative skills and techniques required for total knee arthroplasty surgery. The trial components should be used for size determination, trial reduction and range of motion evaluation. Radiographic templates are available to assist in the preoperative prediction component size and style. The UHMWPE plugs may be removed from the screw holes, and bone screw may be used for additional fixation. The U2 Surgical Protocols provide procedural information.

## PACKAGING, LABELING AND STERILIZATION

All U2 Total Knee implants are supplied sterile and have been packaged in protective trays. The method of sterilization is noted on the package label. Inspect packages for punctures or other damage prior to surgery. Metal components are radiation sterilized. Plastic components are radiation sterilized or ethylene oxide sterilized. Care should be taken to prevent contamination of the component. In the event of contamination, this product must be discarded. The packaging of all sterile products should be inspected for flaws in the sterile barrier before opening. In the presence of such a flaw, the product must be assumed nonsterile. Special trial prostheses are available to avoid having to open any aspect of the sterile package prior to component use.

## IMPORTANT FOR OPENED COMPONENTS

If the package is opened, but the product is not used, the component must be returned to the United Orthopedic Corporation. If necessary, a suitable sterilization and/or special cleaning procedures will be done.

## SAFETY INFORMATION IN THE MAGNETIC RESONANCE (MR) ENVIRONMENT

The U2 Total Knee System has not been evaluated for safety and compatibility in the MR environment. The U2 Total Knee System has not been tested for heating or migration in the MR environment.







*Each Step* **We Care**

**UOC USA Inc.**

20 Fairbanks, Suite 173  
Irvine, CA 92618  
Tel: (949) 328-3366  
Fax: (949) 328-3367

For our valued distribution partners, you can reach our customer service associates at [customerservice@uocusa.com](mailto:customerservice@uocusa.com)

For assistance on general and/or product related inquiries, please email us at [sales@uocusa.com](mailto:sales@uocusa.com)

Please refer to the product-specific package inserts for important information, including indications, contraindications, warnings, precautions, and potential adverse effects.



[www.uocusa.com](http://www.uocusa.com)

Copyright © 2017 United Orthopedic Corp. All rights reserved.

UOC-UM-US-00020 Rev.0 SEP. 2017