

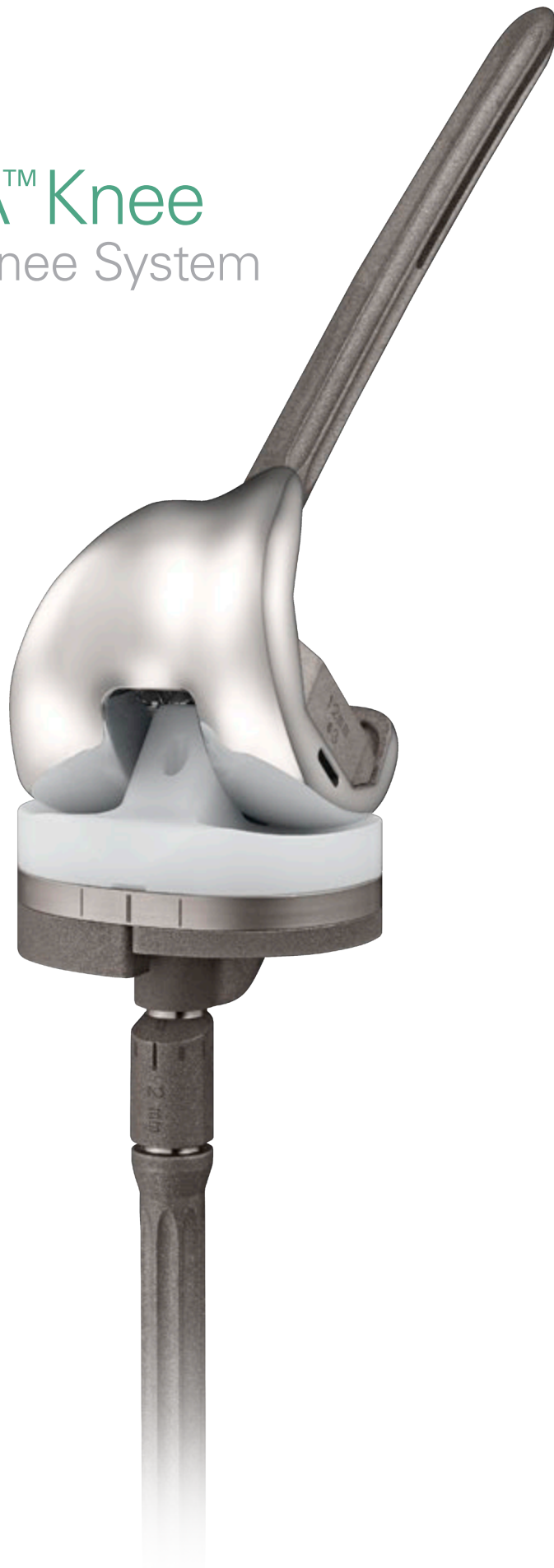

UNITED
ORTHOPEDIC®

U2 PSA™ Knee

Revision Knee System



U2 PSA Knee –

The U2 PSA (Posterior Stabilized Augmentable) Revision Knee System adopts basic design concepts of the Primary U2 Knee System and offers full size interchangeability across its component ranges. For severe bone deficiencies and complex cases, U2 PSA knee offers options for greater constraining design features and a combination of various augment thickness options and extension stem length options.

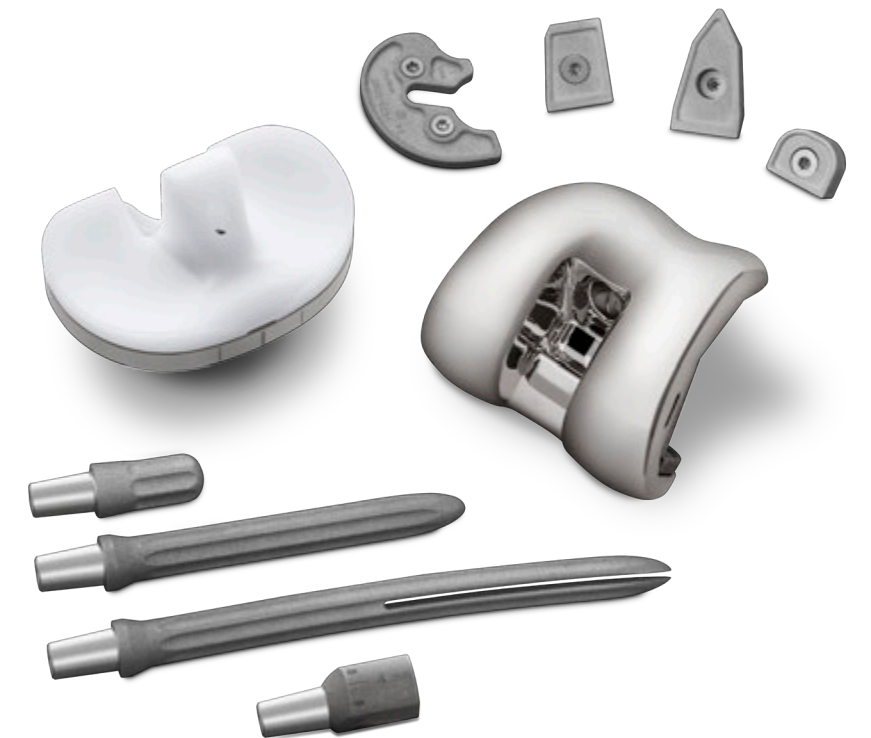

U2 PSA Knee System Overview

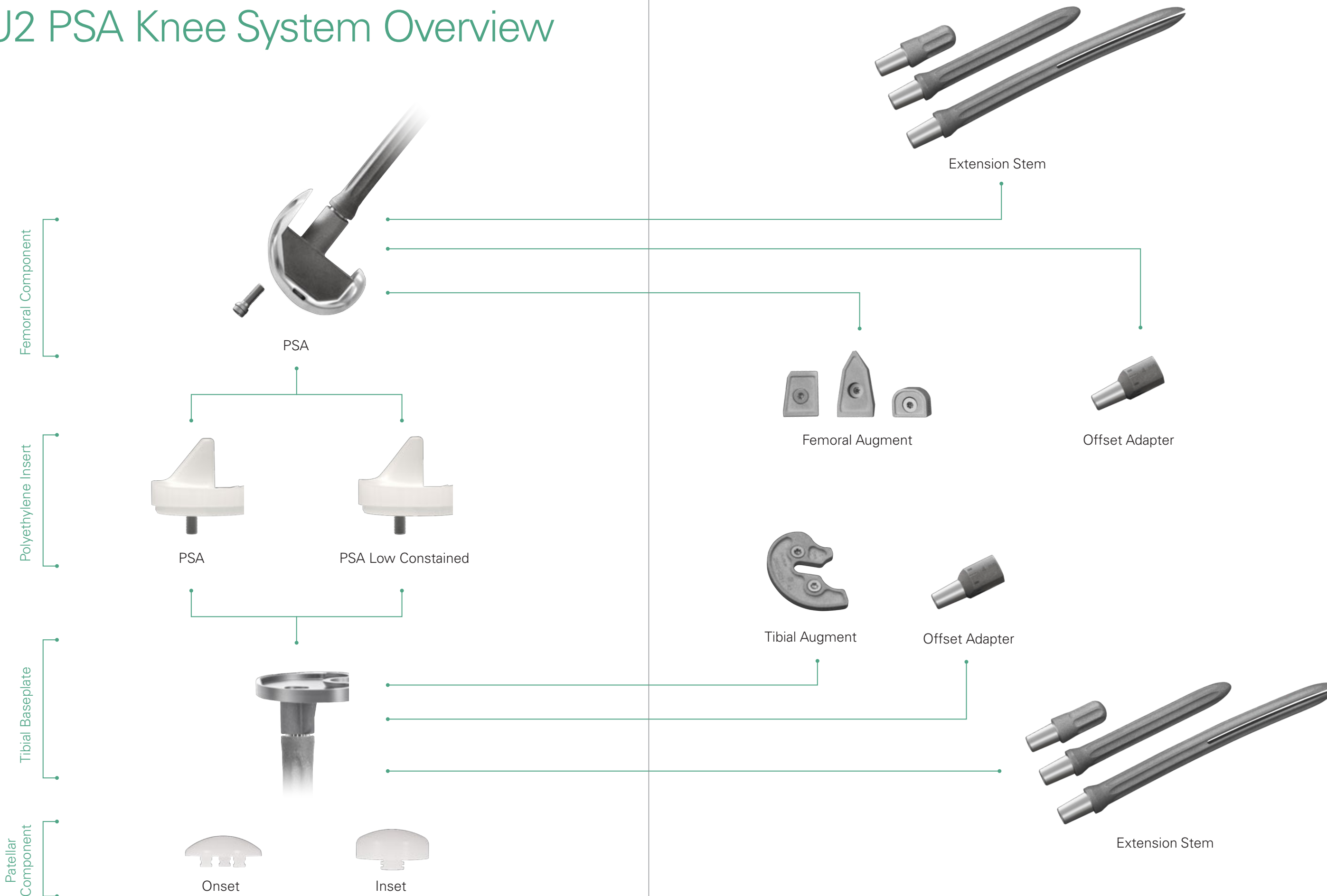

The U2 PSA Knee femoral component design is conceptually based on the U2 Knee System primary femoral component but with more emphasis placed on the constrained design concept to help provide even greater implant stability.

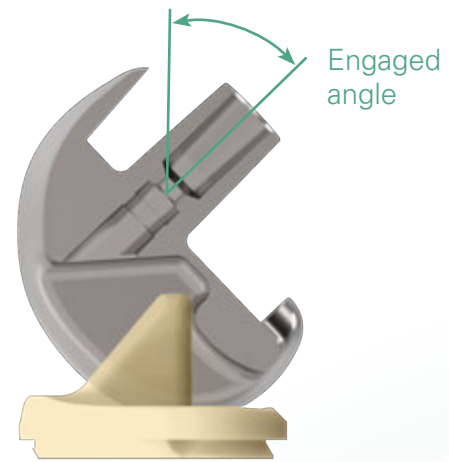

Early post and cam engagement (40° flexion) for improved joint stability

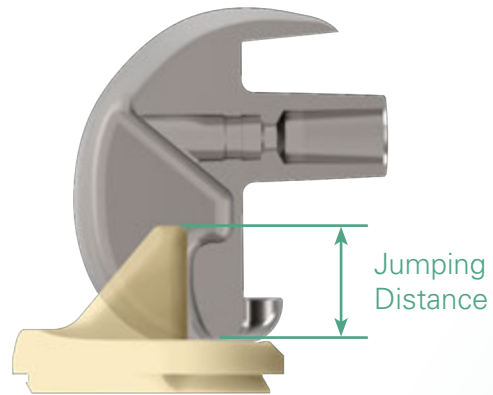

Jump height distance is 21.4 mm to reduce potential for dislocation

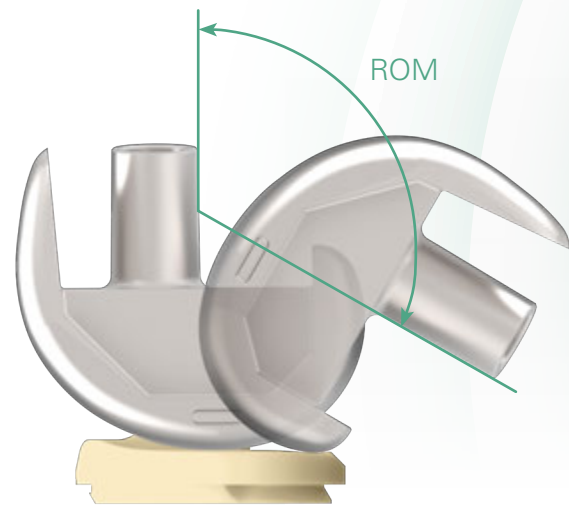

Range of Motion from 0° to 134°

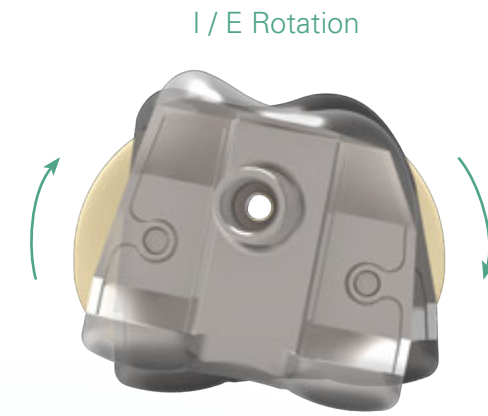

Allow up to ± 3.7° of internal/ external rotation

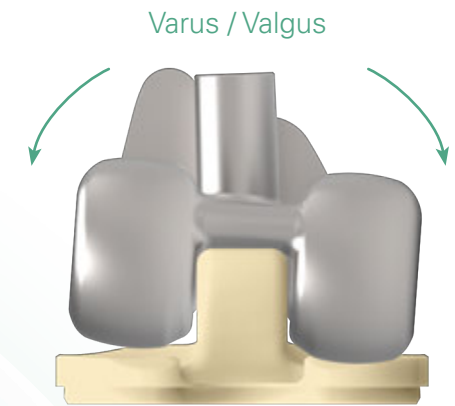

Varus/valgus lift-off is limited to ±1.4° for increased stability



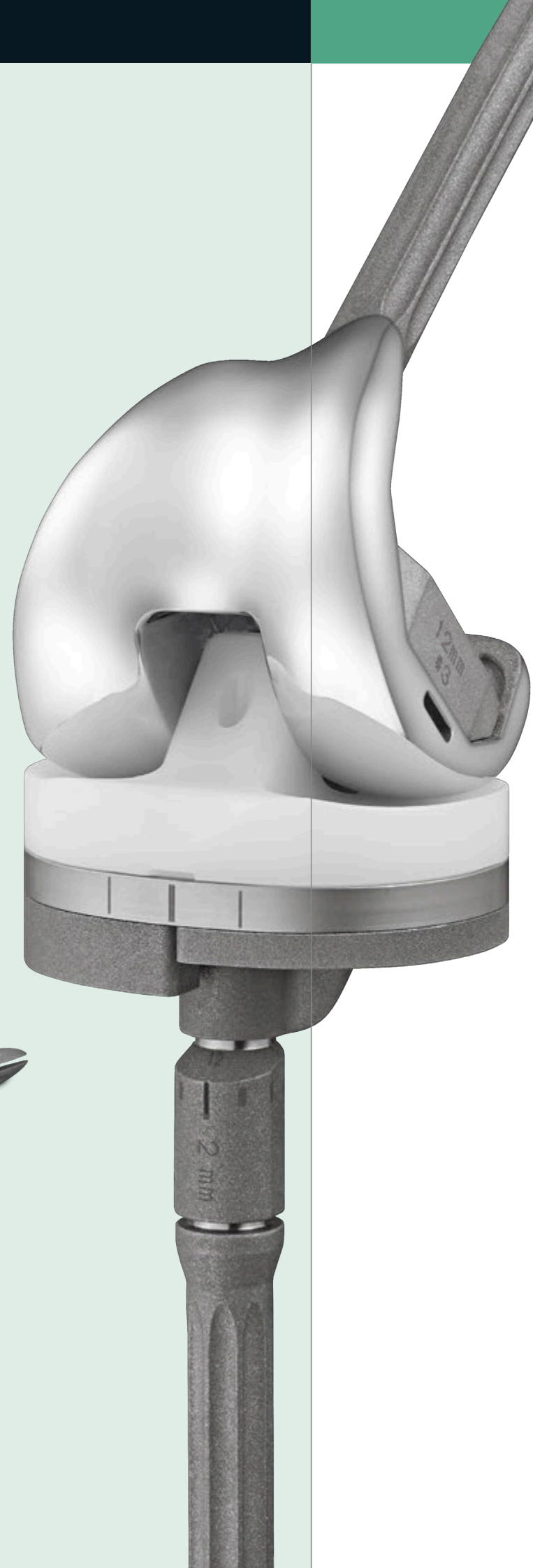

Multiple femoral and tibial offsets and extension stem options are available to achieve optimal component positioning and joint stability

- Offset adapter : 2, 4, 6 mm offset
- Straight stem length: 30, 75, 100, 150, 200 mm
- Curved stem length: 150, 200 mm

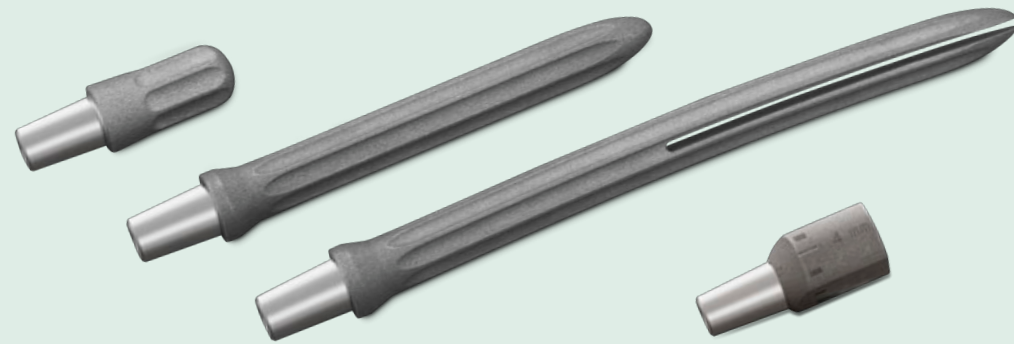

Extension Stem

Offset Adapter



Femoral Augment

A full range of femoral augment options for bone defects are available

- Distal & posterior augments: 4, 8 mm thickness
- Distal augment only : 12, 16 mm thickness



Tibial Augment

A full range of tibial augment options for bone defects are available

- Augment thickness: 5, 10, 15*mm
- * Tapered design augment

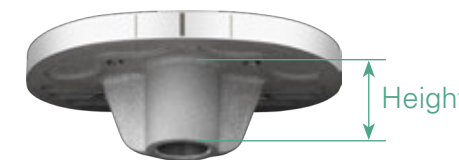

Tibial Baseplate

- Reduced height of tibial stem housing to 18 mm to apply the offset without cortex impingement

Different tibial insert material options are available

- UHMWPE (Ultra-High Molecular Weight Polyethylene)
- XPE (Highly Crosslinked Polyethylene)
- E-XPE (Vitamin E Highly Crosslinked Polyethylene)



U2 PSA Insert



U2 PSA Insert



U2 PSA LC Insert

Low Constrained (LC) Insert

- For intact ligament function and minor bone defects
- XPE (Highly Crosslinked Polyethylene)

Reinforced Femoral Locking Screw

The **C-Ring** design on the femoral locking screw is intended to prevent loosening/backing out

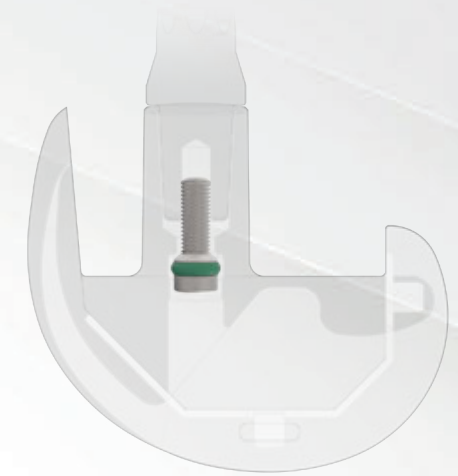

C Ring

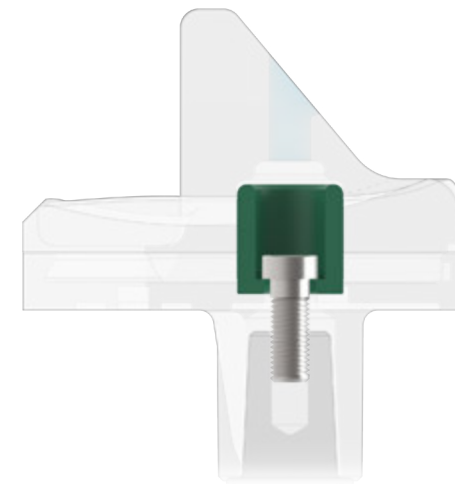

Reinforcement Bushing
Patent No. US 9044327

Proprietary Tibial Locking Screw

A **Built-in reinforcement metal bushing and locking screw** within the tibial insert extends into the baseplate. It is designed to provide additional structural support and to against shearing force from the femur.

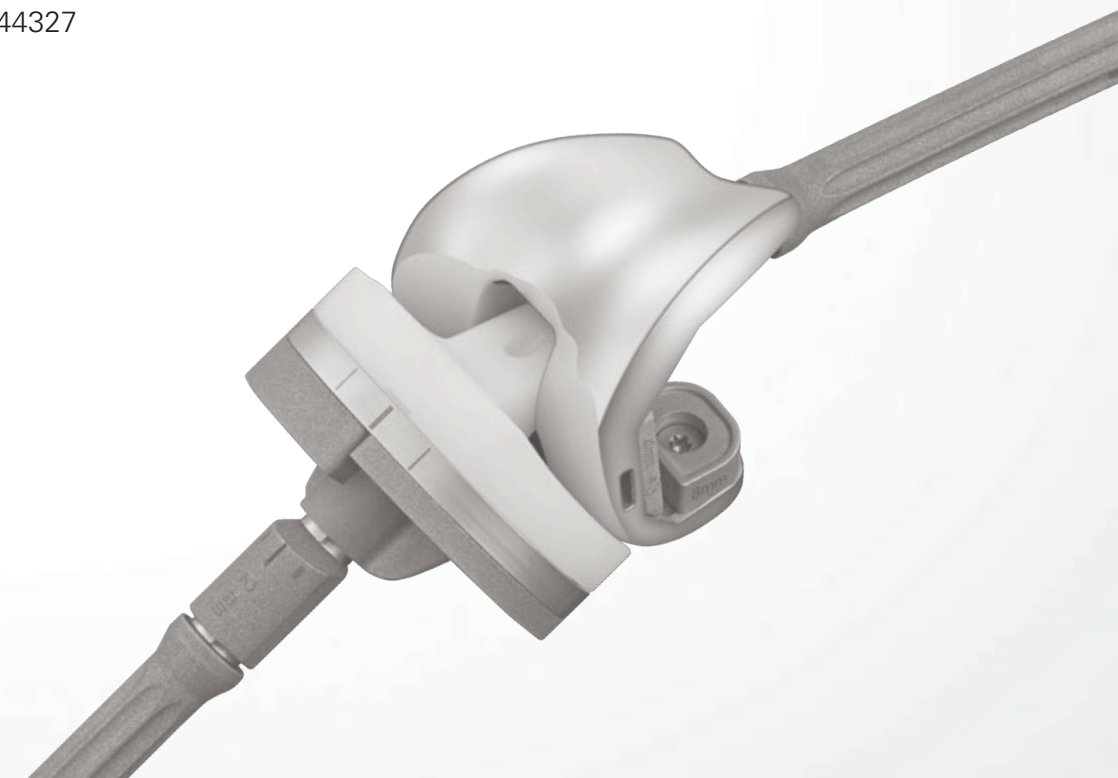

Order Information

Femoral Component

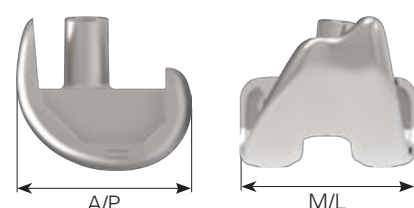

	Left	Right
#1	2103-5110	2103-5210
#2	2103-5120	2103-5220
#3	2103-5130	2103-5230
#4	2103-5140	2103-5240
#5	2103-5150	2103-5250
#6	2103-5160	2103-5260

	A/P	M/L
#1	52	56
#2	56	60
#3	60	64
#4	64	68
#5	68	72
#6	72	76

Unit:mm

Tibial Baseplate

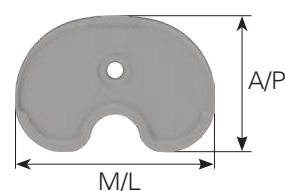

#1	2203-5210
#2	2203-5220
#3	2203-5230
#4	2203-5240
#5	2203-5250
#6	2203-5260

	A/P	M/L
#1	42	63
#2	44.5	66
#3	47	69
#4	49.5	72
#5	52.5	76
#6	55.5	80

Unit:mm

Order Information

Tibial Insert

Special Order Items



	UHMWPE							
	9 mm	11 mm	13 mm	15 mm	18 mm	21 mm	25 mm	30 mm
#1	2303-5011	2303-5012	2303-5013	2303-5014	2303-5015	2303-5016	2303-5017	2303-5018
#2	2303-5021	2303-5022	2303-5023	2303-5024	2303-5025	2303-5026	2303-5027	2303-5028
#3	2303-5031	2303-5032	2303-5033	2303-5034	2303-5035	2303-5036	2303-5037	2303-5038
#4	2303-5041	2303-5042	2303-5043	2303-5044	2303-5045	2303-5046	2303-5047	2303-5048
#5	2303-5051	2303-5052	2303-5053	2303-5054	2303-5055	2303-5056	2303-5057	2303-5058
#6	2303-5061	2303-5062	2303-5063	2303-5064	2303-5065	2303-5066	2303-5067	2303-5068

	XPE							
	9 mm	11 mm	13 mm	15 mm	18 mm	21 mm	25 mm	30 mm
#1	2303-5611	2303-5612	2303-5613	2303-5614	2303-5615	2303-5616	2303-5617	2303-5618
#2	2303-5621	2303-5622	2303-5623	2303-5624	2303-5625	2303-5626	2303-5627	2303-5628
#3	2303-5631	2303-5632	2303-5633	2303-5634	2303-5635	2303-5636	2303-5637	2303-5638
#4	2303-5641	2303-5642	2303-5643	2303-5644	2303-5645	2303-5646	2303-5647	2303-5648
#5	2303-5651	2303-5652	2303-5653	2303-5654	2303-5655	2303-5656	2303-5657	2303-5658
#6	2303-5661	2303-5662	2303-5663	2303-5664	2303-5665	2303-5666	2303-5667	2303-5668



	E-XPE							
	9 mm	11 mm	13 mm	15 mm	18 mm	21 mm	25 mm	30 mm
#1	2303-5811	2303-5812	2303-5813	2303-5814	2303-5815	2303-5816	2303-5817	2303-5818
#2	2303-5821	2303-5822	2303-5823	2303-5824	2303-5825	2303-5826	2303-5827	2303-5828
#3	2303-5831	2303-5832	2303-5833	2303-5834	2303-5835	2303-5836	2303-5837	2303-5838
#4	2303-5841	2303-5842	2303-5843	2303-5844	2303-5845	2303-5846	2303-5847	2303-5848
#5	2303-5851	2303-5852	2303-5853	2303-5854	2303-5855	2303-5856	2303-5857	2303-5858
#6	2303-5861	2303-5862	2303-5863	2303-5864	2303-5865	2303-5866	2303-5867	2303-5868



Low Constrained Type

	XPE, LC TYPE							
	9 mm	11 mm	13 mm	15 mm	18 mm	21 mm	25 mm	30 mm
#1	2303-5211	2303-5212	2303-5213	2303-5214	2303-5215	2303-5216	2303-5217	2303-5218
#2	2303-5221	2303-5222	2303-5223	2303-5224	2303-5225	2303-5226	2303-5227	2303-5228
#3	2303-5231	2303-5232	2303-5233	2303-5234	2303-5235	2303-5236	2303-5237	2303-5238
#4	2303-5241	2303-5242	2303-5243	2303-5244	2303-5245	2303-5246	2303-5247	2303-5248
#5	2303-5251	2303-5252	2303-5253	2303-5254	2303-5255	2303-5256	2303-5257	2303-5258
#6	2303-5261	2303-5262	2303-5263	2303-5264	2303-5265	2303-5266	2303-5267	2303-5268

Order Information

 Special Order Items

Extension Accessories

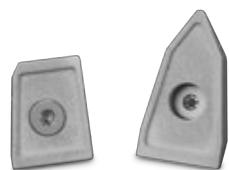

	Distal Femoral Augment					
	4 mm LM / RL	4 mm LL / RM	8 mm LM / RL	8 mm LL / RM	12 mm	16 mm
#1	2603-5111	2603-5211	2603-5112	2603-5212	2603-5313	2603-5314
#2	2603-5121	2603-5221	2603-5122	2603-5222	2603-5323	2603-5324
#3	2603-5131	2603-5231	2603-5132	2603-5232	2603-5333	2603-5334
#4	2603-5141	2603-5241	2603-5142	2603-5242	2603-5343	2603-5344
#5	2603-5151	2603-5251	2603-5152	2603-5252	2603-5353	2603-5354
#6	2603-5161	2603-5261	2603-5162	2603-5262	2603-5363	2603-5364



	Posterior Femoral Augment	
	4 mm	8 mm
#1	2603-5011	2603-5012
#2	2603-5021	2603-5022
#3	2603-5031	2603-5032
#4	2603-5041	2603-5042
#5	2603-5051	2603-5052
#6	2603-5061	2603-5062

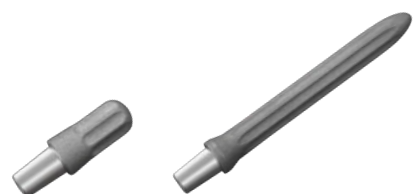

	Straight Stem				
	30 mm	75 mm	100 mm	150 mm	200 mm
Ø10	NA	2703-5011	2703-5021	2703-5051	2703-5061
Ø12	NA	2703-5012	2703-5022	2703-5052	2703-5062
Ø14	2703-5003	2703-5013	2703-5023	2703-5053	2703-5063
Ø16	NA	2703-5014	2703-5024	2703-5054	2703-5064
Ø18	NA	2703-5015	2703-5025	2703-5055	2703-5065
Ø20	NA	2703-5016	2703-5026	2703-5056	2703-5066
Ø22	NA	2703-5017	2703-5027	2703-5057	2703-5067
Ø24	NA	2703-5018	2703-5028	2703-5058	2703-5068



	Curved Stem	
	150 mm	200 mm
Ø10	2703-5031	2703-5041
Ø12	2703-5032	2703-5042
Ø14	2703-5033	2703-5043
Ø16	2703-5034	2703-5044
Ø18	2703-5035	2703-5045
Ø20	2703-5036	2703-5046
Ø22	2703-5037	2703-5047
Ø24	2703-5038	2703-5048

Order Information

Extension Accessories



	Tibial Augment			
	5 mm	10 mm	15 mm LM / RL	15 mm LL / RM
#1	2803-5211	2803-5212	2803-5113	2803-5213
#2	2803-5221	2803-5222	2803-5123	2803-5223
#3	2803-5231	2803-5232	2803-5133	2803-5233
#4	2803-5241	2803-5242	2803-5143	2803-5243
#5	2803-5251	2803-5252	2803-5153	2803-5253
#6	2803-5261	2803-5262	2803-5163	2803-5263



	Offset Adapter		
	2 mm	4 mm	6 mm
	2903-1010	2903-1020	2903-1030



Femoral Screw	
M5 x 14 mm	2903-1014

Please note that all United Orthopedic Corporation product brochures have been authored in the English language. Any translations into other languages have not been reviewed or approved by United Orthopedic Corporation and their accuracy cannot be confirmed. Any questions regarding United Orthopedic Corporation products should be directed to United Orthopedic Corporation at unitedorthopedic.com/contact.

The CE mark is valid only if it is also printed on the product label.

