

acreditat pentru  
CERTIFICARE



SR EN ISO/CEI 17021-1:2015  
CERTIFICAT DE ACREDITARE  
SM004



# C E R T I F I C A T

*SRAC certifică organizația/ certifies the organisation*

## **STERK PLAST SRL**

*Sediul social: Str. Constanței, nr. 2, C18, Medgidia, jud. Constanța*

*Sediul de lucru: Str. Triumfului, nr. 7, corp C1 și C2, Medgidia, jud. Constanța*

**pentru următoarele activități/  
for the following fields of activities**

*Producție de mase plastice: articole de uz casnic, alimentare și nealimentare; fabricarea altor produse din material plastic pentru domeniul construcțiilor și industrial*

*Production of plastics: household, food and non-food items; manufacture of other plastic products for construction and industrial field*

că are implementat și menține un  
**sistem de managementul calității**  
conform condițiilor din standardul

which has implemented and maintains a  
**quality management system**  
which fulfils the requirements of the standard

## **SR EN ISO 9001:2015 (ISO 9001:2015)**



Valabilitatea certificatului este condiționată de  
efectuarea supravegherilor anuale până la data de:



nr. certificat/ certificate registration no. **6632**  
data inițială a certificării/ initial certification date **26 septembrie 2008**  
data recertificării/ recertification date **19 septembrie 2023**  
data ultimei actualizări/ last update -  
valabil până la/ valid until **25 septembrie 2026** (cu condiția vizării anuale)  
SRAC CERT SRL, Str. Vasile Pârvan Nr. 14, Sector 1, București [www.srac.ro](http://www.srac.ro)

Director General  
**Ing. Mihaela Cristea**



# Certificate

SRAC has issued an IQNET recognized certificate that the organization:

## **STERK PLAST SRL**

**Registered Office: Str. Constanței, nr. 2, C18, Medgidia, jud. Constanța**

**Productive Unit: Str. Triumfului, nr. 7, corp C1 și C2, Medgidia, jud. Constanța**

has implemented and maintains a  
**Quality Management System**

for the following scope:

**Production of plastics: household, food and non-food items; manufacture of other plastic products for construction and industrial field**

which fulfils the requirements of the following standard:

## **ISO 9001 : 2015**

Issued on: **2023 - 09 - 19**  
First issued on: **2008 - 09 - 26**  
Expires on: **2026 - 09 - 25**

**Registration Number: RO - 6632**



**Alex Stoichitoiu**  
President of IQNET



**eng. Mihaela Cristea**  
SRAC General Manager



This attestation is directly linked to the IQNET Member's original certificate and shall not be used as a stand-alone document.

**IQNET Members\*:**

**AENOR** Spain **AFNOR Certification** France **APCER** Portugal **CCC** Cyprus **CISQ** Italy **CQC** China **CQM** China **CQS** Czech Republic  
**Cro Cert** Croatia **DQS Holding GmbH** Germany **EAGLE Certification Group** USA **FCAV** Brazil **FONDONORMA** Venezuela **ICONTEC**  
Colombia **ICS** Bosnia and Herzegovina **INTECO** Costa Rica **IRAM** Argentina **JQA** Japan **KFQ** Korea **LSQA** Uruguay **MIRTEC** Greece  
**MSZT** Hungary **Nemko AS** Norway **NSAI** Ireland **NYCE** México **PCBC** Poland **Quality Austria** Austria **SII** Israel **SIQ** Slovenia **SIRIM**  
**QAS** International Malaysia **SQS** Switzerland **SRAC** Romania **TSE** Türkiye **YUQS** Serbia

\*The list of IQNET Members is valid at the time of issue of this certificate. Updated information is available under [www.iqnet-certification.com](http://www.iqnet-certification.com)

acreditat pentru  
CERTIFICARE



SR EN ISO/CEI 17021-1:2015  
CERTIFICAT DE ACREDITARE  
SM 004



# C E R T I F I C A T

**SRAC certifică organizația/ certifies the organisation**

## **STERK PLAST SRL**

*Sediul social: Str. Constanței, nr. 2, C18, Medgidia, jud. Constanța*

*Sediul de lucru: Str. Triumfului, nr. 7, corp C1 și C2, Medgidia, jud. Constanța*

**pentru următoarele activități/  
for the following fields of activities**

*Producție de mase plastice: articole de uz casnic, alimentare și nealimentare; fabricarea altor produse din material plastic pentru domeniul construcțiilor și industrial*

*Production of plastics: household, food and non-food items; manufacture of other plastic products for construction and industrial field*

că are implementat și menține un  
**sistem de management de mediu**  
conform condițiilor din standardul

which has implemented and maintains an  
**environmental management system**  
which fulfils the requirements of the standard

## **SR EN ISO 14001:2015 (ISO 14001:2015)**



Valabilitatea certificatului este condiționată de  
efectuarea supravegheților anuale până la data de:



nr. certificat/ certificate registration no. **2056**  
data inițială a certificării/ initial certification date **26 septembrie 2008**  
data recertificării/ recertification date **19 septembrie 2023**  
data ultimei actualizări/ last update -  
valabil până la/ valid until **25 septembrie 2026** (cu condiția vizării anuale)  
SRAC CERT SRL, Str. Vasile Pârvan Nr. 14, Sector 1, București [www.srac.ro](http://www.srac.ro)

Director General  
**Ing. Mihaela Cristea**



# Certificate

SRAC has issued an IQNET recognized certificate that the organization:

## **STERK PLAST SRL**

**Registered Office: Str. Constanței, nr. 2, C18, Medgidia, jud. Constanța**

**Productive Unit: Str. Triumfului, nr. 7, corp C1 și C2, Medgidia, jud. Constanța**

has implemented and maintains an  
**Environmental Management System**

for the following scope:

**Production of plastics: household, food and non-food items; manufacture of other plastic products for construction and industrial field**

which fulfils the requirements of the following standard:

**ISO 14001 : 2015**

Issued on: **2023 - 09 - 19**  
First issued on: **2008 - 09 - 26**  
Expires on: **2026 - 09 - 25**

**Registration Number: RO - 2056**



**Alex Stoichitoiu**  
President of IQNET



**eng. Mihaela Cristea**  
SRAC General Manager



This attestation is directly linked to the IQNET Member's original certificate and shall not be used as a stand-alone document.

**IQNET Members\*:**

**AENOR** Spain **AFNOR Certification** France **APCER** Portugal **CCC** Cyprus **CISQ** Italy **CQC** China **COM** China **CQS** Czech Republic  
**Cro Cert** Croatia **DQS Holding GmbH** Germany **EAGLE Certification Group** USA **FCAV** Brazil **FONDONORMA** Venezuela **ICONTEC**  
Colombia **ICS** Bosnia and Herzegovina **INTECO** Costa Rica **IRAM** Argentina **JQA** Japan **KFQ** Korea **LSQA** Uruguay **MIRTEC** Greece  
**MSZT** Hungary **Nemko AS** Norway **NSAI** Ireland **NYCE** México **PCBC** Poland **Quality Austria** Austria **SII** Israel **SIQ** Slovenia **SIRIM**  
**QAS** International Malaysia **SQS** Switzerland **SRAC** Romania **TSE** Türkiye **YUQS** Serbia

\*The list of IQNET Members is valid at the time of issue of this certificate. Updated information is available under [www.iqnet-certification.com](http://www.iqnet-certification.com)

acreditat pentru  
CERTIFICARE



SR EN ISO/CEI 17021-1:2015  
CERTIFICAT DE ACREDITARE  
SM 004



# C E R T I F I C A T

**SRAC certifică organizația/ certifies the organisation**

## **STERK PLAST SRL**

*Sediul social: Str. Constanței, nr. 2, C18, Medgidia, jud. Constanța*

*Sediul de lucru: Str. Triumfului, nr. 7, corp C1 și C2, Medgidia, jud. Constanța*

**pentru următoarele activități/  
for the following fields of activities**

*Producție de mase plastice: articole de uz casnic, alimentare și nealimentare; fabricarea altor produse din material plastic pentru domeniul construcțiilor și industrial*

*Production of plastics: household, food and non-food items; manufacture of other plastic products for construction and industrial field*

că are implementat și menține un  
**sistem de management al sănătății  
și securității ocupaționale**  
conform condițiilor din referențialul

which has implemented and maintains an  
**occupational health and safety  
management system**  
which fulfils the requirements of the reference standard

## **SR ISO 45001:2018 (ISO 45001:2018)**



Valabilitatea certificatului este condiționată de  
efectuarea supravegheților anuale până la data de:



nr. certificat/ certificate registration no. **1111**  
data inițială a certificării/ initial certification date **26 septembrie 2008**  
data recertificării/ recertification date **19 septembrie 2023**  
data ultimei actualizări/ last update -  
valabil până la/ valid until **25 septembrie 2026** (cu condiția vizării anuale)  
SRAC CERT SRL, Str. Vasile Pârvan Nr. 14, Sector 1, București [www.srac.ro](http://www.srac.ro)

Director General  
**Ing. Mihaela Cristea**



# Certificate

SRAC has issued an IQNET recognized certificate that the organization:

## **STERK PLAST SRL**

**Registered Office: Str. Constanței, nr. 2, C18, Medgidia, jud. Constanța**

**Productive Unit: Str. Triumfului, nr. 7, corp C1 și C2, Medgidia, jud. Constanța**

has implemented and maintains an  
**Occupational Management System**

for the following scope:

**Production of plastics: household, food and non-food items; manufacture of other plastic products for construction and industrial field**

which fulfils the requirements of the following standard:

## **ISO 45001 : 2018**

Issued on: **2023 - 09 - 19**  
First issued on: **2008 - 09 - 26**  
Expires on: **2026 - 09 - 25**

**Registration Number: RO - 1111**



**Alex Stoichitoiu**  
President of IQNET



**eng. Mihaela Cristea**  
SRAC General Manager



This attestation is directly linked to the IQNET Member's original certificate and shall not be used as a stand-alone document.

**IQNET Members\*:**

**AENOR** Spain **AFNOR Certification** France **APCER** Portugal **CCC** Cyprus **CISQ** Italy **CQC** China **CCM** China **CQS** Czech Republic  
**Cro Cert** Croatia **DQS Holding GmbH** Germany **EAGLE Certification Group** USA **FCAV** Brazil **FONDONORMA** Venezuela **ICONTEC**  
Colombia **ICS** Bosnia and Herzegovina **INTECO** Costa Rica **IRAM** Argentina **JQA** Japan **KFQ** Korea **LSQA** Uruguay **MIRTEC** Greece  
**MSZT** Hungary **Nemko AS** Norway **NSAI** Ireland **NYCE** México **PCBC** Poland **Quality Austria** Austria **SII** Israel **SIQ** Slovenia **SIRIM**  
**QAS** International Malaysia **SQS** Switzerland **SRAC** Romania **TSE** Türkiye **YUQS** Serbia

\*The list of IQNET Members is valid at the time of issue of this certificate. Updated information is available under [www.iqnet-certification.com](http://www.iqnet-certification.com)



### Photo of the product



### 1.Measuring equipment:

Measuring equipment	Manufacturer	Type	Inventory / Serial No.	Next calibration
Sound level meter	SVANTEK	SVAN 971, 7052E	2788755	2023.08.31
Sound Level Calibrator	B&K	4230	2788715	2023.08.09
Measuring-tape	EXTOL	Compact 3m/16mm EC_Class II	9020796	2024.02.17

### 2. TECHNICAL DATA

Description	: MOBILE WASTE CONTAINER
Type	: Waste bin "120 liter"
Volume	: 120 liter
Dimensions	: 480x520x940mm
Mass	: ca. 8,4 kg
Year of manufacture	: 2022

### 3. INSTALLATION AND OPERATING CONDITIONS OF NOISE POWER MEASUREMENT

The measurements were carried out with new product as provided by the manufacturer.  
All the measurements shall be carried out with an empty container.

Operating conditions:

- With the presence of the operator;
- Reflecting surface of concrete;
- Outdoor without reflecting surface.

Place of the test: 1143 Budapest, Gizella út 51-57., Hungary, outdoor.

Date of the test: 18.11.2022.

Responsible for test: Balázs Ivánka

### 4. ACCUSTIC ENVIRONMENT

The indoor area meets the requirements of 4.2 and annex 4 of EN 3744 standard. / Reflecting surface of concrete/

Background noise correction  $K_1=0$  dB.

Environmental correction:  $K_2=0$  dB. / Outdoors measurements /

Measurement surface: hemisphere.

Radius of the hemisphere:  $r=3$  m.

The area of the measurement surface:  $S=56,52$  m<sup>2</sup>.

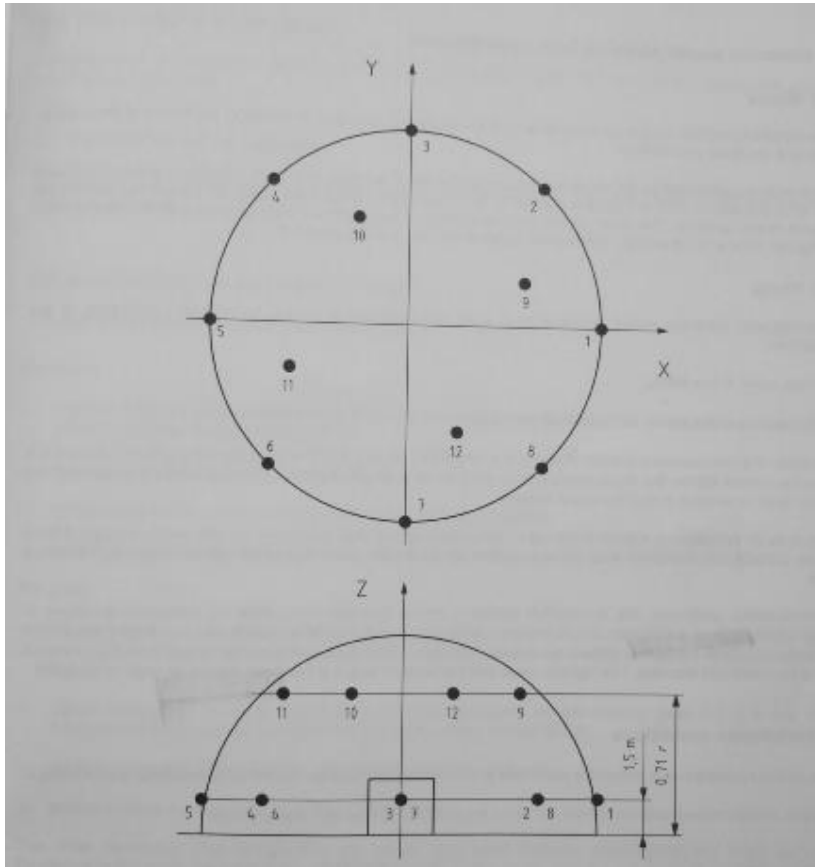

Sketch of the hemisphere measurement surface and the microphone positions

#### Coordinates of the 6 microphone positions

Number of microphone	$x/r$	$y/r$	$z$
1	1	0	1,5m
2	0,7	0,7	1,5m
3	0	1	1,5m
4	-0,7	0,7	1,5m
5	-1	0	1,5m
6	-0,7	-0,7	1,5m
7	0	-1	1,5m
8	0,7	-0,7	1,5m
9	0,65	0,27	0,71r
10	-0,27	0,65	0,71r
11	-0,65	-0,27	0,71r
12	0,27	-0,65	0,71r

The measurements were carried out only six microphone position: 2; 4; 6; 8; 10; 12.

**Environmental correction:**

Determination of the environmental correction based on the EN ISO 3744:2010.  
K<sub>2</sub> is the environmental correction.

Environmental correction: K<sub>2</sub>=0 dB. / Outdoors measurements /

**5. ATMOSPHERIC CONDITIONS**

Barometric pressure : 1010 hPa  
Air temperature : 10 °C  
Relative humidity : 40 %  
Wind velocity : 0-2 m/s

**6. BACKGROUND NOISE**

The level of the background noise was at least 15 dB below the sound pressure level at each measuring point. (The measured background noise average is less than 51 dB(A).)

Background noise correction: K<sub>1</sub>= 0 dB, according to the EN ISO 3744:2010.

/ ΔL>15 dB; There is no correction. /

Positions	2	4	6	8	10	12	L <sub>pA</sub>
LEQ	51	48.6	49.7	51.4	51.6	49.7	50.3

## 7. DETERMINATION OF SOUND POWER LEVEL – MEASUREMENT METHOD

The A-weighted sound power level was measured according to EN ISO 3744:2010. Six microphone positions were located on the surface of the measuring hemisphere. The radius of the hemisphere is 3 m. /See the sketch of the measurement surface and microphone positions./

Digital integration was used to measure the equivalent continuous A-weighted sound pressure level,  $L_{pAeq}$  in decibels for each measurement period  $T$ , and the response level was “S”.

The frequency weight: A

The calculations of Free shutting down of the lid along the container body and complete opening of the lid 2 x 20 measurements were used for the Free shutting down and Complete opening of the lid to obtain a set of measurement data at all six microphone positions for each of 20 cycles.

The calculations of rolling of the container over an artificial irregular track to obtain a set of measurement data at all six microphone positions for each of 6 cycles differing by less than 2 dB.

The sound levels measured at each microphone position is classified in increasing order and the sound power levels are calculated by associating the values at each microphone position according to their row. The measurement results were used to calculate  $L_p$  for cycles according to EN ISO 3744:2010 and the Directive 2000/14/EC. The results for each cycle were averaged over the measurement of 6 microphone positions.

The sound power levels  $L_{WAshutting}$  and  $L_{WAopening}$  are calculated from the quadratic mean of the five highest values among those obtained plus a surface area factor 17,52 dB, according to the EN ISO 3744:2010 and the Directive 2000/14/EC.

## 8. RESULTS OF SOUND POWER LEVEL TEST

Free shutting down of the lid along the container body

Measurement cycles																				
Microphone positions	1	2	3	4	5	6	7	8	9	10	11	12	13	14	15	16	17	18	19	20
2	68.1	68.5	68.6	68.6	68.7	68.9	69.1	69.2	69.5	69.6	69.6	69.9	70	70	70	70.1	70.2	70.3	70.4	70.5
4	67.1	67.6	67.8	67.9	68.1	68.4	68.7	68.7	68.8	68.8	68.8	68.9	69	69	69	69	69.2	69.2	69.3	69.7
6	66.8	67.1	67.2	67.9	68	68.6	68.8	69	69.3	69.3	69.3	69.4	69.8	69.8	69.8	69.9	70.4	70.7	70.9	71
8	67.6	68.9	69	69.1	69.2	69.3	69.4	69.5	69.7	69.7	69.8	69.9	70	70.1	70.1	70.2	70.5	70.6	70.7	71
10	69.4	69.6	69.8	70.4	70.4	70.5	70.6	70.8	71	71	71.1	71.2	71.2	71.2	71.3	71.4	71.4	71.8	71.8	71.9
12	71.7	72	72.2	72.2	72.3	72.5	72.6	72.6	72.7	72.8	72.8	72.8	72.8	72.9	72.9	73	73.1	73.4	73.7	73.9
$\bar{L}'_p = 10 \lg \left[ \frac{1}{N} \sum_{i=1}^N 10^{0.1L'_p} \right]$	68.8	69.3	69.4	69.6	69.7	70.0	70.1	70.2	70.4	70.4	70.5	70.6	70.7	70.7	70.7	70.8	71.0	71.2	71.4	71.6

**S=56.52 m<sup>2</sup>; S<sub>0</sub>=1m<sup>2</sup>,**

**L<sub>pa</sub>: 71.2 dB**

**L<sub>pf</sub>=L<sub>pa</sub>-K1-K2=71.2 dB;**

**L<sub>WAshutting</sub>=L<sub>pf</sub>+10 lg(S/S<sub>0</sub>) = 79.9 + 17.52 = 88.7 dB**

Complete opening of the lid

Measurement cycles																				
Microphone positions	1	2	3	4	5	6	7	8	9	10	11	12	13	14	15	16	17	18	19	20
2	69.4	69.4	69.4	69.6	69.7	69.8	70	70.2	70.5	70.6	70.7	70.8	70.8	71	71.1	71.1	71.2	71.3	71.9	72.1
4	69.5	69.7	69.8	70	70.2	70.3	70.3	70.3	70.4	70.4	70.5	70.5	70.5	70.5	70.7	70.9	70.9	71	71.1	71.4
6	68	68	68.2	68.5	68.7	69	69.1	69.1	69.2	69.6	69.8	69.9	70	70.1	70.1	70.3	70.3	70.4	70.4	70.6
8	69.1	69.4	69.5	69.6	69.7	69.8	69.9	70	70.2	70.2	70.2	70.6	70.8	70.9	70.9	71	71.1	71.1	72	72.1
10	71.6	72.1	72.2	72.4	72.7	72.9	73.1	73.1	73.1	73.3	73.4	73.6	73.6	73.7	73.8	73.8	73.9	73.9	74.1	74.1
12	70.2	70.6	70.7	71	71.2	71.3	71.3	71.3	71.3	71.3	71.4	71.4	71.5	71.6	71.7	71.7	72	72.2	72.3	72.3
$\bar{L}'_p = 10 \lg \left[ \frac{1}{N} \sum_{i=1}^N 10^{0.1L'_p} \right]$	69.8	70.1	70.2	70.4	70.6	70.7	70.8	70.9	71.0	71.1	71.2	71.3	71.4	71.5	71.6	71.6	71.7	71.8	72.1	72.2

**S=56.52 m<sup>2</sup>; S<sub>0</sub>=1m<sup>2</sup>,****L<sub>pb</sub> : 71.9 dB****L<sub>pr</sub>=L<sub>pb</sub>-K1-K2= 79.4-2=71.9 dB,****L<sub>WAopening</sub> =L<sub>pr</sub>+10 lg(S/S<sub>0</sub>) = 77.7 + 17.52 = 89.4 dB**

Rolling of the container over an artificial irregular track

Measurement cycles						
Microphone positions	1	2	3	4	5	6
2	76.4	77.5	76.6	76.9	77	75.7
4	76.7	78.3	77.4	77.2	76.9	76.8
6	78.3	77.6	76.7	77.8	78.2	76.7
8	78.6	76.9	77.7	77.2	78.1	77
10	77.5	75.8	77.1	77.5	76.9	77.8
12	78.1	76.2	77	78.2	77.8	77.8
$\bar{L}'_p = 10 \lg \left[ \frac{1}{N} \sum_{i=1}^N 10^{0.1 L'_p} \right]$	77.6	77.1	77.1	77.5	77.5	77.0

**S=56.52 m<sup>2</sup>; S<sub>0</sub>=1m<sup>2</sup>,**
**L<sub>pc</sub>: 77.3 dB**
**L<sub>pf</sub>=L<sub>pc</sub>-K1-K2=77.3 dB**
**L<sub>WArolling</sub> =L<sub>pr</sub>+10 lg(S/S<sub>0</sub>) = 80.1+ 17.52 = 94.8dB**
**L<sub>W</sub> = 10 log (1/3 (10<sup>0,1</sup> LW<sub>Ashutting</sub> + 10<sup>0,1</sup> LW<sub>Aopening</sub> + 10<sup>0,1</sup> LW<sub>Arolling</sub>)) = 91.9 dB(A)**

## 9. MEASUREMENT UNCERTAINTY

Note:

The declaration of the expanded measurement uncertainty was calculated by EN ISO 11201:2010

$$U = k \sigma_{\text{tot}}$$

$$\sigma_{\text{tot}} = \sqrt{\sigma_{\text{RO}}^2 + \sigma_{\text{omc}}^2}$$

**U:** expanded uncertainty

$\sigma_{\text{RO}}$  (standard deviation of reproducibility): 0.5 dB

$\sigma_{\text{omc}}$  (instability of the operating and mounting conditions): 0,7 dB

**k** (coverage factor): 2

**Measurement uncertainty (U): 1,72 dB**

## 10. CONCLUSIONS

**Type:**

**Waste bin “120 liter”**

The A-weighted sound power level:  **$L_w = 91.9 \text{ dB(A)}$** .

**$L_{wU} = 96.9 \text{ dB(A)} + 1.72 = 93.61 \text{ dB(A)}$**

**Guaranteed sound power level:  $L_{WA} = 94 \text{ dB(A)}$**

**End of test report**

# Zertifikat

# Certificate



<b>Zertifikat Nr. Certificate No.</b> S 60166262	<b>Blatt Sheet</b> 0002	<b>Gültig ab</b> 30.06.2025	<b>Valid from</b> (day/mo/yr)
<b>Ihr Zeichen Client Reference</b>	<b>Unser Zeichen Our Reference</b> 0001-N.S.-HU22E8TC 002	<b>Längstens gültig bis</b> 20.10.2027	<b>Latest expiration date</b> (day/mo/yr)

**Genehmigungsinhaber License Holder**  
Sterk Plast s.r.l.  
Constantei street 2  
905600 Medgidia  
Romania

**Fertigungsstätte Manufacturing Plant**  
Sterk Plast s.r.l.  
Constantei street 2  
905600 Medgidia  
Romania

## Prüfzeichen Test Mark



www.tuv.com  
ID 1111260319

## Geprüft nach Tested acc. to

EN 840-1:2020  
EN 840-5:2020  
EN 840-6:2020  
RAL-GZ 951/1/08.23  
AfPS GS 2019:01 PAK

## Zertifiziertes Produkt (Geräteidentifikation) Certified Product (Product Identification)

## Lizenzentgelte - Einheit License Fee - Unit

### Abfallsammler Mobile waste container

Produkt wie Blatt 0001 / Product as page 0001  
Ergänzung mit weiteren Typbezeichnungen  
/Addition of further type designations

Bezeichnung/Type designation:

120 L PREMIUM

1

Nennvolumen/Nominal volume: 120 l  
Gewicht/Weight: 8,5 kg  
Zul. Gesamtgewicht: 60 kg  
/Max. permissible mass  
Breite/Width [mm]: 480  
Tiefe/Depth [mm]: 470  
Höhe/Height [mm]: 950  
Material: HDPE Behälter /Container;  
D200mm HDPE Räder /wheels  
Stahlachse /steel axle

1

Dem Zertifikat liegt unsere Prüf- und Zertifizierungsordnung zugrunde.  
Die Anforderungen nach § 20 des Produktsicherheitsgesetzes  
sind erfüllt.

This certificate is based on our Testing and Certification Regulation.  
The provisions of §20 Product Safety Act are complied with.

Zertifizierungsstelle



**TÜV Rheinland LGA Products GmbH, Tillystraße 2, 90431 Nürnberg**

http://www.tuv.com/safety E-mail: markcheck@tuv.com  
Fax: +49 221 806-3935

Tibor Mózes

**Ausstellungsdatum Date of Issue : 30.06.2025 (day/mo/yr)**

# Zertifikat

# Certificate



<b>Zertifikat Nr. Certificate No.</b> S 60166262	<b>Blatt Sheet</b> 0001	<b>Gültig ab</b> 21.10.2022	<b>Valid from</b> (day/mo/yr)
<b>Ihr Zeichen Client Reference</b>	<b>Unser Zeichen Our Reference</b> 0001-N.S.-HU22E8TC 001	<b>Längstens gültig bis</b> 20.10.2027	<b>Latest expiration date</b> (day/mo/yr)

**Genehmigungsinhaber License Holder**  
Sterk Plast s.r.l.  
Constantei street 2  
905600 Medgidia  
Romania

**Fertigungsstätte Manufacturing Plant**  
Sterk Plast s.r.l.  
Constantei street 2  
905600 Medgidia  
Romania

## Prüfzeichen Test Mark



www.tuv.com  
ID 1111280319

## Geprüft nach Tested acc. to

EN 840-1:2020  
EN 840-5:2020  
EN 840-6:2020  
RAL-GZ 951/1/11.20  
AfPS GS 2019:01 PAK

## Zertifiziertes Produkt (Geräteidentifikation) Certified Product (Product Identification)

## Lizenzentgelte - Einheit License Fee - Unit

### Abfallsammler Mobile waste container

Fahrbare Abfall- und Wertstoffbehälter mit 2 Rädern  
/Mobile waste and recycling container with 2 wheels

#### Bezeichnung/Type designation:

5

Mülleimer / Waste bin "120 liter"  
Nennvolumen/Nominal volume: 120 l  
Gewicht/Weight: 8,4 kg  
Zul. Gesamtgewicht /max. load: 55 kg  
Breite/Width [mm]: 480  
Tiefe/Depth [mm]: 520  
Höhe/Height [mm]: 940  
Material: HDPE Behälter /Container;  
D200mm HDPE Räder /wheels  
Stahlachse /steel axle

5

Dem Zertifikat liegt unsere Prüf- und Zertifizierungsordnung zugrunde.  
Die Anforderungen nach § 20 des Produktsicherheitsgesetzes  
sind erfüllt.

*This certificate is based on our Testing and Certification Regulation.  
The provisions of §20 Product Safety Act are complied with.*

**TÜV Rheinland LGA Products GmbH, Tillystraße 2, 90431 Nürnberg**

http://www.tuv.com/safety E-mail: markcheck@tuv.com  
Fax: +49 221 806-3935

**Ausstellungsdatum Date of Issue : 21.10.2022 (day/mo/yr)**

**Zertifizierungsstelle**



**Tibor Mózes**

## CE Declaratie de conformitate

### Corespunzator cu norma europeana de zgomot 2000/14/EC

Noi, STERK PLAST S.R.L., declaram ca produsele noastre:

- Pubela 80 litri, 120 litri, 240 litri

-Containerele pentru gunoi 770 litri si 1100 litri

Sunt in concordanta cu urmatoarea directiva:

2000/14/EC Directiva privind emisia de zgomot în mediu de către echipamentele destinate utilizării în exterior

Prin prezenta declarăm că

Echipament: Pubela pentru gunoi Container pentru gunoi

Model Nr.	80 litri	770 litri
	120 litri	1100 litri
	240 litri	

sunt în conformitate cu cerințele aplicabile din următoarele documente:

Ref. Nr.	Titlu:	Data emiterii:
2000/14/EC	2000/14/EC Directiva privind emisia de zgomot în mediu de către echipamentele destinate utilizării în exterior	8 mai 2000
2005/88/EC	Directiva 2005/88/EC de modificare a Directivei 2000/14/EC	14 decembrie 2005
219/2009	Regulamentul (CE)	11 martie 2009

Măsurătorile de zgomot au fost efectuate în conformitate cu (codul de încercare) cu controlul intern al producției (schema 7/anexa V)

Valorile de zgomot masurate sunt urmatoarele :

Varianta produs	Nivelul de putere acustică
80 litri	98 dB
120 litri	94 dB
240 litri	92 dB
770 litri	92 dB
1100 litri	92 dB

Prin prezenta declaram că echipamentul menționat mai sus a fost proiectat pentru a respecta secțiunea relevantă din specificațiile menționate mai sus și este în conformitate cu cerințele directivei (directivelor).

**DATA:**  
3/04/2024

**STERK PLAST SRL**  
Semnatura si stampila:











<b>Vizsgálati jegyzőkönyv sz.:</b> <i>Test report no.:</i>	<b>HU26C91A 001</b>	<b>Rendelés sz.:</b> <i>Order no.:</i>	301572661 P02439785	Oldal 1 / 8 Page 1 / 8
<b>Megbízó-referencia-sz.:</b> <i>Client reference no.:</i>	2432001	<b>Rendelés dátum:</b> <i>Order date:</i>	2026-05-27	
<b>Megbízó:</b> <i>Client:</i>	Sterk Plast s.r.l. Constantei street 2., Medgidia, Romania, 905600			
<b>Vizsgálat tárgya:</b> <i>Test item:</i>	Mobil waste and recycling containers with 2 - and with 4 wheels and flat lid			
<b>Azonosítás / Típus-sz.:</b> <i>Identification / Type no.:</i>	120L Dust Bin Premium (type no.: P120PN), 240L Dust Bin Premium (type no.: P240N), 1100L Dust bin Premium (type no.: P1100N)			
<b>Rendelés-tartalma:</b> <i>Order content:</i>	Waste container noise measurement			
<b>Vizsgálati előírás:</b> <i>Test specification:</i>	2000/14/EC Annex VII *			
<b>Minta átvételi dátum:</b> <i>Date of sample receipt:</i>	2025-12-03; 2026-05-26			
<b>Minta azonosító sz.:</b> <i>Test sample no.:</i>	A004159647-001; A004295509-002-003			
<b>Vizsgálat ideje:</b> <i>Testing period:</i>	2026-06-05			
<b>Vizsgálat helyszíne:</b> <i>Place of testing:</i>	TÜV Rheinland InterCert Kft. 1143 Budapest, Gizella út 51-57, Hungary			
<b>Vizsgáló laboratórium:</b> <i>Testing laboratory:</i>	TÜV Rheinland InterCert Kft. Termékek üzletág Termékvizsgáló laboratórium			
<b>Vizsgálati eredmény*:</b> <i>Test result*:</i>	Pass			
<b>Vizsgálta:</b> <i>tested by:</i>	Tibor Mózes / Trainee Péter Végh / Trainee Petra Pintér / Trainee		<b>Jóváhagyta:</b> <i>authorized by:</i>	
<b>Dátum:</b> <i>Date:</i>	See date in diSign		<b>Kiadás dátuma:</b> <i>Issue Date:</i>	See date in diSign
<b>Pozíció / Position:</b>	Balazs Ivanka / Expert		<b>Pozíció / Position:</b>	Gabor Kovacs / Reviewer
<b>Egyéb szempontok / Other:</b>	* Megjegyzés: a csillaggal jelölt tevékenységet a NAH által NAH-1-1760/2024/K számon akkreditált vizsgálólaboratórium végezte. / The activities marked by star (*) were performed by the testing laboratory accredited by NAH under No. NAH-1-1760/2024/K. / The report is issued electronically. It is valid in the digitally signed PDF file. You can find details on the Signature Panel, check the signature named „TUEV-RHEINLAND-DOCUMENTS”. Any printed version of this PDF file is considered as a copy, where the authenticity cannot be verified. This report is only valid together with report number HU26SF3F 001, HU26NPSO 001 and HU26NRRO 001 and was prepared for certification purposes.			
<b>Vizsgálati tárgy állapota:</b> <i>Condition of the test item at delivery:</i>	Hiánytalan, sérülésmentes Test item complete and undamaged			
* Magyarázat:	P(ass) = megfelel a fenti követelménynek	F(ail) = nem felel meg a fenti követelménynek	N/A = nem vonatkozik	N/T = nem vizsgált
* Legend:	P(ass) = passed a.m. test specification(s)	F(ail) = failed a.m. test specification(s)	N/A = not applicable	N/T = not tested
<b>Ezen vizsgálati jegyzőkönyv a vizsgált mintapéldányra vonatkozik. A vizsgáló szervezet engedélye nélkül részleges másolata nem engedélyezett. Ez a jegyzőkönyv nem jogosít fel valamely biztonsági jel használatára.</b> <i>This test report only relates to the above mentioned test sample. Without permission of the test center this test report is not permitted to be duplicated in extracts. This test report does not entitle to carry any test mark.</i>				



**PHOTO DOCUMENTATION**

120L Dust bin Premium (type no.:	P120PN - Front view	P120PN - Marking	
			
<p>P120PN - Side view</p>	<p>P120PN - Side view with open lid</p>		
			
240L Dust bin Premium (type no.: P240N)	P240N - Front view	P240N - Marking	
			
<p>P240N - Side view</p>	<p>P240N - Side view with open lid</p>		
			

1100L Dust bin Premium (type no.: P1100N)	P1100N - Front view	P1100N - Marking		
				
<p>P1100N - Side view</p>	<p>P1100N – Side view with open lid</p>			
				

**1. MEASURING EQUIPMENT**

Measuring equipment	Manufacturer	Type	Inventory / Serial No.	Next calibration
Sound level meter	SVANTEK	SVAN 971, 7052E	2788755	23.01.2028
Stopwatch	Helvetia	S001	2788000	11.12.2028
Measuring-tape	SOLA METAL	5M/19 mm	9050230	20.04.2029
Temperature and humidity meter	TESTO	635	2786676	27.06.2026
Wind speed sensor	TROTEC	BA06	9024188	10.03.2027
Sound level calibrator	SVANTEK	SV 36	9081012	29.12.2027

**2. TECHNICAL DATA**

Description	:	Mobil waste containers with 2 wheels and flat lid		Mobil waste container with 4 wheels and flat lid
Type	:	120L Dust Bin Premium (type no.: P120PN)	240L Dust Bin Premium (type no.: P240N)	1100L Dust bin Premium (type no.: P1100N)
Nominal value	:	120 l	240 l	1100l
Dimensions [mm] (H x W x L)	:	950 x 480 x 470	1120 x 720 x 580	1081 x 1380 x 1347
Max. permissible weight [kg]	:	max 60 kg	max 110 kg	500
Pulling Force [N]	:	max: 18,5 N	max: 39,0 N	max 275 N

**3. INSTALLATION AND OPERATING CONDITIONS OF NOISE POWER MEASUREMENT**

The measurements were carried out with one new product as provided by the manufacturer.

All the measurements shall be carried out with an empty container.

Operating conditions:

- With the presence of the operator;
- Reflecting surface of concrete;
- Outside.

Place of the test: Mátyásföldi reptér, outdoor

Date of the test: 2026-06-05

Responsible for test: Balázs Ivánka, Tibor Mózes, Péter Végh, Petra Pintér

#### 4. TEST ENVIRONMENT

The outdoor area meets the requirements of 4.2 and Annex A of EN ISO 3744 standard. /Reflecting surface of concrete/

Background noise correction:  $K_1 = 0$  dB

Environmental correction:  $K_2 = 0$  dB / Outdoors measurements /

Measurement surface: hemisphere.

Radius of the hemisphere:  $r = 3$  m.

The area of the measurement surface:  $S = 56.52$  m<sup>2</sup>.

#### 5. ATMOSPHERIC CONDITIONS

For the type

Barometric pressure [hPa] : 1012

Air temperature [°C] : 25

Relative humidity [%] : 59

Wind velocity [m/s] : 4

#### 6. BACKGROUND NOISE

The level of the background noise was at least 15 dB below the sound pressure level at each measuring point. (The measured background noise is less than 50 dB (A))

Background noise correction  $K_{1A} = 0$  dB, according to the EN ISO 3744:2010 standard.

/  $\Delta L > 15$  dB; There is no correction. /

Positions	2	4	6	8	10	12
$L_{EQ}$	41.3	41.4	40.7	39.5	42.1	43.0

**7. MEASUREMENT METHOD – DETERMINATION OF SOUND POWER LEVEL**

Six microphone positions were located on a hemisphere with a radius of 3 [m] according to the following coordinates (EN ISO 3744:2010 standard):

The A-weighted sound power level was measured according to EN ISO 3744:2010 standard. Six microphone positions were located on the surface of the measuring hemisphere. The radius of the hemisphere is 3 [m].

**COORDINATES OF MEASUREMENT POSITIONS**

[ r = 3 [m] ]

Measurement position number	x/r	y/r	z
2	+ 0.7	+ 0.7	1.5 [m]
4	- 0.7	+ 0.7	1.5 [m]
6	- 0.7	- 0.7	1.5 [m]
8	+ 0.7	- 0.7	1.5 [m]
10	- 0.27	+ 0.65	0.71r
12	+ 0.27	- 0.65	0.71r

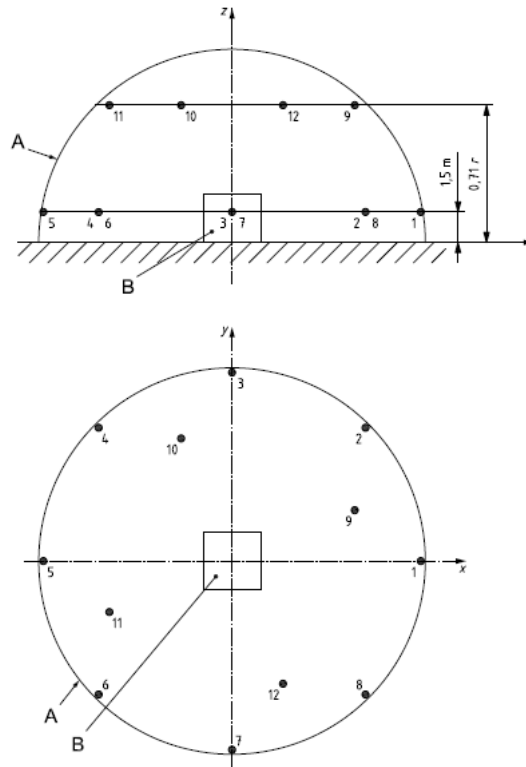

The noise measurement began with the empty container.

**Test No 1: Free shutting down of the lid along the container body**

The measurement is carried out during the following cycle, repeated 20 times:

- initially, the lid is raised vertically;
- the lid is released forward, if possible without giving an impulse, with the operator at the back of the container, unmoving until the lid is shut;
- after complete shutting, the lid is raised to its initial position.

**Test No 2: Complete opening of the lid**

The measurement is carried out during the following cycle:

- initially, the lid is opened horizontally;
- the lid is released without giving an impulse;
- after complete opening, and before a possible rebound, the lid is raised to its initial position.

**Test No 3: Rolling of the container over an artificial irregular track**

The measurement is carried out while the operator draws the container along the artificial track, with a constant speed of approximately 1 m/s, between points A and B (4,24 m distance — see Figure 39.3) when the wheel axle, for a 2-wheel container, or the first wheel axle for a 4-wheel container, reaches point A or point B. This procedure is repeated three times in each direction

**8. RESULTS**

For exact test results and calculations, see at test report of:

- 120L Dust Bin Premium (type no.: P120PN) - HU26SF3F 001
- 240L Dust Bin Premium (type no.: P240N) - HU26NPSO 001
- 1100L Dust bin Premium (type no.: P1100N) - HU26NRRO 001

Type	P120PN	P240N	P1100N
<b>Results</b>			
LWA shutting	87.68 dB (A)	90.98 dB (A)	95.12 dB (A)
LWA opening	88.33 dB (A)	87.24 dB (A)	90.99 dB (A)
LWA measured - rolling	92.8 (A)	87.32 dB (A)	92.91 dB (A)
Measured sound power level ( $L_{WA}$ measured):	90.25 dB (A)	88.89 dB (A)	93.33 dB (A)
Measured sound power level ( $L_{WA}$ measured) + measurement uncertainty (U):	91.97 dB (A)	90.61 dB(A)	95.05 dB (A)
<b>Guaranteed sound power level (<math>L_{WA}</math>):</b>	<b>92 dB (A)</b>	<b>91 dB(A)</b>	<b>95 dB (A)</b>

**The sound levels have been obtained in full conformity with the European Parliament and Council Directive 2000/14/EC.**

<b>Result</b>	<b>OK</b>
---------------	-----------

Place and date of testing:

1143 Budapest, Gizella út 51-57, Hungary, 2026-06-05

- End of Test Report -