

RAYSCAN 

RCT700

User Manual

RUG-700-EN
Rev. 2.0

This user manual contains information for appropriate use of RCT700.

The operator must read this manual carefully before using the product.

The operator must follow instructions and safety regulations described in the user manual to prevent any injury to the operator and the patient or damage to the product.

Caution (US only): This product must only be sold to dentists or oral health professionals as stated by the federal law.

Copyright Ray Co., Ltd.

Publication number: RUG-700-EN Rev. 2.0 (Revised Jun. 14, 2018)

This manual is subject to change without prior notice.

For further inquiries, contact your sales representative or customer service of manufacturer.



Ray Co., Ltd.

332-7, Samsung 1-ro, Hwaseong-si, Gyeonggi-do, 18380, Korea

Phone: +82-31-605-1000 Fax: +82-2-6280-5534

www.raymedical.com



DONGBANG ACUPRIME

1 Forrest Units, Hennock Road East,

Marsh Barton, Exeter EX2 8RU, U.K

Phone: +44-1392-829500 Fax: +44-1392-823232



Table of Contents

1	USER MANUAL INTRODUCTION.....	8
1.1	System Introduction.....	8
1.1.1	Intended Use.....	8
1.1.2	General information about the RCT700 Series.....	8
1.2	User Manual Reference Symbols.....	10
1.2.1	User Manual Reference Symbols.....	10
1.2.2	User Requirements.....	10
2	SAFETY MANAGEMENT AND REGULATIONS.....	14
2.1	System Symbols.....	14
2.2	General Safety.....	16
2.3	Electrical Safety.....	18
2.4	Mechanical Safety.....	19
2.5	Fire Safety.....	19
2.6	Explosion Safety.....	19
2.7	Electromagnetic Compatibility.....	19
2.8	Radiation Protection.....	24
2.9	Maintenance, Cleaning, and Disposal.....	25
3	PRECAUTIONS.....	28
3.1	General Precautions.....	28
3.2	Device-Related Precautions.....	30
4	SYSTEM OVERVIEW.....	34
4.1	System Purpose.....	34
4.2	System Configuration.....	34
5	SYSTEM HARDWARE OPERATION.....	38
5.1	Power ON/OFF.....	38
5.1.1	System Power ON Sequence.....	38
5.1.2	System Power OFF Sequence.....	39
5.2	System Emergency Stop.....	39
6	SOFTWARE OPERATION.....	42
6.1	RAYSCANS composition.....	42
6.2	MWL (Modality Worklist).....	44
6.2.1	MWL.....	44
6.2.2	Acquisition.....	47
6.2.3	Create Modality Worklist.....	62

6.2.4	MWL Modify.....	64
6.2.5	MWL Delete.....	66
6.2.6	MWL Delete All.....	67
6.3	Review.....	68
6.3.1	Review List.....	68
6.3.2	Create MWL.....	71
6.3.3	Job.....	73
6.3.4	Export.....	75
6.3.5	Print.....	79
6.3.6	Accept.....	82
6.3.7	Send.....	84
6.4	Patient Management.....	85
6.4.1	Patient List.....	85
6.4.2	New Patient Registration.....	87
6.4.3	Patient Information Modify.....	89
6.4.4	Patient Photo Registration.....	91
6.4.5	Patient Delete.....	92
6.5	Touch Monitor.....	94
6.5.1	Splash screen.....	94
6.5.2	System Operation.....	95
6.5.3	Acquisition.....	96
6.6	RAYSCAN ^{web}	112
6.6.1	System configuration.....	112
6.6.2	Operating Environment.....	112
6.6.3	Web License Installation.....	113
6.6.4	Web Log-in.....	113
6.6.5	Image Searching.....	115
6.6.6	Image Viewing.....	116
6.6.7	Web Management.....	121
7	SCANNING.....	124
7.1	Panoramic Scanning.....	125
7.1.1	Description of Panoramic Protocol.....	125
7.1.2	Cautionary Measures for Pre-Scanning.....	126
7.1.3	Panoramic Scanning Method.....	126
7.1.4	Patient Positioning Method.....	134
7.2	CEPH Scanning (One Shot Type).....	143
7.2.1	Description of CEPH Protocol.....	143
7.2.2	Cautionary Measures for Pre-Scanning.....	144
7.2.3	CEPH Scanning Method (One Shot Type).....	144

7.2.4	Patient Position Method	147
7.3	CEPH Scanning (Scan Type)	150
7.3.1	Description of CEPH Protocol	150
7.3.2	Cautionary Measures for Pre-Scanning	151
7.3.3	CEPH Scanning Method	151
7.3.4	Patient Position Method	154
7.4	CT Scanning	156
7.4.1	Description of CT Protocol	156
7.4.2	Cautionary Measures for Pre-Scanning	158
7.4.3	CT Scanning Method	158
7.4.4	CT Patient Positioning Method	161
8	ACCESSORIES	166
8.1	Accessories List	166
8.2	Remote Control Operating Procedure	167
8.2.1	How to Insert Batteries in the Remote Control	169
8.3	Temple Support Assembly	170
8.4	Bite Block and Chinrest Assembly	170
8.5	Remote Control Stand Assembly	171
8.6	Exposure Switch Stand Assembly	172
9	SYSTEM SPECIFICATIONS	174
9.1	Technical Specifications	174
9.1.1	X-ray Tube	178
9.2	Dose Information	181
9.2.1	Patient Population	181
9.2.2	Pediatric Subpopulation	181
9.2.3	Procedures Performed	182
9.3	FOV Variable range	183
9.3.1	Panorama Protocol	183
9.3.2	CT Protocol	183
9.3.3	Cephalo (One shot S-type)	184
9.3.4	Cephalo (One shot L-type)	184
9.3.5	Cephalo (Scan type)	184
9.4	Stray Radiation	185
9.5	Imaging Performance	187
9.5.1	Panoramic	187
9.5.2	CT	188
9.5.3	CEPH (One Shot L Type)	192
9.5.4	CEPH (One Shot S Type)	193

9.5.5	CEPH (Scan Type)	194
10	QUALITY ASSURANCE CONTROL.....	196
10.1	CT Quality Assurance Control	196
10.1.1	Qualification and Monitoring Frequency.....	196
10.1.2	Quality Control Test and Acceptance Limit.....	196
10.1.3	Quality Control Maintenance Tool (Phantom Information)	197
10.1.4	Quality Assurance Control Test	198
10.2	Panoramic and CEPH Quality Assurance Control.....	200
10.2.1	Qualification and Monitoring Frequency.....	200
10.2.2	Quality Control Test and Acceptance Limit.....	200
10.2.3	Quality Assurance Control Test	201
10.3	Tools to Maintain Quality Control Logs	203
10.4	Quality Assurance Training Material	203
10.5	Procedure to be Followed if Tested Parameter Fail	203
	Appendix A. RELATED STANDARDS	205
	Appendix B. GLOSSARY OF ACRONYMS	206

Introduction



1 USER MANUAL INTRODUCTION

1.1 System Introduction

RCT700 provides 3D computed tomography for scanning hard tissues such as bone and teeth. By rotating the C-arm, which houses a high-voltage generator, a X-ray tube and a detector on each end, CBCT images of dental maxillofacial structures are obtained by recombining data scanned from the same level at different angles. Functionalities include panoramic image scanning for obtaining images of whole teeth, and a Cephalometric option for obtaining Cephalometric images.

1.1.1 Intended Use

The RCT700 panoramic X-ray imaging system with Cephalostat is an extra-oral source X-ray system, intended for dental radiographic examination of the teeth, jaw, and oral structures, specifically for panoramic examinations and implantology and for TMJ studies and cephalometry. The device is also capable, using the CBCT technique, of generating dental maxillofacial 3D images. The device employs a cone-shaped X-ray beam projected onto a flat panel detector, and the examined volume image is reconstructed as a 3D image. 2D images are obtained using the standard narrow beam technique.

1.1.2 General information about the RCT700 Series

- Type of protection against electric shock: Class I Equipment
- Degree of protection against electric shock: Type B Applied Part
- Degree of protection against the ingress of water: IPX0
- Equipment not suitable for use in the presence of a flammable anesthetic mixture using air, oxygen or nitrous oxide.

- Class 1 laser equipment: IEC 60825-1



Warning



3D imaging should not be used for routine examinations.

3D imaging examinations must be justified for each patient to demonstrate that the benefits outweigh the risks.

1.2 User Manual Reference Symbols

1.2.1 User Manual Reference Symbols

The following symbols introduce cautionary measures for the safe operation of the RCT700.

Symbol	Name	Description
 Warning	Warning	Non-observance of contents described herein may result in casualties or severe injuries.
 Caution	Caution	Non-observance of contents described herein may result in physical injuries or loss of property.
Note	Note	Provision of additional information for assisting users.

1.2.2 User Requirements



Caution

Operation of the system described herein shall be performed only by dentists and those having received professional training, for example, radiologists. Users must be familiar with the operating method and safety guidelines stated in the user manual prior to using equipment. Inadequate knowledge of the operating method and safety guidelines could result in physical injuries to patients or users.

We hold no responsibility for any damage to the device or accidents caused by an operator. Operators must fully understand the procedures and cautions described in this document. This document may not fully describe all versions of the products due to differences in specifications.

This equipment has been tested and found to comply with the limits for medical devices in IEC/EN 60601-1-2. These limits are designed to provide reasonable protection against harmful interference in a typical medical installation. However, there is no guarantee that interference will not occur in a particular installation.

This equipment can generate, use and radiate radio frequency energy and, if not installed and used in accordance with the instructions, may cause harmful interference to other devices in the vicinity.

If this equipment does cause harmful interference to other devices, which can be determined by turning the equipment off and on, the user is encouraged to try to correct the interference by one or more of the following measures:

- Increase the separation between this system and other devices.
- Connect the system into an outlet on a circuit different from that to which other devices are connected.
- Consult the distributor or an experienced technician for help.

This page intentionally left blank.

Safety Management and Regulations











2

2 SAFETY MANAGEMENT AND REGULATIONS

This chapter is intended to provide safety information that users should familiarize themselves with prior to operating the equipment. The contents of this chapter are intended to preserve user safety and prevent property damage, and should be thoroughly studied in preparation for operation. When subsequent training is required, please contact the local representative.

2.1 System Symbols

The following table lists symbols closely related to patient and user safety.

Symbol	Description
	This symbol indicates the date of manufacture.
	This symbol indicates manufacturer.
	This symbol indicates Authorized Representative in the European Community.
	Indicates hazards arising from dangerous voltages.
	Indicates the absolute necessity of referencing the operating guidelines to ensure safe operation.
	Identifies a Type B applied part complying with IEC 60601-1.
	Indicates exposure or imminent exposure to X-rays.
	Indicates (on the rating plate) that the equipment is suitable for alternating current only.
	Indicates the “ON” condition.
	Indicates the “OFF” condition.

	Identifies any terminal which is intended for connection to an external conductor for protection against electric shock in case of a fault, or the terminal of a protective earth (ground) electrode.
	Indicates the danger of hands, long hair or loose clothing becoming caught or jammed.
	Indicates the necessity for compliance to guidelines appearing in this manual for safe operation of the equipment.
	General warning sign
	General mandatory action sign
	General prohibition sign
	Identifies the switch or button which suspends operation of the equipment in an emergency situation.
	Caution: Equipment is emitting a laser beam.
	Caution sign
	Caution: ionizing radiation.
	Do not open when box is broken or damaged.
	In-use or in-storage temperature sign.
	In-use or in-storage humidity sign.

2.2 General Safety



Warning

- The system described herein emits X-rays. Therefore, installation and operation of the equipment must be in compliance with international regulations.
- This system is considered dangerous to patients and users if exposure safety standards, operating guidelines and maintenance schedules are not properly followed. Additionally, the X-ray equipment described herein should be operated only by qualified users, such as dentists and radiologists.
- Only authorized users are permitted to touch any part of the system other than the Patient Handle.
- Device operation must be terminated immediately if any electrical and/or mechanical failure occurs. System failures can be verified through the display panel or by the warning alarm.
- When connecting parts to this system from an alternate machine, consult a professionally trained specialist. Use only the connectable accessories certified in compliance with IEC standards (IEC 60950-1 or IEC 60601-1). In addition, always comply with the relevant articles in IEC 60601-1 when connecting additional devices to the input/output signal elements.
- The system described herein requires regularly scheduled maintenance. For further details, refer to the section in this manual on Maintenance, Cleaning and Disposal.
- The system may not be usable if an error message appears during operation. Contact a service representative if an error message appears.
- RAY Co., Ltd. is not liable in the following circumstances.
 - Defects or physical injuries resulting from incorrect user-performed maintenance procedures.
 - Physical injuries as a result of user carelessness.
 - Defects, damages or physical injuries caused or initiated by supplemental equipment provided by anyone other than RAY Co., Ltd.

- Range of application
 - Conservative dentistry
 - Endodontics
 - Periodontology / Prosthodontics
 - Functional diagnosis and therapy of craniomandibular dysfunctions
 - Surgical dentistry
 - Implantology
 - Oral and maxillofacial surgery
 - Orthodontics

- Contraindications
 - Caries diagnoses, especially of proximal lesions
 - Display of cartilaginous structures
 - Display of soft tissues using X-ray

- Nonmodification of this equipment is allowed.

- Do not modify this equipment without authorization of the manufacture.

- If this equipment is modified, appropriate inspection and testing must be conducted to ensure continued safe use of equipment.

2.3 Electrical Safety

- The medical equipment described herein complies with Safety Class I, Type B in accordance with IEC 60601-1.
- The system must be operated in an environment fulfilling the IEC safety regulation requirements.



Warning

- Do not remove the system cover, beneath which there are no user-serviceable parts. Removing the cover exposes the user to the risk of electrocution from high-voltage current.

- Do not permit liquids to penetrate the system.



Caution

- If an unintended system operation places patients or users in danger, the equipment may be forced to turn off by pressing the Emergency Stop Switch.

- An unstable power supply may cause irregular system operation or suspension which could result in physical injuries to patients and users. Stable power supply must be taken into consideration at the time of installation.

- Emergency Stop Switch

If the system poses a danger to patients or users, it can be shut down by pressing the Emergency Stop Switch. The Emergency Stop Switch is located on the front side of the Main Power Switch.



Caution

- If the Emergency Stop Switch is pressed while an X-ray is being emitted, X-ray emission is immediately suspended.

- Use the Emergency Stop Switch only in case of emergency. Turning the system OFF with the Emergency Stop Switch can result in the loss of patient information.

- Emergency Stop Switch Release

To release the Emergency Stop Switch, rotate the switch to the right.

2.4 Mechanical Safety



Warning

- Do not remove system cover and cable unless directed by a professionally trained specialist.
- Audible and visual contact between patient and equipment operator must be maintained at all times during examination.
- Prevent body parts or clothing from being caught or jammed in the machinery. A warning sign is affixed to sections of the equipment which pose a risk of jamming and/or collision during use.

2.5 Fire Safety



Warning

- Do not operate this system in locations exposed to fire hazards.
- In the event of a fire, end equipment operation immediately and turn the power off. Extinguish the fire using a CO2 fire extinguisher. Do not use water or other liquids.

2.6 Explosion Safety



Warning

- Do not operate this system in locations which present the risk of explosion. This system is not designed for use in locations with explosion hazards and does not comply with AP/AGP standards.

2.7 Electromagnetic Compatibility



Warning

- Use of mobile phones and similar wireless devices in the vicinity of this system is prohibited. Use of devices non-compliant with EMC standards in close proximity can lead to unintended consequences due to electromagnetic interference.
- If the system is intended for use on patients having an “Implantable Cardiac Pacemaker” or “Implantable Defibrillator”, the user is obligated to inform patients that X-rays exposure may cause malfunction of these devices. When using this machine, avoid direct X-ray exposure of the “Implantable Cardiac Pacemaker” or “Implantable Defibrillator” and emit X-rays for the shortest duration possible.
- Protect the equipment from external electromagnetic waves.

- This device is only for use in an X-ray-shielded room providing over 20dB attenuation. The increased limits (beyond 20dB) were taken into account during the manufacturer’s radiated emission tests.

Guidance and manufacturer’s declaration - electromagnetic emissions		
<p>The RCT700 is intended for use in the electromagnetic environment specified below. The customer or the user of the RCT700 should assure that it is used in such an environment.</p>		
Emissions test	Compliance	Electromagnetic environment – guidance
RF emissions CISPR 11	Group 1	The RCT700 uses RF energy only for its internal function. Therefore, its RF emissions are very low and are not likely to cause any interference in nearby electronic equipment.
RF emissions CISPR 11	Class A	The RCT700 is suitable for use in all establishments other than domestic, and may be used in domestic establishments and those directly connected to the public low-voltage power supply network that supplies buildings used for domestic purposes, provided the following warning is heeded: Warning: This equipment/system is intended for use by healthcare professionals only. This equipment/system may cause radio interference or may disrupt the operation of nearby equipment. It may be necessary to take mitigation measures, such as re-orienting or relocating the RCT700 or shielding the location.
Harmonic emissions IEC 61000-3-2	Class A	
Voltage fluctuations/ flicker emissions IEC 61000-3-3	Complies	

Guidance and manufacturer's declaration - electromagnetic immunity			
The RCT700 is intended for use in the electromagnetic environment specified below. The customer or the user of the RCT700 should assure that is used in such an environment.			
Immunity Test	IEC 60601 Test Level	Compliance Level	Electromagnetic Environment - guidance
Electrostatic discharge (ESD) IEC 61000-4-2	±6 kV contact ±8 kV air	±6 kV contact ±8 kV air	Floors should be wood, concrete, or ceramic tile. If floors are covered with synthetic material the relative humidity should be at least 30%.
Electrical fast transient / burst IEC 61000-4-4	±2 kV for power supply lines ±1 kV for input/output lines	±2 kV ±1 kV	Mains power quality should be that of a typical commercial or hospital environment.
Surge IEC 61000-4-5	±1 kV line(s) to line ±2 kV line(s) to earth	±1kV ±2kV	Mains power quality should be that of a typical commercial or hospital environment.
Voltage dips, short interruptions and voltage variations on power supply input lines IEC 61000-4-11	<5% UT (>95% dip in UT) for 0,5 cycles 40% UT (60% dip in UT) for 5 cycles 70% UT (30% dip in UT) for 25 cycles <5% UT (>95% dip in UT) for 5 sec	Functions Interruption Functions Interruption Functions Interruption Functions Interruption	Mains power quality should be that of a typical commercial or hospital environment. If the user of the RCT700 requires continued operation during power main interruptions, it is recommended that the RCT700 be powered from an uninterruptible power supply or a battery.
Power frequency (50/60 Hz) magnetic field IEC 61000-4-8	3 A/m	Complies	Power frequency magnetic fields should be at levels characteristic of a typical location in a typical commercial or hospital environment.



Guidance and manufacturer's declaration - electromagnetic immunity			
<p>The RCT700 is intended for use in the electromagnetic environment specified below. The customer or the user of the RCT700 should assure that is used in such an environment.</p>			
<p>Conducted RF IEC 61000-4-6</p>	<p>3 Vrms 150 kHz to 80 MHz</p>	<p>0.15~80 MHz 3 V</p>	<p>Portable and mobile RF communications equipment should be used no closer to any part of the RCT700, including cables, than the recommended separation distance calculated from the equation applicable to the frequency of the transmitter.</p> <p>Recommended separation distance</p> $d = \left[\frac{3.5}{V_1} \right] \sqrt{P}$ $d = \left[\frac{3.5}{E_1} \right] \sqrt{P} \quad 80 \text{ MHz to } 800 \text{ MHz}$ $d = \left[\frac{7}{E_1} \right] \sqrt{P} \quad 800 \text{ MHz to } 2.5 \text{ GHz}$ <p>Where P is the maximum output power rating of the transmitter in watts (W) according to the transmitter manufacturer and d is the recommended separation distance in meters (m).</p> <p>Fields strengths from fixed RF transmitters, as determined by an electromagnetic site survey, should be less than the compliance level in each frequency range.</p> <p>Interference may occur in the vicinity of equipment marked with the following Radiated RF symbol.</p> 
<p>Radiated RF IEC 61000-4-3</p>	<p>3 V/m 80 MHz to 2.5 GHz</p>	<p>10 V/m 80 MHz to 2.5 GHz</p>	<p>Fields strengths from fixed RF transmitters, as determined by an electromagnetic site survey, should be less than the compliance level in each frequency range.</p> <p>Interference may occur in the vicinity of equipment marked with the following Radiated RF symbol.</p> 

TABLE: Recommended separation distances between portable and mobile RF communications equipment and the equipment.

The RCT700 is intended for use in an electromagnetic environment in which radiated RF disturbances are controlled. The customer or the user of the RCT700 can help prevent electromagnetic interference by maintaining a minimum distance between portable and mobile RF communications equipment and the RCT700 as recommended below, according to the maximum output power of the communication equipment.

Rated maximum output power of transmitter (W)	Separation distance according to frequency of transmitter (m)		
	150 kHz to 80 MHz $d = 1.2\sqrt{P}$	80 MHz to 800 MHz $d = 1.2\sqrt{P}$	800 MHz to 2.5 GHz $d = 2.3\sqrt{P}$
0.01	0.12	0.12	0.23
0.1	0.387	0.38	0.73
1	1.2	1.2	2.3
10	3.8	3.8	7.3
100	12	12	23

For transmitter rated at a maximum output power not listed above, the recommended separation distance d in meters (m) can be estimated using the equation applicable to the frequency of the transmitter, where P is the maximum output power rating of the transmitter in watts (W) according to the transmitter manufacturer.

Note 1 At 80 MHz and 800 MHz, the separation distance for the higher frequency range applies.

Note 2 These guidelines may not apply in all situations. Electromagnetic propagation is affected by absorption and reflection from structures, objects and people.

2.8 Radiation Protection



Warning

- The X-ray equipment described herein is in compliance with the radiation protection standard IEC 60601-1-3.
- Use available protective gear on patients during X-ray exposure to protect critical anatomy. (Neck area, especially around thyroid gland, reproductive organs, etc.)
- Excessive X-ray exposure can and must be avoided. Accurate scanning will reduce the number of rescans.
- X-ray scanning should be conducted in an X-ray shielded room when possible.
- In the event that anyone other than the patient must be in the X-ray room when X-rays are emitted, protective gear and a film badge or TLD badge must be worn.

2.9 Maintenance, Cleaning, and Disposal

- Maintenance
 - Perform regularly scheduled equipment inspections for safety of patients and users.

Maintenance Tasks	Period
Check power plug for secure connection to the dedicated power supply.	Daily
Check software for proper functioning after turning on the PC.	Daily
Check the connection between the device and the Workstation. (Confirm indication in User Interface.)	Daily
Make sure that Patient Information (Name, ID, etc.) appears correctly.	Daily
Check for correct appearance of scanned images on Workstation and Touch Monitors.	Daily
Check to make sure that scanned images are saved.	Daily
Turn the device off and confirm that all bolts are tightened.	Monthly

- Cleaning
 - Turn off all equipment power prior to cleaning.
 - Do not inject liquids while system cover is open.
 - Use a soft cloth to clean the Touch Monitor user interface and LCD monitor. When using spray detergents made for LCDs, do not spray directly on the LCD. Instead, spray appropriate amount of detergent onto cloth, then wipe.
 - Patient-contacting components such as Chinrest, Bite Block, Patient Handles and Temple supports can be cleaned with alcohol-based solutions. Other unit surfaces, including the Control Panel display, can be cleaned using a soft cloth slightly dampened with mild cleaning solution.

Note Do not use cleaning agents in aerosol or spray form directly on unit surfaces.

- Sterilization

- Parts coming in direct or indirect contact with patients must be sterilized periodically.
- Follow hospital or clinic's sanitary regulations.

- Disposal



- Because the system includes industrial waste materials in its composition, inappropriate disposal can cause environmental pollution. Do not dispose along with common industrial or household waste. When disposing of the system in whole or in part, observe all local, state, and federal biohazard handling regulations.
- For waste disposal related matters, contact RAY Co., Ltd. or a local authorized.

Precautions

3

3 PRECAUTIONS

The following includes information related to user safety in regard to possible incidents caused by fire or electricity, and should be understood fully before using the product.

3.1 General Precautions

1. The device should not be used by anyone other than trained users.
2. Installation pre-checks and precautions.
 - Install in a location where water damage is unlikely to occur.
 - Install in a location not subject to variations in air pressure, temperature, humidity, ventilation, direct sunlight, excessive dust, salinity, ion levels, etc.
 - Maintain safe working conditions by not subjecting the system to tilt, vibration, or shock.
 - Do not install in a location where chemical substances are stored or where gas is generated.
 - Pay attention to the voltage input, power frequency and acceptable tube current (or consumed power).
 - Check that the power is grounded.
 - Device not suitable for use in the presence of a flammable anesthetic mixture, especially in the presence of high oxygen or nitrous oxide levels.
3. Precautions prior to use
 - Inspect the switch operation. Verify that the device operates properly.
 - Make sure that the device ground is firmly connected.
 - Check all cables for firm and proper connection.
 - Do not use while other nearby devices are in operation, as problems may occur in obtaining accurate diagnoses.
 - Check for proper grounding.

4. Precautions during use
 - Continually monitor the device and patient behavior for irregularities.
 - When an irregularity is detected, stop the device, move the patient to a safe location, then pursue appropriate actions.
5. When malfunctions occur, do not touch the device under any circumstances. Immediately contact the manufacturer and distributor.
6. This device shall not be modified without permission.
7. Maintenance and inspection
 - Consult the manufacturer or an authorized service technician for assistance.
 - Device and components should be regularly inspected.
 - When the device is used after a long period of non-use, it should be tested for normal operation.
 - Clean using a neutralizing agent. Exercise caution to ensure that external substances do not enter the internal machinery.
 - Sterilize by using sterilizing liquids such as ethyl alcohol.
 - Do not use corrosive cleaning or sterilizing agents.
8. Other requirements
 - See User Manual for device handling and maintenance.

3.2 Device-Related Precautions

1. When scanning, user should be positioned outside the X-ray shielded room, operating the device through the use of an extension cable.
2. The user should be positioned to the rear of the X-ray scanner, rather than in front of it.
3. During installation, verify that the power cord is properly connected to the ground relay set.
4. Check the power ground. Connect the device to an outlet on a circuit to which no other device is connected.
5. Turn off the power when inspecting the device's internal components.
6. Continued maintenance and regular testing of the device is required.
7. X-ray Generation
 - This device generates X-rays and may cause harm to patient and user if used inappropriately.
 - This device may not be repaired by unauthorized personnel.
 - User is responsible for regular inspection of the device. Inspection routines are explained in hospital regulations and/or during installation and user training.
8. Warnings and Cautions
 - Pay attention to any warning signs evident on the equipment.
 - Application of the device based on the patient's age, gender and medical condition shall follow the physician's professional judgment.
 - This device generates X-rays and may cause serious harm or injury to patient and user. The device should be used only after proper user training, including thorough familiarization with this User Manual.
 - Pregnant women, or patients taking prescriptions, should consult with their physician prior to X-ray exposure.
 - Only authorized personnel should be allowed to enter the examination room.
 - Ensure an adequate supply of input power.

- Device operator should stay alert while using the equipment to monitor for possible side-effects and reduce the risk of accidents caused by carelessness.
- Because the device generates X-rays it should be installed and used according to the relevant international regulations.
- Adjust Lift Column height slowly to prevent equipment from dropping onto or colliding with the patient's head.
- Since various components rotate during the X-ray scan, advise the patient not to move while the scan is being performed.

9. Hygiene and disinfection

- Disinfect any parts of the system where the patient and the operator contact after each patient.
- Use hygienic cover for each patient to prevent cross contamination.
- Hygienic cover should be used once.

This page intentionally left blank.

System Overview

4

4 SYSTEM OVERVIEW

4.1 System Purpose

RCT700 is 3D computed tomography devices for scanning hard tissues such as bone and teeth. By rotating the C-arm, which houses a high-voltage generator, detectors (one at each end), and an all-in-one X-ray tube, complete images of anatomical structures may be obtained by recombining data acquired by scanning tissue levels from different angles. Included are panoramic image scanning functions for obtaining images of whole teeth, and a cephalometric scanning option for obtaining cephalic images.

4.2 System Configuration

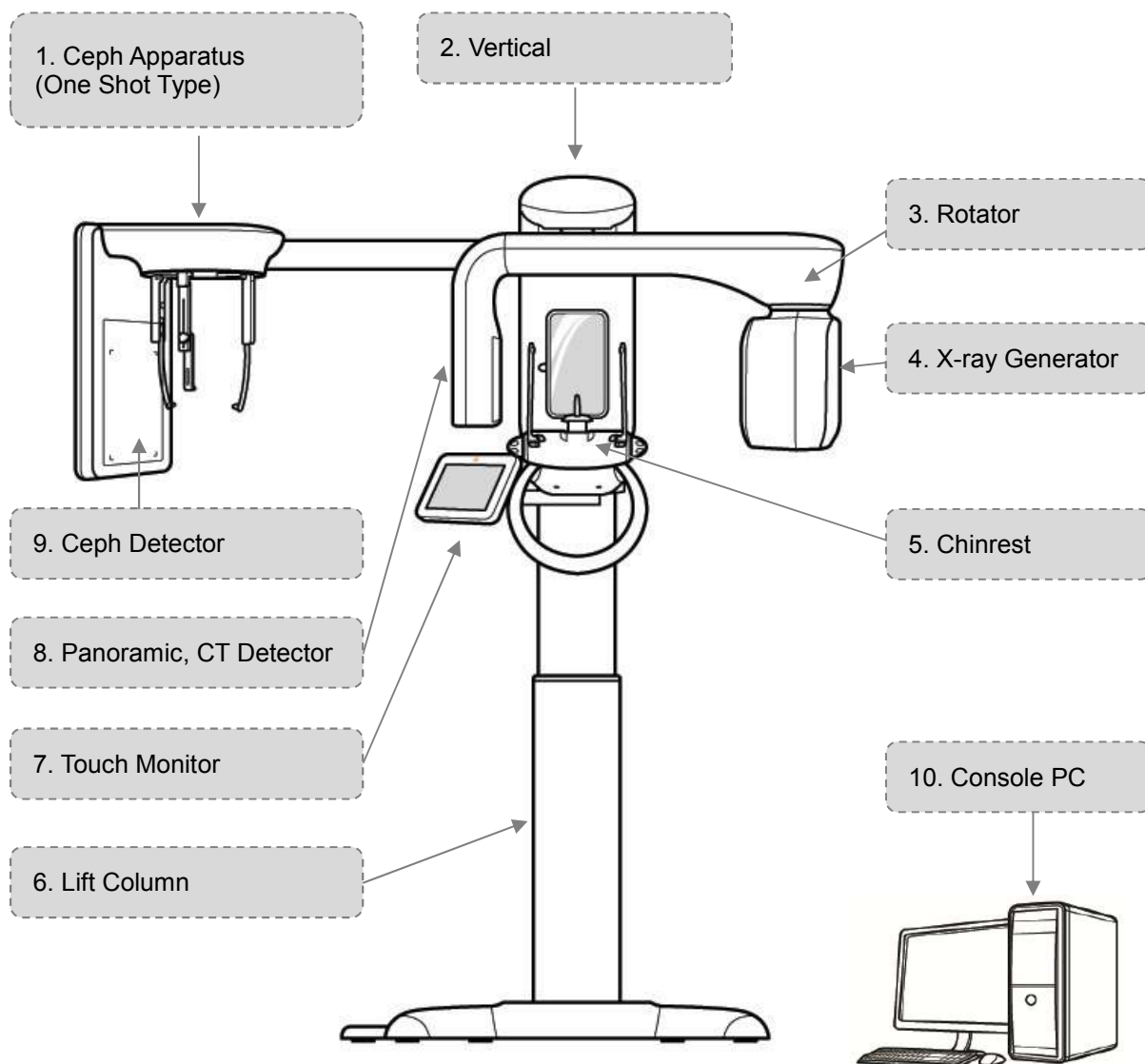

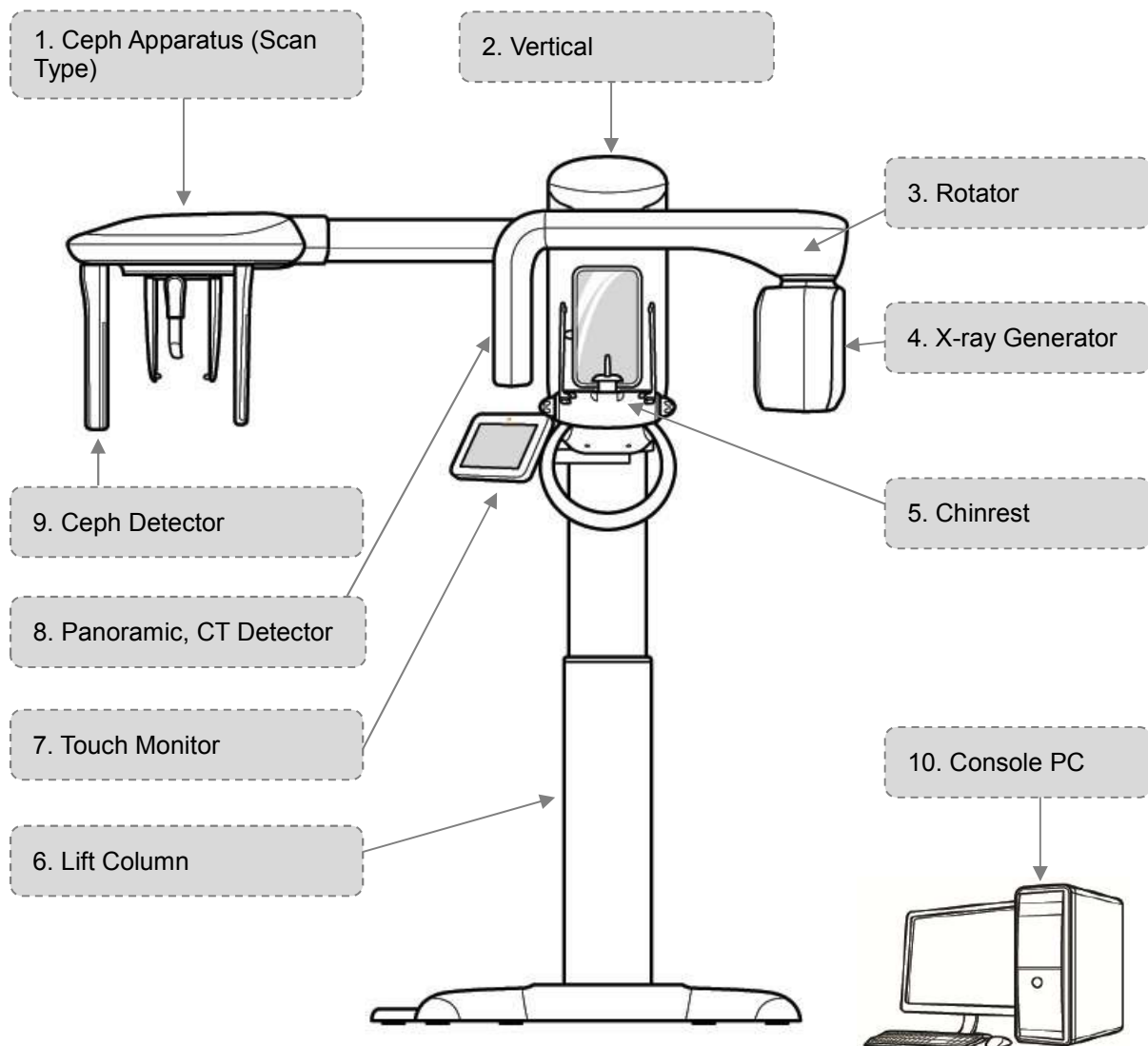

1) Ceph Apparatus

- Composed of an arm which connects to the Lift Column, a head-positioning assembly for patient placement, and a Ceph Detector. (One Shot Type/Scan Type)

2) Vertical

- This part is equipped with Rotator part.

3) Rotator

- Rotates during X-ray examination.

4) X-ray Generator

- High Frequency Generator and X-ray Tube integrated.

- High Frequency Generator: Supplies power to the X-ray Tube.
- X-ray Tube: Accelerates thermionic electrons emitted from a heated filament. Accelerated thermions collide with the Anode to generate X-rays.

5) Chinrest

- Attaches and detaches chinrest accessories and guides. (TMJ, Sinus, etc.)
- Installed Headrest and patient handle.

6) Lift Column

- Height adjustable
- Mirror for patient positioning.
- Touch Monitor for scanning, condition, control, etc.
- Remote control for height adjustment, etc. (The remote control is not provided in Canada.)
- Switch for X-ray exposure. (Exposure Switch)
- Base installed for floor support.
- Primary power installation.

7) Touch Monitor

- Displays touch-activated control buttons.
- Preview function for scanned images is available. (For detailed description, refer to paragraph 6.5.3.6: Confirm Image View.)

8) Panoramic, CT Detector

- Receives X-rays which have penetrated the human body and converts them into an electrical signal for transmission to a visual display device.

9) Ceph Detector

- Receives X-rays which have penetrated the human body and converts them into an electrical signal for transmission to a visual display device.

10) Console PC

- Console PC Set (PC, Monitor, Keyboard, Mouse)

System Hardware Operation

5

5 SYSTEM HARDWARE OPERATION

Prior to use of the device:



Warning

- Check the Main Power Switch and make sure the device is operating normally.
- Check ground for firm connection.
- Check all cables for firm and accurate connection.
- The simultaneous use of other devices may cause problems with accurate diagnosis.
- Check the power ground.

5.1 Power ON/OFF

5.1.1 System Power ON Sequence

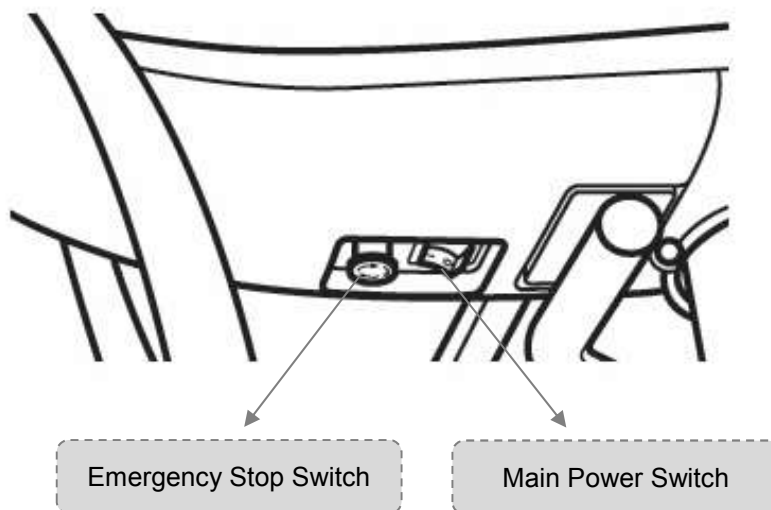

1	To turn on the RCT700, press the Main Power Switch located on the front of the equipment handle to the “ON” position.
2	Turn on the Console PC power.
3	RAYSCANS is automatically loaded.

5.1.2 System Power OFF Sequence

1	Close the RAYSCANS.
2	To turn off the RCT700, press the Main Power Switch located on the front of the equipment handle to the “OFF” position.

Note

When rebooting after turning the equipment off, wait approximately 5-10 seconds, then press the Main Power Switch to the “ON” position.

5.2 System Emergency Stop

In order to stop the equipment immediately in case of an emergency, press the Emergency Stop Switch located at the front of the equipment’s Main Power Switch. This will automatically halt device operation and suspend X-ray exposure.

To re-start the equipment, turn the Emergency Stop Switch in a clockwise direction. This will release the button from the “OFF” position and allow for system re-start.



Warning

The Emergency Stop Switch must only be used when physical injury to users or patients is imminent or ongoing, or when operating conditions become dangerous to the system, users or patients, or the immediate environment. Additionally, the Emergency Stop Switch may be used in dangerous situations caused by irregular scanning, natural disasters, or equipment malfunction.

This page intentionally left blank.

Software Operation

6

6 SOFTWARE OPERATION

6.1 RAYSCANS composition

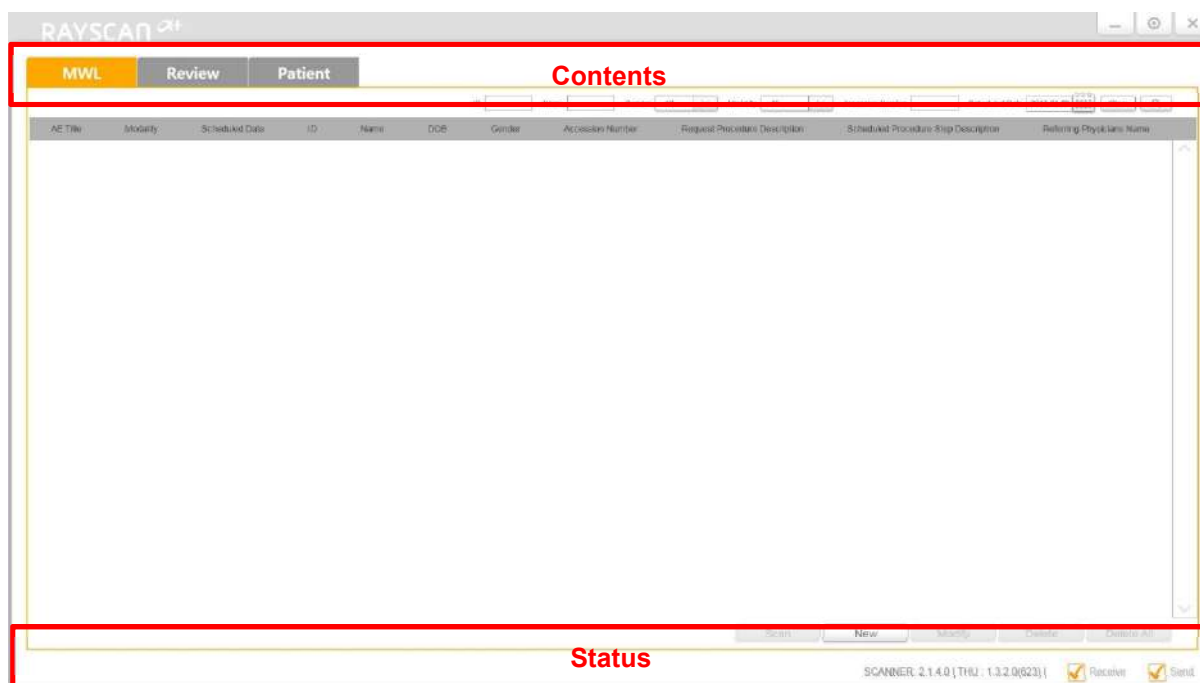

Fig 1 RAYSCANS composition

Contents

Item	Description
MWL	Displays the modality worklist (MWL). MWL may be prepared, modified, deleted, and selected for scanning. Search MWL using ID, Name, etc. For detailed description, refer to paragraph 6.2 MWL.
Review	Shows the scanning-completed MWL. Send scanning-completed MWL to an alternate server; Export; DICOM print; completed image confirm and transmit to DICOM server. Search scanning completed MWL using ID, Name, etc. For detailed description, refer to paragraph 6.3 Review.
Patient	Displays patient information in thumbnail or list. Patient information may be added, modified or deleted. Search patient information using ID, Name, etc. For detailed description, refer to paragraph 6.4 Patient Management.

Status

Scanning enabled only when both Receive and Send categories are checked.

Item	Description
Version	Shows the SCANNER and THU version. Displays the version when connected the system.
Receive	Checked when the RAYSCANS is ready to receive data from the system. Cannot be user-designated.
Send	Checked when the RAYSCANS is ready to send data to the system. Cannot be user-designated.

6.2 MWL (Modality Worklist)

6.2.1 MWL

This tab provides MWL(order list of image acquisition) management function such as new, modify, delete and delete all.

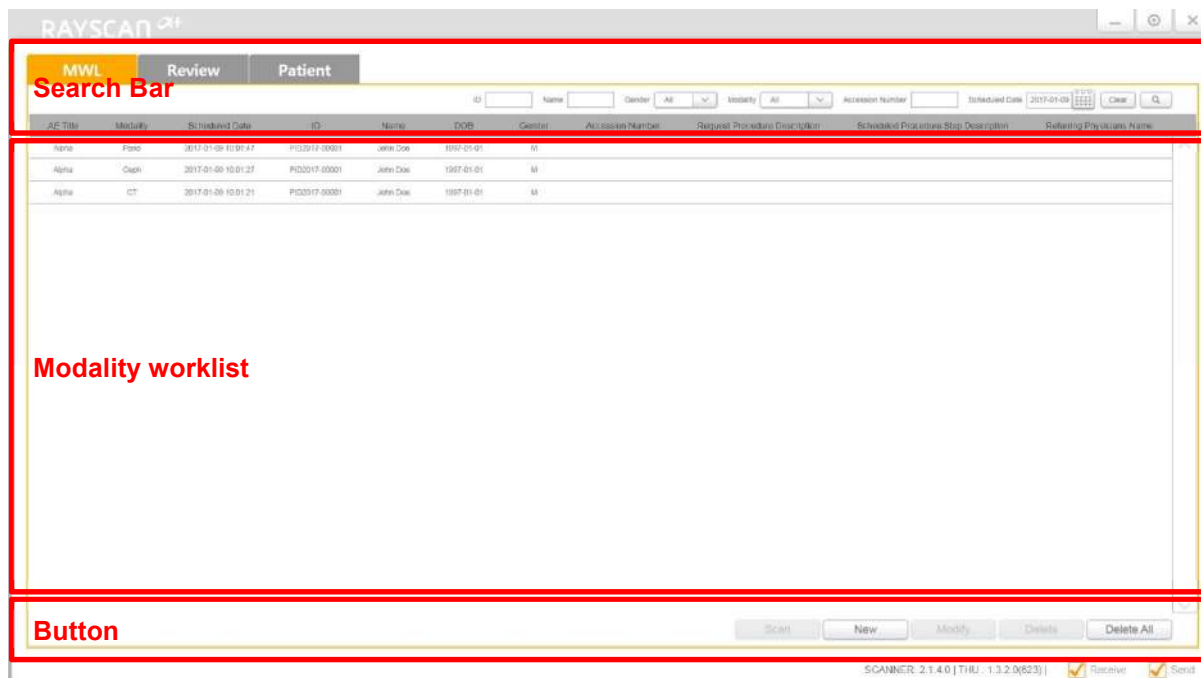

Fig 2 MWL

Search Bar

Item	Description
ID	Input Criteria: Fewer than 20 characters, English·Numeric·Chinese Characters·Japanese/Special Characters “-” (hyphen), “.” (period) characters are available for input. Insert the first letter and click the “Search” button to see a list of words that begin with the selected letter.
Name	Input Criteria: Fewer than 50 characters, English·Numeric·Chinese Characters·Japanese/Special Characters “-” (hyphen), “.” (period), “,” (comma), blank characters are available for input. Enter the name(or first name, middle name, last name) of patient.
Gender	Type: All (Default), Male, Female, Other (Example: Emergency)

Modality	In this category, the type of scanning differs depending on the type of device. Through use of the Config Editor Tool, it is possible to mark and use a category. Type: All(Default), CT, Pano, Ceph, Intraoral
Accession Number	Input Criteria: Fewer than 20 characters, English·Numeric·Chinese Characters·Japanese/Special Characters “-” (hyphen), “.” (period) characters are available for input. When using insurance claim numbers, insert the relevant claim number in the DICOM scanning information. Searching by accession number will be available in the future.
Scheduled Date	Scanning date (Default: Today’s Date)
[Calendar]	Click to display calendar for date selection. When date is selected, calendar automatically disappears and selected date is shown in the text box.
[Clear]	Deletes the designated criteria and returns to initial condition.
[Search]	Searches MWL based on the designated search criteria.

Modality worklist

Item	Description
AE Title	This separator is for checking where the image was acquired.
Modality	Type: CT, Pano, Ceph, Intraoral
Scheduled Date	Scanning date (Default: Today’s date)
ID	Patient ID.
Name	Patient name
DOB	Date of Birth
Gender	Type: M (Male), F (Female), O (Other)
Accession Number	When using insurance claim numbers, insert the relevant claim number in DICOM scanning information.
Request Procedure Description	If saved format for specific scanning method exists, insert relevant description.
Scheduled Procedure Step Description	Shows name of requesting physician.
Referring Physician Name	Referring physician’s name. Name of the doctor who requested the scan.

Button

[Default]

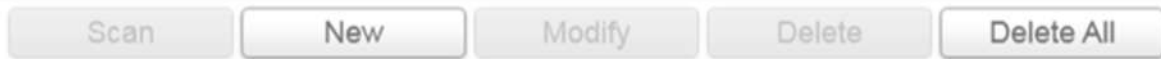

[At MWL selection – buttons are activated as shown below.]



Item	Description
[Scan]	Select modality worklist and click [Scan] to start image acquisition or double click the MWL (RAYSCANS will go to Acquisition screen). For detailed description, refer to paragraph 6.2.2 Acquisition.
[New]	Create new MWL for preparing acquisition. For detailed description, refer to paragraph 6.2.3 Create Modality Worklist.
[Modify]	Modify MWL information for proper acquisition. For detailed description, refer to paragraph 6.2.4 MWL Modify.
[Delete]	Delete the selected MWL. For detailed description, refer to paragraph 6.2.5 MWL Delete.
[Delete All]	Delete all requested MWL. For detailed description, refer to paragraph 6.2.6 MWL Delete all.

6.2.2 Acquisition

Acquisition occurs when the [Scan] button is clicked in the MWL screen.

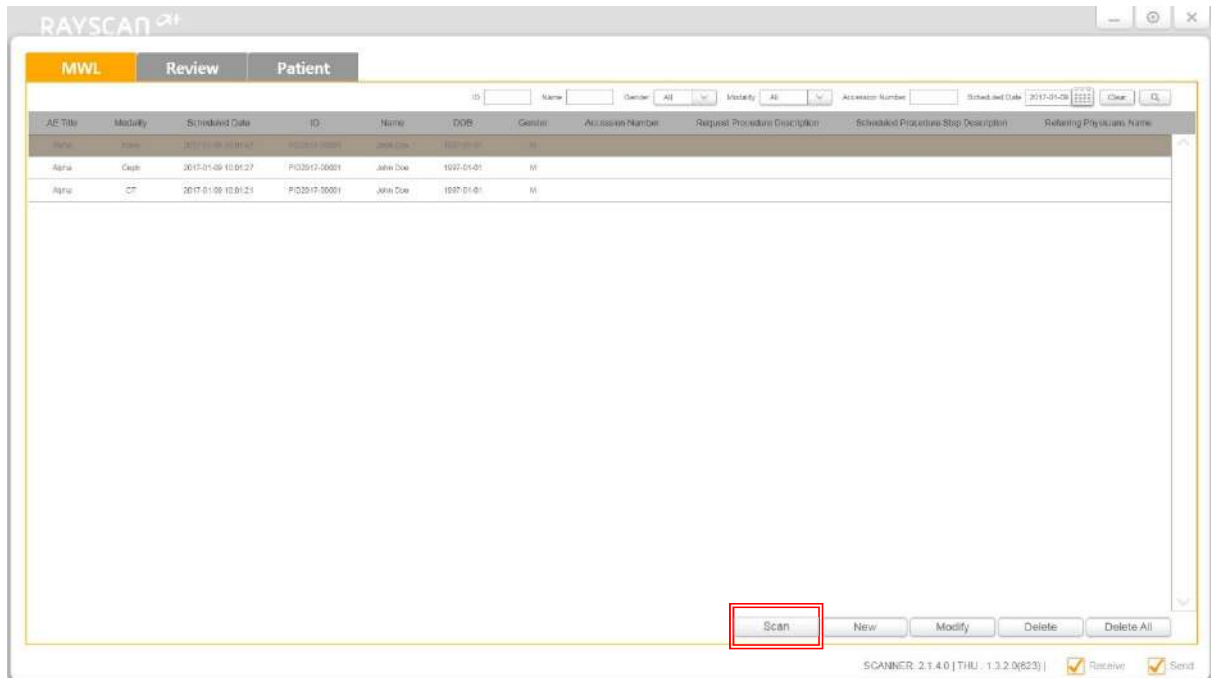

Fig 3 MWL Scan

6.2.2.1 Patient Information

Confirm the patient information for correct image acquisition.

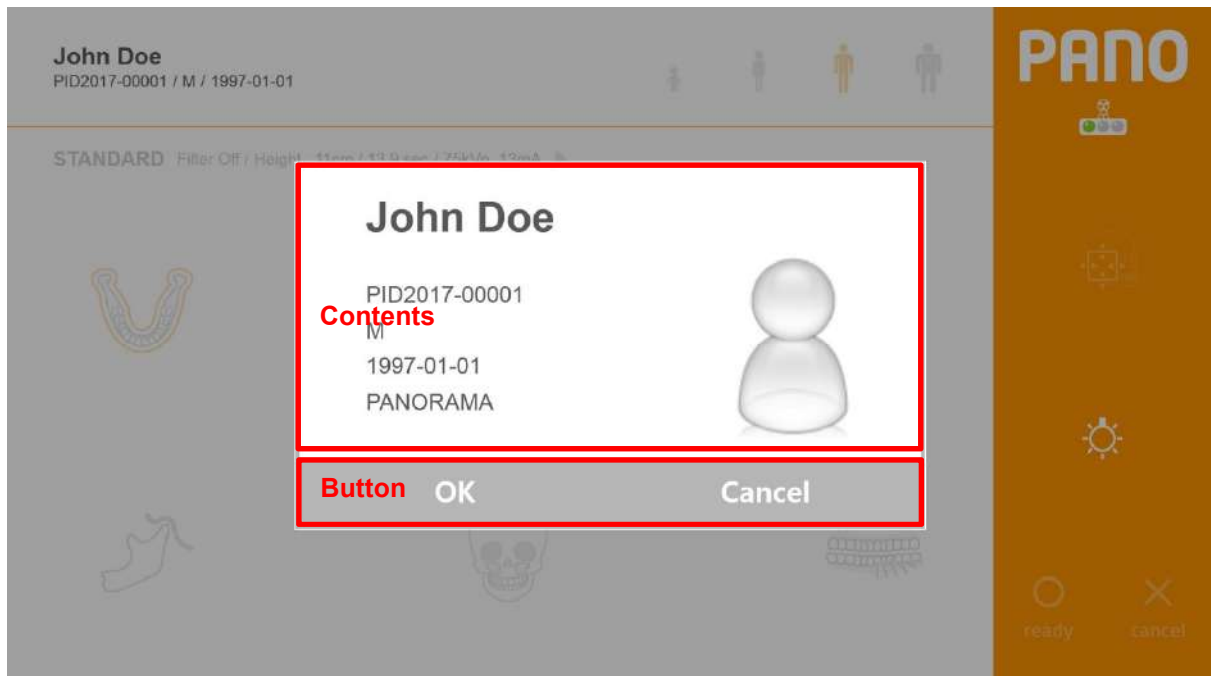

Fig 4 Patient Information

Contents

Item	Description
Portrait	Shows the patient photo when a patient photo is registered. When the photo is not registered, displays default image.
ID	Patient ID.
Name	Patient name
Gender	Type: M(Male), F(Female), O(Other)
Birth date	Patient birth date
Modality	Type: CT, Pano, Ceph, Intraoral

Button

Item	Description
[OK]	Verify patient information. If correct, click to close Patient Information screen and go to Scanning screen.
[Cancel]	Click when patient information is incorrect or scanning is cancelled. Click to cancel scanning. Close Patient Information screen and scanning screen in that order and return to MWL screen.

6.2.2.2 Panoramic Acquisition

Panoramic Imaging Setup Screen

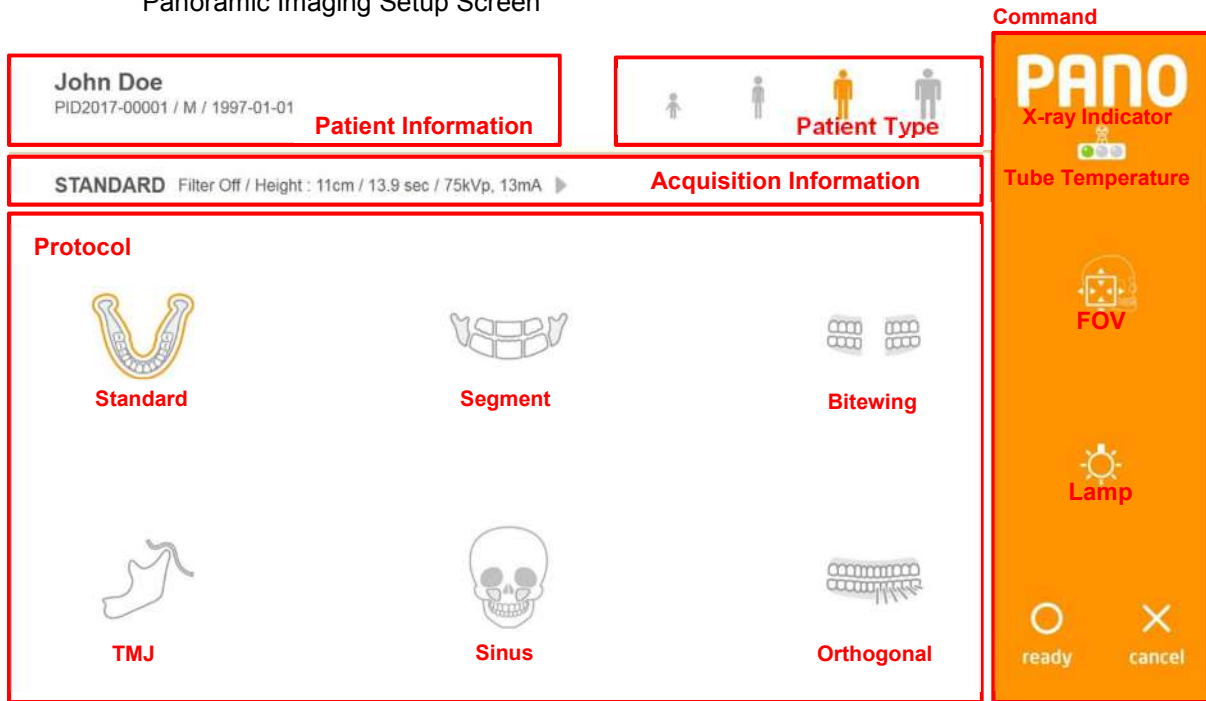

Fig 5 Panoramic Acquisition

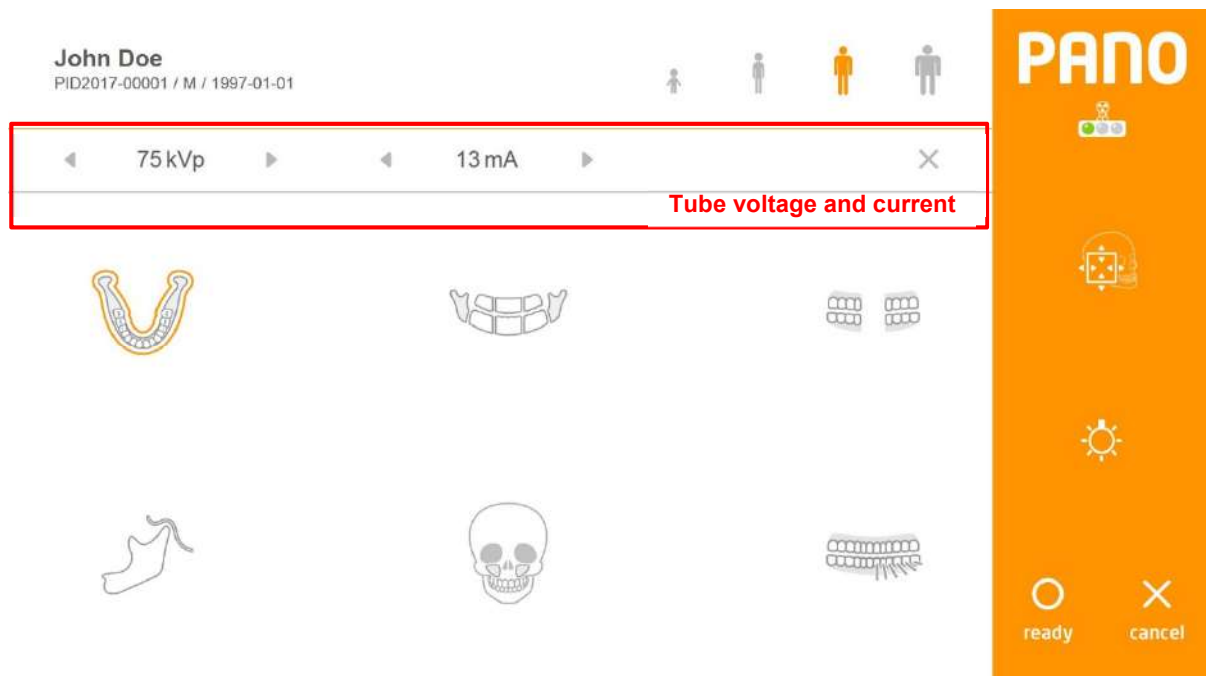

Fig 6 Exposure Condition Adjustment

Patient Information

Item	Description
ID	Patient ID.
Name	Patient name
Gender	Type: M (Male), F (Female), O (Other)
Birth Date	Patient birth date
Exposure Time	Exposure time varies according to modality and protocol.

Patient Type

Item	Description
[Child]	Child build
[Small adult]	Small adult build
[Adult]	Adult build
[Large adult]	Large adult build

Acquisition Information: Display acquisition information

Item	Description
Display	Display the information of selected protocol.
▶	Display the exposure select options with click.





Tube Voltage and Tube Current: Control tube voltage and current

Item	Description
◀	Decrease kVp button. The number decreases by 1 kVp on click.
Tube Voltage (kVp)	Display the voltage kVp setting.
▶	Increase kVp button. The number increases by 1 kVp on click.
◀	Decrease mA button. The number decreases by 1 mA on click.
Tube current (mA)	Display the current mA setting.
▶	Increase mA button. The number increases by 1 mA on click.

Protocol: Acquisition Mode

Item	Description
[Standard]	Select Standard protocol.
[Segment]	Select Segmentation protocol.
[TMJ]	Select TMJ protocol.
[Sinus]	Select Sinus protocol.
[Bitewing]	Select Bitewing protocol.
[Orthogonal]	Select Orthogonal protocol.

Command

Item	Description
Tube Temperature	Temperature of X-ray tube 
X-ray Indicator	X-ray exposure condition. Yellow light turns on during X-ray exposure. ON  Yellow light OFF 
[FOV]	Turn on/off buttons on FOV Mode. Click to get into FOV Mode. Alignment Beam On/Off Button. Click to turn the alignment beam OFF if turned ON and turn ON if turned OFF.
[Lamp]	ON  OFF 
[ready]	Scanning preparation complete button. When clicked, system moves to the start position for scanning.
[cancel]	Click to cancel scanning, close Pano screen and return to MWL screen. Click after [ready] button is clicked to cancel the scanning preparation process.

FOV Mode

On FOV Mode, the THU displays as Fig 7 on the screen. The exposure area can be adjusted on the THU and/or remote control.

※ The remote control is not provided in Canada.

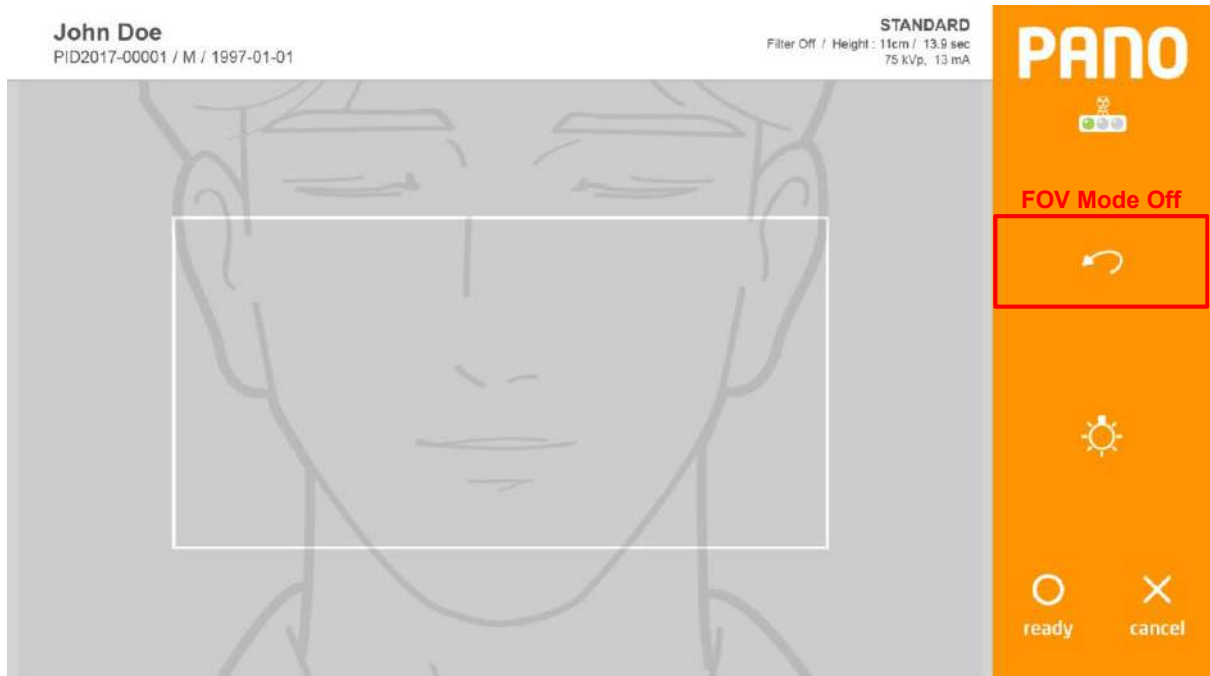

Fig 7 FOV Mode

Item	Description
[FOV Mode Off]	Finish FOV Mode and turns back to Protocol screen.

Temperature

Monitor the X-ray tube temperature. Under normal operating conditions, the green light is on. When the temperature rises, the yellow light turns on. When overheated, the red light turns on. Scanning is possible when the green light is on. When the red or yellow light is on, cooling time is required. (Yellow zone: ~3 minutes, Red zone: ~5 minutes) Remaining cooling time is shown above the [ready] button. Fig 8 shows the cooling time indicator.

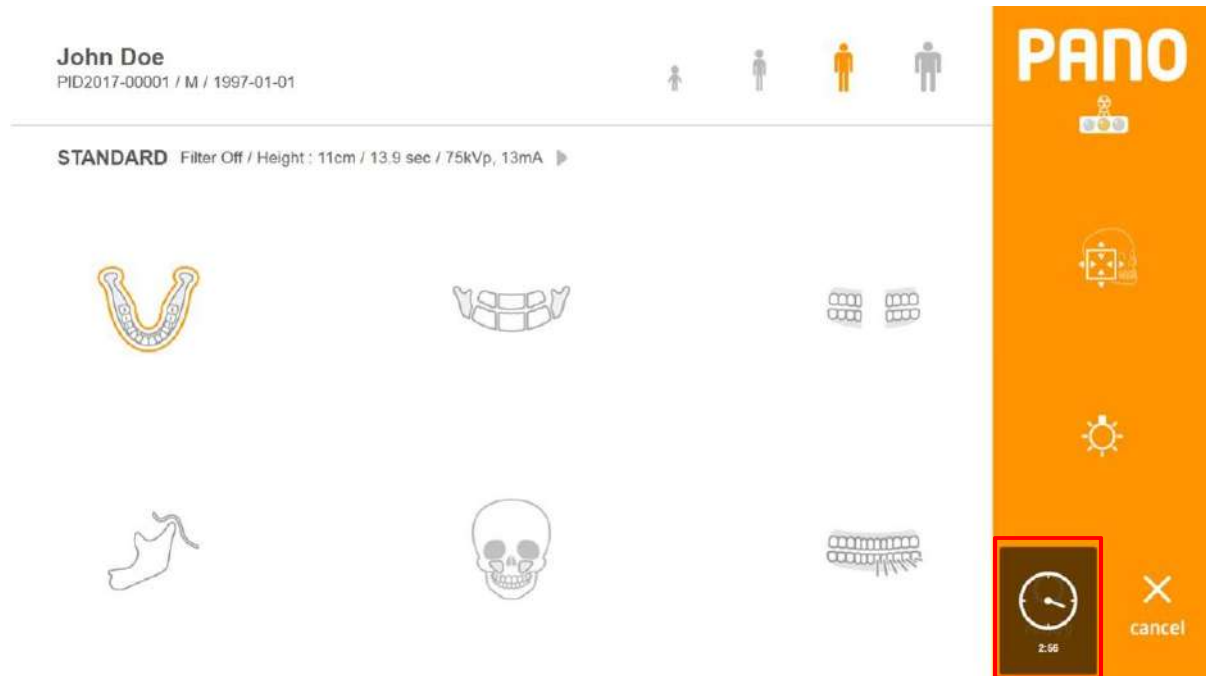

Fig 8 Cooling Time Indicator

6.2.2.3 Cephalometric Acquisition (One Shot Type)

One Shot Ceph Imaging Setup Screen

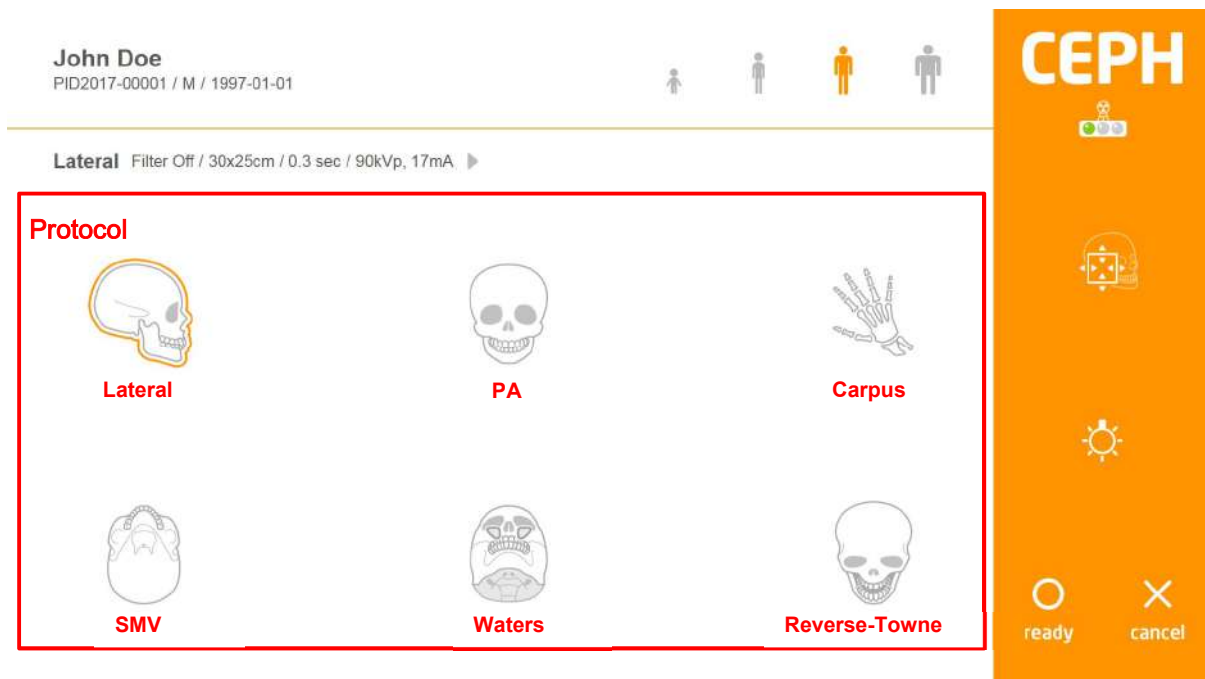

Fig 9 Acquisition: Cephalometric

Protocol: Acquisition Mode

Item	Description
[Lateral]	Select Lateral protocol.
[PA]	Select PA protocol.
[Carpus]	Select Carpus protocol.
[SMV]	Select SMV protocol.
[Waters]	Select Waters protocol.
[Reverse-Towne]	Select Reverse-Towne protocol.

6.2.2.4 Cephalometric Acquisition (Scan Type)

Scan Ceph Imaging Setup Screen

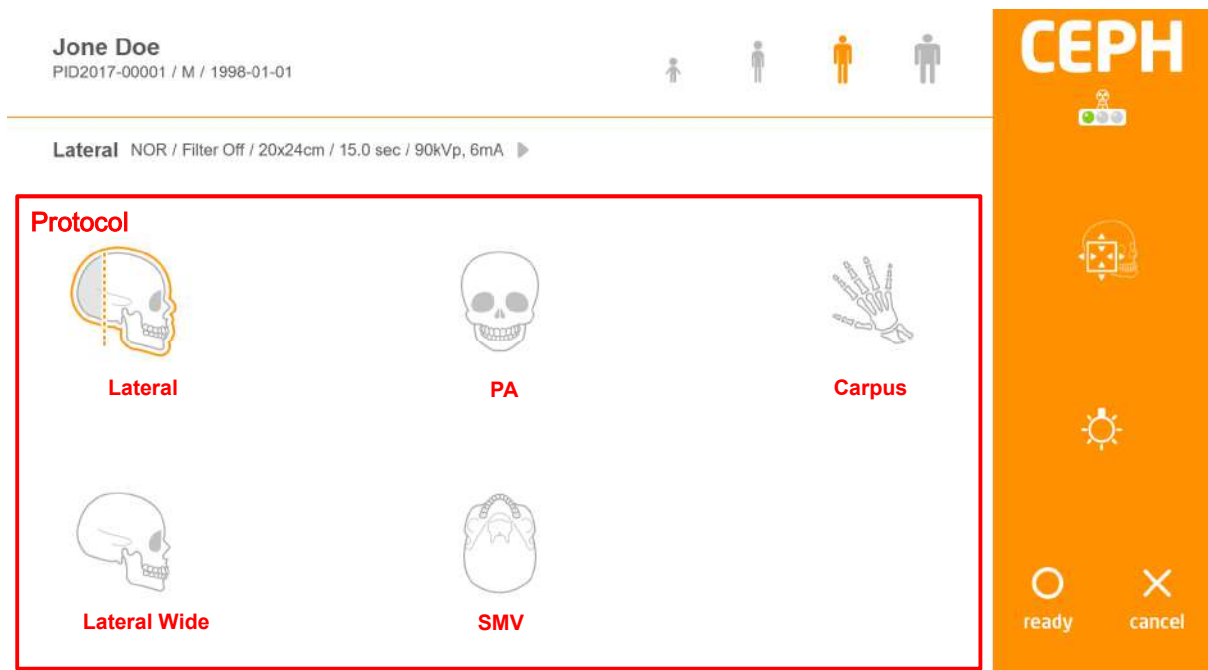

Fig 10 Acquisition: Cephalometric

Protocol: Acquisition Mode

Item	Description
[Lateral]	Select Lateral protocol.
[PA]	Select PA protocol.
[Carpus]	Select Carpus protocol.
[Lateral Wide]	Select Lateral Wide protocol.
[SMV]	Select SMV protocol.

6.2.2.5 CT Acquisition

CT Imaging Setup Screen

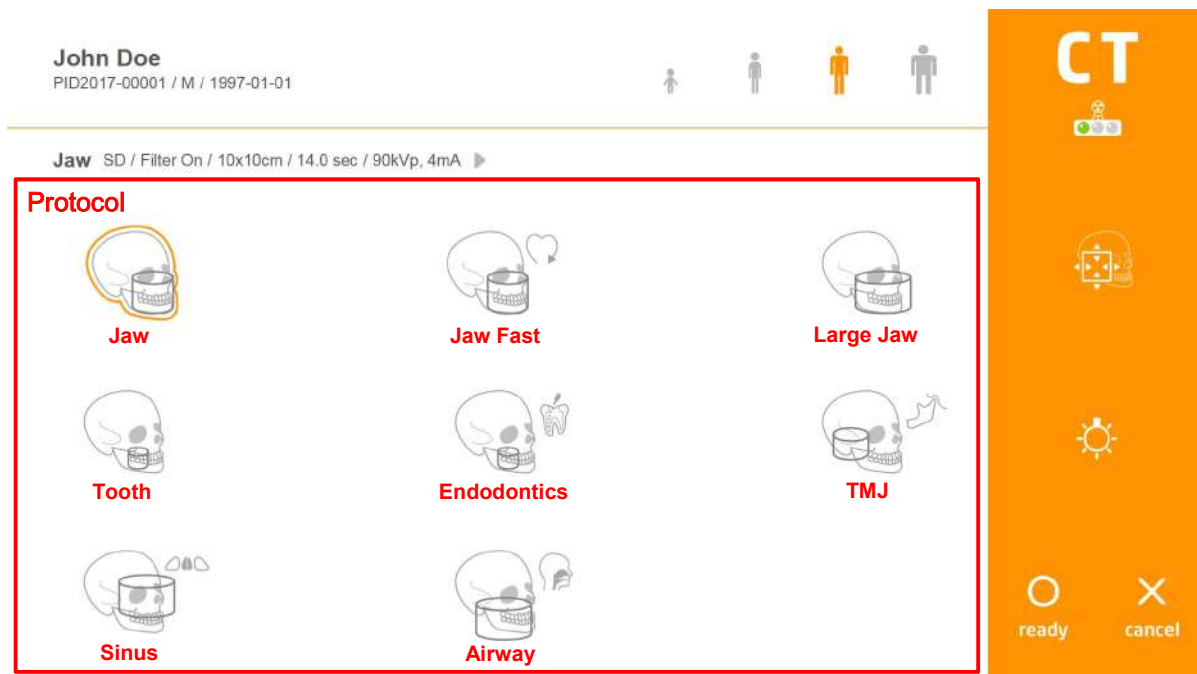

Fig 11 Acquisition: CT

Protocol: Acquisition Mode

Item	Description
[Jaw]	Select Jaw protocol.
[Jaw Fast]	Select Jaw Fast protocol.
[Large Jaw]	Select Large Jaw protocol.
[Tooth]	Select Tooth protocol.
[Endodontics]	Select Endodontics protocol.
[TMJ]	Select TMJ protocol.
[Sinus]	Select Sinus protocol.
[Airway]	Select Airway protocol.

6.2.2.6 Confirm Image View

Image view confirmation screen, displayed after image acquisition has been completed.



Fig 12 Confirm Image View: Panoramic

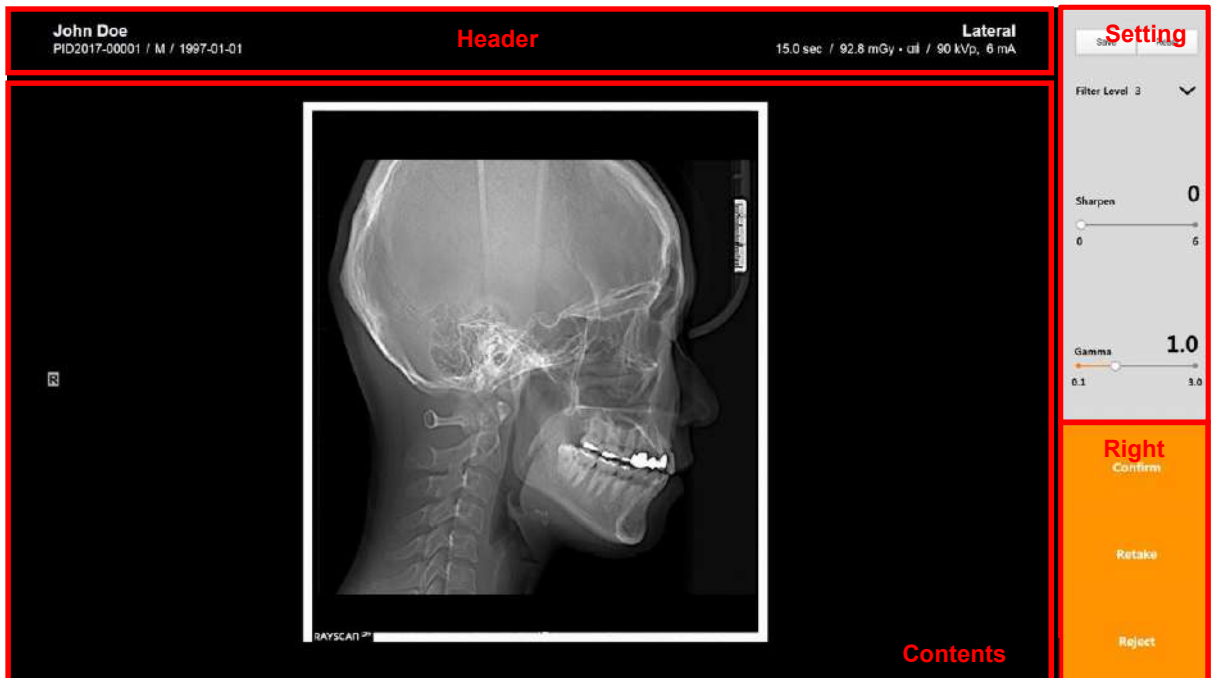

Fig 13 Confirm Image View: Cephalometric



Fig 14 Confirm Image View: CT

Header

Item	Description
ID	Patient ID.
Name	Patient name
Gender	Type: M (Male), F (Female), O (Other)
Birth Date	Patient birth date
Scan Time	Scan time
Dose	X-ray Dose (mGy * cm ²)

Contents

Item	Description
Image	Completed image

Setting

Item	Description
Save	Save the set value.
Reset	Go to the initial value.
Filter Level	Adjust the filter level.
Sharpen	Adjust the sharpness.
Gamma	Adjust the gamma.

Right

Item	Description
[Confirm]	Save acquired image to the server on confirmation status and go to MWL screen. Scanned image is automatically sent to Auto Routing destination. For detailed description, refer to paragraph 6.3 Review.
[Retake]	Save acquired image to the server on reject status and go to imaging setup screen for acquiring image again.
[Reject]	Save acquired image to the server on reject status and go to MWL screen. Scanned image does not go through Auto Routing procedure. For detailed description, refer to paragraph 6.3 Review. To confirm the rejected image, refer to paragraph 6.3.6 Accept.

Note

Reject image is not displayed on imaging software. You can change reject status to confirmation at review tab.

6.2.2.7 Panoramic TMJ Acquisition

Use TMJ protocol is for Temporomandibular Joint Disorders and Malocclusion. On 2-View, the operator can select either Open mouth or Close mouth. However, both scanning options can be used on 4-View.

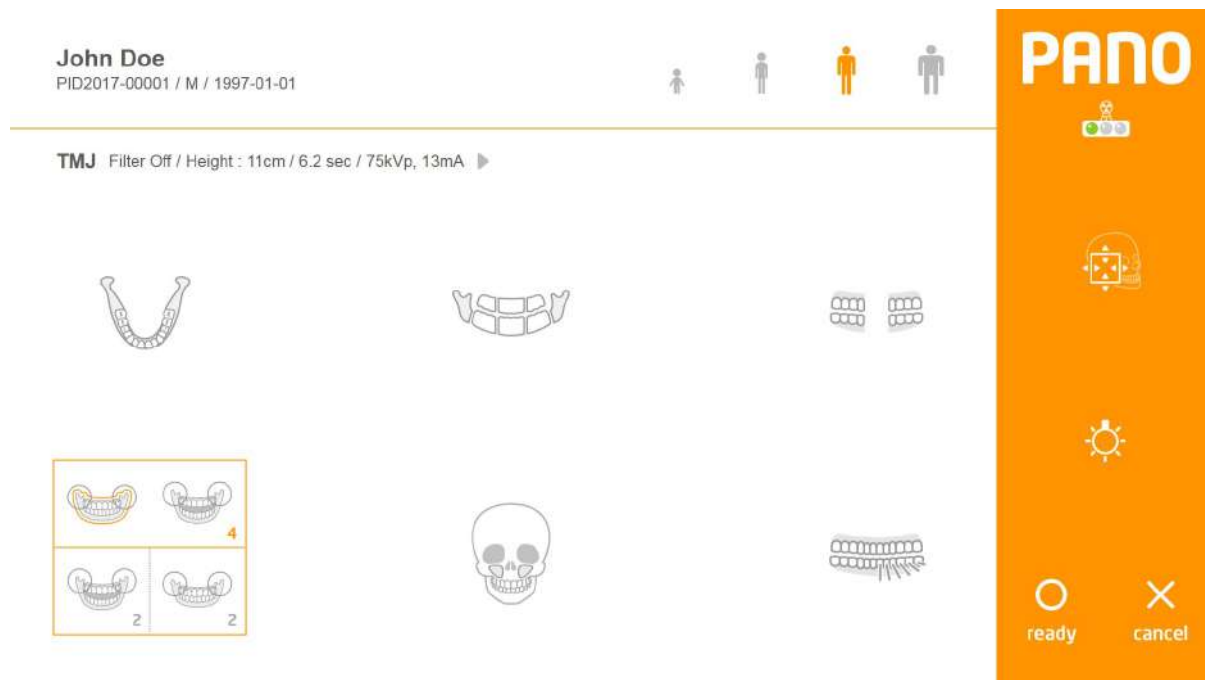

Fig 15 TMJ Select screen

On 4-View option, scan 2 times continuously and the results are in 1 image view as 'Fig 17'.

2-View scan: On TMJ Select screen (Fig 15), select either Open or Close to scan and the result image is displayed as 'Fig 16'.

4-View scan: On TMJ Select screen (Fig 15), select 4-View option and scan Close images first. As soon as the scan is finished, the result image pops-up (Fig 16). Click [Confirm] to scan Open images as following. After all the scans, the final image is displayed in 1 image view 'Fig 17'.

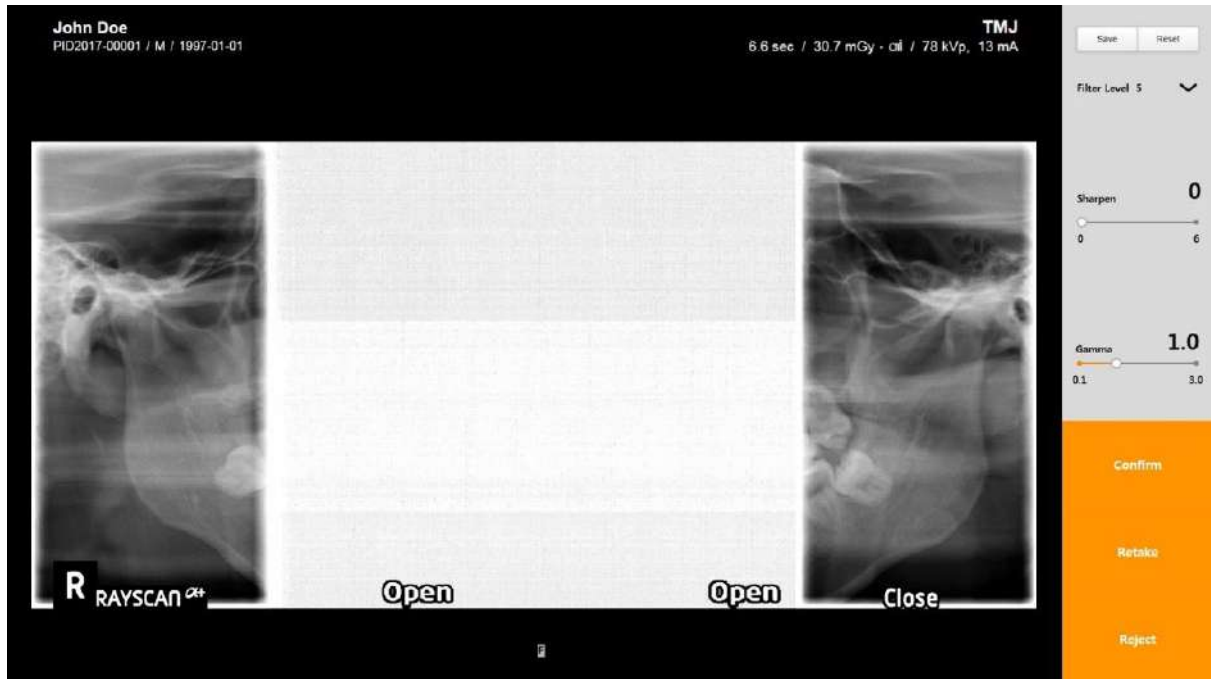

Fig 16 TMJ 2-View



Fig 17 TMJ 4-View

6.2.3 Create Modality Worklist

Click [New] button on MWL tab to make new MWL. Create Modality Worklist window displays as below figure.

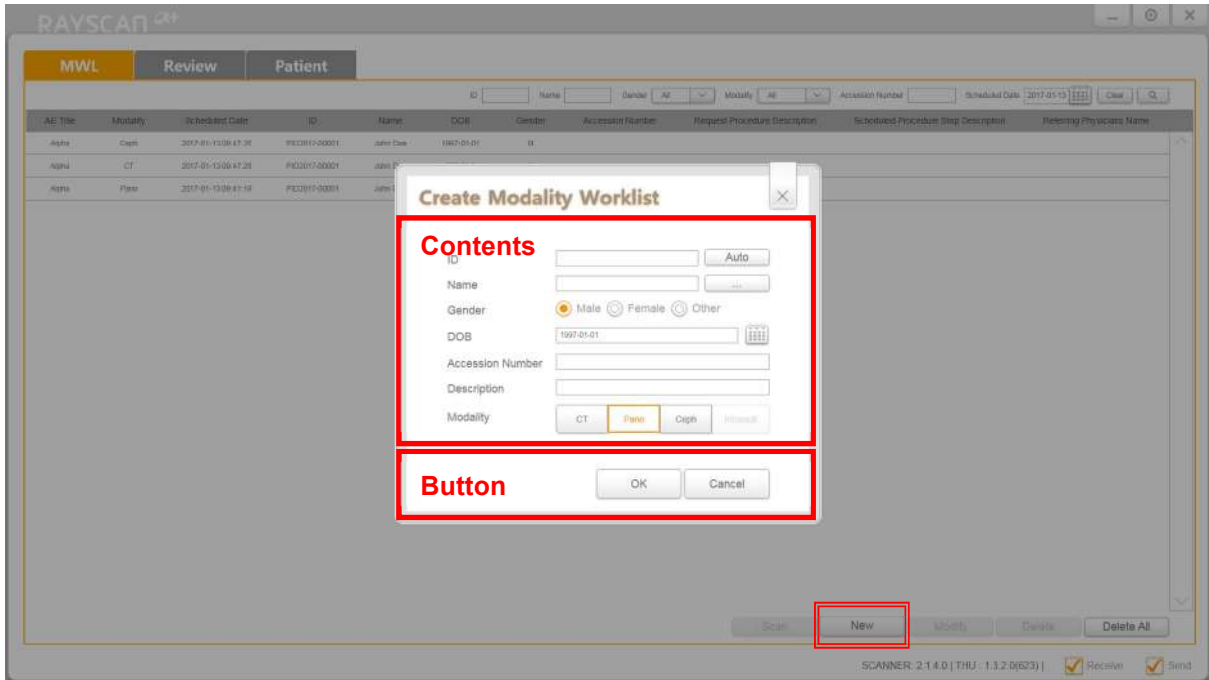
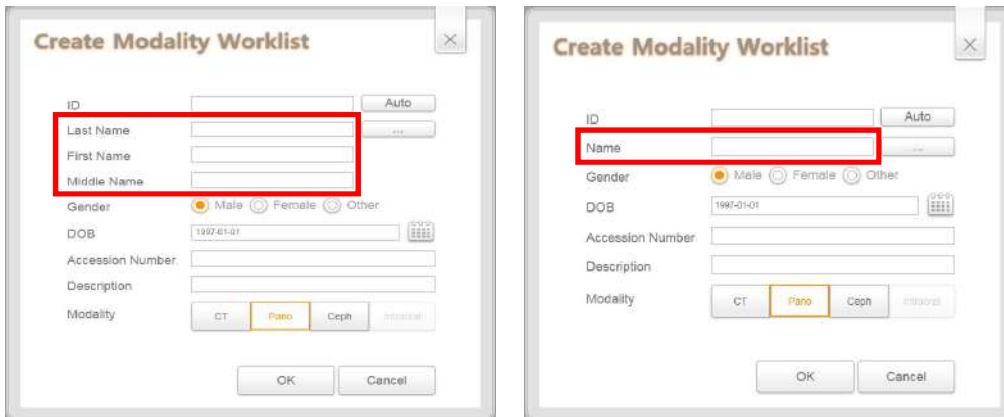

Fig 18 Create Modality Worklist

Patient name displays 2 type, see below figure.



Contents

Item	Description
ID	Input Criteria: Fewer than 20 characters, English·Numeric·Chinese Characters·Japanese/Special Characters “-” (hyphen), “.” (period) characters are available for input.

[Auto]	<p>Patient ID Auto Create</p> <p>Click to create patient ID according to the following auto-create rules.</p> <p>Auto Create Format: PID<Current Year(4 digit)>-<Five Digit Number></p> <p>(Example: PID2011-00001)</p>
Name	<p>Input Criteria: Fewer than 50 characters, English·Numeric·Chinese Characters·Japanese/Special Characters “-” (hyphen), “.” (period), “,” (comma), blank characters are available for input. Enter part of the patient’s name and press the [Enter] key, after which the Search Patient pop-up screen will appear.</p>
[...]	<p>Patient name search</p> <p>Select the name of the patient from the Patient Name list that appears in the Search Patient pop-up screen. When you select a patient name from the list, the patient’s information will be filled in automatically.</p>
Gender	<p>Type: Male (Default), Female, Other (Example: Emergency)</p>
DOB	<p>Insert correct date of birth. (Patients aged 9 and below are categorized as children.)</p>
[Calendar]	<p>Click to display calendar for date selection. Following date selection calendar disappears automatically and selected date is displayed in the text box.</p>
Accession Number	<p>Input Criteria: Fewer than 16 characters, English·Numeric·Chinese Characters·Japanese/Special Characters “-” (hyphen), “.” (period) characters are available for input.</p>
Study Description	<p>Input Criteria: Fewer than 64 characters, English·Numeric·Chinese Characters·Japanese/Special Characters “-” (hyphen), “.” (period), blank characters are available for input.</p>
[Modality]	<p>Choose one option only. Selectable choice varies depending on type or device.</p> <p>Type: CT, Pano, Ceph, Intraoral</p>

Button

Item	Description
[OK]	Click to close the pop-up window and create the MWL.
[Cancel]	Click to cancel created MWL process. Close pop-up window and returns to the MWL screen.

6.2.4 MWL Modify

Select MWL and click [Modify] button. Modify Modality worklist window displays as below figure.

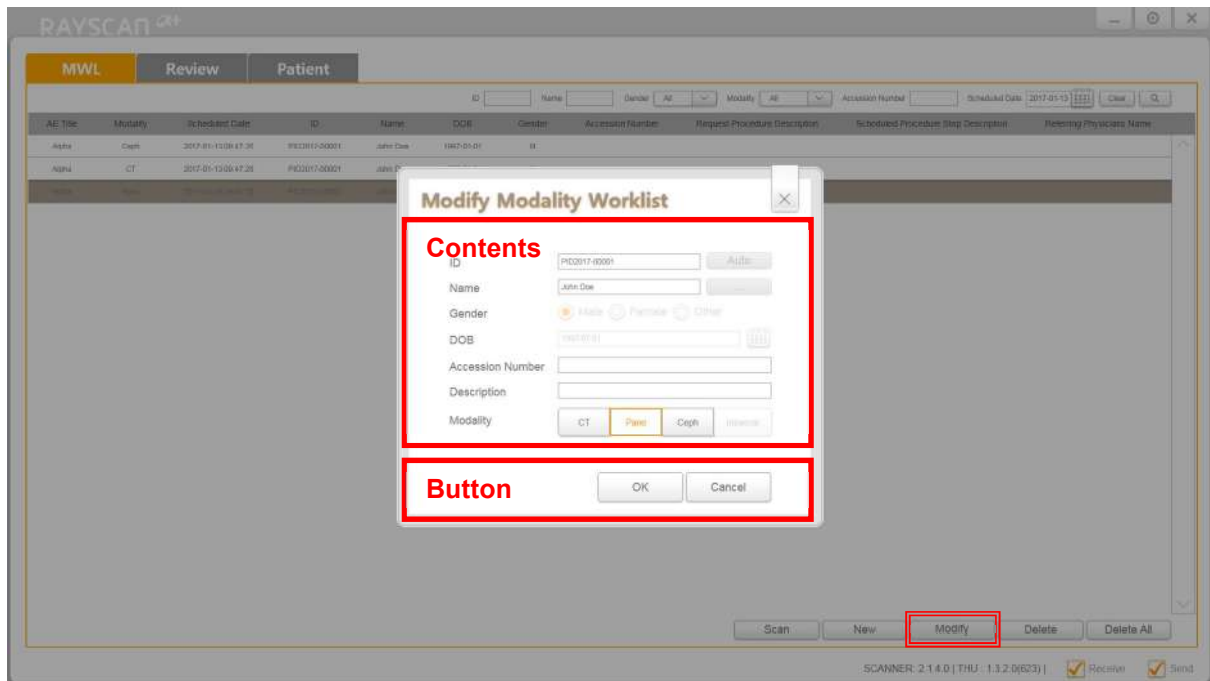
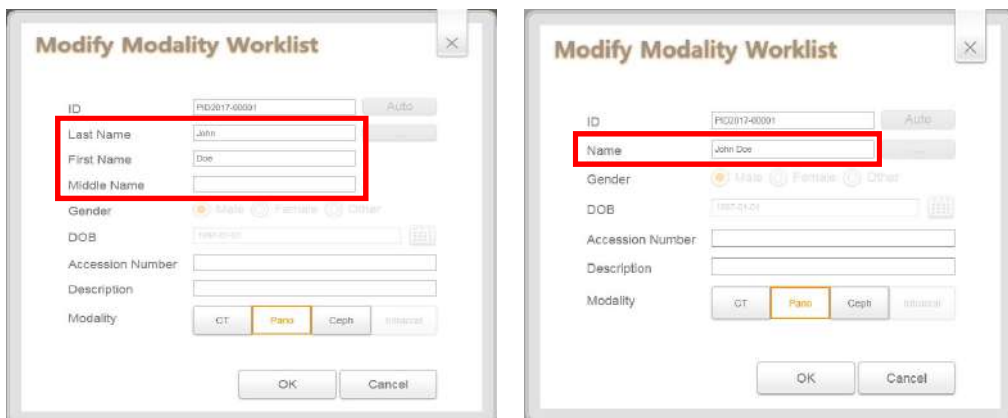

Fig 19 MWL Modify

Patient name displays 2 type, see below figure.



Contents

Item	Description
ID	Modification not permitted.
[Auto]	Patient ID modification is not permitted therefore remains inactive.
Name	Modification not permitted.
Gender	Modification not permitted.
DOB	Modification not permitted.
[Calendar]	Remains inactive.
Accession Number	Input Criteria: Fewer than 16 characters, English·Numeric·Chinese Characters·Japanese/Special Characters “-” (hyphen), “.” (period), “,” (comma), blank characters are available for input.
Study Description	Input Criteria: Fewer than 64 characters, English·Numeric·Chinese Characters·Japanese/Special Characters “-” (hyphen), “.” (period), “,” (comma), blank characters are available for input.
[Modality]	Choose one option only. Selectable choice varies depending on type or device. Type: CT, Pano, Ceph, Intraoral

Button

Item	Description
[Ok]	Click to modify the selected MWL information. Delete Pop-up window is closed and MWL is updated.
[Cancel]	Click to cancel the MWL modify process. Delete Pop-up window is closed and returns to the MWL screen.

6.2.5 MWL Delete

Select MWL and click [Delete] button. Delete window displays as below figure.

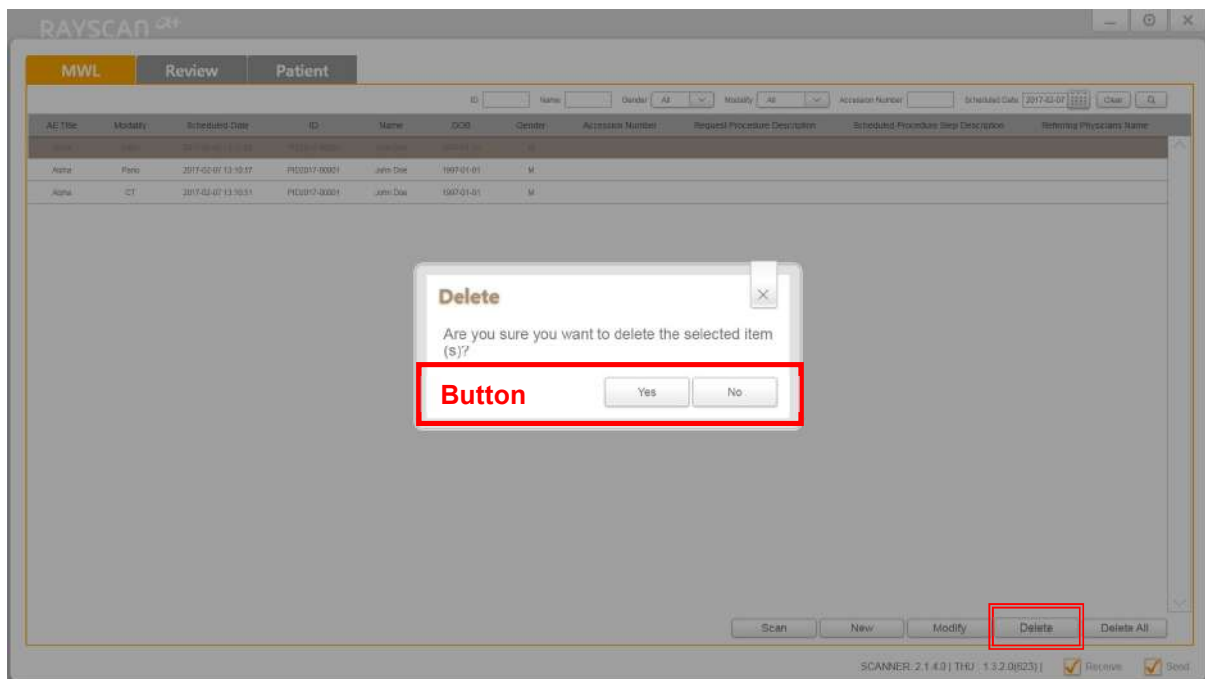

Fig 20 MWL Delete

Button

Item	Description
[Yes]	Click to delete the selected MWL information. Delete pop-up window is closed and MWL is updated.
[No]	Click to cancel the MWL delete process. Delete pop-up window is closed and returns to the MWL screen.

6.2.6 MWL Delete All

Click [Delete All] button. Delete window displays as below figure.

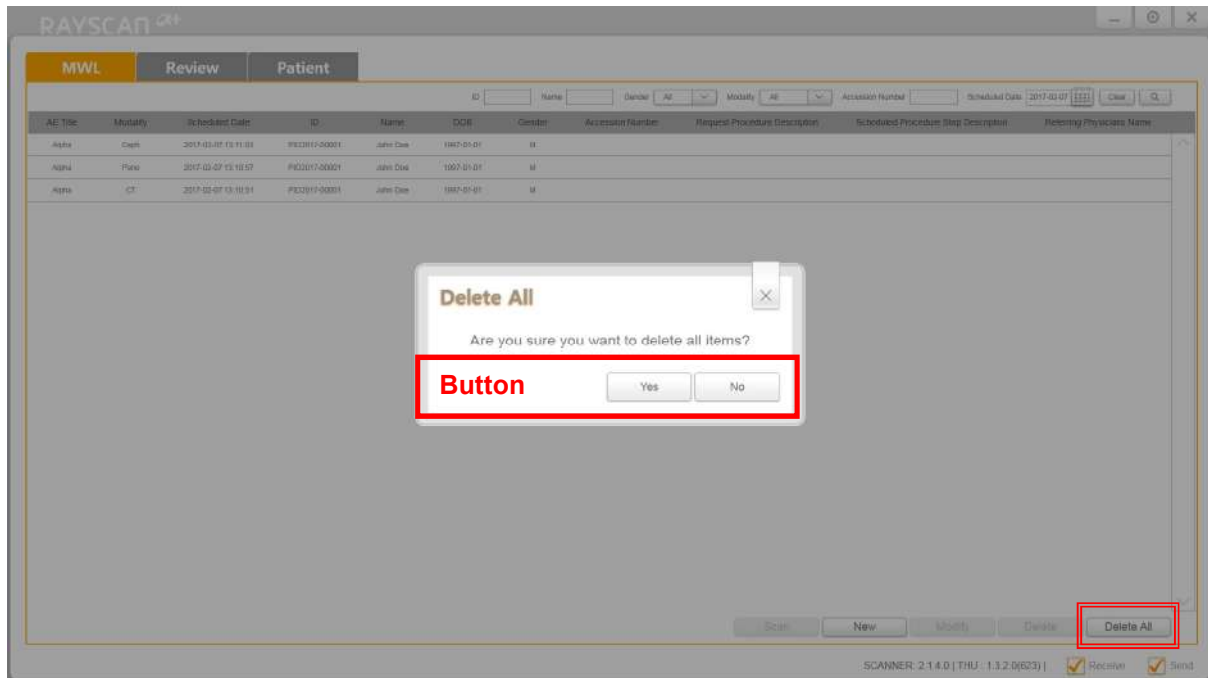

Fig 21 MWL Delete All

Button

Item	Description
[Yes]	Click to delete all the selected MWL information. Delete all pop-up window is closed and delete all requested MWL.
[No]	Click to cancel the MWL delete all process. Delete all pop-up window is closed and returns to the MWL screen.

6.3 Review

6.3.1 Review List

Review tab provides various image management function for completed acquisition. It also supports diverse search option.

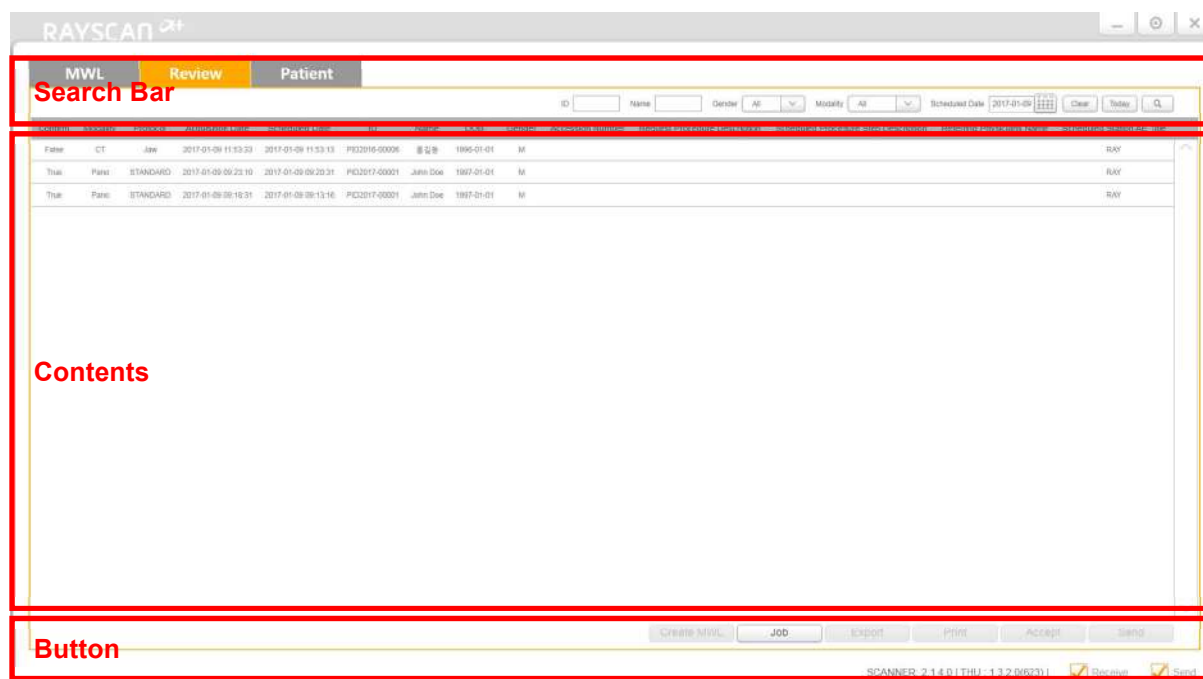

Fig 22 Review List

Search Bar

Item	Description
ID	Input Criteria: Fewer than 20 characters, English·Numeric·Chinese Characters·Japanese/Special Characters “-” (hyphen), “.” (period) characters are available for input.
Name	Input Criteria: Fewer than 50 characters, English·Numeric·Chinese Characters·Japanese/Special Characters “-” (hyphen), “.” (period), “,” (comma), blank characters are available for input. Insert the first letter and click the “Search” button to see a list of words that begin with the selected letter. Enter the name(or first name, middle name, last name) of patient.
Gender	Type: All(default), Male, Female, Other (Example: Emergency)
Scheduled Date	Scanning date (default: today’s date)
[Calendar]	Click to display calendar for date selection. After date is selected the calendar disappears automatically and date is displayed in the text box.

[Clear]	All specified search conditions and list contents are deleted.
[Today]	Searching for patients who registered today. Search for MWL entries displaying today's registration date. Tip: MWL entries registered in the past must be searched by registration date.
[Search]	Searches the Scanning Completed MWL using the specified search condition.

Contents

Item	Description
Confirm	Image Confirm Status
Modality	Type: CT, Pano, Ceph, Intraoral
Protocol	Pano: Standard, TMJ, Sinus, Bitewing, Orthogonal Ceph(One Shot type): Lateral, PA, Carpus, SMV, Waters, Reverse Towne Ceph(Scan type): Lateral, PA, Carpus, Lateral Wide, PA Fast, SMV CT: Jaw, Jaw Fast, Large Jaw, Tooth, Endo, TMJ, Sinus, Airway
Scheduled Date	Scanning date (Default: Today's date)
ID	Patient ID.
Name	Patient name
DOB	Patient birth date
Gender	Type: M (Male), F (Female), O (Other)
Accession Number	Accession number
Requested Procedure Description	Requested procedure description.
Scheduled Procedure Step Description	Scheduled procedure step description.
Referring Physicians Name	Referring physicians name.
Scheduled Station AE Title	Scheduled Station AE Title

Button

[Default: Buttons are inactive.]



[Click the Review List category to activate buttons.]



Item	Description
[Create MWL]	Click to display Create MWL pop-up screen. For detailed description, refer to paragraph 6.3.2 Create MWL.
[Job]	Click to display SCU pop-up screen. For detailed description, refer to paragraph 6.3.3 Job.
[Export]	Click to display Export Image pop-up screen. For detailed description, refer to paragraph 6.3.4 Export.
[Print]	Click to display Print Image pop-up screen. For detailed description, refer to paragraph 6.3.5 Print.
[Accept]	Remains inactive until scanning is completed and MWL is selected. Click to display Confirm Image pop-up screen. For detailed description, refer to paragraph 6.3.6 Accept.
[Send]	Click to show Send DICOM pop-up screen. For detailed description, refer to paragraph 6.3.7 Send.

6.3.2 Create MWL

Click [Create MWL] button to make new MWL. Create Modality Worklist window is as below figure.

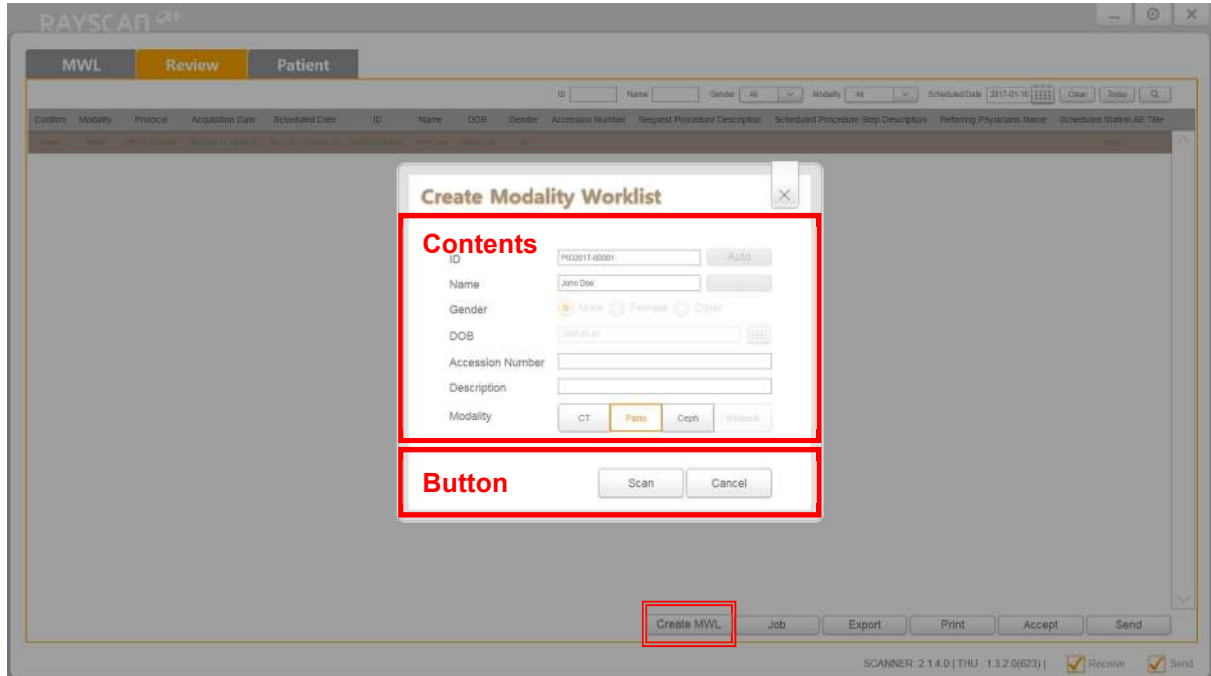
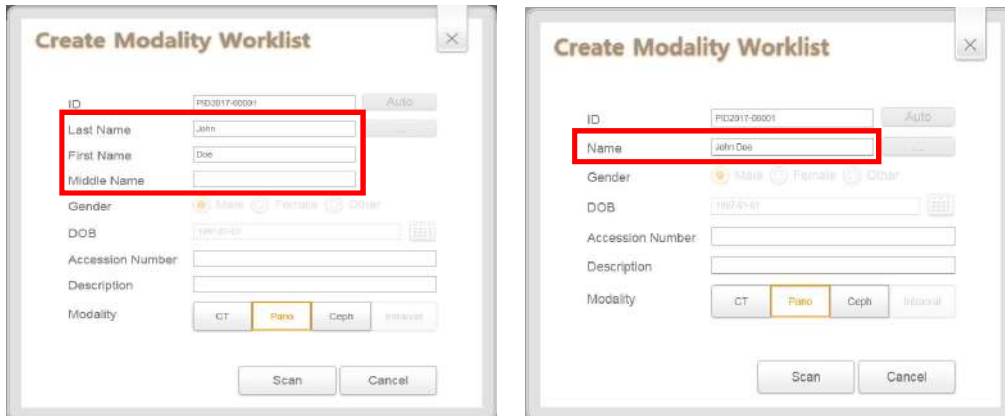

Fig 23 Create MWL

Patient name displays 2 type, see below figure.



Contents

Item	Description
ID	Modification not permitted.
[Auto]	Modification not permitted.
Name	Modification not permitted.
[...]	<p>Patient Name Search</p> <p>Enter the patient's name in the Patient Name field. When the patient's name is selected from the search results list, the patient's information will be filled in automatically.</p>
Gender	Modification not permitted.
DOB	Modification not permitted.
[Calendar]	Modification not permitted.
Accession Number	<p>Input Criteria: Fewer than 16 characters, English·Numeric·Chinese Characters·Japanese/Special Characters "-" (hyphen), "." (period) characters are available for input.</p>
Study Description	<p>Input Criteria: Fewer than 20 characters, English·Numeric·Chinese Characters·Japanese/Special Characters "-" (hyphen), "." (period), blank characters are available for input.</p>
[Modality]	<p>Choose one option only. Selectable choice varies depending on type or device.</p> <p>Type: CT, Pano, Ceph, Intraoral</p>

Button

Item	Description
[Scan]	<p>Scanning button remains inactive until MWL is selected.</p> <p>Click to display Acquisition screen.</p>
[Cancel]	Click to create MWL, return to Review List screen.

6.3.3 Job

Job provides Storage SCU status monitoring and resend functions. Select item on Review tab and click [Job] button on the bottom of window, SCU window displays as below figure.

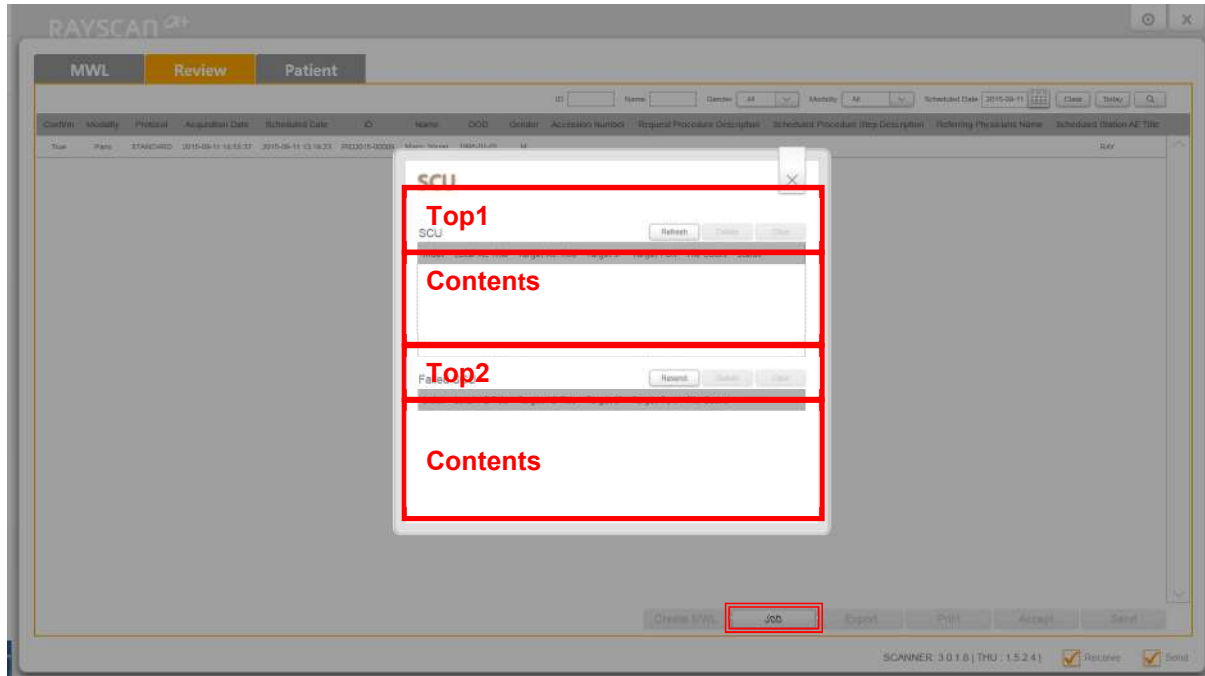

Fig 24 SCU

Top1

Item	Description
[Refresh]	Indicates sending standby status. The list will be deleted after the data is delivered in order.
[Delete]	Delete the selected item.
[Clear]	Delete all items.

Top2

Item	Description
[Resend]	Resend the failed lists.
[Delete]	Delete the selected item.
[Clear]	Delete all items.

Contents

Item	Description
SCU List	Displays the Send Standby and Send in Progress List. When relevant items are delivered in order, they are deleted from the list.
[Refresh]	Updates the SCU/Failed SCU List.
Index	Index
Local AE Title	Current RAYSCANS AE title. Default value is set to Alpha.
Target AE Title	AE title of server set as destination.
Target IP	Target IP address
Target Port	Target port number
File Count	Number of files
Status	Send status
Failed SCU List	Displays a list of failed sends.

6.3.4 Export

Select images on Review tab and click [Export] button on the bottom of window. Export Image window displays as below figure.

Publishing supports to export images with image viewer. CD/DVD and USB provide image exporting with various image formats.

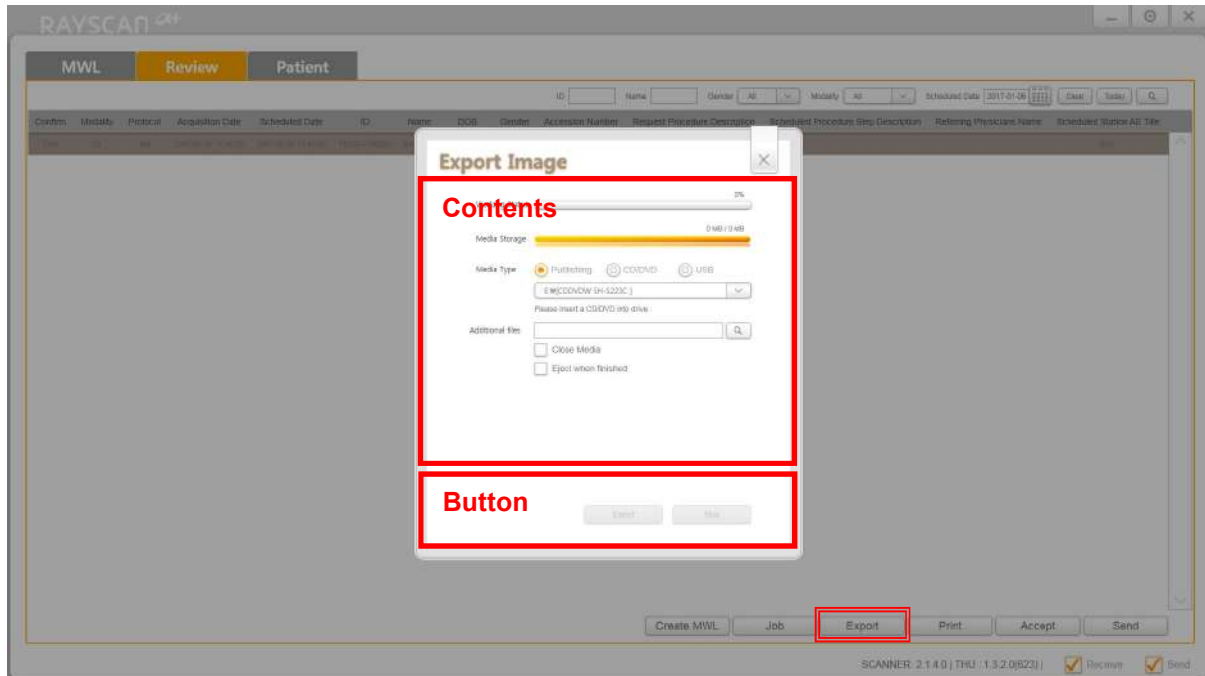

Fig 25 Export to Publishing

Contents

Item	Description
Working Status	Work progress (Unit: %)
Media Storage	Selected media capacity indicator (Unit: MB or GB)
Media Type	Click Publishing to export images with web viewer. (Example: radiology center publishing) It supports CD/DVD and USB.
Addition file(s)	Select a file for adding to the media.
[Close Media]	Following Export completion, close media (writing prohibited) Status (Media Type activates at CD/DVD.)
[Eject when finished]	When Export is finished, ejects the CD automatically. (Media Type activates at CD/DVD.)

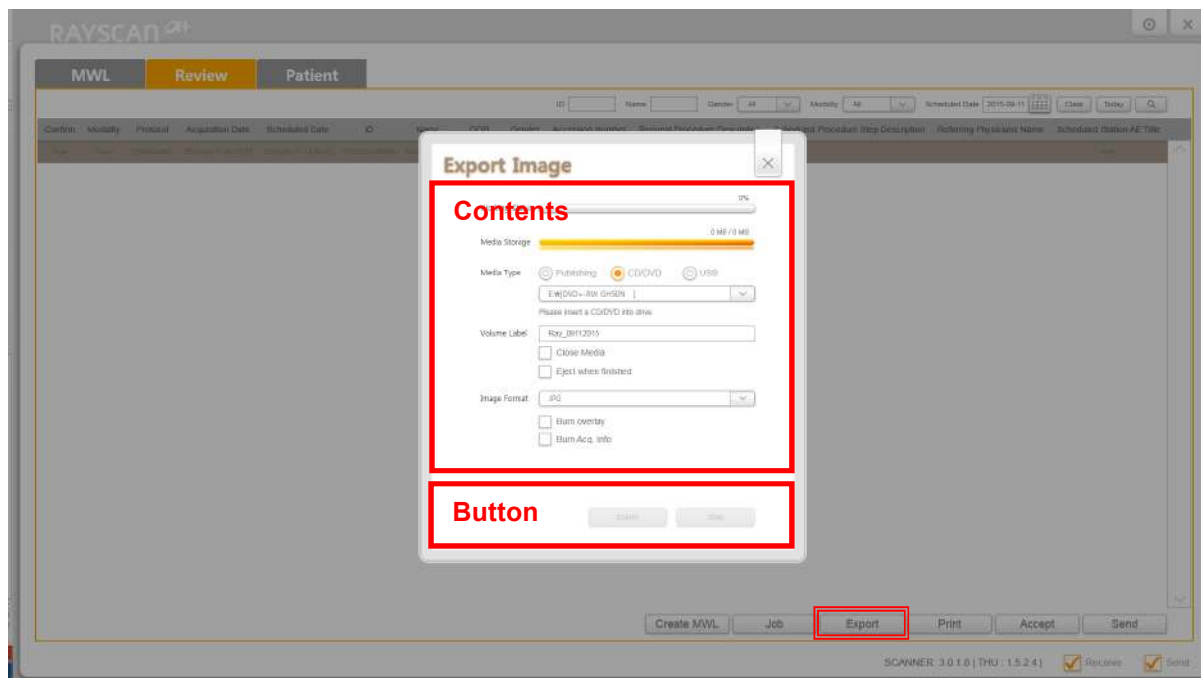

Fig 26 Export to CD/DVD

Contents

Item	Description
Working Status	Work progress (Unit: %)
Media Storage	Selected media capacity indicator (Unit: MB or GB)
Media Type	Click CD/DVD to export images on CD/DVD. Available media list is display on the below.
Volume Label	When Media Type is CD/DVD, the volume label cannot be used repeatedly in the same media. Standard Setting Format: Ray-<Current Year (4 digits)> <Current Month (2 digits)> <Current Date (2 digits)> (Example: Ray-20110930)
[Close Media]	Following Export completion, close media (writing prohibited) Status (Media Type activates at CD/DVD.)
[Eject when finished]	When Export is finished, ejects CD automatically. (Media Type activates at CD/DVD.)
Image Format	Type: DICOM, RAW, JPG
[Burn overlay]	Image measurements (length, angle, etc.) and annotations are ready for export.
[Burn Acq.Info]	Burn patient and scan information in the image then export.

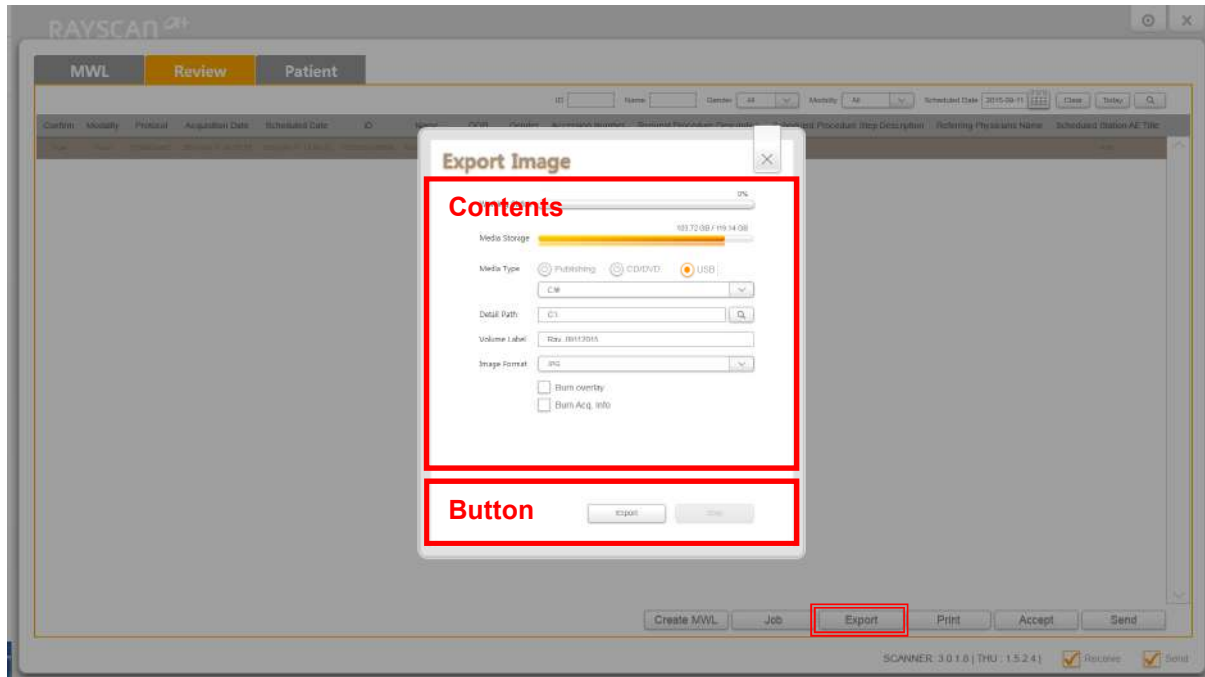

Fig 27 Export to USB

Contents

Item	Description
Working Status	Work progression (Unit: %)
Media Storage	Selected media capacity indicator (Unit: MB or GB)
Media Type	Click USB to export images to USB. It also supports to set detail path.
Detail Path	Select the path.
Volume Label	Standard Setting Format: Ray- <Current Year(4 digits)> <Current Month (2 digits)> <Current Date (2 digits)> (Example: Ray-20110930)
Image Format	Type: DICOM , RAW, JPG
[Burn overlay]	Image measurements (length, angle, etc.) and annotations are ready for export.
[Burn Acq.Info]	Burn patient and scan information in the image then export.

Button



[Export abled status]

[During Export – Stop abled status]

Item	Description
[Export]	Click to start export.
[Stop]	Click to stop export process.

6.3.5 Print

6.3.5.1 DICOM Printer

Select image on Review tab and click [Print] button on the bottom of window. In case of DICOM printer, Print Image window displays as below figure.

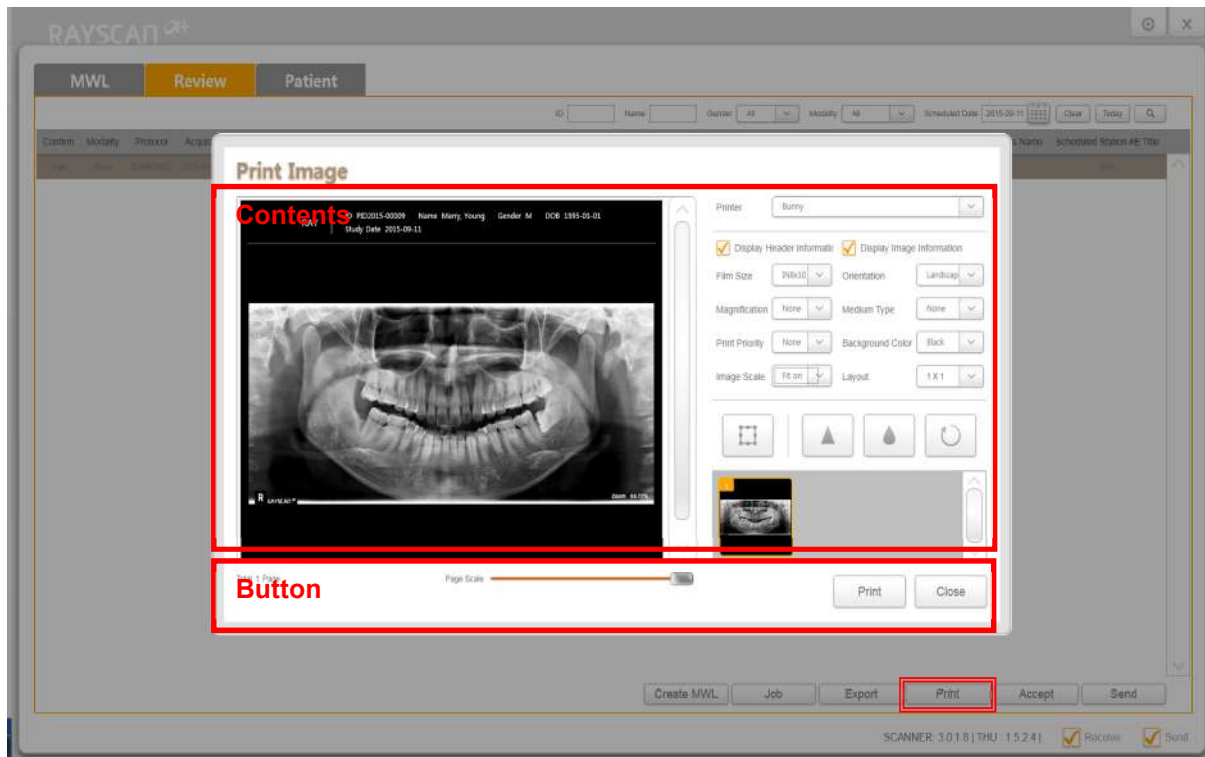

Fig 28 DICOM Print Window

Contents

Item	Description
DICOM Printer	Displays the available DICOM printer list. This item can be modified in the Config Editor.
Film Info.	
Film Size	Type: None, IN8x10, IN8_5x10, IN10x12, IN10x14, IN11x14, IN11x17, IN14x14, IN14x17, CM24x24, CM24x30
Orientation	Type: Portrait, Landscape
Magnification	Type: None, Replicate, Bilinear, Cubic
Medium Type	Type: None, Paper, Clear Film, Blue Film, Mammo Clear Film, Mammo Blue Film
Print Priority	Type: None, High, Medium, Low
Background	Type: Black, White
Image Scale	Fit on, 10-200%

Layout	Select from minimum 1x1 to maximum 7x7 Default setting: 3x3
--------	--

Button

Item	Description
[Page Scale] Slide	Page magnification
[Print]	Print start
[Close]	Return to previous window.

6.3.5.2 Paper Printer

Select image on Review tab and click [Print] button on the bottom of window. In case of general printer, Print Image window displays as below figure.

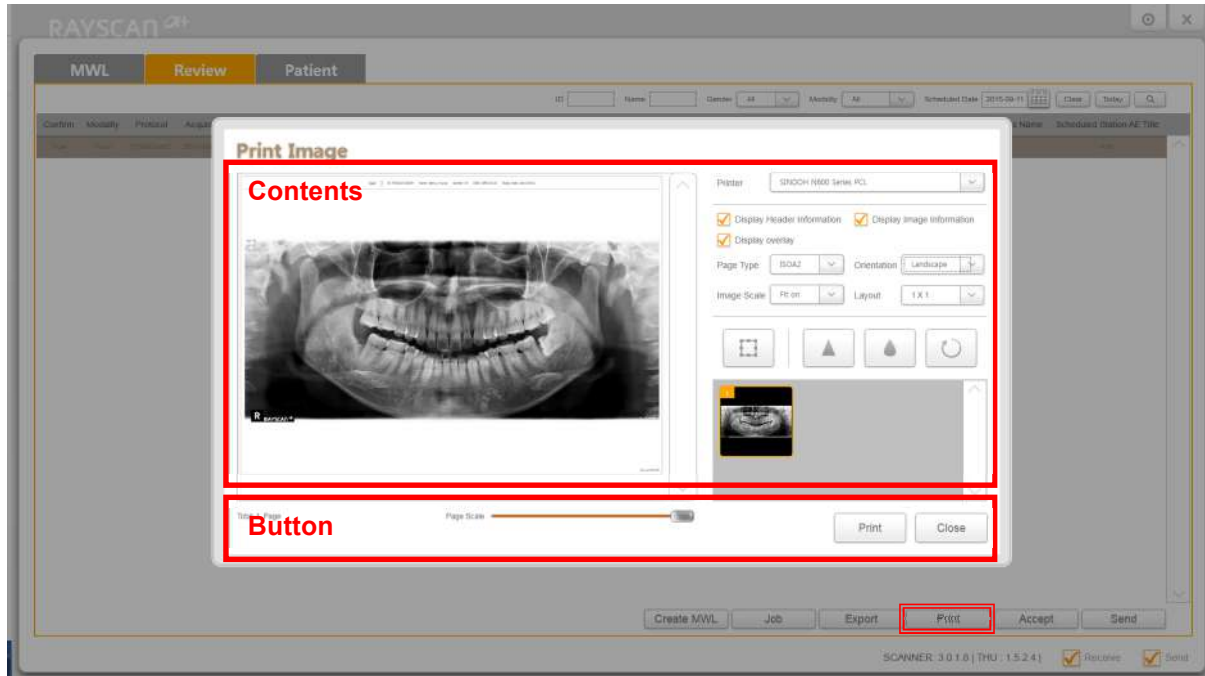

Fig 29 Paper Print Window

Contents

Item	Description
Printer	Displays the available normal printer and DICOM printer list. This item can be modified to Config Editor.
Page Type	Type: ISOA2, ISOA3, ISOA4, ISOA5, ISOA6, JISB4, JISB5, JISB6
Page Orientation	Type: Portrait, Landscape
Page Info.	Image Scale Fit on, 10~200 %
	Layout Select from minimum 1x1 to maximum 7x7 Basically set to 3x3

Button

Item	Description
[Page Scale] Slide	Page magnification
[Print]	Print start
[Close]	Return to the previous window

6.3.6 Accept

Select item and click [Accept] for changing image status to [Confirm] or [Reject] buttons. Confirm Image windows as below figure.

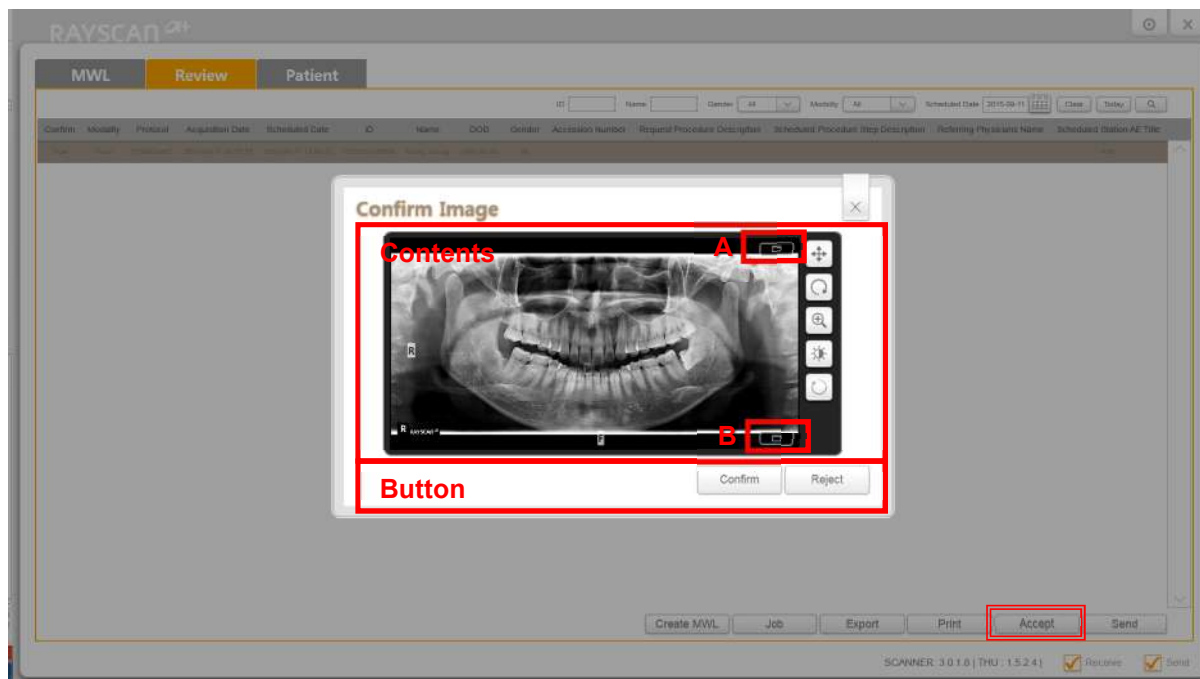

Fig 30 Confirm Image

Contents

Item	Description
A	Click the [A] button to open the ID, Name, Birthday and Scan protocol information.
B	Click the [B] button to open the Radiation exposure, Window center, Window Width, Zoom Ratio and Length Unit information.
[Move]	Click to select the image for movement. Cursor will change when the mouse pointer is positioned over the image. Image is moved by pressing the left mouse button down and moving the mouse.
[Rotate]	Click to rotate image. Cursor will change when mouse pointer is positioned over the image. With left mouse button pressed down, move the mouse. Image will rotate in the direction of mouse movement.
[Zoom]	Click to enlarge/shrink image. Cursor will change when mouse pointer is positioned over the image. With left mouse button pressed down, move mouse toward right side of image to shrink, left side to enlarge.

[Windowing]



Click to adjust image windowing.
 Cursor will change when mouse pointer is positioned over the image.
 With left mouse button pressed down, move higher to decrease the windowing value and move lower to increase the windowing value.

[Back]



Ongoing process is cancelled when clicked.

Button

Item	Description
[Confirm]	Confirm patient image.
[Reject]	Reject patient image.

Note SMARTDent only shows the confirmed images.

6.3.7 Send

Select item and click [Send] button when it did not send to PACS server.

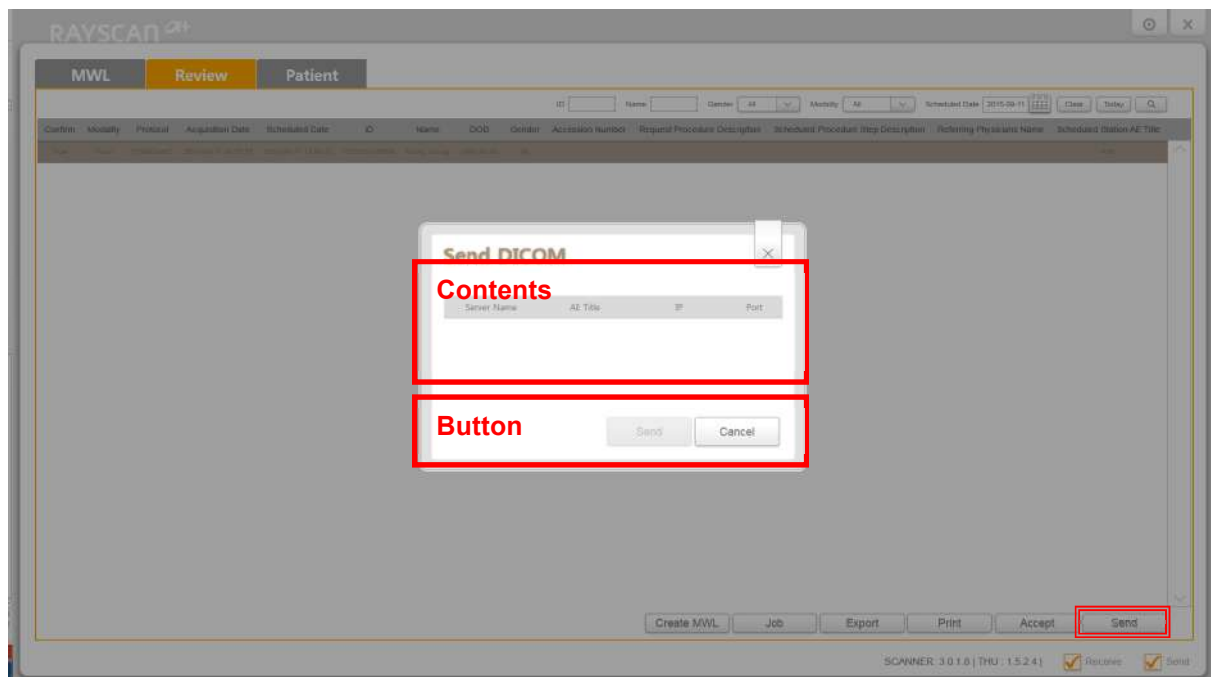

Fig 31 Send DICOM

Contents

Item	Description
Server Name	Name of the server
AE Title	SCP server to transmit AE Title.
IP	SCP server to transmit IP address.
Port	SCP server to transmit Port number.

Button



[No selected items]

[Send abled status]

Item	Description
[Send]	Send image to selected server.
[Cancel]	Cancel image send and close window.

6.4 Patient Management

6.4.1 Patient List

The Patient Information List screen (which appears when the Patient Tab from the Scanner S/W Main is selected), displays both the list of patients not having completed the scanning in MWL tab and the scanning completed patient list from the review tab.

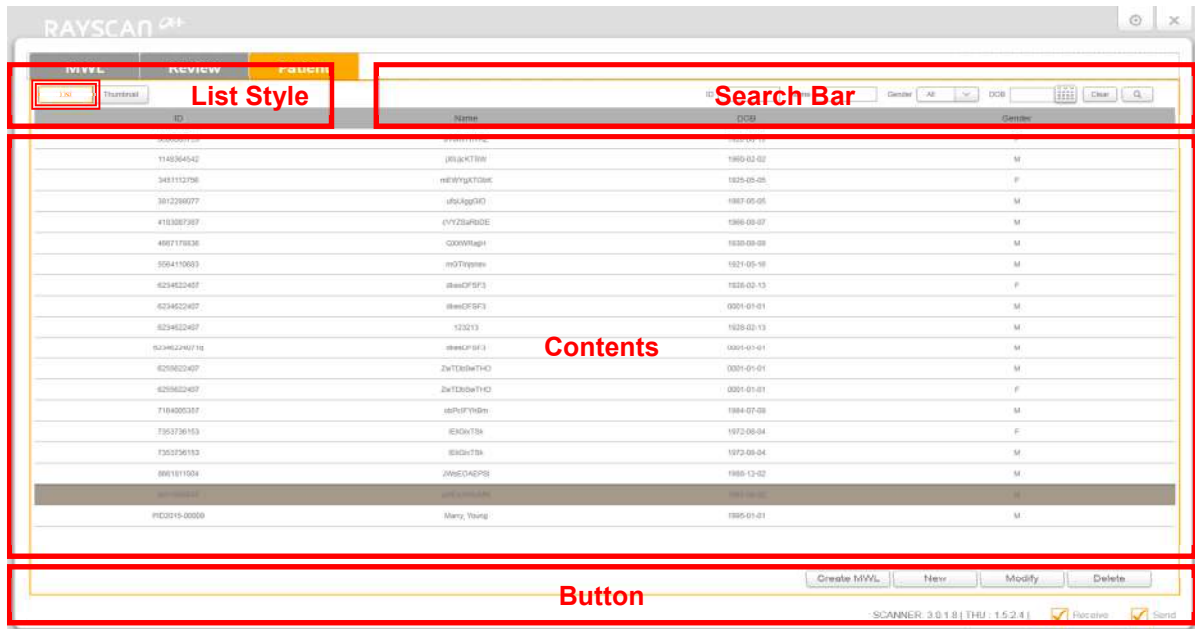

Fig 32 Patient List

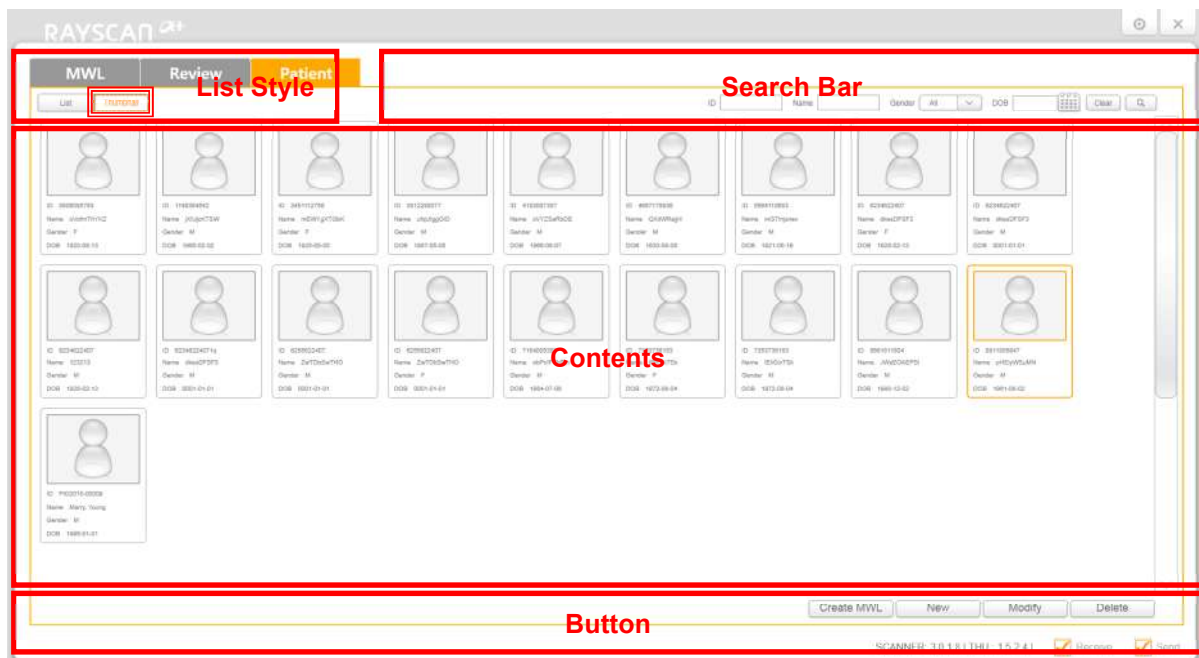

Fig 33 Patient Thumbnail List

List Style

Item	Description
[List]	Displays patient information in list format.
[Thumbnail]	Displays patient information in thumbnail format.

Search Bar

Item	Description
ID	Input Criteria: Fewer than 20 characters, English·Numeric·Chinese Characters·Japanese/Special Characters “-” (hyphen), “.” (period) characters are available for input.
Name	Input Criteria: Fewer than 50 characters, English·Numeric·Chinese Characters·Japanese/Special Characters “-” (hyphen), “.” (period), “,” (comma), blank characters are available for input. Enter the name(or first name, middle name, last name) of patient.
Gender	Type: All(default), Male, Female, Other
DOB	Date of birth
[Clear]	Clear the selected search condition and refresh the selection.
[Search]	Search the lists with the selected condition.

Contents

Item	Description
ID	Patient ID.
Name	Patient name
Gender	Type: M (Male), F (Female), O (Other)
DOB	Date of birth
Portrait	Show the patient's picture. If patient's picture is not in the system, standard image will be displayed.

Button

Item	Description
[Create MWL]	Click to display Create MWL pop-up screen. For detailed description, refer to paragraph 6.3.2 Create MWL
[New]	Patient information add button. For detailed description, refer to paragraph 6.4.2 New
[Modify]	Patient information modify button. For detailed description, refer to paragraph 6.4.3 Modify
[Delete]	Patient information delete button For detailed description, refer to paragraph 6.4.5 Delete

6.4.2 New Patient Registration

Click [New] button on Patient tab to create new patient as below figure.

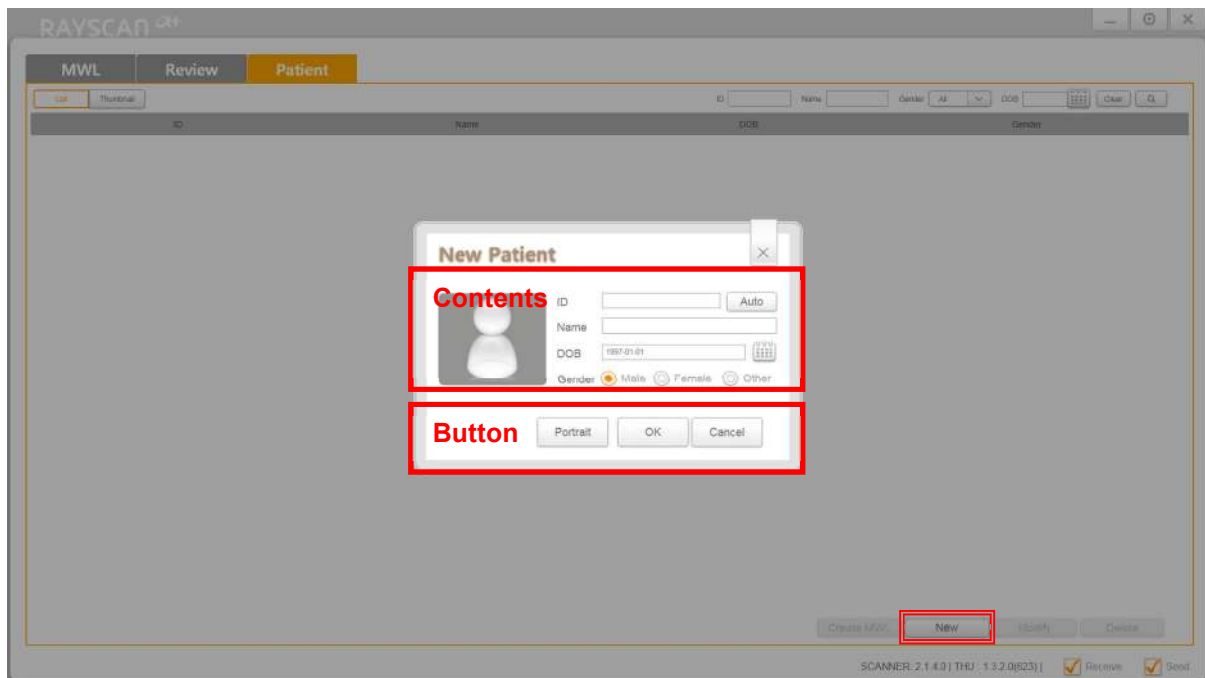
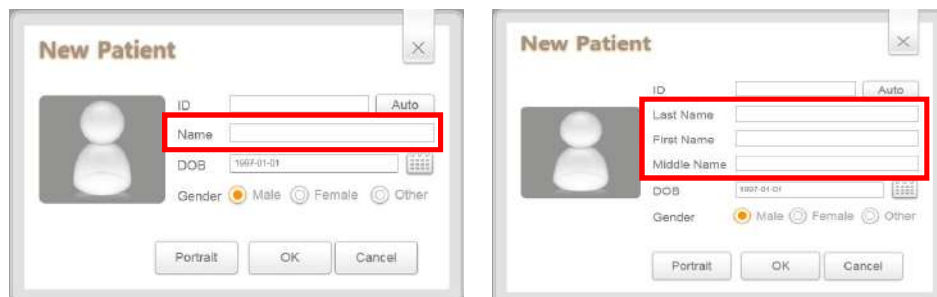

Fig 34 New Patient Registration

Patient name displays 2 type, see below figure.



Contents

Item	Description
ID	Input Criteria: Fewer than 20 characters, English·Numeric·Chinese Characters·Japanese/Special Characters “-” (hyphen), “.” (period) characters are available for input.
[Auto]	Patient ID Auto Create Click to create patient ID according to the following auto-create rules. Format: PID<Current Year(4 digits)>-<Five Digit Number>. (Example: PID2011-00001)
Name	Input Criteria: Fewer than 50 characters, English·Numeric·Chinese Characters·Japanese/Special Characters “-” (hyphen), “.” (period), “,” (comma), blank characters are available for input.
DOB	Date of Birth (Patients under the age of 9 are categorized as children.)
Gender	Type: Male(default), Female, Other
[Calendar]	Calendar display button

Button

Item	Description
[Portrait]	Register a picture of the patient.
[OK]	Save the registered patient information.
[Cancel]	Close the window without saving.

6.4.3 Patient Information Modify

Select patient list and click [Modify] to change the patient information as below figure.

Note

It takes for a while when images are registered to the patient. Alert message will be displayed as Fig 36.

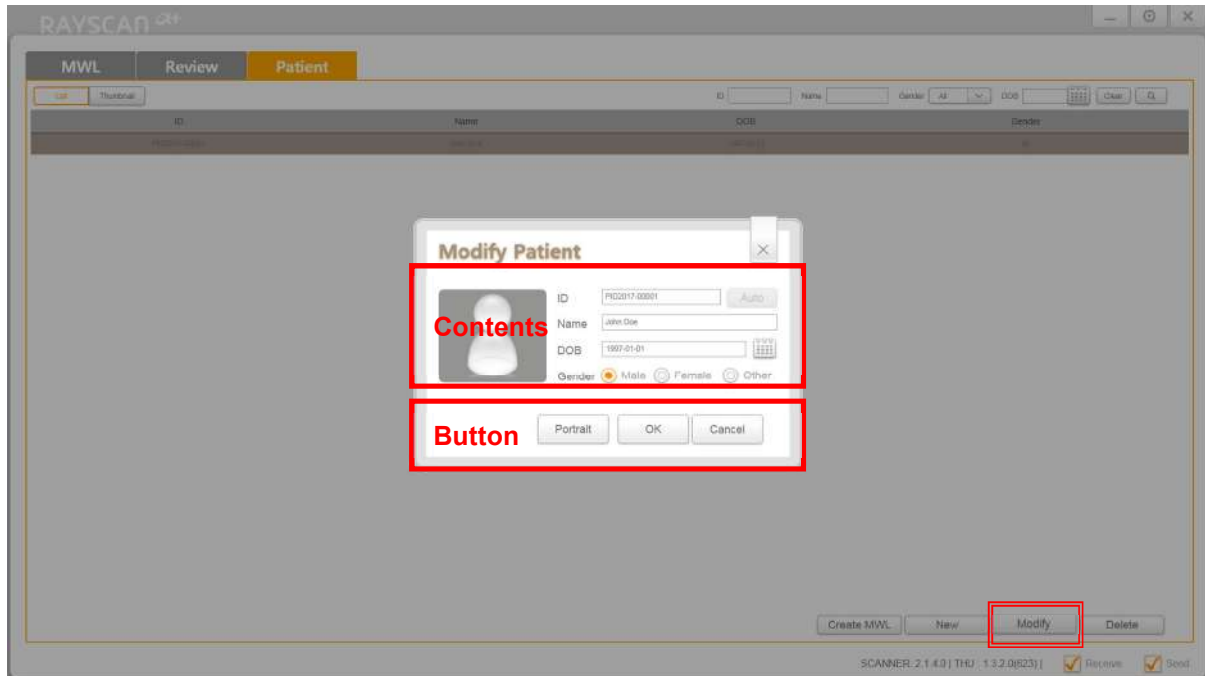

Fig 35 Modify Patient

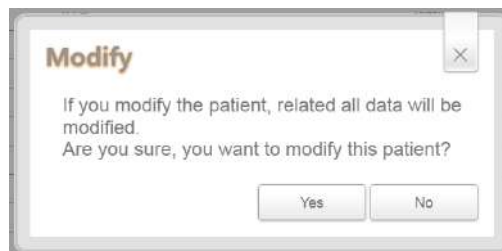
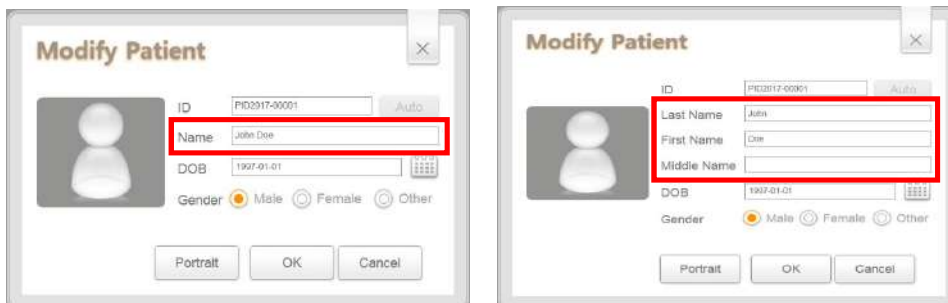

Fig 36 Modify Alert

Patient name displays 2 type, see below figure.



Contents

Item	Description
ID	Modification not permitted.
[Auto]	Patient ID modification is not permitted. Button remains inactive.
Name	Input Criteria: Fewer than 50 characters, English·Numeric·Chinese Characters·Japanese/Special Characters “-” (hyphen), “.” (period), “,” (comma), blank characters are available for input.
DOB	Date of Birth
Gender	Type: Male(default), Female, Other (Example: Emergency)
[Calendar]	Calendar display button

Button

Item	Description
[Portrait]	Properties of patient image.
[OK]	Save the registered patient information.
[Cancel]	Close the window without saving.

6.4.4 Patient Photo Registration

Click [Portrait] button on the Patient Registration or Modification window. Patient Photo Registration Window as below figure.

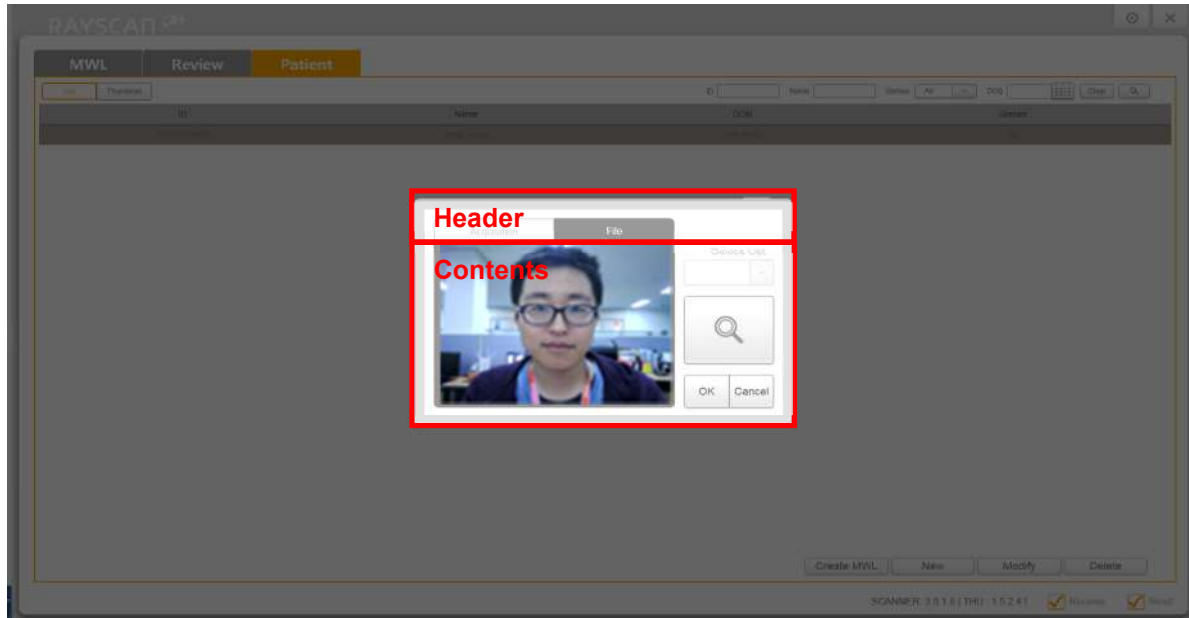

Fig 37 Patient Photo Registration Window

Header

Item	Description
Acquisition	Acquire image using system webcam.
File	Load the photo file on PC.

Contents

Item	Description
[Acquisition]	Take photo with webcam.
[File]	Store the photo file on PC.
Image View	View webcam screen or photo.
Device	Select among webcam devices. (Optional)
[Capture/Open]	Capture current window in acquisition mode. In file mode, recall images using file explorer.
[OK]	Click to close the patient photo registration screen and return to the previous screen.
[Cancel]	Click when registration of patient photo is cancelled and return to the previous screen.

6.4.5 Patient Delete

Screen displayed when [Delete] button is clicked following patient selection in the Patient List screen. From here, patients on the Patient List can be deleted.



You should be careful to delete patient. Image restore is impossible.

Caution

Click to [Delete] button. System will ask for a password.

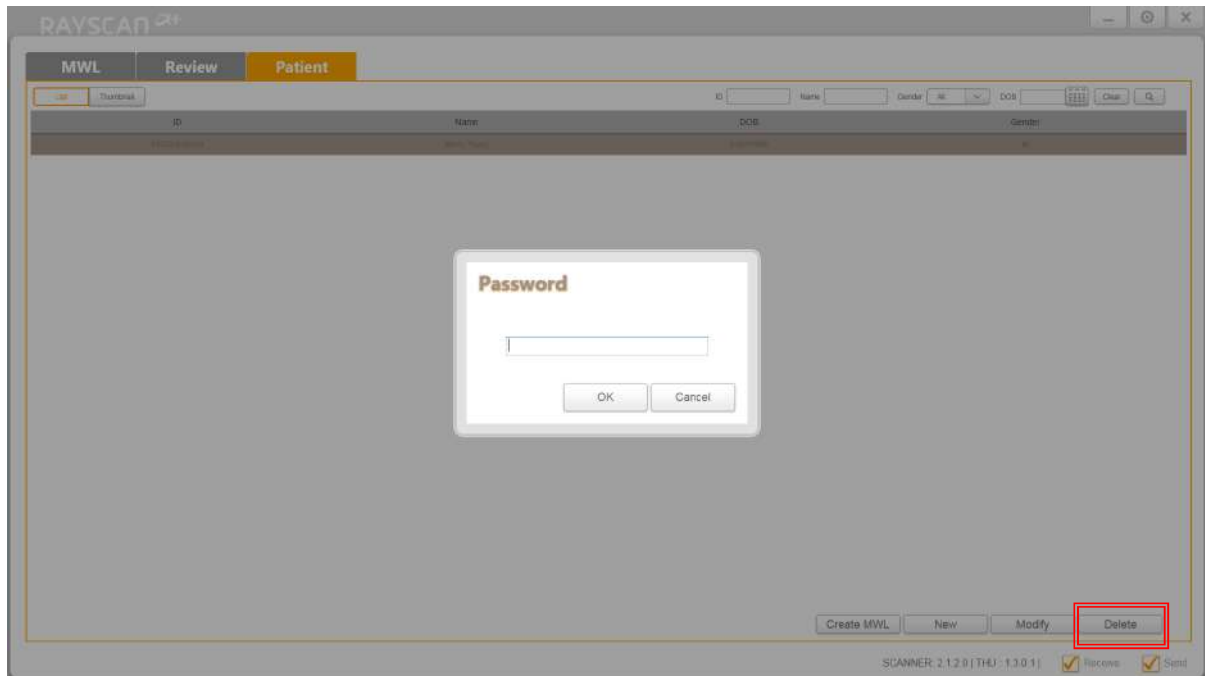

Fig 38 Patient Delete Password

Note

When you forget the password, please contact your representative for the password.

Below is the screen that appears after the correct password is supplied and Patient Information is deleted.

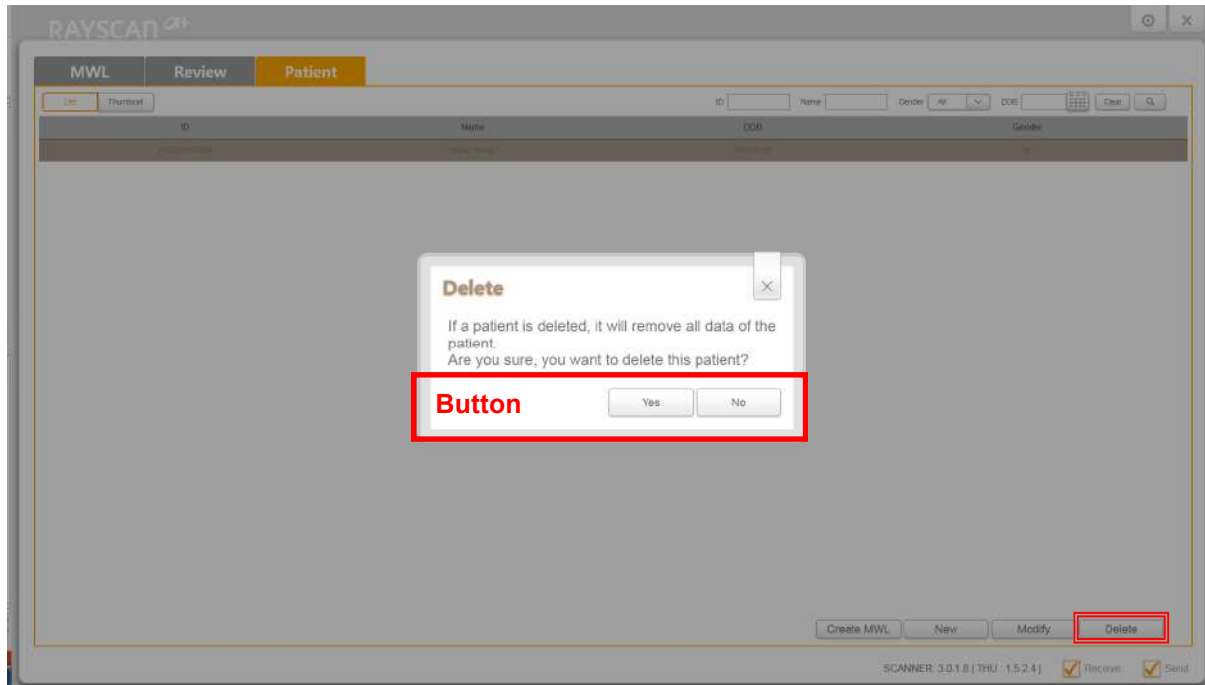

Fig 39 Patient Delete

Button

Item	Description
[Yes]	Delete all patient images and information. After delete, close the window and return to the Patient tab.
[No]	Close the window and return to the Patient tab.

6.5 Touch Monitor

6.5.1 Splash screen

The Splash screen is the touch Monitor standby screen that changes to the Setup screen when touched by a user. When a scanning sequence is received from the Scanner, the Splash screen proceeds to the scanning screen.

The image shows the word "RAYSCAN" in a large, light gray, sans-serif font. The letters are slightly shadowed, giving them a 3D appearance as if they are floating or resting on a surface. The font is clean and modern.

Fig 40 Splash screen

6.5.2 System Operation

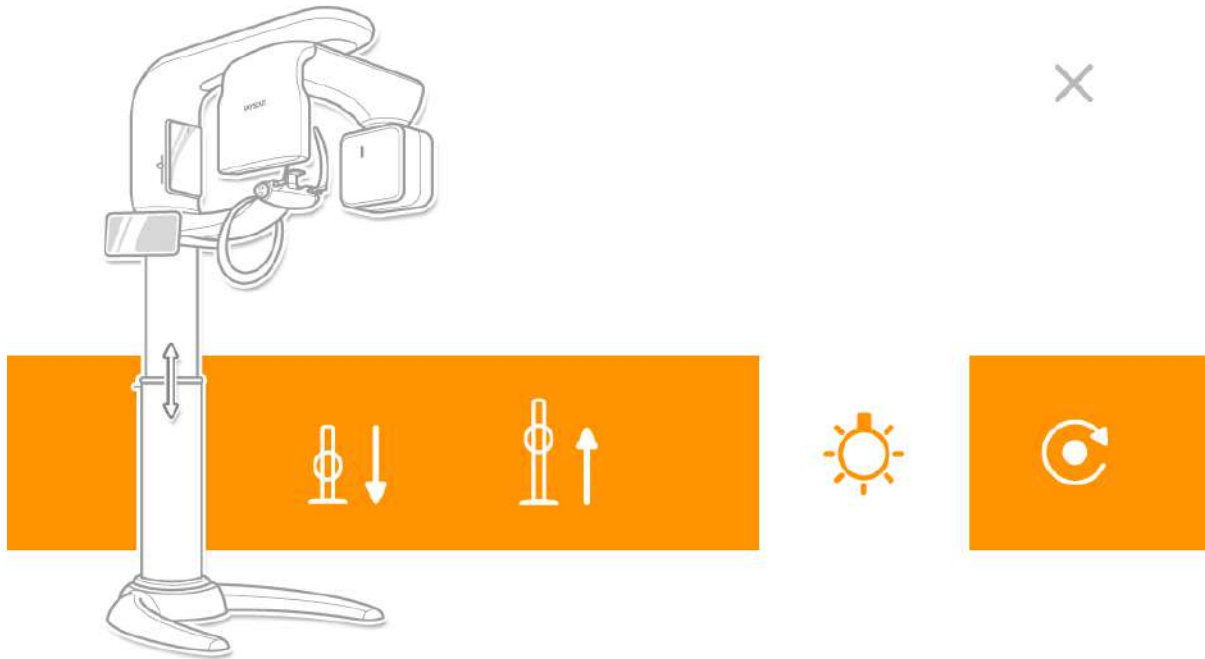







Fig 41 System Operation

Item	Description
[X]	Touch to close Setup screen and return to Splash screen.
[Down] 	Equipment Lift Column lower button Equipment is lowered when user maintains touch on the [Down] button.
[Up] 	Equipment Lift Column raise button Equipment is raised when user maintains touch on the [Up] button.
[Home] 	Equipment initialization button Touch to initialize the equipment.
[Lamp]	Alignment Beam ON/OFF button Touch to turn the alignment beam OFF (when turned on) and ON (when turned off). Turns Off automatically after a specified time.
	ON  OFF 

6.5.3 Acquisition

Screens displayed when [Scan] button is clicked.

6.5.3.1 Patient Information

Before starting image acquisition, Patient Info window appears as below figure.

Please confirm the patient information.

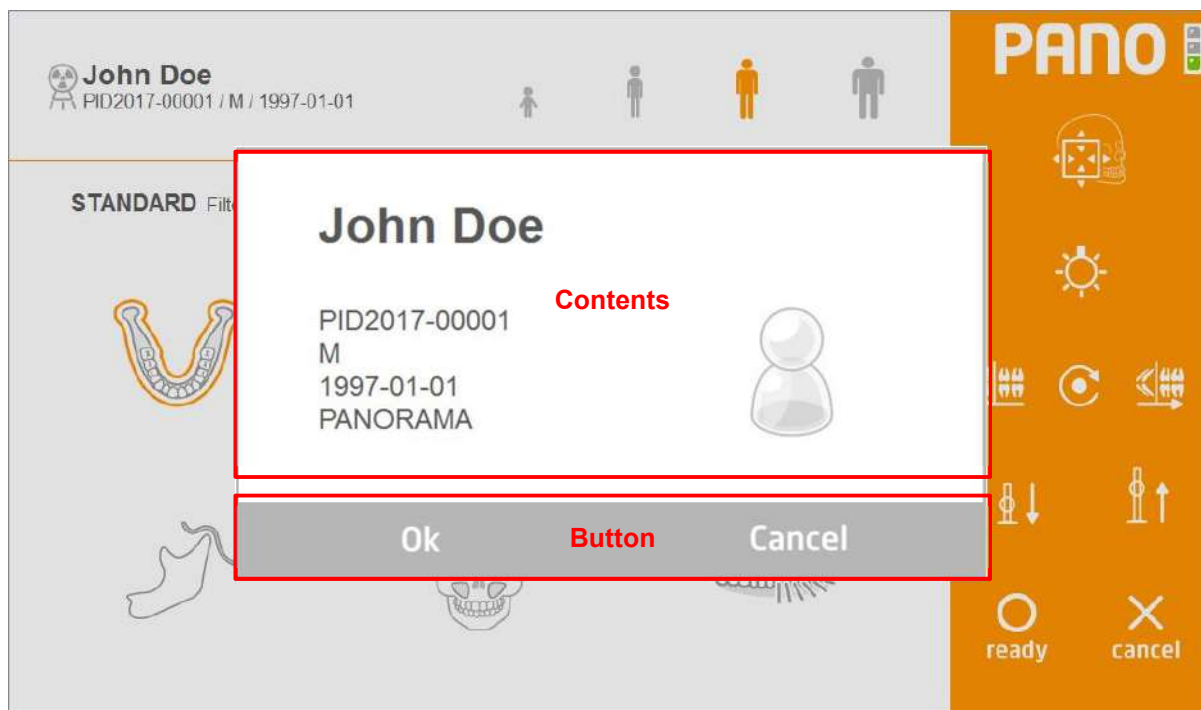

Fig 42 Patient Information

Contents

Item	Description
Portrait	Shows the patient photo when a patient photo is registered. When the photo is not registered, displays default image.
ID	Patient ID.
Name	Patient name
Gender	Type: M (Male), F (Female), O (Other)
Birth Date	Patient birth date
Modality	Type: CT, Pano, Ceph, Intraoral

Button

Item	Description
[OK]	Confirm patient information and click if correct. Touch to close Patient Information screen and display the scanning screen.
[Cancel]	Touch if Patient Information is incorrect or procedure is cancelled. Touch to cancel scanning, close Patient Information screen and scanning screen, and return to Splash screen.

6.5.3.2 Panoramic Acquisition

Panoramic scanning setup screen.

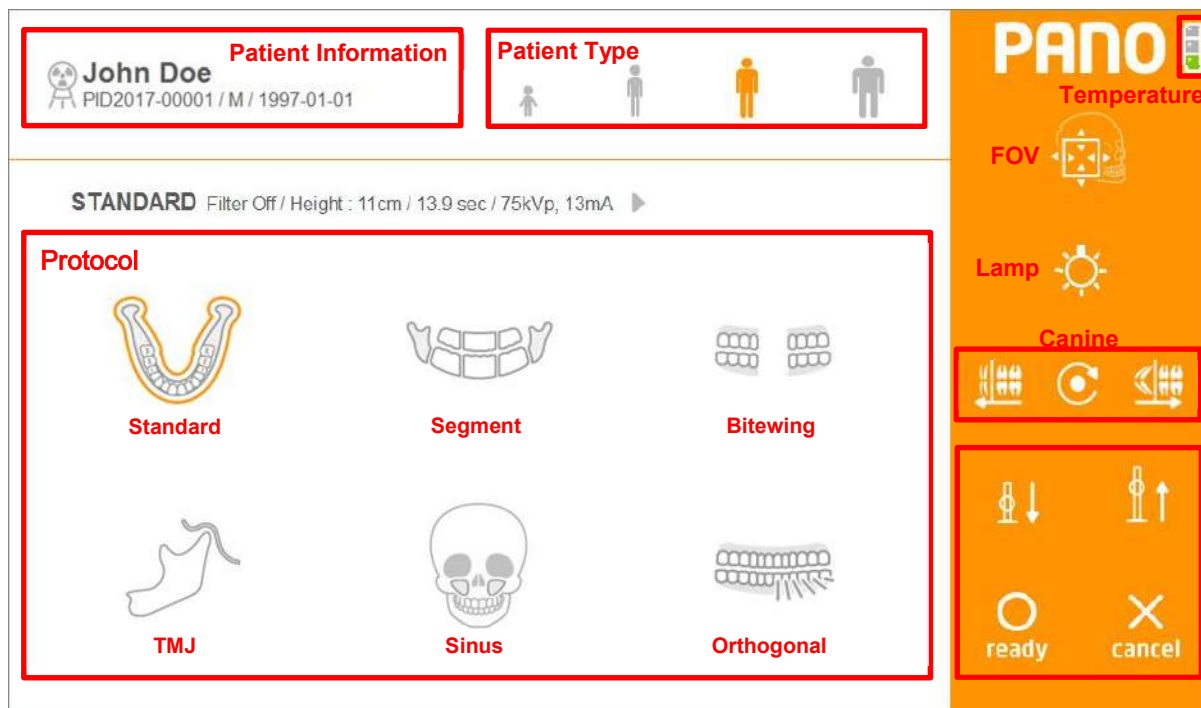

Fig 43 Acquisition: Panoramic

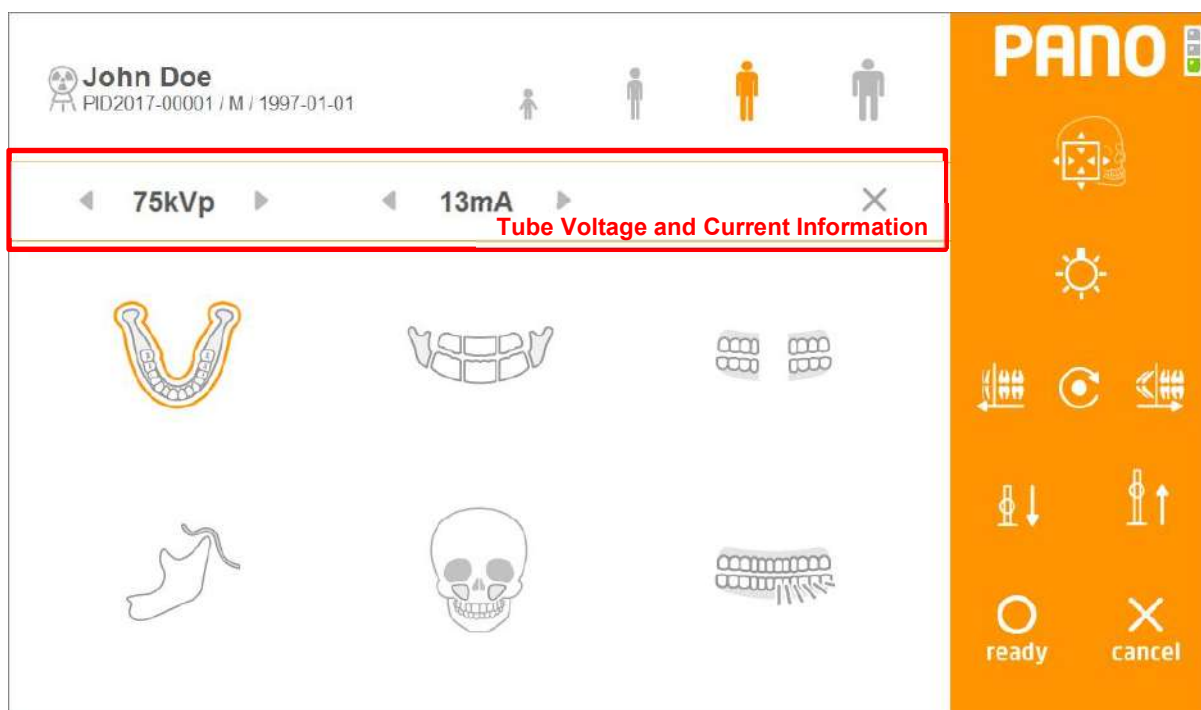

Fig 44 Exposure Condition Adjustment



Patient Information

Item	Description
Name	Patient name
ID	Patient ID.
Gender	Type: M (Male), F (Female), O (Other)
Birth Date	Patient birth date

Patient Type

Item	Description
[Child]	Child build
[Small adult]	Small adult build
[Adult]	Adult build
[Large adult]	Large adult build

Canine Position (Pano)

Item	Description
[Left] 	Move canine beam forward. Modify canine beam by moving rotator forward.
[Center] 	Move canine beam to the center position. Modify canine beam by moving rotator to the center position.
[Right] 	Move canine beam backward. Modify canine beam by moving the rotator backward.







Tube Voltage and Tube Current

Item	Description
◀	Decrease kVp button. The number decreases by 1 kVp on click.
Tube Voltage (kVp)	Display the voltage kVp setting.
▶	Increase kVp button. The number increases by 1 kVp on click.
◀	Decrease mA button. The number decreases by 1 mA on click.
Tube Current (mA)	Display the current mA setting.
▶	Increase mA button. The number increases by 1 mA on click.

Protocol

Item	Description
[Standard]	Select Standard protocol.
[Segment]	Select Segmentation protocol.
[TMJ]	Select TMJ protocol.
[Sinus]	Select Sinus protocol.
[Bitewing]	Select Bitewing protocol.
[Orthogonal]	Select Orthogonal protocol.

Command

Item	Description
<p>[Lamp]</p>	<p>Alignment beam On/Off button. When clicked, turns the alignment beam OFF (if turned on) and ON (if turned off).</p> <p style="text-align: center;"> ON  OFF  </p>
<p>[Down]</p> 	<p>Equipment Lift Column height lower button. Equipment is lowered when user maintains touch on the [Down] button.</p>
<p>[Up]</p> 	<p>Equipment Lift Column height raise button. Equipment is raised when user maintains touch on the [Up] button.</p>
<p>[ready]</p> 	<p>When clicked, system moves to the starting position for scanning.</p>
<p>[cancel]</p> 	<p>Touch to cancel scanning, close scanning screen and return to the Splash screen. Click after [ready] button is touched to cancel the scanning preparation process.</p>

FOV Mode (Panorama)

The ROI (Region Of Interest) can be adjusted as needed for diagnosis on FOV Mode. Each modality provides different active areas. Use arrow buttons on THU and/or the remote controller to adjust. By limiting the radiation area as users' needs, the real Low Dose is realized.

※ The remote control is not provided in Canada.

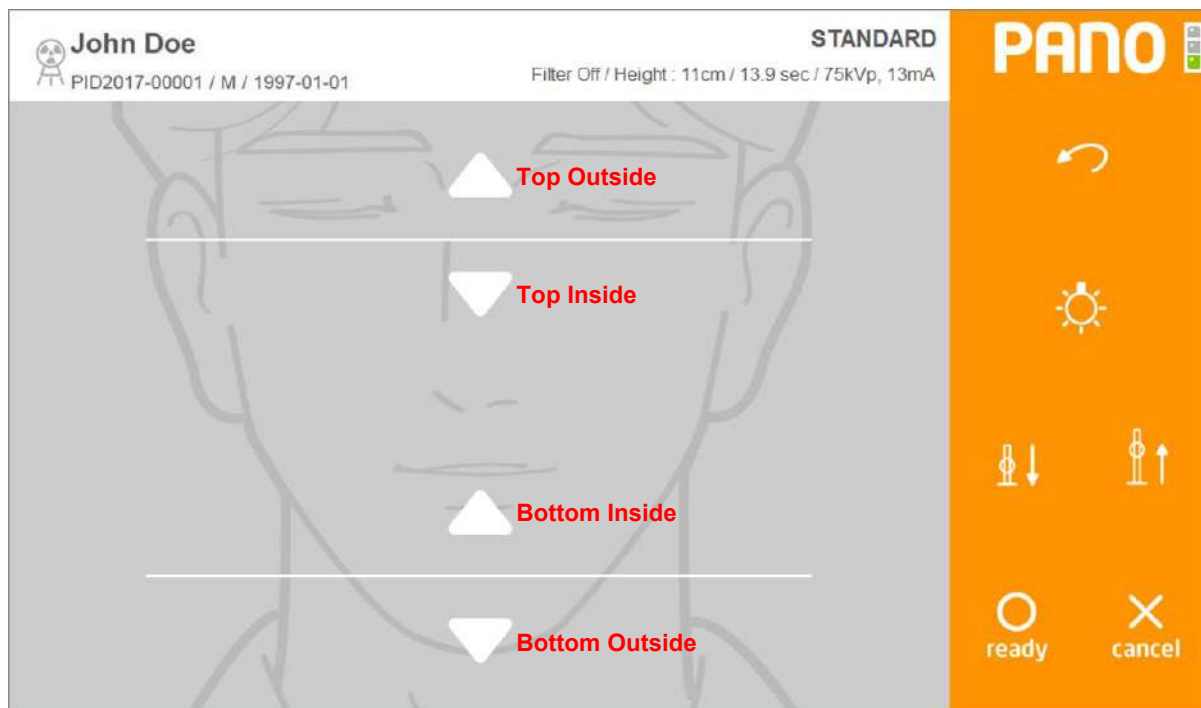

Fig 45 FOV Mode(Touch Monitor)

FOV

Item	Description
[Top Outside]	Shift up the size of ROI on the top side.
[Top Inside]	Shift down the size of ROI on the top side.
[Bottom Outside]	Shift down the size of ROI on the bottom side.
[Bottom Inside]	Shift up the size of ROI on the bottom side.

Temperature

Monitor the X-ray tube temperature and mark it on the screen as shown in Fig 46.

During normal operation the green light will be on. If the temperature rises, the green light turns off and the yellow light turns on. If the system becomes overheated the red light will turn on.

When the green light is on, the system will perform a scan. If the red or yellow light is on, cooling time is required before the next scan can be performed. (Yellow zone: 3min, Red zone: 5min) The remaining cooling time is shown to the left of the temperature indicator lights, above the [ready] button.

Fig 46 shows the cooling time procedure.

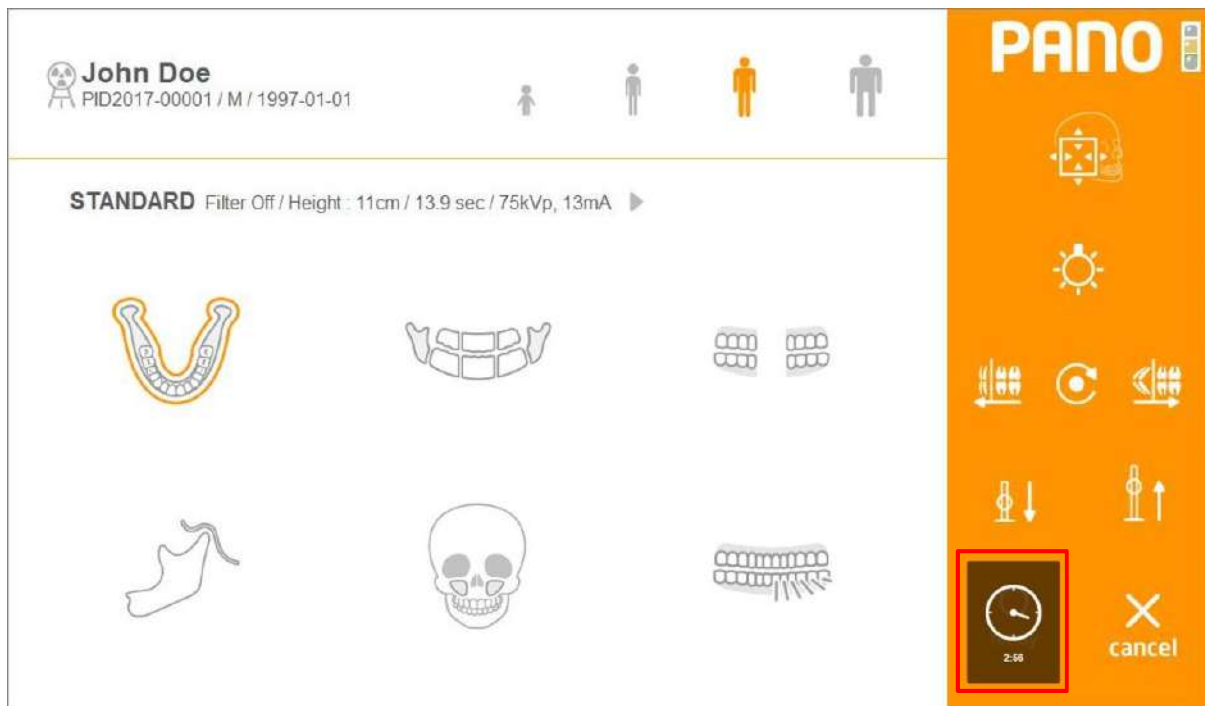

Fig 46 Cooling Time

6.5.3.3 Cephalometric Acquisition (One Shot Type)

Below is the Ceph scanning screen.

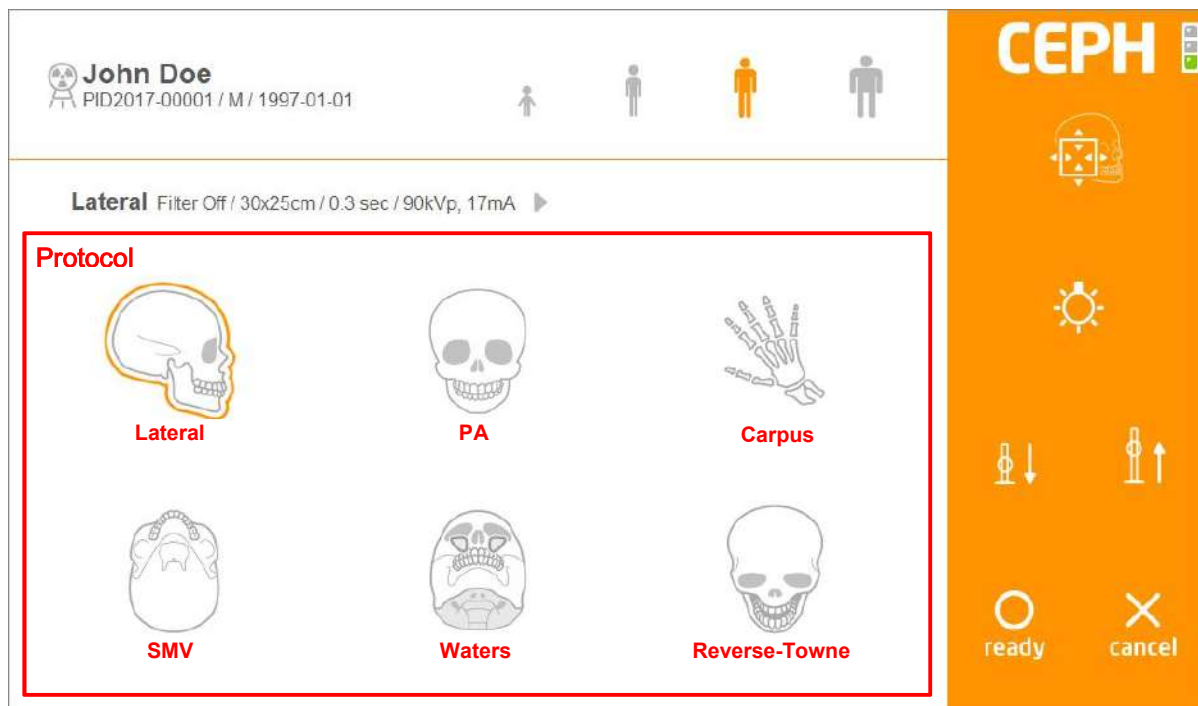

Fig 47 Acquisition: Cephalometric

Protocol

Item	Description
[Lateral]	Select Lateral protocol.
[PA]	Select PA protocol.
[Carpus]	Select Carpus protocol.
[SMV]	Select SMV protocol.
[Waters]	Select Waters protocol.
[Reverse-Towne]	Select Reverse-Towne protocol.

FOV Mode (Ceph)

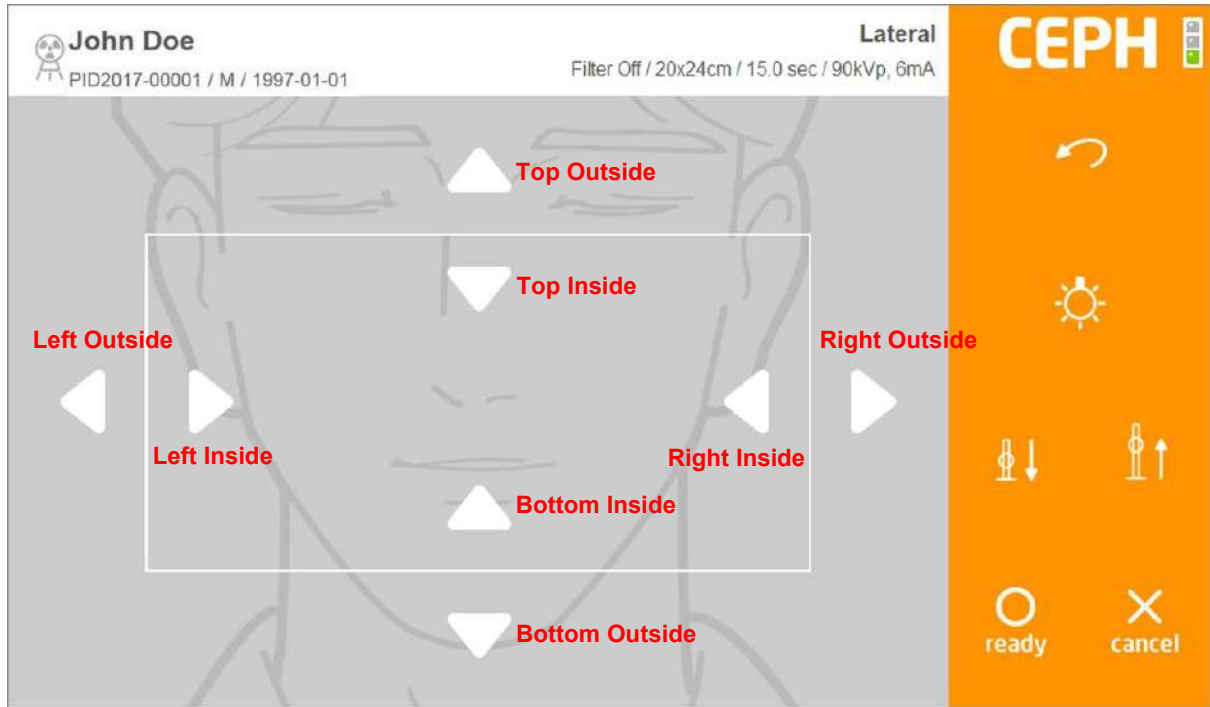

Fig 48 FOV Mode (on THU)

FOV

Item	Description
[Top Outside]	Shift up the size of ROI on the top side.
[Top Inside]	Shift down the size of ROI on the top side.
[Bottom Outside]	Shift up the size of ROI on the bottom side.
[Bottom Inside]	Shift down the size of ROI on the bottom side.
[Left Outside]	Shift up the size of ROI on the left side.
[Left Inside]	Shift down the size of ROI on the left side.
[Right Outside]	Shift up the size of ROI on the right side.
[Right Inside]	Shift down the size of ROI on the right side.

Note FOV Mode operates the same on both One Shot and Scan Type.

6.5.3.4 Cephalometric Acquisition (Scan Type)

Below is the Ceph screen for setting Ceph scanning.

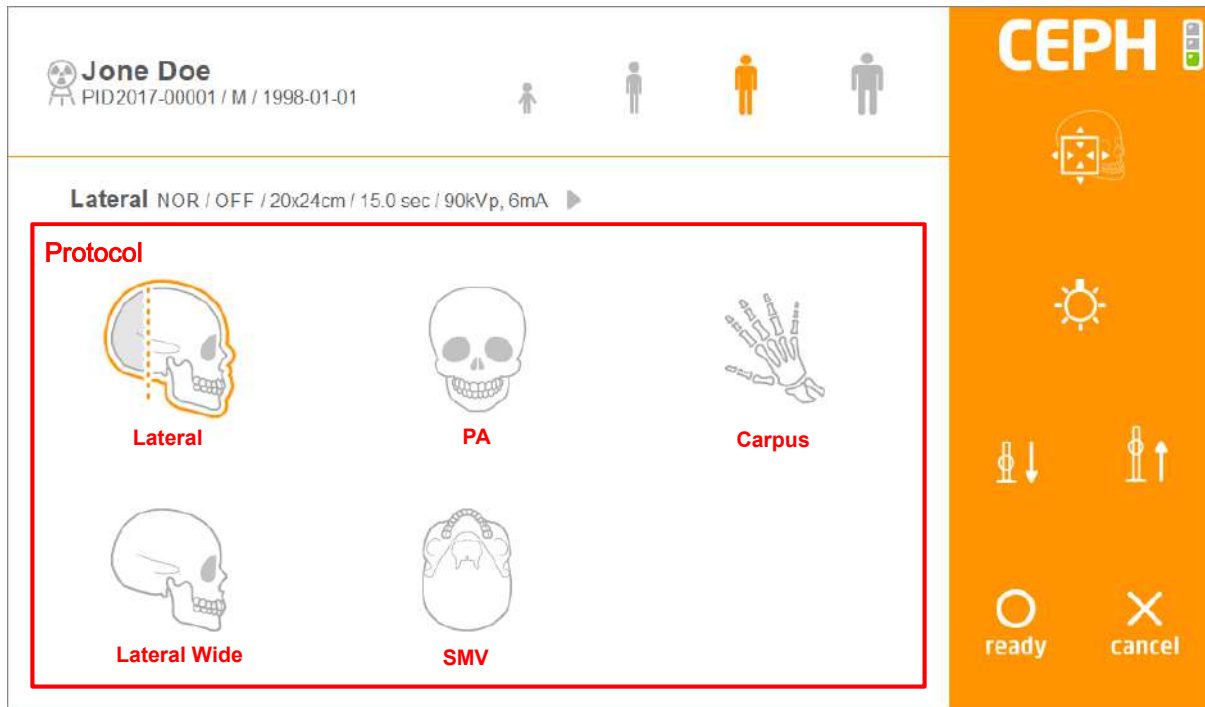

Fig 49 Acquisition: Cephalometric

Protocol

Item	Description
[Lateral]	Select Lateral protocol.
[PA]	Select PA protocol.
[Carpus]	Select Carpus protocol.
[Lateral Wide]	Select Lateral Wide protocol.
[SMV]	Select SMV protocol.

6.5.3.5CT Acquisition

Below is the screen for setting CT scanning.

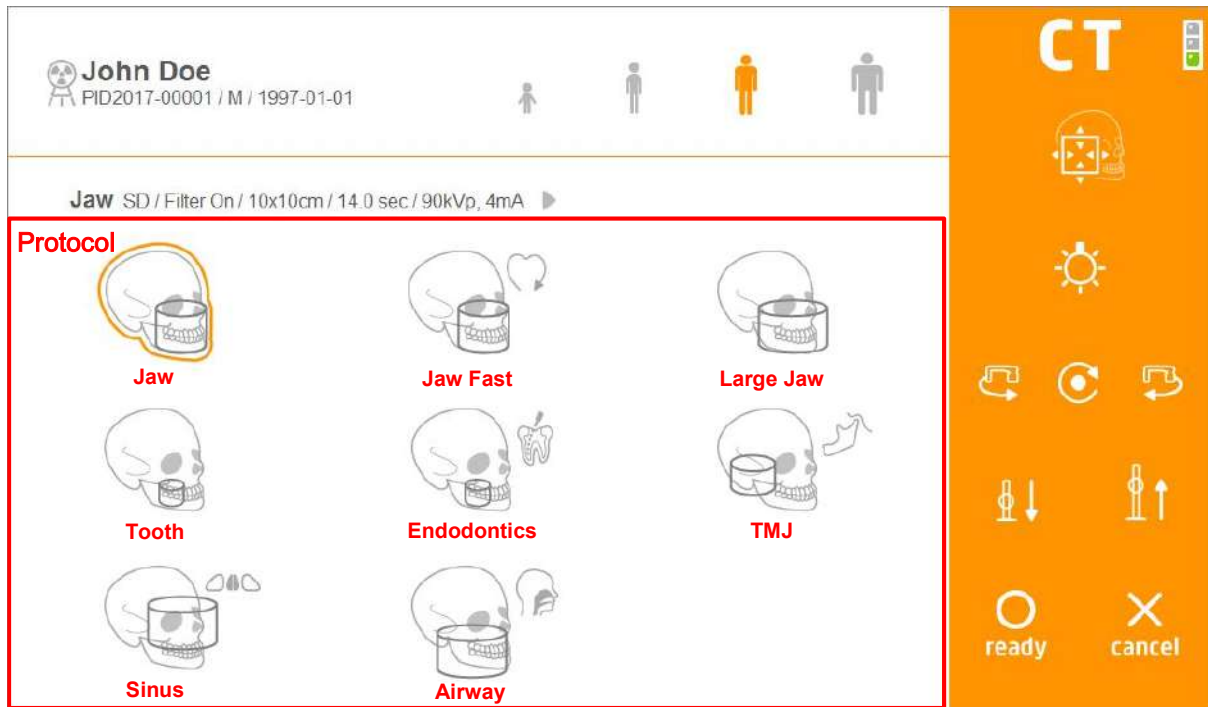

Fig 50 Acquisition: CT

Protocol

Item	Description
[Jaw]	Select Jaw protocol.
[Jaw Fast]	Select Jaw Fast protocol.
[Large Jaw]	Select Large Jaw protocol.
[Tooth]	Select Tooth protocol.
[Endodontics]	Select Endodontics protocol.
[TMJ]	Select TMJ protocol.
[Sinus]	Select Sinus protocol.
[Airway]	Select Airway protocol.

FOV Mode (CT)

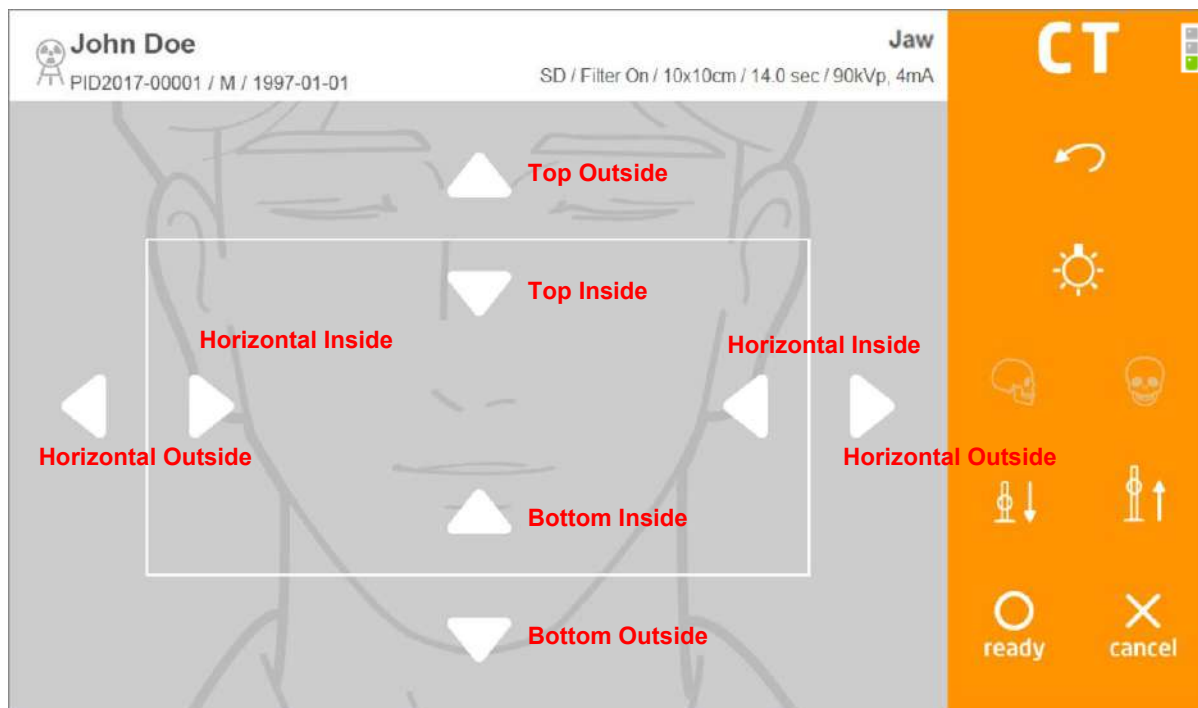

Fig 51 FOV Mode (On THU)

FOV

Item	Description
[Top Outside]	Shift up the size of ROI on the top side.
[Top Inside]	Shift down the size of ROI on the top side.
[Bottom Outside]	Shift up the size of ROI on the bottom side.
[Bottom Inside]	Shift down the size of ROI on the bottom side.
[Horizontal Outside]	Shift up the size of ROI on the horizontal side.
[Horizontal Inside]	Shift down the size of ROI on the horizontal side.

Note On CT FOV Mode, Left and Right collimators move to inside and outside as a set. For instance, press “Horizontal inside” button and Left and Right collimators move to inside as a set.

6.5.3.6 Confirm Image View

Image View Confirm screen displayed after scanning completion.

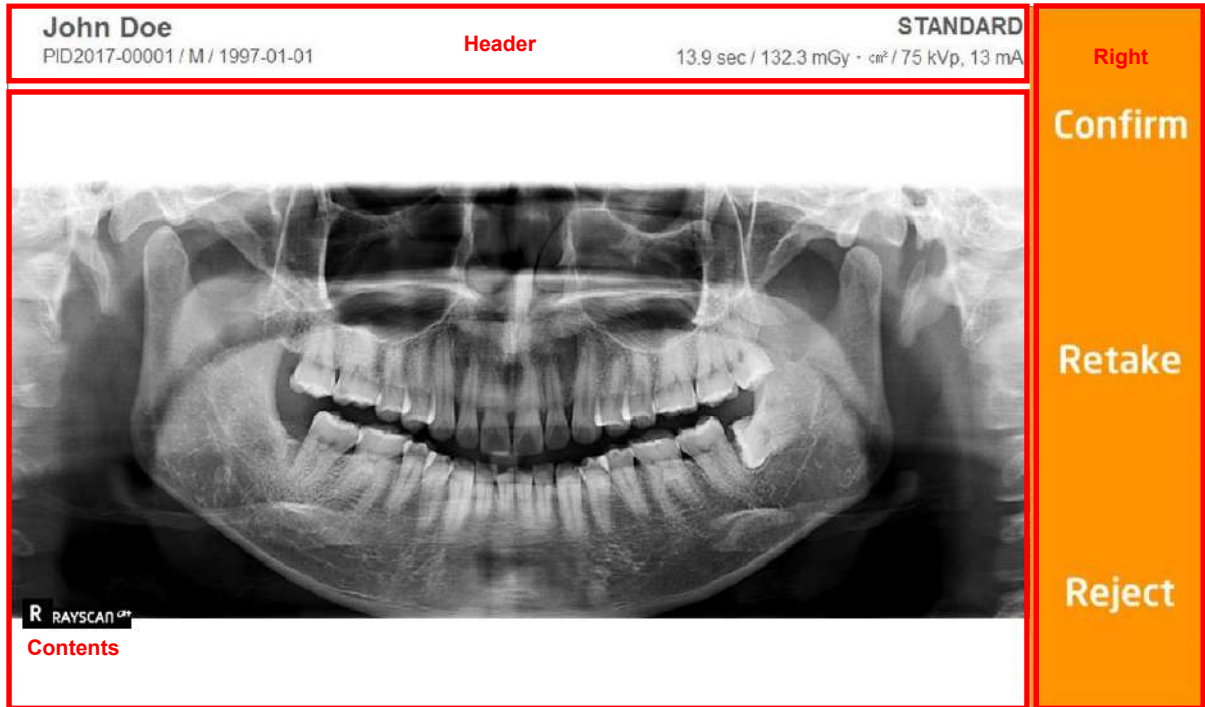

Fig 52 Confirm Image View: Pano

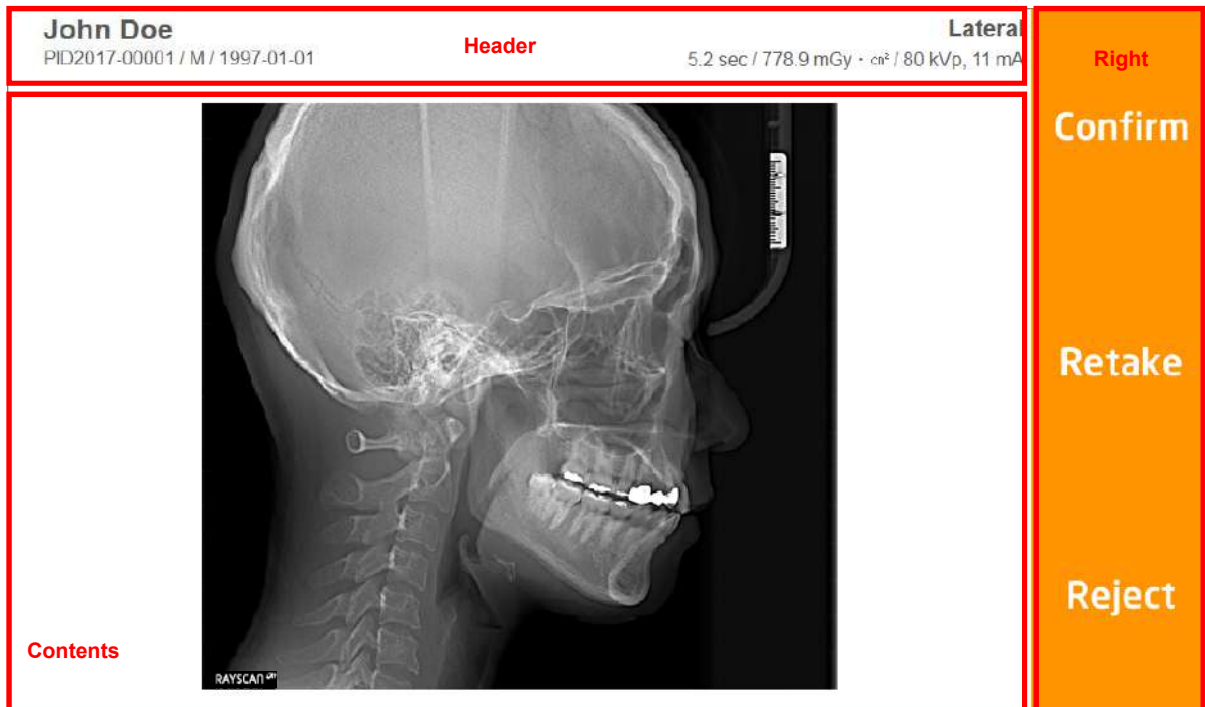

Fig 53 Confirm Image View: Ceph

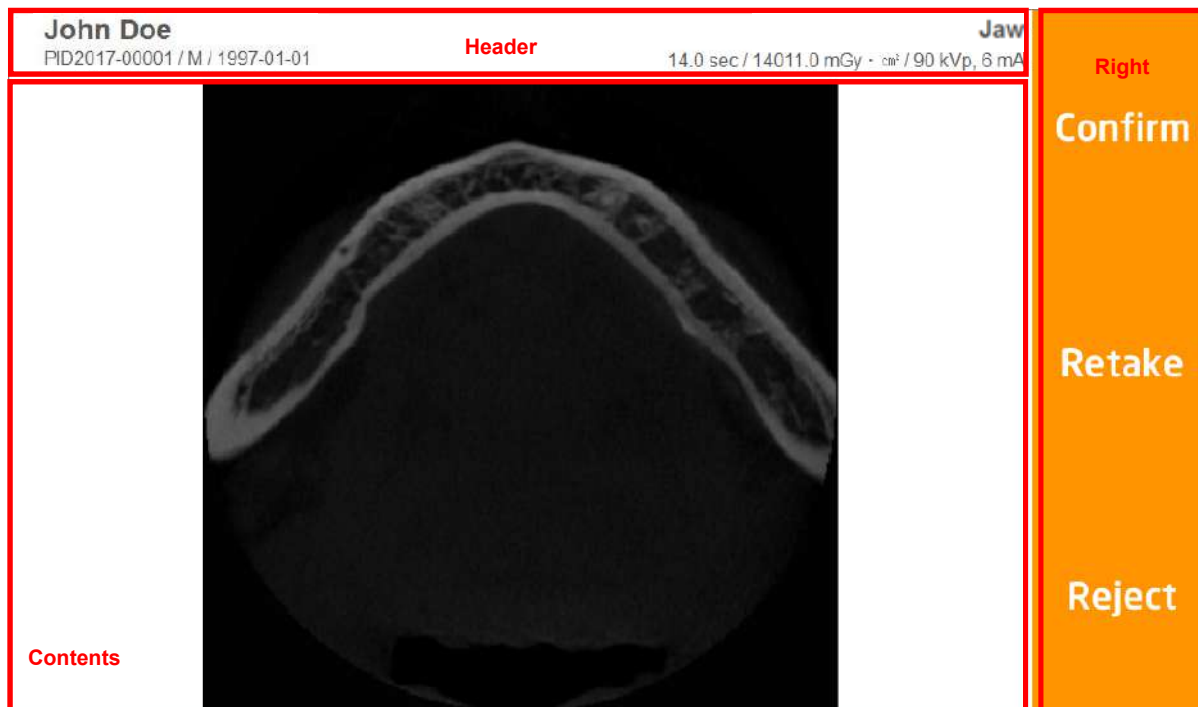

Fig 54 Confirm Image View: CT

Header

Item	Description
ID	Patient ID.
Name	Patient name
Gender	Type: M(Male), F(Female), O(Other)
Birth Date	Patient birth date
Scan Time	Scan Time
Dose	X-ray Dose (mGy * cm ²)

Contents

Item	Description
Image	Completed image

Right

Item	Description
[Confirm]	Image View Confirm button. Click to save Image View and return to Splash screen.
[Retake]	Image retake button. Click to save Image View and go to Acquisition-Patient Info screen automatically. Resets the equipment.
[Reject]	Reject image

6.6 RAYSCAN^{web}

6.6.1 System configuration

The system configuration for using RAYSCAN^{web} is as below figure. Through the wireless router in local network environment, mobile device can access the RAYServer for using RAYSCAN^{web}.

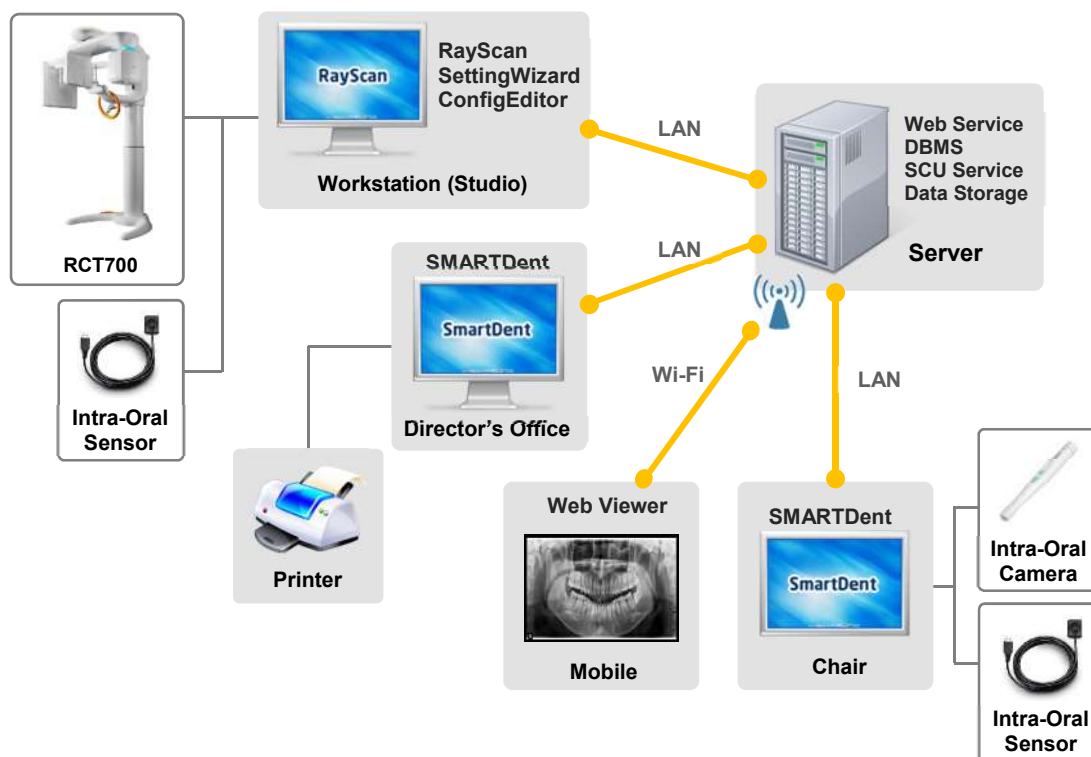
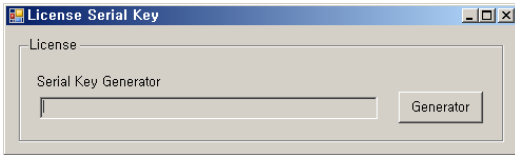
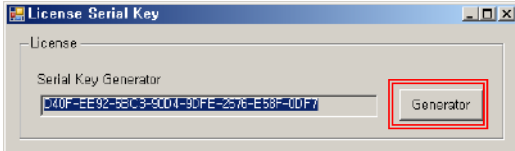



Fig 55 System Configuration of RAYSCAN^{web}

6.6.2 Operating Environment

Class	PC Minimum Requirements	Mobile Minimum Requirements
CPU	Pentium 4 or higher	Dual core 1.2GHz
RAM	1GB or more	1GB or more
Resolution	1024 X 768 or higher	320 X 480 or higher
Operating System	All Windows and MacOS	Android 4.1 or above, iOS 8.0 or above
Browser	Internet Explorer 10 or above, Safari 8.0 or above, and HTML5 supported browser	Internet Explorer 10 or above, Safari 8.0 or above, and HTML5 supported browser

6.6.3 Web License Installation

No.	Figure	Description
1		Run "C:\Ray\SerialKeyGenerator.exe".
2		Click [Generator] button to get serial key.
3		<p>Send e-mail to ray_cs@raymedical.co.kr You should provide the model name, S/N, and generated serial key. Please send the information to ray_cs@raymedical.co.kr to receive the license file. RAY CS Team will follow up with more instructions.</p> <div style="border: 1px solid gray; padding: 5px; background-color: #f0f0f0;"> <p>Note RAYSCAN^{Web} is optional. Please contact your local representative for more details.</p> </div>

6.6.4 Web Log-in

6.6.4.1 Clinic Use for All Patient Images

Run your internet browser and insert RAYSCAN^{web} address on the address bar.
 (If IP address of RAYServer is 192.168.1.200, insert "http://192.168.1.200::9091")

No.	Figure	Description
1		Enter ID, Password and click [Log in] button.

2



After the account have been verified, the main page will be opened as the figure.

6.6.4.2 Personal Use for Particular Patient

No.	Figure	Description
-----	--------	-------------

1



Click [Guest>] button on log-in page.

2



Insert particular patient name and click [Search] button.

3

Patient ID	Patient Name	Birthday	Gender
01227560	Alpha-PX-University-Hospital	1993-11-23	Male
01452128	Alpha-PX-University-Hospital	1993-11-22	Male
01600140	Alpha-PX-University-Hospital	1989-11-12	Male
01630007	Alpha-PX-University-Hospital	2003-03-28	Male
1194	Alpha-SC-Dental-Clinic-Lab-AP	1989-04-05	Female

If retrieved patient is not one, this page will be displayed. Select the patient in the retrieved patient list.



4





Patient images will be displayed as the figure.

6.6.5 Image Searching

- Search Patient



No.	Figure	Description
1		<p>Enter patient name or ID in the search bar at the top right corner of the screen.</p> <p>Tip: Entering the first letter of the patient name or ID will retrieve a list of patients whose names begin with the applicable letter.</p>
2		<p>The retrieved patient image will be displayed on-screen.</p>

- Search Recent Image by Modality

No.	Figure	Description
1		<p>Click the modality icon on the right-hand side.</p>
2		<p>Recently acquired images corresponding to the selected modality are displayed.</p>

6.6.6 Image Viewing

- Move to Image View Mode

No.	Figure	Description
1		<p>Search for the image desired.</p> <p>Tip: If the desired image is not found, search by patient.</p>
2		<p>Click on the image desired.</p>
3		<p>The screen will change to Image View mode.</p>

- Move Image

No.	Figure	Description
1		<p>Click [Move] button in Tool Menu.</p> <p>Tip: On mobile device, [Move] and [Zoom] buttons are not displayed, but the image can be controlled by touch function.</p>

2



Click and hold to move.

3



Move image to desired position and release.

Image Zoom

No.

Figure

Description

1



Click [Zoom] button in Tool Menu.

Tip: If used from a mobile device, [Move] and [Zoom] buttons are not displayed, but the image can be controlled by touch function.

2

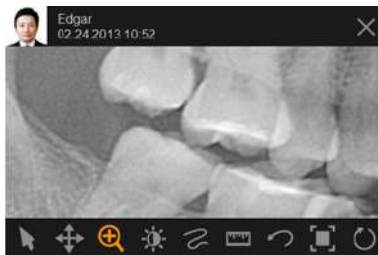

Click the left mouse button on top of the image, and move the mouse right to zoom.



For tablets and smart phones, touch function provides zoom as in standard photo applications.

3





Click the left mouse button on top of the image, and move the mouse left to shrink the image.

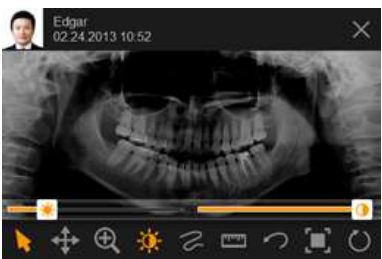

▪ Windowing

No.	Figure	Description
1		Click [Windowing] button in Tool menu.
2		The Brightness and Contrast control interface is displayed in the figure to the left.
3		Use the left slide control for adjusting image brightness. Use the right slide control for adjusting image contrast.



▪ Draw Free Curve

No.	Figure	Description
1		Click [Free Curve] button in Tool menu. Caution: Additional overlays will not be saved in web.
2		With the left mouse button held down, draw the desired shape. The shape drawn will appear on the screen.



▪ Length Measurement

No.	Figure	Description
1		<p>Click [Length] button in Tool Menu. Caution: Additional overlays will not be saved in web.</p>
2		<p>Click the start and end points of the area to be measured. The length indicated will be displayed. Units of length are in “mms” which represent the actual measurement unit. Tip: Click the [Select] button to change to Mouse Mode then select the appropriate overlay to move position or modify start and end points.</p>



▪ Delete Overlay

No.	Figure	Description
1		<p>Click [Cancel] button in Tool Menu.</p>
2		<p>The most recently entered overlay is deleted.</p>

Fit Image to Screen



No.	Figure	Description
1		Click [Fit-on] button in Tool Menu.
2		Image is changed as in figure.

Initialize Image

No.	Figure	Description
1		Click [Initialize] button in Tool Menu.
2		<p>All overlays entered in web version are deleted and windowing is initialized.</p> <p> Overlays entered in the PC version are retained. Also Overlays entered in the Web version are not saved.</p> <p>Caution</p>

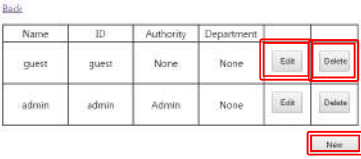

6.6.7 Web Management

6.6.7.1 User Account Management

No.	Figure	Description
1		<p>Log in with admin account. *When you install, ID and Password are admin/admin.</p>
2		<p>You can add, modify, and delete the user account.</p>
3		<p>After adding or modifying the information, click [Submit] button to save.</p>

6.6.7.2 Bookmark Setting

- Add Bookmarks on Internet Explorer 11

No.	Figure	Description
1		<p>Go to RAYSCAN^{web} page on Internet Explorer 11.</p>
2		<p>Click [Add Bookmark] button on left top corner.</p>

3



On next, easy to run RAYSCAN^{web} by clicking Bookmark.

- Add Bookmark on Google Chrome

No.

Figure

Description

1



Go to RAYSCAN^{web} page on Google Chrome.

2



Click [Add Bookmark] button on the top.

3

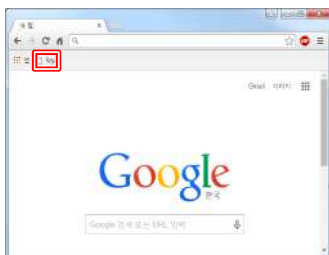

On next, easy to run RAYSCAN^{web} by clicking Bookmark.

Note





Please note that as a generic viewing application RAYSCAN^{web} (optional software for RAYSCAN α) is not suited for diagnostic purposes. However, it is an excellent tool for communicating a diagnosis made at SMARTDent for desktop.

Scanning

7

7 SCANNING

Bite Block, Chinrest, Sinus Chinrest, Edentulous Chinrest, TMJ Chinrest, TMJ Guide, and Temple Support

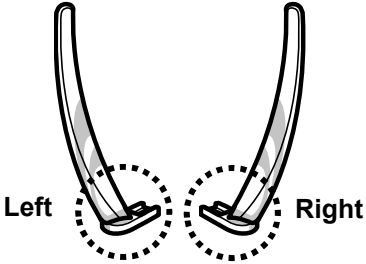
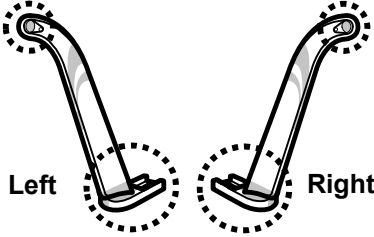



Accessory	Figure	Description
Bite Block		Used for normal position of Panoramic and CT. Assist with placing the front teeth into the groove of the bite block.
Chinrest		Used for normal position of Panoramic and CT.
Sinus Chinrest		Used for Sinus position of Panoramic and CT. Used for TMJ position of CT. Sinus Chinrest is lower than Chinrest.
Edentulous Chinrest		Used for Panoramic and general CT position of edentulous patients.
TMJ Chinrest		Used for TMJ position of CT. TMJ Chinrest is mounted on the Sinus Chinrest.
Temple Support		Used for Normal and Sinus position of Panoramic, and TMJ position of CT. The rounded part of temple support must be mounted on the inner-side. Check the marker "L", "R" in Temple support.
TMJ Guide		Used for TMJ Position of Panoramic. TMJ guide is shorter than the Temple Support, and has cone-shaped protrusions that fit inside the ears.

Note Sterilize by using sterilizing liquids such as ethyl alcohol.

7.1 Panoramic Scanning

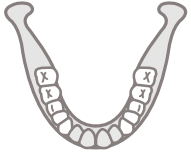
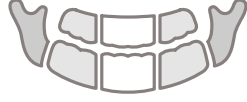
7.1.1 Description of Panoramic Protocol

The Panoramic Scanning programs include automatic spinal compensation for an excellent view of the anterior teeth without a distracting spinal shadow.



No.	Figure	Description
1		<p><u>Standard</u> Radiate the entire region of the maxilla and mandible. Typically used to observe both the maxilla and mandible.</p>
2		<p><u>Segment</u> Select scanning area to reduce radiation exposure.</p>
3		<p><u>TMJ (Temporomandibular Joint)</u> Radiate on left and right TMJ section while mouth is opened and/or closed. Used to observe TMJ.</p>
4		<p><u>Sinus</u> Radiate the sinus. Used commonly to observe maxillary sinus.</p>
5		<p><u>Bitewing</u> Effective in the diagnosis of occlusal surfaces of the posterior teeth.</p>
6		<p><u>Orthogonal</u> For effective diagnosis of the proximal surfaces of the teeth.</p>

7.1.2 Cautionary Measures for Pre-Scanning

- ① Make sure chinrest is installed properly.
- ② Install hygienic cover over Bite Block.
- ③ Patient must remove all metal when undergoing scanning, including glasses, necklaces, earrings, hearing aids, etc.
- ④ Patient must wear a protective lead apron.

7.1.3 Panoramic Scanning Method

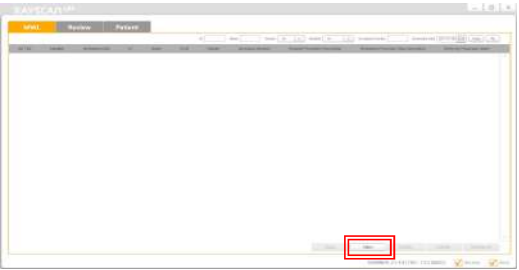
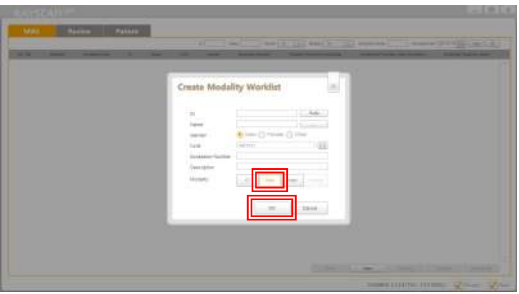
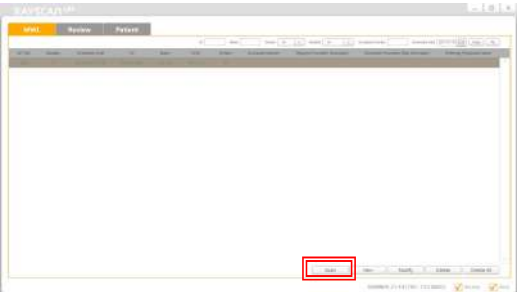
7.1.3.1 Panoramic (Standard) Scanning Method

No.	Figure	Description
1		<p>Click MWL on top left side of the screen and [New] button on the bottom right to register a new patient.</p>
2		<p>In Modality Worklist screen, select [Pano] for Modality and click [OK] button.</p>
3		<p>Select the MWL created above and click [Scan] button on the bottom right.</p>
4		<p>Confirm Patient Information, click [OK] button, then proceed to next step.</p>

5

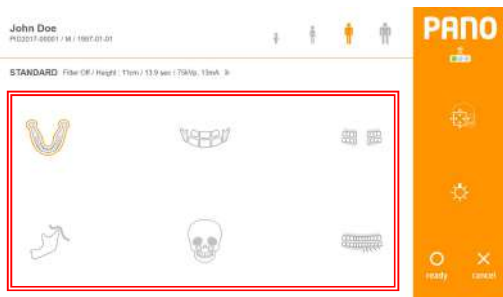

Select the intended scanning protocol.

6

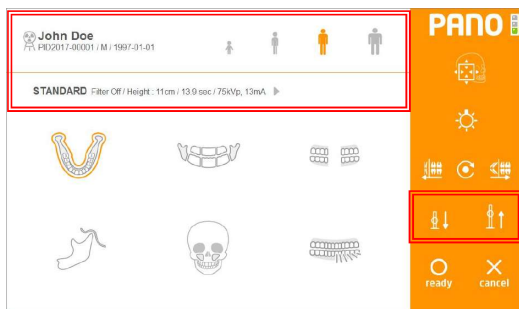

Select Patient Type, Tube Voltage and Tube Current based on the patient.

Using the remote control or touch screen, adjust equipment height to patient height and make sure that the patient's neck is as straight as possible. Once positioned, allow patient to hold on to the Patient Handle.

※ The remote control is not provided in Canada.

Position the patient according to the intended scanning protocol. (Refer to paragraph 7.1.4 for the positioning method.)

7

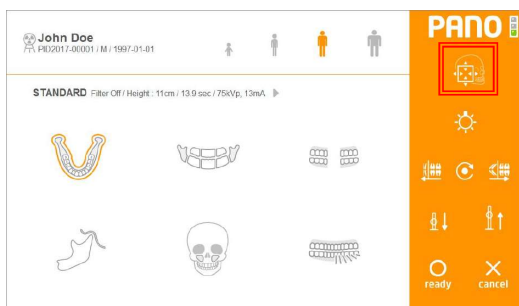

Use [FOV] button on the THU and/or remote controller to get into FOV Mode. Go to “8-2” if FOV adjustment not needed.

※ The remote control is not provided in Canada.

8-1

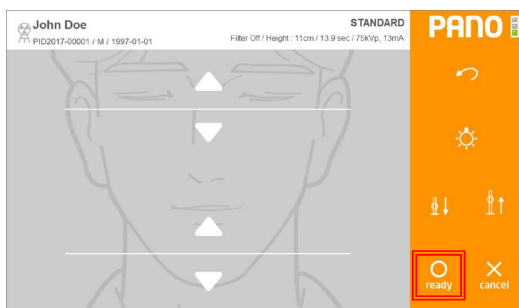

Press [ready] button after FOV adjustment on Console PC and/or the THU. The device moves to ready position for exposure.

8-2

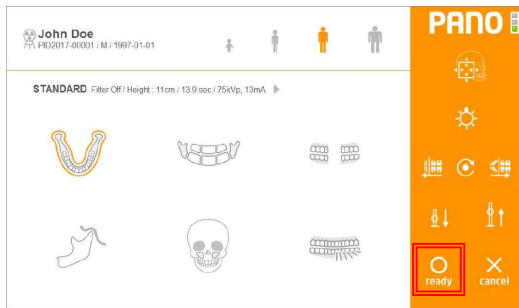

Once patient positioning is complete, press [ready] button on the touch screen.

9

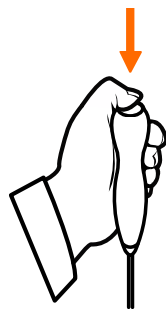

After the green light on the exposure switch has been illuminated, continue to press the switch until scanning has been completed.

Note

Take care not to release the button during scanning as doing so will stop the scanning process. Maintain audio and visual contact with the patient and x-ray unit during exposure. If the c-arm stops moving during exposure, or moves in an erratic way, release the exposure button immediately.

10



Once scanning is complete, select among the [Confirm/Retake/Reject] buttons.

✳ **Operation Description**

[Confirm]: Save image and go to MWL screen.



[Retake]: Save image and automatically go to Acquisition-Patient Info screen for retake.

[Reject]: Save Image View, indicate rejected image in the database, then go to MWL screen.

Note

The system monitors a temperature sensor that is embedded in the X-ray tube and will automatically cool the X-ray tube to maintain safe operation.

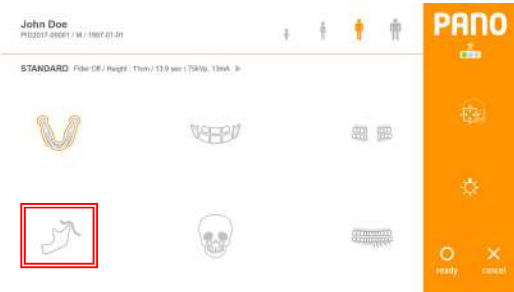
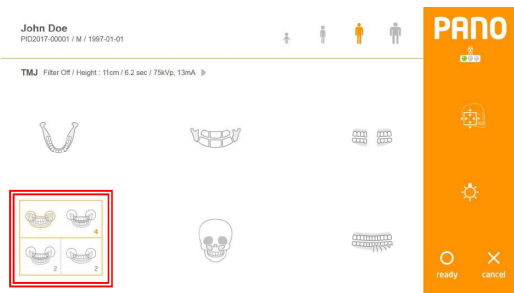
7.1.3.2 Panoramic (TMJ) Scanning Method

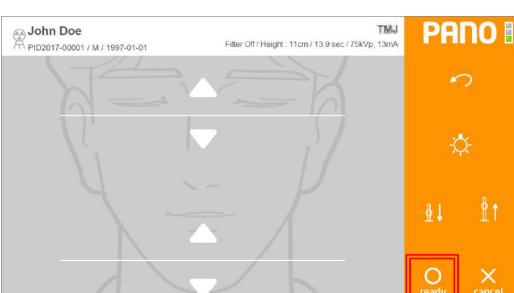
No.	Figure	Description
1	 <p>The screenshot shows the PANO menu with various scanning options. The TMJ protocol icon, which depicts a hand holding a device, is highlighted with a red rectangular box. The menu also displays patient information and technical specifications for the STANDARD protocol.</p>	<p>Select TMJ protocol.</p>
2	 <p>The screenshot shows the PANO menu with the 4-2 TMJ protocol icon highlighted by a red box. This icon shows two views of the TMJ joint. The menu also displays patient information and technical specifications for the TMJ protocol.</p>	<p>Choose either Open or Close mouth on the THU.</p> <p>Note Select either Open or Close mode on 2-View.</p>
3	 <p>The screenshot shows the PANO menu with the FOV (Field of View) button highlighted by a red box. The button is located on the right-hand side of the menu. The menu also displays patient information and technical specifications for the TMJ protocol.</p>	<p>Use [FOV] button on the THU and/or remote controller to get into FOV Mode. Go to “4-2” if FOV adjustment not needed.</p> <p>※ The remote control is not provided in Canada.</p>
4-1	 <p>The screenshot shows the PANO menu with the ready button highlighted by a red box. The main display area shows a grayscale image of a human face with white arrows indicating the field of view for the scan. The menu also displays patient information and technical specifications for the TMJ protocol.</p>	<p>Press [ready] button after FOV adjustment on Console PC and/or the THU. The device moves to ready position for exposure.</p>

4-2



Once patient positioning is complete, press [ready] button on the touch screen.

5

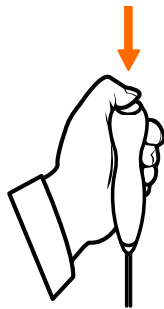

After the green light on the exposure switch has been illuminated, continue to press the switch until scanning has been completed.

Note

Take care not to release the button during scanning as doing so will stop the scanning process. Maintain audio and visual contact with the patient and x-ray unit during exposure. If the c-arm stops moving during exposure, or moves in an erratic way, release the exposure button immediately.

6

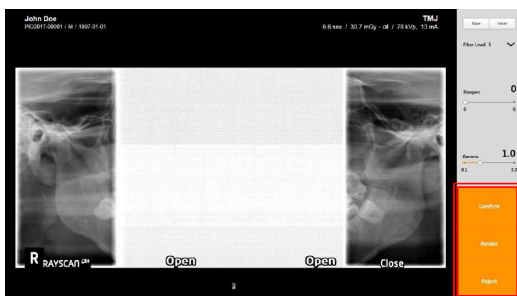

After scanning is completed, click [Confirm/ Retake/ Reject] buttons.

※ **Operation Description**

[Confirm]: Saves image and shows 4-View scanning mode screen.

[Retake]: Automatically moves to scanned Patient Information screen and proceeds with rescan.

[Reject]: Saves image, including rejected information, then moves to scan list and stands by.

7

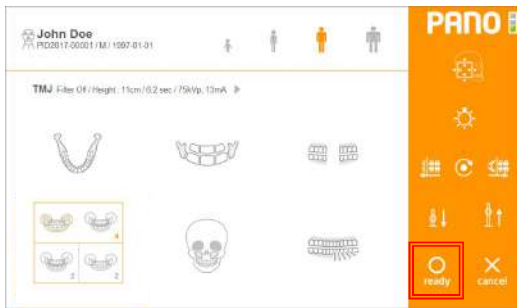

Once patient positioning is complete, press [ready] button on the touch screen.

8

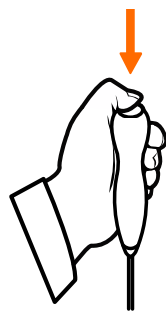

After the green light on the exposure switch has been illuminated, continue to press the switch until scanning has been completed.

Note

Take care not to release the button during scanning as doing so will stop the scanning process. Maintain audio and visual contact with the patient and x-ray unit during exposure. If the c-arm stops moving during exposure, or moves in an erratic way, release the exposure button immediately.

9

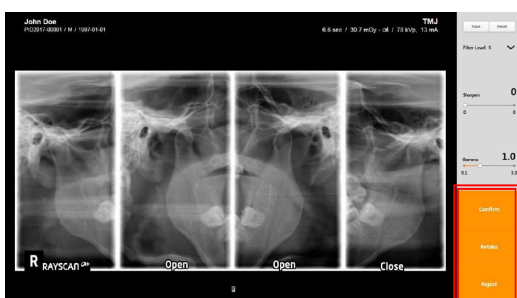

After 4-View scanning is completed, click [Confirm/ Retake/ Reject] buttons. First scanned image locates in the middle and second image on both ends.

※ **Operation Description**

[Confirm]: Saves image, moves to scanning list screen and stands by. (Only 4-View image gets saved.)

[Retake]: Automatically moves to the scanned Patient Information screen and proceeds with rescan. (First scanned 2-View image does not change, only second image is rescanned.)

[Reject]: Saves image, including rejected information, moves to scan list and stands by.

7.1.3.3 Panoramic (Segment) Scanning Method

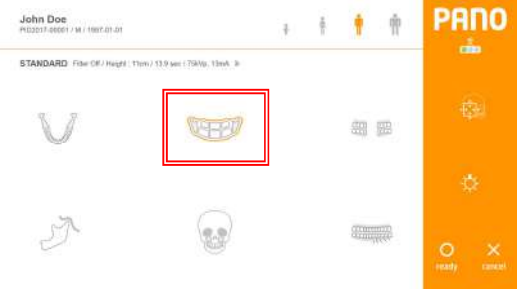
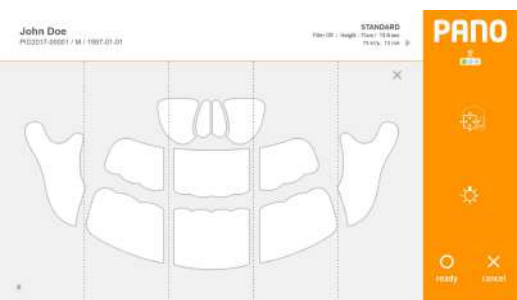
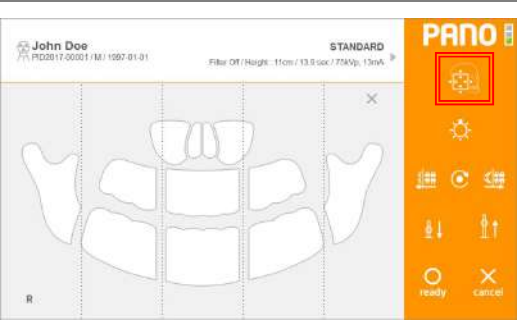
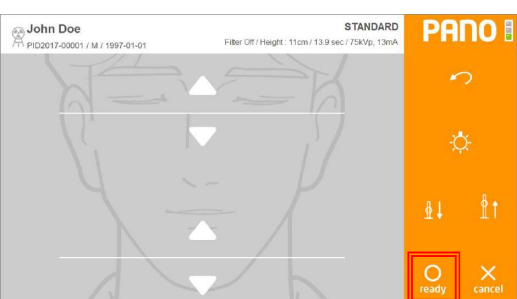
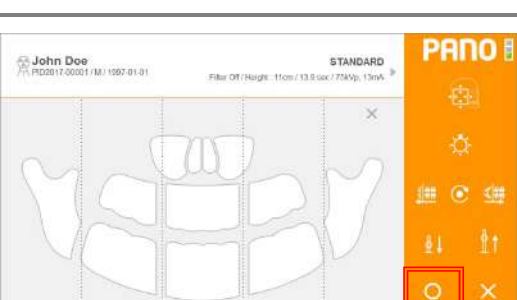
No.	Figure	Description
1		<p>Select Segmented Pano protocol.</p> <p>Note To modify scanning protocol, click on the Segmented Pano button.</p>
2		<p>Specify area for scanning within selected window.</p> <p>Note Image will be converted into a full Panoramic if all 5 areas are selected. Dark gray section is unscanned area.</p>
3		<p>Use [FOV] button on the THU and/or remote controller to get into FOV Mode. Go to “4-2” if FOV adjustment not needed.</p> <p>※ The remote control is not provided in Canada.</p>
4-1		<p>Press [ready] button after FOV adjustment on Console PC and/or the THU. The device moves to ready position for exposure.</p>
4-2		<p>Once patient positioning is complete, press [ready] button on the touch screen.</p>

5

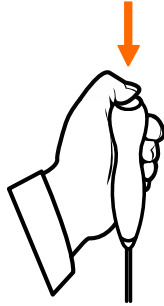

After the green light on the exposure switch has been illuminated, continue to press the switch until scanning has been completed.

Take care not to release the button during scanning as doing so will stop the scanning process.

Note Maintain audio and visual contact with the patient and x-ray unit during exposure. If the c-arm stops moving during exposure, or moves in an erratic way, release the exposure button immediately.

7.1.4 Patient Positioning Method

7.1.4.1 Panoramic (Standard, Segment) Positioning Method

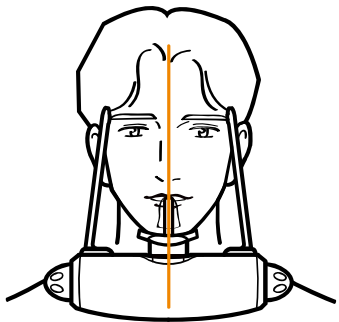
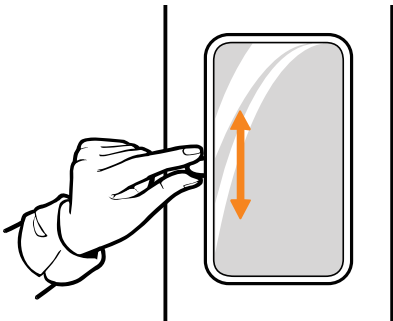
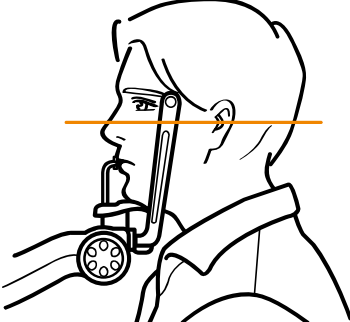
No.	Figure	Description
1		<p>Align center of the patient's head (midsagittal plane, for example, middle of the forehead, nose, philtrum etc.) with the vertical alignment beam as shown in the figure on the left. Avoid tilting to either side.</p>
2		<p>Adjust patient's head angle to align the Frankfort plane with the horizontal alignment beam. Make sure that the patient's neck is fully straightened and not tipped forward.</p>
3		<p>Use the horizontal alignment beam lever, mounted on the equipment Lift Column, to align the patient's Frankfort plane parallel to the laser.</p>

4

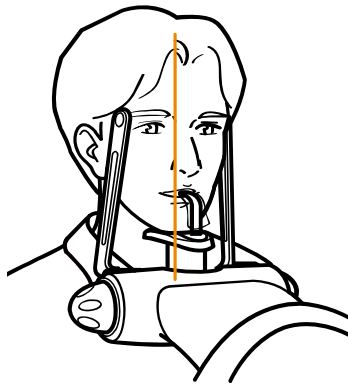

Confirm the position of Canine Beam is on the center of right canine tooth.

5

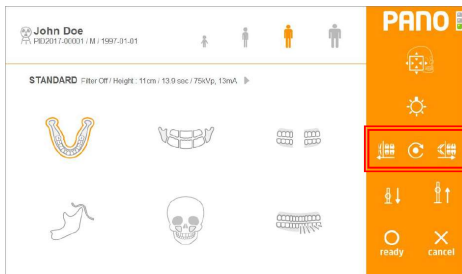

Adjust the position of Canine Beam by using touch screen or remote control.

[Left]: Move canine beam to forward.

[Center]: Place Canine Beam to initial position.

[Right]: Move canine beam to backwards.

Note

It is important step to get optimal image. Do not skip this process.

6

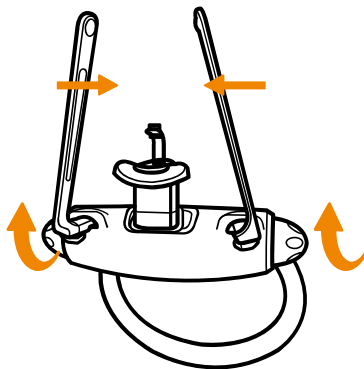

Once patient positioning is completed, turn the lever so that the Chinrest and Temple Support can hold the patient's head in place.



Caution

Remove the CT headrest when taking panoramic acquisition.

7.1.4.2 Panoramic (Standard, Segment) Edentulous Position Method

No.	Figure	Description
1		<p>Detach the Bite Block and install the Edentulous Chinrest. The center of the Edentulous Chinrest is designed to match the Bite Stick hole of the chinrest.</p>
2		<p>Push the patient's lower jaw forward, to rest in the cup of the Edentulous Chinrest.</p>
3		<p>Align the center of the patient's head (midsagittal plane, for example, middle of the forehead, nose, philtrum etc.) with the vertical alignment beam as shown in the figure on the left. Avoid tilting to either side.</p>

4

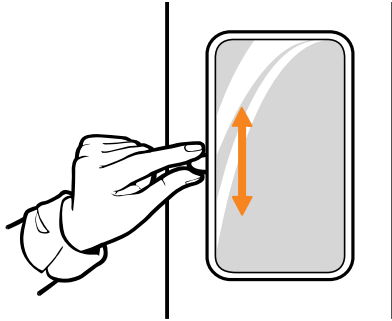

Adjust patient's head to align the Frankfort plane with the horizontal alignment beam. Make sure that the patient's neck is fully straightened and not tipped forward.

5

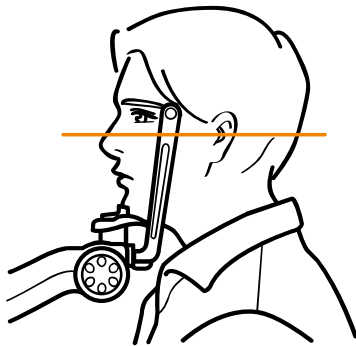

Use the horizontal alignment beam lever, mounted on the equipment Lift Column, to align the patient's Frankfort plane parallel to the laser.

6

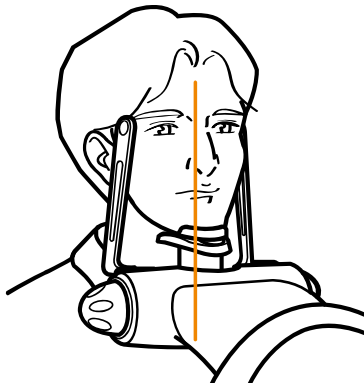

Confirm the position of Canine Beam is on the center of right canine tooth.

7

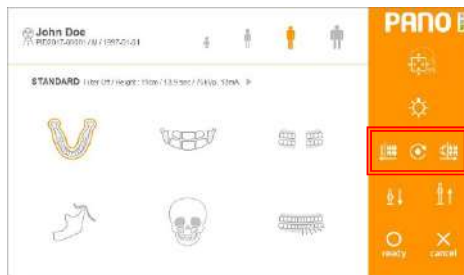

Adjust the position of Canine Beam by using touch screen or remote control.

[Left]: Move canine beam to forward.

[Center]: Place Canine Beam to initial position.

[Right]: Move canine beam to backwards.

Note

It is important step to get optimal image. Do not skip this process.

8

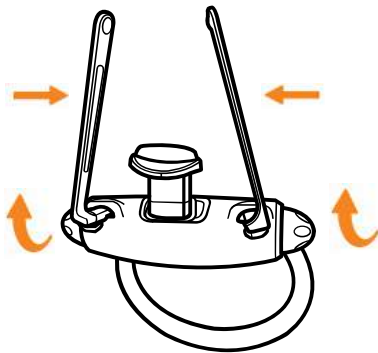

Once patient positioning is completed, turn the lever so the Chinrest and Temple Support can hold the patient's head in place.

7.1.4.3 Panoramic (Sinus) Position Method

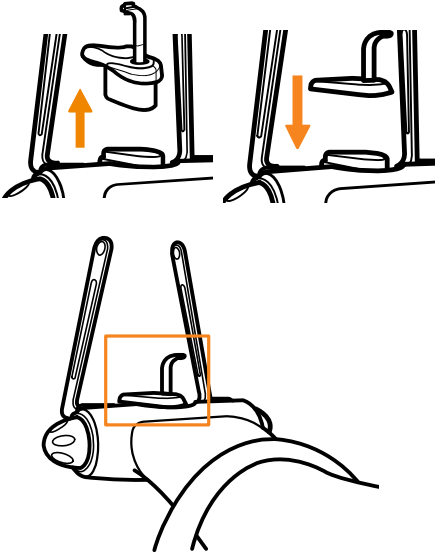
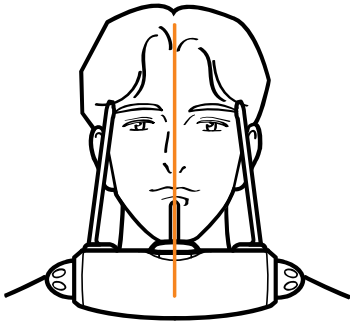
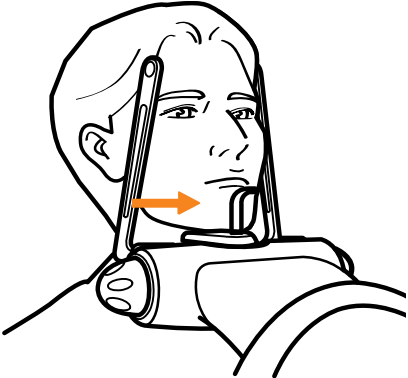
No.	Figure	Description
1		<p>Push the Chinrest upward to detach, then install the Sinus Chinrest. Turn the Bite Block in the opposite direction for installation.</p>
2		<p>Align center of the patient's head (midsagittal plane, for example, middle of the forehead, nose, philtrum etc.) with the vertical alignment beam as shown in the figure on the left. Avoid tilting to either side.</p>
3		<p>Push patient's chin forward and support it using the installed Bite Block.</p>

4

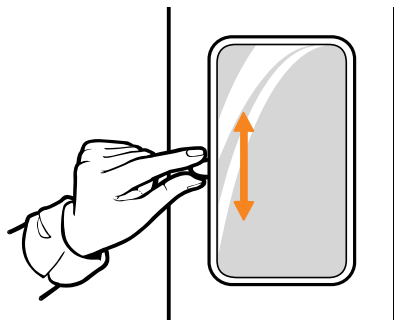

Use the horizontal alignment beam lever (mounted on the equipment Lift Column) to check the patient's head angle in preparation for sinus scanning.

5

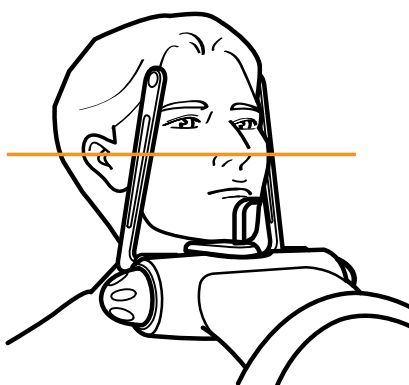

Adjust the patient's head angle so that the horizontal alignment beam, the tip of the nose and the external auditory meatus are on the same horizontal plane, then stabilize the patient in a straight position and make sure that the neck is not tilted forward.

6

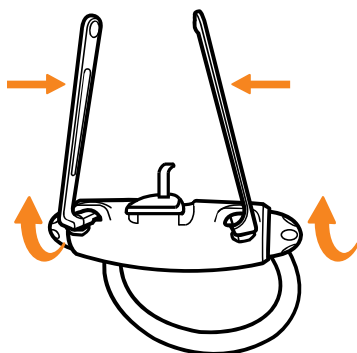

After patient positioning, turn the lever so the Chinrest and Temple Support can secure the patient's head.

7.1.4.4 Panoramic (TMJ) Position Method

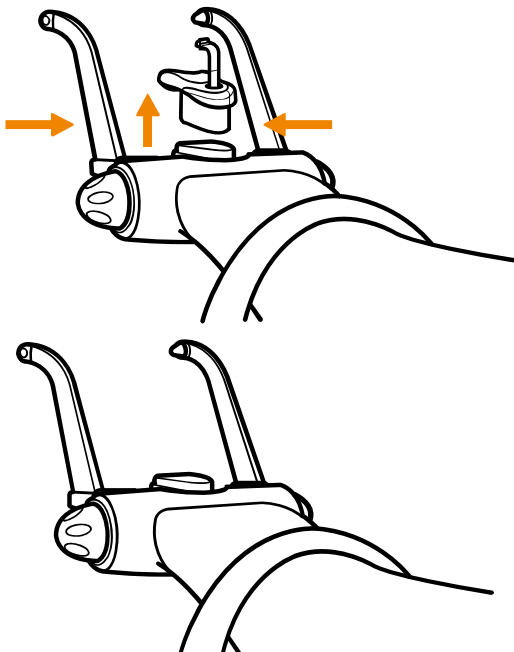
No.	Figure	Description
1		<p>Push the Chinrest or Sinus Chinrest upward to detach. (TMJ scanning should be conducted with the Chinrest detached.) Turn the screw underneath the Temple Guide to detach and install the TMJ Guide, then tighten the Locking Screw. Insert the TMJ Guide into the patient's ear.</p> <div style="border: 1px solid gray; padding: 5px; margin-top: 10px;"> <p>Note Scan with TMJ Chinrest removed.</p> </div>

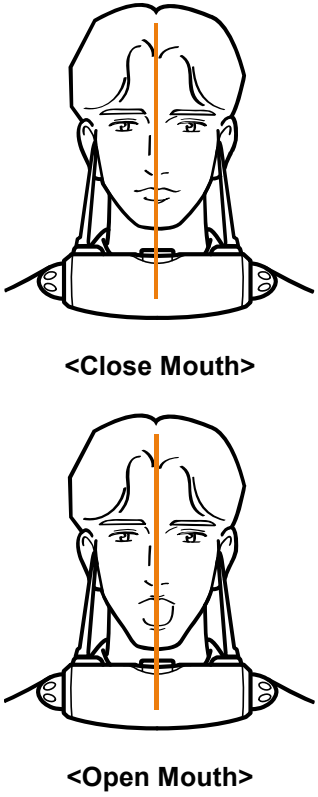
2	 <p style="text-align: center;"><Close Mouth></p> <p style="text-align: center;"><Open Mouth></p>	<p>Insert TMJ Guide into patient's ears. Align center of the patient's head (midsagittal plane, for example, middle of the forehead, nose, philtrum etc.) with the vertical alignment beam as shown in the figure on the left. Avoid tilting to either side.</p>
---	--	--

3

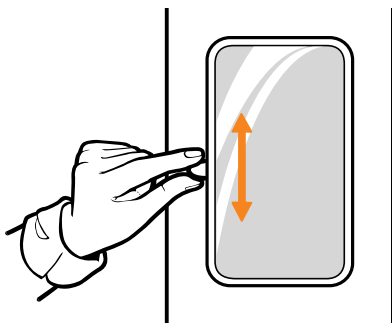

Adjust the horizontal laser beam lever to check patient's head angle in preparation for TMJ scanning.

4

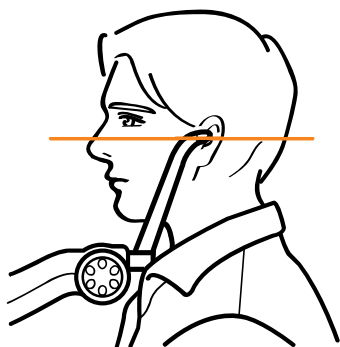

<Close Mouth>

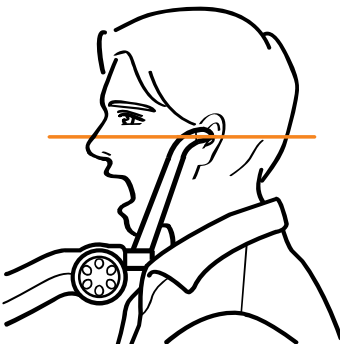

<Open Mouth>

Adjust patient's head angle until the horizontal laser beam matches the Frankfort plane.



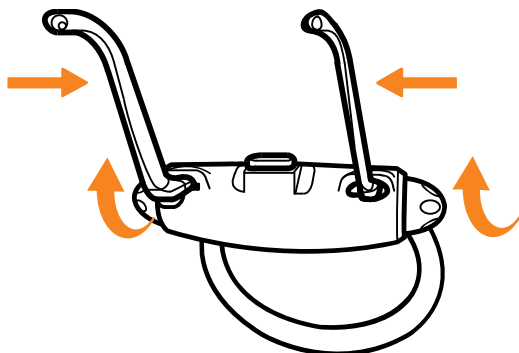

5

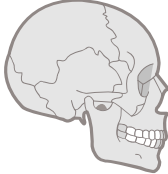
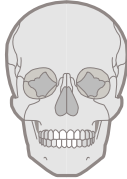

After patient positioning, turn the lever so the TMJ Guide can hold the patient in position.

7.2 CEPH Scanning (One Shot Type)

7.2.1 Description of CEPH Protocol

No.	Figure	Description
1		<p><u>Lateral</u></p> <p>Taken with the X-ray beam perpendicular to the patient's midsagittal plane. The center of the X-ray exposure should penetrate the external auditory meatus. Used to observe cranial and facial disorders, superficial wounds, nasopharyngeal soft tissues and paranasal sinus.</p>
2		<p><u>PA (Posterior-Anterior)</u></p> <p>Radiate from back to front. Used to observe illnesses of the cranium, superficial wounds, facial lateral growth and frontal sinus.</p>
3		<p><u>SMV (Sub-Mento Vertex)</u></p> <p>Radiate from the bottom of the maxilla looking up toward the epicranium. Used to observe the cranial base, position of the mandibular condylar and zygomatic arch.</p>
4		<p><u>Carpus</u></p> <p>Radiate the hand and wrist. Skeletal maturity of the hand can be compared to cranial development.</p>
5		<p><u>Waters</u></p> <p>When the midsagittal plane of the patient is vertical in relation to the detector, the X-ray should penetrate the center of the maxillary sinus. Used to observe maxillary sinus, etc.</p>
6		<p><u>Reverse-Towne</u></p> <p>X-ray should penetrate the occipital bone while mouth is fully opened. Used in observation of maxillary condylar fractures or maxillary condylar displacement.</p>

7.2.2 Cautionary Measures for Pre-Scanning

- ① When undergoing scanning, patients must remove all metals including glasses, necklaces, earrings, hearing aids, etc.
- ② Patient must wear a lead apron for protection against radiation.

7.2.3 CEPH Scanning Method (One Shot Type)

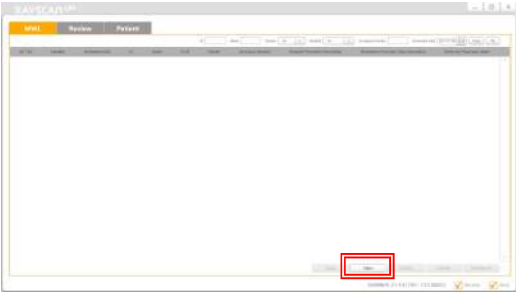
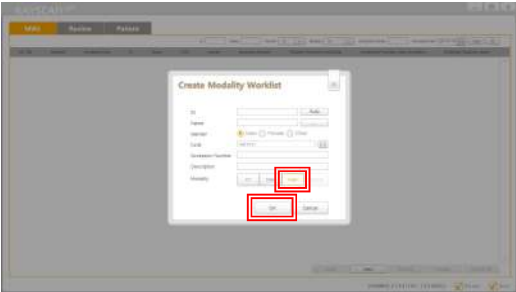
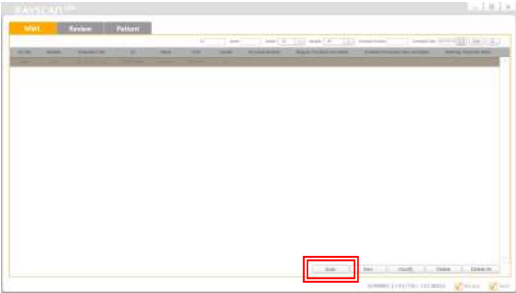
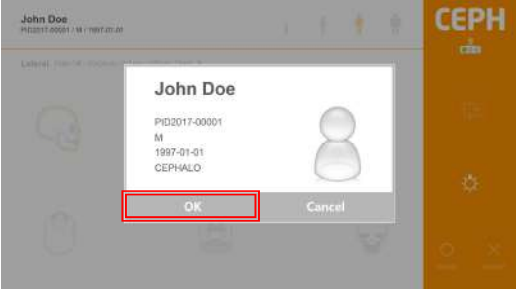
No.	Figure	Description
1		Click MWL on the top left side of the screen and click the [New] button on the bottom right to register a new patient.
2		In the Modality Worklist screen, select [Ceph] for Modality and click [OK] button.
3		Select the MWL created above and click [Scan] button on the bottom right.
4		Verify Patient Information and click [OK] button.

5



Select the intended scanning protocol.

Select Patient Type, Resolution, Tube Voltage and Tube Current based on the patient.

Using the remote control or touch screen, adjust equipment height to patient height and make sure the patient's neck is as straight as possible. Once positioned, allow patient to hold on to the Patient Handle.

※ The remote control is not provided in Canada.

6

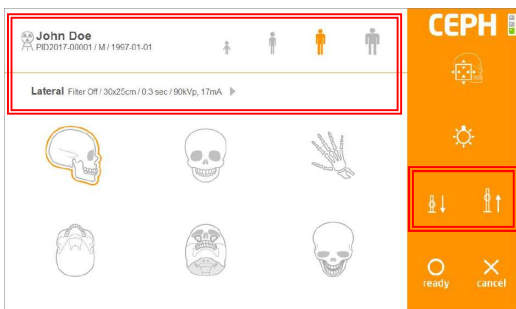

Position the patient according to the intended scanning protocol. (Refer to paragraph 7.2.4 for the positioning method.)

7

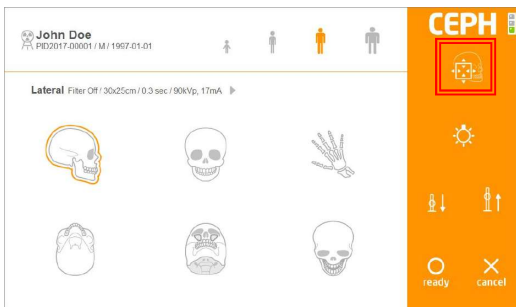

Use [FOV] button on the THU and/or remote controller to get into FOV Mode. Go to "8-2" if FOV adjustment not needed.

※ The remote control is not provided in Canada.

8-1

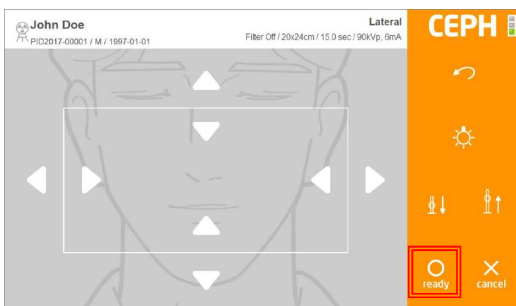

Press [ready] button after FOV adjustment on Console PC and/or the THU. The device moves to ready position for exposure.

8-2



Once patient positioning is complete, press [ready] button on the touch screen.

9

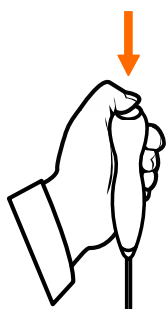

After the green light on the exposure switch has been illuminated, continue to press the switch until scanning has been completed.

Note

Take care not to release the button during scanning as doing so will stop the scanning process. Maintain audio and visual contact with the patient and x-ray unit during exposure. If the c-arm stops moving during exposure, or moves in an erratic way, release the exposure button immediately.

10



Once scanning is complete, select among the [Confirm/Retake/Reject] buttons.

※ **Operation Description**

[Confirm]: Save Image View and go to MWL screen.

[Retake]: Save Image View and automatically go to Acquisition-Patient Info screen for retake.

[Reject]: Save Image View, indicate rejected image in the database, then go to MWL screen.

7.2.4 Patient Position Method

7.2.4.1 CEPH (Lateral) Position Method

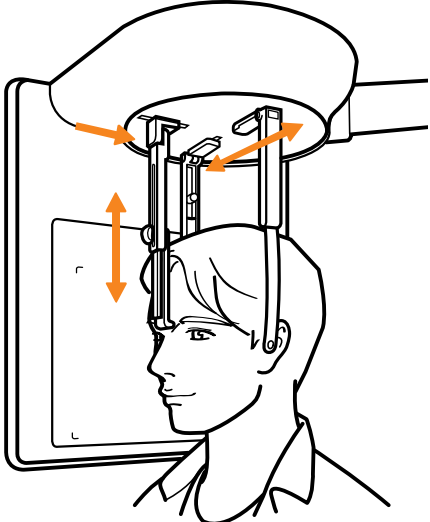
No.	Figure	Description
1		<p>Position the patient's head as shown in the figure to the left, with the ala-tragus line parallel to the floor.</p> <p>Note Place detector on the patient's right-hand side.</p>

7.2.4.2 CEPH (PA) Position Method

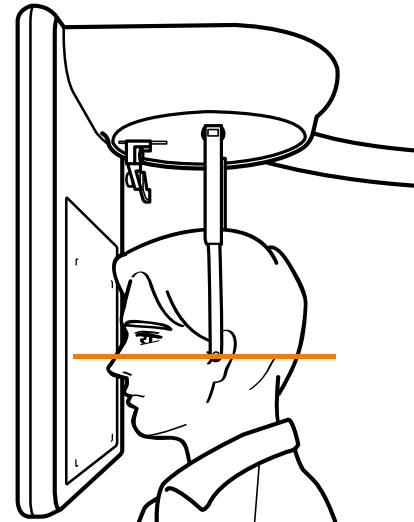
No.	Figure	Description
1		<p>Turn the Ear Rods as shown in the figure on the left. Fold up the Nasion Bar, then position the patient's head with the ala-tragus line parallel to the floor.</p>

7.2.4.3 CEPH (SMV) Position Method

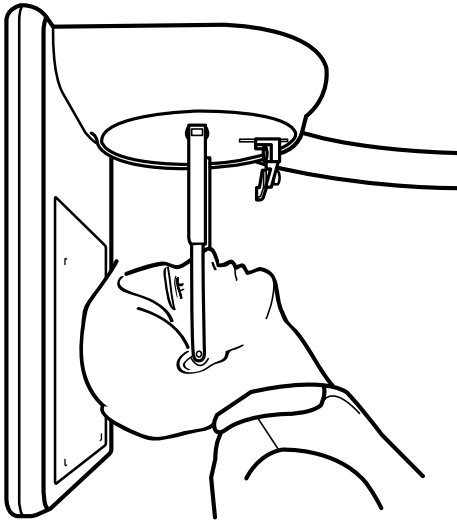
No.	Figure	Description
1		<p>Turn the Ear Rods as shown in the figure on the left and fold-up the Nasion Bar. Position the patient's head vertically, with the ala-tragus line perpendicular to the floor.</p> <div style="border: 1px solid gray; padding: 5px; margin-top: 10px;"> <p>Note Place the patient in a sitting position when scanning SMV.</p> </div>

7.2.4.4 CEPH (Carpus) Position Method

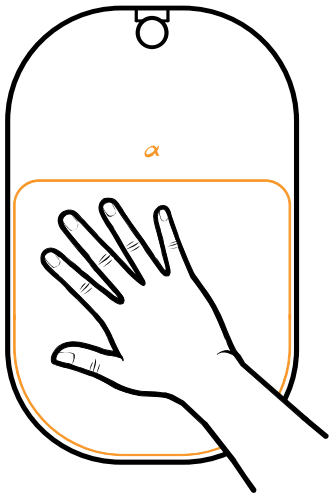
No.	Figure	Description
1		<p>Gently place the patient's hand palm down on the sensor, inside the marked region.</p>

7.2.4.5 CEPH (Waters) Position Method

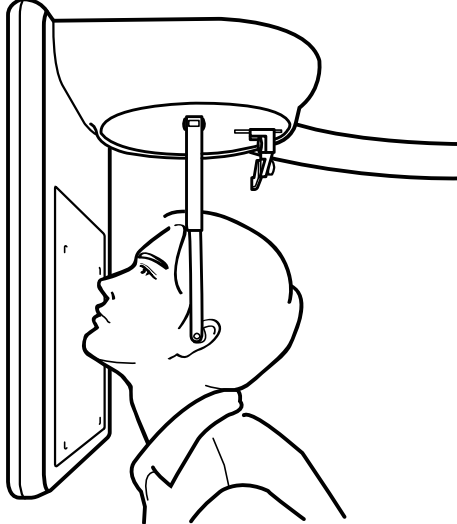

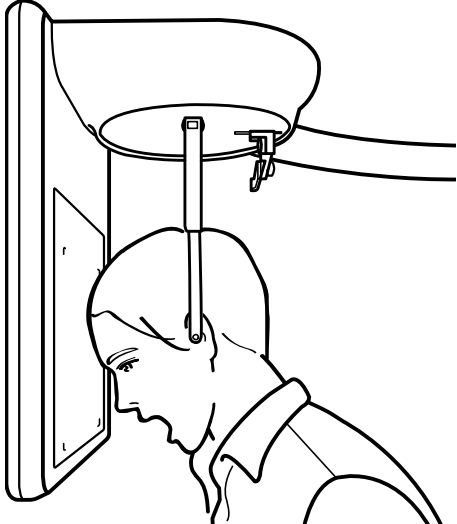

No.	Figure	Description
1	 <p>The diagram shows a patient's head in profile, facing left, positioned for a Waters cephalometric radiograph. The patient's head is tilted back. A vertical rod is attached to the top of the head, and a horizontal detector is positioned above the head. The angle between the alar-targal line and the detector is indicated as 37-40 degrees.</p>	<p>Position the patient's head as depicted in the figure to the left. Place the head of the patient so that the angle between the Alar-targal line and the Detector is 37~40°.</p>

7.2.4.6 CEPH (Reverse Towne) Position Method

No.	Figure	Description
1	 <p>The diagram shows a patient's head in profile, facing left, positioned for a Reverse Towne cephalometric radiograph. The patient's head is tilted back, and the mouth is open. A vertical rod is attached to the top of the head, and a horizontal detector is positioned above the head. The angle between the alar-targal line and the detector is indicated as 25-30 degrees.</p>	<p>Position the patient's head as depicted in the figure to the left. Place the head of the patient so that the angle between the Alar-targal line and the Detector is 25~30°. The mouth is positioned at the maximum open position.</p>

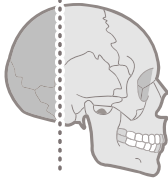
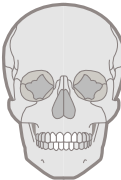
7.3 CEPH Scanning (Scan Type)

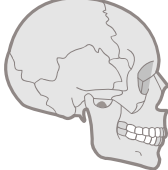
7.3.1 Description of CEPH Protocol

No.	Figure	Description
1		<p><u>Lateral</u> Taken with the X-ray beam perpendicular to the patient's sagittal plane. The center of the X-ray exposure should penetrate the external auditory meatus. Used to observe cranial and facial disorders, superficial wounds, nasopharyngeal soft tissues and paranasal sinus.</p>
2		<p><u>PA (Posterior-Anterior)</u> Radiate from back to front. Used to observe illnesses of the cranium, superficial wounds, facial lateral growth and frontal sinus.</p>
3		<p><u>Carpus</u> Radiate the hand and wrist. Skeletal maturity of the hand can be compared to cranial development.</p>
4		<p><u>Lateral wide</u> Provides a wider FOV than the upper Lateral protocol. Use it to see the occiput of the patient.</p>
5		<p><u>SMV (Sub-Mento Vertex)</u> Radiate from the bottom of the maxilla looking up toward the epicranium. Used to observe the cranial base, position of the mandibular condylar and zygomatic arch.</p>

7.3.2 Cautionary Measures for Pre-Scanning

- ① Patient must remove all metals including glasses, necklaces, earrings, hearing aids, etc., when undergoing scanning.
- ② Patient must wear a lead apron for protection against radiation.

7.3.3 CEPH Scanning Method

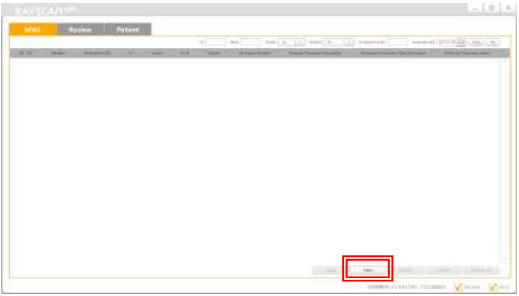
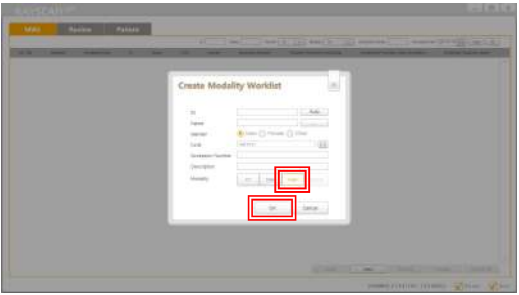
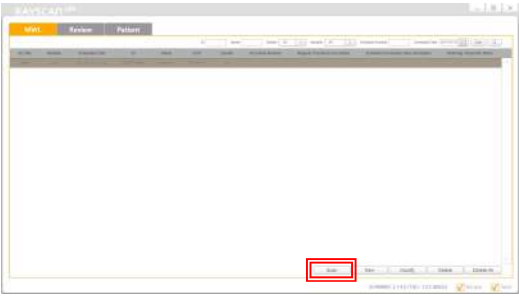
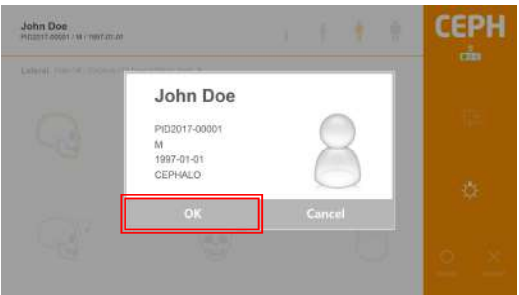
No.	Figure	Description
1		<p>Click MWL on the top left side of the screen, then click the [New] button on the bottom right to register a new patient.</p>
2		<p>In Modality Worklist screen, select [Ceph] for Modality and click [OK] button.</p>
3		<p>Select the MWL created in above and click [Scan] button on bottom right.</p>
4		<p>Verify patient information and click [OK] button then proceed to the next step.</p>

5



Select the intended scanning protocol.

Select Patient Type, Resolution, Tube Voltage and Tube Current based on the patient.

6



Using the remote control or touch screen, adjust equipment height to patient height and make sure that the patient's neck is as straight as possible. Once positioned, allow patient to hold on to the Patient Handle. Once patient positioning is complete, press [ready] button on the touch screen.

※ The remote control is not provided in Canada.

Position the patient according to the intended scanning protocol. (Refer to paragraph 7.3.4 for the positioning method.)

7

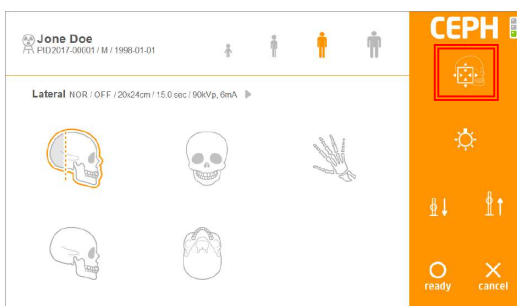

Use [FOV] button on the THU and/or remote controller to get into FOV Mode. Go to “8-2” if FOV adjustment not needed.

※ The remote control is not provided in Canada.

8-1

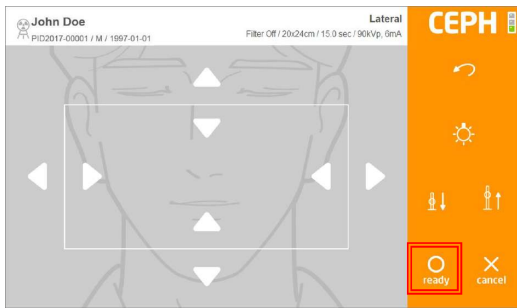

Press [ready] button after FOV adjustment on Console PC and/or the THU. The device moves to ready position for exposure.

8-2



Once patient positioning is complete, press [ready] button on the touch screen.

9



After green light on the exposure switch has been illuminated, continue to press the switch until scanning has been completed.

Note

Take care not to release the button during scanning as doing so will stop the scanning process. Maintain audio and visual contact with the patient and x-ray unit during exposure. If the c-arm stops moving during exposure, or moves in an erratic way, release the exposure button immediately.

10



Once scanning is complete, select among the [Confirm/Retake/Reject] buttons.

✳ **Operation description**

[Confirm]: Save image view and go to MWL screen.

[Retake]: Save image view and automatically go to Acquisition-Patient Info screen for retake.

[Reject]: Save image view and indicate rejected image view in Database then go to the MWL screen.

7.3.4 Patient Position Method

7.3.4.1 CEPH (Lateral) Position Method

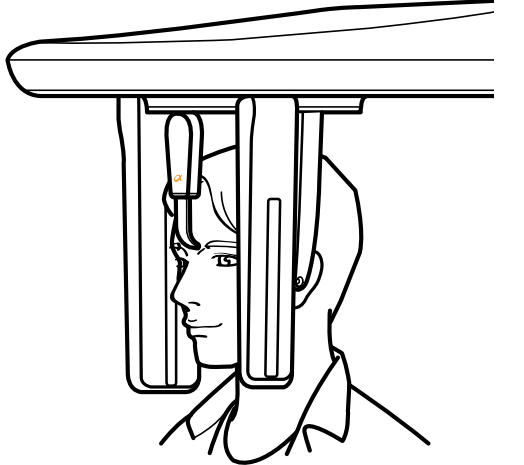
No.	Figure	Description
1		<p>Place detector on the patient's right-hand side.</p> <p>Note Place detector on patient's right-hand side.</p>

7.3.4.2 CEPH (PA) Position Method

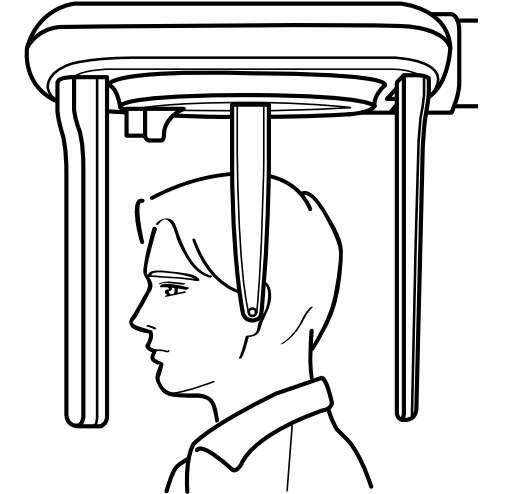
No.	Figure	Description
1		<p>Turn the Temple Support as shown in the figure on the left and fold-up the Nasion Bar. Position the patient's head with the ala-tragus line parallel to the floor.</p>

7.3.4.3 CEPH (SMV) Position Method

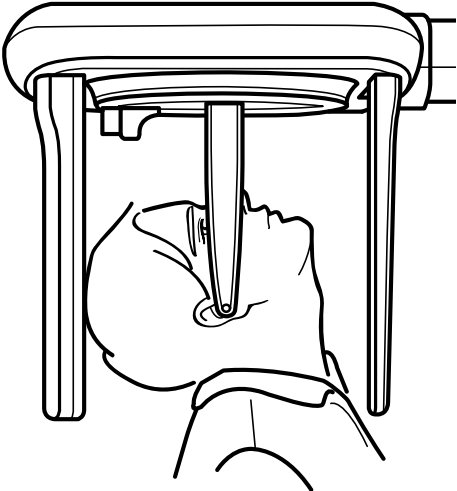

No.	Figure	Description
1		<p>Turn the Temple Support as shown in the figure on the left and fold-up the Nasion Bar. Position the patient's with the ala-tragus line perpendicular to the floor.</p> <div style="border: 1px solid gray; padding: 5px; margin-top: 10px;"> <p>Note Place the patient in a sitting position when scanning SMV.</p> </div>

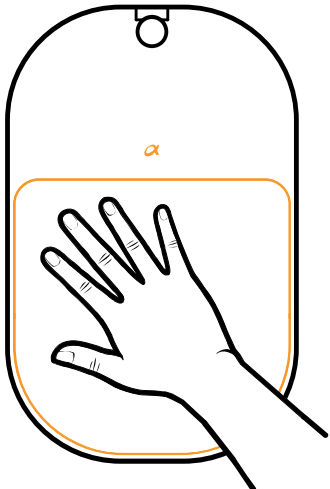
7.3.4.4 CEPH (Carpus) Position Method

No.	Figure	Description
1		<p>Gently place the patient's hand palm down on the sensor, inside the marked region.</p>

7.4 CT Scanning

7.4.1 Description of CT Protocol

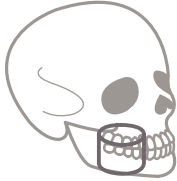
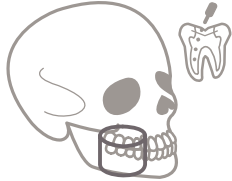
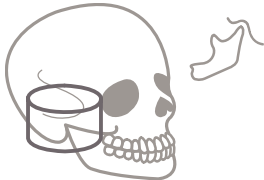
No.	Figure	Description
1		<p><u>Jaw</u> Commonly used to observe the patient's maxilla and mandible.</p>
2		<p><u>Jaw-Fast</u> Observing maxilla and mandible of the patient in fast scan (4.9sec) and low dose.</p>
3		<p><u>Large-Jaw</u> Commonly used to observe the patient's maxilla and mandible.</p>
4		<p><u>Tooth</u> Observing segment of maxilla and mandible.</p>
5		<p><u>Endodontics</u> Image is optimized for use in endodontic treatments. (4 x 3 Minimum)</p>
6		<p><u>TMJ (Temporomandibular Joint)</u> Used to observe TMJ.</p>

7



Sinus

Used to observe Sinus.

8

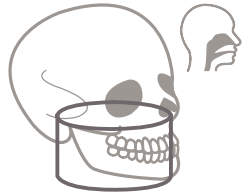

Airway

Used to observe Airway.

7.4.2 Cautionary Measures for Pre-Scanning

- ① Install hygienic cover over Bite Block and Chinrest.
- ② Open Temple Support to facilitate patient positioning.
- ③ Patient must remove all metal when undergoing scanning, including glasses, necklaces, earrings, hearing aids, etc.
- ④ Patient must wear a lead apron to protect against radiation.

7.4.3 CT Scanning Method

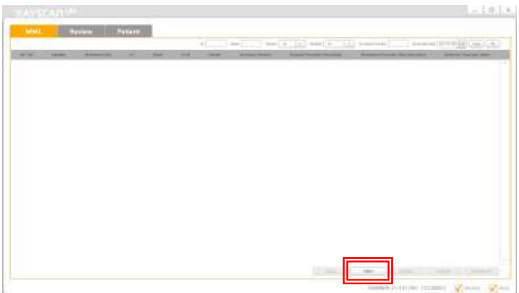
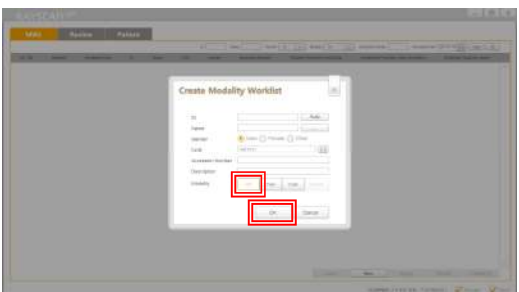
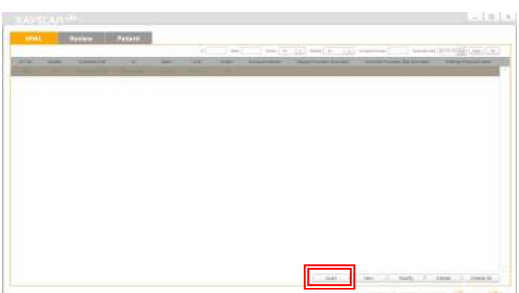
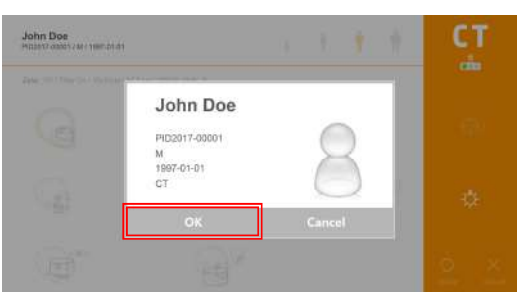
No.	Figure	Description
1		<p>Click MWL on the top left side of the screen and [New] button on the bottom right to register a new patient.</p>
2		<p>In Modality Worklist screen, select [CT] for Modality and click [OK] button.</p>
3		<p>Select the MWL created above and click [Scan] button on the bottom right.</p>
4		<p>Verify patient information and click [OK] button, then proceed to next step.</p>

5



Select the intended scanning protocol.

6



Select Patient Type, Tube Voltage and Tube Current based on the patient.

Using the remote control or touch screen, adjust equipment height to patient height and make sure that the patient's neck is as straight as possible. Once positioned, allow patient to hold on to the Patient Handle.

※ The remote control is not provided in Canada.

7



Position the patient according to the intended scanning Protocol.

(Refer to paragraph 7.4.4 for the positioning method)

Use [FOV] button on the THU and/or remote controller to get into FOV Mode. Go to “8-2” if FOV adjustment not needed.

※ The remote control is not provided in Canada.

8-1

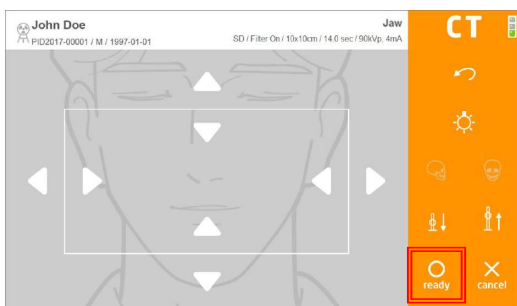

Press [ready] button after FOV adjustment on Console PC and/or the THU. The device moves to ready position for exposure.

8-2

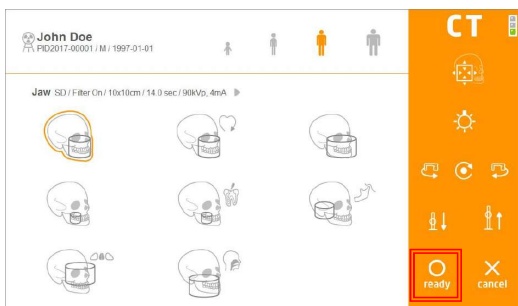

Once patient positioning is complete, press [ready] button on the touch screen.

9

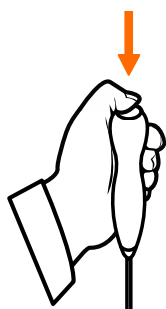

After the green light on the exposure switch has been illuminated, continue to press the switch until scanning has been completed.

Take care not to release the button during scanning as doing so will stop the scanning process.

Maintain audio and visual contact with the patient and x-ray unit during exposure. If the c-arm stops moving during exposure, or moves in an erratic way, release the exposure button immediately.

Note

10

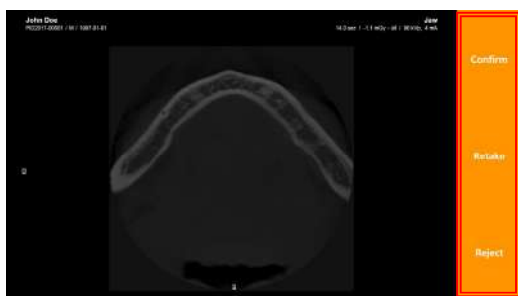

Once scanning is complete, select among the [Confirm/Retake/Reject] buttons.

※ **Operation description**

[Confirm]: Save image view and go to MWL screen.

[Retake]: Save image view and automatically go to Acquisition-Patient Info screen for retake.

[Reject]: Save Image View, indicate rejected image in the database, then go to MWL screen.

7.4.4 CT Patient Positioning Method

7.4.4.1 CT (Jaw, Jaw-Fast, Large-Jaw, Tooth, Endo, Airway) Position Method

No.	Figure	Description
1		<p>Install the Headrest. Please use it only for CT image acquisition.</p>
2		<p>As shown in the figure on the left, position the center of the patient's head (midsagittal plane, for example, middle of the forehead, nose, philtrum, etc.) in alignment with the vertical alignment beam. Avoid tilting the head to either side.</p>
3		<p>Once the patient is properly positioned, turn the lever to secure the patient with the Temple Support.</p>
4		<p>Position the laser beam anterior to the patient.</p> <div style="display: flex; align-items: center;">  <p>The laser beam must be positioned in front of the incisor. Note that do not get confused of Pano modality.</p> </div> <p>Caution</p>

Note Applying Headrest allows better image quality of CBCT.
 Adjust the Forehead support up and down to reach the patient.
 Column up and down adjustment allows the forehead support to reach the patient.

7.4.4.2 CT (Sinus) Position Method

No.	Figure	Description
-----	--------	-------------

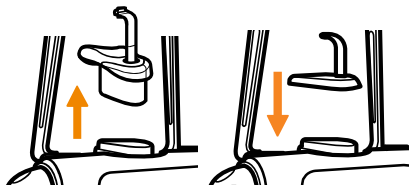

1

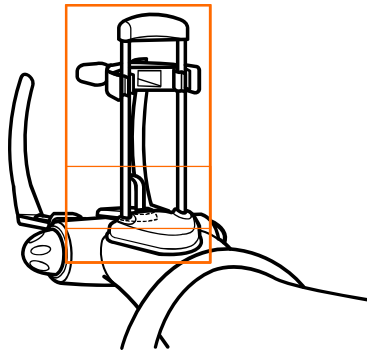

Push the Chinrest upward to detach. Install the Sinus Chinrest and Headrest.

2

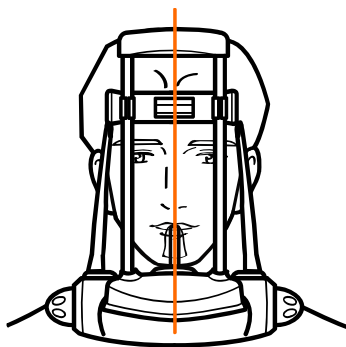

As shown in the figure on the left, position the center of the patient's head (midsagittal plane, for example, middle of the forehead, nose, philtrum, etc.) in alignment with the vertical alignment beam. Avoid tilting the head to either side.

3

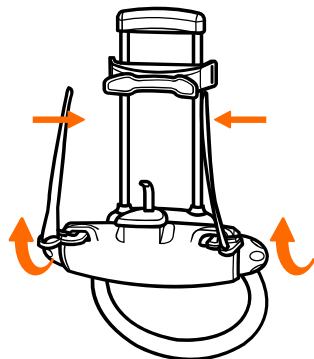

Once the patient is properly positioned, turn the lever to secure the patient with the Temple Support.

7.4.4.3 CT (TMJ) Position Method

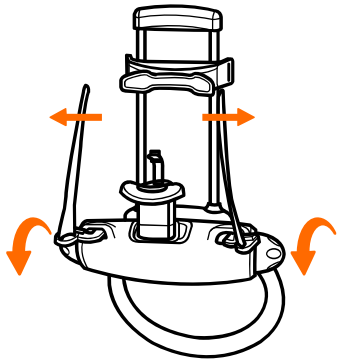
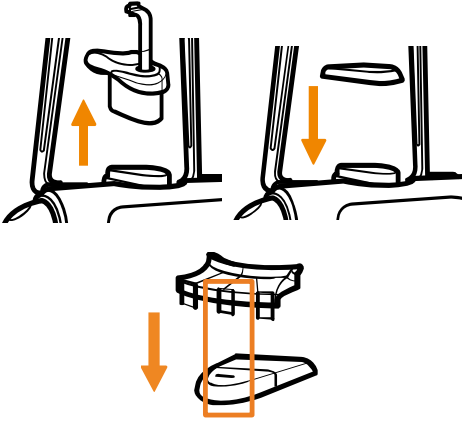
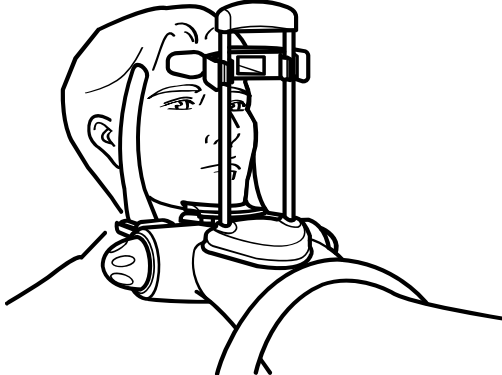
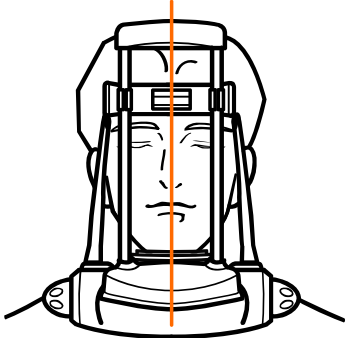
No.	Figure	Description
1		<p>Before positioning the patient, turn the lever to spread the Temple Support.</p>
2		<p>Push the Chinrest upward to detach, then install the Sinus Chinrest. The center of the TMJ Chinrest is equipped to meet the Bite Stick hole of the Sinus Chinrest.</p>
3		<p>Push the patient's lower jaw forward, to rest in the cup of the TMJ Chinrest.</p>
4		<p>As shown in the figure on the left, position the center of the patient's head (midsagittal plane, for example, middle of the forehead, nose, philtrum, etc.) in alignment with the vertical alignment beam. Avoid tilting the head to either side.</p>













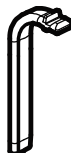

This page intentionally left blank.

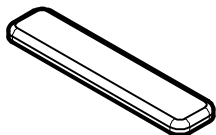
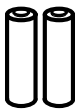
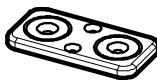
Accessories

8

8 ACCESSORIES

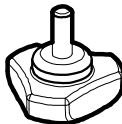
8.1 Accessories List

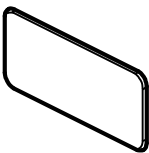
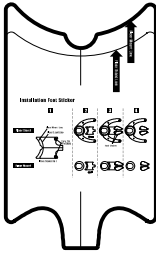
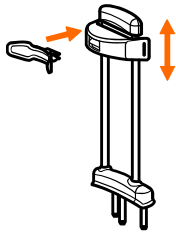
				
CHINREST	SINUS CHINREST	EDENTULOUS CHINREST	TMJ CHINREST	BITE BLOCK
				
FOOT STICKER	REMOTE CONTROL	AAA Battery [2EA]	REMOTE CONTROL STAND	REMOTE CONTROL STAND STICKER
				
TMJ Guide (L)	TMJ Guide (R)	PANO/CT Temple Support (L)	PANO/CT Temple Support (R)	ADJUSTMENT KNOB [2EA]
				
EXPOSURE SWITCH HOLDER	EXPOSURE SWITCH HOLDER STICKER	FOOT STICKER JIG	Headrest	

※ The remote control is not provided in Canada.

8.2 Remote Control Operating Procedure

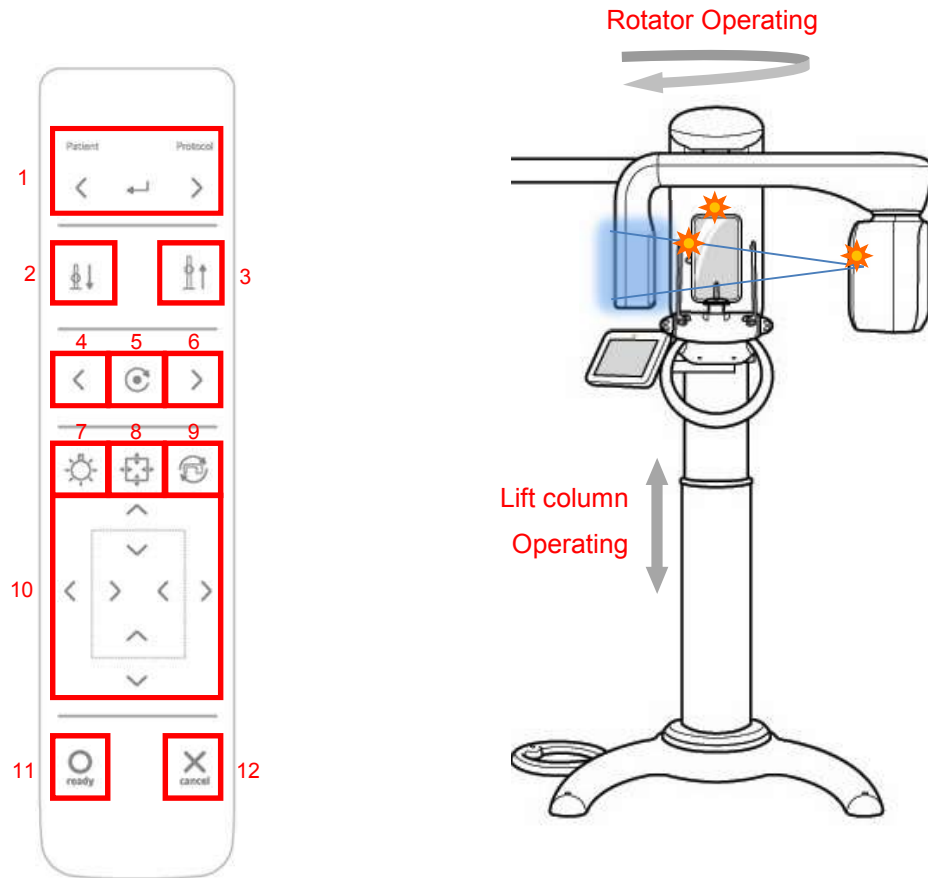

- Remote Control can control motions

No.	Item	Description
1	Patient, Protocol Select	Select the patient type and protocol.
2	Lift Column Down	Lowers system when pressed.
3	Lift Column Up	Raises system when pressed.
4	Canine Left	Move Canine Beam forward.
5	Canine Center	Move Canine Beam to center.
6	Canine Right	Move Canine Beam backward.
7	Lamp	Laser beam ON/OFF.
8	FOV	To enter the FOV adjustment mode.
9	90° rotation	Rotate the device by 90°.
10	Collimator adjust	Adjust the collimator

11	ready	Scanner ready button. When clicked, system moves to the start position.
12	cancel	Cancel button. Touch to cancel scanning, close scanning screen and return to the Splash screen.

- Omnidirectional Remote Control allows the user freedom of movement.
 - User can easily control the device while taking care of the patient.
 - Distinct button configuration facilitates ease-of-use.
 - Remote Control can be attached to the wall with the Remote Control Stand (included).
 - 2 AAA sized batteries are required. Replace when batteries are exhausted.



Warning

Stop holding the button from the wireless remote controller in case of hitting a patient due to movements such as up / down Lift Column and rotation of rotator. Use pre-motion function if it is needed to check clearly hitting a patient during the motions. Do not press remote buttons when device is out of sight. Always use the Remote Control with the device in sight. If the Remote Control will be inactive for a significant length of time, please remove the batteries.

※ The remote control is not provided in Canada.

8.2.1 How to Insert Batteries in the Remote Control

- ① Open the cover on the back side, as seen in the image below.
- ② Check +/- and insert two AAA size 1.5V batteries.
- ③ Close the cover.

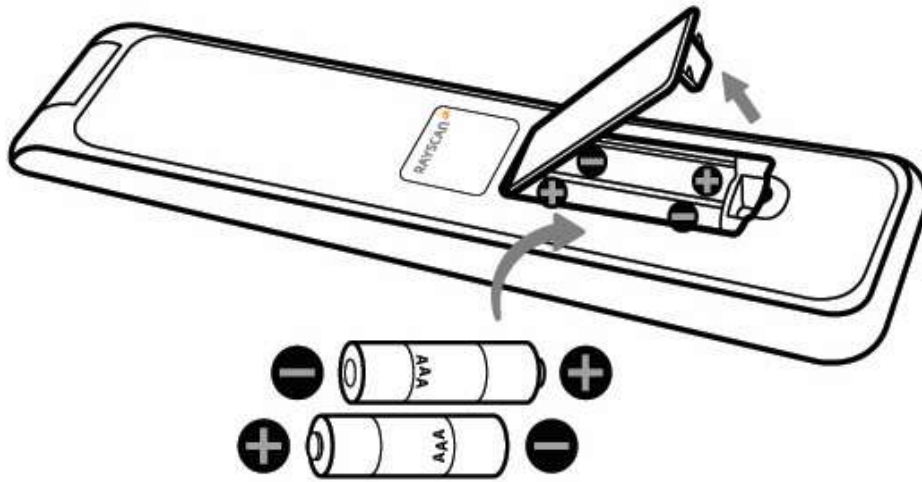

※ The remote control is not provided in Canada.

8.3 Temple Support Assembly

- 1) Piece together Pano/CT Temple Support (L) and Pano/CT Temple Support (R) into the Chinrest Mechanism, then screw in 2 Adjustment Knobs to secure.

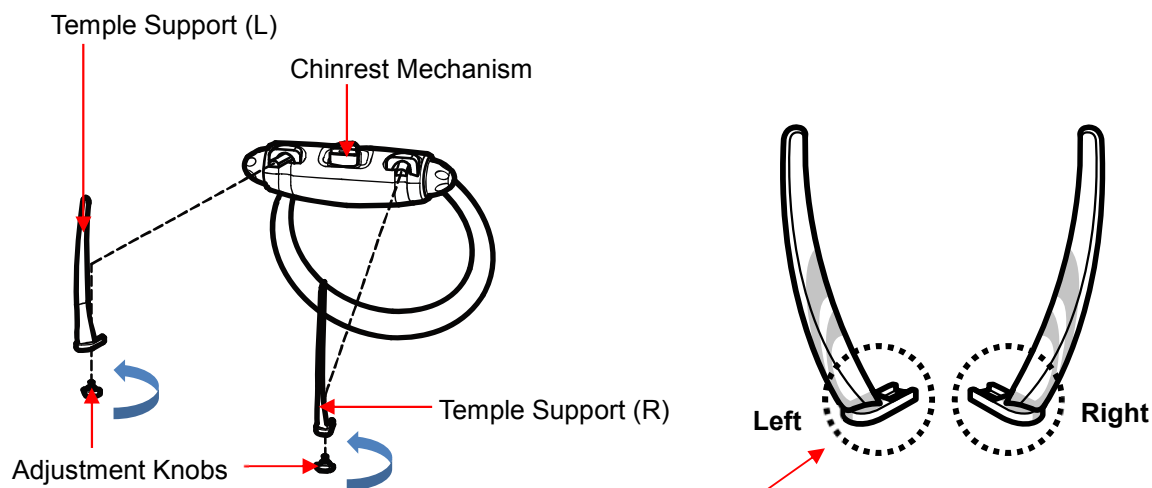

Caution

The rounded part of temple support must be mounted on the inner-side.
Check the marker "L", "R" in Temple support.

8.4 Bite Block and Chinrest Assembly

- 1) Attach Chinrest to upper part of Chinrest Mechanism then insert the Bite Block.

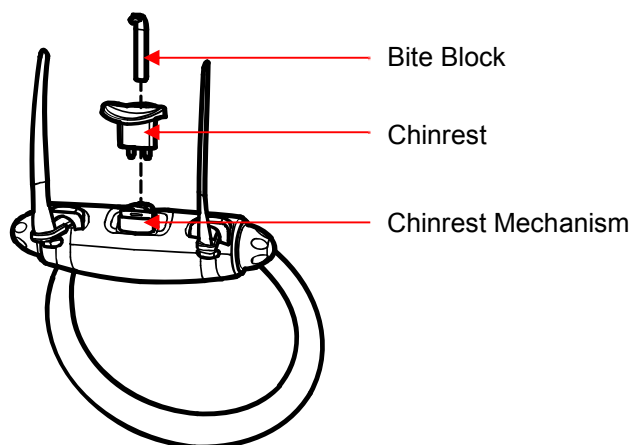

Caution

There are four kind of chinrest. Place with the proper chinrest.

8.5 Remote Control Stand Assembly

- 1) Use a Phillips screwdriver to secure 2 $\Phi 4 \times 20$ Flat Head Tapping Screws on the wall in the location chosen for the remote control stand.

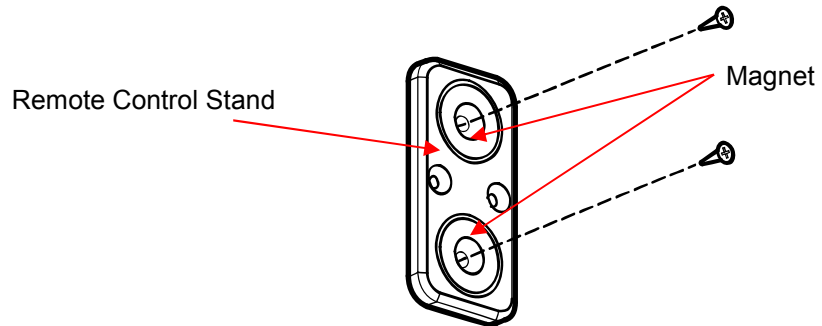

- 2) Attach the Remote Control Stand to the wall and cover surface with included Remote Control Stand Sticker.

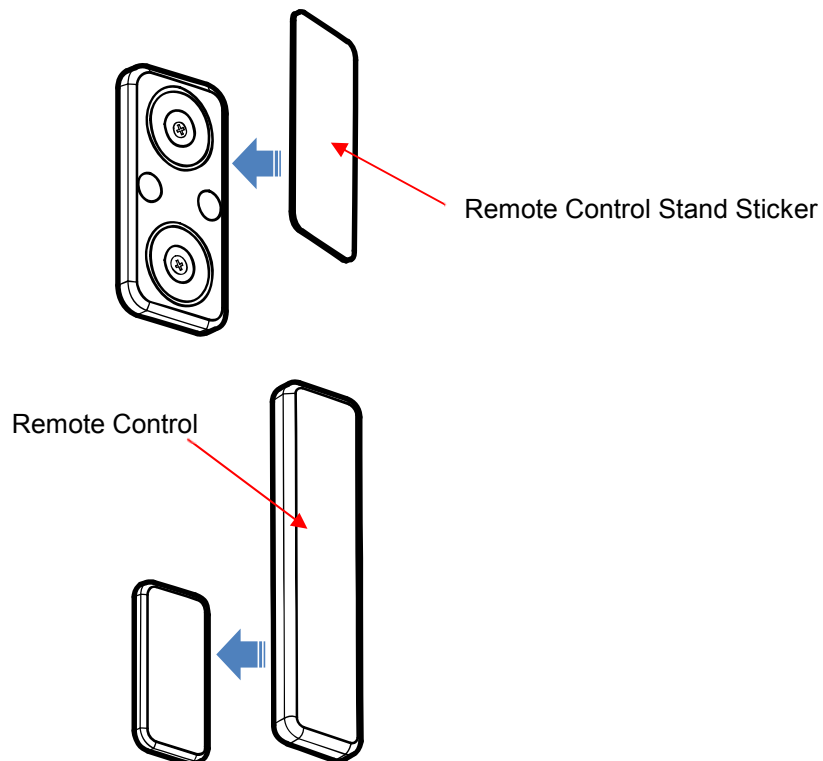

※ The remote control is not provided in Canada.

8.6 Exposure Switch Stand Assembly

- 1) Use a Phillips screwdriver to secure 3 $\Phi 4 \times 20$ Flat Head Tapping Screws in the wall chosen for the Exposure Switch Holder.

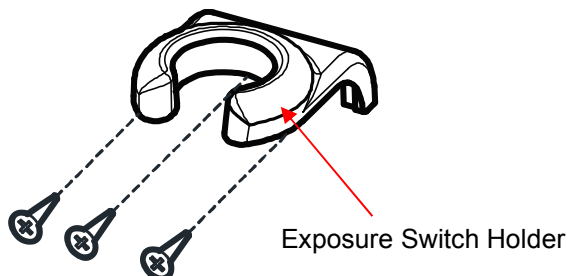

- 2) Mount the Exposure Switch Holder to the wall, then attach an Exposure Switch Holder Sticker to the surface of the Exposure Switch Holder.

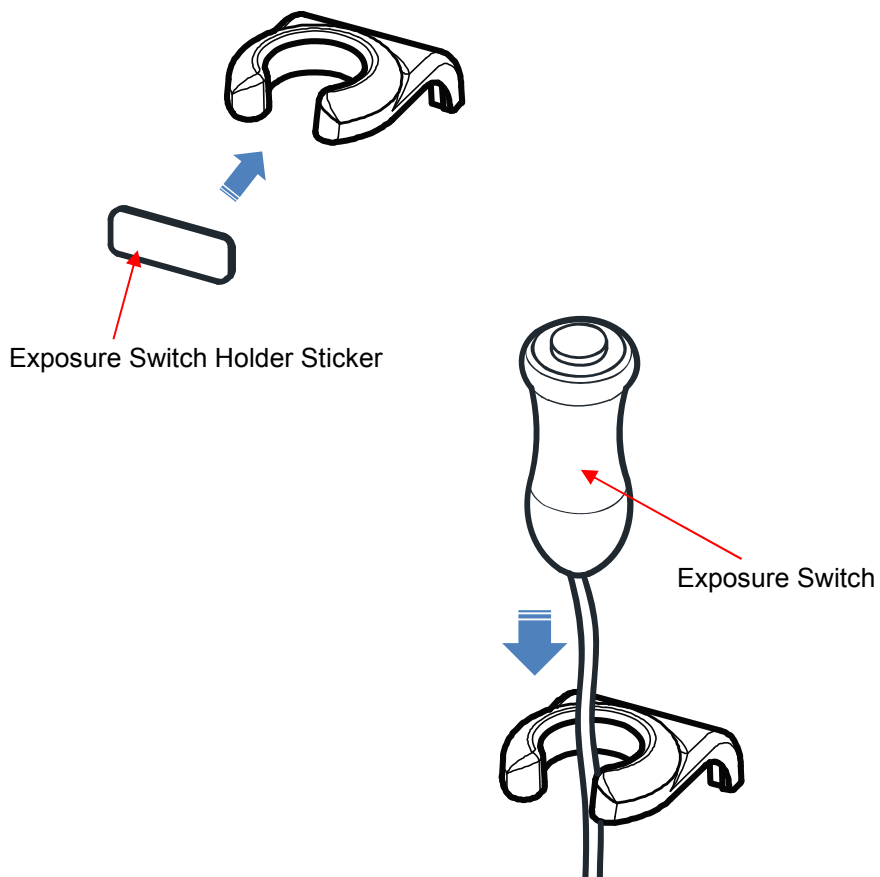

System Specifications

9

9 SYSTEM SPECIFICATIONS

9.1 Technical Specifications

Classification		Specification	Remark
Rated Voltage		100-240V~, 50/60Hz	
Power Consumption		2.5kVA Max	
Operation Mode		Continuous operation with intermittent loading.	
Max.permissible apparent impedance of supply mains		0.8Ω(100V)	
Overcurrent Circuit		30A	
Form and Degree of Electric Shock		Class 1, Type B	
Total Filtration		2.8mmAl/90IEC60522	
X-ray	X-ray Tube	Tube Voltage: 50~110kV Tube Current: Max 22mA Focal Point Size: 0.5mm Target Angle: 5° Heat Capacity: 35kJ	
	High-Voltage Generator	Tube Voltage: 60~90kV(±10%) Tube Current: 4~17mA(±20%) Power Input: 2.185kW Power Output: 1.530kW (less than 3s exposure) Inherent Filtration: 1.8mmAl (Tube+insulating oil+case) Added Filtration: 1.0mmAl	
	Cooling Time	Temperature is monitored and displayed on the screen with a color code. Green indicates that another scan can be performed immediately. Yellow or Red indicates that the user must wait either 3 or 5 minutes respectively.	
	Loading Factor	Max. kV when mA : 90kV/17mA Max. mA when kV : 17mA/90kV	

X-ray Detector	For Panoramic Use	Pixel Size: 100um Pixel Matrix: 60x1512 Pixel Area: 6.0mm(W)x151.2mm(H)	Option
	For Panoramic Use	Pixel Size: 150um Pixel Matrix: 960x786 Pixel Area: 144.0mm(W)x117.9mm(H)	Option
	For Panoramic Use	Pixel Size: 100um Pixel Matrix: 48x1500 Pixel Area: 4.8mm(W)x150mm(H)	Option
	For CEPH Use (One Shot S Type)	Pixel Size: 139um Pixel Matrix: 2176x1792 Pixel Area: 302mm(W)x249mm(H)	Option
	For CEPH Use (One Shot L Type)	Pixel Size: 139um Pixel Matrix: 3072x2560 Pixel Area: 427mm(W)x356mm(H)	Option
	For CEPH Use (Scan Type)	Pixel Size: 100um Pixel Matrix: 48x2400 Pixel Area: 4.8mm(W)x240mm(H)	Option
	For CT Use	Pixel Size: 150um Pixel Matrix: 960x786 Pixel Area: 144.0mm(W)x117.9mm(H) Pixel resolution: above 1 lp/mm	
SID		CT: 661mm Pano: 657mm Ceph(Scan): 1663mm Ceph(Oneshot-S): 1663mm Ceph(Oneshot-L): 1504mm	
Tube Voltage	CT	Child: 60~90kV Adult: 60~90kV	
	Pano	Child: 69~90kV Adult: 60~90kV	
	Ceph	Child: 60~90kV Adult: 90~90kV	
Tube Current	CT	Child: 4~17mA Adult: 4~17mA	

	Pano	Child: 4~12mA Adult: 4~17mA	
	Ceph	Child: 4~17mA Adult: 4~17mA	
Exposure Time	CT	Child: ~14s Adult: ~14s	
	Pano	Child: ~14s Adult: ~14s	
	Ceph(Scan)	Child: ~19s Adult: ~19s	
	Ceph(Oneshot)	Child: ~0.8s Adult: ~0.8s	
Magnification		CT: 1.39 Pano: 1.31 Scan Ceph: 1.11 Oneshot Ceph: 1.13	
Alignment Beam	IEC60825-1 Safety Ratings	Class I	
	Wavelength	650nm±20nm	
	Output power	<1mW	
Apparatus Specifications	Size	1,118mm(W)×1,481mm(D)×2,296mm(H)	
	One Shot S Type CEPH Inclusive	1,831mm(W)×1,481mm(D)×2,296mm(H)	
	One Shot L Type CEPH Inclusive	1,672mm(W)×1,481mm(D)×2,296mm(H)	
	Scan Ceph Inclusive	1,831mm(W)×1,481mm(D)×2,296mm(H)	
	Weight	185kg±10%	
	One Shot S Type CEPH Inclusive	211kg±10%	
	One Shot L	211kg±10%	

	Type CEPH Inclusive		
	Scan Ceph Inclusive	212.5kg±10%	
Quantity per pack		1 SET	
Lift Column Height Control	Stroke	670mm	
Software		RayScan ver. 2.1 or higher	
Workstation	OS	Windows 7, 64Bit	Use products with certificate from National or Accredited Organization.
	CPU	Intel Dual Core or higher	
	RAM	8GB or higher	
	HDD	1TB or higher	
	Network	Gigabit Ethernet	
Operating Environment	Ambient Temperature Range	15°C ~ 25°C	
	Relative Humidity	20%~ 60%	
	Atmospheric Pressure Range	700hPa ~1060hPa	
Transport & Storage Environment	Temperature Range	-10°C ~ 50°C	
	Relative Humidity	10%~ 90%	
	Atmospheric Pressure Range	700hPa ~1060hPa	

9.1.1 X-ray Tube

9.1.1.1 Maximum Rating Charts

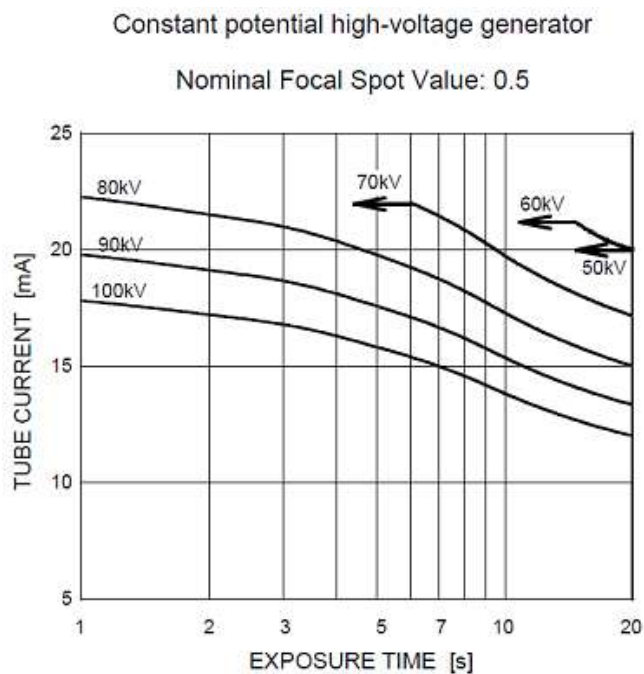

9.1.1.2 Emission & Filament Characteristics

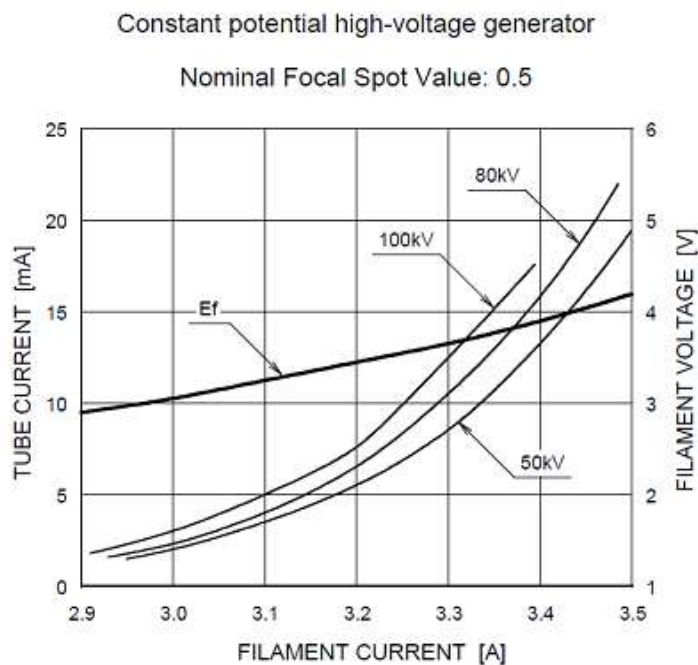

9.1.1.3 Anode Thermal Characteristics

Anode Thermal Characteristics

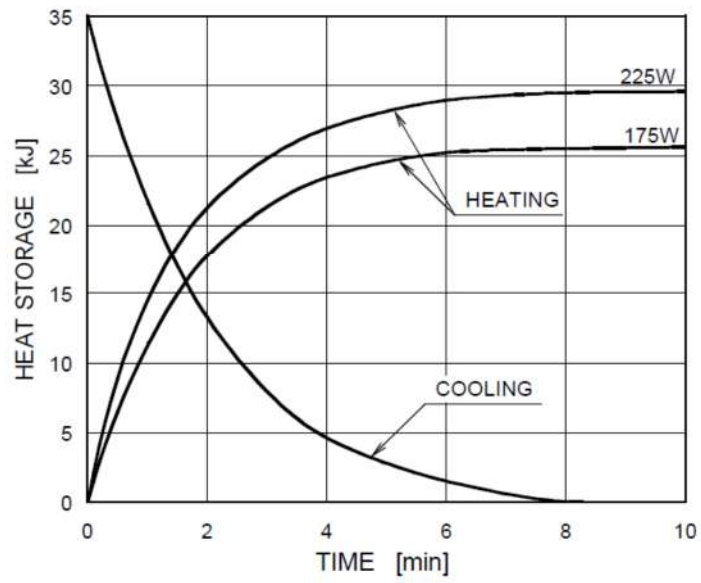

9.1.1.4 Dimensional Outline

Unit: mm

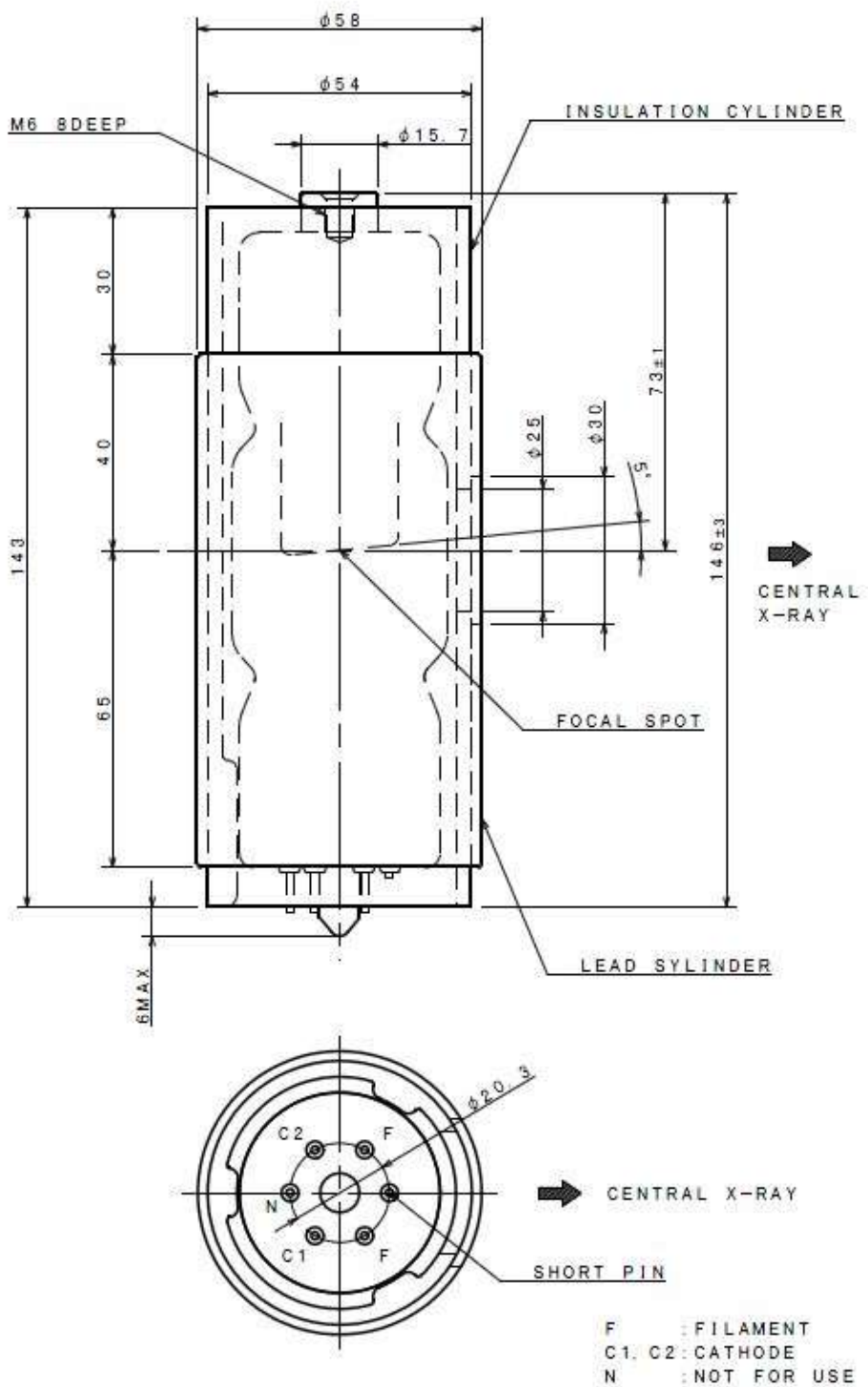

9.2 Dose Information

9.2.1 Patient Population

The patient population can be the possible person who can be taken X-ray diagnostic radiation exposure.

There is no restriction for ethnic group, Gender, weight, health, or condition.

We recommend patients for X-ray diagnostic radiation exposure to be over 5 years old.

9.2.2 Pediatric Subpopulation

This device is not intended for use on patients less than approximately 21 kg (46 lb) in weight and 113 cm (44.5 in) in height; these height and weight measurements approximately correspond to that of an average 5 year old according to FDA guidance “Pediatric Information for X-ray Imaging Device Premarket Notifications. (Draft Guidance)”

- a. 5 year old [~21 kg, 113 cm standing height]: Child
- b. 12 year old [~52 kg, 156 cm standing height]: Overlap small size adults
- c. 21 year old [~80 kg, 170 cm height]: Adult
- d. Adult [more than 80 kg, 180 cm standing height]: Large Adult

Radiation exposure is a concern in both adults and children. However, children are more sensitive to radiation than adults and have a longer life expectancy. Radiation risk is higher in young patients, as they have more rapidly dividing cells than adults. The younger the patient, the more sensitive they are. Using the same exposure parameters on a child as used on an adult may result in larger doses to the child. There is no need for these larger doses to children, and X-ray settings can be adjusted to reduce dose significantly while maintaining diagnostic image quality.

Please refer the web pages regarding additional pediatric information.

- FDA's Pediatric X-ray Imaging webpage:
<http://www.fda.gov/Radiation-EmittingProducts/RadiationEmittingProductsandProcedures/MedicalImaging/ucm298899.htm>
- The Image Gently Back to Basics campaign materials:
<http://www.pedrad.org/associations/5364/ig/?page=824>

9.2.3 Procedures Performed

9.2.3.1 Panoramic/CEPH

- X-ray dosage is noted as $\text{mGy}\cdot\text{cm}^2$ (dose area product) and measured in the primary collimator. The dosage has $\pm 25\%$ tolerance.

9.2.3.2 CT

- X-ray dosage is noted as CTDIvol (mGy) and has $\pm 25\%$ tolerance.
- X-ray dosage is measured at the center of the patient position and 3, 6, 9, 12 o'clock.
- Positions in the pencil ionization chamber.
- The measured value is used to calculate CTDIw.
- $\text{CTDI}_{100} = [f \times \text{measured value}] / (\text{beam width})$, conversion factor $f=0.0087\text{mGy/mR}$
- $\text{CTDI}_w = 1/3\text{CTDI}_{100} \text{ center} + 2/3\text{CTDI}_{100}$ (mean value of 4 positions)
- CT consists of 1 revolution imaging, therefore CTDIw and CTDIvol are equivalent.
- $\text{CTDI}_{\text{vol}} \leq 20\text{mGy}$ at CT condition of operation. (Tube voltage: 85kV, Tube current: 5mA, Exposure time: 14s)

9.3 FOV Variable range

9.3.1 Panorama Protocol

Protocol		WxH Default (cm)	WxH Min. (cm)	WxH Max. (cm)
Standard	Normal	23x11	23x2	23x11
	PED	20x8	20x2	20x11
	Wide	25x11	25x2	25x11
Standard (Segment)		Selection	H 2	H 11
Bitewing		13x8	13x2	13x11
TMJ	TMJ Close	26x11	26x2	26x11
	TMJ Open	14x11	14x2	14x11
Sinus		11x11	11x2	11x11
Orthogonal		18x11	18x2	18x11

9.3.2 CT Protocol

Protocol	CT130			CT160			
	ΦxH Default (cm)	ΦxH Min. (cm)	ΦxH Max. (cm)	ΦxH Default (cm)	ΦxH Min. (cm)	ΦxH Max. (cm)	
Jaw	10x10	8x3	12x10	10x10	8x3	12x10	
Jaw-Fast	8x10	6x3	8x10	8x10	6x3	8x10	
Large-Jaw	13x10	10x8	13x10	16x10	12x8	16x10	
Tooth	5x5	4x3	6x6	5x5	4x3	6x6	
Endodontics	4x4	4x3	6x6	4x4	4x3	6x6	
TMJ	Left	8x6	8x3	12x10	8x6	8x3	12x10
	Right	8x6	8x3	12x10	8x6	8x3	12x10
	Both	-	-	-	16x6	12x3	16x10
Sinus	13x10	8x3	13x10	14x10	12x3	15x10	
Airway	12x10	8x3	12x10	12x10	12x3	15x10	

9.3.3 Cephalo (One shot S-type)

Protocol	WxH Default (cm)	WxH Min. (cm)	WxH Max. (cm)
LAT	30x25	8x8	30x25
PA	30x25	8x8	30x25
Carpus	30x25	8x8	30x25
SMV	30x25	8x8	30x25
Waters	30x25	8x8	30x25
Reverse Towne	30x25	8x8	30x25

9.3.4 Cephalo (One shot L-type)

Protocol	WxH Default (cm)	WxH Min. (cm)	WxH Max. (cm)
LAT	33x33	8x8	33x33
PA	33x33	8x8	33x33
Carpus	33x33	8x8	33x33
SMV	33x33	8x8	33x33
Waters	33x33	8x8	33x33
Reverse Towne	33x33	8x8	33x33

9.3.5 Cephalo (Scan type)

Protocol	WxH Default (cm)	WxH Min. (cm)	WxH Max. (cm)
LAT-Fast	20x24	20x8	26x24
PA-Fast	24x24	8x8	26x24
Carpus	22x24	8x8	26x24
LAT	20x24	20x8	26x24
PA	24x24	8x8	26x24
SMV	24x24	8x8	26x24

9.4 Stray Radiation

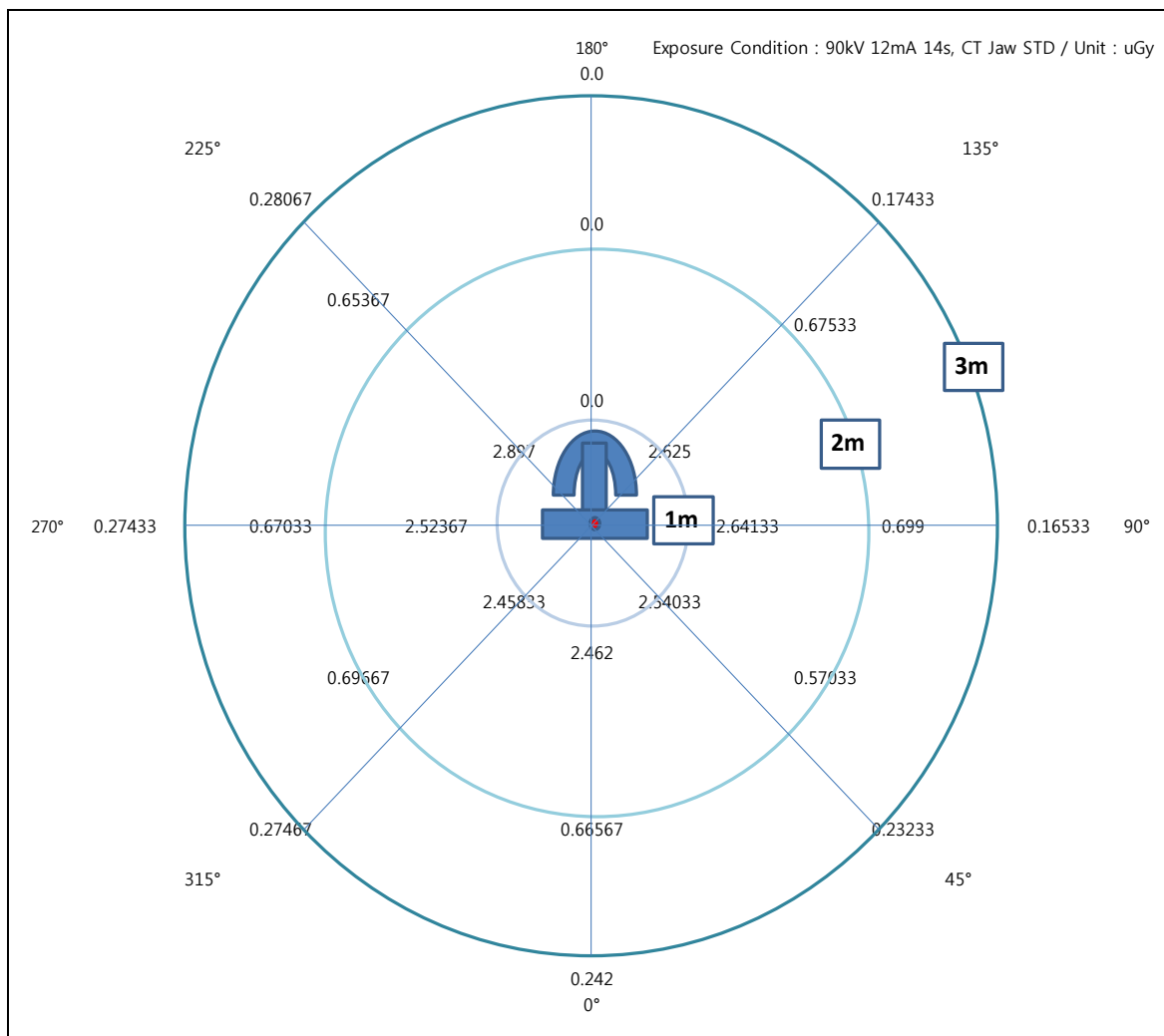

Angle (°)	Measuring Point	Distance (m)	uGy/mAs
0	1	1	0.015
	2	2	0.004
	3	3	0.001
45	4	1	0.015
	5	2	0.003
	6	3	0.001
90	7	1	0.016
	8	2	0.004
	9	3	0.001
135	10	1	0.016
	11	2	0.004
	12	3	0.001
180	13	1	Not measured
	14	2	Not measured
	15	3	Not measured
225	16	1	0.017
	17	2	0.004
	18	3	0.002
270	19	1	0.015
	20	2	0.004
	21	3	0.002
315	22	1	0.015
	23	2	0.004
	24	3	0.002

9.5 Imaging Performance

9.5.1 Panoramic

Characteristics of Sensitivity, Dynamic range, MTF, DQE

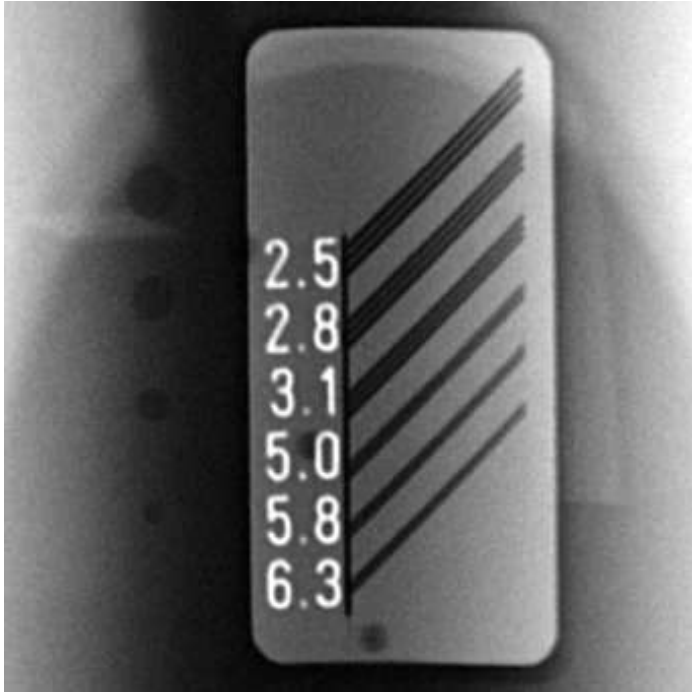
PANORAMIC			Sensitivity	5.5 GL/nGy
			Dynamic range	16000
			MTF	60% at 1 lp/mm
			DQE	45% at 1 lp/mm
Low Contrast Resolution				Verdict
				P
X-ray Tube Condition			Measured Value	
Voltage (kV)	Current (mA)	Time (sec)	Low Contrast Resolution (Step)	Criteria
78	14	13.9	4	
Producing Low Contrast Resolution \geq 2 step				
Line Pair Resolution				Verdict
				P
X-ray Tube Condition			Measured Value	
Voltage (kV)	Current (mA)	Time (sec)	Line Pair Resolution (lp/mm)	Criteria
78	14	13.9	3.1	
Line Pair Resolution \geq 2.5				
Image				
				

9.5.2 CT

Characteristics of Sensitivity, Dynamic range, MTF, DQE, Mean CT Number, Uniformity and Spatial Resolution

CT			Sensitivity	0.8 GL/nGy
			Dynamic range	16000
			MTF	60% at 1 lp/mm
			DQE	45% at 1 lp/mm
Noise				Verdict
				P
X-ray Tube Condition			Measured Value	
Voltage (kV)	Current (mA)	Time (sec)	Contrast/Noise Ratio	Criteria
90	6	14	30.096%	CNR ≥ 20%

Image

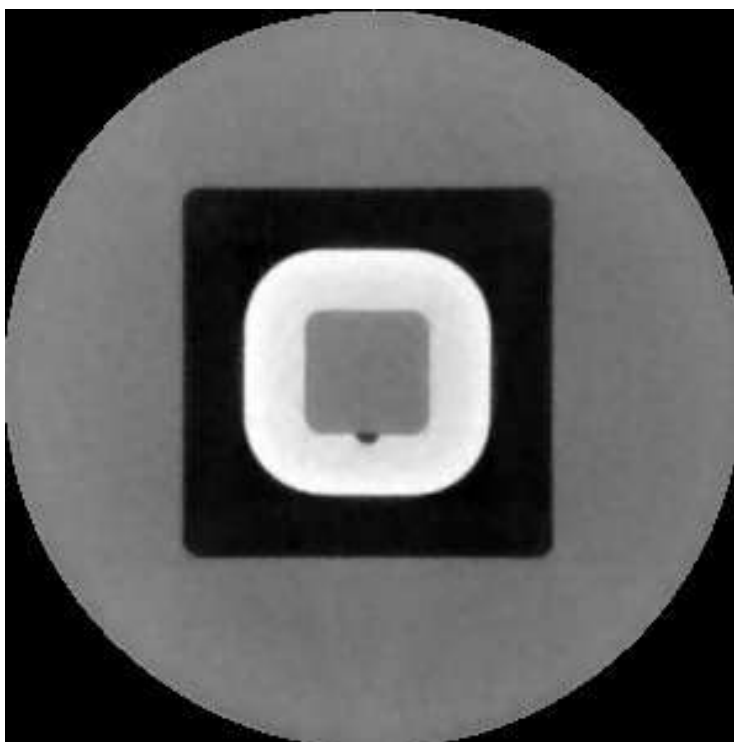

Edge between lines: 15 & 24
Noise: 27.711 (R)
Contrast: 834.000 (K)
Contrast / Noise ratio: 30.096 (K/R)

Mean CT Number						Verdict
X-ray Tube Condition			Measured Value			P
Voltage(kV)	Current (mA)	Time (sec)	CT number (HU)			Criteria
			Area	CT number	Average	
90	6	14	Upper	68.225	12.451	-100HU ≤Average≤ 100HU
			Lower	-25.583		
			Left	53.203		
			Right	-46.041		

Image

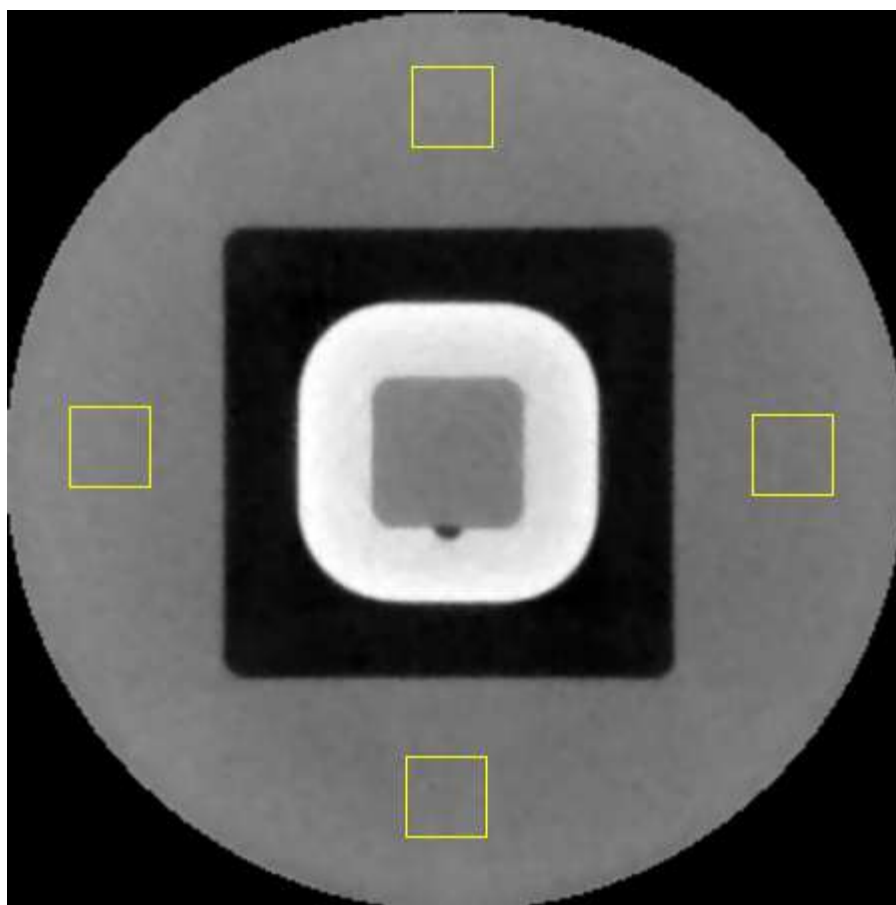

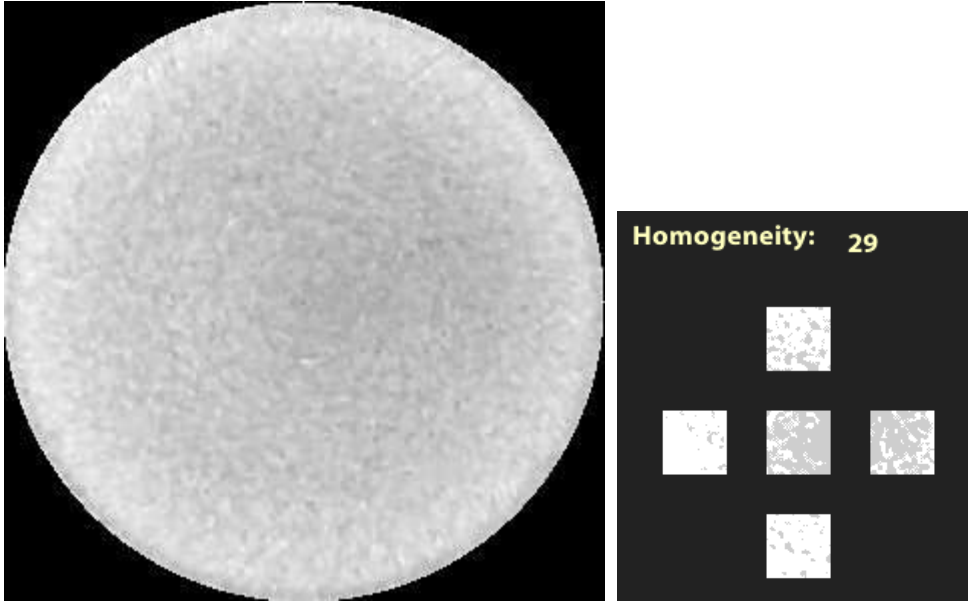
Uniformity				Verdict
				P
X-ray Tube Condition			Measured Value	Criteria
Voltage (kV)	Current (mA)	Time (sec)	Homogeneity	
90	6	14	29	Homogeneity \geq 25
Image				
				

Spatial Resolution				Verdict
				P
X-ray Tube Condition			Measured Value	Criteria
Voltage (kV)	Current (mA)	Time (sec)	MTF 10% (lp/mm)	
90	6	14	1.12 lp/mm	MTF10% ≥ 1.0lp/mm

Image

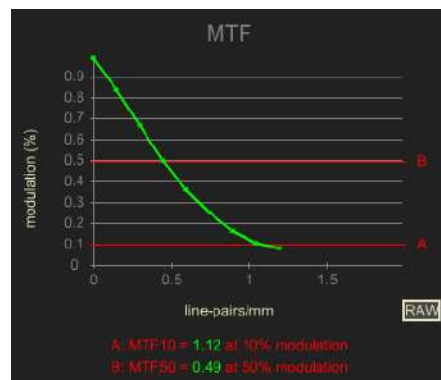
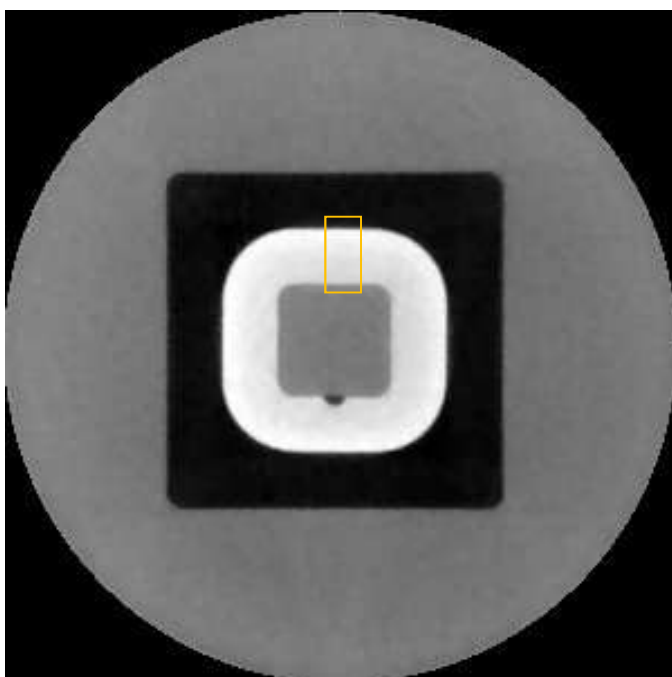

9.5.3 CEPH (One Shot L Type)

Characteristics of Sensitivity, Dynamic range, MTF, DQE

Ceph (One shot L Type)				Sensitivity	0.412 LSB/nGy
				Dynamic range	54000
				MTF	54% at 1 lp/mm
				DQE	0.2 at 1 lp/mm
Low Contrast Resolution					Verdict
					P
X-ray Tube Condition				Measured Value	
Voltage (kV)	Current (mA)	Time (sec)	Low Contrast Resolution (Step)		Criteria
90	16	0.3	4		Producing Low Contrast Resolution ≥ 1 step
Line Pair Resolution					Verdict
					P
X-ray Tube Condition				Measured Value	
Voltage (kV)	Current (mA)	Time (sec)	Line Pair Resolution (lp/mm)		Criteria
90	16	0.3	3.1		Line Pair Resolution ≥ 2.5
Image					

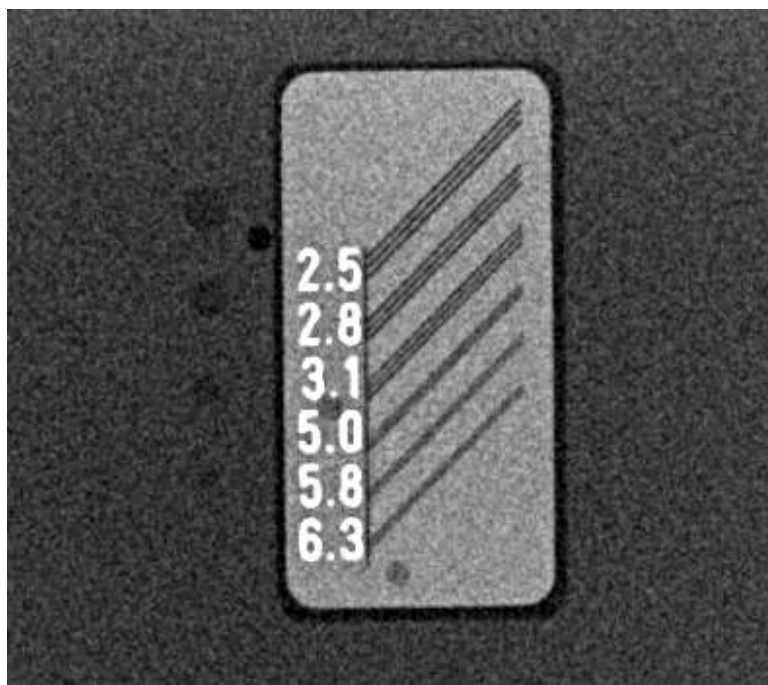

9.5.4 CEPH (One Shot S Type)

Characteristics of Sensitivity, Dynamic range, MTF, DQE

Ceph (One shot S Type)		Sensitivity		2400 ADU/uGy
		Dynamic range		15000
		MTF		54% at 1 lp/mm
		DQE		0.2 at 1 lp/mm
Low Contrast Resolution				Verdict
				P
X-ray Tube Condition			Measured Value	Criteria
Voltage (kV)	Current (mA)	Time (sec)	Low Contrast Resolution (Step)	
90	16	0.3	4	Producing Low Contrast Resolution \geq 1 step
Line Pair Resolution				Verdict
				P
X-ray Tube Condition			Measured Value	Criteria
Voltage (kV)	Current (mA)	Time (sec)	Line Pair Resolution (lp/mm)	
90	16	0.3	3.1	Line Pair Resolution \geq 2.5
Image				

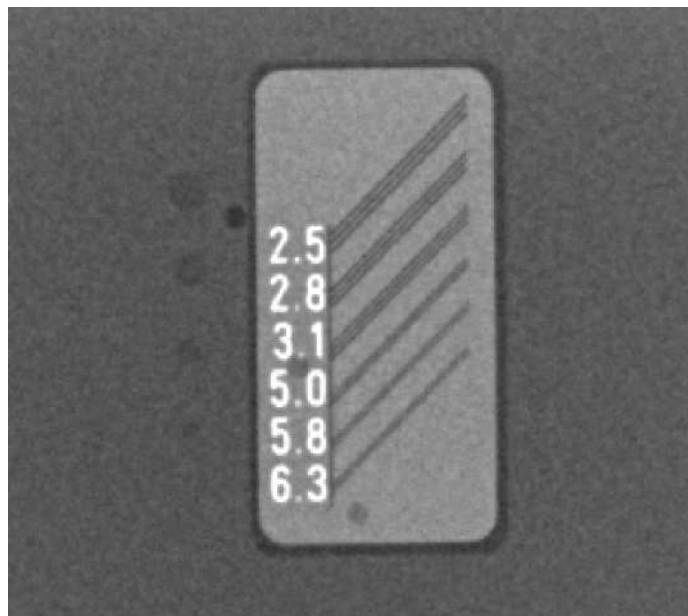

9.5.5 CEPH (Scan Type)

Characteristics of Sensitivity, Dynamic range, MTF, DQE

Ceph (Scan type)				Sensitivity	117000 LSB / mR
				Dynamic range	≥72dB
				MTF	75% at 1 lp/mm
				DQE	0.88 at 1 lp/mm
Low Contrast Resolution					Verdict
					P
X-ray Tube Condition				Measured Value	
Voltage (kV)	Current (mA)	Time (sec)	Low Contrast Resolution (Step)	Criteria	
85	10	15	4	Producing Low Contrast Resolution ≥ 1 step	
Line Pair Resolution					Verdict
					P
X-ray Tube Condition				Measured Value	
Voltage (kV)	Current (mA)	Time (sec)	Line Pair Resolution(lp/mm)	Criteria	
85	10	15	3.1	Line Pair Resolution ≥ 2.5	
Image					

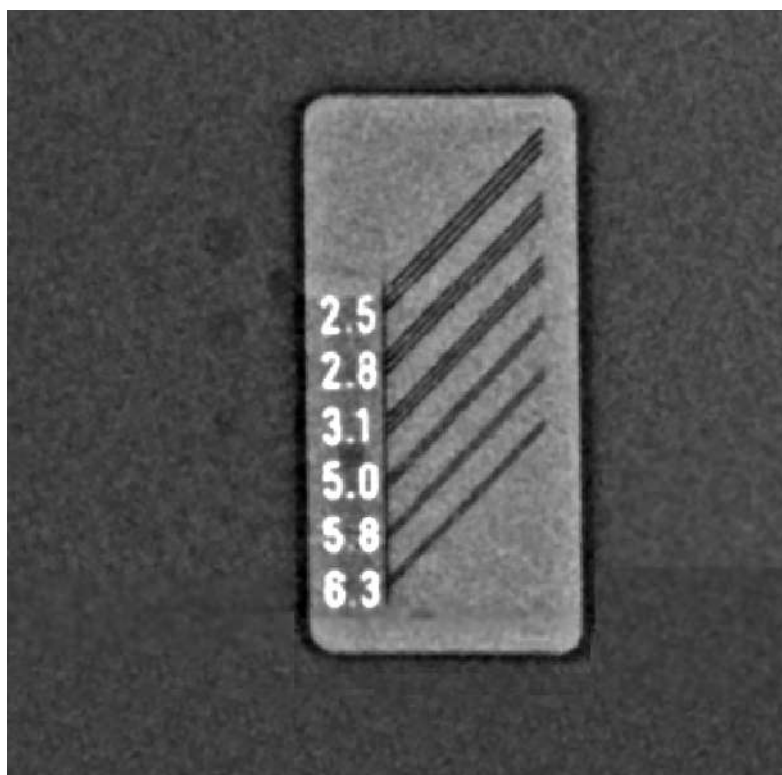

Quality Assurance Control

10

10 QUALITY ASSURANCE CONTROL

10.1 CT Quality Assurance Control

10.1.1 Qualification and Monitoring Frequency

In order to ensure the operational safety and functional reliability of your product, operator or physician who reads this instruction for use should check the equipment at regular intervals (at least 6 months) or contact RAY service center or your local RAY representative.

10.1.2 Quality Control Test and Acceptance Limit

① Quality control test tool

- QUART DVT_KP (Art. No. 12131, QUART, Germany): Universal tool for QA/QC within the full range of Cone Beam CT (DIN 6868-161)

② Quality control test & Acceptance limit

- Noise test: $CNR \geq 20\%$
- Contrast scale/Mean CT number: Water: 0 ± 100 HU / Air: -1000 ± 100 HU
- Spatial Resolution: MTF at 10% ≥ 1.0 lp/mm
- Uniformity test: Homogeneity ≥ 25

10.1.3 Quality Control Maintenance Tool (Phantom Information)

The QUART is made of polymethyl-methacrylate (PMMA) containing all required test objects for quality control as well as positioning tools for reproducible placement:

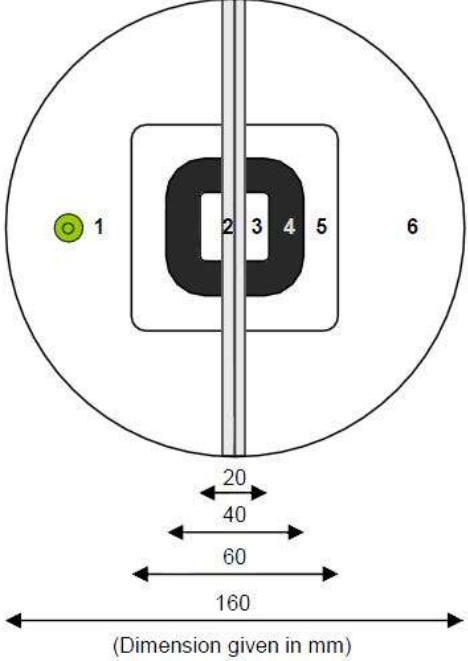
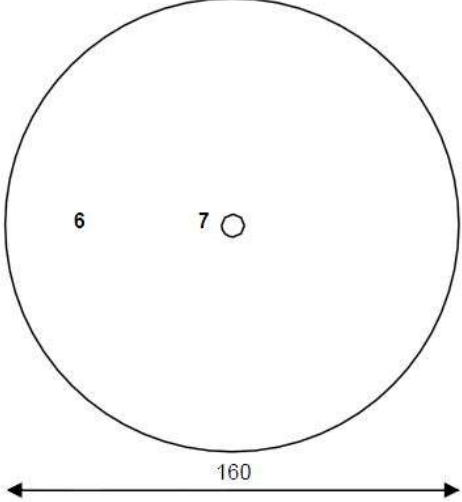
Disc 1: Test objects / Centering aide / Level	Disc 2: Homogeneity part
	
<p>1 Level (for horizontal line-up) 2 Centering Aide 3 PMMA (tissue equivalent) 4 PVC (bone equivalent) 5 Air 6 PMMA</p>	<p>6 PMMA 7 Fixation Aide (depends on phantom version)</p>
<p>Dimension: Diameter 160mm</p>	
<p>Thickness: 20mm (each disc 1 and 2)</p>	
<p>Physical Properties: Density PMMA 1.19 g/cm³ (± 1%) / Density PVC 1.41 g/cm³ (± 3%)</p>	

10.1.4 Quality Assurance Control Test

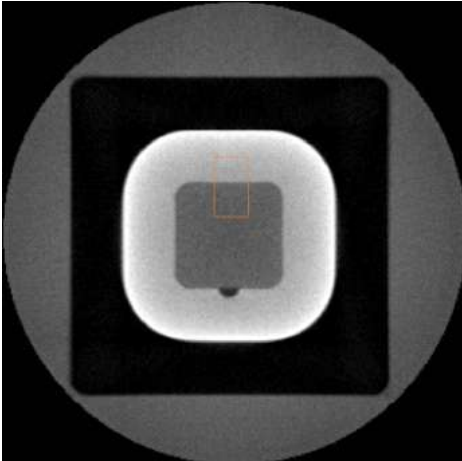
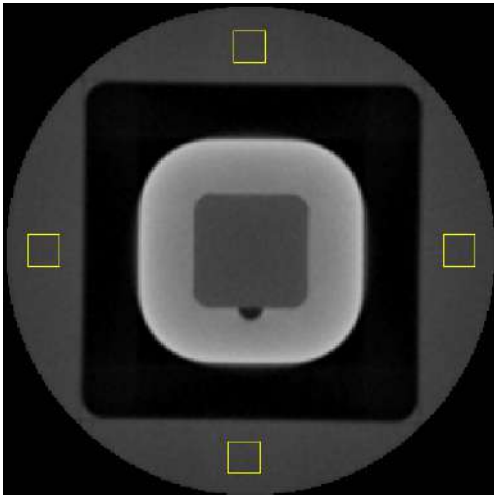
Noise Test	
Test Method	<ol style="list-style-type: none"> 1. Place DVT_KP phantom in CT FOV. 2. Scan CT 3. Measure the CNR after scanning DVT_KP phantom. <div style="text-align: center;">  </div> <p>* Worst case Condition * Prototype, Production and Assembler tests use same methods</p>
Quality Criteria	CNR ≥ 20%
Contrast scale, Mean CT number	
Test Method	<ol style="list-style-type: none"> 1. Place DVT_KP phantom in CT FOV. 2. Scan CT 3. Measure the CT number after scanning DVT_KP phantom. <div style="text-align: center;">  </div> <p>* Worst case Condition * Prototype, Production and Assembler tests use same methods</p>
Quality Criteria	CT number Water: 0 ± 100 HU / Air: -1000 ± 100 HU

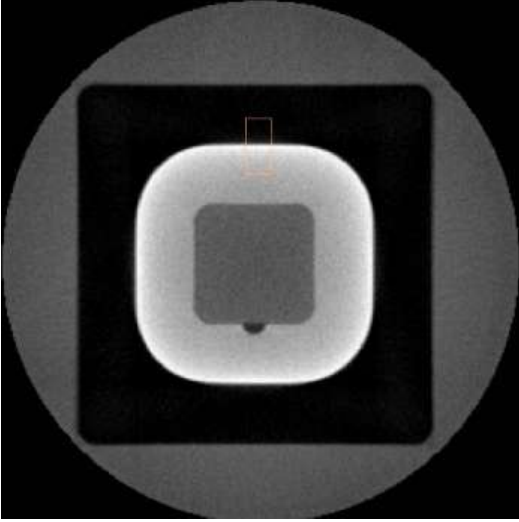
Spatial Resolution+6	
Test Method	<ol style="list-style-type: none"> 1. Place DVT_KP phantom in CT FOV. 2. Scan CT 3. Check the phantom resolution after scanning DVT_KP phantom.  <p>* Worst case Condition * Prototype, Production and Assembler tests use same methods</p>
Quality Criteria	MTF10% \geq 1.0 lp/mm

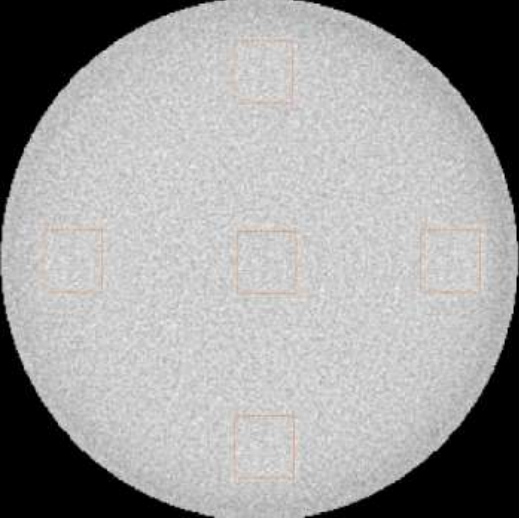
Uniformity Test	
Test Method	<ol style="list-style-type: none"> 1. Place DVT_KP phantom in CT FOV. 2. Scan CT 3. Measure the homogeneity after scanning DVT_KP phantom.  <p>* Worst case Condition * Prototype, Production and Assembler tests use same methods</p>
Quality Criteria	Homogeneity \geq 25

10.2 Panoramic and CEPH Quality Assurance Control

10.2.1 Qualification and Monitoring Frequency

In order to ensure the operational safety and functional reliability of your product, operator or physician who reads this instruction for use should check the equipment at regular intervals (at least 6 months) or contact RAY service center or your local RAY representative.

10.2.2 Quality Control Test and Acceptance Limit

① Quality Control Test Tool

- QUART Dent/Digitest 2.1 (Art. No. 12107, QUART, Germany): Universal OPG Testing (IEC 61223-3-4, IEC 61223-2-7, DIN 6868-151, DIN 6868-5)

② Quality Control Test & Acceptance Limit

- Line Pair Resolution
 - a. Panoramic Line Pair Resolution ≥ 2.5 lp/mm
 - b. CEPH Line Pair Resolution ≥ 2.5 lp/mm
- Low Contrast Resolution
 - a. Panoramic Low Contrast Resolution ≥ 2 step
 - b. CEPH Low Contrast Resolution ≥ 1 step

10.2.3 Quality Assurance Control Test

10.2.3.1 Panoramic

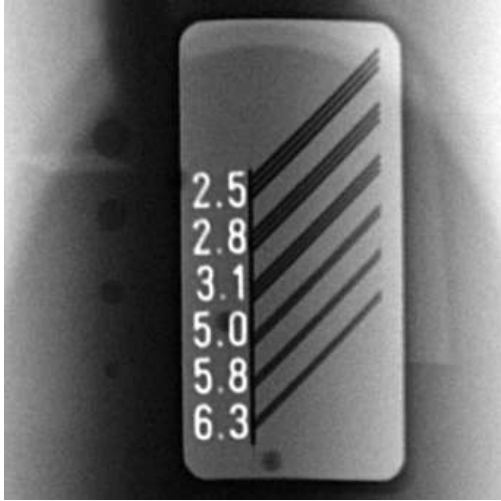
Line Pair Resolution Test	
Test Method	<ol style="list-style-type: none"> 1. Place Digitest 2.1 phantom in Canine Beam. 2. Scan Panoramic Standard protocol. 3. Measure the Line pair after scanning Digitest 2.1 phantom. 
Quality Criteria	Line Pair Resolution \geq 2.5 lp/mm

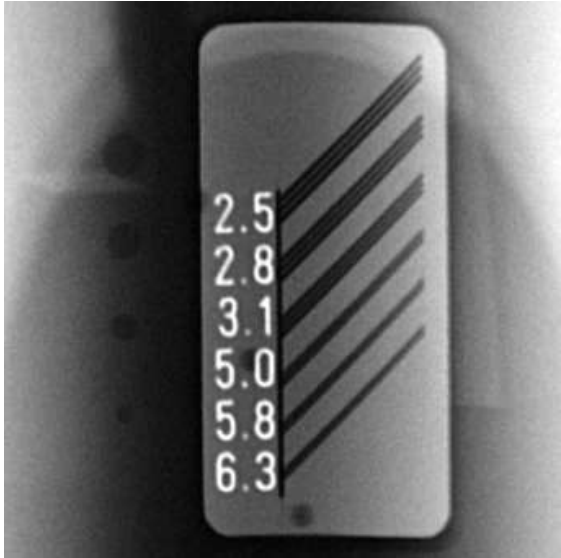
Low Contrast Test	
Test Method	<ol style="list-style-type: none"> 1. Place Digitest 2.1 phantom in Carpus plate or Detector case. 2. Scan Panoramic Standard protocol. 3. Measure the Line pair after scanning Digitest 2.1 phantom. 
Quality Criteria	Low contrast \geq 2 step

10.2.3.2 CEPH

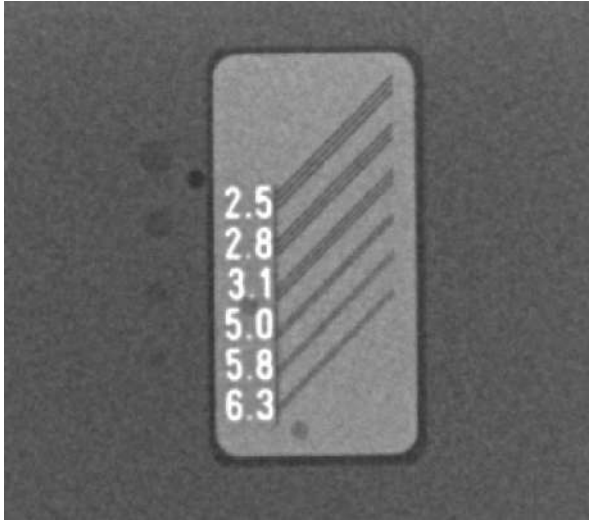
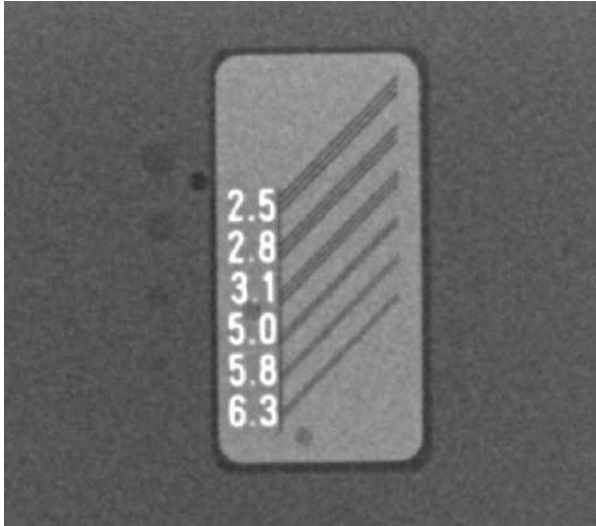
Line Pair Resolution Test	
Test Method	<ol style="list-style-type: none"> 1. Place Digitest 2.1 phantom in Carpus plate or Detector case. 2. Scan CEPH Lateral protocol. 3. Measure the Line pair after scanning Digitest 2.1 phantom. 
Quality Criteria	Line Pair Resolution \geq 2.5 lp/mm
Low Contrast Test	
Test Method	<ol style="list-style-type: none"> 1. Place Digitest 2.1 phantom in Carpus plate or Detector case. 2. Scan CEPH Lateral Standard protocol. 3. Measure the Line pair after scanning Digitest 2.1 phantom. 
Quality Criteria	Low contrast \geq 1 step

10.3 Tools to Maintain Quality Control Logs

Item	Modality	Test	Frequency	Standard	Verdict
1	CT	Mean CT Number	At six-month intervals	PMMA(HU) = 0 ± 100 (HU)	
2	CT	Uniformity	At six-month intervals	Homogeneity ≥ 25	
3	CT	Spatial Resolution	At six-month intervals	MTF 10% > 1.0 lp/mm	
4	CT	Noise	At six-month intervals	CNR ≥ 20	
5	Panoramic	Low Contrast Resolution	At six-month intervals	Low Contrast Resolution ≥ 2 step	
6	Panoramic	Line pair Resolution	At six-month intervals	Line Pair Resolution ≥ 2.5 lp/mm	
7	CEPH	Low Contrast Resolution	At six-month intervals	Low Contrast Resolution ≥ 1 step	
8	CEPH	Line pair Resolution	At six-month intervals	Line Pair Resolution ≥ 2.5 lp/mm	

10.4 Quality Assurance Training Material

Please refer to Quality Assurance Training material. (Doc No. IM-301-E)

10.5 Procedure to be Followed if Tested Parameter Fail

If operator or physician (who reads this instruction for use) fail the QA test, Please retest more one time accordance with Quality Assurance Training material. (Doc No. IM-301-E)

If the value of retest is still not on criteria value or failed, please contact manufacturer or your local RAY representative for the inspection.

This page intentionally left blank.

Appendix A. RELATED STANDARDS

- IEC 60601-1: 2005 / Medical electrical equipment - Part 1: General requirements for basic safety and essential performance.
- IEC 60601-1-2: 2007 / Medical electrical equipment Part1-2: General requirements
Collateral standard: Electromagnetic compatibility.
- IEC 60601-1-3: 2008 / Medical electrical equipment Part 1-3: General requirements for safety and essential Performance Collateral standard: Radiation protection in diagnostic X-ray equipment.
- IEC 60601-1-6: 2010 / Medical electrical equipment -- Part 1-6: General requirements for basic safety and essential performance - Collateral standard: Usability.
- IEC 60601-2-28: 2010 / Medical electrical equipment – Part 2-28: Particular requirements for the basic safety and essential performance of X-ray tube assemblies for medical diagnosis.
- IEC 60601-2-63: 2012 / Particular requirements for the basic safety and essential performance of dental extra-oral X-ray equipment.
- IEC 61223-3-4: 2000 / Evaluation and routine testing in medical imaging departments - Part 3-4: Acceptance tests – Imaging performance of dental X-ray equipment.
- IEC 61223-3-5: 2004 / Evaluation and routine testing in medical imaging departments - Part 3-5: Acceptance tests –Imaging performance of computed tomography X-ray equipment.
- IEC 62220-1: 2003 / Medical electrical equipment – Characteristics of digital X-ray imaging devices – Part 1: Determination of the detective quantum efficiency.
- IEC 61674: 2005 / Medical diagnostic X-ray equipment - Radiation conditions for use in the determination of characteristics.
- EN/ISO 14971: 2012 / Medical devices – Risk Application of Risk management to medical Devices.
- IEC 62366: 2007 / Medical devices - Application of usability engineering to medical devices.
- ISO 62304: 2006 / Medical device software - Software life-cycle processes.

Appendix B. GLOSSARY OF ACRONYMS

Description of acronyms commonly referenced in the User Manual.

Glossary	Acronyms
CBVT	Cone-Beam Volumetric Tomography
CT	Computed Tomography
PANO/Pano/PX	Panoramic
CEPH/Ceph/DX	Cephalometric
MWL	Modality Worklist
S/W	Software
IO	Intra Oral Sensor
OT	Camera
THU	Touch Monitor
TMJ	Temporomandibular Joint
PA	Posterior-Anterior
SMV	Sub-Mento Vertex

