

LANDANGER

1947

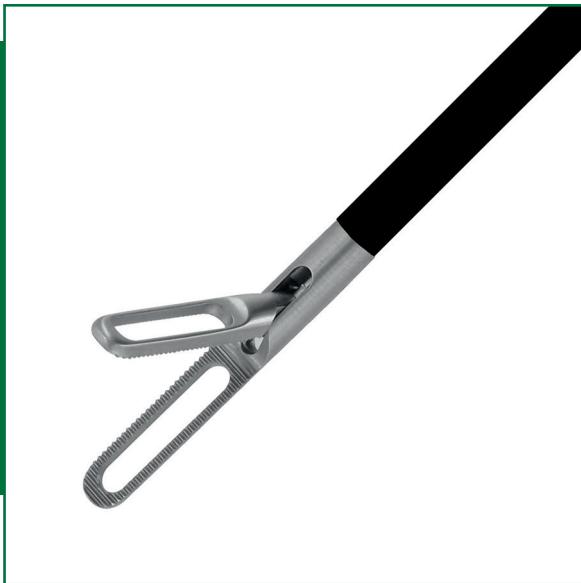

CÆLIOSCOPIE

LAPAROSCOPY

Poignées composite HF - pouce mobile

HF polymer handle - mobile thumb



E0616016 Sans crémaillère / *Without ratchet*



E0616017 Avec crémaillère française / *With flat ratchet*



E0616018 Avec crémaillère centrale / *With central ratchet*

E0616019 Avec crémaillère centrale débrayable / *With switchable central ratchet*

Tubes isolés pour instruments de laparoscopie - ø 10 mm

Laparoscopy instruments insulated shaft - ø 10mm



Longueur / Length

E0634001	220 mm
 E0634002	330 mm
E0634003	450 mm

Tubes non isolés pour instruments de laparoscopie - ø 10 mm

Laparoscopy instruments uninsulated shaft - ø 10mm



* Ne pas utiliser la fonction HF avec des tubes non isolés

* *Not use the HF function with uninsulated shafts*



E0634005	220 mm
 E0634006	330 mm
E0634007	450 mm

Écrous de personnalisation pour instruments de laparoscopie - ø 10 mm

Laparoscopy instruments customization nuts - ø10mm



Couleur / Color

E9634001	Noir / Black
 E9634002	Rouge / Red
 E9634003	Jaune / Yellow
 E9634004	Bleu / Blue
E9634005	Vert / Green

Raccord de nettoyage pour tube / Flushing part for shaft



E0631000



Inserts pour instruments de laparoscopie - ø 10 mm

Laparoscopy instruments inserts - ø 10mm

Dissecteur courbe - 2 mors mobiles L : 23 mm / *Curved dissector - double action - L:23mm*



Longueur utile
Working length

E0634051	220 mm
E0634052	330 mm
E0634053	450 mm

Mixer 90° - 2 mors mobiles - L : 25 mm / *Mixer 90° - double action - L:22mm*

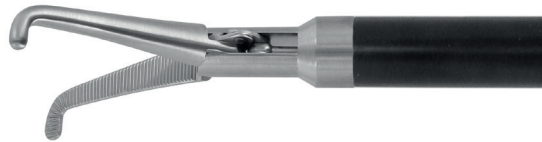

E0634061	220 mm
E0634062	330 mm
E0634063	450 mm

Duval - 2 mors mobiles - L : 40 mm / *Duval - double action - L:40mm*

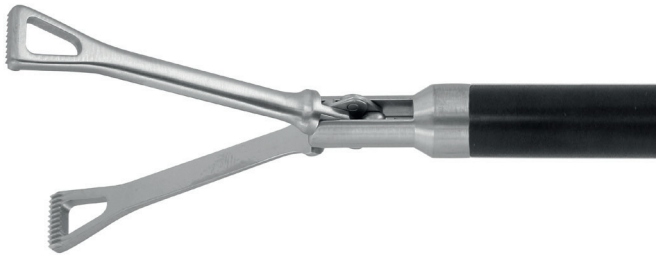

E0634071	220 mm
E0634072	330 mm
E0634073	450 mm

Babcock atraumatique - 2 mors mobiles - L : 35 mm / *Atraumatic Babcock - double action - L:35mm*



E0634081	220 mm
E0634082	330 mm
E0634083	450 mm

Trocarts COLIBRI - Pointes - ø 5,5 mm

COLIBRI trocars - Tips - ø 5.5mm

Pour / For
instruments ø 5 mm

● Pointes pyramidales composites / Polymer pyramidal trocar tips



	Trocarts / Trocars	
Pédiatrique / Paediatric	E0637624	L : 70 mm
Standard / Standard	E0637625	L : 100 mm
Bariatrique / Bariatric	E0637626	L : 140 mm

● Pointes pyramidales inox / Stainless steel pyramidal trocar tips



	Trocarts / Trocars	
Pédiatrique / Paediatric	E0610054	L : 70 mm
Standard / Standard	E0610055	L : 100 mm
Bariatrique / Bariatric	E0610056	L : 140 mm

● Pointes pyramidico-coniques / Pyramido-conical trocar tips



	Trocarts / Trocars		Non Perforée / No permeable		Trocarts / Trocars	
Perforée / Permeable						
Standard / Standard	E0611055	L : 100 mm	Standard / Standard	E0612055	L : 100 mm	
Bariatrique / Bariatric	E0611056	L : 140 mm				

● Pointes coniques / Conical trocar tips



	Trocarts / Trocars		Non Perforée / No permeable		Trocarts / Trocars	
Perforée / Permeable						
Standard / Standard	E0609055	L : 100 mm	Standard / Standard	E0608055	L : 100 mm	
Bariatrique / Bariatric	E0609056	L : 140 mm	Bariatrique / Bariatric	E0608056	L : 140 mm	

Trocarts Inox à Levier - Ø 5,5 mm
Inox Trocars with Opening Lever - Ø 5.5mm

Pour / For
instruments Ø 5 mm

Tube lisse / *Smooth tube*

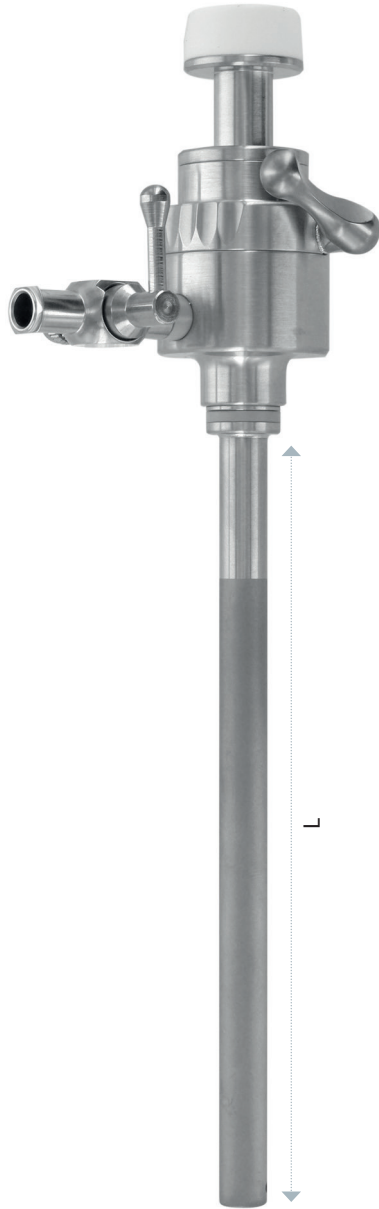

Tube fileté / *Threaded tube*



Avec robinet / *With stopcock*

Standard / <i>Standard</i>	E0638005	L : 100 mm
Bariatrique / <i>Bariatric</i>	E0638006	L : 140 mm

Avec robinet / *With stopcock*

Standard / <i>Standard</i>	E0638105	L : 100 mm
----------------------------	-----------------	------------

Trocarts Inox à Levier - Ø 11 mm
Inox Trocars with Opening Lever - Ø 11mm

Pour / For
instruments Ø 10 mm

Tube lisse / *Smooth tube*

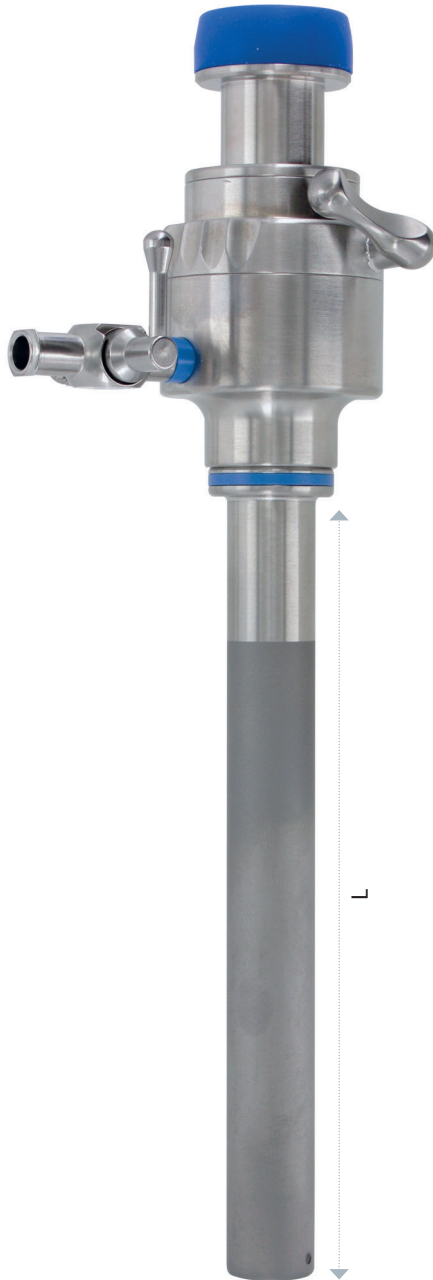

Tube fileté / *Threaded tube*



Avec robinet / *With stopcock*

Standard / <i>Standard</i>	E0638010	L : 100 mm
Bariatrique / <i>Bariatric</i>	E0638011	L : 140 mm

Avec robinet / *With stopcock*

Standard / <i>Standard</i>	E0638110	L : 100 mm
----------------------------	-----------------	------------

Trocarts Inox à Levier - Pointes - ø 11 mm
Inox Trocars with Opening Lever - Tips - ø 11mm

Pour / For
instruments ø 10 mm

● Pointes dilatatrices composites / Polymer dilating trocar tips



Standard / *Standard*

 E0637610

Trocarts / *Trocars*

L : 100 mm

Bariatrique / *Bariatric*

E0637611

L : 140 mm

● Pointes de sécurité démontables / Safety trocar tips, take apart system



Standard / *Standard*

 E0606110

Trocarts / *Trocars*

L : 100 mm

Bariatrique / *Bariatric*

E0606111

L : 140 mm

Trocarts / *Trocars*

● Pointe de Hasson / Hasson trocar tip



Standard / *Standard*

E0607110

Trocarts / *Trocars*

L : 100 mm

Systèmes de lavage et aspiration - poignée droite à robinet basculant
Suction-irrigation systems - sliding valve straight handle



E0615500

Poignée / Handle

● Tubes 4 trous / 4 holes tubes



E0615502

∅

5 mm

Longueur / Length

330 mm

E0615503

10 mm

330 mm

● Pièces détachées / Spare parts



E9615610

Bouchon ressort / Cap spring



E9615500

Robinet basculant / Valve



Composez votre poignée de lavage/aspiration

Compose your suction/irrigation handle

Poignée, page 80
Handle, page 80



Tube, page 81
Tube, page 81

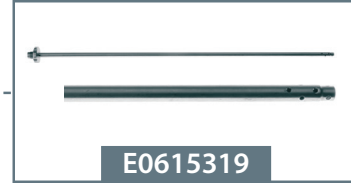
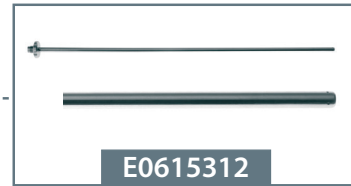
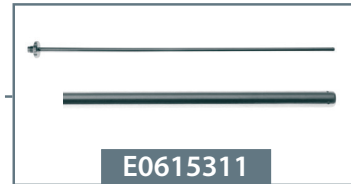

Porte aiguilles avec canal de nettoyage

Needle holders with flushing port



TC Inserts

● Droit / Straight



	ø	Longueur / Length
E0619541	5 mm	250 mm
E0619551	5 mm	330 mm
E0619552	5 mm	450 mm

● Courbe gauche / Left curved



E0619542	5 mm	250 mm
 E0619553	5 mm	330 mm
E0619554	5 mm	450 mm

● Courbe droite / Right curved



E0619543	5 mm	250 mm
E0619555	5 mm	330 mm
E0619556	5 mm	450 mm



Diamonite

● Mors Roméo / Romeo jaws



E0619544	5 mm	250 mm
E0619557	5 mm	330 mm
E0619558	5 mm	450 mm



LANDANGER

1947



ÉLECTROCHIRURGIE

ELECTROSURGERY

ELECTRO-CIRUGÍA

2 kVp max

Droit
Straight
Recta

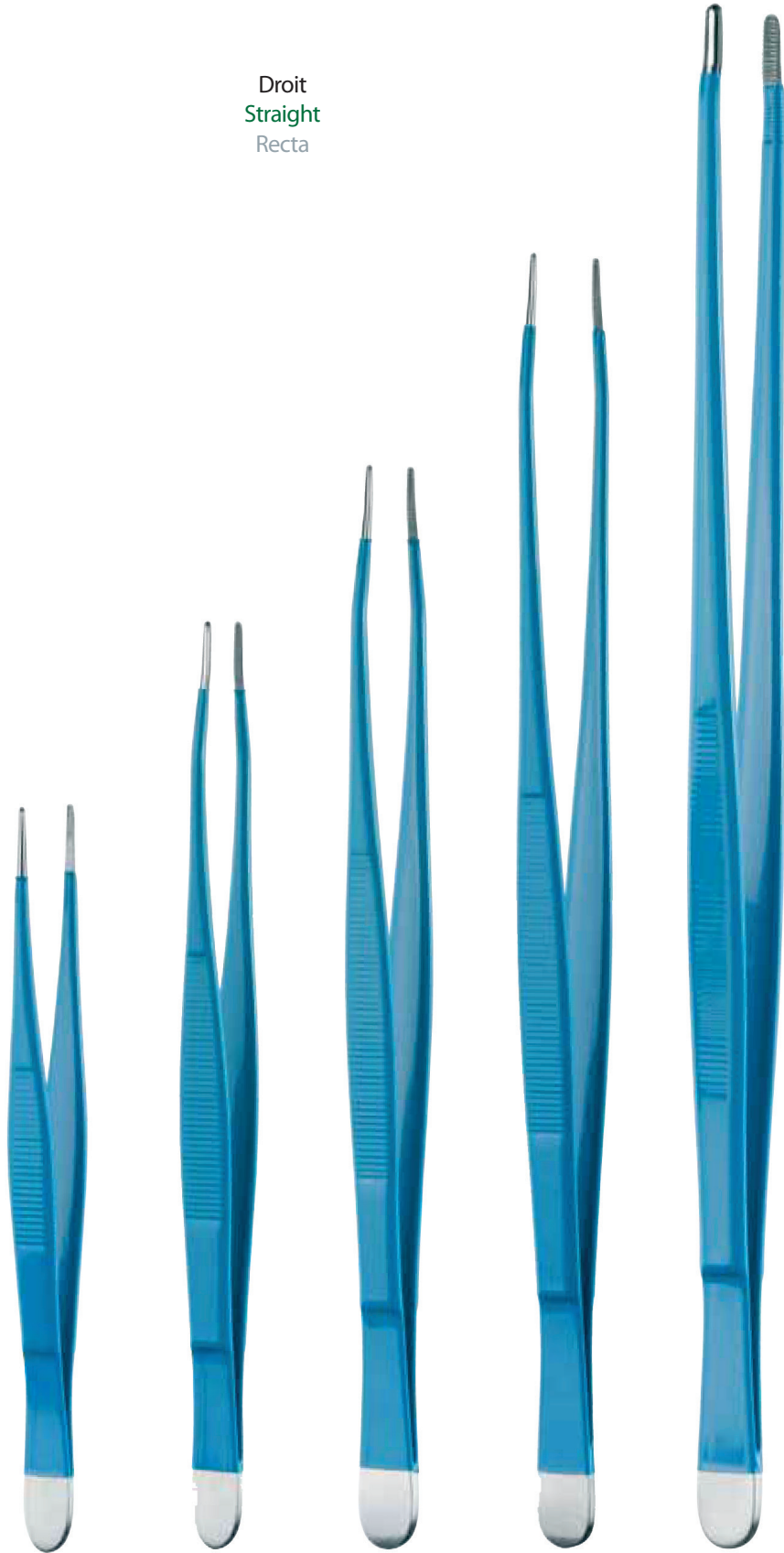
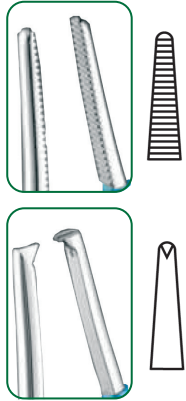

Sans griffe
Without teeth
Sin dientes

Avec griffe
With teeth
Con dientes



HF9714110

HF9618110

HF9621110

HF9625110

HF9630110



HF9714120

HF9618120

HF9621120

HF9625120

HF9630120

145 mm

180 mm

210 mm

250 mm

300 mm



STÉRILISATION

STERILIZATION

L A N D A N G E R

Boîte perforée avec couvercle articulé pour aiguilles

Perforated needles case with hinged lid



Perforation
Perforation
Ø 1 mm

Dimensions / Dimensions



O602540

150 × 90 × 15 mm / 5.90 × 3.54 × 0.59"

1

Boîte perforée avec couvercle amovible pour aiguilles

Perforated needles case with removable lid



Perforation
Perforation
Ø 2 mm

Dimensions / Dimensions



O602550

Ø 65 mm × 15 mm / Ø 2.56 × 0.59"

1

Boîtes perforées avec couvercle coulissant pour aiguilles

Perforated needles cases with sliding lid

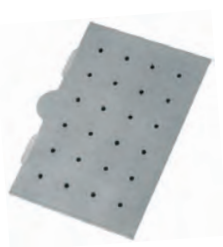
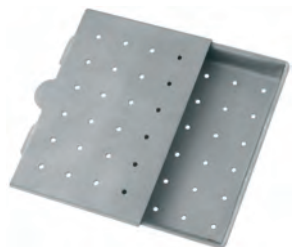

Perforation
Perforation
Ø 1,5 mm

Dimensions / Dimensions



O602560

65 × 45 × 8 mm / 2.56 × 1.77 × 0.31"

O602570

80 × 30 × 8 mm / 3.15 × 1.18 × 0.31"

O602580

50 × 30 × 8 mm / 1.97 × 1.18 × 0.31"

1

LANDANGER



LANDANGER

1947



*«L'instrument des instruments
c'est la main.»
Aristote*

GROSS MAYER

Droite Straight Recta		Courbe Curved Curva	
	B507701	20 cm - 8"	B507702
	B50780	25 cm - 10"	B50785 



B50780
25 cm - 10"



B50785
25 cm - 10"

Pinces hémostatiques longues - Long haemostatic forceps - Pinzas hemostáticas largas

HEISS

Droite
Straight
Recta

Courbe
Curved
Curva

Sans griffes
Without teeth
Sin dientes

A griffes
With teeth
Con dientes

Sans griffes
Without teeth
Sin dientes

A griffes
With teeth
Con dientes



B60460

B60450

20 cm - 8 "



B60480

B60470

B604810



B60460

B60450

B60460
20 cm - 8 "



B60480 **B604810**

B60470

B60480
20 cm - 8 "

ROCHESTER-PEAN

Droite Straight Recta	Sans griffes Without teeth Sin dientes	Courbe Curved Curva
B506990	14 cm - 5 1/2"	B507090
 B50700	16 cm - 6 1/4"	B50710
B50705	18 cm - 7"	B50715
B50706	20 cm - 8"	B50720
B507065	22 cm - 8 3/4"	B507210
B50707	24 cm - 9 1/2"	B50725
B507080	26 cm - 10 1/4"	B507261
B507081	30 cm - 11 3/4"	B507262



B50700
16 cm - 6 1/4"



B50705
18 cm - 7"



B50706
20 cm - 8"



B50707
24 cm - 9 1/2"

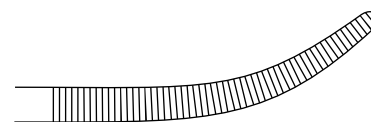

B50710
16 cm - 6 1/4"



B50715
18 cm - 7"

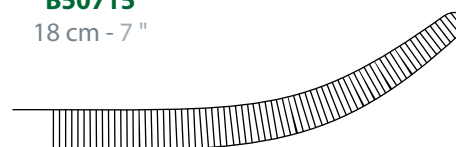

B50720
20 cm - 8"

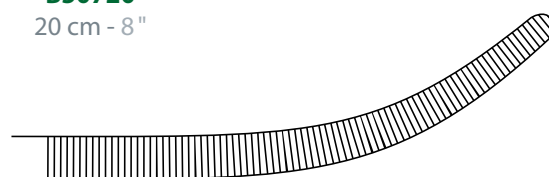

B50725
24 cm - 9 1/2"

LANDANGER

Ciseaux divers - Various scissors - Tijeras diversas

NANCY

DOYEN

Droit
Straight
Recta

Droit
Straight
Recta

Courbe
Curved
Curva

16 cm - 6 1/4"

B257609

B257614

18 cm - 7" 

B257610

B257615

Courbe
Curved
Curva



B25775
18,5 cm - 7 1/4"



B257605
16 cm - 6 1/4"





B257610
18 cm - 7"



B257615

III - Ciseaux
III - Scissors
III - Tijeras

Pinces à dissection standards - Standard dissecting forceps - Pinzas para disección estándares

Sans griffes Without teeth Sin dientes			STANDARD - STANDARD - ESTÁNDAR			1 x 2 griffes 1 x 2 teeth 1 x 2 dientes		
B40005	-	10 cm - 4"	B40045	-				
B40010	B401140	12 cm - 4 ³ / ₄ "	B40050	B401150				
B40015	B401141	14 cm - 5 ¹ / ₂ "	B40055	B401151				
 B40020	B401142	16 cm - 6 ¹ / ₄ "	B40060	B401152				
B40025	B401143	18 cm - 7"	B40065	B401153				
B40030	B401144	20 cm - 8"	B40070	B401154				
B40035	B401145	25 cm - 10"	B40075	B401155				
B40040	-	30 cm - 11 ³ / ₄ "	B40080	-				



B40020
16 cm - 6¹/₄"

B401142
16 cm - 6¹/₄"



B40060
16 cm - 6¹/₄"

B401152
16 cm - 6¹/₄"

GREGOIRE

18 cm - 7"

B40270



20 cm - 8"

B40275



B40270
18 cm - 7"

J.L. FAURE

18 cm - 7"

B40415



20 cm - 8"

B40420

25 cm - 10"

B40425

30 cm - 11^{3/4}"

B404251

3 x 4 griffes
3 x 4 teeth
3 x 4 dientes



B40415
18 cm - 7"

ROCHESTER-OSCHNER

	A griffes With teeth Con dientes		Courbe Curved Curva
Droite Straight Recta			
B507295	14 cm - 5 1/2"		B507395
 B50730	16 cm - 6 1/4"		B50740
B50735	18 cm - 7"		B50745
B507351	20 cm - 8"		B507451
B507352	22 cm - 8 3/4"		B507452
B507353	24 cm - 9 1/2"		B507453
B507354	26 cm - 10 1/4"		B507454
B507355	30 cm - 11 3/4"		B507455



B50730
16 cm - 6 1/4 "



B50730
16 cm - 6 1/4 "



B50735
18 cm - 7 "



B507351
22cm - 8 3/4 "



B507353
24cm - 9 1/2 "

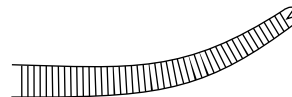

B50740
16 cm - 6 1/4 "



B50745
18 cm - 7 "

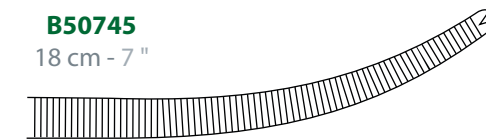

B507451
20 cm - 8 "

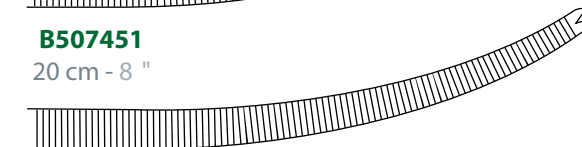

B507453
22 cm - 8 3/4 "



LANDANGER

Ciseaux tungstène - Tungsten scissors - Tijeras de tungsteno



TC Insert

MAYO

Droit
Straight
Recta

Courbe
Curved
Curva

Standard
Standard
Estándar



Microcut

Standard
Standard
Estándar



Microcut



SupercutBlack

14 cm - 5 1/2" 

B35042

14 cm - 5 1/2" 

B35043

17 cm - 6 3/4"

B35044

B35044M

17 cm - 6 3/4"

B35045

B35045M

B35045SB

23 cm - 9"

B35046

23 cm - 9"

B35047



B35042

14 cm - 5 1/2"

Lames plates
Flat blades
Hojas planas



B35043

14 cm - 5 1/2"



* **Microcut** : 1 lame TC standard + 1 lame TC microdentée - 1 TC standard blade + 1 TC serrated blade - 1 hoja TC estándar + 1 hoja TC micro-serrada

* **SupercutBlack** : 1 lame TC microdentée + 1 lame TC rasoir + Nitrure de titane noir - 1 TC serrated blade + 1 TC razor blade + Black coating - 1 hoja TC micro-serrada + 1 hoja TC navaja + recubrimiento negro

PENFIELD



FISH

ADSON

CLOWARD



J08035
18,5 cm - 7 1/4 "



J162320
20 cm - 8 "



J162330
20 cm - 8 "



J162310
16 cm - 6 1/2 "

WEITLANER-NEURO

ANDERSON-ADSON

Courbe (dos d'âne) - Curved (back ass) - Curva (a bombado)

Pointu
Sharp
Agudo

Mousse
Blunt
Romo



20 cm - 8"

B805412

B805413



B805410
20 cm - 8"



B805413
20 cm - 8"

MIKULICZ

Pinces pour le péritoine
Peritoneal forceps
Pinzas para peritoneo

A griffes
With teeth
Con dientes

Courbe
Curved
Curva

Très courbe
Very curved
Muy curva



B507680

B507680
18 cm - 7"



B507690

B507695

B507690
20 cm - 8"

BACKHAUS



B70140
11 cm - 4 1/4 "



B70130
9 cm - 3 1/2 "





B70150
13 cm - 5 "



B70160
14 cm - 5 1/2 "

Pinces hémostatiques - Haemostatic forceps - Pinzas hemostáticas

		HALSTEAD-MOSQUITO					
		Droite Straight Recta		Courbe Curved Curva			
		Sans griffes Without teeth Sin dientes	A griffes With teeth Con dientes	Sans griffes Without teeth Sin dientes	A griffes With teeth Con dientes		
		B504580	B504582	12 cm - 4 3/4 "	B504584	B504586	
		B504581	B504583	14 cm - 5 1/2 "	B504585	B504587	
		B504560	B504564	18 cm - 7 "	B504562	B504566	
		B504561	B504565	21 cm - 8 1/4 "	B504563	B504567	

Modèles allemands
German models
Modelos alemanes



IV - Pinces
IV - Forceps
IV - Pinzas

DE MARTEL

Droit	Courbe
Straight	Curved
Recta	Curva

18 cm - 7"

B25813

B25814



POTTS DE MARTEL

MILLS



60°

B258121
21 cm - 8 1/4"



B25814

B25813
18 cm - 7"



60°

B258123
21 cm - 8 1/4"

III - Ciseaux
III - Scissors
III - Tijeras

LISTON

Double doigt
Double Collin's lock
Doble articulación

Droite
Straight
Recta

-	14 cm - 5 1/2 "	J68022
-	17 cm - 6 3/4 "	J68026
J68062	19 cm - 7 1/2 "	J68030
J68066	22 cm - 8 3/4 "	J68050

Coudée
Angular
Acodada

-	14 cm - 5 1/2 "	J68024
-	17 cm - 6 3/4 "	J68028
J68064	19 cm - 7 1/2 "	J68040
J68068	22 cm - 8 3/4 "	J68060



J68062
19 cm - 7 1/2 "



J68026
17 cm - 6 3/4 "

LANDANGER

Ciseaux chirurgicaux - Surgical scissors - Tijeras quirúrgicas

	Droit Straight Recta			Courbe Curved Curva
	B25255	11 cm - 4 1/4"		B25260
	B25261	13 cm - 5"		B25262 
	B25275	14 cm - 5 1/2"		B25280
	B25285	16 cm - 6 1/4"		B25290
	B25295	18 cm - 7"		B25300
	B25302	20 cm - 8"		B25303

Mousse / Mousse
Blunt / Blunt
Roma / Roma





B25261
13 cm - 5"



B25262
13 cm - 5"

III - Ciseaux
III - Scissors
III - Tijeras

Pinces à dissection standards - Standard dissecting forceps - Pinzas para disección estándares

Sans griffes Without teeth Sin dientes		STANDARD - STANDARD - ESTÁNDAR	1 x 2 griffes 1 x 2 teeth 1 x 2 dientes	
B40005	-	10 cm - 4"	B40045	-
B40010	B401140	12 cm - 4 ³ / ₄ "	B40050	B401150
B40015	B401141	14 cm - 5 ¹ / ₂ "	B40055	B401151
 B40020	B401142	16 cm - 6 ¹ / ₄ "	B40060	B401152 
B40025	B401143	18 cm - 7"	B40065	B401153
B40030	B401144	20 cm - 8"	B40070	B401154
B40035	B401145	25 cm - 10"	B40075	B401155
B40040	-	30 cm - 11 ³ / ₄ "	B40080	-



B40020
16 cm - 6¹/₄"

B401142
16 cm - 6¹/₄"



B40060
16 cm - 6¹/₄"

B401152
16 cm - 6¹/₄"

MIKULICZ

Pinces pour le péritoine
Peritoneal forceps
Pinzas para peritoneo

A griffes
With teeth
Con dientes

Courbe
Curved
Curva

Très courbe
Very curved
Muy curva



B507680

B507680
18 cm - 7"



B507690

B507695

B507690
20 cm - 8"

IV - Pinces
IV - Forceps
IV - Pinzas

BACKHAUS



B70140
11 cm - 4 1/4 "



B70130
9 cm - 3 1/2 "





B70150
13 cm - 5 "



B70160
14 cm - 5 1/2 "

Pinces hémostatiques - Haemostatic forceps - Pinzas hemostáticas

		HALSTEAD-MOSQUITO					
		Droite Straight Recta		Courbe Curved Curva			
		Sans griffes Without teeth Sin dientes	A griffes With teeth Con dientes	Sans griffes Without teeth Sin dientes	A griffes With teeth Con dientes		
		B504580	B504582	12 cm - 4 3/4 "	B504584	B504586	
		B504581	B504583	14 cm - 5 1/2 "	B504585	B504587	
		B504560	B504564	18 cm - 7 "	B504562	B504566	
		B504561	B504565	21 cm - 8 1/4 "	B504563	B504567	

Modèles allemands
German models
Modelos alemanes

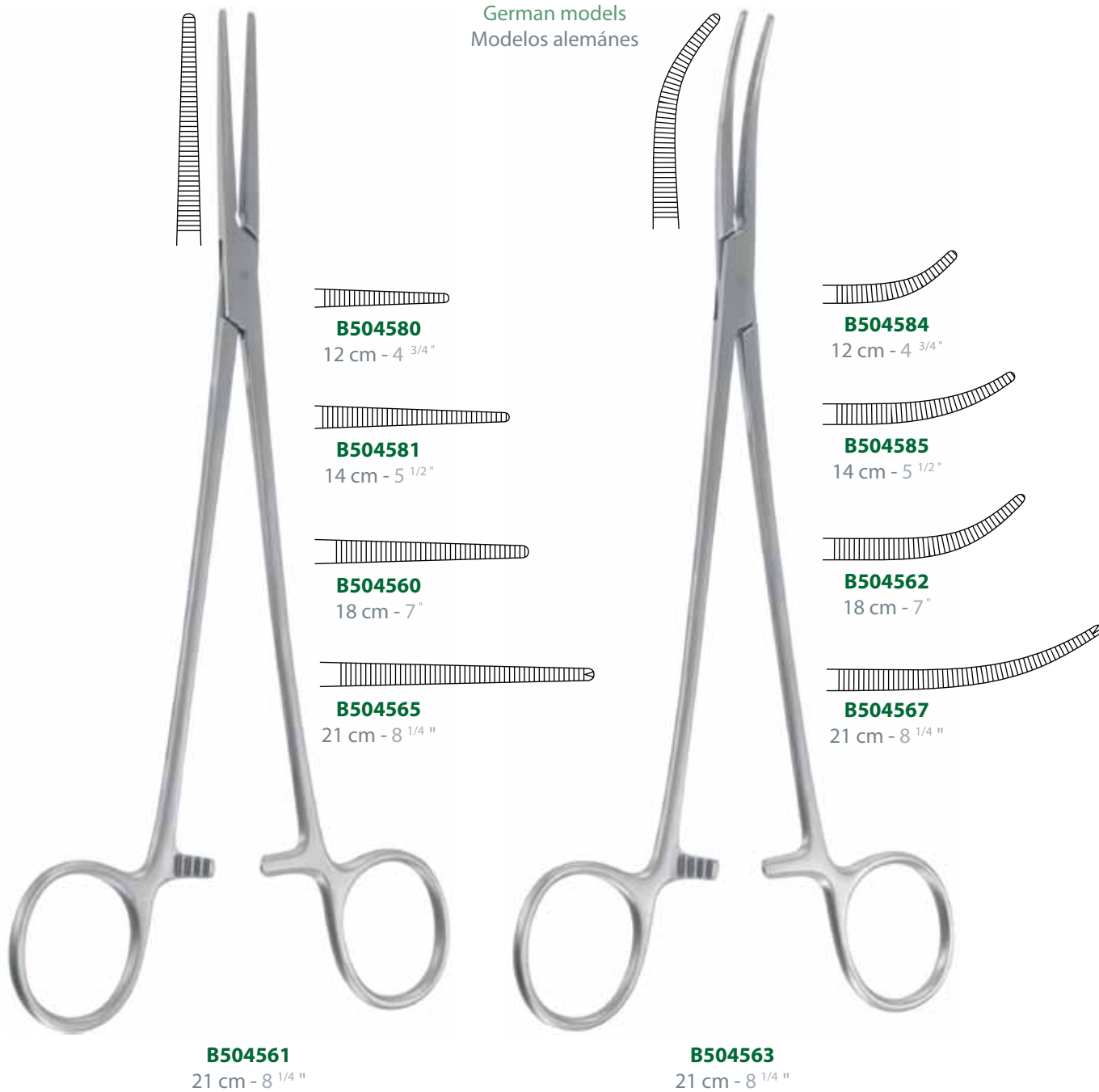

IV - Pinces
IV - Forceps
IV - Pinzas

ROCHESTER-PEAN

Droite Straight Recta	Sans griffes Without teeth Sin dientes	Courbe Curved Curva
B506990	14 cm - 5 1/2"	B507090
 B50700	16 cm - 6 1/4"	B50710
B50705	18 cm - 7"	B50715
B50706	20 cm - 8"	B50720
B507065	22 cm - 8 3/4"	B507210
B50707	24 cm - 9 1/2"	B50725
B507080	26 cm - 10 1/4"	B507261
B507081	30 cm - 11 3/4"	B507262



B50700
16 cm - 6 1/4"



B50705
18 cm - 7"



B50706
20 cm - 8"



B50707
24 cm - 9 1/2"

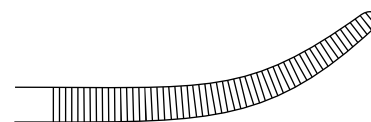

B50710
16 cm - 6 1/4"



B50715
18 cm - 7"

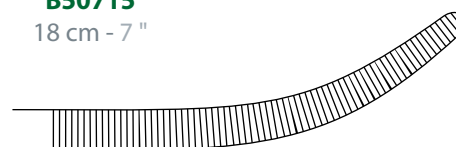

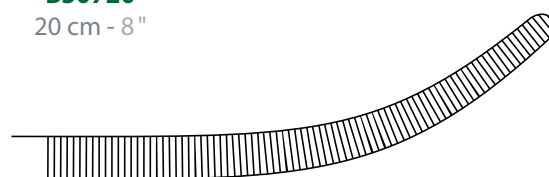

B50720
20 cm - 8"



B50725
24 cm - 9 1/2"

METZENBAUM-FINO

	Droit Straight Recta	Courbe Curved Curva		Droit Straight Recta	Courbe Curved Curva
15 cm - 6" 	B256205	B256255		15 cm - 6" 	B256215 B256265
18 cm - 7"	B256305	B256355			
20 cm - 8"	B256405	B256455			
23 cm - 9"	B256505	B256555			
25 cm - 10"	B256605	B256655			
28 cm - 11"	-	B256760			
28 cm - 11"	-	B256770	WELLER (Lames courtes - Short blades - Lamas cortas)		

Mousse / Mousse
Blunt / Blunt
Roma / Roma



B256205
15 cm - 6"

Pointu / Pointu
Sharp / Sharp
Aguda / Aguda



B256215
15 cm - 6"

ROCHESTER-PEAN

Droite Straight Recta	Sans griffes Without teeth Sin dientes	Courbe Curved Curva
B506990	14 cm - 5 1/2"	B507090
 B50700	16 cm - 6 1/4"	B50710
B50705	18 cm - 7"	B50715
B50706	20 cm - 8"	B50720
B507065	22 cm - 8 3/4"	B507210
B50707	24 cm - 9 1/2"	B50725
B507080	26 cm - 10 1/4"	B507261
B507081	30 cm - 11 3/4"	B507262



B50700
16 cm - 6 1/4"



B50705
18 cm - 7"



B50706
20 cm - 8"



B50707
24 cm - 9 1/2"

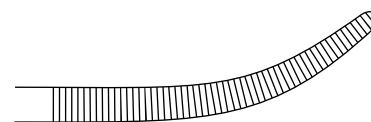

B50710
16 cm - 6 1/4"



B50715
18 cm - 7"

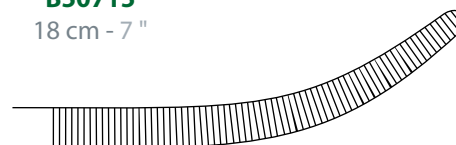

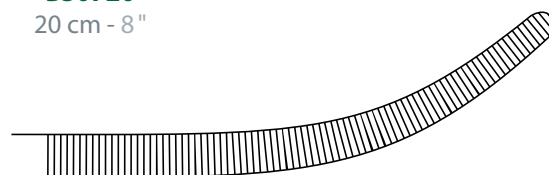

B50720
20 cm - 8"



B50725
24 cm - 9 1/2"

Pinces à dissection standards - Standard dissecting forceps - Pinzas para disección estándares

Sans griffes Without teeth Sin dientes			STANDARD - STANDARD - ESTÁNDAR			1 x 2 griffes 1 x 2 teeth 1 x 2 dientes		
B40005	-	10 cm - 4"	B40045	-				
B40010	B401140	12 cm - 4 ³ / ₄ "	B40050	B401150				
B40015	B401141	14 cm - 5 ¹ / ₂ "	B40055	B401151				
 B40020	B401142	16 cm - 6 ¹ / ₄ "	B40060	B401152				
B40025	B401143	18 cm - 7"	B40065	B401153				
B40030	B401144	20 cm - 8"	B40070	B401154				
B40035	B401145	25 cm - 10"	B40075	B401155				
B40040	-	30 cm - 11 ³ / ₄ "	B40080	-				



B40020
16 cm - 6¹/₄"

B401142
16 cm - 6¹/₄"



B40060
16 cm - 6¹/₄"

B401152
16 cm - 6¹/₄"

POTTS-SMITH

	25°	45°	60°	125°
19 cm - 7 1/2"	B25802	B25804	B25806	B25812

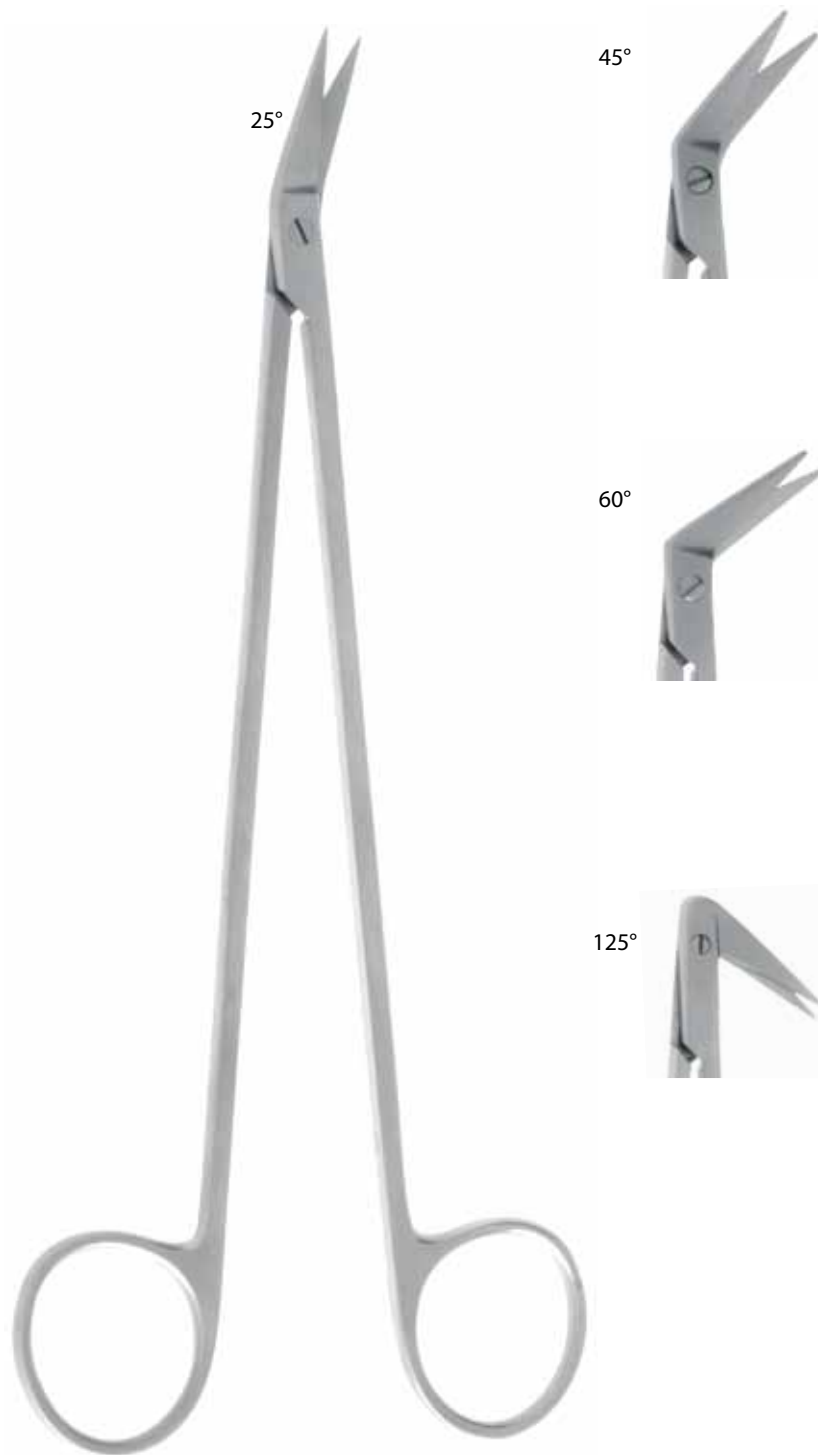

B25802
19 cm - 7 1/2"

ROCHESTER-PEAN

Droite Straight Recta	Sans griffes Without teeth Sin dientes	Courbe Curved Curva
B506990	14 cm - 5 1/2"	B507090
 B50700	16 cm - 6 1/4"	B50710
B50705	18 cm - 7"	B50715
B50706	20 cm - 8"	B50720
B507065	22 cm - 8 3/4"	B507210
B50707	24 cm - 9 1/2"	B50725
B507080	26 cm - 10 1/4"	B507261
B507081	30 cm - 11 3/4"	B507262



B50700
16 cm - 6 1/4"



B50705
18 cm - 7"



B50706
20 cm - 8"



B50707
24 cm - 9 1/2"

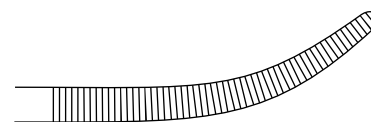

B50710
16 cm - 6 1/4"



B50715
18 cm - 7"

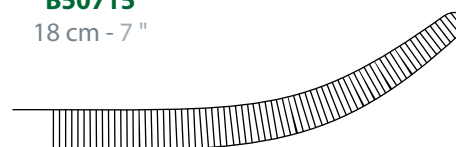

B50720
20 cm - 8"

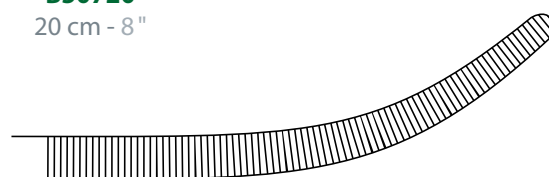

B50725
24 cm - 9 1/2"

RANDALL

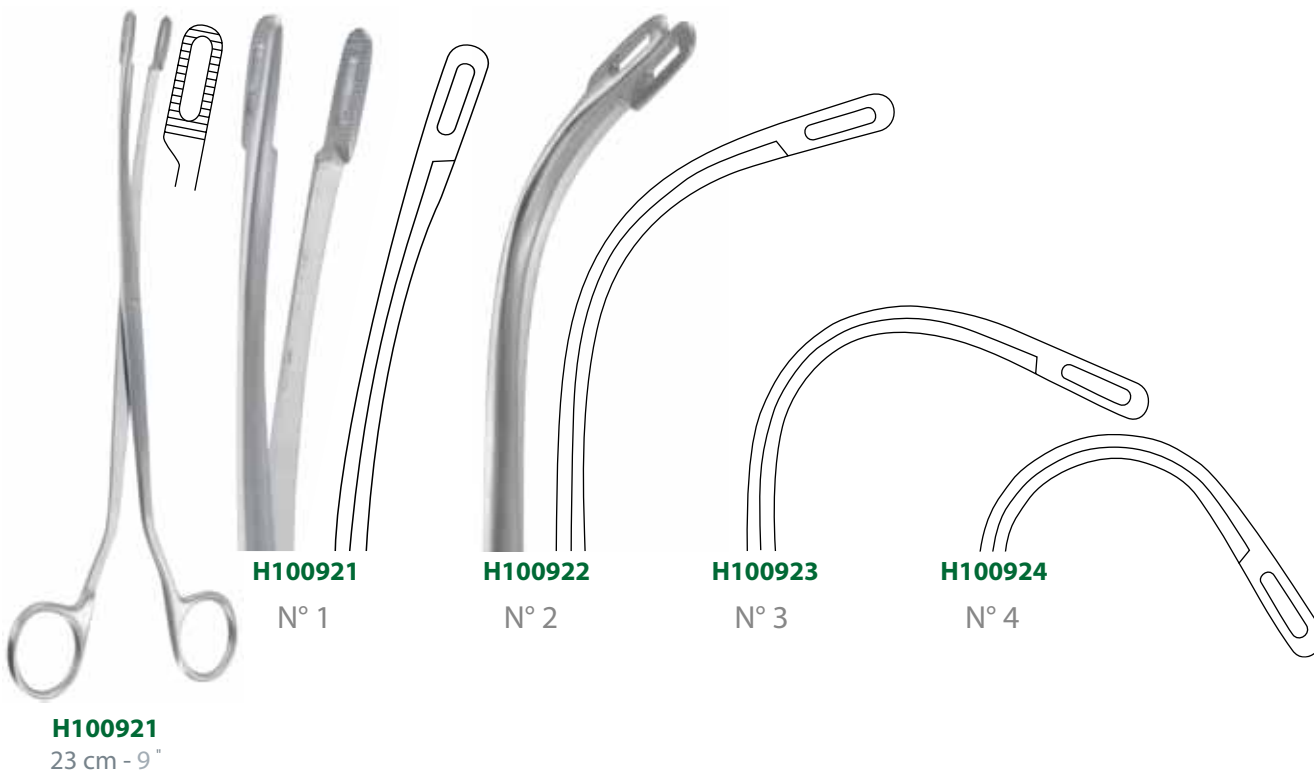

ALLIS

Atraumatique
Non-traumatic
No traumática

4 x 5 griffes
4 x 5 teeth
4 x 5 dientes

5 x 6 griffes
5 x 6 teeth
5 x 6 dientes

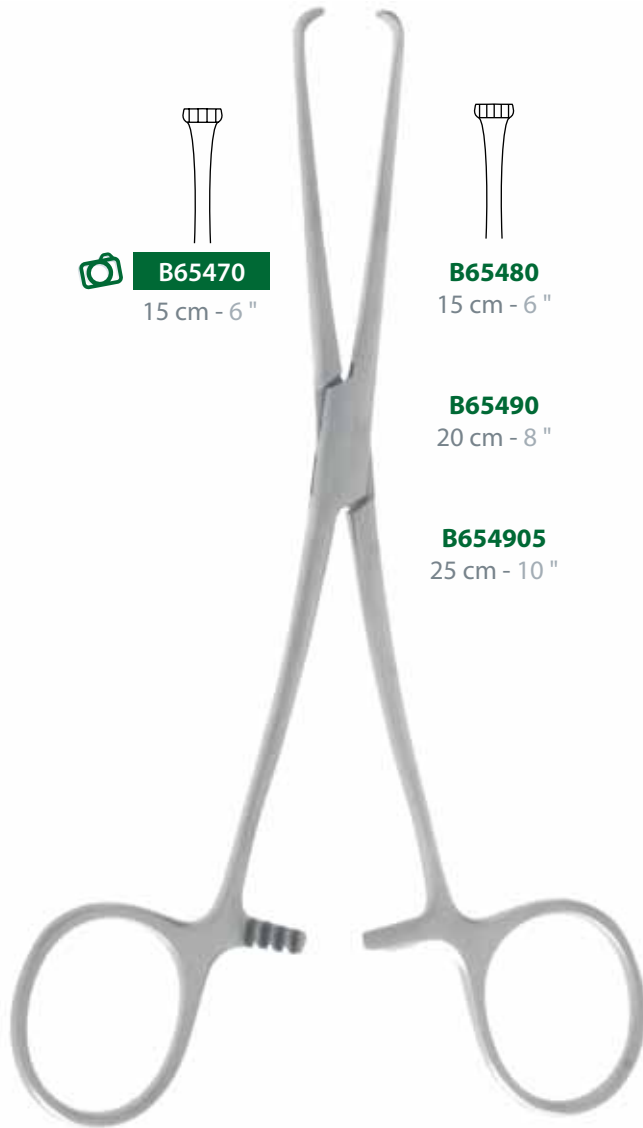
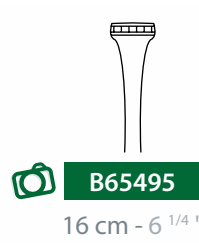
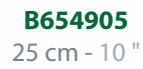
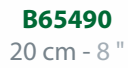
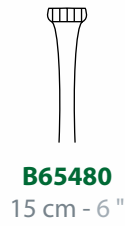
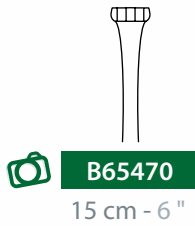

B65470
15 cm - 6 "



B65495
16 cm - 6 1/4 "

ROCHESTER-PEAN

Droite Straight Recta	Sans griffes Without teeth Sin dientes	Courbe Curved Curva
B506990	14 cm - 5 1/2"	B507090
 B50700	16 cm - 6 1/4"	B50710
B50705	18 cm - 7"	B50715
B50706	20 cm - 8"	B50720
B507065	22 cm - 8 3/4"	B507210
B50707	24 cm - 9 1/2"	B50725
B507080	26 cm - 10 1/4"	B507261
B507081	30 cm - 11 3/4"	B507262



B50700
16 cm - 6 1/4"



B50705
18 cm - 7"



B50706
20 cm - 8"



B50707
24 cm - 9 1/2"

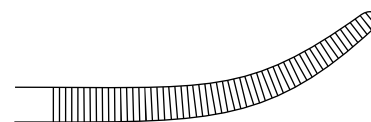

B50710
16 cm - 6 1/4"



B50715
18 cm - 7"

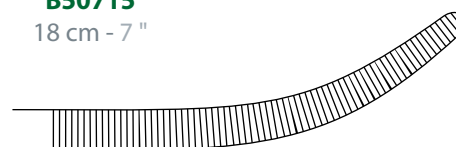

B50720
20 cm - 8"

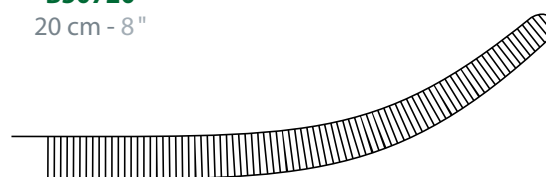

B50725
24 cm - 9 1/2"

CATLIN

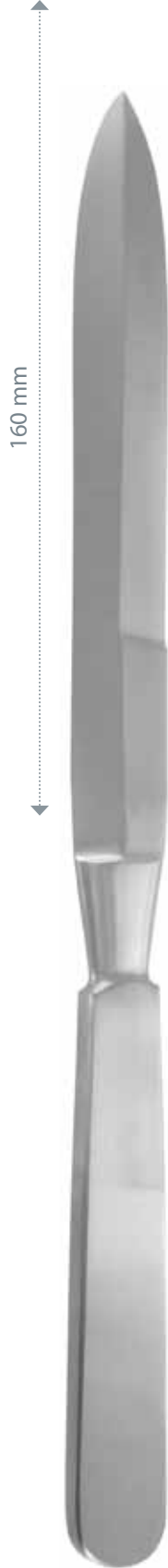

160 mm

J141100
28 cm - 11"

LANGENBECK

Couteaux pour lobes
Flap knives
Cuchillos para lóbulos



120 mm

J141110
26 cm - 10 1/4"

Couteau inter-osseux
Interosseous knife
Cuchillo interóseo



110 mm

J141120
25 cm - 10"

Couteau à phalanges
Phalangeal knife
Cuchillo para falanges



95 mm

J141130
23 cm - 9"

BUCK



QUIRE

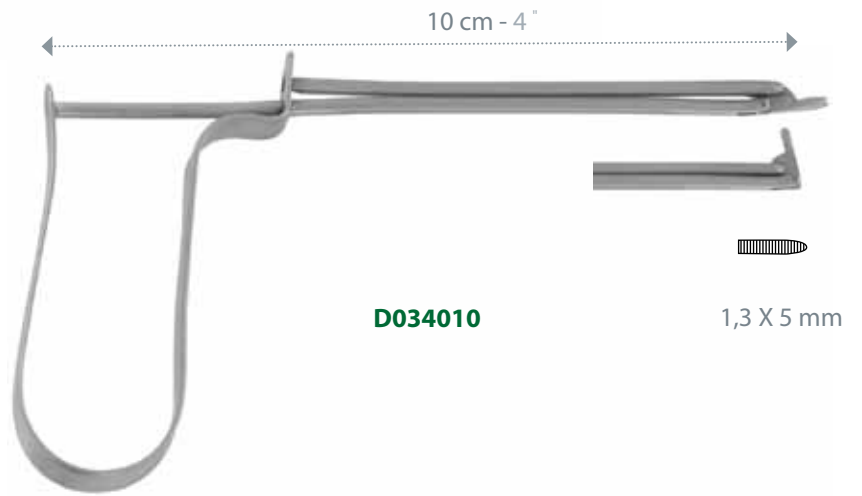

HARTMANN

- 12 cm - 4 3/4" D035000
- 14 cm - 5 1/2" D035010
- 16 cm - 6 1/4" D035020
- 20 cm - 8" D035030



DeBakey Atrauma Tissue Forceps / Pincas DeBakey Atraumatiques / Pinzas DeBakey Atraumáticas

200g Pressure
Pression 200 g
Presión 200 g



DeBakey

DeBakey

1 mm

1.5 mm

2 mm

DC13101-12

L : 120 mm - 4 ^{3/4}"

DC13101-16

L : 160 mm - 6"

DC13101-20

L : 200 mm - 8"

DC13101-24

L : 240 mm - 9 ^{1/2}"

DC13101-30

L : 300 mm - 12"



DC13100-16

L : 160 mm - 6"



DC13100-20

L : 200 mm - 8"



DC13100-24

L : 240 mm - 9 ^{1/2}"

DC13100-30

L : 300 mm - 12"



DC13200-16

L : 160 mm - 6"



DC13200-20

L : 200 mm - 8"



DC13200-24

L : 240 mm - 9 ^{1/2}"

DC13200-30

L : 300 mm - 12"

2.8 mm

3.5 mm



DC13300-16

L : 160 mm - 6"



DC13300-20

L : 200 mm - 8"



DC13300-24

L : 240 mm - 9 ^{1/2}"

DC13300-30

L : 300 mm - 12"

DC13400-16

L : 160 mm - 6"

DC13400-20

L : 200 mm - 8"

DC13400-24

L : 240 mm - 9 ^{1/2}"

DC13400-30

L : 300 mm - 12"

: Add Ti for Titanium Model / Ajoutez Ti pour le Modèle Titane / Añadir Ti para Modelo Titánio

200g Pressure
Pression 200 g
Presión 200 g



DeBakey

DeBakey

1 mm

1.5 mm

2 mm

- DC13101-12
L : 120 mm - 4 ³/₄"
- DC13101-16
L : 160 mm - 6"
- DC13101-20
L : 200 mm - 8"
- DC13101-24
L : 240 mm - 9 ¹/₂"
- DC13101-30
L : 300 mm - 12"

- DC13100-16
L : 160 mm - 6"
- DC13100-20
L : 200 mm - 8"
- DC13100-24
L : 240 mm - 9 ¹/₂"
- DC13100-30
L : 300 mm - 12"

- DC13200-16
L : 160 mm - 6"
- DC13200-20
L : 200 mm - 8"
- DC13200-24
L : 240 mm - 9 ¹/₂"
- DC13200-30
L : 300 mm - 12"

2.8 mm

3.5 mm

- DC13300-16
L : 160 mm - 6"
- DC13300-20
L : 200 mm - 8"
- DC13300-24
L : 240 mm - 9 ¹/₂"
- DC13300-30
L : 300 mm - 12"

- DC13400-16
L : 160 mm - 6"
- DC13400-20
L : 200 mm - 8"
- DC13400-24
L : 240 mm - 9 ¹/₂"
- DC13400-30
L : 300 mm - 12"

: Add TI for Titanium Model / Ajoutez TI pour le Modèle Titane / Añadir TI para Modelo Titánio

0.4 mm TC Inserts - For Suture : 6/0 -> 4/0
Inserts TC 0.4 mm - Pour Suture : 6/0 -> 4/0
Insertos TC 0.4 mm - Para Sutura : 6/0 -> 4/0



TC Inserts



0.4 mm

DeBakey



DC51150-18

L : 180 mm - 7"

DC51150-20

L : 200 mm - 8"

DC51150-23

L : 230 mm - 9"

DC51150-26

L : 260 mm - 10"

DC51150-30

L : 300 mm - 12"

Mayo Hegar Needle Holders / Porte-Aiguilles Mayo Hegar / Porta Aguijas Mayo Hegar

0.5 mm TC Inserts - For Suture : 4/0 -> 1/0
 Inserts TC 0,5 mm - Pour Suture : 4/0 -> 1/0
 Insertos TC 0,5 mm - Para Sutura : 4/0 -> 1/0



TC Inserts



0.5 mm

Straight
Droit
Recta



DC51170-16

L : 160 mm - 6 1/4"

DC51170-18

L : 180 mm - 7"

DC51170-20

L : 200 mm - 8"

DC51170-24

L : 240 mm - 9 1/2"

DC51170-26

L : 260 mm - 10"

DC51170-30

L : 300 mm - 12"

Mayo Hegar



Curved
Courbe
Curva



DC51171-20

L : 200 mm - 8"

DC51171-24

L : 240 mm - 9 1/2"

DC51171-26

L : 260 mm - 10"

Reposable Curved Metzenbaum Scissors
Ciseaux Metzenbaum Courbes Réutilisables
Tijeras Metzenbaum Curvas Desechables



1.5 mm

DC83110-02

Ø : 5 mm

Ø 5 mm

Patent
Breveté
Patentado

Registered Design
Modèle déposé
Diseño registrado



DC80110-30

L : 300 mm - 11 4/5"

DC80110-36

L : 360 mm - 14 1/5"

DC80110-44

L : 440 mm - 17 1/4"



NEW
NOUVEAU
NUEVO



DC83112-36

L : 360 mm - 14 1/5"

DC83112-44

L : 440 mm - 17 1/4"



NEW
NOUVEAU
NUEVO

NEW
NOUVEAU
NUEVO

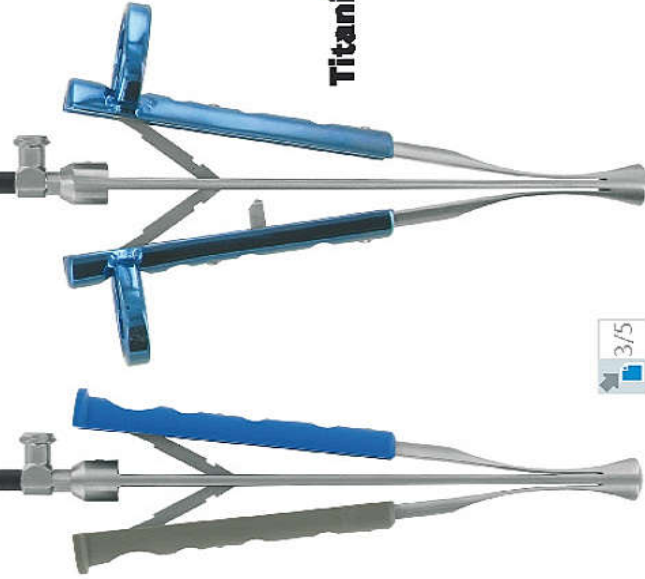

Liase
Titanium

3/5

Active Knot Pushers / Pousse-Noeuds Actifs / Empuja-Nudos

Ø 3.5 mm / Ø 5 mm

Ø 5 mm



**Patent
Breveté
Patentado**

**NEW
NOUVEAU
NUEVO**

DC80302-30
L : 300 mm - 11^{4/5"}

DC80302-36
L : 360 mm - 14^{1/5"}

With Ratchet
Avec Verrou
Con Cerrojo

**NEW
NOUVEAU
NUEVO**

DC80303-30
L : 300 mm - 11^{4/5"}

DC80303-36
L : 360 mm - 14^{1/5"}

Without Ratchet
Sans Verrou
Sin Cerrojo

**NEW
NOUVEAU
NUEVO**

DC80304-30
L : 300 mm - 11^{4/5"}

DC80304-36
L : 360 mm - 14^{1/5"}

With Ratchet
Avec Verrou
Con Cerrojo



DC80300-30
L : 300 mm - 11^{4/5"}

DC80300-36
L : 360 mm - 14^{1/5"}

Without Ratchet
Sans Verrou
Sin Cerrojo

DC80941-34
VATS FOERSTER CLAMP 12MM OVAL CURVED LEFT JAWS WL:240MM TL:340MM D:7MM WITH RATCHET

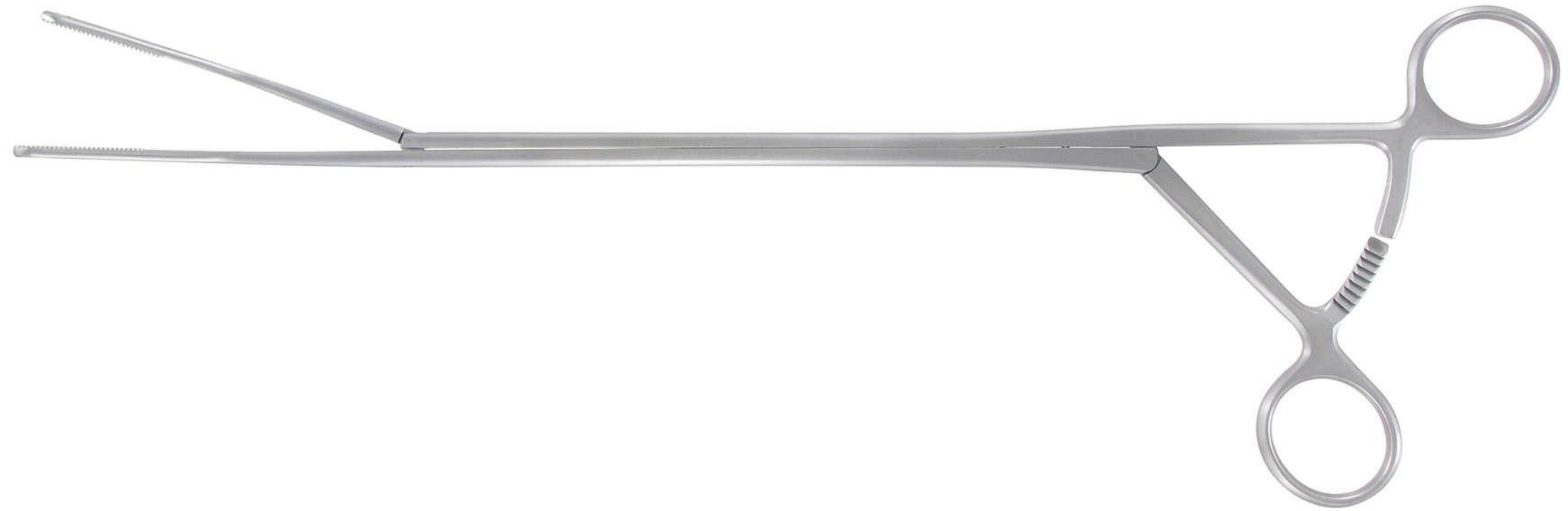

DC80954-34
VATS NEEDLE HOLDER STRAIGHT DIAMONITE JAWS FOR 4/0 NEEDLES WL:210MM TL:340MM D:5MM WITH RATCHET

