

DESIGNED BY  
PERFUSIONISTS.  
ENGINEERED BY  
MEDTRONIC.



Affinity Fusion™  
Oxygenation System

Medtronic  
Further. Together

# THE PRODUCT OF TRUE COLLABORATION

The Affinity Fusion oxygenation system

- Built on input from more than **500 perfusionists worldwide**
- Represents a unique fusion of clinical insight and engineering expertise
- **Features 79 new design enhancements**

Designed by perfusionists.  
Engineered by Medtronic.

# DESIGN, SIMPLY ADVANCED.

## Proactive Air Management

An entire oxygenation system designed to handle air upfront.

- Unique curved venous inlet reduces blood turbulence and GME generation
- A pre-membrane bubble trap is designed to purge air before it enters the fiber membrane
- An oxygenator with integrated arterial filter removes particulates and air

## Uniform Flow Distribution

Designed to reduce blood trauma, lower rates of hemolysis and minimize exposure to foreign surfaces.

- Curved venous inlet for smooth, fluid pathways and low resistance to flow
- Venous inlet tube's flared design reduces blood velocity and resistance to flow
- Cardiotomy cone shape design allows for gentle blood flow
- Oxygenator's radial flow design results in short blood flow paths that avoid areas of stasis

## Perfusion-practical Ergonomics

Improved flexibility, ease of use and set-up, and enhanced customization capabilities.

- Orbit holder system with 360 degrees of flexibility
- Ambidextrous design
- Convenient port locations and spacing
- Independent adjustment of the reservoir and oxygenator

## Progressive Fiber Filtration

Gas exchange and particulate filtration occur simultaneously, enabled by Medtronic's proprietary Graduated Fiber Bundle Density Technology.

- A fully integrated oxygenator and arterial filter
- A compact, low-prime design
- Radial flow for short, uniform blood paths, minimizing blood's contact with foreign surfaces
- Low pressure drop



Finely tuned, carefully considered parameters, from inlet to outlet.

Designed to achieve the optimal blend of performance providing expanded heat exchange and oxygenation capability, while maintaining low prime and low pressure drop.

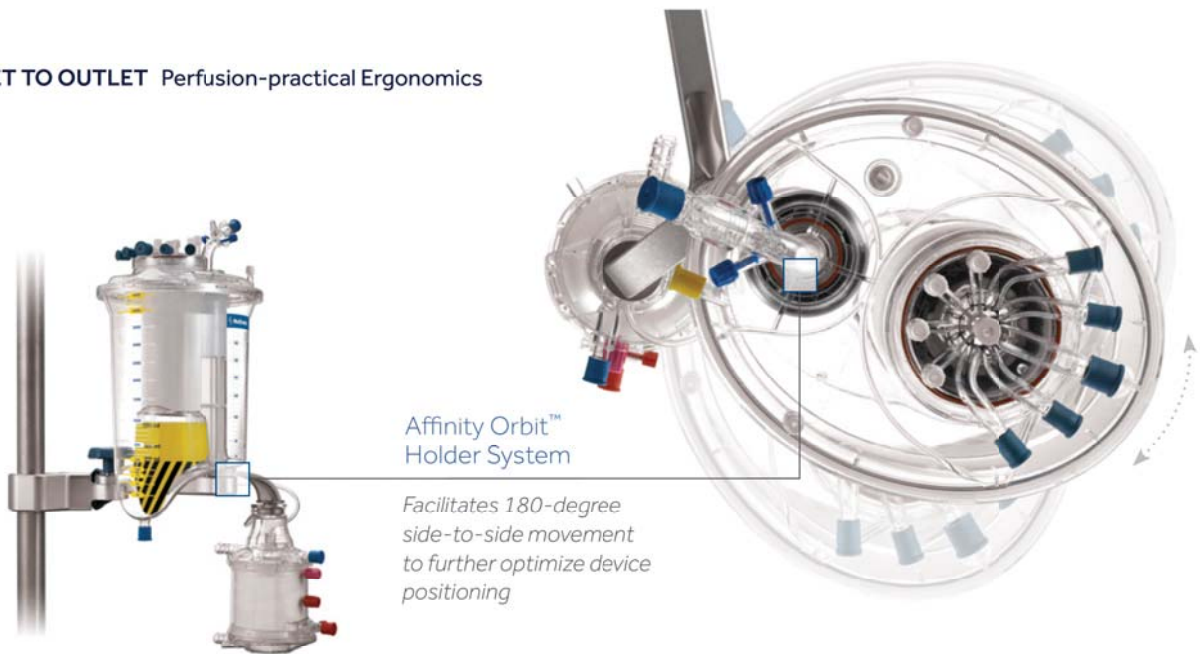

Affinity Orbit™  
Holder System

*Facilitates 180-degree  
side-to-side movement  
to further optimize device  
positioning*



*Easy access, low-profile  
venous temperature port*



*Volume-displacing luer  
caps to prevent areas of stasis*

## MORE ROOM TO SHORTEN LINES.

The Fusion system delivers Perfusion-practical Ergonomics providing improved flexibility, ease of use and set-up, and enhanced customization capabilities.

- The unique Affinity Orbit holder system allows 360-degree positioning and placement flexibility
- Ambidextrous design
- Independent adjustment of the oxygenator and reservoir
- Convenient port locations and spacing
- Non-vented caps for ease of set-up for VAVD procedures (except inlet, outlet and vent/vacuum port)
- Totally clear design for unobstructed visibility of blood, gas and water phases
- Quick and easy set-up and tear down



# THOUGHTFUL DESIGN, FROM INLET TO OUTLET.

The Affinity Fusion oxygenation system takes a fundamentally different design approach.

- Proactive air handling
- Uniquely designed for hemocompatibility
- Improved flexibility and ease of use
- Oxygenator with integrated arterial filter
- Expanded heat exchanger and gas transfer capabilities

Both oxygenator and reservoir devices have:

- Blood-contacting materials made from BPA\*- and DEHP-free polymers
- 1 to 7 L/min flow rate
- Low system priming volume
- Biocompatible surface coatings

Cardiotomy/Venous Reservoir available in:

- Balance Biosurface<sup>1</sup>

Oxygenator available in two biocompatible surface options:

- Balance Biosurface
- Cortiva BioActive Surface

## Balance™ Biosurface

A hydrophilic biosurface option without heparin

- Reduces platelet activation
- Lowers platelet adhesion
- Preserves platelet function<sup>2</sup>

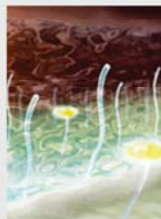

## Cortiva™ BioActive Surface

- Durable, Non-leaching End Point Attached Heparin
- Provides thromboresistance and enhanced blood compatibility

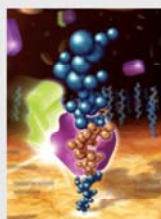

The Affinity Fusion oxygenation system is indicated for use in an extracorporeal circulation circuit during cardiopulmonary bypass procedures up to 6 hours in duration.

**Warning:** A strict anticoagulation protocol should be followed and anticoagulation should be routinely monitored during all procedures. The benefits of extracorporeal support must be weighed against the risk of systematic anticoagulation and must be assessed by the prescribing physician.

For a complete listing of indications, contraindications, precautions and warnings, please refer to the Instructions for Use which accompany each product.

\* Sampling manifold is not BPA-free.

# THE AFFINITY FUSION™ CARDIOTOMY/VENOUS RESERVOIR

- Curved venous inlet, flared walls of the venous inlet down tube and gradual slope of the reservoir contribute to Uniform Flow Distribution
- Separate venous and cardiotomy filter chambers
- Low minimum operating level
- Low dynamic and static hold-up
- Low resistance to flow
- Proactive removal of GME and gross air
- Vacuum Assisted Venous Drainage (VAVD) ready with built-in pressure relief valve and non-vented cardiotomy port covers
- Removable sampling manifold
- Indicated for use for chest drainage collection

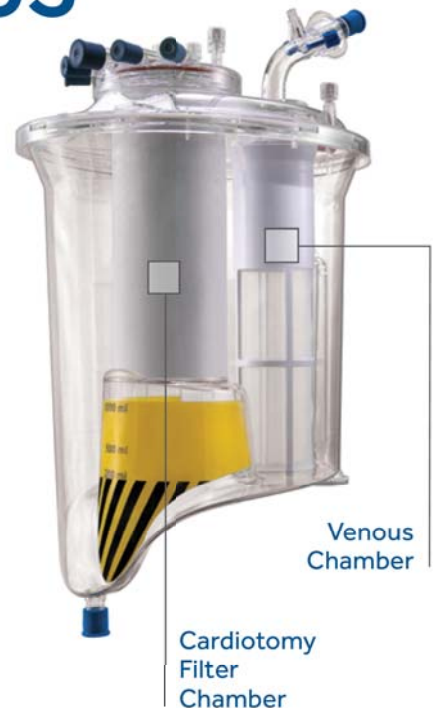

## Curved Venous Inlet

- Creates smooth, fluid blood pathways
- For reduced blood turbulence that could create gaseous micro emboli from gross air
- Reduction in GME generation allows for larger venous screen pore size, lowering dynamic hold-up behind the screen
- For reduced resistance to flow

## Vacuum Port

VAVD ready

## Angled Venous Luer Ports

- Facilitate gentle merging of peripheral blood flow
- For reduced blood turbulence that could create gaseous micro emboli from gross air

## 1/2" to 3/8" Adapter

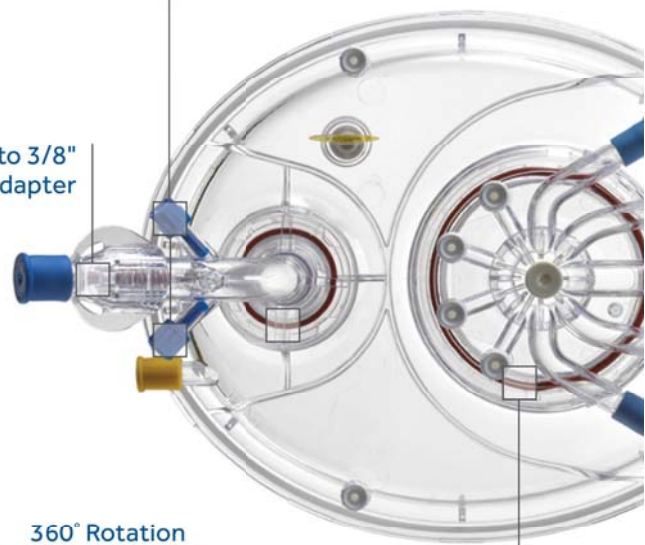

## 360° Rotation

For flexibility in circuit set-up

# DESIGNED FOR CAREFUL BLOOD HANDLING AND AIR MANAGEMENT.

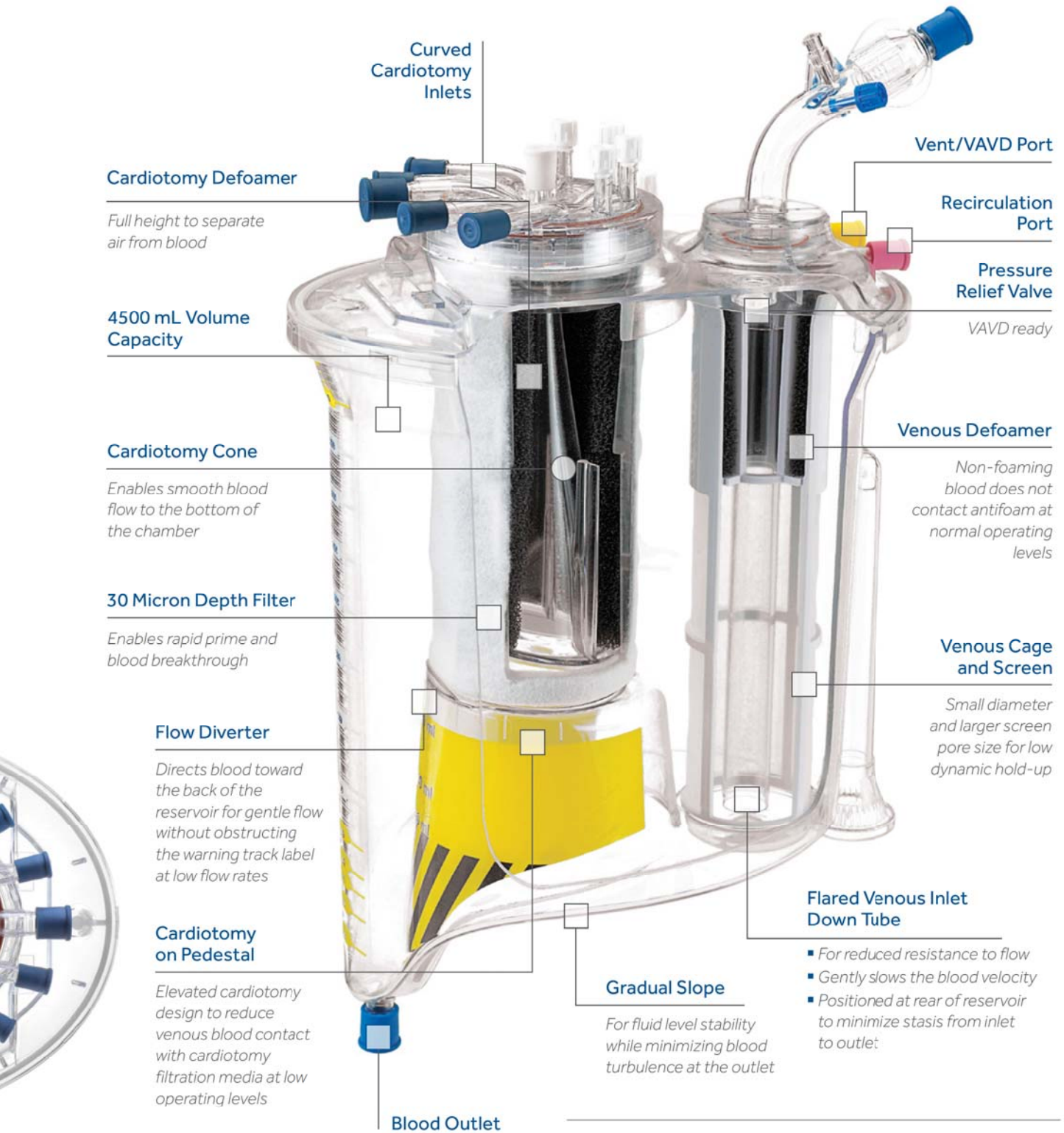

**Caution:** Federal law (USA) restricts these devices to sale by or on the order of a physician. For a complete listing of indications, contraindications, precautions and warnings, please refer to the Instructions for Use.

INLET TO OUTLET Oxygenator

# THE AFFINITY FUSION OXYGENATOR

- 260 mL prime volume
- Enhanced gas transfer and heat exchange performance
- Indicated for use as both an oxygenator and arterial filter
- 25µm filtration
- Efficiently handles air and particulates

Blood Inlet

Recirculation Port

With volume-displacing cap

Cardioplegia Port

With volume-displacing cap

Temperature Port

Dual Outlet Port

- Oxygenated blood exits the device through a unique dual outlet, minimizing areas of stasis, shear or hemolysis
- Provides good temperature and sampling accuracy

Sampling Port

With volume-displacing cap



## Multiple Gas Vents

Reduces the risk of gas pressure build-up in the oxygenator chamber

## Oxygenator Performance Data<sup>3</sup>

Testing performance per ISO 7199, 2009 standard conditions. Based on in vitro data; may not be indicative of clinical results.

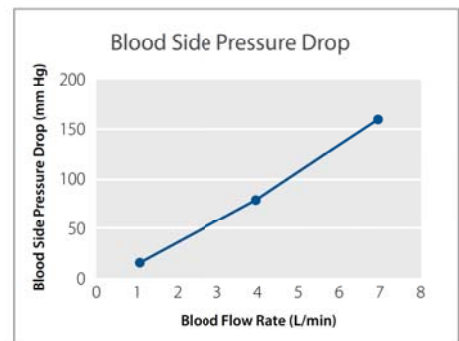
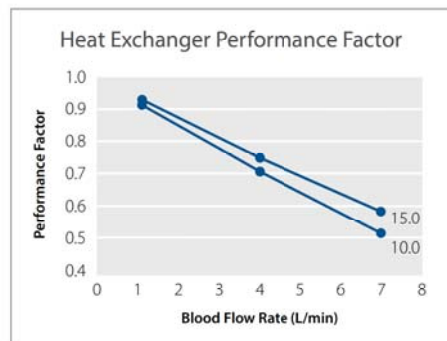
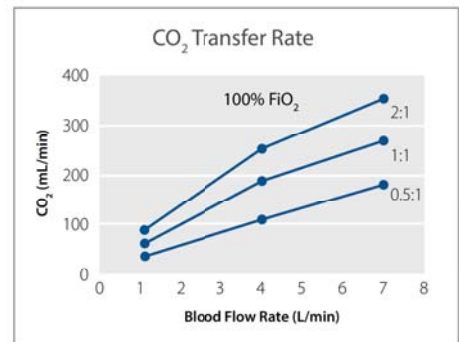
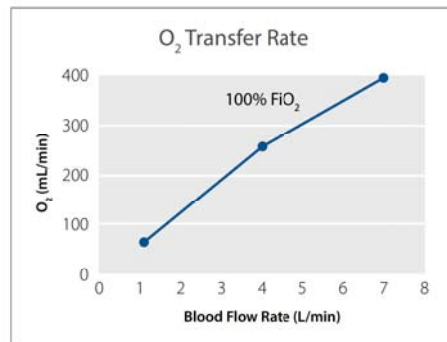

Performance claims based on in vitro product validation test results.<sup>3</sup>



# A FULLY INTEGRATED OXYGENATOR AND ARTERIAL FILTER.



## Pre-membrane Bubble Trap

- Placed at top of oxygenator to purge air before it reaches the fiber membrane
- Tangential flow creates centrifugal force that moves air to the center of device and removes through purge line
- Built-in, one-way valve

## Electrical Shunt

- Equilibrates voltage between the blood and water pathways
- Reduces the potential for electrostatic discharge that may develop inside the blood pathway due to rotation of the roller pump heads

## Plastic Heat Exchanger

- Small tube design of capillaries increases heat exchange performance
- Decreases prime volume
- Minimizes blood-contacting surfaces
- Enables device incineration

## Radial Blood Flow Design

- Facilitates a short, uniform blood flow path that avoids areas of stasis
- Minimizes blood's contact with foreign surfaces

## Proprietary Graduated Fiber Bundle Density Technology

- Optimized bundle efficiency
- Manufacturing consistency
- Progressive Fiber Filtration

## Progressive Fiber Filtration

Within the graduated fiber bundle assembly, gas exchange and particulate filtration occur simultaneously by means of Progressive Fiber Filtration, which allows for:

- Low pressure drop
- Enhanced gas transfer
- Short, uniform blood flow path
- Efficient particulate filtration
- A compact, low-prime design
- Integrated arterial filter

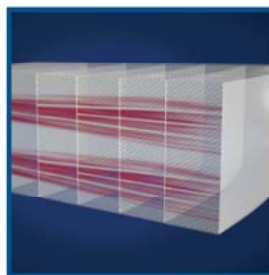

- Blood
- Gas
- Water

**Caution:** Once an oxygenator is primed with blood, adequate heparinization should be maintained per institution cardiopulmonary bypass (CPB) protocol and the blood pathway should be constantly recirculated within the recommended blood flow range.

# Affinity Fusion Oxygenation System

Affinity Fusion Oxygenation Systems		
Model#	Product Description	Units/case
BB841	Oxygenator with Integrated Arterial Filter and Cardiotomy/Venous Reservoir with Balance Biosurface	1
CB841	Oxygenator with Integrated Arterial Filter with Cortiva BioActive Surface and Cardiotomy/Venous Reservoir with Balance Biosurface	1
BB811	Oxygenator with Integrated Arterial Filter and Balance Biosurface	1
CB811	Oxygenator with Integrated Arterial Filter and Cortiva BioActive Surface	1

Affinity Fusion Accessories and Holders		
Model#	Product Description	Units/case
AUH2093	Affinity Orbit Holder System	1
ATP210	Temperature Probe	1
AMH2014	Affinity Manifold Holder	1
RCL841	Recirculation Line	12
AUH4014	Affinity Orbit Arterial Filter Arm	1

## References

1. Technology licensed under agreement from Biointeractions, Limited, United Kingdom.
2. % Functional Platelets Over Time.

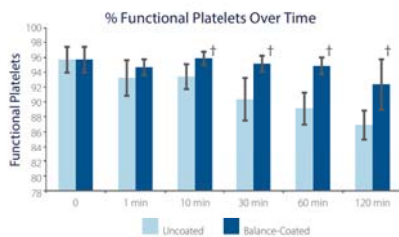

Comparison between Balance-coated and uncoated in vitro bench test circuits of percentage of platelets that are activated with adenosine diphosphate (ADP @20 µM) in circulating heparinized human blood over time. Error bars represent standard deviation. († indicates p<0.05)

3. Data on file at Medtronic.

## Specifications

### Oxygenator

Membrane Type	Microporous polypropylene hollow fiber
Membrane Surface Area	2.5m <sup>2</sup>
Heat Exchange Material	Polyethylene Terephthalate (PET)
Static Priming Volume	260 mL
Recommended Blood Flow Rate	1-7 L/min
Maximum Water Side Pressure	30 psi
Maximum Blood Pressure	750 mmHg
Arterial Outlet Port	3/8"
Venous Inlet Port	3/8"
Arterial Sample Port	Female Luer Port
Recirculation Port	1/4"
Cardioplegia Port	1/4"
Gas Inlet Port	1/4" Nonbarbed
Gas Outlet Port	3/8" Nonbarbed
Water Ports	1/2" Quick Disconnects
Filtration	25µm

### Cardiotomy/Venous Reservoir

Reservoir Volume Capacity	4500 ml
Recommended Blood Flow Rate	1-7 L/min
Maximum Cardiotomy Flow Rate	6 L/min
Minimum Operating Level	200 at 7 L/min
Cardiotomy Filtration	30 µm
Venous Screen	105 µm
Venous Inlet, Rotatable	1/2" with 3/8" adapter
Venous Reservoir Outlet	3/8"
Vent/VAVD Port	1/4" Nonbarbed
Cardiotomy Port (4)	1/4"
Cardiotomy Port (1)	3/8"
Prime Port	1/4" Nonbarbed
Recirculation Port	1/4"
Filtered Luer Lock Ports	4
Non-filtered Luer Lock Ports	2
Venous Luer Lock Ports	2
Positive Pressure Relief Valve Crack	<5 mmHg
Vacuum Pressure Relief Valve Crack	>100 mmHg average

For information on Affinity Fusion visit: [www.fusionoxygenator.com](http://www.fusionoxygenator.com)

For information on other Medtronic technologies for extracorporeal circulation, blood processing and diagnostics, visit: [www.perfusion.medtronic.com](http://www.perfusion.medtronic.com)

# Medtronic

710 Medtronic Parkway  
Minneapolis, MN 55432-5604  
USA  
Tel: (763) 514-4000  
Fax: (763) 514-4879  
Toll-free: (800) 328-2518

**LifeLine**  
**CardioVascular Technical Support**  
Tel: (877) 526-7890  
Tel: (763) 526-7890  
Fax: (763) 526-7888  
rs.cstechsupport@medtronic.com

©2013, 2016, 2017 Medtronic.  
All rights reserved.  
Medtronic, Medtronic logo  
and Further, Together  
are trademarks of Medtronic.  
All other brands are trademarks  
of a Medtronic company.

[medtronic.com](http://medtronic.com)

UC201303375c EN  
12/2017