



DERMATOME ST-5 Skin Transplantation

SURGICAL MOTOR SYSTEMS
Battery Operated

AYGUN[®]
SURGICAL INSTRUMENTS CO., INC.

" Meeting point for surgery..."

EDITON 01



" Meeting point for surgery..."

Aygün has the right to modify and develop the products declared in this catalogue and its production program.

The weight and dimensional information given in our catalog are approximate values.

KA-4027-Y3 Copyright ©
Aygün Co., Inc 2022 All Right
Reserved, Printed in Türkiye

www.aygun.com

OUR HISTORY

AYGÜN, one of the leading establishments of Turkey in the field of Medical Industry, was founded in 1988. It manufactures Container Systems for sterilization, Surgical Motor Systems, Medical Illumination Systems and Single Use Medical Systems in its facility at Samsun Central Organized Industrial Zone.

AYGÜN meets the needs of significant part of Turkey as a result of its continuous R&D works and the capacity increasing. It manufactures its products in international standards and put them to the world market with a high competitive power. Moreover with its integrated quality management system, it proves that it is a specialized establishment.

Besides being a manufacturer, AYGÜN is also a designer company and with its continuous product development works it increases number of its patents, on the other hand, is contributing career development of rising generation by acting as a school.





STERILIZATION CONTAINER SYSTEMS

All AYGÜN sterilization container systems are designed for perfect steam penetration, traceability, safety and stability. The locking mechanisms secure excellent grip and ensure up and down movement of the lids under steam pressure during the sterilization. We service our bottoms and lids made of 2 mm high quality special alloy aluminum raw material to the whole world with 8 basic color options.

CONTAINER MODELS

STANDARD PLUS MODEL
STANDARD MODEL
BIO-BARRIER MODEL
PPSU MODEL
WINDOW MODEL
B3 MODEL
PLASMA MODEL
A1 MODEL
SAFE MODEL



SURGICAL MOTOR SYSTEMS

The expertise of AYGÜN in surgical motor systems gathered up many designs and systems that have special structures servicing from neuro and spinal surgery to many fields like cardiovascular, orthopedic, plastic, hand & foot and maxillofacial surgery. The quality, power and ergonomic design of the new generation of high-tech battery powered surgical motor systems once again demonstrates AYGÜN's expertise in the medical field.

SURGICAL MOTOR SYSTEM MODELS

KARINCA 206
KARINCA 208
DERMATOME BES
DERMATOME ST-5
SKIN GRAFT MESHER
PRAXIS 3
PRAXIS 3B
Sternal Saw 3B
HSM Micro System
HSM 2 Neuro & Spine System
Mini Bone 40.000 rpm
Mini Bone Monoblock
Arthroscopy Shaver
Mini Surgical Motor
Mini Compact
Neuro Air Power
Standard Macro
EPS Motor System
Macro Compact
Mobil Stator
Raptor SPS4



SURGICAL ILLUMINATION SYSTEMS

AYGÜN is furthering a number of R&D projects simultaneously thanks to its advanced R&D infrastructure, team of engineers and technical personnel specialized in their field. Thus, the company holds tens of patents and models actively used in the medical sector.

ILLUMINATION SYSTEMS FEATURES

I-LIGHT LD Specifications
Superior Optical performance
Light beams configuration to provide shadowless illumination
Almost perfect color rendition (Typ. 95)
TFT touch screen for lighting control
Adjustable beam sizes to user preferences
Suitable for use with Laminar Flow functional ceilings
Easy to clean
Minimum Energy Consumption
60.000 hours LED life
Indirect Endo light for endoscopic operations



DISPOSABLE STERILIZATION PRODUCTS

AYGÜN continues expanding its product range by adding other single use medical products to the completely silicone medical drainage systems needed by surgery. With its ISO 7 clean room and by carrying its expertise on sterilization and operation solutions one step further, AYGÜN offers professional service to its valued customers in disposable medical items as well.

DISPOSABLE PRODUCTS MODELS

Reusable Laryngeal Mask
Silicone Penrose Drain Tube
Spiral In Tubes
Silicone Nutrition Tube
Silicone Round Drain
Silicone Flat-Soft Drain
Silicone Flat Drain
Intubation Tube
PVC Laryngeal Mask
Silicone Penrose Drain
Silicone Thorax Drain
Tracheostomy tube
Intubation Tube
Vac Silicone Drain
Oxygen Mask

for more

visit us

www.aygun.com

GROWING UP TOGETHER

AYGÜN has an actively growing position in the sector through using a high technology and innovative institutional structure.



OUR VISION

The vision of AYGÜN is to grow in health sector according to the developing technology and sectoral innovations and serve humanity by producing new project and products appropriate to these innovations.

OUR MISSION

AYGÜN builds projects that can contribute to human health all over the world and integrates these projects to its production area and products in the light of technological developments. It constantly stays active with its innovative and explorer soul and remains taking part among the leader companies ruling the sector.

QUALITY MANAGEMENT SYSTEM

- ISO 9001:2015
- ISO 14001:2015
- ISO 45001: 2018
- ISO 13485:2016
- 93/42/EEC
- FDA 510 (K)
- 2017/745 (EU)





AYGÜN®
SURGICAL INSTRUMENTS CO., INC.

PRODUCTION

Sense of high-grade quality in each process from raw material supply to the shipment is combined with integrated quality management system according to the standards. A big stuff gathered under the same roof and adopted importance of teamwork carry all stages above the dreams and makes what is desired real.

TECHNICAL INFRASTRUCTURE

CNC Machines

Hydraulic and Eccentric Presses

Hot Presses

Conventional CNC Machines

Mold Design and Molding Technology

3D Modelling Technology

Thermoforming

Cutting Machines

Electronic Design and Manufacturing Engineering

Software Technology

Fine Mechanic Techniques

Hardening

Laser Technology

Silicone Extrusion Technology

Clean Room – ISO 7

Chemical Coating and Anodizing Technology

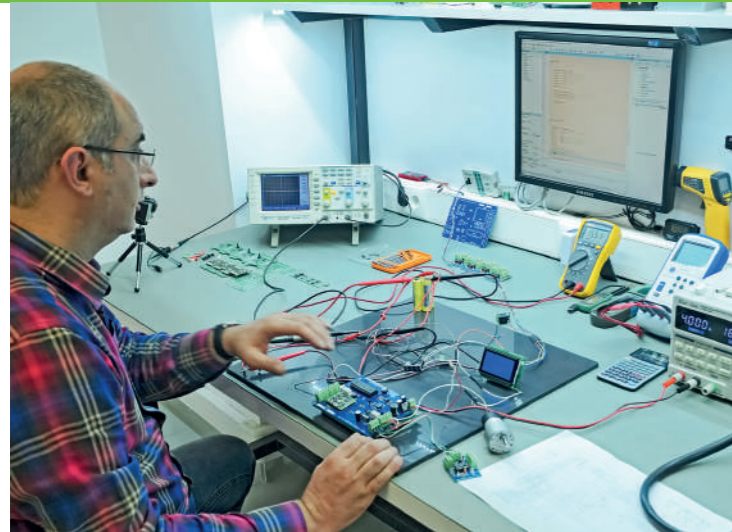

COMBINATION OF PRECIOUS HIGH TECHNOLOGY PRODUCTION MACHINES AND PERFECT CRAFTSMANSHIP

New product development desire and need began in minds becomes sharable and interpretable with 3D printers and technical drawings. After setting the models and testing the prototypes, the production process starts for the approved designs. The production starts with combination of high technology production machines and perfect craftsmanship.

RESEARCH, DEVELOPMENT, QUALITY

AYGÜN increases its power with its endless R&D works. It makes all needed investments so as to research and develop even the smallest part of the complicated products manufactured and carries out successful projects with its professional engineer team. It both develops the existing products with today's technology and performs serious works on new product designs.

- High Power
- New Generation Cutting Technology
- New Generation Surgical Motor Technology
- Li-ion Battery Technology



DERMATOME ST-5

- Special designed hand pieces for different operation variations
- Small, medium and large head designs provides precise cutting results in different areas
- Light weight and cordless, battery operated ergonomic system offers mobility
- Quick, easy and safe blade replacement mechanism
- 10 level for cutting thickness adjustment with 5 main and 5 intermediate level for sensitive results
- High quality dermatome blades for precise and smooth consequences
- Provides 40 mm, 80 mm and 120 mm cutting width options for standard use (With the help of width reduction clamp, it allows cutting in special dimension)

Ceramic Dermatome Blade

- Provides up to 10 times sharpness than traditional steel blades
- Biocompatible zirconium oxide (ZrO₂) ceramic material
- Autoclavable
- Not affected by chemicals
- Provides measurement stability with its rigid structure

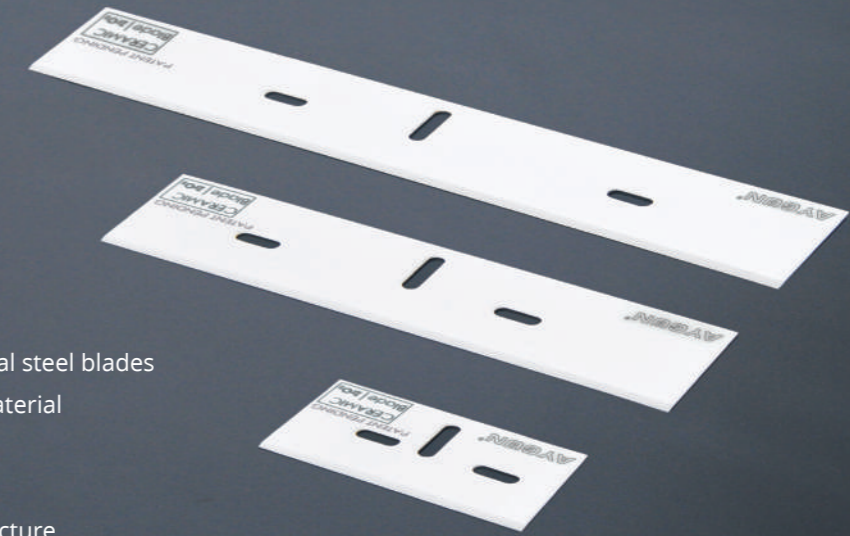

Green, yellow and red lights indicate charging status.

White light indicates that the motor is ready for operation.



Mechanical structure of Dermatome ST-5 Handpieces provides users non-restrictive washing and disinfection.



The use of width-reducing clamps on the dermatome head allows cutting of smaller graft widths.



POWER BOX



M10-502
Power Box

- Powerful DC motor technology
- Battery type: Li-ion
- Battery capacity: 700 mAh
- Voltage: 12.6 Volts
- Charging time: 45 min
- Not Autoclavable
- Ø 30 x 195 mm / 300 g

- High technology Li-ion battery and Swiss made surgical motor
- Indicator light technology enables to monitor battery capacity without removing power box by user
- White indicator light informs user about not to put the product in autoclave when power box is not removed
- Non-sterile battery, motor and electrical parts increases durability of product life
- Extended battery life
- Flashing light on power box shows that the device is ready for use and also warns the user about preventing from putting into the sterilization device



M10-504
Autoclavable sterile funnel
for aseptic battery loading

- Steam sterilisable
- Ø 45 x 35 mm / 35 g



BATTERY CHARGING UNITS

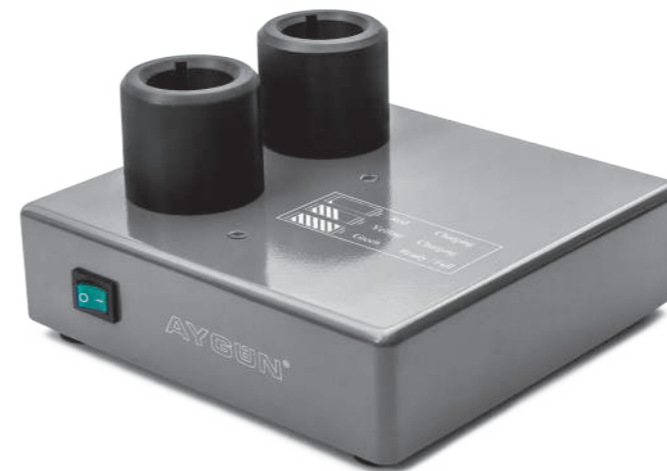
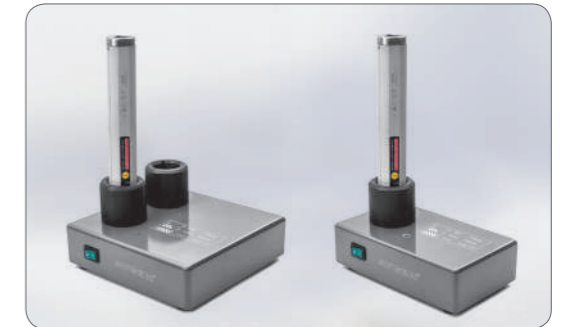

M10-503
Charger unit for 2 battery

- Main voltage 100-240 Volts, 50-60 Hz
- Charging current 2.3 A (x2)
- Charging voltage 12.6 Volts
- Protections: Short circuit / Overload / Over voltage
- Charging indicator led
- Battery not included
- 175 x 190 x 100 mm / 1400 g

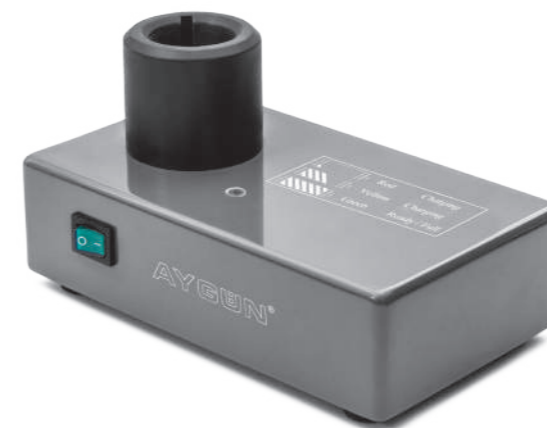

M10-505
Charger unit for 1 battery

- Main voltage 100-240 Volts, 50-60 Hz
- Charging current 2.3 A
- Charging voltage 12.6 Volts
- Protections: Short circuit / Overload / Over voltage
- Charging indicator led
- Battery not included
- 175 x 120 x 100 mm / 850 g

DERMATOME SMALL HANDPIECE (40 mm)

Dermatome Level	Cutting mm	Thickness inch
0	0.0	0.00000
1	0.1	0.00394
2	0.2	0.00787
3	0.3	0.0118
4	0.4	0.0157
5	0.5	0.0197
6	0.6	0.0236
7	0.7	0.0276
8	0.8	0.0315
9	0.9	0.0354
10	1	0.0394



M10-400
Dermatome Small Handpiece (40 mm)

- Autoclavable
- 16.000 cpm
- 290 x 65 x 50 mm / 730 g

DERMATOME HANDPIECE (80 mm)

Dermatome Level	Cutting mm	Thickness inch
0	0.0	0.00000
1	0.1	0.00394
2	0.2	0.00787
3	0.3	0.0118
4	0.4	0.0157
5	0.5	0.0197
6	0.6	0.0236
7	0.7	0.0276
8	0.8	0.0315
9	0.9	0.0354
10	1	0.0394



M10-500
Dermatome Handpiece (80 mm)

- Autoclavable
- 16.000 cpm
- 290 x 105 x 50 mm / 1024 g



M7-104
Spare blades (10 ea)
One side cutting only.
Stainless steel

- 41 x 18,5 x 0,40 mm

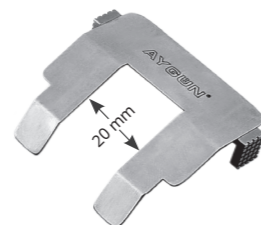

M10-400A
Width reducing clamp (20 mm)



M7-104C
Ceramic spare blade (1 piece)
(Ultrasharp)
One side cutting only.
Zirconium oxide (ZrO2)
Patent pending

- 41 x 18,5 x 0,40 mm



M7-105
Spare blades (10 ea)
One side cutting only.
Stainless steel

- 81 x 18,5 x 0,40 mm



M7-105C
Ceramic spare blade (1 piece)
(Ultrasharp)
One side cutting only.
Zirconium oxide (ZrO2)
Patent pending

- 81 x 18,5 x 0,40 mm

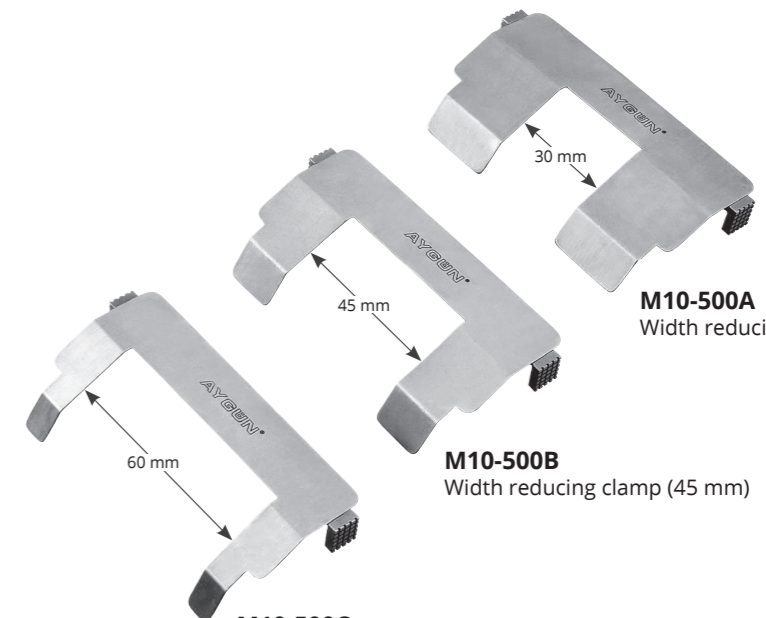

M10-500A
Width reducing clamp (30 mm)

M10-500B
Width reducing clamp (45 mm)

M10-500C
Width reducing clamp (60 mm)

DERMATOME LARGE HANDPIECE (120 mm)

Dermatome Level	Cutting mm	Thickness inch
0	0.0	0.00000
1	0.1	0.00394
2	0.2	0.00787
3	0.3	0.0118
4	0.4	0.0157
5	0.5	0.0197
6	0.6	0.0236
7	0.7	0.0276
8	0.8	0.0315
9	0.9	0.0354
10	1	0.0394



M10-600
Dermatome Large Handpiece (120 mm)

- Autoclavable
- 16.000 cpm
- 290 x 145 x 50 mm / 1360 g

WIDTH REDUCING CLAMP FOR LARGE DERMATOME

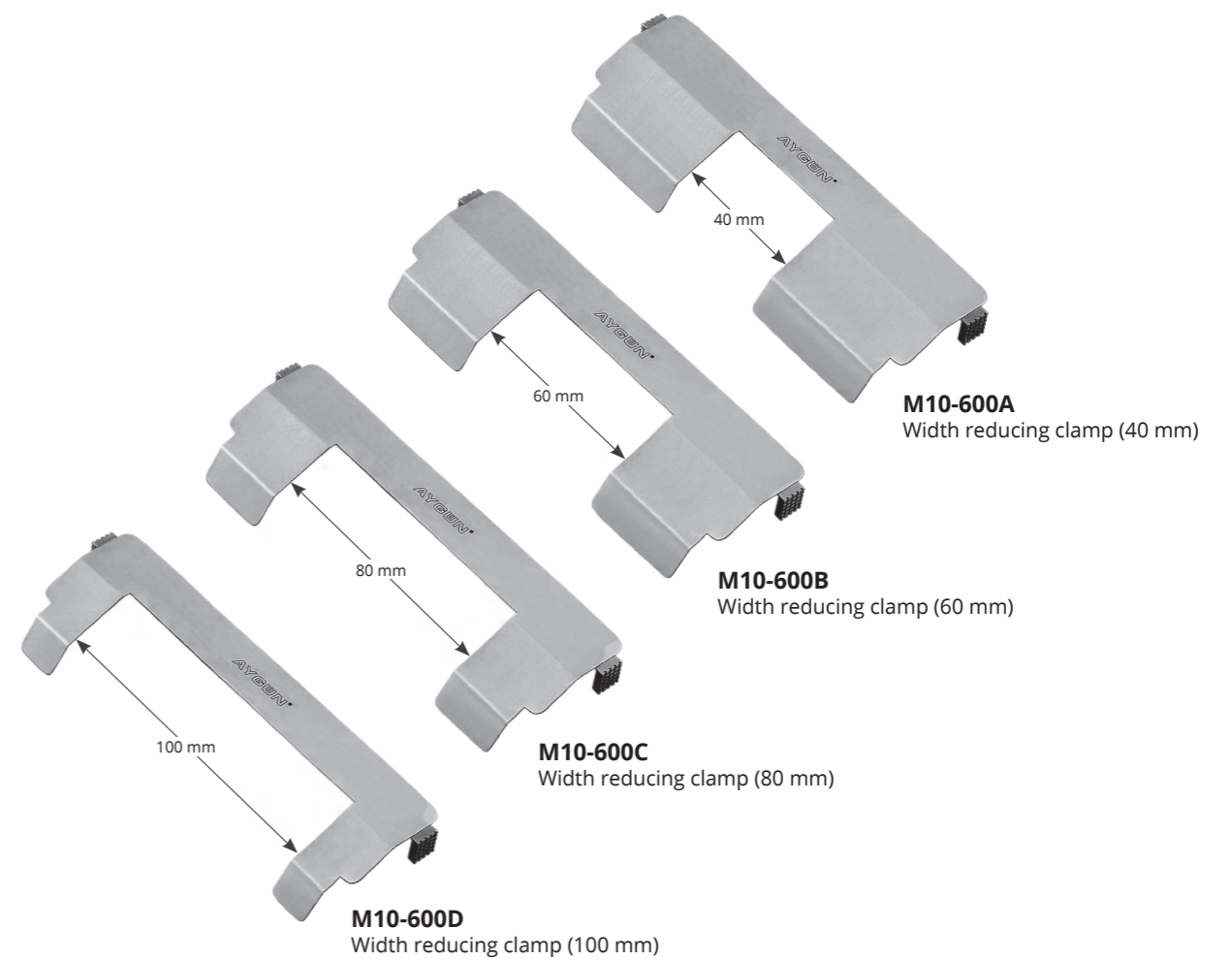

M7-106
Spare blades (10 ea)
One side cutting only.
Stainless steel
• 121,5 x 18,5 x 0,40 mm



M7-106C
Ceramic spare blade (1 piece)
(Ultrasharp)
One side cutting only.
Zirconium oxide (ZrO2)
Patent pending
• 121,5 x 18,5 x 0,40 mm

DERMATOME BATTERY SET



M10-510 Dermatomome Battery Set

Set Content

M10-500	Dermatome Handpiece
M10-502	Power box
M10-504	Autoclavable sterile funnel for aseptic battery loading
M10-505	Charger unit for 1 battery
M7-105C	Ceramic spare blade
M10-500A	Width reducing clamp (30 mm)
M10-500B	Width reducing clamp (45 mm)
M10-500C	Width reducing clamp (60 mm)
M14-816	Spray oil
M10-530	PPSU attachment stand
K3-762	Lid
K3-751	Basket
K6-340	Perforated lid
K6-307	Box, non perforated

ACCESSORIES

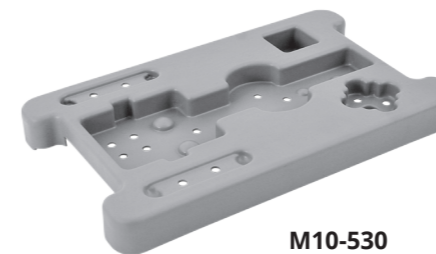

M10-530
PPSU attachment stand



K3-762 (Lid)
407 x 256 x 4 mm

K3-751
Basket, made from stainless steel sheet
405 x 253 x 110 mm



K6-340
Perforated Lid, Standard Model
460 x 285 mm

K6-307
Box, non perforated
475 x 272 x 138 mm



M10-505
Charger unit for 1 battery



M10-502
Power box



M10-500A (30 mm)
M10-500B (45 mm)
M10-500C (60 mm)
Width reducing clamp



M14-816
Spray oil



M14-816
Spray oil



- Guides for Graft Carrier
- Ratchet Handle for Easy Operation
- Graft Thickness Adjustment (0-1,5 mm)

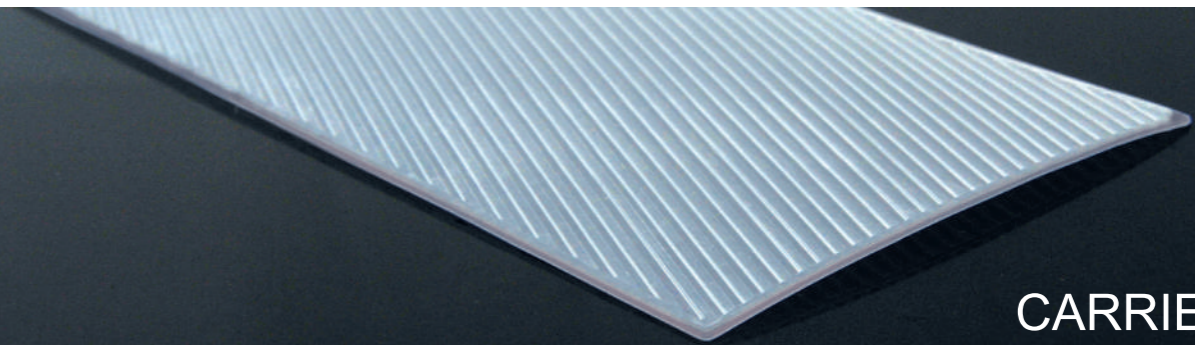

CARRIER

SKIN GRAFT MESHER



M11-500G
Skin Graft Mesher
205 x 165 x 120 mm / 4000g

- Single cutter cuts skin graft into geometrical shaped mesh & enlarges skin surface
- Graft expansion predetermined by graft carrying plates, eliminates the need to change the cutter during operation
- Continuous feed design prevents graft carrying plate from being loaded incorrectly and allows multiple plates to be used without interruption
- Graft thickness adjustment feature allows expansion on thin and thick grafts
- Easy availability of replacement parts

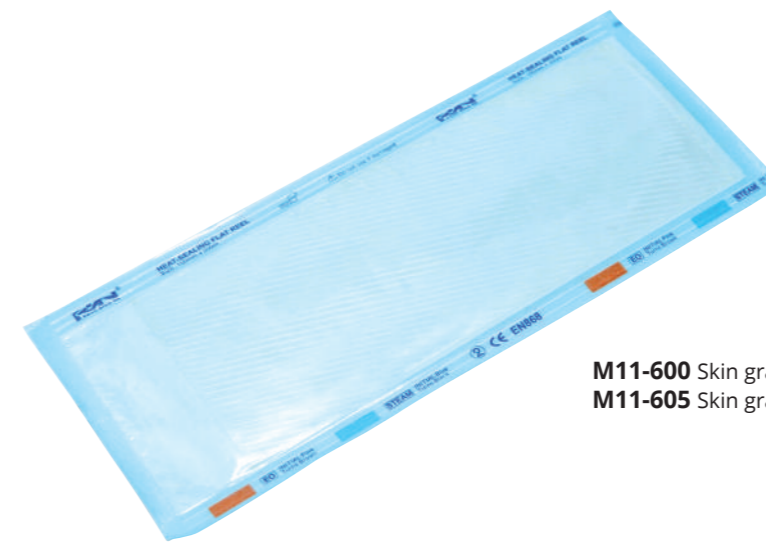

M11-600 Skin graft carrier > 1,5:1 (Box of 20)
M11-605 Skin graft carrier > 3:1 (Box of 20)

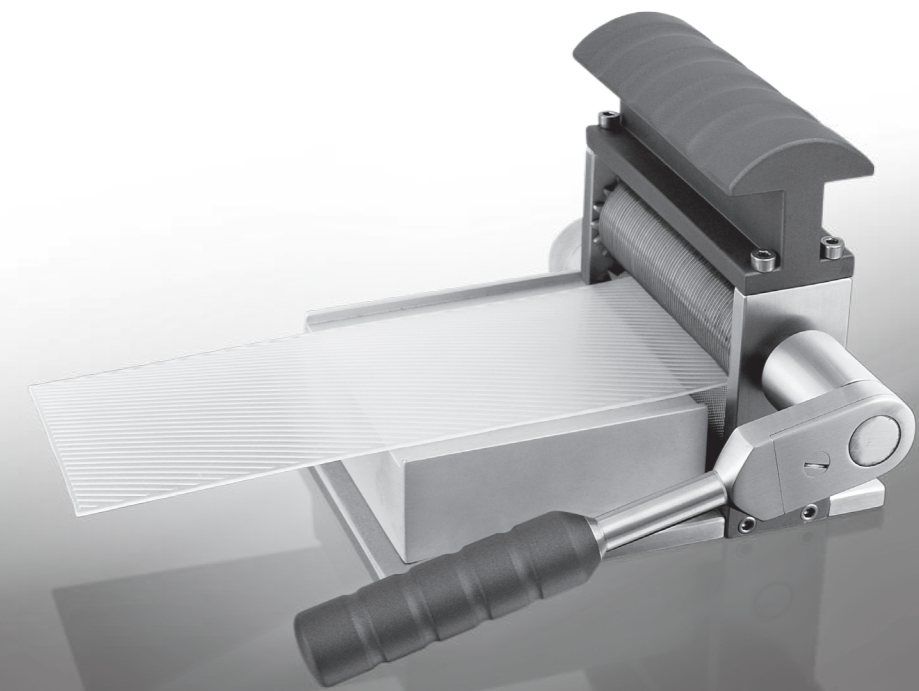

CONTAINER SET FOR STERILIZATION



K8-123V
Lid, B3 Barrier Model
585 x 285 mm

K6-107
Container, non perforated
600 x 272 x 138 mm



K8-343V
Lid, B3 Barrier Model
460 x 285 mm

K6-307
Container, non perforated
475 x 272 x 138 mm



K3-742
Basket made from
stainless steel sheet (with stand)
540 x 253 x 80 mm



K3-750
Basket made from
stainless steel sheet (with stand)
405 x 253 x 80 mm



K2-462
Wire basket
540 x 245 x 70 mm



K2-1502
Wire basket
405 x 245 x 70 mm

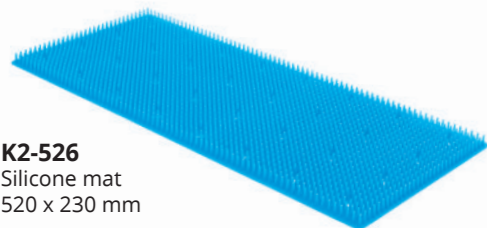

K2-526
Silicone mat
520 x 230 mm

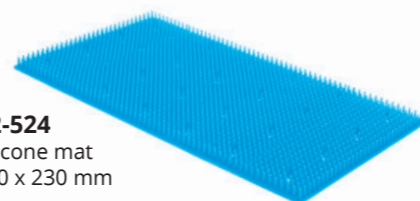

K2-524
Silicone mat
380 x 230 mm

	code	color
Thoracotomy	K2-700	Red
Basic Set	K2-701	Blue
Thoracotomy	K2-702	Green
Basic Set	K2-703	Yellow
Thoracotomy	K2-704	Grey
Basic Set	K2-705	Black
Thoracotomy	K2-706	Pink
Basic Set	K2-707	Brown

Identification labels (aluminium)
Coloured identification labels
Engraved to your specifications
Maximum 16 letters

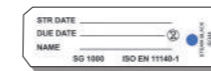

K2-673
Labels (paper)
100 pcs. With indicator.
For small size and special
containers

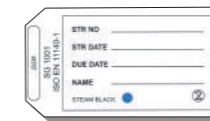

K2-672
Labels (paper)
100 pcs. With indicator.
For full and half size containers



K1-900
Modular Auto Lock Mechanism (2 Pcs)



K2-660 red
Security seal
100 pcs made of plastic



K2-740
Single use paper
filter 100 pcs
with indicator.
Aygün mark.



For more information and alternative please see
our Sterilization Container System catalog.
From our website www.aygun.com

DERMATOME ST-5 Surgical Motor Systems

Battery Operated

New website, tens of high quality catalogues and thousands of products,



Standard Plus Model



Bio-Barrier Model



B3 Barrier Model
PTFE - Valve - Biostop



PPSU Model



Standard Model



Scoren



Karınca 206



Raptor SPS 4



Dermatome ST5



Dermatome
Skin Graft Mesher



A1 Model



Window Model



Plasma Model



Dental, Mini &
Special Model



Basket



Karınca 208



HSM-2
Neuro System



HSM
Neuro System



Mini Bone



Mini Bone
Monoblock



Artroscopy
Shaver System

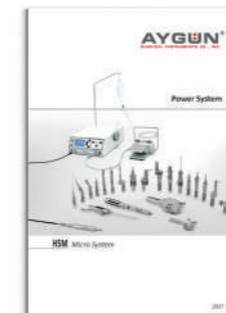

HSM
Micro System



Praxis 3



Praxis 3B



Standard Macro



Electro Pneumatic
Surgical Motor



Macro Compact 2



Mini Compact



NAP Neuro Air
Power



Mini Surgical Motor

INDEX

CODE	PAGE	CODE	PAGE
K1-900	23	M7-104C	14
K2-462	22	M7-105	15
K2-524	22	M7-105C	15
K2-526	22	M7-106	16
K2-660	23	M7-106C	16
K2-672	23	M10-400	14
K2-673	23	M10-400A	14
K2-700	23	M10-500	15
K2-701	23	M10-500A	15, 18
K2-702	23	M10-500B	15, 18
K2-703	23	M10-500C	15, 18
K2-704	23	M10-502	12, 18
K2-705	23	M10-503	13
K2-706	23	M10-504	12
K2-707	23	M10-505	13, 18
K2-740	23	M10-510	18
K2-1502	22	M10-530	19
K3-742	22	M10-600	16
K3-750	22	M10-600A	17
K3-751	19	M10-600B	17
K3-762	19	M10-600C	17
K6-107	22	M10-600D	17
K6-307	19, 22	M11-500G	20
K6-340	19	M11-600	21
K8-123V	22	M11-605	21
K8-343V	22	M14-816	19
M7-104	14		

AYGÜN®
SURGICAL INSTRUMENTS CO., INC.

FACTORY

AYGÜN CERRAHİ ALETLER A.Ş.
Organize Sanayi Bölgesi
Yaşar Doğu Caddesi, No: 76
Kerimbey OSB, 55300, Tekkeköy
SAMSUN, TÜRKİYE

T : +90 (362) 266 66 80

F : +90 (362) 266 93 30

aygun@aygun.com

www.aygun.com