

Description

The U7 series is constant-current, NFC programmable and IP20 rated LED driver that operates from 176~305Vac input with excellent power factor. The NFC interface implemented enables an easy and safe way for programming LED drivers during the production process and in the field. The parameters can be transferred without powering on the LED driver. U7 series integrate AC power monitoring with an auxiliary voltage and dim-to-off functionality for powering low voltage. The dimming control supports two-way communication via DALI-2 and complies with D4i. The better thermal design and high efficiency enables the driver to operate with high reliability and extend product lifetime. Overall protection is provided against lightning surge, output over voltage, short circuit, and over temperature to ensure low failure rate.



Product Features

- Universal input voltage / Full range: 176~305Vac;
- Constant power design, output current programming adjustable;
- DALI-2 & D4i Certified;
- Adjustable Output Current (AOC) with NFC programmable;
- Over temperature protection via external NTC;
- Constant lumen output(CLO);
- Suitable for luminaires with protection Class I and II;
- Integrated 16Vdc Bus Power Supply Based on DALI-2;
- Auxiliary power supply: 24V/125mA;
- Output and Dimming Signal Isolating;
- Surge protection: 6KV line-line, 10KV line-earth(Class I);
- Complies with Zhaga Interface Specification Book 13;
- Protections: SCP/UVP/OVP/OTP;
- IP20 design for indoor and outdoor applications
- Suitable for dry / damp / wet locations;
- 7 years warranty.

Application

Roadway lighting,
Industrial lighting,

Models

Model Number	Input Voltage Range(Vac)	Max Output Power(W)	Output Voltage Range(Vdc)	Full Power Output Current Range(A)	Default Current(A)	Eff.(Typ.)	PF(Typ.)	THD
U7-200D286	176-305	200	143-286	0.70-1.05	0.70	93%	0.97	5%

NOTES:

[1]. All specifications are measured at 25°C ambient temperature, input voltage 230Vac, and the typical value tested by full load, if no specific note.

Input Specifications

Parameter	Min	Typ.	Max	Notes
Input Voltage	176Vac	220~240Vac	305Vac	
Input Frequency AC	47Hz	50/60Hz	63Hz	
Max Input Current	-	-	1.6A	176Vac&Full Load
Max Input Power	-	-	240W	176Vac&Full Load
Leakage Current	-	-	0.70mA	IEC 60598-1;240Vac/60Hz
Inrush Current	-	-	75A	230Vac&Full Load, Cold Start
Standby Power Consumption	-	-	0.5W	230Vac&50Hz, Auxiliary Power Without Load and 16Vdc Bus Power Supply Shut Off
Power Factor(PF)	0.96	0.98	-	220-240Vac, 50-60Hz, 100% Load
Power Factor(PF)	0.90	0.92	-	220-240Vac, 50-60Hz, 60%-100% Load
Total Harmonic Distortion(THD)	-	5%	10%	220-240Vac, 50-60Hz, 100% Load
Total Harmonic Distortion(THD)	-	-	10%	220-240Vac, 50-60Hz, 60%-100% Load
MCB(B16)	-	3	-	230Vac

Output Specifications

Parameter	Min	Typ.	Max	Notes
Output Voltage Range	143Vdc	-	286Vdc	The full power cannot be lower than 191Vdc
Open Circuit Voltage	-	-	310Vdc	The open circuit protection is locked, and the AC needs to be powered on again
Output Current Range	70% I_{set}	-	100% I_{set}	The NFC or Dali programmer regulates the I_{set} current
Full Power Current Range	0.70A	-	1.05A	
Current Accuracy	-5% I_{set}	-	+5% I_{set}	$I_{set}>0.70A$
Total Output Current Ripple (pk-pk)	-	5%	10%	20MHz BW, full load& LED load, the ripple would be tiny different under different LED load.
Startup Overshoot Current	-	5%	10%	220~240Vac & 100% Load, load is LED
Line Regulation	-1%	-	+1%	25°C±10°C ambient temperature, input voltage changes from 200Vac to 240Vac.
Load Regulation	-3%	-	+3%	25°C±10°C ambient temperature, Input Voltage 230Vac, load changes from 60% to 100%.
Turn-on Delay Time	-	1.0s	1.5s	230Vac
Isolation input to output	-	Double	-	
Output P_{st}^{LM}	-	-	0.01	In entire operating window
Output SVM	-	-	0.01	In entire operating window
Power Monitoring Accuracy	-5%	-	5%	Measured at 230Vac input and 100% load

General Specifications

Parameter	Min	Typ.	Max	Notes
Efficiency@230Vac I _o =1.05A I _o =0.70A	90% 91%	92% 93%	- -	Measured at full load and 25°C ambient temperature 24V No Load
Mean Time Between Failure	-	200Khours	-	25°C±10°C ambient temperature, 230Vac, 80% load (MIL-HDBK-217F/ Telcordia SSR-332)
Life Time	-	80Khours	-	T _c =75°C, 230Vac&100% load,
Operating Temperature	-40°C	-	+50°C	230Vac&100% load
Operating T _c for Safety T _{c_s}	-40°C	-	+90°C	
Operating T _c for Warranty T _{c_s}	-40°C	-	+75°C	5 years warranty case temperature Humidity: 10% to 80% RH No condensation
Storage Temperature	-40°C	-	+85°C	Humidity: 5% to 50% RH No condensation
Altitude	-60m	-	4000m	
Input Under voltage Protection	130Vac	150Vac	170Vac	When the input voltage is lower than the protection voltage, the driver will turn off automatically. When the input voltage exceeds the recovery voltage, the driver will restart automatically.
Input Over voltage Protection	305Vac	325Vac	345Vac	The input voltage exceeds the protection voltage, the output is turned off. Automatic recovery. When the input voltage falls below the recovery voltage, the drive will restart.
External NTC (R1)	-	20.05K ohm (Set by software)	-	When the R-NTC is reduced to R1, the external thermal protection is triggered and the output current gradually decreases.
External NTC (R2)	-	10.27K ohm (Set by software)	-	When the R-NTC is reduced to R2, the output current is reduced to the programmed protection current value.
External NTC (Protection Circuit)	10%I _{oset}	60%I _{oset}	100%I _{oset}	10%I _{oset} >I _{omin} (Default setting 60%).
External NTC (Protection Circuit)	I _{omin}	60%I _{oset}	100%I _{oset}	10%I _{oset} ≤I _{omin} (Default setting 60%).
Output over voltage Protection	-	-	-	AC needs to be powered on again
Over Temp Protection T _c	-	95°C	-	T _c ; 230Vac&100% load
Short Circuit Protection	-	-	-	self-recovery after 30 seconds
Dimensions (L*W*H)mm	171*101*41mm			
Net Weight	1000±100g/PCS			
Package (L*W*H)mm	405*369*180mm; 18PCS/ctn, Gross Weight: 20kg			

Notes:

NTC:100K NTC B value: 4050, 10 K NTC B value: 3380, the tolerance is within 2°C, Other NTC tolerance are within 5°C Celsius.

DALI Specifications

Parameter	Min	Typ.	Max	Notes
24V Auxiliary Output Voltage	21.6V	24V	26.4V	220-240Vac, P _{load} >0.1W
24V Auxiliary Output Source Current	0mA	-	125mA	Return terminal is "24V-"
24V Auxiliary Output Transient Peak Current @6W	-	-	250mA	250mA peak for a maximum duration of 2.2ms in a 6.0ms period during which time the average should not exceed 125mA.
24V Auxiliary Output Transient Peak Current @10W	-	-	425mA	425mA peak for a maximum duration of 1.3ms in a 5.2ms period during which time the average should not exceed 125mA.
Integrated DALI-2 Bus Power Supply Voltage	12V	16V	20V	Voltage is depending on loading.
Integrated DALI-2 Bus Power Supply Current	50mA	-	60mA	Return terminal is "DA-"
DALI-2 (High Voltage Level)	9.5V	16V	22.5V	
DALI-2 (Lower Voltage Level)	-6.5V	0V	6.5V	Return terminal is "DA-"
DALI-2 (Dimming Output Range)	10% I _{set}	-	100% I _{set}	I _{set} =0.70~1.05A
DALI-2 (Sink Current)	-	-	2.0mA	

Insulation

Insulation	Mains	EQUI	LED +/- NTC	DA+ / Vaux
Mains	-	Double	Double	Double
EQUI	Double	-	Double	Supplementary
LED +/- NTC	Double	Double	-	Supplementary
DA+ / Vaux	Double	Supplementary	Supplementary	-

Notes:

[1] DALI-2 bus power supply is enabled by default and can be disabled via programming interface.

[2] DALI-2 bus power supply supports automatic shut-down and restart after short-circuit.

[3] DALI signal line shall not be connected to the five core terminal shared by input and dimming

[4] The DALI signal line shares the negative with the 24V auxiliary source. The 24V auxiliary source can be used alone or share the negative pole with the DALI line

Safety Specification

Parameter	Min	Typ.	Max	Notes
Dielectric Strength(Input-Output)	-	3750Vac	-	60s, Current not exceeding 5mA
Dielectric Strength(Input-Ground)	-	3750Vac	-	60s, Current not exceeding 5mA
Dielectric Strength(Output-Ground)	-	3300Vac	-	60s, Current not exceeding 5mA
Insulation Resistance	10MΩ	-	-	Input-Output, Input-PE, Output-PE, 500Vdc/60s/25°C/70%RH

Safety Compliance

Safety Category	Standards	Approved	Notes
CCC	GB19510.1, GB19510.14		
CE	EN61347-1, EN61347-2-13, EN62493	√	
ENEC	EN61347-1, EN61347-2-13, EN62384	√	
CB	IEC61347-1, IEC61347-2-13	√	
BIS	IS 15885(PART 2/SEC 13)		
UL	UL 8750		
CUL	CSA C22.2 No.250.13		
KC	K61347-1, K61347-2-13		
PSE	J61347-1, J61347-2-13		
SAA	AS/NZS IEC 61347.2.13		
SAA	AS/NZS 61347.1		

EMC Compliance

EMC Category	Standards	Approved	Notes
CCC	GB/T 17743, GB 17625.1		
CE	EN 55015	√	
CE	EN 61000-3-2, EN 61000-3-3	√	
CE	EN61000-4-2,3,4,5,6,11	√	
CE	EN 61547	√	
KC	K61547		
KC	K00015		
PSE	J55015		
FCC	FCC part 15		
Surge Shock Immunity	ANSI/C82.77-5-2017		
Ringin Wave			

RoHS

Our products comply with RoHS Directive (EU) 2015/863 amending Annex II to Directive 2011/65/EU.

Inrush Current

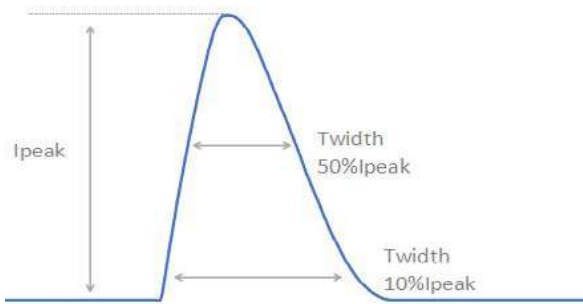

V_{in}	I_{peak}	$T(@10\% \text{ of } I_{peak})$	$T(@50\% \text{ of } I_{peak})$
220Vac	60A	910uS	500uS

Output Voltage vs. Output Current

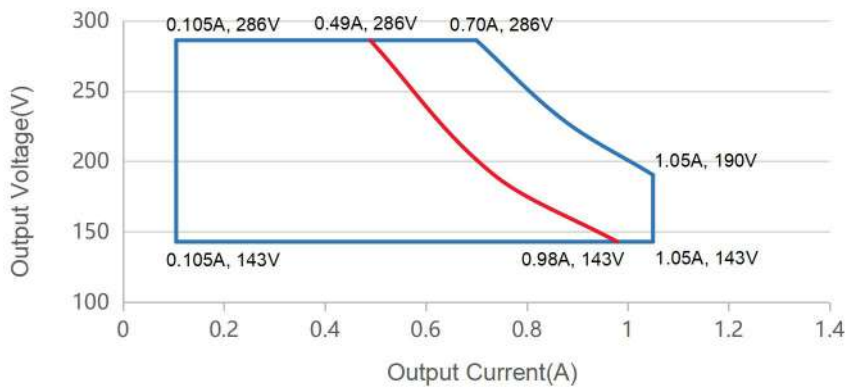

Red curve: good performance area

Output Power vs. Input Voltage

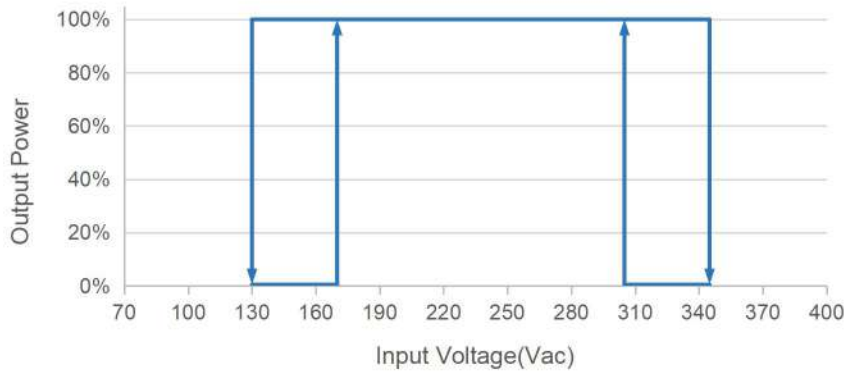

Efficiency vs. load

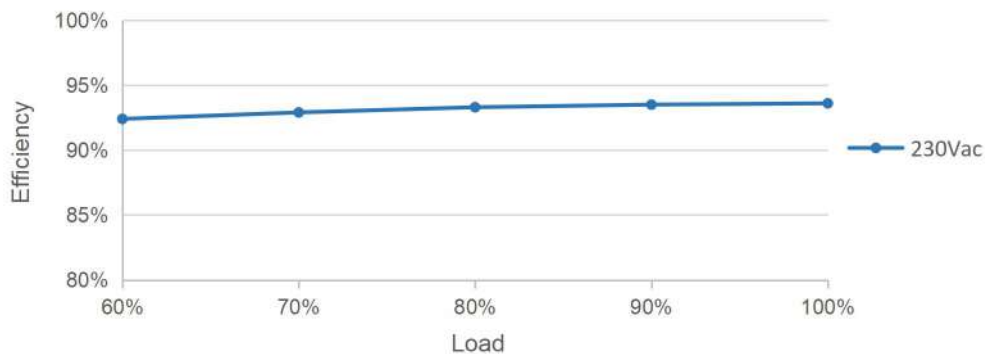

PF vs. Load

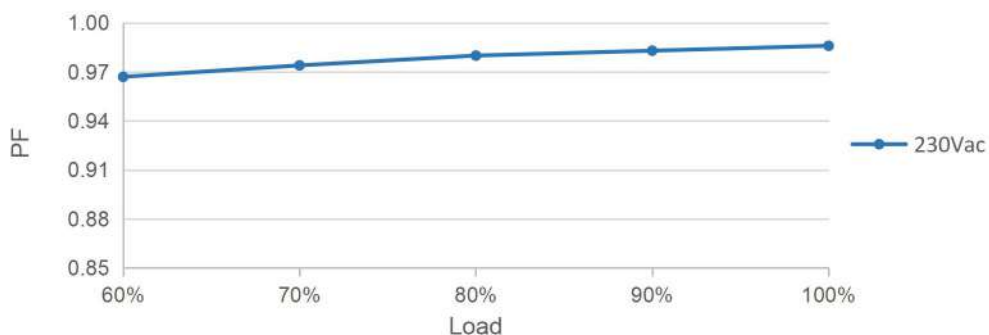

THD vs. Load

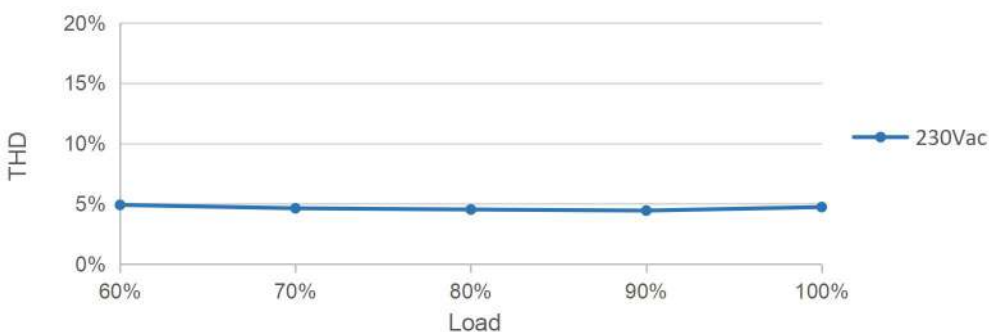

Output Power vs. Ambient Temperature

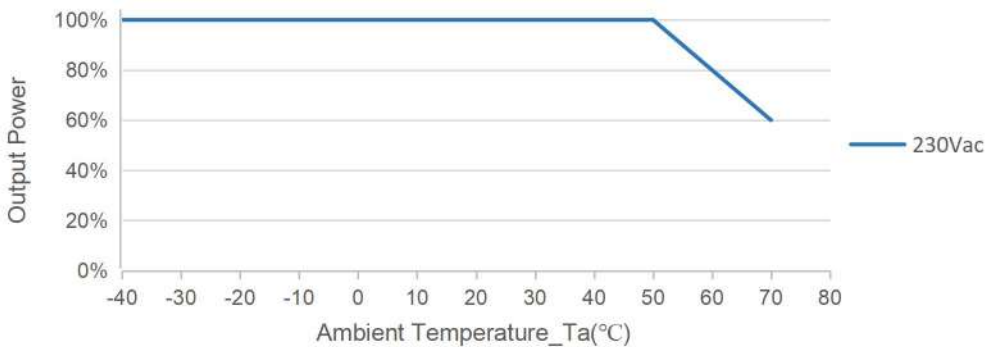

Over Temperature Protection Curve

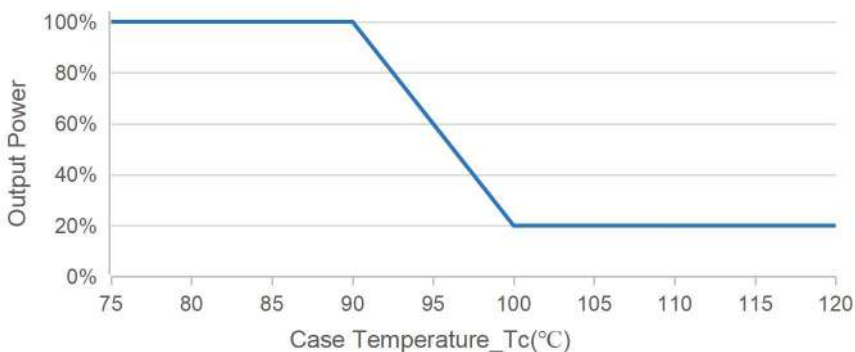

Notes:

Customers can set the start derating temperature and end derating temperature. This curve is the default factory protection curve, When the temperature rises to the normal operating temperature, the drive will resume output.

Lifetime vs. Case Temperature

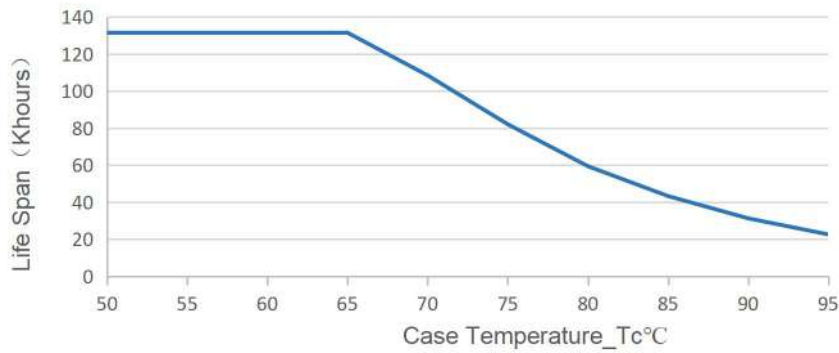

DALI-2 Dimming

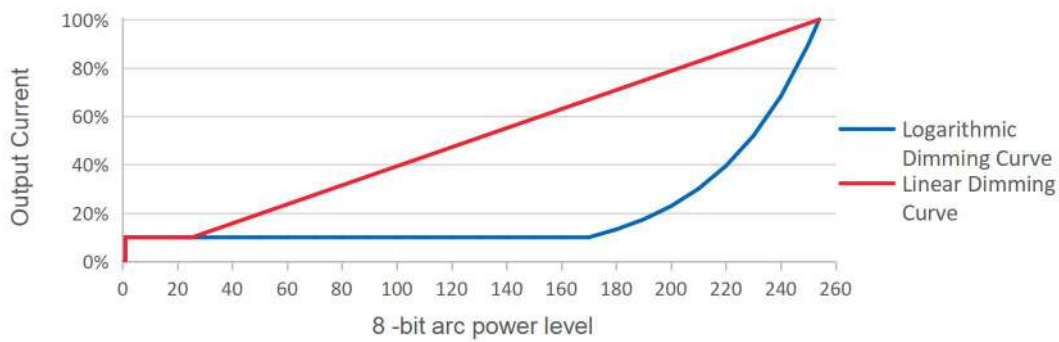

Note: Factory Default Output Logarithmic Curve

Programming Link (DALI-2)

Programming mode 1

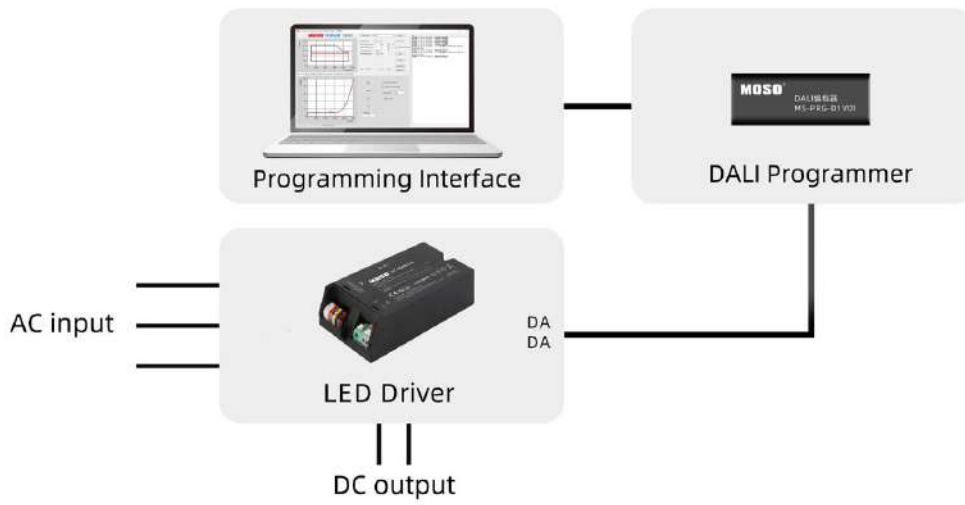

Programming mode 2



Notes:

1. The driver does not need to be powered on during the programming process.
2. Please refer to MS-PRG-D1 or MS-PRG-N1 (Programmer) datasheet for details.
3. Applicable to FEIG programmer: ISC PRH101 and CPR30-USB

Time Dimming

Time-controlled dimming is divided into three modes: Timing dimming, Virtual Midnight dimming, Self-Adaptive dimming.

Timing Dimming

After the driver is powered on, the driver will change in sequence according to the programmed seven periods, and maintain the brightness of timer 7 after running to the last timer.

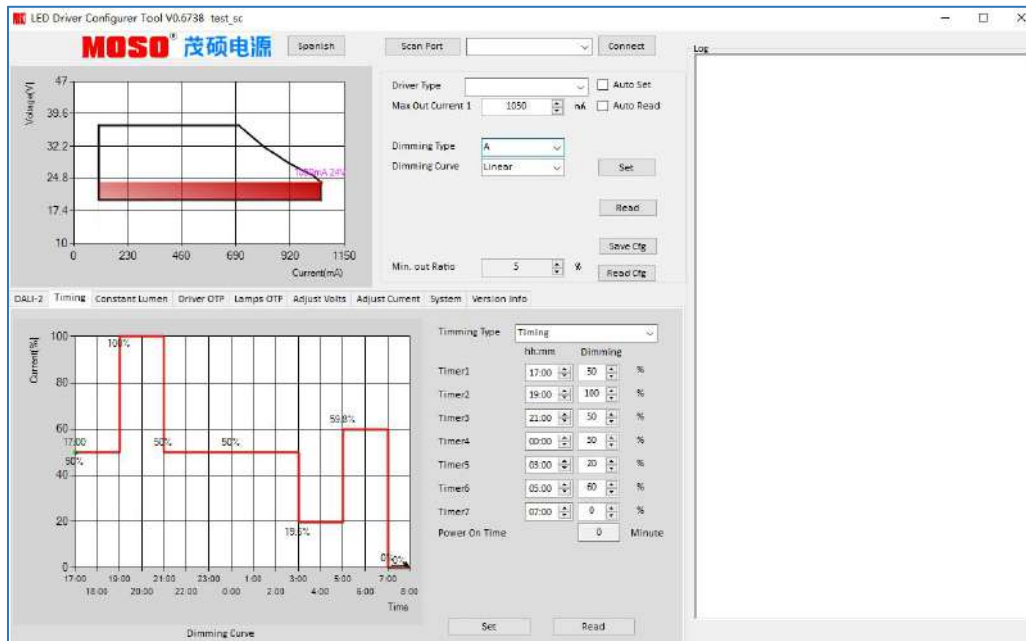

Virtual Midnight Dimming

The power-on point and power-off point usually correspond to sunset time and sunrise time respectively, so their midpoint is the virtual midnight point. The driver will automatically sample the corresponding effective working days according to the reference days set by the customer, and automatically adjust the dimming curve according to the average working hours.

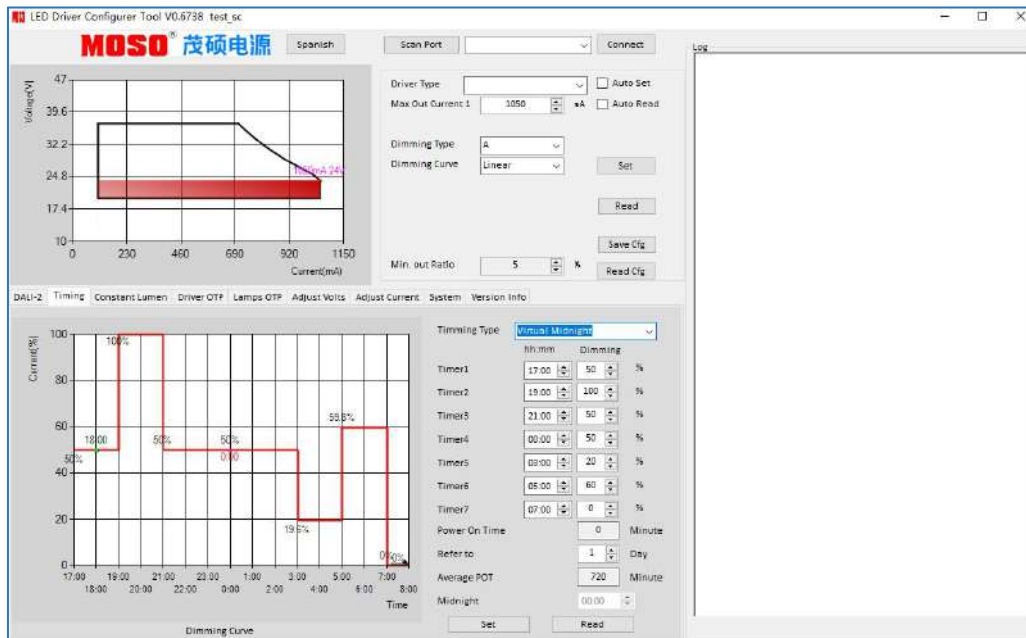

◆ Self - Adaption Dimming

Depending on the customer setup, the drive automatically calculates the effective mean operating time and calculates the ratio to the customer's set parameter time length, automatically making this computational ratio adjustment at each step.

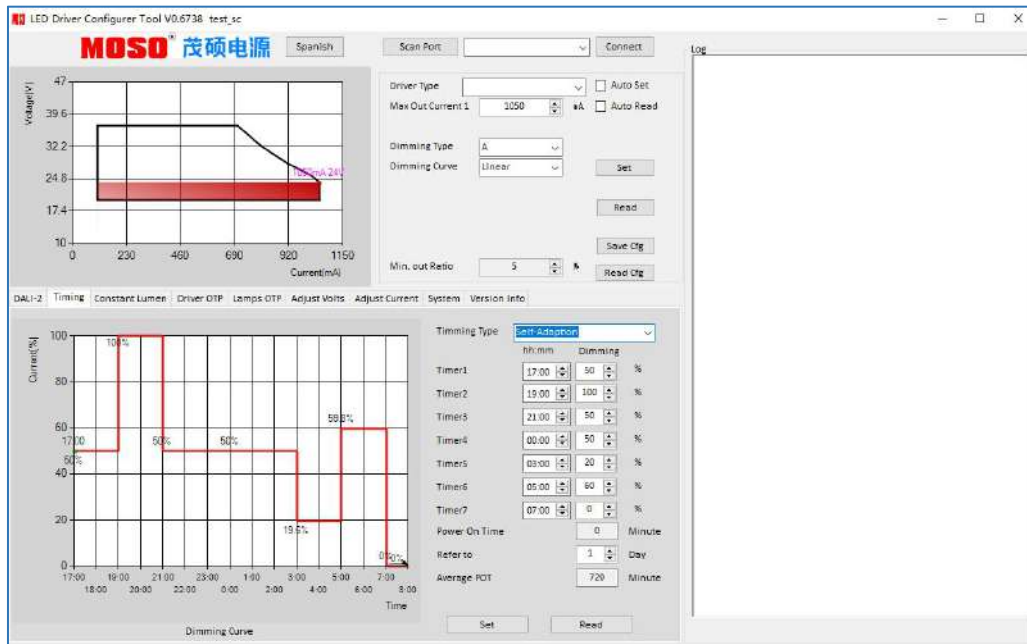

Note: Drives were judged only as valid working days if they were greater than 4 hours and less than 24 hours, and an effective on-off cycle was considered a day

CLO

CLO: With the increase of cumulative illumination time of LED light source, the LED driving can automatically increase its output current, and then realize the increasing of light flux output of LED light source with the increase of cumulative illumination time to achieve the purpose of light decay compensation. Thus the road surface illumination level is basically constant.

Note: Compensated current values are calculated as a percentage based on IMAX. The minute setting column is only used by the customer to test the CLO function. The driver will reset the hour setting column after power failure and power on again. The "ENABLE check box" must be checked to enable the CLO function

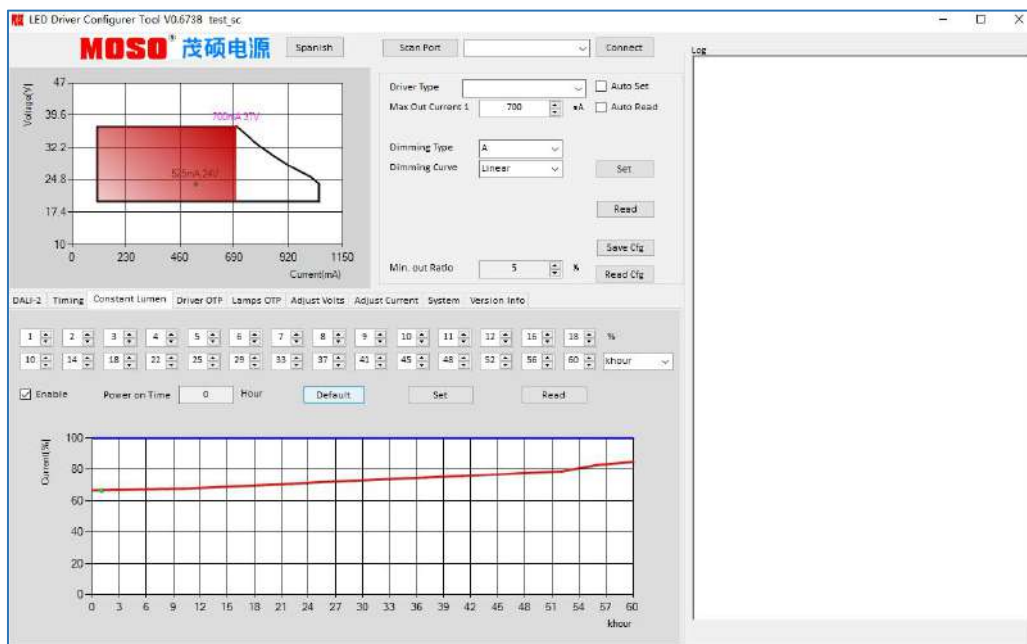

AC Dimming

AC Dimming: The maximum adjustable range of AC DIMMING is 160Vac-250Vac. The specific dimming range can be set by software, and the voltage difference between the starting input voltage and the cut-off input voltage should be guaranteed to be 20Vac. The customer can manually adjust the under voltage protection range and over voltage protection range. There must be a minimum voltage difference of 5V from the initial input voltage before the drive begins to enter AC dimming.

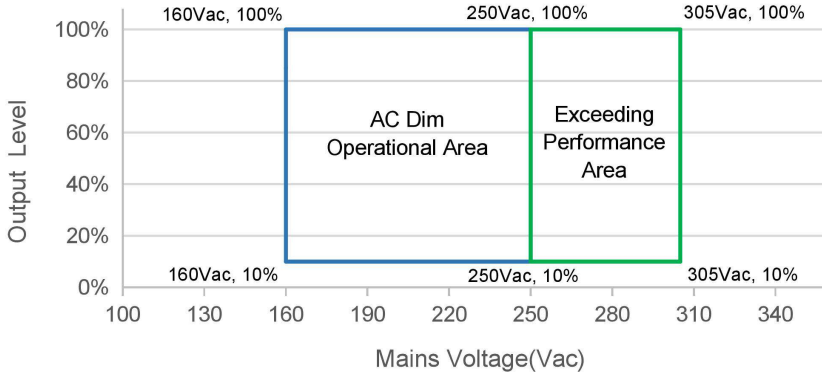

AC Dimming

Arameter	Min	Typ	Max
AC DIMMING (Start input Voltage)	180Vac	-	250Vac
AC DIMMING (Start output Current)	10%	-	100%
AC DIMMING (Cut off input Voltage)	160Vac	-	230Vac
AC DIMMING (Cutoff output Current)	10%	-	100%
AC DIMMING (gap between the starting and cut-off voltages)	20V	-	-
AC DIMMING (Starting and cut-off voltage increments)	-	1V	-
AC DIMMING (Starting and cut-off current increments)	-	1%	-

Luminaire Information

Customer can program the drive through Dali line control programmer (MS-PRG-D1 V01) and use "set button" in Luminaire information function bar for writing information as follows graphic.

According to the provisions of DALI part 253, the driver needs to realize the operation information of lamps Data storage. This information is filled in by the lighting equipment manufacturer.

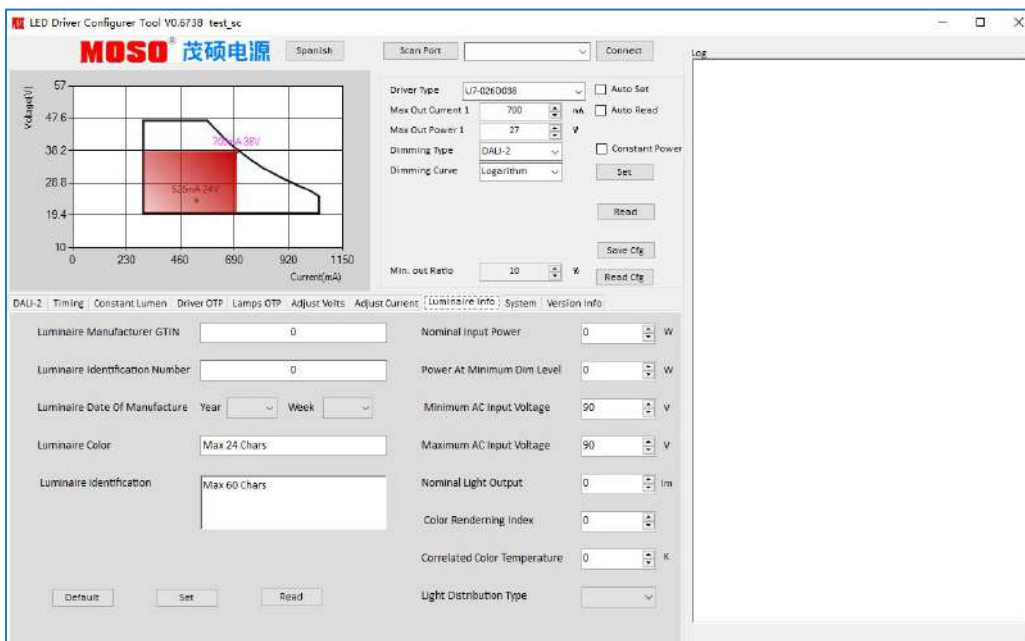

Drive Protection and Luminaire Protection

The one with the faster rate of decrease in preferential current during over- temperature protection. At the end of over-temperature protection, the lower the “OTP out Ratio” current value is set, the higher the priority is.

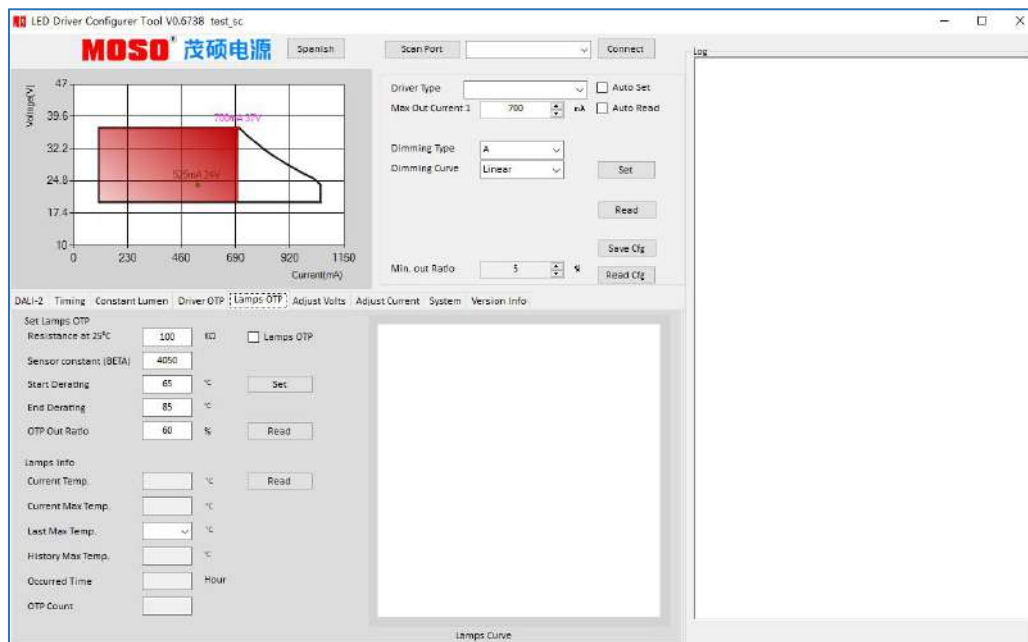
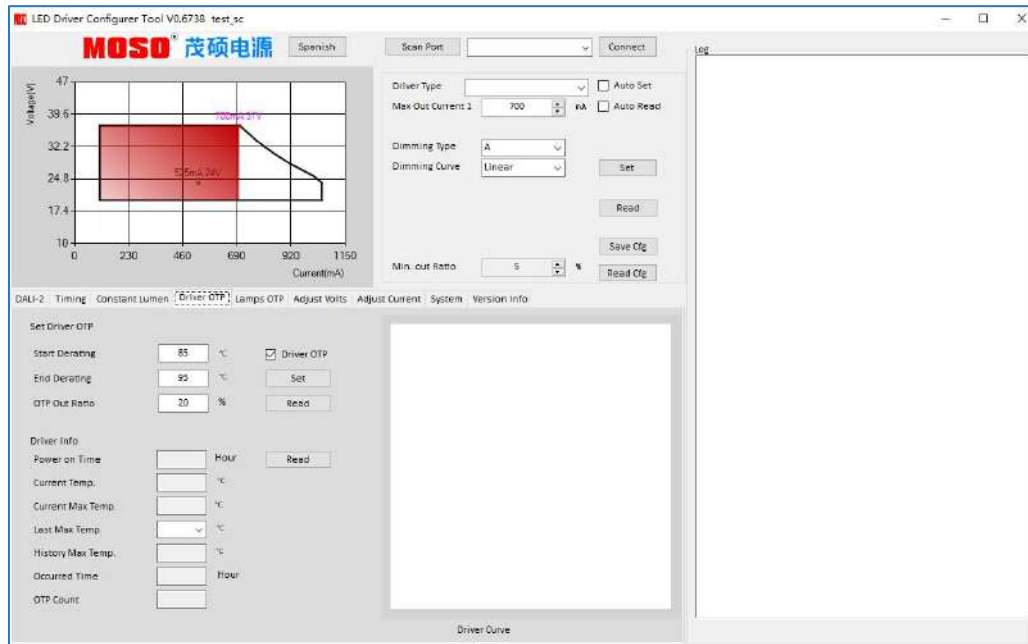

Mechanical Outline

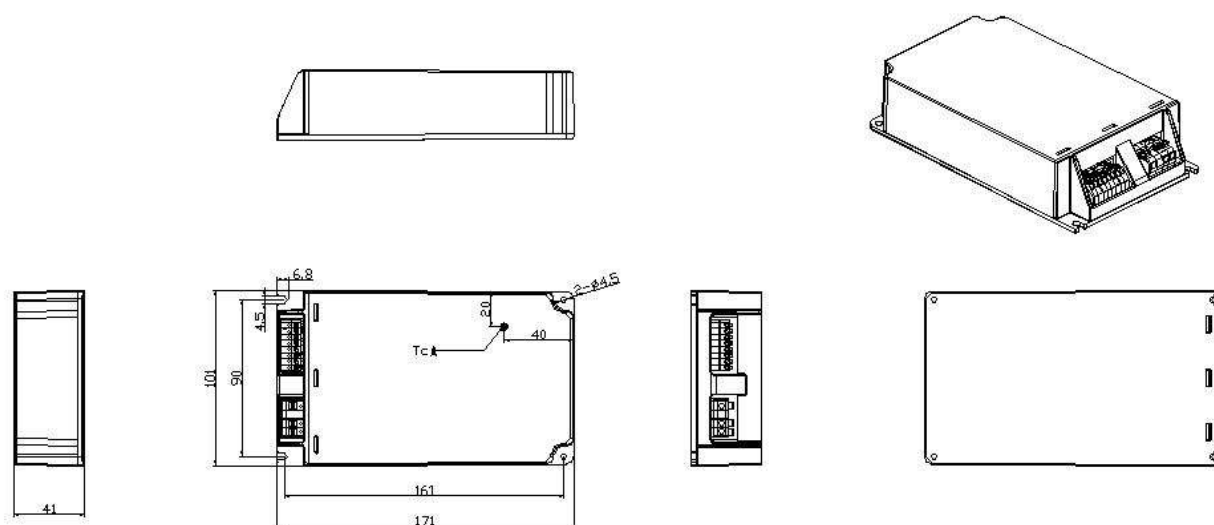

Connections

Input (L,N,G)	Wire Cross-section 0.5 mm ² - 1.5 mm ² /20 AWG - 16 AWG	Push-in at 45°angle, solid and stranded wire	
Output	Wire Cross-section 0.2 mm ² - 1.5 mm ² /22 AWG - 16 AWG	Push-in at 45°angle, solid and stranded wire	
Dimming	Wire Cross-section 0.2 mm ² - 1.5 mm ² /22 AWG - 16 AWG	Push-in at 45°angle, solid and stranded wire	
Specification item	Value	Unit	type
Maximum cable length	1.5	M	
Maximum NTC Output cable length	0.6	M	

Label

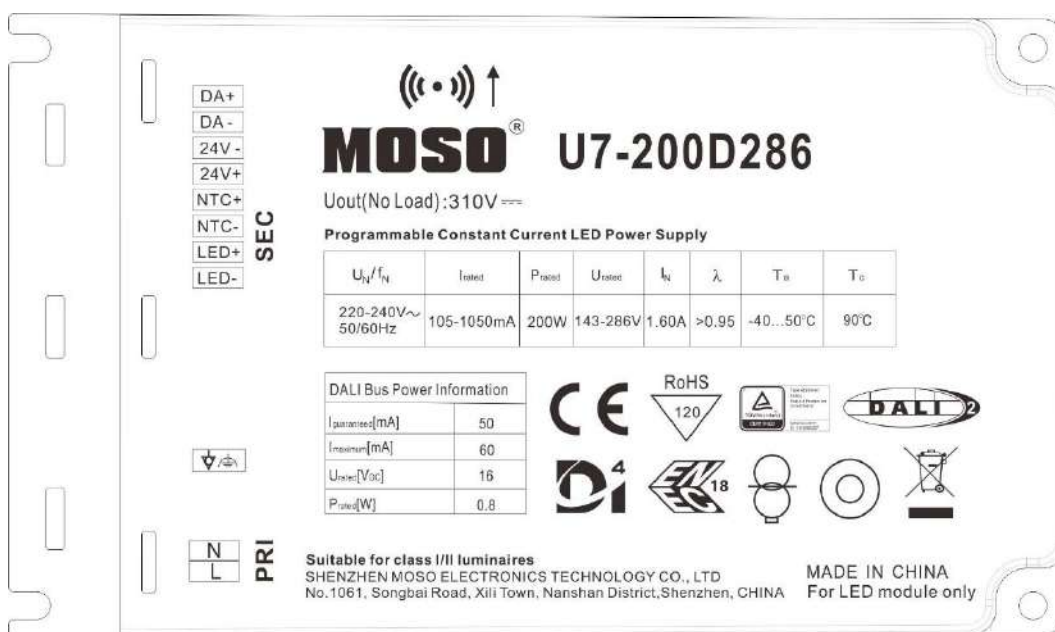

Version

A.2	First release	2023-10-13

Specification for Approval

Product Name: 200W Class I/II Programmable D4i Driver

Product Model: U7-200D286

Rev: A.2

Address: XiLi Songbai Road 1061, Nanshan District, Shenzhen City, Guangdong, China

Tel: 0755-27657000

FAX: 755-27657908

E-mail: info@mosopower.com

Web Site: <http://www.mosopower.com>

Prepared By	Checked By	Approved By

Specification for Approval

Product Name: 200W Class I/II Programmable D4i Driver

Product Model: U7-200D286

Rev: A.2

CUSTOMER AUTHORIZED SIGNATURE		
Tested By	Checked By	Approved By
(Company seal)Return one copy to MOSO with approved signature and company seal.		

Address: XiLi Songbai Road 1061, Nanshan District, Shenzhen City, Guangdong, China

Tel: 0755-27657000

FAX: 755-27657908

E-mail: info@mosopower.com

Web Site: http://www.mosopower.com

Prepared By	Checked By	Approved By