



SCHEREN – SCISSORS

By

Fizza Surgical International





Standard	Blunt/Blunt	Sharp/Blunt	Sharp/Sharp
	Fig. 1	Fig. 2	Fig. 3
105 mm – 4 1/4"	SC02-10-01	SC02-11-01	SC02-12-01
115 mm – 4 1/2"	SC02-10-02	SC02-11-02	SC02-12-02
130 mm – 5"	SC02-10-03	SC02-11-03	SC02-12-03
145 mm – 5 3/4"	SC02-10-04	SC02-11-04	SC02-12-04
155 mm – 6"	SC02-10-05	SC02-11-05	SC02-12-05
165 mm – 6 1/2"	SC02-10-06	SC02-11-06	SC02-12-06
175 mm – 7"	SC02-10-07	SC02-11-07	SC02-12-07
185 mm – 7 1/4"	SC02-10-08	SC02-11-08	SC02-12-08
200 mm – 8"	SC02-10-09	SC02-11-09	SC02-12-09



Standard	Blunt/Blunt	Sharp/Blunt	Sharp/Sharp
	Fig. 1	Fig. 2	Fig. 3
115 mm – 4 1/2"	SC02-15-01	SC02-16-01	SC02-17-01
130 mm – 5"	SC02-15-02	SC02-16-02	SC02-17-02
145 mm – 5 3/4"	SC02-15-03	SC02-16-03	SC02-17-03
155 mm – 6"	SC02-15-04	SC02-16-04	SC02-17-04
165 mm – 6 1/2"	SC02-15-05	SC02-16-05	SC02-17-05
175 mm – 7"	SC02-15-06	SC02-16-06	SC02-17-06
185 mm – 7 1/4"	SC02-15-07	SC02-16-07	SC02-17-07
200 mm – 8"	SC02-15-08	SC02-16-08	SC02-17-08



Graziol	Blunt/Blunt	Sharp/Blunt	Sharp/Sharp
	Fig. 1	Fig. 2	Fig. 3
130 mm – 5"	SC02-20-01	SC02-21-01	SC02-22-01
145 mm – 5 3/4"	SC02-20-02	SC02-21-02	SC02-22-02



Graziol	Blunt/Blunt	Sharp/Blunt	Sharp/Sharp
	Fig. 1	Fig. 2	Fig. 3
130 mm - 5"	SC02-25-01	SC02-26-01	SC02-27-01
145 mm - 5 ³ / ₄ "	SC02-25-02	SC02-26-02	SC02-27-02



Deaver	Sharp/Blunt	Sharp/Blunt	Sharp/Blunt	Sharp/Blunt
145 mm - 5 ³ / ₄ "	SC02-30-01	SC02-31-01	SC02-32-01	SC02-33-01
	<i>straight</i>	<i>curved</i>	<i>straight, Serrated Blade</i>	<i>curved, Serrated Blade</i>

Deaver	Blunt/Blunt	Blunt/Blunt	Blunt/Blunt	Blunt/Blunt
145 mm - 5 ³ / ₄ "	SC02-30-01	SC02-31-01	SC02-32-01	SC02-33-01
	<i>straight</i>	<i>curved</i>	<i>straight, Serrated Blade</i>	<i>curved, Serrated Blade</i>



Lange	Sharp/Blunt	Sharp/Blunt	Sharp/Blunt	Sharp/Blunt
145 mm - 5 ³ / ₄ "	SC02-35-01	SC02-36-01	SC02-37-01	SC02-38-01
	<i>straight</i>	<i>curved</i>	<i>straight, Serrated Blade</i>	<i>curved, Serrated Blade</i>



Mixer

155 mm - 6"	SC02-40-01	SC02-40-02	SC02-41-01	SC02-41-02
	<i>straight</i>	<i>straight, saw edge</i>	<i>curved</i>	<i>curved, Serrated Blade</i>

1:2



Lexer

160 mm - 6 ¹ / ₄ "	SC02-45-01	SC02-46-01
210 mm - 8 ¹ / ₄ "	SC02-45-02	SC02-46-02



Fergusson

140 mm - 5 ¹ / ₂ "	SC02-55-01
160 mm - 6 ¹ / ₄ "	SC02-55-03
180 mm - 7"	SC02-55-03



Richter

140 mm - 5 ¹ / ₂ "	SC02-50-01
--	------------



130 mm - 5"	SC02-60-01
145 mm - 5 ³ / ₄ "	SC02-60-02

1:2



Mayo

145 mm - 5 ³ / ₄ "	SC02-65-01	SC02-66-01
150 mm - 6"	SC02-65-02	SC02-66-02
170 mm - 6 ³ / ₄ "	SC02-65-03	SC02-66-03
230 mm - 9"	SC02-65-04	SC02-66-04
200 mm - 8"	SC02-65-05	SC02-66-05
160 mm - 6 ¹ / ₄ "	SC02-65-06	SC02-66-06
250 mm - 10"	SC02-65-07	SC02-66-07
300 mm - 12"	SC02-65-08	SC02-66-08



Mayo - Stille

150 mm - 6"	SC02-70-01	SC02-71-01
170 mm - 6 ³ / ₄ "	SC02-70-02	SC02-71-02
195 mm - 7 ³ / ₄ "	SC02-70-03	SC02-71-03
210 mm - 8 ³ / ₄ "	SC02-70-04	SC02-71-04

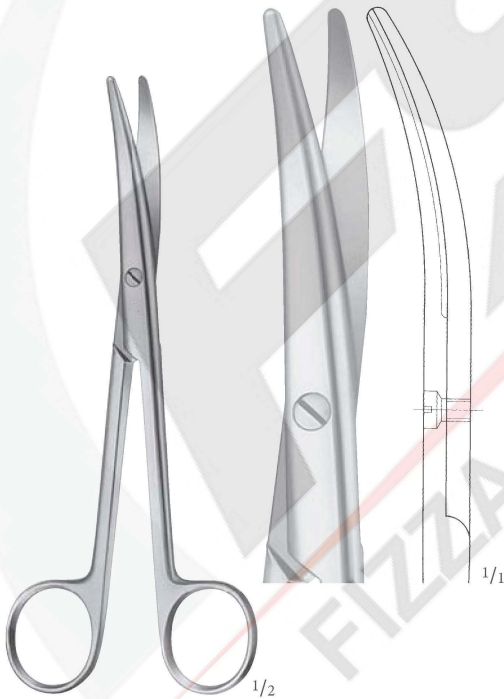

Mayo-Lexer

165 mm, 6 1/2"

SC 02-72-01

Standard-Modell
Standard pattern



Mayo - Harrington

220 mm - 8 ³ / ₄ "	SC02-75-01
--	------------



1:2



1:2

SC02-76-01

Operating scissors – Dissecting scissors



Mayo - Noble

170 mm – 6³/₄"



1:2



1:2

SC 02-80-01

SC 02-81-01

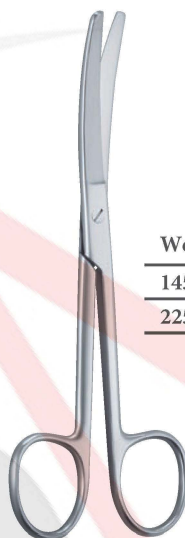

Wertheim

145 mm – 5³/₄"

SC 02-85-01

225 mm – 8³/₄"

SC 02-85-02



1:2



1:2



1:2

Metzenbaum

150 mm – 6"

SC 02-90-01

SC 02-91-01



Metzenbaum



1:2



1:2

	Fig. 1	Fig. 2	Fig. 3
115 mm – 4 ¹ / ₂ "	SC 02-95-01	SC 02-96-01	SC 02-97-01
145 mm – 5 ³ / ₄ "	SC 02-95-02	SC 02-96-02	SC 02-97-02
180 mm – 7"	SC 02-95-03	SC 02-96-03	SC 02-97-03
200 mm – 8"	SC 02-95-04	SC 02-96-04	SC 02-97-04
230 mm – 9"	SC 02-95-05	SC 02-96-05	SC 02-97-05
250 mm – 10"	SC 02-95-06	SC 02-96-06	SC 02-97-06
280 mm – 11"	SC 02-95-07	SC 02-96-07	SC 02-97-07
300 mm – 12"	SC 02-95-08	SC 02-96-08	SC 02-97-08

Operating scissors – Dissecting scissors



Metzenbaum



	Fig. 1	Fig. 2	Fig. 3
115 mm – 4 1/2"	SC 02-100-01	SC 02-101-01	SC 02-102-01
145 mm – 5 3/4"	SC 02-100-02	SC 02-101-02	SC 02-102-02
180 mm – 7"	SC 02-100-03	SC 02-101-03	SC 02-102-03
200 mm – 8"	SC 02-100-04	SC 02-101-04	SC 02-102-04
230 mm – 9"	SC 02-100-05	SC 02-101-05	SC 02-102-05
250 mm – 10"	SC 02-100-06	SC 02-101-06	SC 02-102-06
280 mm – 11"	SC 02-100-07	SC 02-101-07	SC 02-102-07
300 mm – 12"	SC 02-100-08	SC 02-101-08	SC 02-102-08



Metzenbaum-Nelson



	Fig. 1	Fig. 2	Fig. 3
180 mm – 7"	SC 02-105-01	SC 02-106-01	SC 02-107-01
200 mm – 8"	SC 02-105-02	SC 02-106-02	SC 02-107-02
230 mm – 9"	SC 02-105-03	SC 02-106-03	SC 02-107-03
250 mm – 9 3/4"	SC 02-105-04	SC 02-106-04	SC 02-107-04
280 mm – 11"	SC 02-105-05	SC 02-106-05	SC 02-107-05
300 mm – 12"	SC 02-105-06	SC 02-106-06	SC 02-107-06



Metzenbaum-Nelson







	Fig. 1	Fig. 2	Fig. 3
180 mm – 7"	SC 02-110-01	SC 02-111-01	SC 02-112-01
200 mm – 8"	SC 02-110-02	SC 02-111-02	SC 02-112-02
230 mm – 9"	SC 02-110-03	SC 02-111-03	SC 02-112-03
250 mm – 9 3/4"	SC 02-110-04	SC 02-111-04	SC 02-112-04
280 mm – 11"	SC 02-110-05	SC 02-111-05	SC 02-112-05
300 mm – 12"	SC 02-110-06	SC 02-111-06	SC 02-112-06

Chirurgische Scheren – Präparierscheren
Operating scissors – Dissecting scissors



Metzenbaum-Fino

	 1:2	 1:2	 1:2	 1:2
	Fig. 1	Fig. 3	Fig. 1	Fig. 3
145 mm – 5 ³ / ₄ "	SC 02-115-01	SC 02-116-01	SC 02-117-01	SC 02-118-01



FOMON

135 mm – 5¹/₄"
SC 02-125-01



Metzenbaum-Fino

180 mm – 7"	SC 02-120-01	SC 02-121-01	SC 02-122-01
220 mm – 8"	SC 02-120-02	SC 02-121-02	SC 02-122-02
230 mm – 9"	SC 02-120-03	SC 02-121-03	SC 02-122-03

S-förmig gebogen
S-curved



Thorek

190 mm – 7¹/₂"
SC 02-130-01

Gynaecological scissors

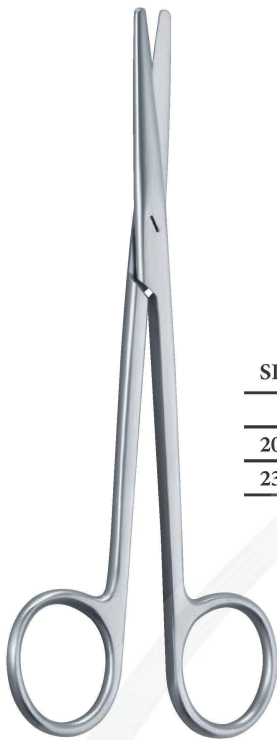

SIMS

	Fig. 1	Fig. 2	Fig. 1	Fig. 2
200 mm – 8"	SC 02-135-01	SC 02-136-01	SC 02-137-01	SC 02-138-01
230 mm – 9"	SC 02-135-02	SC 02-136-02	SC 02-137-02	SC 02-138-02



DUBOIS

270 mm – 10 ³ / ₄ "	SC 02-140-01
---	--------------



DOYEN

175 mm – 7"	SC 02-145-01	SC 02-146-01
-------------	--------------	--------------



SIEBOLD

240 mm – 9¹/₂"

SC 02-150-01

S-CURVED

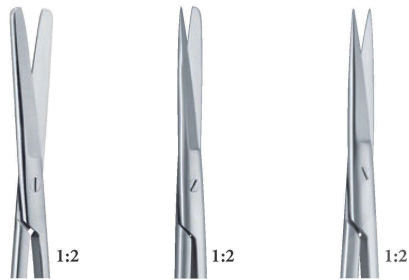

	Fig. 1	Fig. 2	Fig. 3
120 mm – 4 ³ / ₄ "	SC 02-155-01	SC 02-156-01	SC 02-157-01

**Brophy
(Sullivan)**



145 mm – 5 ³ / ₄ "	SC 02-175-01
--	--------------



	Fig. 1	Fig. 2	Fig. 3
120 mm – 4 ³ / ₄ "	SC 02-160-01	SC 02-161-01	SC 02-162-01



SC 02-176-01



Knapp



105 mm – 4 ¹ / ₄ "	SC 02-165-01	SC 02-166-01
--	--------------	--------------

blunt

Littler



115 mm – 4 ¹ / ₂ "	SC 02-180-01
145 mm – 5 ³ / ₄ "	SC 02-180-02



Wagner



120 mm – 4 ³ / ₄ "	SC 02-170-01	SC 02-170-02	SC 02-171-01	SC 02-171-02
--	--------------	--------------	--------------	--------------

straight

straight, Serrated Blade curved

curved, Serrated Blade

Fine scissors



Locklin

165 mm – 6 1/2"

SC 02-185-01



SC 02-186-01



Quinby

125 mm – 5"

SC 02-190-01

Serrated Blade,

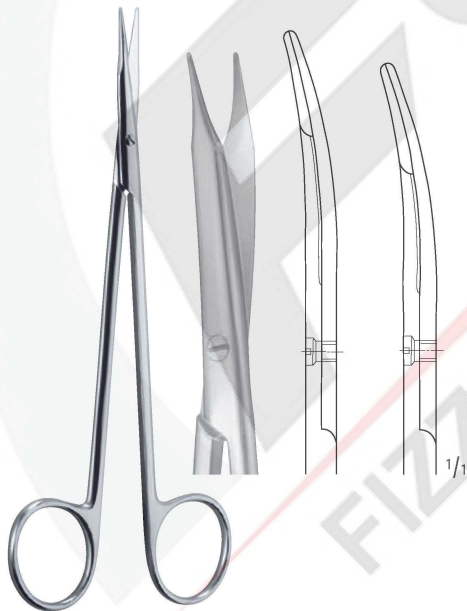

Reynolds Jameson

160 mm – 6 1/4"

SC 02-195-01

180 mm – 7"

SC 02-195-02

145 mm – 5 3/4"

SC 02-195-03

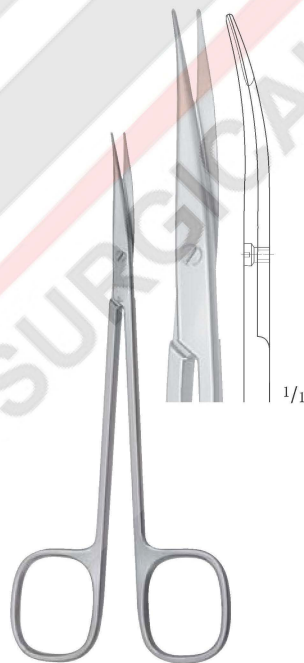

Reynolds-Jameson

140 mm, 5 1/2"

SC 02-196-01

Gefäß-Schere

Vascular scissors



Neumann

120 mm – 4 3/4"

SC 02-200-01

S-curved

Fine scissors

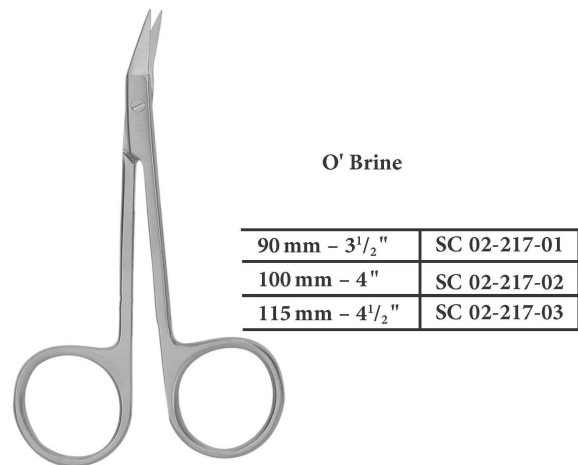
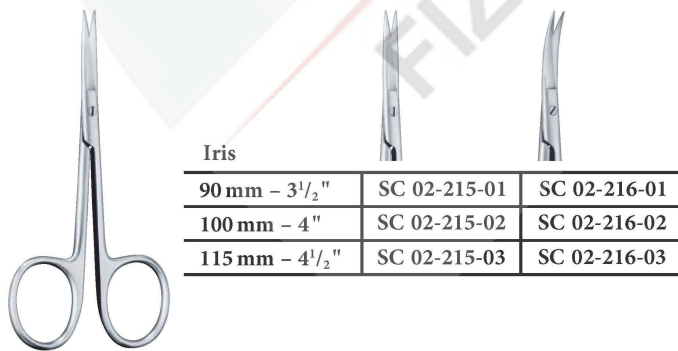
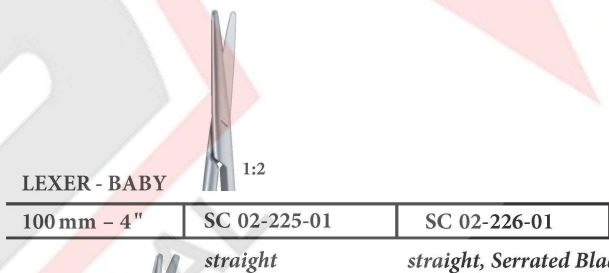
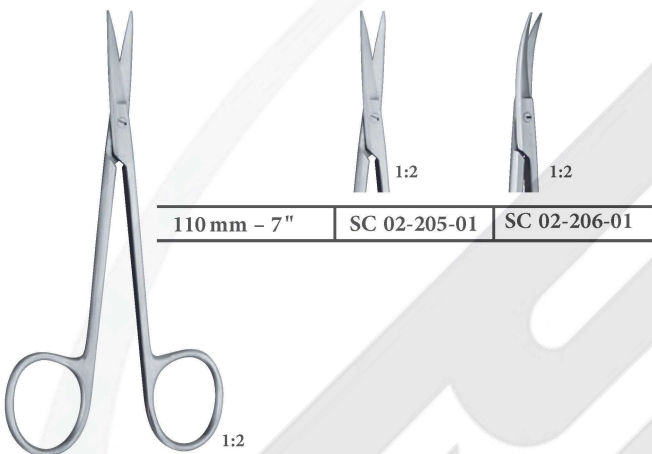
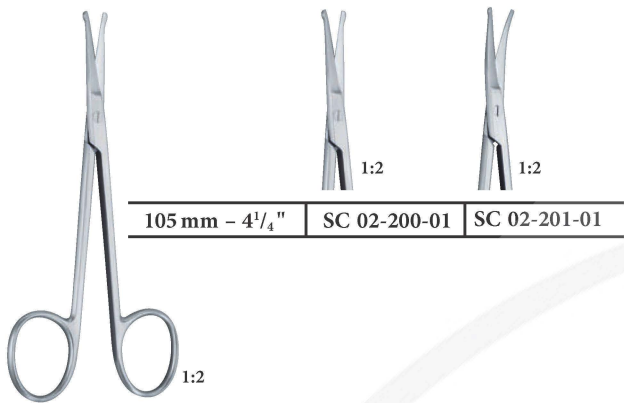

Fistula scissors

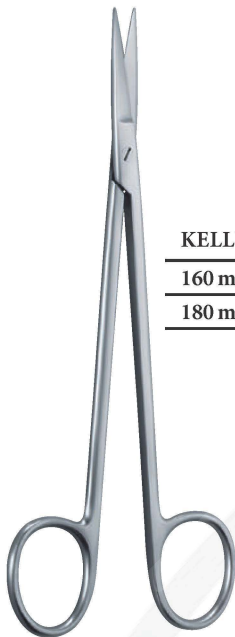

KELLY

160 mm - 6 ¹ / ₄ "	SC 02-235-01	SC 02-236-01
180 mm - 7"	SC 02-235-02	SC 02-236-02



Enukleationsscheren Enucleation scissors



LANDOLT

125 mm - 5"	SC 02-240-01	SC 02-241-01
-------------	--------------	--------------

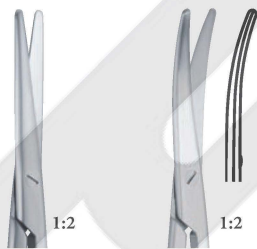

CHADWICK

110 mm - 4 ¹ / ₄ "	SC 02-245-01
--	--------------

110 mm - 4 ¹ / ₄ "	SC 02-250-01
--	--------------

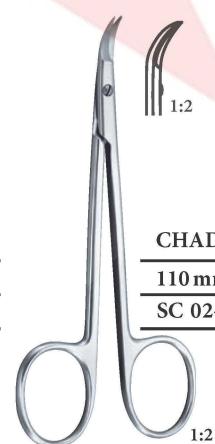

JOSEPH

140 mm - 5 ¹ / ₂ "	SC 02-255-01	SC 02-256-01
--	--------------	--------------



KILNER (Ragnell)

120 mm - 4 ³ / ₄ "	SC 02-260-01
150 mm - 6"	SC 02-260-02



Plastic surgery scissors

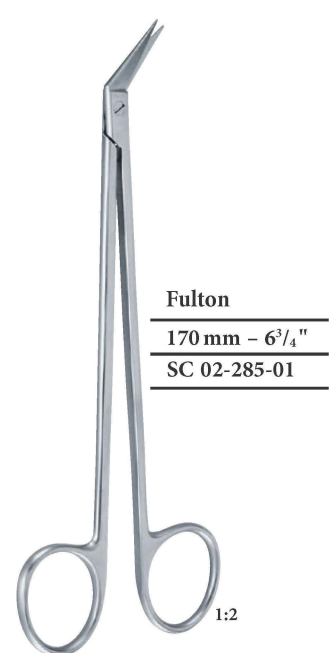
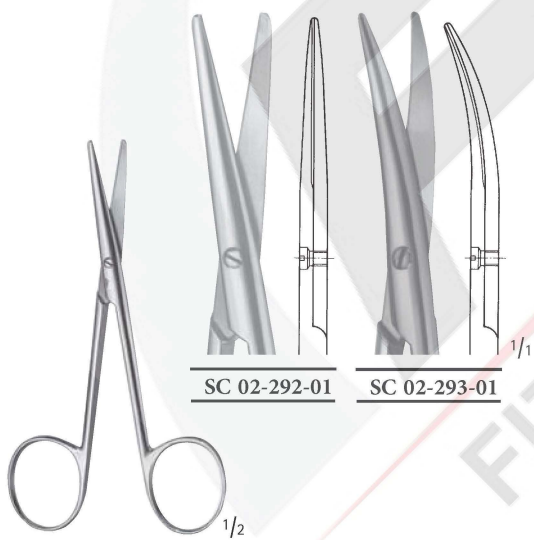
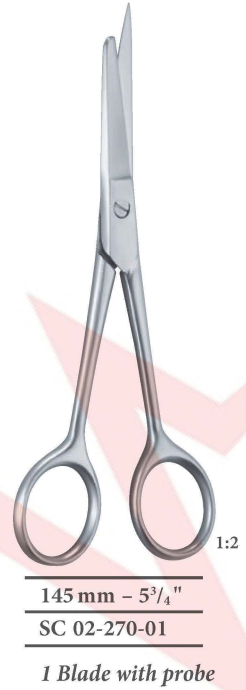
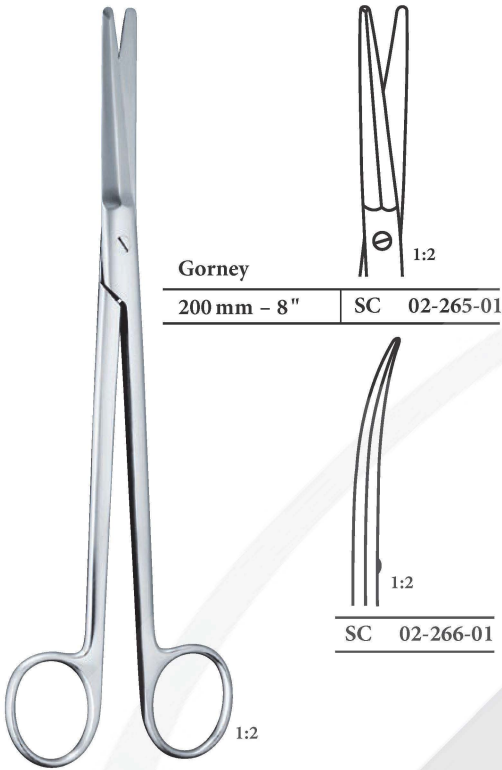

Cottle-Knapp
105 mm, 4 1/8"
Scheren für die plastische Chirurgie
Scissors for plastic surgery

COTTLE
115 mm, 4 1/2"
SC 02-294-01
Bulldog-Schere
Bulldog scissors

Artery scissors



**Potts - Smith
(de Martel)**
195 mm – 7³/₄"
SC 02-290-01

1:2

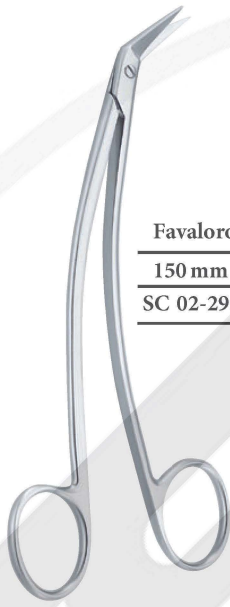

Favaloro
150 mm – 6"
SC 02-295-01

1:2



De Bakely
155 mm – 6" | SC 02-300-01 | SC 02-301-01

Offset scissors, s-shaped

1:2

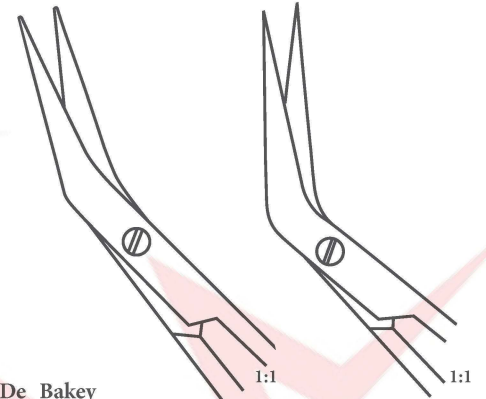

1:1

1:1



De Bakely

160 mm – 6 ¹ / ₄ "	SC 02-305-01	SC 02-306-01	SC 02-307-01
230 mm – 9"	SC 02-305-02	SC 02-306-02	SC 02-307-02
280 mm – 11"	SC 02-305-03	SC 02-306-03	SC 02-307-03

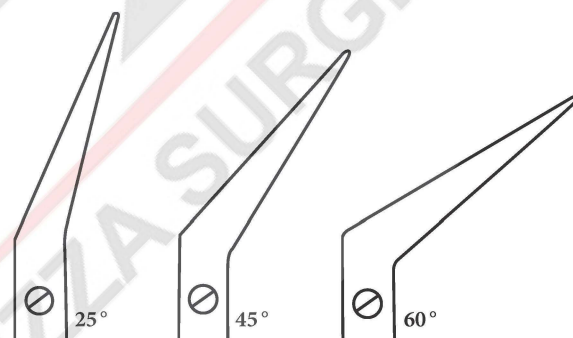

25°

45°

60°



Mills
225 mm – 8³/₄"
SC 02-310-01

1:2

Artery scissors

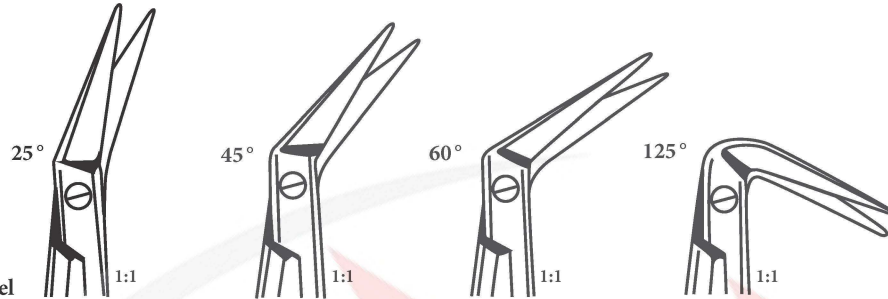
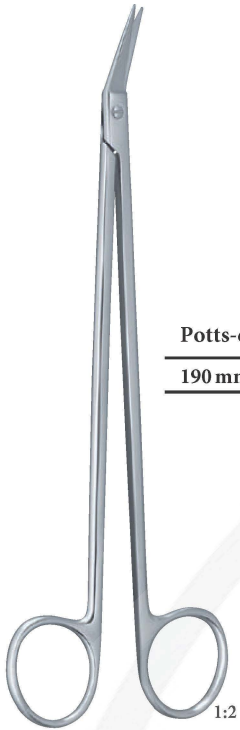

Potts-de Martel

190 mm - 7 1/2"	SC 02-315-01	SC 02-315-02	SC 02-315-03	SC 02-315-04
-----------------	--------------	--------------	--------------	--------------

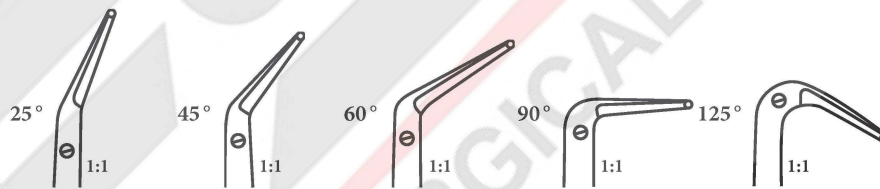

180 mm - 7"	SC 02-320-01	SC 02-320-02	SC 02-320-03	SC 02-320-04	SC 02-320-05
-------------	--------------	--------------	--------------	--------------	--------------

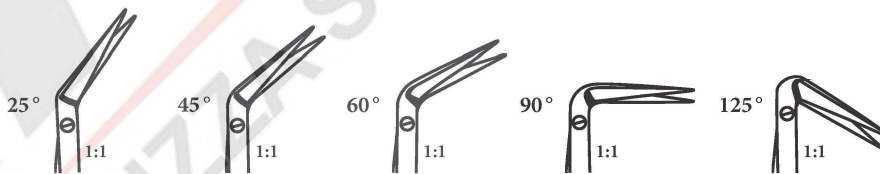

SC 02-320-07	SC 02-320-08	SC 02-320-09	SC 02-320-10	SC 02-320-11
--------------	--------------	--------------	--------------	--------------

Artery scissors

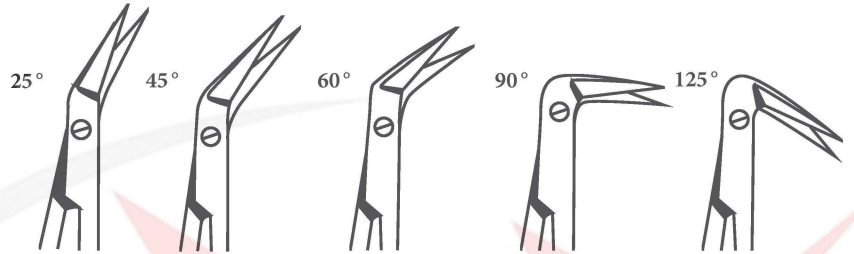

Diethrich - Hegemann

145 mm - 5 ³ / ₄ "	SC 02-325-01	SC 02-326-01	SC 02-327-01	SC 02-328-01	SC 02-329-01
160 mm - 6 ¹ / ₄ "	SC 02-325-02	SC 02-326-02	SC 02-327-02	SC 02-328-02	SC 02-329-02
190 mm - 7 ¹ / ₂ "	SC 02-325-03	SC 02-326-03	SC 02-327-03	SC 02-328-03	SC 02-329-03



Martin - Cartilage
190 mm - 7¹/₂" | SC 02-330-01
curved, Serrated Blade



Mc Indoe
190 mm - 7¹/₂" | SC 02-335-01

Cartilage scissors



Potts - Smith

190 mm - 7½"	SC 02-340-01
--------------	--------------



Prince

175 mm - 7"	SC 02-350-01
-------------	--------------



Toennis

180 mm - 7"



SC 02-360-01



SC 02-361-01



Boettcher

180 mm - 7"	SC 02-345-01
-------------	--------------



Toennis - Adson

170 mm - 6¾"	SC 02-355-01
--------------	--------------



Dean

170 cm - 6¾"

SC 02-365-01

curved

SC 02-366-01

curved, Serrated Blade

Tonsil scissors



Wertheim	
190 mm – 7½"	SC 02-370-01

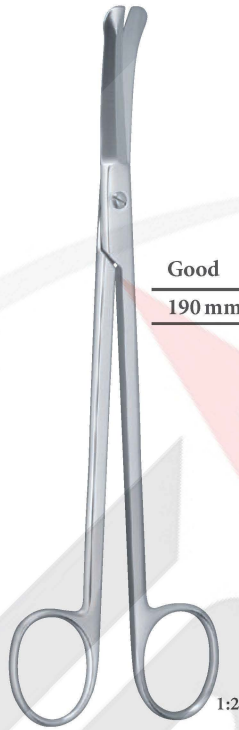

Good	
190 mm – 7½"	SC 02-380-01



Crafoord	
300 mm – 12"	SC 02-385-01



Olivecrona	
230 mm – 9"	SC 02-375-01

Trigeminal scissors

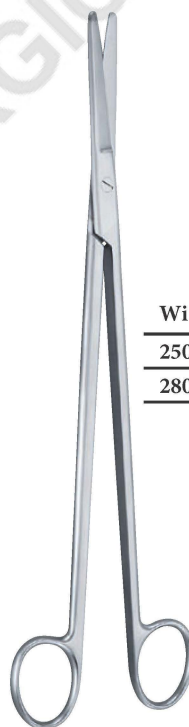
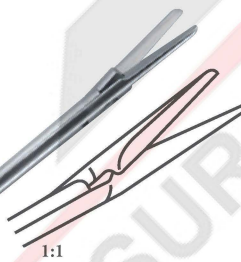

Willauer		
250 mm – 9¾"	SC 02-390-01	SC 02-391-01
280 mm – 11"	SC 02-390-02	SC 02-392-02

straight

curved

Lobectomy scissors



Finochietto
270 mm – 10³/₄" | SC 02-400-01

1:3



Resano
250 mm – 10" | SC 02-405-01

1:3



Satinsky
245 mm – 9³/₄" | SC 02-406-01

1:2

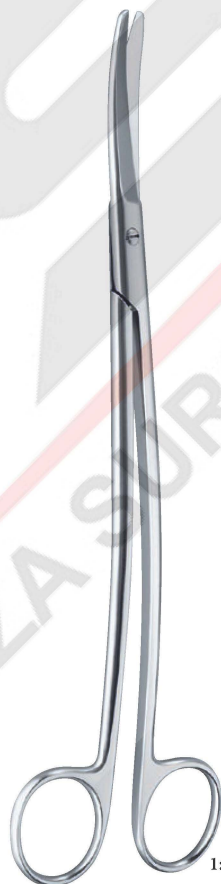

Klinkenberg - Loth
230 mm – 9" | SC 02-410-01

1:2



Jorgenson
220 mm – 8³/₄" | SC 02-411-01

1:2

Darmscheren *Enterotomy scissors*

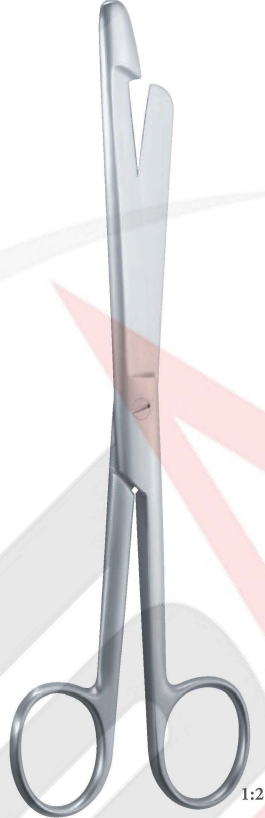

	Fig. 1	Fig. 2	Fig. 3
210 mm – 8 1/4"	SC 02-415-01	SC 02-420-01	SC 02-425-01

Umbilical scissors



Busch

130 mm – 5"	SC 02-426-01	SC 02-427-01
160 mm – 6 1/4"	SC 02-426-02	SC 02-427-02

Schumacher

160 mm – 6 1/4"	SC 02-430-01
------------------------	---------------------

Mod. USA

105 mm – 4 1/4"	SC 02-435-01
------------------------	---------------------

Serrated Blade

Episiotomy scissors

Parametrium scissors



Braun - Stadler

145 mm - 5³/₄"

SC 02-440-01

220 mm - 8³/₄"

SC 02-440-02

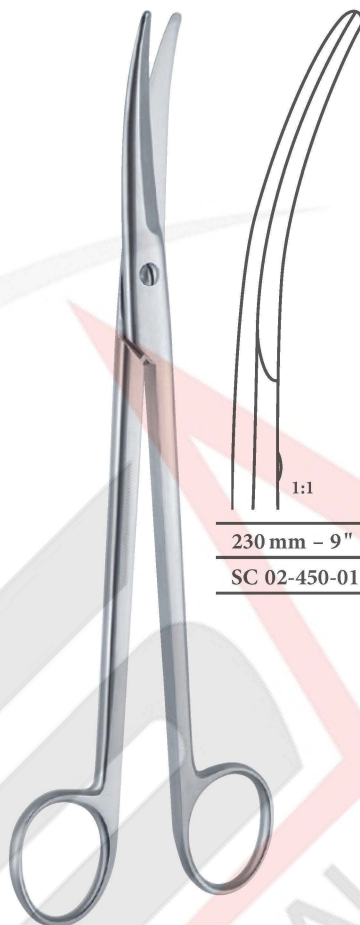

1:1

1:1

230 mm - 9"

225 mm - 8³/₄"

SC 02-450-01

SC 02-451-01



1:2

Waldmann

180 mm - 7"

SC 02-445-01

Nasal scissors



Sailer

170 mm - 6 ³ / ₄ "	SC 02-455-01
--	--------------

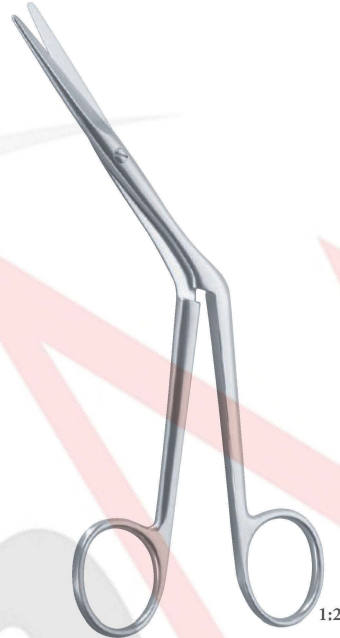

Heymann

180 mm - 7"	SC 02-460-01
-------------	--------------



Fomon

130 mm - 5"	SC 02-465-01
-------------	--------------



Cottle

160 mm - 6 ¹ / ₄ "	SC 02-470-01
--	--------------

Operating scissors – Dissecting scissors

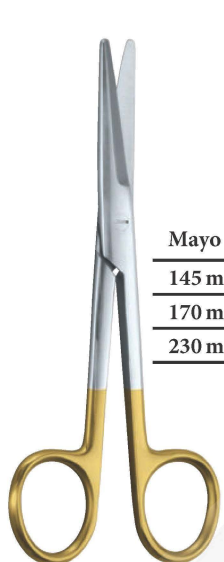

Mayo

145 mm – 5 ³ / ₄ "	SC 02-805-01	SC 02-806-01
170 mm – 6 ³ / ₄ "	SC 02-805-02	SC 02-806-02
230 mm – 9"	SC 02-805-03	SC 02-806-03



Mayo - Stille

150 mm – 6"	SC 02-810-01	SC 02-811-01
170 mm – 6 ³ / ₄ "	SC 02-810-02	SC 02-811-02



Metzenbaum

	Fig. 1	Fig. 2	Fig. 3
115 mm – 4 ¹ / ₂ "	SC 02-815-01	SC 02-816-01	SC 02-817-01
145 mm – 5 ³ / ₄ "	SC 02-815-02	SC 02-816-02	SC 02-817-02
180 mm – 7"	SC 02-815-03	SC 02-816-03	SC 02-817-03
200 mm – 8"	SC 02-815-04	SC 02-816-04	SC 02-817-04
230 mm – 9"	SC 02-815-05	SC 02-816-05	SC 02-817-05
250 mm – 10"	SC 02-815-06	SC 02-816-06	SC 02-817-06
280 mm – 11"	SC 02-815-07	SC 02-816-07	SC 02-817-07
300 mm – 12"	SC 02-815-08	SC 02-816-08	SC 02-817-08



Metzenbaum

	Fig. 1	Fig. 2	Fig. 3
115 mm – 4 ¹ / ₂ "	SC 02-827-01	SC 02-828-01	SC 02-829-01
145 mm – 5 ³ / ₄ "	SC 02-827-02	SC 02-828-02	SC 02-829-02
180 mm – 7"	SC 02-827-03	SC 02-828-03	SC 02-829-03
200 mm – 8"	SC 02-827-04	SC 02-828-04	SC 02-829-04
230 mm – 9"	SC 02-827-05	SC 02-828-05	SC 02-829-05
250 mm – 10"	SC 02-827-06	SC 02-828-06	SC 02-829-06
280 mm – 11"	SC 02-827-07	SC 02-828-07	SC 02-829-07
300 mm – 12"	SC 02-827-08	SC 02-828-08	SC 02-829-08



Artery scissors

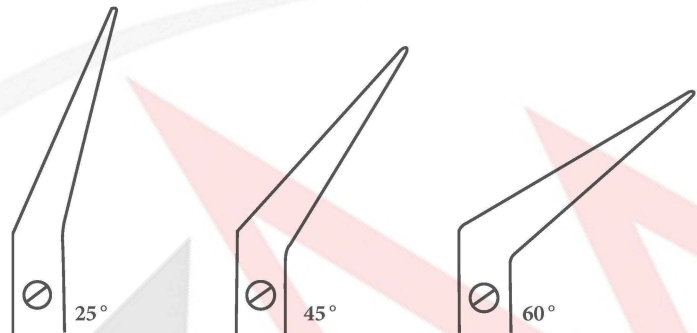

De Bakey			
160 mm – 6 1/4"	SC 02-875-01	SC 02-876-02	SC 02-877-03
230 mm – 9"	SC 02-875-02	SC 02-876-02	SC 02-877-02
280 mm – 11"	SC 02-875-03	SC 02-876-03	SC 02-877-03

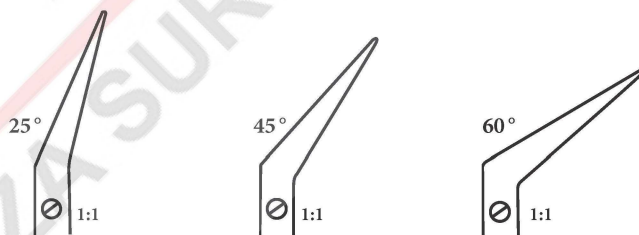

Potts - de Martel			
190 mm – 7 1/2"	SC 02-880-01	SC 02-881-01	SC 02-882-01