



Zeyrek Konteyner

ENGLISH CATALOG





Zeyrek
Konteyner



ABOUT US

We are Zeyrek Konteyner company from İstanbul, Turkey. And For many years, Zeyrek Konteyner has been serving in the manufacturing of high-quality garbage bins, metal garbage containers, trash cans made of stainless steel, metal with electrostatic oven painting, and plastics. with the motto of a clean and green environment. This long marathon started in 1985 and continues today with our expert staff. Since its establishment, it has been devotedly serving with important designs and projects. We carry out our production with new technology machines and experienced technical staff.

Our goal since our establishment is to manufacture the best quality products. Our products are offered to local governments, official institutions, and mass housing areas. And all of our products are under warranty of 1 year. Our company, which has been serving throughout the country, has grown more every day and has proven itself in this sector by gaining an important place in its field. It should be emphasized that Zeyrek Konteyner company continues to grow by taking firm steps towards the future with its experienced, and knowledgeable staff and offering our customers the best quality products by increasing their varieties.

If you require any type of garbage container. Recycling bins and Ashtrays are made of metal, plastic, and stainless steel. Please see our catalogs in the email attachment or our E-catalog links listed below for more products. And please reply to me with your preferred product number and quantity so that we can provide you with the quotation and your required information.





1100 Liter Metal Waste Container Flat Lid

- Volume: 1100 L
- Dimensions: 930 x 1200 x 1390 mm
- Weight: 94 KG (+/-5%)
- Body sheet thickness is 1,50 mm.
- The cover sheet is made of a 1,20 mm sheet, considering it's lightweight.
- Lifting arms are suitable for garbage truck lifting systems.
- Container lifting arms are made of 32 inch.
- Material: Galvanized Steel
- Wheels: 4 rubber 200*50 in size.
- Temperature resistant: 30°C to +80°C
- 4 of the wheels rotate 360 degrees and 2 of them has a brake
- Wheel connection sheet is 4 mm.
- Our containers are welded with slag-free gas metal arc welding.
- All of our products used in our containers are of first quality and TSE certified

660 L and 770 L options are available.

Production can be made according to the desired sheet thickness.



1 TRUCK: 132 pieces



1x40HQ: 118 pieces

 **Zeyrek**
Konteyner





1100 Liter Metal Waste Container Dome Lid

- Volume: 1100 L-Dimensions: 890 x 1350 x 1440 mm
- Weight: 94 KG (+/-5%)
- Body sheet thickness is 1,50 mm.
- The cover sheet is made of a 1,20 mm sheet, considering it's lightweight.
- Lifting arms are suitable for garbage truck lifting systems.
- Cover movement is coil spring.
- There is 1 stop mechanism on the lid. There is lastic profile on the lid mouth.
- Material: Galvanized Steel
- Wheels: 4 rubber 200*50 in size.
- Temperature resistant: 30°C to +80°C
- 4 of the wheels rotate 360 degrees and 2 of them has a brake.
- Wheel connection sheet is 4 mm.
- Our containers are welded with slag-free gas metal arc welding.
- All 1100 containers are fully produced under the EN840 compliant, to ensure the waste bin is compatible with customers requirements, such as trunnion and comb bar lifting devices.



1 TRUCK: 100 pieces



1x40HQ: 90 pieces

Production can be made according to the desired sheet thickness.



ОБЩИНА

ОБЩИНА

ОБЩИНА

ОБЩИНА

ОБЩИНА

ОБЩИНА





1100 Liter Metal Waste Container Plastic Lid

- Volume: 1100 L
- Dimensions: 950 x 1200 x 1390 mm
- Weight: 94 KG (+/-5%)
- Body sheet thickness is 1,50 mm.
- Lid is plastic lid. (Green or other color)
- Lifting arms are suitable for garbage truck lifting systems.
- Container lifting arms are made of 32 inch.
- Material: Galvanized Steel
- Wheels: 4 rubber 200*50 in size.
- Temperature resistant: 30°C to +80°C
- 4 of the wheels rotate 360 degrees and 2 of them has a brake.
- Wheel connection sheet is 4 mm.
- Our containers are welded with slag-free gas metal arc welding.
- All of our products used in our containers are of first quality and TSE certified

660 L and 770 L options are available.

Production can be made according to the desired sheet thickness.



1 TRUCK: 132 pieces



1x40HQ: 108 pieces



MUSHROOM ATTACHMENT



KINSOFFER ATTACHMENT



HOOK ATTACHMENT



THE 2500-3000-3750 LITER ABOVE GROUND WASTE CONTAINER SYSTEM

“WE LOVE OUR WORLD, WE PRODUCE FOR OUR ENVIRONMENT”

1100x1600x1690 - 1450x1600x1690 - 1750x1600x1600

Our above-ground container systems are robust and durable which manufactured in European Standards to be used for all known garbage systems.(domestic waste, paper, plastic, glass)

The above-ground container system has been made in such a way that it can be emptied by opening the bottom covers of the garbage truck by lifting the container from the head mechanism with the on-board crane directed by the driver with the help of the remote control, by getting out of the vehicle or without getting out of the vehicle.

The Container bottom covers are designed and manufactured to prevent liquid waste from leaking out. The Aboveground Containers allow for sticker coating or in desired color tones (Ral color) compatible with the advertisement area or the environment.





THE 2200 LITER UNDERGROUND WASTE CONTAINER SYSTEM WITH HYDRAULIC JACK

“WE LOVE OUR WORLD, WE PRODUCE FOR OUR ENVIRONMENT”

2540x2000x2770

The hydraulic jack underground waste container system allows municipalities to use existing garbage collection vehicles and also allows for garbage to be disposed of underground. It provides an environmentally friendly aesthetic, modern city furniture look, and comfortable use. Only the garbage disposal chute is visible above ground, while the main containers are underground. The system is connected to the compactor garbage truck using a jack hose and has two 1100 Lt. inner containers which can be emptied using an elevator platform. The upper walking platform is made of tear-patterned sheet metal, which is strong enough for people to walk on easily. The underground container system has been manufactured to European Standards and is designed for long-term use. The containers can be made in different color options that are compatible with the environment with Ral color or sticker coating.

3,5 m3 and 5 m3 options are available.



To live green...





660 L Plastic Waste Container

- Volume: 660 L
- Dimensions: 1370x778x1228 mm
- Weight: 38 KG (+/-5%)
- Wheels: 4 rubber 200*50 in size.
- Temperature resistant: 30°C to +80°C.
- Lid is plastic lid.
- Lifting arms are suitable for garbage truck lifting systems.
- Material: HDPE Plastic.
- 4 of the wheels rotate 360 degrees and 2 of them has a brake.
- Fully recyclable, resistant to violet and infrared rays, acids and alkalis, high and low air temperatures
- DIN 30700 male attachment with printing grooves on the front edge of the container and no cutting edges or sharp corners.



1 TRUCK: 216 pieces



1x40HQ: 180 pieces



770 L Plastic Waste Container

- Volume: 770 L
- Dimensions: 1370x778x1365 mm
- Weight: 40 KG (+/-5%)
- Wheels: 4 rubber 200*50 in size.
- Temperature resistant: 30°C to +80°C.
- Lid is plastic lid.
- Lifting arms are suitable for garbage truck lifting systems.
- Material: HDPE Plastic.
- 4 of the wheels rotate 360 degrees and 2 of them has a brake.
- Fully recyclable, resistant to violet and infrared rays, acids and alkalis, high and low air temperatures
- DIN 30700 male attachment with printing grooves on the front edge of the container and no cutting edges or sharp corners.



1 TRUCK: 180 pieces



1x40HQ: 150 pieces

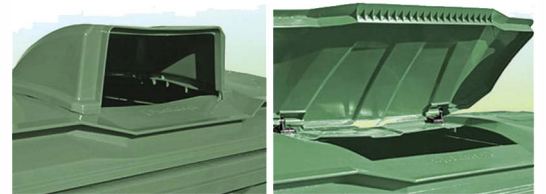

1100 L Plastic Waste Container

- Volume: 1100 L
- Dimensions: 1150 x 1370 x 1355 mm
- Weight: 46 KG (+/-5%)
- Wheels: 4 rubber 200*50 in size.
- Temperature resistant: 30°C to +80°C.
- Lid is plastic lid.
- Lifting arms are suitable for garbage truck lifting systems.
- Material: HDPE Plastic.
- 4 of the wheels rotate 360 degrees and 2 of them has a brake.
- Fully recyclable, resistant to violet and infrared rays, acids and alkalis, high and low air temperatures
- DIN 30700 male attachment with printing grooves on the front edge of the container and no cutting edges or sharp corners.
- Compatible with the mechanical loading / offloading system of garbage trucks.



1 TRUCK: 180 pieces



1x40HQ: 108 pieces

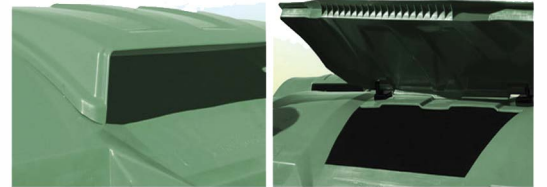

1100 L Plastic Waste Container with Dome Lid

- Volume: 1100 L
- Dimensions: 1370 x 1070 x 1461 mm
- Weight: 54 KG (+/-3%)
- Body sheet thickness is 1,50 mm.
- The cover sheet is made of a 1,20 mm sheet, considering it's lightweight.
- Lifting arms are suitable for garbage truck lifting systems.
- Container lifting arms are made of 32 inch.
- Material: Galvanized Steel
- Wheels: 4 rubber 200*50 in size.
- Temperature resistant: 30°C to +80°C
- 4 of the wheels rotate 360 degrees and 2 of them has a brake
- Wheel connection sheet is 4 mm.
- Our containers are welded with slag-free gas metal arc welding.
- All of our products used in our containers are of first quality and TSE certified



1 TRUCK: 132 pieces



1x40HQ: 118 pieces

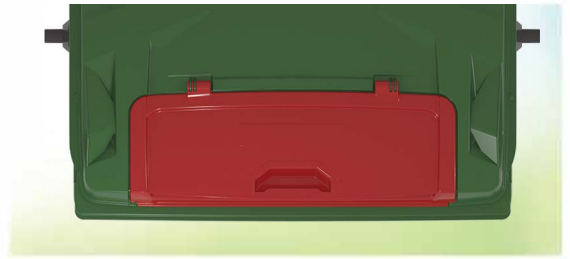

1100 L Plastic Waste Container Lid in Lid

- Volume: 1100 L
- Dimensions: 1150 x 1370 x 1355 mm
- Weight: 46 KG (+/-5%)
- Wheels: 4 rubber 200*50 in size.
- Temperature resistant: 30°C to +80°C.
- Lid is plastic lid in lid.
- Lifting arms are suitable for garbage truck lifting systems.
- Material: HDPE Plastic.
- 4 of the wheels rotate 360 degrees and 2 of them has a brake.
- Fully recyclable, resistant to violet and infrared rays, acids and alkalis, high and low air temperatures
- DIN 30700 male attachment with printing grooves on the front edge of the container and no cutting edges or sharp corners.
- Compatible with the mechanical loading / offloading system of garbage trucks.



1 TRUCK: 132 pieces



1x40HQ: 118 pieces



**Zeyrek
Konteyner**



Ready To Go!



100 Liter Plastic Waste Bin

Volume: 100 L

Dimensions: 760 x 450 x 545 mm

Weight: 7 KG (+/-5%)

Body and cover with warranty certificate, produced by injection system using high-density polyethylene(HDPE).

Temperature resistant: -30°C to +80°C

The cover is hinged and can be leaned on the back and there are two arms for lifting. Lid hinges are plastic.

Solid rubber swivel wheel with a diameter of 200 mm.

Electrolytically galvanized quality steel shaft.



1 TRUCK: 1200 pieces



1x40HQ: 900 pieces



120 Liter Plastic Waste Bin

Volume: 120 L

Dimensions: 925 x 465 x 580 mm

Weight: 7,5 KG (+/-5%)

Body and cover with warranty certificate, produced by injection system using high-density polyethylene(HDPE).

Temperature resistant: -30°C to +80°C

The cover is hinged and can be leaned on the back and there are two arms for lifting. Lid hinges are plastic.

Solid rubber swivel wheel with a diameter of 200 mm.

Electrolytically galvanized quality steel shaft.



1 TRUCK: 1100 pieces



1x40HQ: 900-1000 pieces





240 Liter Plastic Waste Bin

Volume: 240 L

Dimensions: 605 x 745 x 1060 mm

Weight: 12,5 KG (+/-5%)

Body and cover with warranty certificate, produced by injection system using high-density polyethylene(HDPE).

Temperature resistant: -30°C to +80°C

The cover is hinged and can be leaned on the back and there are two arms for lifting.Lid hinges are plastic.

Solid rubber swivel wheel with a diameter of 200 mm.

Electrolytically galvanized quality steel shaft.



1 TRUCK: 810 pieces



1x40HQ: 750 pieces



360 Liter Plastic Waste Bin

Volume: 360 L

Dimensions: 596 x 880 x 1099 mm

Weight: 15,4 KG (+/-5%)

Body and cover with warranty certificate, produced by injection system using high-density polyethylene(HDPE).

Temperature resistant: -30°C to +80°C

The cover is hinged and can be leaned on the back and there are two arms for lifting.Lid hinges are plastic.

Solid rubber swivel wheel with a diameter of 200 mm.

Electrolytically galvanized quality steel shaft.



1 TRUCK: 600 pieces



1x40HQ: 500-525 pieces



70 L. Plastic Zero Waste Bucket

It is produced by injection method with HDPE raw material. It has easy to clean inner and outer surface. Resistant to hot and cold, chemicals and UV rays. It has removable lid and foot compartment. Mouths are open. The reason for preference is recycling. Convenient to use.

Examples of where it is used: Schools, hospitals, workplaces, offices, government offices and institutions. Can be divided into 2,3,4,5,6 classes upon request. Colours and labels are optional.



Your Yard's Best Friend



Post mounted bin 50 L

Volume: 50 L

Dimensions: 430 x 340 x 740 mm

Weight: 9approx. 4,00 KG

Material: HDPE, UV-stabilized, resistant to high and low temperatures.

Zync-coated all metal parts.

Lock with key.

Metal plates for cigarettes.

Environment friendly

Long life expectancy

Can be recycled

Frost-proof

Chemical resistance

High UV resistance



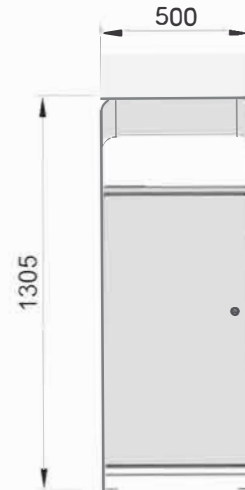

100 Liter

Volume: 100 L

Height: 1305 mm, Width: 500 mm, Depth: 480 mm



1 TRUCK: 132 pieces



1x40HQ: 118 pieces

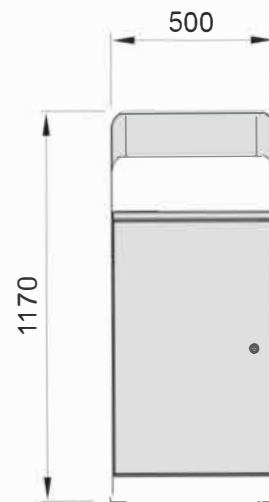

80 Liter

Volume: 80 L

Height: 1170 mm, Width: 500 mm, Depth: 480 mm



1 TRUCK: 132 pieces



1x40HQ: 118 pieces

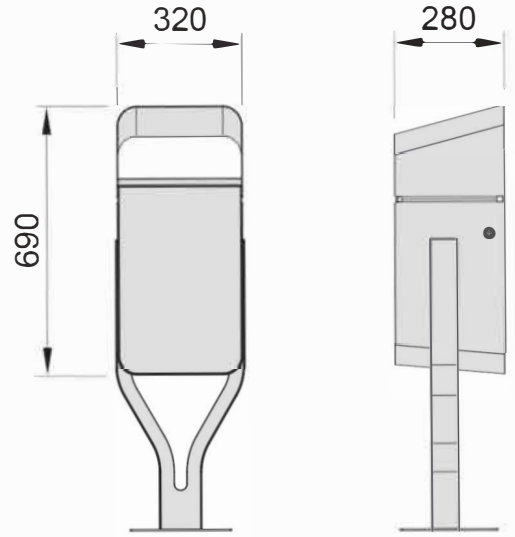

30 Liter

Volume: 100 L
 Height: 690 mm, Width: 320 mm, Depth: 280 mm



1 TRUCK: 132 pieces



1x40HQ: 118 pieces



Stilo Select

Volume: 4 x 40 L
 Height: 1142mm, Width: 1378mm, Depth: 380mm



1 TRUCK: 132 pieces



1x40HQ: 118 pieces

Waste bin Trio



TECHNICAL DATA

Volume: **60 L**

Dimensions: 500 x 650 mm

Weight: approx. 4,0 kg (+/-3%)

Material: HDPE



TECHNICAL DATA

Volume: **80 L**

Dimensions: 500 x 820 mm

Weight: approx. 5,00 kg (+/-3%)

Material: HDPE



TECHNICAL DATA

Volume: **100 L**

Dimensions: 500 x 950 mm

Weight: approx. 6,00 kg (+/-3%)

Material: HDPE

OPTIONS:

Marking

Colors: black, green





**FOR A CLEAN
WORLD**



ZK-1001B
30x66 cm



ZK-1002B
30x66 cm



ZK-1006B
30x60 cm



ZK-1017B
30x72 cm



ZK-1021B
30x60 cm



ZK-1022B
30x60 cm



ZK-1031C
30x70 cm



ZK-1033B
30x70 cm



ZK-6234
124x33x80 cm



ZK-1705
39x113 cm



ZK-1706
37x80 cm



ZK-1707
38x100 cm



ZK-1701
38x111 cm



ZK-1704
41x75 cm



ZK-1708
38x111 cm



ZK-1736
38x82 cm



ZK-1751
38x67 cm



ZK-148
40x85 cm



ZK-2118
36x70 cm



ZK-2114
30x70 cm

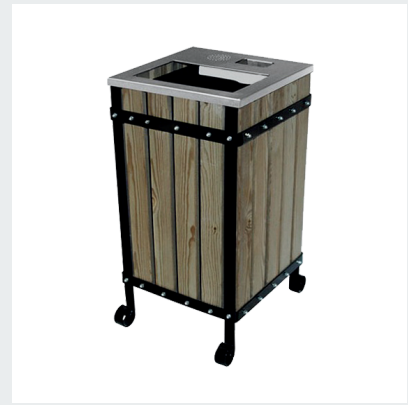

ZK-2110
35x65 cm



ZK-2105
35x65 cm

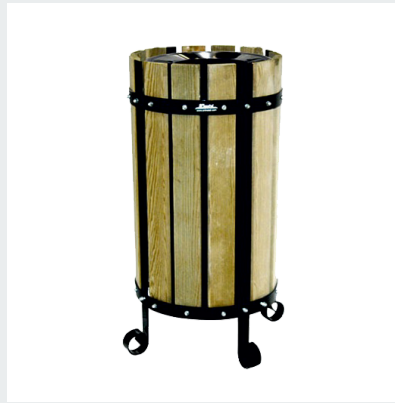

ZK-2101
35x65 cm



ZK-2100
35x65 cm



ZK-150
24x60 cm



ZK-161
24x60 cm



ZK-190
24x80 cm

REFERANSLARIMIZ



CENTER OFFICE: Ekinoba MH. Çanakkale SK. No:5 Büyükçekmece / İSTANBUL / TURKEY
PHONE:+90 536 256 36 16 - **MAIL:** export@zeyrekkonteyner.com

İZMİR FACTORY: Yazıbaşı Mahallesi, 325. Sokak, No:1/3 - 2. Bölüm Torbalı / İZMİR
PHONE : +90 536 256 36 16 - **MAIL :** export@zeyrekkonteyner.com

TEKİRDAĞ FACTORY: Çavuşköy MH. Ergenekon CD. No:18 Malkara / TEKİRDAĞ / TURKEY
PHONE: +90 212 863 60 70 - **MAIL :** export@zeyrekkonteyner.com

BULGARIA: UL. G.S. Rakovski-50 ET.3 AP.5 7700 Targovishte / BULGARIA
PHONE: +359 88 899 8818 - **MAIL :** higiamedbg@gmail.com

FRANCE: 39 Reu Du Mont Sainte Barbe 67700 Ottersthal / FRANCE
PHONE : +33 6 03 82 87 59 - **MAIL :** gokmenzeyrek@gmail.com



OUR EXPORT RATES TO OTHER COUNTRIES