

Overall View

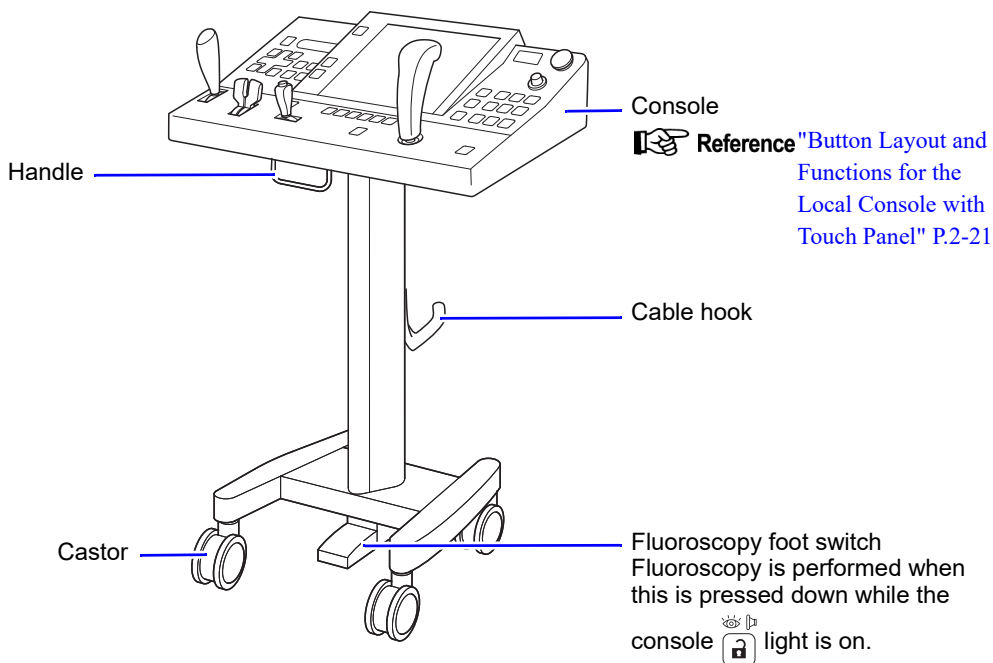

Button Layout and Functions for the Local Console with Touch Panel

The touch panel and button operations are the same as those of the remote console, however the local console does not have the following dials and buttons.

- Balance adjustment dial
- Control room/examination room speaker volume adjustment dial
- Power ON button/Power OFF button

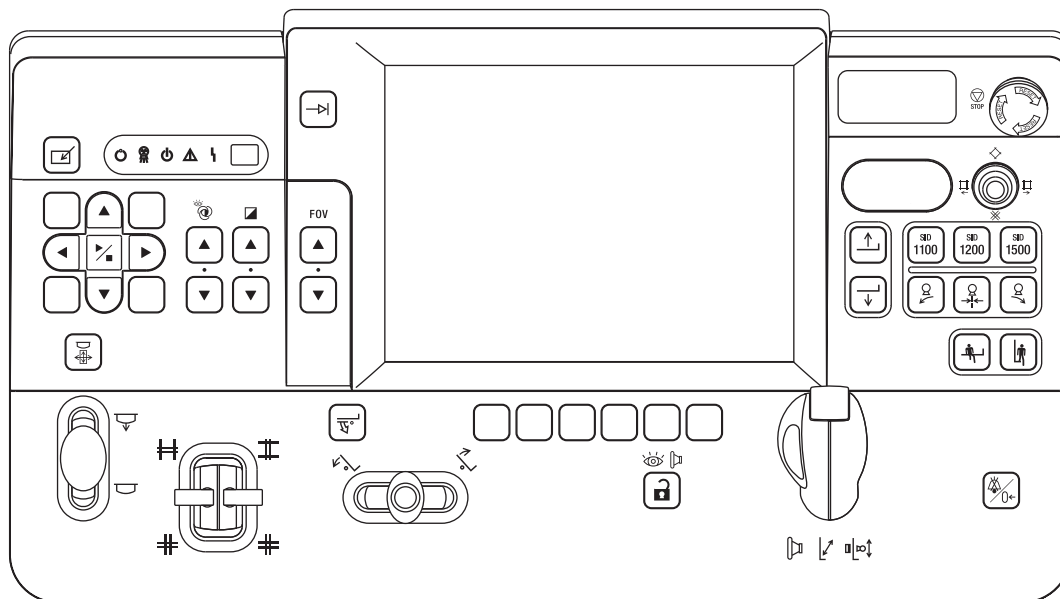

2.4.2 Local Console

This console comes with a cart so that it can be operated inside the examination room. It is not fitted with a touch panel.

The local console comes in the following types:

- With an integrated monitor for use in the examination room
 - Separate from the monitor cart
-  **Reference** "In Combination with the Monitor Cart" P.2-25

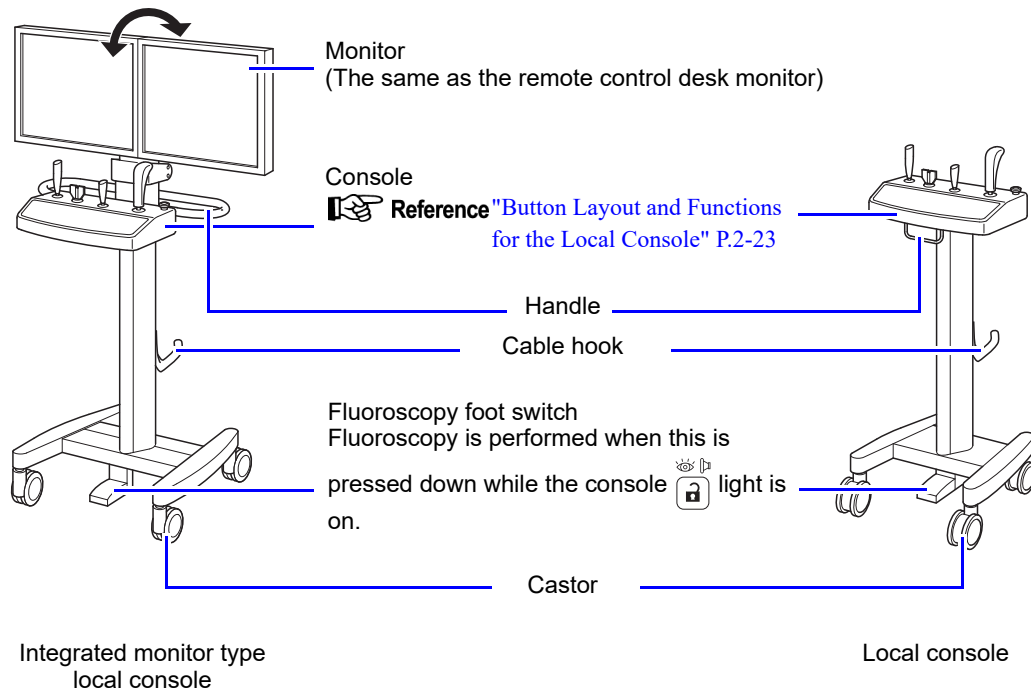

The monitor angle can be raised and lowered. When changing the angle, hold the center of the two monitors and tilt them backwards or forwards.

Button Layout and Functions for the Local Console



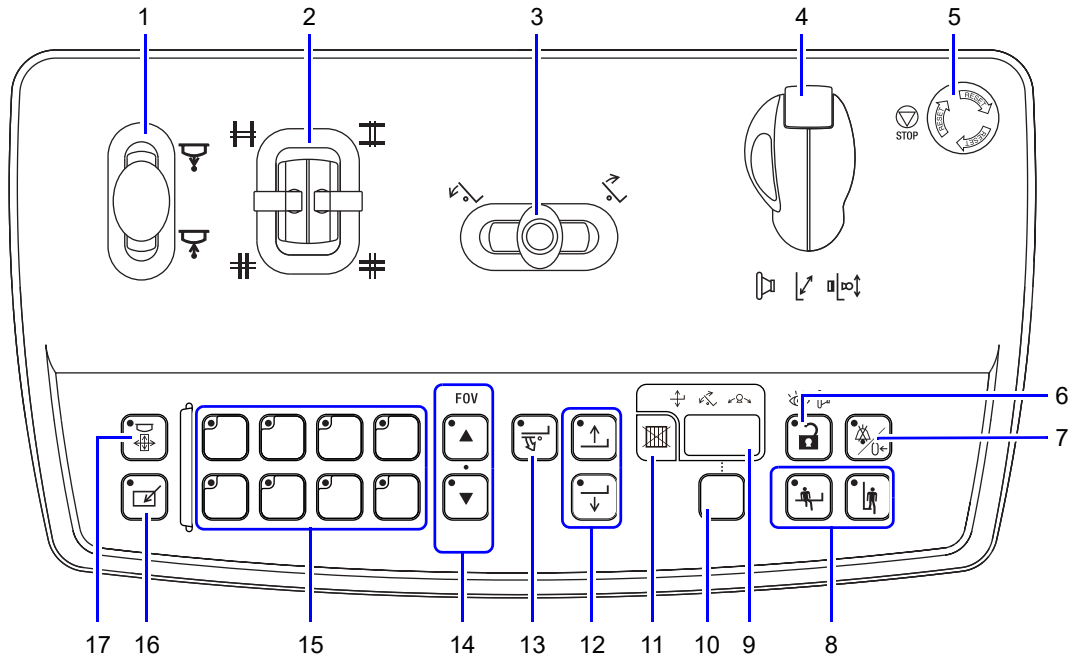



























The button operations are the same as on the remote console, with the exception of some buttons which have been omitted.



2

| No. | Form | Name | Function |
|-----|------|-------------------------------------------------------|------------------------------------------------------------------------------------------------------------------------------------------------------------------------------------------------------------------------------------------------------------------------------------------------------------------------|
| 1 | | Compression unit control lever* ¹ | Controls the compression unit. Push forward to apply compression on the patient. Pull towards you to return the compression unit to its original position. Reference P.4-71 |
| 2 | | Collimator open/close lever | Controls the collimator irradiation field. Controls the collimator in a horizontal/vertical direction. Reference P.4-78 |
| 3 | | Tabletop tilting lever* ¹ | Tilts the tabletop. It is operated while holding down the button on the top of the lever. When it is moved to the right, the tabletop is tilted in a vertical direction. It is tilted in the opposite direction when the lever is moved to the left. Reference P.4-54 |
| 4 | | Tabletop and imaging unit control lever* ¹ | When tilted to the left or right, the tabletop moves to the left or right. When tilted up or down, the imaging unit moves up or down. A: Radiography button B: Button to change the speed of the tabletop's movement to the left or right Reference P.4-58 , P.4-64 |
| 5 | | Emergency stop button | Brings the X-ray diagnostic table to an emergency stop. Reference P.5-2 |

2 Configuration

| No. | Form | Name | Function |
|-----|-------------------------------------------------------------------------------------|------------------------------------------------------|-------------------------------------------------------------------------------------------------------------------------------------------------------------------------------------------------------------------------------------------------------------------------------------------------------------------------------------------------------------------------------------------------------------------------------------------------------------------------------------------------------------|
| 6 |  | X-ray irradiation clearance button | Lights up when pressed, signalling that X-ray irradiation is permitted. |
| 7 |  | Fluoroscopy timer button | Turns off the fluoroscopy timer alarm, and restarts the timer count from 0.  Reference P.4-93 |
| 8 |  | Tabletop return buttons *1 | Returns the tabletop slant and height to the set position.  returns the tabletop to the horizontal position and to the height set when it was installed.  moves the tabletop to the vertical position.  Reference P.4-66 |
| 9 |  | Display | Displays the tabletop height ( above lights up), the angle at which the tabletop is tilted ( lights up) and the angle at which the X-ray tube unit is tilted ( lights up). The caution/failure code is displayed when a caution or failure occurs. |
| 10 |  | Display switchover button | Changes the display on the screen. |
| 11 |  | Grid display lamp | Lights up when the anti-scatter grid has been removed.  Reference P.4-36 |
| 12 |  | Raise tabletop button *1 Lower tabletop button *1 |  raises the tabletop and  lowers it.  Reference P.4-60 |
| 13 |  | Tabletop reverse tilt check button | Press when reversing the tilt of the tabletop. When the button is pressed and lit up, the tilt can be reversed using the tabletop tilting lever.  Reference P.4-56 |
| 14 |  | Magnification size switchover buttons | Changes the FPD magnification size through 5 levels.  increases the magnification and  decreases it.  Reference P.4-77 |
| 15 |  | Customizable buttons | You can assign frequently used functions to these buttons.  Reference P.2-26 |
| 16 |  | Operational button | When this button is lit up, the X-ray diagnostic table and X-ray irradiation can be controlled by the local console.  Reference P.4-53 |
| 17 |  | Squeeze compression button | Use this when applying "squeeze compression".  Reference P.4-72 |

*1: Only moves while the button is being pressed or the lever is being operated.

In Combination with the Monitor Cart

The local console can be combined with the monitor cart. This can be done to save space. When combining the two, slide the local console's feet between the monitor cart's feet (they cannot be fixed together). Hang the local console cable on the cable hook so that it does not get trodden on, and run it over the top of the base.

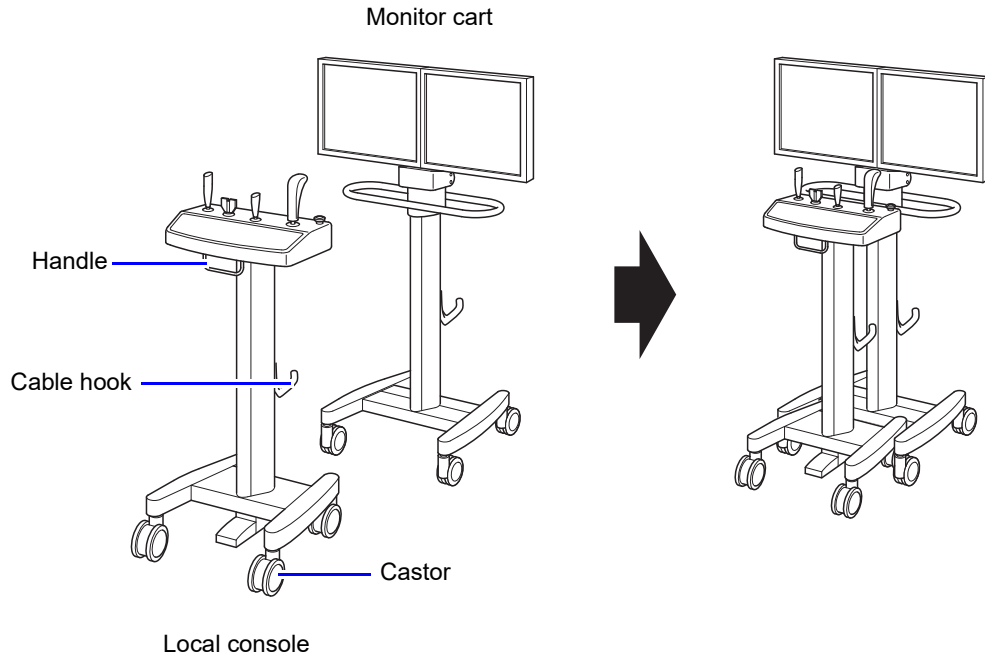

NOTE The local console and the monitor cart cannot be fixed together. Please move them separately.